



Accessories for Surface Modification



For More Information...

For more information on our Accessories offering, visit [**3M.com/AccessoriesASD**](http://3M.com/AccessoriesASD)

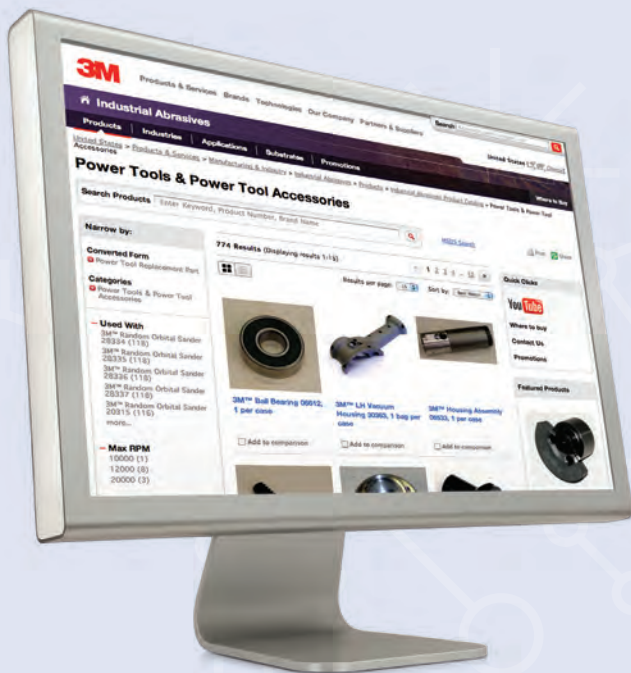



For more information about our 3M™ Power Tool replacement parts, visit [**3M.com/SpareParts**](http://3M.com/SpareParts)

Table of Contents

Power Tool Accessories	2–14	3M™ Finesse-it™ Compounds, Polishes and Pads	41–47
3M™ Air Line Extensions & Air Tool Lubricants	2	3M™ Finesse-it™ Compounds and Polishes	41–42
3M™ Dual Lock™ Rubber Skirts	2	3M™ Finesse-it™ Disc & Buffing Pads	42–44
3M™ Dual Lock™ Disc Pad	3	3M™ Perfect-it™ II Wool Compounding Pad	44
3M™ Electric Random Orbital Sander Accessories	3	3M™ Buffing and Polishing Accessories	45
3M™ Filter Bags and Adapters	3	Scotch-Brite™ High Performance Cloth	45
3M™ File Belt Sander Accessories	4	3M™ Finesse-it™ Hand Sanding Pads	46
3M™ File Belt Arm Service Tool Kit & Repair Kits	5	3M™ Finesse-it™ Roloc™ Backup Pads	46
3M™ Orbital/Random Orbital Sander Grips	5	3M™ Hookit™ Polishing Pads	47
3M™ 28391 Polisher Carbon Brush 120V	5	3M™ Marine Products	47–50
3M™ Tool Hangers	6	3M™ Flanges	51
3M™ Random Orbital Sander Muffler Kit	6	3M™ RX Hub and Roto Peen Assembly	51
3M™ Orbital/Random Orbital Sander Drop In Motors	6–7	3M™ Flap Disc Adapter Nut and Holder	52
3M™ Collets for 3M™ Disc Sanders & Die Grinders	8	3M™ Flexible Grinding Wheel Backup Pads	52
3M™ Elite Random Orbital Sander Wet Sanding Shroud Kit	8	Hand Pads, Blocks and Pad Holders	53–60
3M™ Flanges	9	3M™ Center Water Feed Disc Hand Pads	53
3M™ Power Tool Flange Nuts & Handles	9	3M™ Wetordry™ Bucket	53
3M™ Service Tool Kit	10	3M™ Rubber Sanding Blocks	53
3M™ Wrenches for Power Tools	10–11	Pad Holders	54
3M™ Bearing Puller	11	3M™ Hookit™ Hand Pads and Blocks	54–55
3M™ Service Tools — T-7 Soft Collar	11	3M™ Dust Free Hand Pads and Blocks	56
3M™ Vacuum Hose and Accessories	12–13	3M™ Fairing and Hand File Boards	56
3M™ Type 27 Grinder Guards	13	Air File Shoes	57
3M™ Power Tool Overhose Kit and Sleeve	13	3M™ Facing Material Rolls	57
3M™ Roloc™ Dust Shroud Kits and Accessories	14	3M™ Stikit™ Hand Pads and Blocks	58–59
Adapters, Mandrels, Cutters	14–15	3M™ Screen Cloth Hand Pads	60
3M™ Adapters	14–15	Mandrel and Spindles	60–62
3M™ Bristle Disc Adapters	15	3M™ Cartridge Roll Mandrels	60
3M™ Bristle Disc Mandrel	15	3M™ Forked Spindle	61
3M™ SR Rotary Cutter	15	3M™ Mandrels	61
Disc Pads and Holders	16–40	3M™ Roloc™ Mandrel TS/TSM	61
3M™ Disc Pad Face Plates	16–17	3M™ Square/Cross Pad Mandrel	61
3M™ Disc Pad Hubs	18	3M™ Star Mandrel	61
3M™ Disc Retainer Nuts	19	3M™ Unitized Wheel Mandrels	62
3M™ Fibre Disc Backup Pads	19	3M™ Platen Pad Cover	62
Disc Pad Holders (Hook-and-Loop)	20–22	3M™ Roto Peen Accessories	63
3M™ Hookit™ Disc Pads & D/F Disc Pads	22–25	Molding Adhesive and Stripe Removal	63
3M™ Hookit™ Roloc™ Disc Pads	25	3M™ Rubber Cushion Polishing Wheels	64
3M™ Roloc™ PSA Disc Pad	25	3M™ Rubber Slotted Expander Wheels	65
3M™ Hookit™ Clean Sanding Disc Pads & Pads	26–27	3M™ Wetordry™ Rubber Squeegees	65
3M™ Hookit™ Clean Sanding Pad Hook Saver	27	3M™ All Purpose Tack Cloth	66
3M™ Hookit™ Soft Interface Disc Pad	27	Power Tool Conversion Replacement Parts	66–67
3M™ Hookit™ Clean Sanding Interface Pads	28	UPC Index	68–70
3M™ Hookit™ Clean Sanding Disc Pad Hook Savers	28	Part Number Index	71–72
3M™ Hook-and-Loop Conversion Face	28		
3M™ Random Orbital Sander 5" & 6" Backup Pads	29		
3M™ Stikit™ D/F Disc Pads (Vacuum)	30		
3M™ Stikit™ Disc Pads & Pads	31–32		
3M™ Stikit™ D/F Pad	32		
3M™ Stikit™ Soft Interface Disc Pad	32		
3M™ Stikit™ Dispensers	32		
3M™ PSA Disc Holders	33		
3M™ Roloc™ Shanks	34		
3M™ Roloc™ Disc Pads & Assemblies	35–39		
3M™ Roloc™ Cool Running Disc Pads	39		
3M™ Break Hub Cleaning	40		
3M™ Roloc™+ Buttons and Holders	40		
Dressing and Shaping Tape	40		



3M™ Air Line Extensions

Shorter lengths of 3/8" ID air line that moves the quick disconnect couplings away from the tool and exhaust assembly. The 1/4" NPT fitting attaches directly to the Random Orbital Sander with Self-Generating or Central Vacuum.

Product Name	UPC	Part No.	Description	Size	Air Inlet Thread	MOQ	
3M™ Random Orbital Sander Mini Air Line Extension		051141-25119-6	25119	• 5" long air line moves coupling connection away from exhaust tube	3/8" ID x 5" L	1/4" NPT	10
3M™ Random Orbital Sander Air Line Extension		051141-20209-9	20209	• Moves connection away from the exhaust tube and its 4-foot long extension safely keeps the couplings from hitting the work piece	3/8" ID x 4' L	1/4" NPT	1
3M™ Swivel Quick Change Connector		051141-55180-7	55180	• Swivel quick disconnect air fitting • Swivels to allow air hose to be moved away from the filter bag	—	1/4" NPT EXT	1

3M™ Air Tool and Compressor Lubricants

A lubricating oil that keeps the tools running at top efficiency. The oil reduces the coefficient of friction between moving parts and reduces the amount of heat produced by the motor. Durable for air compressors.

Product Name	UPC	Part No.	Description	Size	MOQ	
3M™ Air Tool and Compressor Lubricant		051141-20466-6*	20466	For Power Tools Air Compressors	Quart	12
3M™ Air Tool and Compressor Lubricant		051141-20467-3*	20467	Larger size for Air Compressors	Gallon	4
3M™ Air Tool Lubricant		051141-20451-2	20451	For Power Tools	4 fl. oz. (188mL)	12

*Make to order. Ships within 4 days.

Four Ball Wear Test (ASTM D-4172)

The Four Ball Wear Test determines the wear protection properties of a lubricant. Three metal balls are clamped together and covered with the test lubricant, while a rotating fourth ball is pressed against them in sliding contact. This contact typically produces a wear scar, which is measured and recorded. The smaller the average wear scar, the better the wear protection provided by the lubricant.

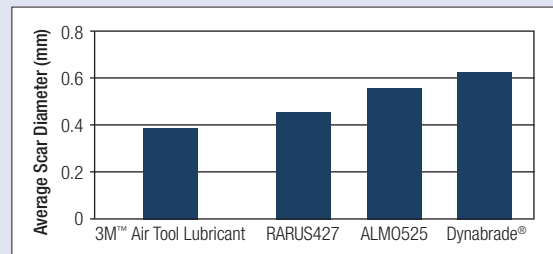

3M™ Dual Lock™ Rubber Skirts

Attaches to 3M™ Nib Removal Sander (PN03125) with existing four screws. Used in applications where a more durable attachment is needed to secure backup pad.





Product Name	UPC	Part No.	Diameter	Max RPM	MOQ	
3M™ Dual Lock™ Rubber Skirt		051141-20246-4	20246	1-1/4"	7,500	10

3M™ Dual Lock™ Disc Pad

This disc pad attaches to the 3M™ Dual Lock™ Rubber Skirt (PN20246). The Dual Lock™ Hooks provide a secure attachment even in extreme wet applications. The pad has a blue vinyl face to hold the PSA backed 3M™ Trizact™ Finesse-it™ Film Disc 466LA.

Product Name	UPC	Part No.	Diameter	Density	Max RPM	MOQ	
3M™ Dual Lock™ PSA Soft Disc Pad		051141-20247-1	20247	1-1/4"	Soft	7,500	20

3M™ Electric Random Orbital Sander Accessories

Product Name	UPC	Part No.	Description	MOQ	
3M™ Power Cord		051141-28434-7	28434	<ul style="list-style-type: none"> • 12 ft. • 18 AWG Low Voltage • UL approved 	1
		051141-28435-4	28435	<ul style="list-style-type: none"> • 24 ft. • Low Voltage • UL approved 	1
3M™ Power Supply with AC Power Cord		051141-28436-1	28436	<ul style="list-style-type: none"> • AC input 100–240 volt • Full Range, DC output 30 volt, 5 amp • Removable side bumpers and pre-drilled mounting flange • UL approved 	1
3M™ AC Power Cord		051141-28478-1	28478	<ul style="list-style-type: none"> • 6 ft. • Three Prong Power Cord • 110 volt • UL approved 	1

3M™ Filter Bags and Adapters

HEPA-rated filter dust collection bags and accessories used on Self Generating Vacuum Orbital and Random Orbital Sanders.

Product Name	UPC	Part No.	Description	Size	MOQ	
3M™ Clean Sanding Filter Bag		051141-20452-9	20452	<ul style="list-style-type: none"> • Used on Random Orbital Sanders with Self-Generated Vacuum to collect dust • Eliminates the need for vacuum hose which improves operator ease of use • Attach bag to sander with 3M™ Filter Bag Adapter • HEPA-rated 	Large — Holds up to 1/2 lb.	50
3M™ Clean Sanding Filter Bag		051141-28364-7	28364	<ul style="list-style-type: none"> • Used on Random Orbital Sanders with Self-Generated Vacuum to collect dust • Use with 3M™ Clean Sanding Filter Bag Backpack Assembly which holds and protects the Filter Bag • HEPA-rated 	Extra Large — Holds up to 3 lbs.	20
3M™ Clean Sanding Filter Bag Backpack Assembly		051141-28365-4	28365	<ul style="list-style-type: none"> • Use as backpack or hip pack • Holds our 3M™ Extra Large Clean Sanding Filter Bag along with the other components used to connect the 3M™ Self-Generated Vacuum Random Orbital Sander to the Filter Bag 	—	1
3M™ Clean Sanding Filter Bag End Cap		051141-28383-8	28383	<ul style="list-style-type: none"> • Press onto the nozzle of the Filter Bag (PN20452 or PN28364) after the filter bag is full to keep dust from escaping • The order quantity of End Caps will be packaged in a poly bag and shipped in a best fit box 	1" ID	1
3M™ Filter Bag Adapter		051141-20453-6	20453	<ul style="list-style-type: none"> • Used to attach 3M™ Clean Sanding Filter Bag to Self Generating Vacuum Orbital and Random Orbital Sanders • 1" EXT hose thread attaches to 3M™ Sander • 1" ID tubing attaches to 3M™ Clean Sanding Filter Bag 	1" EXT Hose Thread x 1" ID	10
3M™ Hose Seal A0778		051115-28146-4	28146	<ul style="list-style-type: none"> • Properly seals Self-Generated Vacuum exhaust swivel • Hose seal is standard on all Self-Generated Vacuum Orbital Sanders and Self-Generated Vacuum Random Orbital Sanders 	1" (28mm)	1

3M™ File Belt Sander Accessories — Platen Pad Materials

3M™ Platen Pad materials provide support for abrasive belts. They can easily be trimmed to length and the PSA adhesive is easy for mounting. They are available in various hardnesses and thicknesses for a variety of sanding applications.

Product Name	UPC	Part No.	Size	Thickness	Density	MOQ
3M™ File Belt Sander Platen Pad Material 	051141-28381-4	28381	1/2" x 7"	1/32"	Thin	10
	051141-28377-7	28377	1/2" x 7"	1/8"	Soft	10
	051141-28379-1	28379	1/2" x 7"	1/8"	Hard	10
	051141-28382-1	28382	3/4" x 7"	1/32"	Thin	10
	051141-28378-4	28378	3/4" x 7"	1/8"	Soft	10
	051141-28380-7	28380	3/4" x 7"	1/8"	Hard	10
	NEW! 051141-28726-3	28726	15-3/4" x 11-13/16"	1/8"	Soft	1

3M™ File Belt Sander Accessories — Attachment Arms

Attachment arms are for use with the 3M™ File Belt Sander and 3M™ Coated Abrasive and Scotch-Brite™ Belts.

Product Name	UPC	Part No.	Description	MOQ
3M™ File Belt Sander Attachment Arm 	051141-28374-6	28374	<ul style="list-style-type: none"> • Curved arm used for blending flat areas • Sand with contact wheel or platen • Use with 1/2" x 18" Coated Abrasive and Scotch-Brite belts 	1
	051141-28368-5	28368	<ul style="list-style-type: none"> • Standard arm included with 3M™ File Belt Sander • Sand with contact wheel or platen • Use with 1/2" x 18" Coated Abrasive and Scotch-Brite belts 	1
	051141-28371-5	28371	<ul style="list-style-type: none"> • Thick Standard • Sand with contact wheel or platen • Use with 5/8" or 3/4" x 18" Coated Abrasive and Scotch-Brite belts 	1
	051141-28369-2	28369	<ul style="list-style-type: none"> • Thin — Thinner than standard arm • Sand with contact wheel or platen • Use with 1/2" x 18" Coated Abrasive and Scotch-Brite belts 	1
	051141-28375-3	28375	<ul style="list-style-type: none"> • Vessel • Sand with contact wheel • Unique large arm used for blending weld seams • Use with 1/4" or 1/2" x 24" Coated Abrasive and Scotch-Brite belts • Includes tracking/control knob 	1
	051141-28376-0	28376	<ul style="list-style-type: none"> • Extension used to extend arms to 24" length • Can be used with same attachment arms used for 18" length arms 	1
	051141-28370-8	28370	<ul style="list-style-type: none"> • Sand corners and grooves with contact wheel • Use with 1/8", 1/4", or 1/2" x 18" Coated Abrasive and Scotch-Brite belts 	1
	051141-28372-2	28372	<ul style="list-style-type: none"> • Sand corners and grooves with contact wheel • Use with 1/8" or 1/4" x 18" Coated Abrasive and Scotch-Brite belts 	1
	051141-28373-9	28373	<ul style="list-style-type: none"> • 20-1/2" • Sand with contact wheel or platen • Use with 5/8" or 3/4" x 20-1/2" Coated Abrasive and Scotch-Brite belts 	1



3M™ File Belt Sander Accessories — Rubber Drive Pulley

Product Name	UPC	Part No.	Description	MOQ
3M™ Drive Pulley — Rubber 	051141-30671-1	30671	<ul style="list-style-type: none"> • Used to drive Scotch-Brite™ File Belts • Replacement drive pulley for 3M™ File Belt Sander 	1

3M™ File Belt Arm Service Tool Kit

This kit contains Wheel Positioning Block, Shaft Removal Tool, two Bearing Removal Tools, Bearing Mount Tool, Bearing Tool and Retaining Compound.

Product Name	UPC	Part No.	MOQ
 3M™ File Belt Arm Service Tool Kit	051141-30670-4	30670	1

3M™ File Belt Sander Attachment Arm Repair Kits



Kits contain: Contact wheel, bearings, shaft and platen pad if applicable. 3M™ File Belt Arm Service Tool Kit (PN30670) recommended for use with repair kits.

Repair Kit Part No.	For Use with Arm Part No.
30662	28374
30663	28368
30664	28371
30667	28369

Repair Kit Part No.	For Use with Arm Part No.
30669	28375
30668	28370
30666	28372
30665	28373

3M™ Random Orbital Sander Grips — Elite and Original Series

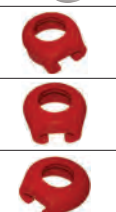
Three different size replacement grips allow the sander to be used by operators with larger or smaller hand sizes.

Product Name	UPC	Part No.	Description	Diameter	MOQ	
 3M™ Random Orbital Sander Grip — Elite Series	NEW!	051141-55204-0	55204	• For small sized hands	2-1/2"	1
	NEW!	051141-55205-7	55205	• For medium sized hands • Standard size that comes on the tool	2-3/4"	1
	NEW!	051141-55206-4	55206	• For large sized hands	3"	1
 3M™ Random Orbital Sander Grip — Original Series		051141-20342-3	20342	• For small sized hands	2-1/2"	1
		051141-20343-0	20343	• For medium sized hands • Standard size that comes on the tool	2-3/4"	1
		051141-20344-7	20344	• For large sized hands	3"	1
 3M™ Grip	NEW!	051141-55146-3	55146	• Replacement grip for 3M™ Electric Random Orbital Sander	5"/6"	1







3M™ 28391 Polisher Carbon Brush 120V

Product Name	UPC	Part No.	Description	MOQ
 3M™ 28391 Polisher Carbon Brush 120V	051141-30933-0	30933	Replacement motor brushes for 3M™ Electric Variable Speed Polisher (model 28391)	1



3M™ Tool Hangers

Product Name		UPC	Part No.	Description	MOQ
3M™ Hanger		051141-30331-4	30331	<ul style="list-style-type: none"> Replacement part for 3M™ Abrasive Power Tools See Owners Manual for specific tool for Parts List and tool schematic 	1
3M™ Hanger 28737		051115-66905-7	66905	<ul style="list-style-type: none"> Replacement part for 3M™ Elite Series Mini Orbital Sander (PN28737) 	1
3M™ Screw, Hanger 28737		051115-66906-4	66906	<ul style="list-style-type: none"> Replacement part for 3M™ Elite Series Mini Orbital Sander (PN28737) 	1
3M™ Tool Hanger B0442		051141-28317-3	28317	<ul style="list-style-type: none"> Attaches to all 3M™ Random Orbital Sanders and Buffers to be conveniently hung up on a hook for easy access 	1



3M™ Random Orbital Sander Muffler Kit

Product Name		UPC	Part No.	Description	MOQ
3M™ Random Orbital Sander Muffler Kit		051141-28394-4	28394	<ul style="list-style-type: none"> Kit used for 3", 5" and 6" 3M™ Random Orbital Sanders Contains 1 each: internal muffler (PNA0062), muffler insert (PNA0068) and muffler housing (PNA0166) 	1





3M™ Orbital Sander Drop In Motors

Allows for very fast and easy repair of the 3M™ Orbital Sander. The complete motor is replaced instead of rebuilding the motor with individual parts.

Product Name		UPC	Part No.	Tool Size	Orbit Diameter	MOQ
3M™ Orbital Sander Drop In Motor		051141-20223-5	20223	3" x 4"	1/8" (3.2mm)	1

3M™ Electric Random Orbital Sander Drop In Motors

Allows for very fast and easy repair of the 3M™ Electric Random Orbital Sander. The complete motor is replaced instead of rebuilding the motor with individual parts.

Product Name		UPC	Part No.	Tool Diameter	Orbit Diameter	MOQ
3M™ Electric Random Orbital Sander Drop In Motor		051141-55434-1	55434	5" (127mm)	3/32" (2.5mm)	1
		051141-55435-8	55435	5" (127mm)	3/16" (5mm)	1
		051141-55436-5	55436	6" (150mm)	3/32" (2.5mm)	1
		051141-55437-2	55437	6" (150mm)	3/16" (5mm)	1

3M™ Elite Random Orbital Sander Drop In Motors

Allows for very fast and easy repair of the 3M™ Elite Random Orbital Sander. The complete motor is replaced instead of rebuilding the motor with individual parts.

Product Name	UPC	Part No.	Tool Diameter	Orbit Diameter	MOQ	
3M™ Elite Random Orbital Sander Drop In Motor		051141-28605-1	28605	3" (77mm)	3/32" (2.5mm)	1
		051141-28606-8	28606	3" (77mm)	3/16" (5mm)	1
		051141-28607-5	28607	5" (127mm)	3/32" (2.5mm)	1
		051141-28608-2	28608	5" (127mm)	3/16" (5mm)	1
		051141-28609-9	28609	5" (127mm)	5/16" (8mm)	1
		051141-28610-5	28610	5" (127mm)	3/8" (10mm)	1
		051141-28611-2	28611	6" (150mm)	3/32" (2.5mm)	1
		051141-28612-9	28612	6" (150mm)	3/16" (5mm)	1
		051141-28613-6	28613	6" (150mm)	5/16" (8mm)	1
		051141-28614-3	28614	6" (150mm)	3/8" (10mm)	1





3M™ Random Orbital Sander Drop In Motors

Allows for fast and easy repair of 3M™ Random Orbital Sanders. The complete motor is replaced instead of rebuilding the motor with individual parts.

Product Name	UPC	Part No.	Description	Tool Diameter	Orbit Diameter	MOQ	
3M™ Mini Random Orbital Sander Drop In Motor		051141-28318-0	28318	• For 3M™ Mini Random Orbital Sander • 3/16" orbit	1-1/4" (32mm)	3/16" (5mm)	1
3M™ Random Orbital Buffer Drop In Motor		051141-30445-8	30445	• For 3-inch 3M™ Random Orbital Buffer (PN28333) • 1/2" orbit	3" (77mm)	1/2" (12mm)	1
3M™ Random Orbital Sander Drop In Motor		051141-20216-7	20216	• For 3-inch 3M™ Random Orbital Sander • 3/32" orbit	3" (77mm)	3/32" (2.5mm)	1
		051141-20217-4	20217	• For 3-inch 3M™ Random Orbital Sander • 3/16" orbit	3" (77mm)	3/16" (5mm)	1
		051141-20218-1	20218	• For 5-inch 3M™ Random Orbital Sander • 3/32" orbit	5" (127mm)	3/32" (2.5mm)	1
		051122-01811-4	01811	• For 5-inch 3M™ Random Orbital Sander • 3/16" orbit	5" (127mm)	3/16" (5mm)	1
		051141-20256-3	20256	• For 5-inch 3M™ Random Orbital Sander • 5/16" orbit	5" (127mm)	5/16" (8mm)	1
		051122-01812-1	01812	• For 6-inch 3M™ Random Orbital Sander • 3/32" orbit	6" (150mm)	3/32" (2.5mm)	1
		051141-20221-1	20221	• For 6-inch 3M™ Random Orbital Sander • 3/16" orbit	6" (150mm)	3/16" (5mm)	1
		051141-20222-8	20222	• For 6-inch 3M™ Random Orbital Sander • 5/16" orbit	6" (150mm)	5/16" (8mm)	1
3M™ Random Orbital Sander — Two-Hand Drop In Motor		051141-30443-4	30443	• For 3M™ Random Orbital Sander, 2-Hand • 3/36" orbit	6" (150mm)	3/16" (5mm)	1
		051141-30444-1	30444	• For 3M™ Random Orbital Sander, 2-Hand • 3/8" orbit	6" (150mm)	3/8" (10mm)	1



3M™ Collets for 3M™ Disc Sanders

Product Name		UPC	Part No.	Size	MOQ
3M™ Collet		051115-06528-6	06528	1/4"	1
		051115-06529-3	06529	1/8"	1
		051115-06530-9	06530	3/16"	1
		051115-06540-8	06540	3mm	1
		051115-06541-5	06541	6mm	1



3M™ Collets for 3M™ Die Grinders

Product Name		UPC	Part No.	Size	MOQ
3M™ Collet		051115-06545-3	06545	3/8"	1
		051115-06546-0	06546	8mm	1
		051115-06573-6	06573	1/8"	1
		051115-06574-3	06574	3/16"	1
		051115-06575-0	06575	1/4"	1
		051115-06576-7	06576	3mm	1
		051115-06577-4	06577	6mm	1
3M™ Collet for 0.3 HP		051141-55772-4	55772	1/8"	1
		051141-55752-6	55752	1/4"	1





3M™ Elite Random Orbital Sander Wet Sanding Shroud Kit

Product Name		UPC	Part No.	Size	MOQ
3M™ Elite Random Orbital Sander Wet Sanding Shroud Kit		051141-28653-2	28653	5"	1







3M™ Flanges

Product Name		UPC	Part No.	Size	Thread Size	MOQ
3M™ Flange		051141-55100-5	55100	1-1/4"	3/8-24 INT	1
3M™ Flange Nut		051141-28739-3	28739	1" x 5/8"	3/8-24 INT	1
		051141-28740-9	28740	1"	5/8-11 INT	1







3M™ Power Tool Flange Nuts

Product Name		UPC	Part No.	Size	Thread Size	MOQ
3M™ Retainer-Grinding Wheel		051141-55082-4	55082	—	3/8-24 INT	1
3M™ Wheel Retainer		051115-06585-9	06585	—	3/8-24 INT	1
		051115-06590-3	06590	—	5/8-11 INT	1
3M™ Wheel Flange		051141-55085-5	55085	3/8" AH	—	1



3M™ Power Tool Handles

Product Name		UPC	Part No.	Size	Thread Size	MOQ
3M™ Handle		051141-30364-2	30364	—	—	1
3M™ Power Tool Handle Kit		051141-28395-1	28395	—	—	1
3M™ Side Handle		051141-28402-6	28402	1-1/2" x 6"	3/8-16 EXT	1
		051141-30334-5	30334	—	M8 EXT	1

3M™ Service Tool Kit

This kit contains all of the special tools needed to disassemble and reassemble 3M™ Orbital and Random Orbital Sanders.

Product Name	UPC	Part No.	MOQ
3M™ Service Tool Kit	051141-20215-0	20215	1



3M™ Wrenches for Power Tools

Product Name	UPC	Part No.	Size	MOQ
3M™ 28391 Polisher Wrench	051141-30948-4	30948	17mm	1
3M™ 28737 L Shape Hex Wrench	051115-66902-6	66902	2.0mm	1
	051115-66901-9	66901	2.5mm	1
3M™ 28631 Pad Wrench	051141-55788-5	55788	13mm	1
3M™ 3125 Clamp Nut Wrench ST041	051141-30831-9	30831	—	1
3M™ Adjustable Spanner Wrench	051115-06544-6	06544	—	1
3M™ Hex Wrench	051115-06610-8	06610	3/16"	1
3M™ Hex Wrench A0864	051115-28147-1	28147	2.5mm	1
3M™ Pad Wrench A0022	051115-28108-2	28108	24mm	1
3M™ Wrench — Drive Wheel	051141-30672-8	30672	—	1
3M™ Wrench	051115-06522-4	06522	7/8"	1
	051115-06524-8	06524	5/8"	1
	051115-06569-9	06569	9/16" x 3/4"	1
	051115-06586-6	06586	7/16" x 11/16"	1
3M™ Wrench — open end	051141-28725-6	28725*	2-15/64"	1
	051141-30437-3	30437	13/16"	1

*For 3M™ Fibre Disc Pad Hubs



3M™ Wrenches for Power Tools (cont.)

Product Name		UPC	Part No.	Size	MOQ
3M™ Wrench —L-Key		051141-30673-5	30673	4.0mm	1
		051141-30674-2	30674	2.5mm	1
3M™ Wrench A0146		051115-28134-1	28134	17mm	1
3M™ Spanner Wrench		051141-55081-7	55081	1/8" Dia. x 21/32 B.C.	1
		051141-55115-9	55115	1/8" Dia. x 1.25 B.C.	1
3M™ T-6 Lock Ring Wrench		051141-28320-3	28320	—	1



3M™ Bearing Puller

Product Name		UPC	Part No.	Size	MOQ
3M™ 3125 Bearing Puller ST501		051141-30832-6	30832	—	1



3M™ Service Tools — T-7 Soft Collar

Product Name		UPC	Part No.	Size	MOQ
3M™ T-7 Soft Collar		051141-28319-7	28319	—	1

3M™ Vacuum Hose and Accessories

Allows different size vacuum hoses to be attached to Central Vacuum-ready sanders.

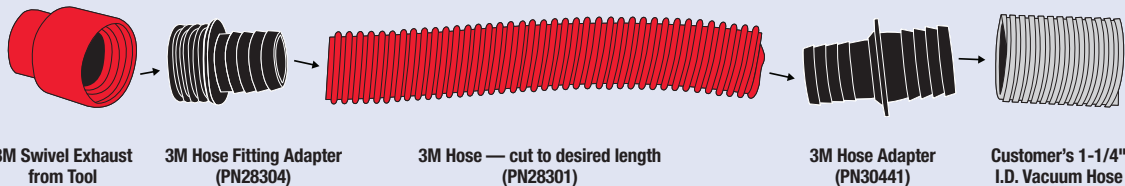

Product Name	UPC	Part No.	Description	Size	MOQ
3M™ Vacuum Bag Cover	051141-28303-6	A1434	<ul style="list-style-type: none"> • Holds and protects paper Vacuum Bag Insert (PN20338) • Black Cloth 	9" Wide 20" Long	1
3M™ Vacuum Bag Inserts	051141-20338-6	20338	<ul style="list-style-type: none"> • Paper vacuum bag used to collect dust when using a SGV Orbital or ROS • Connects to 1" vacuum hose (PN28301) with adapter (PN28302) • Fits inside cloth bag cover (PNA1434) 	1" INT	50
3M™ Vacuum Hose Adapter	051141-28302-9	28302	<ul style="list-style-type: none"> • Used to connect 1" External Hose Thread vacuum hose to paper vacuum bag and cloth cover bag 	1" INT	1
	051141-30441-0	30441	<ul style="list-style-type: none"> • Used to attach a 1" ID vacuum hose to a 1-1/4" ID vacuum hose • 1" friction fit barb pushes into ID of 1" vacuum hose • 1-1/4" friction fit barb pushes into ID of 1-1/4" vacuum hose 	1" Dia 1-1/4" OD	1
	051141-30440-3	30440	<ul style="list-style-type: none"> • Used to attach a 1" ID vacuum hose to a 1-1/2" ID hose • 1" friction fit barb pushes into ID of 1" hose • 1-1/2" friction fit barb pushes into ID of 1-1/2" hose 	1" Dia 1-1/2" OD	1
	051141-30439-7	30439	<ul style="list-style-type: none"> • Used to attach a 1" ID vacuum hose to a 2" ID hose • 1" friction fit barb pushes into ID of 1" hose • 2" friction fit barb pushes into ID of 2" hose 	1" Dia 2" OD	1
3M™ Vacuum Hose End Adapter	051141-30324-6	30324	<ul style="list-style-type: none"> • Used to attach a 1" ID vacuum hose to a 3/4" ID hose • 1" internal hose thread in one end of the adapter; 3/4" internal hose thread in the other end 	3/4" INT 1" INT	1
	051141-20340-9	20340	<ul style="list-style-type: none"> • Used to attach a 1" threaded hose to a 1-1/4" threaded hose 	1" INT 1-1/4" INT	1
3M™ Vacuum Hose Fitting Adapter	051141-20341-6	20341	<ul style="list-style-type: none"> • 1" INT hose thread x 1-1/2" OD Hose Adapter 	1-1/2" ID 1" INT	1
	051141-28304-3	28304	<ul style="list-style-type: none"> • Used to attach a 1" ID vacuum hose to 3M™ Random Orbital Sander • 1" vacuum hose external thread (left hand thread) screws into ROS exhaust assembly • 1" friction fit barb pushes into ID of the hose 	1" Dia 1" EXT	1
3M™ Vacuum Hose Anti-Static	051141-28730-0	28730	<ul style="list-style-type: none"> • Black vacuum hose used to properly connect 3M™ Dust Shrouds, 3M™ Random Orbital and Orbital Sanders to a vacuum system for superb performance 	1" ID 4 ft Long 1" EXT	1

How to Connect a Random Orbital Sander to a 1-1/4" Vacuum Hose



3M™ Vacuum Hose and Accessories (cont.)





Allows different size vacuum hoses to be attached to Central Vacuum-ready sanders.

Product Name	UPC	Part No.	Description	Size	MOQ	
3M™ Vacuum Hose		051141-28301-2	28301	<ul style="list-style-type: none"> Red vacuum hose used to properly connect 3M™ Random Orbital and Orbital Sanders to a vacuum system for superb performance 	1" ID 6 ft Long 1" EXT	1
		051141-28393-7	28393	<ul style="list-style-type: none"> Red vacuum hose used to properly connect 3M™ Random Orbital and Orbital Sanders to a vacuum system for superb performance 	1" ID 60 ft Long 1" EXT	1
3M™ Vacuum Hose Swivel Adapter		051141-30442-7	30442	<ul style="list-style-type: none"> Used to attach a 1" ID vacuum hose to another 1" ID vacuum hose to create a longer vacuum hose 1" internal hose thread in both ends of the adapter 	1" INT x 1" INT	1





3M™ Type 27 Grinder Guards

Replacement parts for 3M™ Right Angle Grinders and Sanders.

Product Name	UPC	Part No.	Size	MOQ	
3M™ Type 27 Guard		051141-55109-8	55109	4"	1
3M™ Grinder Guard (flat back)		051141-55106-7	55106	4-1/2"	1
3M™ Type 27 Guard		051141-55108-1	55108	4-1/2"	1
3M™ Grinder Guard	 Photo Not Available	051141-28632-7	28632	5"	1







3M™ Power Tool Overhose Kit and Sleeve

Product Name	UPC	Part No.	Description	Size	MOQ	
3M™ Overhose Kit		051141-28651-8	28651	<ul style="list-style-type: none"> For 0.3 HP Die Grinders Kit Contains: Air Line Extension (PN20209), Adapter (PN20453), Overhose Cloth Sleeve, Exhaust Spacer, Air Inlet Bushing and Instruction Sheet 	—	1
3M™ Overhose Replacement Sleeve		051141-28652-5	28652	<ul style="list-style-type: none"> Replaces the sleeve that comes in the Overhose Kit for 0.3 HP Die Grinders Zip tie allows it to be attached to the rubber adapter supplied with the kit Can also be used on 0.5 HP and 1 HP Die Grinders and Disc Sanders 	1-1/2" x 4 ft	5











3M™ Roloc™ Dust Shroud Kits and Accessories

Product Name	UPC	Part No.	Description	Size	MOQ	
3M™ Roloc™ TR Dust Shroud Kit		051141-28727-0	28727	<ul style="list-style-type: none"> Converts a 3M™ Disc Sander (0.3 HP or 0.5 HP) into a vacuum Disc Sander Comes with a 2" Roloc™ TR Cool Running Disc Pad (PN82974) and an alignment jig for mounting the shroud onto the 3M Disc Sander For use with 3M™ Roloc™ D/F TR Discs TS/TSM Holder is also available 	2"	1
		051141-28728-7	28728	<ul style="list-style-type: none"> Converts a 3M™ Disc Sander (0.3 HP or 0.5 HP) into a vacuum Disc Sander Comes with a 3" Roloc™ TR Cool Running Disc Pad (PN82975) and an alignment jig for mounting the shroud onto the 3M Disc Sander For use with 3M™ Roloc™ D/F TR Discs TS/TSM Holder is also available 	3"	1
3M™ Dust Shroud Clear Skirt		051141-28743-0	28743	<ul style="list-style-type: none"> Replaces the clear skirt that comes with the 2" Disc Sander Dust Shroud Kit (PN28727) after it has become worn or cloudy in appearance The worn skirt is easily removed and the new skirt snaps into the lip molded into the shroud 	2"	5
		051141-28741-6	28741	<ul style="list-style-type: none"> Replaces the clear skirt that comes with the 3" Disc Sander Dust Shroud Kit (PN28728) after it has become worn or cloudy in appearance The worn skirt is easily removed and the new skirt snaps into the lip molded into the shroud 	3"	5



3M™ Adapters

Used to change the attachment style of a tool for use with common attachments used on accessories for abrasive disc products.



Product Name	UPC	Part No.	Description	Thread Size	MOQ	
3M™ Disc Holder Adapter 9		048011-22970-6	9	<ul style="list-style-type: none"> Convert a sander with a 3/8–24 external threaded shaft to a 5/8–11 EXT threaded shaft Use with 5/8–11 disc holders 	5/8–11 EXT x 3/8–24 INT	1
		048011-22971-3	9	<ul style="list-style-type: none"> Convert a sander with an M10–1.25 EXT threaded shaft to a 5/8–11 EXT threaded shaft Use with 5/8–11 disc holders 	5/8–11 EXT x M10–1.25 INT	1
		048011-22972-0	9	<ul style="list-style-type: none"> Convert a sander with an M10–1.5 EXT threaded shaft to a 5/8–11 EXT threaded shaft Use with 5/8–11 disc holders 	5/8–11 EXT x M10–1.50 INT	1
3M™ Wheel Adapter 81A		051144-45081-7	45081	<ul style="list-style-type: none"> Use with Type 81 and Type 84 PG Wheels 1/4" diameter shank and 1/4–20 INT thread to fit PG Wheels with 1/4–20 EXT threads 	1/4–20 INT	1
3M™ Wheel Adapter Kit		051141-28419-4	28419	Kit contains: <ul style="list-style-type: none"> one spindle extension 5/8–11 INT x 1/2–20 EXT three #5 telescoping adapters 5/8" wide one set #3 Flange Adapter 1" x 1/2" one set #3 Flange Adapter 1" x 5/8" two 2" OD x 1/2" ID Steel Washers two 2" OD x 5/8" ID Steel Washers one end cap 1" x 1/2–20 INT 	1/2–20 EXT x 5/8–11 INT	1
		051144-45038-1	45038	Kit contains: <ul style="list-style-type: none"> one spindle extension four 3/8" wide spacers two 3/16" wide spacers one 1" arbor hole adapter one cap nut one Allen Wrench 	5/8–11 EXT x 5/8–11 INT	1
		051141-27819-5	28719	<ul style="list-style-type: none"> Fits 3M™ Rubber Slotted Expander Wheel (PN28718) Kit contains: <ul style="list-style-type: none"> one adapter 1" x 5/8–11 INT one end cap 1" x 5/8–11 INT one spacer 1" dia. x 5/8" CH x 3/16" wide one 5/8–11 x 1-1/2" LG SHCS one 1/2" Allen Wrench 	5/8–11 INT	1

3M™ Adapters (cont.)

Used to change the attachment style of a tool for use with common attachments used on accessories for abrasive disc products.

Product Name	UPC	Part No.	Description	Thread Size	MOQ	
3M™ Spindle Extender Kit		048011-04019-6	300	<ul style="list-style-type: none"> Use on flexible shafts with Scotch-Brite™ Wheels 6" or 8" diameter and up to 4" wide for better alignment and handling Spindle has 5/8–11 INT thread and 5/8–11 EXT thread Kit contains: <ul style="list-style-type: none"> two 3/8" wire spacers two 1" x 5/8" flange adapters one 2" OD x 5/8" ID washer one spanner nut one spindle extension 	5/8–11 EXT x 5/8–11 INT	1
Replacement Spacers		051141-28636-5	28636	1" OD x 5/8" ID x 3/8" thick	—	1
		051141-28637-2	28637	1" OD x 5/8" ID x 3/16" thick	—	1

3M™ Bristle Disc Adapters

Product Name	UPC	Part No.	Description	Size	MOQ	
3M™ Flange Adapter		048011-27628-1	27628	<ul style="list-style-type: none"> 6" Flange Adapter Flange minimum capacity of 7 discs (1/2" wide) used with 6" Radial Bristle Discs to optimize mount on bench motors with a shaft size of 1" diameter A #5 Flange Adapter can be used on shaft sizes down to 1/2" diameter 	2" Dia x 1" ID	25
3M™ Tapered Spindle Mount Adapter		048011-30133-4	30133	<ul style="list-style-type: none"> Tapered Spindle Mount Adapter Adapter configured for convenient disc mount of 2" to 3" fine bristle discs Fits on standard tapered spindle for bench motors 	3/8–24 EXT	50
3M™ Spindle Extender Adapter		048011-30134-1	30134	<ul style="list-style-type: none"> 6" Spindle Extender Adapter 	2" x 1/2" x 1"	40

3M™ Bristle Disc Mandrel

Used with Bristle Discs to change the center hole to fit machine shaft size.

Product Name	UPC	Part No.	Description	Length	Shank Size	MOQ	
3M™ Bristle Disc Mandrel		048011-27680-9	27680	<ul style="list-style-type: none"> Use with small radial bristle discs 1" diameter or smaller with 1/16" center hole Fits 3/32" drill or collet chucks Max RPM 30,000 	1-3/4"	3/32"	5

3M™ SR Rotary Cutter

Use these plastic rotary cutters on a right angle power tool with its integral metal mandrel at slow speeds to remove sealant and adhesives. Removes coatings without damaging the underlying base material like paints, primers, alodine and metal.

Product Name	UPC	Part No.	Diameter	Length	Thread Size	Max RPM	MOQ	
3M™ SR Cutter No.3		048011-30096-2	3	.40"	.975"	1/4–28 EXT	3,200	40
3M™ SR Cutter No.8		048011-30095-5	8	.83"	1.015"	1/4–28 EXT	3,200	40

3M™ Disc Pad Face Plates

3M™ Disc Pad Face Plates can be easily changed without removing the hub. Allows the operator to use a single tool for multiple applications from grinding to finishing a work piece.

Available in the following densities to meet various applications:



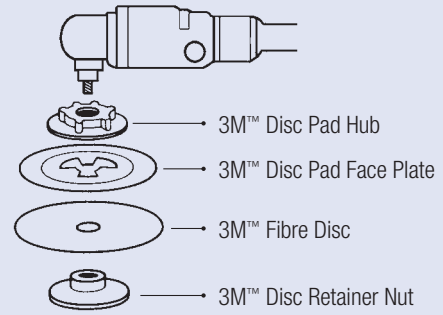

Color	Description	Applications
Red	Extra Hard	Heavy grinding
Black	Hard	Heavy metal removal, large welds, etc
Gray	Medium	General purpose grinding and finishing — normal flexibility
White	Soft	Finishing operations — flexible, follows contours

Power Tool Assembly















3M™ Disc Pad Face Plates

For use with fibre discs. Available in various hardnesses for use with various size discs and fibre disc pad hubs.

Product Name	UPC	Part No.	Description	Diameter	Color	Hardness	Max RPM	MOQ	
3M™ Disc Pad Face Plate, Smooth		051144-13325-3	13325	Smooth	4-1/2"	Gray	Medium	13,300	1
		051144-14270-5	14270	Smooth	4-1/2"	Black	Hard	13,300	1
		051144-45208-8	45208	Smooth	5"	White	Soft	12,000	10
		051144-45194-4	45194	Smooth	7"	White	Soft	8,600	10

3M™ Disc Pad Face Plates (cont.)

For use with fibre discs. Available in various hardnesses for use with various size discs and fibre disc pad hubs.

Product Name	UPC	Part No.	Description	Diameter	Color	Hardness	Max RPM	MOQ	
3M™ Disc Pad Face Plate, Ribbed		051141-28656-3	28656	Ribbed	4"	Red	Extra Hard	15,000	10
		051141-28657-0	28657	Ribbed	4"	Black	Hard	15,000	10
		051141-28658-7	28658	Ribbed	4"	Gray	Medium	15,000	10
		051141-28443-9	28443	Ribbed	4-1/2"	Red	Extra Hard	13,300	1
		051144-81734-4	81734	Ribbed	5"	Gray	Medium	12,000	1
		051144-81733-7	81733	Ribbed	5"	Black	Hard	12,000	1
		051144-81732-0	81732	Ribbed	5"	Red	Extra Hard	12,000	1
		051141-28625-9	28625	Ribbed	5"	Red	Extra Hard	12,000	100
		051144-80516-7	80516	Ribbed	7"	Gray	Medium	8,600	1
		051144-80515-0	80515	Ribbed	7"	Black	Hard	8,600	1
		051144-80514-3	80514	Ribbed	7"	Red	Extra Hard	8,600	1
		051144-81729-0	81729	Ribbed	9"	Black	Hard	6,600	10
		051144-81728-3	81728	Ribbed	9"	Red	Extra Hard	6,600	10

3M™ Disc Pad Hubs*

Disc pad hubs have a threaded metal insert and can be used on most face plates.

Product Name	UPC	Part No.	Description	Diameter	Thread Size	Color	MOQ	
3M™ Disc Pad Hub		051144-11824-3	11824	<ul style="list-style-type: none"> • GL Quick Change • Use with 4" to 7" face plates • Adapters available for M10–1.25, M10–1.50, 3/8–24 shafts* 	2-1/2"	5/8–11 INT	Black	1
		051144-45205-7	45205	<ul style="list-style-type: none"> • Can be used on all 4" to 9" face plates 	2-1/2"	5/8–11 INT	Black	1
		051141-28626-6	28626	<ul style="list-style-type: none"> • Can be used on all 4" to 9" face plates 	2-1/2"	5/8–11 INT	Black	40
		051144-88743-9	88743	<ul style="list-style-type: none"> • For right angle grinders with 5/8–11 EXT short shafts (3/8"–1/2" long) • Can be used on 4" to 9" face plates 	2-1/2"	5/8–11 EXT x 5/8–11 INT	Black	1
		051141-28442-2	28442	<ul style="list-style-type: none"> • Low Profile design allows fibre disc to fit inside tool guards • For right angle grinders with 3/8–24 EXT shaft • Can be used on all 4" to 9" face plates • 5/8–11 EXT thread for 3M retainer nuts or TN Fibre discs 	2-1/2"	3/8–24 INT x 5/8–11 EXT	Black	1
		051141-28476-7	28476	<ul style="list-style-type: none"> • Low Profile design allows fibre disc to fit inside tool guards • Can be used on 4" to 9" face plates 	2-1/2"	5/8–11 INT	Black	10
		051141-28477-4	28477	<ul style="list-style-type: none"> • Low Profile design allows fibre disc to fit inside tool guards • Can be used on 4" to 9" face plates 	2-1/2"	M14–2.0 INT	Black	10
		051144-11823-6	11823	<ul style="list-style-type: none"> • GL Quick Change • Hub is used with color-coded extra hard, hard, medium, and soft backup plates • Use with 7" face plates • Adapters available for M10–1.25, M10–1.50, 3/8–24 shafts 	4-1/2"	5/8–11 INT	Black	1
		051144-45190-6	45190	<ul style="list-style-type: none"> • Can be used on 7", 8" and 9" face plates 	4-1/2"	5/8–11 INT	Black	1
		051111-60306-2	86100	<ul style="list-style-type: none"> • Can be used on 7" and larger face plates 	4-1/2"	5/8–11 INT	Black	10
3M™ Disc Pad Hub And Retainer Nut		051141-28416-3	28416	<ul style="list-style-type: none"> • Disc pad hub and retainer nut kit • For use on grinders with M14–2 threaded spindle • Can be used on 4-1/2" through 9" Fiber Discs with 7/8" (22mm) center hole 	2-1/2"	M14–2.0 INT	Black	1
		051141-28417-0	28417	<ul style="list-style-type: none"> • Disc pad hub and retainer nut kit • For use on grinders with M14–2 threaded spindle • Can be used on 7" through 9" Fiber Discs with 7/8" (22mm) center hole 	4-1/2"	M14–2.0 INT	Black	1



*See page 14

3M™ Disc Retainer Nuts

For use with 3M™ Disc Pad Hub and Face Plates and 3M™ Fibre Disc Holders. 1/4" diameter holes for use with a spanner wrench.

Product Name	UPC	Part No.	Length	Thread Size	MOQ	
3M™ Disc Retainer Nut		051111-51047-6	02618	5/16"	5/8-11 INT	10
		051141-28654-9	28654	5/16"	M14-2.0 INT	10
		051144-05620-0	05620	5/8"	5/8-11 INT	1
		051144-05622-4	05622	3/8"	5/8-11 INT	1
		051144-05621-7	05621	1/2"	5/8-11 INT	1
		051141-28418-7	28418	1/2"	M14-2.0 INT	10

3M™ Fibre Disc Backup Pads

Product Name	UPC	Part No.	Description	Size	MOQ	
3M™ Fibre Disc Backup Pad 		051131-05637-4	05637	<ul style="list-style-type: none"> • For use with Fibre Discs on pistol grip sanders • Uses retainer nut supplied with sander • 18,00 Max RPM 	5" x 7/8" CH	1
3M™ TN Quick Change Fibre Disc Backup Pad		051111-56573-5	02140	<ul style="list-style-type: none"> • TN platform allows quick change of 3M products as needed without using tools or retainer nuts • Use with TN discs • 13,300 Max RPM 	4-1/2" x 5/8-11 INT	5

3M™ Disc Pad Hook Types

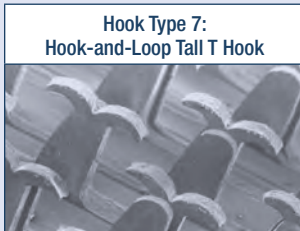
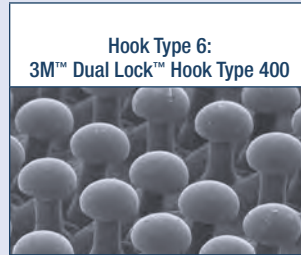
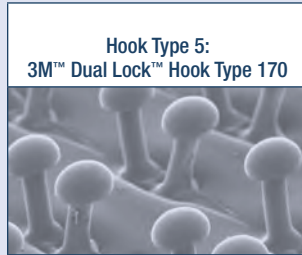
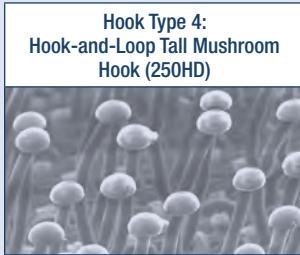
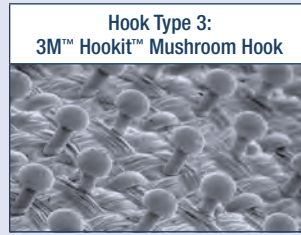
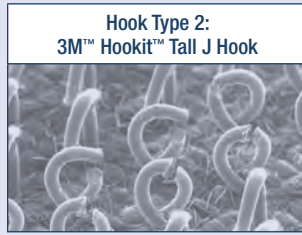
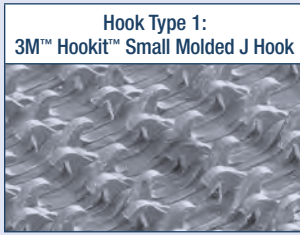

Disc Pad Holders (Hook-and-Loop)

Use with hook-and-loop discs. Allows discs to be run on right angle grinders or random orbital sanders.

Product Name	UPC	Part No.	Size	Thick-ness	Ctr. Hole	Thread/Shank Size	Density Rating	Hook Type	Max RPM (OPM)	MOQ	
3M™ Disc Pad Holder		048011-04130-8	9215	1-1/2"	1/8"	—	1/4"	Firm	5	25,000	10
		048011-07494-8	922	2"	1/8"	—	1/4"	Firm	5	23,000	1
		048011-04132-2	923	3"	1/8"	—	1/4"	Firm	5	20,000	1
Scotch-Brite™ Surface Conditioning Disc Pad Holder 7493		051131-07493-4	7493	3"	1/8"	—	1/4"	Firm	5	20,000	10
Scotch-Brite™ Surface Conditioning Disc Pad 924		048011-07492-4	924	4"	1/16"	—	1/4"	Firm	5	13,000	5
3M™ Disc Pad Holder		048011-05673-9	914	4"	1/8"	3/8"	1/2–13 INT	Firm	7	13,000	1

Disc Pad Holders (Hook-and-Loop) (cont.)

Use with hook-and-loop discs. Allows discs to be run on right angle grinders or random orbital sanders.

Product Name	Image	UPC	Part No.	Size	Thick-ness	Ctr. Hole	Thread/Shank Size	Density Rating	Hook Type	Max RPM (OPM)	MOQ
3M™ Disc Pad Holder		048011-05674-6	914	4"	1/8"	3/8"	5/8-11 INT	Firm	7	13,000	1
		048011-05677-7	914	4"	1/8"	3/8"	M14-2.0 INT	Firm	7	13,000	1
		048011-14111-4	9145	4-1/2"	1/8"	3/8"	5/8-11 INT	Firm	7	13,000	1
		048011-14114-5	9145	4-1/2"	1/8"	3/8"	M14-2.0 INT	Firm	7	13,000	1
		048011-09448-9	905	5"	1/4"	—	5/16-24 EXT	Medium	7	10,000 (12,000)	1
		048011-05680-7	915	5"	1/8"	3/8"	5/8-11 INT	Firm	7	10,000	1
		048011-05681-4	915	5"	1/8"	3/8"	M14-2.0 INT	Firm	7	10,000	1
		048011-09449-6	906	6"	1/4"	—	5/16-24 EXT	Medium	7	8,500 (10,000)	1
		048011-05682-1	916	6"	1/8"	3/8"	5/8-11 INT	Firm	7	10,000	1
		048011-09450-2	917	7"	5/16"	3/8"	5/8-11 INT	Medium	7	6,000	1
		051141-28409-5	917M	7"	5/16"	3/8"	M14-2.0 INT	Medium	7	6,000	96
3M™ Hook-and-Loop Disc Pad Holder		051141-20245-7	20245	7" x 7/8" ID	—	—	5/8-11 INT	Extra Hard	7	8,500	1
3M™ Disc Pad Holder		051141-20279-2	947TH	7"	1"	—	5/8-11 INT	Medium	7	6,000	1
3M™ Hook-and-Loop Disc Face Plate		051141-20439-0	20439	7"	—	—	—	Extra Hard	7	8,600	10
3M™ Disc Pad Holder		048011-09451-9	918	8"	5/16"	3/8"	5/8-11 INT	Medium	7	6,000	1

3M™ Disc Pads Shape Profile

- 1 One piece stud design for improved balance and reduced vibration
- 2 Color-coded pads with customized features make it simpler to achieve the exact finish desired
- 3 Upgraded hole placement for clean sanding pads for the ultimate in dust extraction

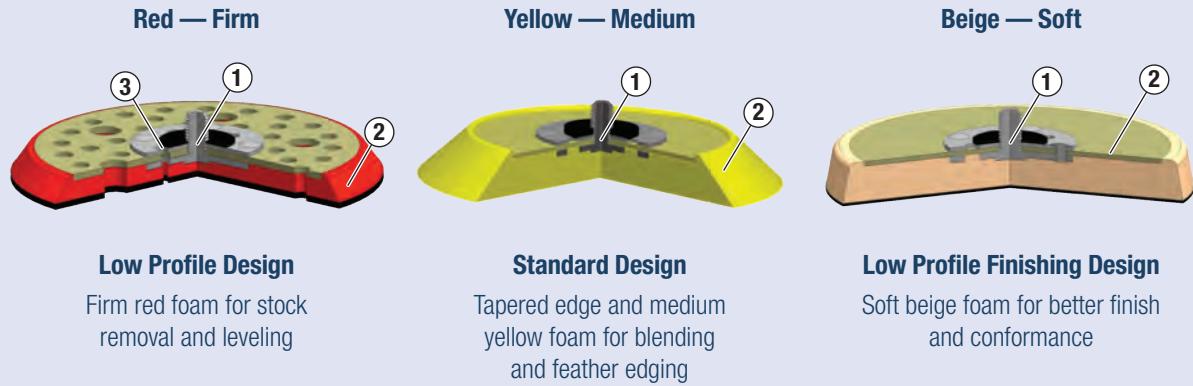

3M™ Hookit™ Disc Pads













These disc pads have a hook attachment which drives 3M™ Hookit™ Discs with brushed Nylon loop backings.

Product Name	UPC	Part No.	Diameter	Thickness	Thread Size	Density Rating	Hook Type	Max RPM (OPM)	MOQ	
3M™ Hookit™ Disc Pad		051111-55764-8	02700	3"	1/2"	5/16-24 EXT	Firm	2	15,000 (15,000)	5
		051141-28472-9	28472	3"	1/2"	1/4-20 EXT	Firm	2	15,000 (15,000)	5
		051144-88739-2	88739	3"	11/16"	5/8-11 INT	Medium	1	6,000	5
		051144-82880-7	82880*	3-1/2"	1/2"	5/16-24 EXT	Medium	1	12,000 (12,000)	240
		051131-05775-3	05775	5"	3/4"	5/16-24 EXT	Medium	1	12,000 (12,000)	1
		051144-85105-8	85105	5"	3/4"	5/8-11 INT	Medium	1	12,000	1
		051144-85096-9	85096	5"	5/8"	5/8-11 INT	Medium	1	12,000	1
		051141-28662-4	28662	5"	1/2"	5/8-11 INT	Firm	1	12,000	1

*Not Available in U.S.

























3M™ Hookit™ Disc Pads (cont.)

These disc pads have a hook attachment which drives 3M™ Hookit™ Discs with brushed Nylon loop backings.

Product Name		UPC	Part No.	Diameter	Thickness	Thread Size	Density Rating	Hook Type	Max RPM (OPM)	MOQ
3M™ Hookit™ Disc Pad		048011-18444-9	18444	5"	3/4"	M8-1.25 INT	Medium	1	10,000 (12,000)	5
	NEW! LB 	051141-28709-6	70138	6"	3/4"	5/16-24 EXT	Medium	2	12,000 (12,000)	1
		051144-13627-8	947	7"	1"	5/8-11 INT	Medium	1	6,000	1
		051131-07394-4	07394	7" (178mm)	1" (25mm)	M14-2.0 INT	Medium	1	6,000	1
		051144-77751-8	77751	8"	5/16"	5/8-11 INT	Firm	1	6,000	1
		051141-28548-1	77751B	8"	5/16"	5/8-11 INT	Medium	1	6,000	50
	NEW!  Photo Not Available	051141-20248-8	20248	8"	—	5/8-11 INT	Firm	1	6,000	24
	CFM 	051131-05779-1	05779	8"	1"	5/8-11 INT	Medium	1	3,000	1
	CFM 	051131-05768-5	05768	8"	1"	5/8-11 INT	Soft	1	3,000	1
		051141-27884-1	27884	8"	1/2"	5/8-11 INT	Medium	1	6,000	150
3M™ Hookit™ Low Profile Disc Pad	LB 	051141-20352-2	20352	5"	3/8"	5/16-24 EXT	Firm	2	12,000 (12,000)	1
	LB 	051141-20355-3	20355	6"	3/8"	5/16-24 EXT	Firm	2	12,000 (12,000)	1
3M™ Hookit™ Low Profile Finishing Disc Pad	LB 	051144-77855-3	77855	5"	11/16"	5/16-24 EXT	Soft	1	12,000 (12,000)	1

3M™ Hookit™ D/F Disc Pads

For use with 3M™ Hookit™ D/F Discs. Available in various densities and thicknesses for your vacuum sanding needs.

Product Name	UPC	Part No.	Size	Thick-ness	Thread Size	# of Dust Holes	Density Rating	Hook Type	Max RPM (OPM)	MOQ	
3M™ Hookit™ D/F Disc Pad	 	051144-82659-9	82659	5"	3/4"	5/16-24 EXT	5	Medium	1	12,000 (12,000)	1
		051141-28411-8	28411	5" (for 6" ROS)	3/4"	5/16-24 EXT	5	Medium	1	12,000 (12,000)	1
	 	051131-05876-7	05876	6" x 3/4" CH	3/4"	5/16-24 EXT	7	Medium	1	12,000 (12,000)	1
	 	051131-07390-6	07390	6" x 3/4" CH	3/4"	M8-1.25 EXT	6	Medium	1	12,000 (12,000)	1
	 	051131-05781-4	05781	8"	3/8"	5 Bolt Holes	8	Medium	1	1,500 (10,000)	1
	 	051131-05782-1	05782	8"	3/8"	6 Bolt Holes	8	Medium	1	1,500 (10,000)	1
	  	051131-05780-7	05780	8"	—	5/8-11 INT	12	Firm	3	1,500	1
	  	051131-05783-8	05783	8"	3/8"	5 Bolt Holes	8	Firm	1	1,500	1
3M™ Hookit™ D/F Low Profile Backup Pad	 	051131-05855-2	05855	5"	3/8"	5/16-24 EXT	5	Firm	1	12,000 (12,000)	1
3M™ Hookit™ D/F Low Profile Disc Pad	 	051141-25122-6	25122	6"	3/8"	5/16-24 EXT	6	Firm	2	12,000 (12,000)	1
3M™ Hookit™ D/F Low Profile Finishing Disc Pad	 	051144-77856-0	77856	5"	11/16"	5/16-24 EXT	5	Soft	1	12,000 (12,000)	1
	 	051111-51042-1	84226	5"	11/16"	5/16-24 EXT	5	Soft	1	12,000 (12,000)	1

3M™ Hookit™ Pad

Pad provides excellent adhesion with the brushed Nylon loop backing. Hook attachment firmly secures the 3M™ Hookit™ Sheet and allows easy sheet removal. Use with 3M™ Hookit™ Abrasive Sheets.

Product Name	UPC	Part No.	Size	Thickness	Color	Face Color	Density Rating	Hook Type	Max OPM	MOQ	
3M™ Hookit™ Pad		051141-20433-8	20433	3" x 4"	1/2"	Red	Black	Medium	1	10,000	10









3M™ Hookit™ D/F Pad

Product Name	UPC	Part No.	Size	Thickness	# of Dust Holes	Density Rating	Hook Type	Max OPM	MOQ	
3M™ Hookit™ D/F Pad		051141-20242-6	20242	3" x 4"	1/2"	4	Medium	1	12,000	200

3M™ Hookit™ Roloc™ Disc Pads

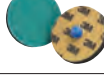
Hook material attached to soft neoprene foam which provides a resilient base when using QRS Flexible Diamond discs. These disc pads allows for easy micron grade change. Pad must be used with proper Roloc™ Disc Pad hardware.

Product Name	UPC	Part No.	Attachment	Diameter	Thickness	Density Rating	Hook Type	Max RPM (OPM)	MOQ	
3M™ Hookit™ Roloc™ Disc Pad		051144-82564-6	82564	Roloc™ TR	1"	5/16"	Medium	2	8,000 (10,000)	10
		051111-60311-6	67415	Roloc™ TR	1-1/16"	5/16"	Medium	1	10,000 (10,000)	20
	NEW! 	051141-28655-6	28655	Roloc™ TR	1-1/4"	5/16"	Medium	1	10,000 (10,000)	20
		051144-82565-3	82565	Roloc™ TR	1-1/2"	5/16"	Medium	2	8,000 (10,000)	5
		051144-82566-0	82566	Roloc™ TR	2"	5/16"	Medium	2	8,000 (10,000)	5
		051144-82567-7	82567	Roloc™ TR	3"	5/16"	Medium	2	8,000 (10,000)	1

3M™ Roloc™ PSA Disc Pad

Skin surface of neoprene foam provides a resilient base when using PSA Flexible Diamond discs.

Product Name	UPC	Part No.	Diameter	Attachment	Density Rating	Max OPM	Max RPM	MOQ	
3M™ Roloc™ PSA Disc Pad		051144-85287-1	85287	2"	Roloc™ TR	Medium	10,000	10,000	5

3M™ Hookit™ Clean Sanding Disc Pads



Designed with high performance hole patterns. Pair with a 3M™ Random Orbital Sander to increase abrasive life and achieve high efficiency dust pickup.

Product Name	UPC	Part No.	Size	Thick-ness	Thread Size	# of Holes	Density Rating	Hook Type	Max RPM (OPM)	MOQ
 3M™ Clean Sanding Disc Pad Kit* 	051141-20427-7	20427	3"	1/2"	5/16-24 INT	6	Medium	1	15,000 (15,000)	5
 3M™ Clean Sanding Soft Disc Pad	051141-20428-4	20428	3"	3/4"	1/4-20 EXT	6	Soft	1	12,000 (12,000)	10
 3M™ Hookit™ Clean Sanding Low Profile Disc Pad	051141-20350-8	20350	3"	1/2"	1/4-20 EXT	3	Firm	2	15,000 (15,000)	10
 3M™ Clean Sand Painter's Pad with Hookit™ 	051131-05858-3	05858	5" x 3/4" CH	1/2"	5/16-24 EXT	31	Soft	1	12,000 (12,000)	1
 3M™ Clean Sanding Backup Pad	051141-20206-8	20206	5" x 3/4" CH	1/2"	5/16-24 EXT	31	Medium	1	12,000 (12,000)	10
 3M™ Clean Sanding Low Profile Finishing Disc Pad 	051141-20290-7	20290	5"	11/16"	5/16-24 EXT	44	Soft	1	12,000 (12,000)	1
 3M™ Hookit™ Clean Sanding Low Profile Disc Pad 	051141-20353-9	20353	5"	3/8"	5/16-24 EXT	44	Firm	2	12,000 (12,000)	1
 3M™ Clean Sanding Low Profile Disc Pad 861 Plus 	051141-20465-9	20465	6" x 5/8" CH	3/8"	5/16-24 EXT	53	Firm	2	12,000 (12,000)	1
 3M™ Clean Sanding Soft Disc Pad 	051141-20425-3	20425	6" x 3/4" CH	1/2"	5/16-24 EXT	53	Soft	1	10,000 (12,000)	1
 3M™ Hookit™ Clean Sand Painter's Backup Pad 	051131-05551-3	05551	6" x 3/4" CH	1/2"	5/16-24 EXT	25	Soft	1	12,000 (12,000)	1
 3M™ Hookit™ Clean Sanding Low Profile Disc Pad 	051141-20356-0	20356	6"	3/8"	5/16-24 EXT	52	Firm	2	12,000 (12,000)	1
 3M™ Clean Sanding Dust Free Disc Pad with Hookit™ 	051131-05865-1	05865	6" x 3/4" CH	1/2"	5/16-24 EXT	25	Medium	1	10,000 (12,000)	10

*Kit includes 5 adapters: 1/4-20 EXT x 5/16-24 EXT; 1/4-20 INT x 5/16-24 EXT; 1/4-28 EXT x 5/16-24 EXT; 5/16-24 EXT x 5/16-24 EXT; 5/16-24 EXT x 6mm-1.0 EXT

3M™ Hookit™ Clean Sanding Pads

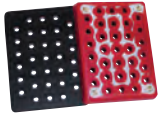
3M™ Clean Sanding Holders and Abrasives with a multi-hole design pattern to achieve high efficiency dust pickup. Use the 3M™ Vacuum Sander, Clean Sanding Holders and Clean Sanding Sheets for a total system solution.

Product Name	UPC	Part No.	Size	Thickness	# of Holes	Color	Face Color	Density Rating	Hook Type	Max OPM	MOQ	
3M™ Hookit™ Clean Sanding Pad		051141-20435-2	20435	3" x 4"	1/2"	33	Red	Black	Medium	1	10,000	10
		051141-28531-3	28531	70mm x 198mm	12.7mm	33	Red	Black	Medium	1	10,000	5

3M™ Hookit™ Clean Sanding Pad Hook Saver

Protects the hooks on a new 3M™ Hookit™ Clean Sanding Pad. An inexpensive attachment device to be consumed during sanding in place of a more expensive pad. Use with 3M™ Hookit™ Clean Sanding Pad (PN20435).

Product Name	UPC	Part No.	Size	# of Holes	Face Color	Hook Type	Max OPM	MOQ	
3M™ Clean Sanding Pad Hook Saver		051141-28325-8	28325	3" x 4"	33	Black	2	12,000	20

3M™ Hookit™ Soft Interface Disc Pad

Constructed of a soft durable foam to be used with standard 3M™ Hookit™ Backup Pad which increases conformability allowing the technician to get in closer to most edges.

Product Name	UPC	Part No.	Diameter	Thickness	Density Rating	Hook Type	Max RPM (OPM)	MOQ	
3M™ Hookit™ Soft Interface Disc Pad		051111-56491-2	70166	5"	1/2"	Soft	1	12,000 (12,000)	10

3M™ Hookit™ Clean Sanding Interface Pads

Use with 3M™ Clean Sanding Discs. Constructed of soft durable foam. When used with a Clean Sanding Multi-hole Hookit™ Backup Pad it increases conformability allowing you to follow contours and get closer to most edges while maximizing dust extraction.

Product Name	UPC	Part No.	Size	Thick-ness	Ctr Hole	# of Dust Holes	Density Rating	Hook Type	Max RPM (OPM)	MOQ
3M™ Clean Sanding Interface Pad	051141-28324-1	28324	3" x 4"	1/2"	—	33	Medium	3	— (12,000)	10
3M™ Clean Sanding Interface Disc Pad	051141-28323-4	28323	5" Dia.	1/2"	3/4"	31	Medium	3	12,000 (12,000)	10
3M™ Hookit™ Soft Interface Pad CFM	051131-05771-5	05771	3" Dia.	1/2"	—	6	Soft	3	15,000 (15,000)	10
3M™ Clean Sanding Soft Interface Disc Pad	051141-20278-5	20278	5" Dia.	1/2"	3/4"	31	Soft	3	12,000 (12,000)	10
	051141-28321-0	28321	5" Dia.	1/2"	—	44	Soft	2	12,000 (12,000)	10
	051141-28322-7	28322	6" Dia.	1/2"	—	52	Soft	2	12,000 (12,000)	10
3M™ Hookit™ Soft Interface Pad CFM	051131-05777-7	05777	6" Dia.	1/2"	3/4"	25	Soft	3	12,000	1

3M™ Hookit™ Clean Sanding Disc Pad Hook Savers

Protects the hooks on a new 3M™ Hookit™ Clean Sanding Disc Pad. An inexpensive attachment to be consumed during sanding in place of a more expensive disc pad.

Product Name	UPC	Part No.	Use With	Diameter	Ctr Hole	# of Dust Holes	Hook Type	Max RPM (OPM)	MOQ
3M™ Clean Sanding Disc Pad Hook Saver	051141-28326-5	28326	PN20350	3"	—	3	2	15,000 (15,000)	20
	051141-20444-4	20444	PN20353	5"	—	44	2	12,000 (12,000)	20
	051141-20443-7	20443	PN20206	5"	3/4"	31	2	12,000 (12,000)	20
	051141-20446-8	20446	PN20356	6"	—	52	2	12,000 (12,000)	20
	051141-20445-1	20445	PN05865	6"	3/4"	25	2	12,000 (12,000)	20



3M™ Hook-and-Loop Conversion Face

Use to convert 3M™ Hookit™ II holders to a Hook-and-Loop holder for driving Surface Conditioning Products.

Product Name	UPC	Part No.	Use With	Diameter	Hook Type	MOQ
3M™ Hook-and-Loop Conversion Face	048011-33521-6	33521	Surface Conditioning Products	11-1/4"	4	5

3M™ Random Orbital Sander 5" & 6" Backup Pads

One Piece Stud Design, Color Coded and Simplified

Red — Firm

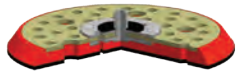

Low Profile Design

Yellow — Medium

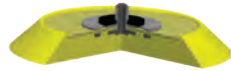

Standard Tapered Design

Beige — Soft

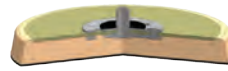





Low Profile Finishing Design

ALL PADS
AVAILABLE IN
5 & 10 CASE
LARGE BUY



	ATTACHMENT	# HOLES	PN	UPC	DIA.	THICKNESS	THREAD	FOAM	FACE	PADS/CASE	3M ID	
LOW PROFILE		3M™ Stikit™	—	20351	051141-20351-5	5"	3/8"	5/16-24 EXT	Red	Blue	10	60-4402-4106-9
		3M™ Stikit™	—	20354	051141-20354-6	6"	3/8"	5/16-24 EXT	Red	Blue	10	60-4402-4107-7
		3M™ Stikit™	—	85104	051144-85104-1	5"	3/8"	5/16-24 EXT	Red	Silver	10	60-4402-4132-5
		3M™ Stikit™	5 Holes	20442	051141-20442-0	5"	3/8"	5/16-24 EXT	Red	Blue	10	60-4402-4109-3
		3M™ Stikit™	6 Holes	20454	051141-20454-3	6"	3/8"	5/16-24 EXT	Red	Blue	10	60-4402-4108-5
		3M™ Hookit™	—	20352	051141-20352-2	5"	3/8"	5/16-24 EXT	Red	Black	10	604402-4110-1
		3M™ Hookit™	—	20355	051141-20355-3	6"	3/8"	5/16-24 EXT	Red	Black	10	60-4402-4111-9
		3M™ Hookit™	5 Holes	05855	051131-05855-2	5"	3/8"	5/16-24 EXT	Red	Yellow	10	60-4402-4137-4
		3M™ Hookit™	6 Holes	25122	051141-25122-6	6"	3/8"	5/16-24 EXT	Red	Black	10	60-4402-4112-7
		3M™ Hookit™	44 Holes	20353	051141-20353-9	5"	3/8"	5/16-24 EXT	Red	Black	10	60-4402-4115-0
		3M™ Hookit™	52 Holes	20356	051141-20356-0	6"	3/8"	5/16-24 EXT	Red	Black	10	60-4402-4113-5
		3M™ Hookit™	861 Plus, 51 Holes	20465	051141-20465-9	6"	3/8"	5/16-24 EXT	Red	Black	10	60-4402-4114-3
STANDARD		3M™ Stikit™	—	05575	051144-05575-3	5"	3/4"	5/16-24 EXT	Yellow	Blue	10	60-4402-4123-4
		3M™ Stikit™	—	45215	051144-45215-6	5"	3/4"	5/16-24 EXT	Yellow	Silver	10	60-4402-4124-2
		3M™ Stikit™	—	81821	051144-81821-1	5"	3/4"	5/16-24 EXT	Yellow	Red	10	60-4402-4125-9
		3M™ Stikit™	—	28772	051141-28772-0	6"	3/4"	5/16-24 EXT	Yellow	Blue	10	60-4402-4104-4
		3M™ Stikit™	5 Holes	45217	051144-45217-0	5"	3/4"	5/16-24 EXT	Yellow	Blue	10	60-4402-4130-9
		3M™ Stikit™	6 Holes	45218	051144-45218-7	6"	3/4"	5/16-24 EXT	Yellow	Blue	10	60-4402-4131-7
		3M™ Hookit™	—	05775	051131-05775-3	5"	3/4"	5/16-24 EXT	Yellow	Yellow	10	60-4402-4133-3
		3M™ Hookit™	—	70138	051141-28709-6	6"	3/4"	5/16-24 EXT	Yellow	Yellow	10	60-4402-4134-1
		3M™ Hookit™	5 Holes	82659	051144-82659-9	5"	3/4"	5/16-24 EXT	Yellow	Yellow	10	60-4402-4138-2
		3M™ Hookit™	6 Holes	05876	051131-05876-7	6"	3/4"	5/16-24 EXT	Yellow	Yellow	10	60-4402-4139-0
LOW PROFILE FINISHING		3M™ Stikit™	—	05545	051131-05545-2	5"	11/16"	5/16-24 EXT	Beige	Blue	10	60-4402-4126-7
		3M™ Stikit™	—	05546	051131-05546-9	6"	11/16"	5/16-24 EXT	Beige	Blue	10	60-4402-4127-5
		3M™ Stikit™	5 Holes	05645	051131-05645-9	5"	11/16"	5/16-24 EXT	Beige	Blue	10	60-4402-4129-1
		3M™ Stikit™	6 Holes	05646	051131-05646-6	6"	11/16"	5/16-24 EXT	Beige	Blue	10	60-4402-4128-3
		3M™ Hookit™	—	77855	051144-77855-3	5"	11/16"	5/16-24 EXT	Beige	Yellow	10	60-4402-4135-8
		3M™ Hookit™	5 Holes	77856	051144-77856-0	5"	11/16"	5/16-24 EXT	Beige	Yellow	10	60-4402-4140-8
		3M™ Hookit™	5 Holes + Groove	84226	051111-51042-1	5"	11/16"	5/16-24 EXT	Beige	Black	10	60-4402-4136-6
		3M™ Hookit™	44 Holes	20290	051141-20290-7	5"	11/16"	5/16-24 EXT	Beige	Yellow	10	60-4402-4144-0
		3M™ Hookit™	53 Holes	20425	051141-20425-3	6"	11/16"	5/16-24 EXT	Beige	Yellow	10	60-4402-4141-6

3M™ Stikit™ Disc Pads Face Color

Color	Description	Applications
	Slightly lower than standard adhesion, easiest removal characteristics	High heat (woodworking)
	Standard level of adhesion, standard removal characteristics	General purpose
	Standard level of adhesion, standard removal characteristics	General purpose
	Higher level of adhesion	High speed

3M™ Stikit™ D/F Disc Pads (Vacuum)

These disc pads have a vinyl face material which drives 3M™ Stikit™ D/F Discs (Vacuum) with Pressure Sensitive adhesive backings. Dust collection holes align with hole patterns in the abrasive discs.

Product Name	UPC	Part No.	Diameter	Thick-ness	Thread Size	# of Dust Holes	Density Rating	Max RPM (OPM)	MOQ	
3M™ Stikit™ D/F Disc Pad	 LB	051144-45217-0	45217	5"	3/4"	5/16-24 EXT	5 (Die #500FH)	Medium	10,000 (12,000)	1
	 LB	051144-45218-7	45218	6"	3/4"	5/16-24 EXT	6 (Die #600HZ)	Medium	10,000 (12,000)	1
3M™ Stikit™ D/F Low Profile Disc Pad	 NEW! LB	051141-20442-0	20442	5"	3/8"	5/16-24 EXT	5	Firm	12,000 (12,000)	1
	 NEW! LB	051141-20454-3	20454	6"	3/8"	5/16-24 EXT	6	Firm	12,000 (12,000)	1
3M™ Stikit™ D/F Low Profile Finishing Disc Pad	 LB	051131-05645-9	05645	5"	11/16"	5/16-24 EXT	5 (Die #500FH)	Soft	12,000 (12,000)	1
	 LB	051131-05646-6	05646	6"	11/16"	5/16-24 EXT	6 (Die #600HZ)	Soft	10,000 (12,000)	1
3M™ Stikit™ D/F Disc Pad	 CFM	051131-05581-0	05581	8"	3/8"	5 Bolt Holes	8 (Die #800JH)	Medium	1,500 (10,000)	1
	 CFM	051131-05582-7	05582	8"	3/8"	6 Bolt Holes	8 (Die #800JH)	Medium	1,500 (10,000)	1



3M™ Stikit™ Disc Pads

These disc pads have a vinyl face material which drives 3M™ Stikit™ Discs with Pressure Sensitive Adhesive backings.

Product Name		UPC	Part No.	Diameter	Thickness	Thread Size	Density Rating	Max RPM (OPM)	MOQ
3M™ Stikit™ Disc Pad		051111-56472-1	70449	1-1/8"	1/8"	—	Soft	10,000 (12,000)	5
	NEW!	051141-28754-6	28754	3-1/2"	1/2"	1/4–20 EXT	Medium	12,000 (12,000)	5
		051111-55813-3	70234	5"	1/2"	5/8–11 INT	Medium	12,000	1
		051141-28661-7	28661	5"	1/2"	5/8–11 INT	Medium	12,000	1
		051144-82189-1	82189	5"	3/4"	5/8–11 INT	Medium	12,000	1
	LB	051144-05575-3	05575	5"	3/4"	5/16–24 EXT	Medium	10,000 (12,000)	1
	LB	051144-45215-6	45215	5"	3/4"	5/16–24 EXT	Medium	10,000 (12,000)	1
	LB	051144-81821-1	81821	5"	3/4"	5/16–24 EXT	Medium	10,000 (12,000)	1
		051144-82178-5	82178	5"	1-1/4"	5/16–24 EXT	Soft	7,500 (12,000)	1
	NEW! LB	051141-28772-0	28772	6"	3/4"	5/16–24 EXT	Medium	10,000 (12,000)	1
	CFM	051144-05579-1	05579	8"	1"	5/8–11 INT	Medium	3,000	1
	CFM	051131-05568-1	05568	8"	1"	5/8–11 INT	Soft	3,000	1
3M™ Stikit™ Low Profile Disc Pad		051141-20348-5	20348	3"	1/2"	1/4–20 EXT	Firm	15,000 (15,000)	10
	LB	051144-85104-1	85104	5"	3/8"	5/16–24 EXT	Firm	10,000 (12,000)	1
	LB	051141-20351-5	20351	5"	3/8"	5/16–24 EXT	Firm	12,000 (12,000)	1
	LB	051141-20354-6	20354	6"	3/8"	5/16–24 EXT	Firm	12,000 (12,000)	1
3M™ Stikit™ Low Profile Finishing Disc Pad	LB	051131-05545-2	05545	5"	11/16"	5/16–24 EXT	Soft	12,000 (12,000)	1
	LB	051131-05546-9	05546	6"	11/16"	5/16–24 EXT	Soft	10,000 (12,000)	1

3M™ Stikit™ Pad

Lightweight, shock-resistant pads have a tough vinyl face that provides excellent adhesion yet allows quick, easy sheet removal. Well-balanced pads made with a rugged, durable, plastic hub and foam body. For use with 3" x 4" 3M™ Stikit™ Sheets or 3" wide 3M™ Stikit™ Sheet Rolls with adhesive contained on the backing.

Product Name	UPC	Part No.	Size	Thickness	Color	Face Color	Density Rating	Max OPM	MOQ	
3M™ Stikit™ Pad		051141-20432-1	20432	3" x 4"	1/2"	Red	Blue	Medium	10,000	10
		051141-28660-0	28660	2-3/4" x 7-3/4"	1/2"	Red	Blue	Medium	10,000	5



3M™ Stikit™ D/F Pad

Product Name	UPC	Part No.	Size	Thickness	Color	Face Color	Density Rating	Max OPM	MOQ	
3M™ Stikit™ D/F Pad		051141-20434-5	20434	3" x 4"	1/2"	Red	Blue	Firm	10,000	10





3M™ Stikit™ Soft Interface Disc Pad

Soft foam with loop material bonded on both sides. One side attaches to a 3M™ Hookit™ Backup Pad and the other side attaches to a 3M™ Stikit™ Disc.

Product Name	UPC	Part No.	Diameter	Thickness	Foam Color	Face Color	Density Rating	Max OPM	Max RPM	MOQ	
3M™ Stikit™ Soft Interface Disc Pad		051111-56459-2	02795	5"	1/2"	Black	White	Soft	12,000	12,000	25

3M™ Stikit™ Dispensers

Sturdy metal dispensers for quick and easy dispensing and storage of 3M™ Stikit™ Disc and Sheet Rolls. Keeps abrasives flat while protecting the adhesive backing.

Product Name	UPC	Part No.	Description	MOQ	
3M™ Stikit™ Disc Roll Dispenser 		051144-05450-3	05450	<ul style="list-style-type: none"> • For dispensing 5" or 6" 3M™ Stikit™ Disc Rolls • Portable or can be wall or bench mounted • Holds two rolls 	1
3M™ Stikit™ Double Roll Dispenser 		051144-05452-7	05452	<ul style="list-style-type: none"> • For dispensing 2-3/4" 3M™ Stikit™ Sheet Rolls • Portable • Holds two rolls 	1

3M™ PSA Disc Holders

PSA Disc Holders can be used with sanders that have a 1/4-inch collet chuck. Provides excellent support when grinding hard-to-reach areas. Holder face diameter is smaller than disc size to allow for easier disc centering and removal.

Product Name		UPC	Part No.	Diameter	Shank	Color	Face Color	Density Rating	Max RPM	MOQ
3M™ PSA Disc Holder		051144-45074-9	45074	1/2"	1/4"	Black	Black	Medium	20,000	1
		051144-45073-2	45073	3/4"	1/4"	Black	Black	Medium	20,000	1
		051144-45072-5	45072	1"	1/4"	Black	Black	Medium	20,000	1
		051144-45071-8	45071	1-1/2"	1/4"	Black	Black	Medium	20,000	1
		051144-45070-1	45070	2"	1/4"	Black	Black	Medium	15,000	1
		051144-05510-4	05510	3"	1/4"	Black	Black	Medium	20,000	10
		051144-45069-5	45069	4"	1/4"	Black	Black	Medium	7,500	1
		051144-45068-8	45068	5"	1/4"	Black	Black	Medium	6,000	1

3M™ Roloc™ Attachment Systems

Rubber disc pads are available in different diameters and types of hardness for various grinding applications.



3M™ Roloc™ TR Disc Pad

- Easily mounts directly to tools with a 1/4–20 EXT thread shaft or use with a 3M™ Roloc™ Shank to fit collet chuck tools
- Other specific thread sizes available



3M™ Roloc™ TP Disc Pad

- Disc pad for use with 3M™ Roloc™ TP Discs or with other “press on” type abrasive discs.
- Easily mounts directly to tools with a 1/4–20 EXT thread shaft or use with a 3M™ Roloc™ Shank to fit collet chuck tools



3M™ Roloc™ TS or TSM Disc Pad

- Disc pad for use with 3M™ Roloc™ TSM discs or with other “screw on” type Standard Abrasive™ abrasive discs
- Easily mounts directly to tools with a 1/4–20 EXT thread shaft or use with a 3M™ Roloc™ Shank to fit collet chuck tools

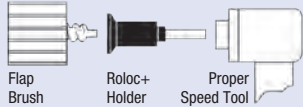

3M™ Roloc™ + Holders

- Use with 3M™ Roloc™ + products and other Scotch-Brite™ bench area Roloc™ + products or with right angle disc sanders or straight shaft die grinders

IMPORTANT INFORMATION:

Use 3M™ Roloc™ TR Discs with 3M™ Roloc™ Disc Pads for safe, secure performance. Non-3M disc pads may have a deeper threaded cavity which causes the button to continue to tighten down during use. This can cause the button to separate from the disc resulting in the disc flying off and potential operator harm.





3M™ Roloc™ Disc Pad





Non-3M Disc Pad

3M™ Roloc™ Shanks

These shanks allow 3M™ Roloc™ TR Disc Pads to fit collet chucks or drill chucks. The 1/4–20 external thread fits 3M™ Roloc™ Disc Pads with 1/4–20 internal threads.

Product Name		UPC	Part No.	Shank Size	Thread Size	MOQ
3M™ Roloc™ Shank		051144-82455-7	82455	6mm	1/4–20 EXT	5
		051144-45102-9	45102	1/4"	1/4–20 EXT	5

3M™ Roloc™ Disc Pad TR Assemblies

Product Name	UPC	Part No.	Description	Diameter	Thread Size	Color	Density Rating	Max RPM	MOQ
   	051131-05538-4	05538	• Includes a 3M™ Roloc™ shank and adapter	1"	1/4–20 INT	Black	Medium	30,000	1
	051144-05539-5	05539	• Includes a 3M™ Roloc™ shank and adapter	2"	1/4–20 INT	Black	Hard	25,000	1
 	051131-07715-7	07715	• 3M™ Roloc™ gasket removal disc pad holder	2"	1/4–20 INT	Black	Hard	25,000	1
   	051144-05540-1	05540	• Includes a 3M™ Roloc™ shank and adapter	3"	1/4–20 INT	Black	Hard	20,000	1
	051131-05541-4	05541	• Includes a 3M™ Roloc™ shank and adapter	4"	1/4–20 INT	Black	Medium	12,000	1

3M™ Roloc™ Disc Pads TR

Rubber backup pad supports 3M™ Roloc™ Discs in different degrees of hardness for varying grinding applications. Conveniently mounts directly to tools with threaded shafts or used with 3M™ Roloc™ Shank to fit collet chuck tools.

Product Name	UPC	Part No.	Diameter	Thread Size	Color	Density Rating	Max RPM	MOQ
        	051144-45101-2	45101	1"	1/4–20 INT	Black	Medium	30,000	5
	051144-45100-5	45100	1-1/2"	1/4–20 INT	Black	Hard	30,000	5
	051144-45099-2	45099	1-1/2"	1/4–20 INT	Black	Medium	30,000	5
	051144-45098-5	45098	1-1/2"	1/4–20 INT	Black	Soft	30,000	5
	051144-45097-8	45097	2"	1/4–20 INT	Black	Extra Hard	25,000	5
	051144-45096-1	45096	2"	1/4–20 INT	Black	Hard	25,000	5
	051111-51155-8	51155	2"	1/4–20 INT	Black	Hard	25,000	50
	051144-45095-4	45095	2"	1/4–20 INT	Black	Medium	25,000	5







3M™ Roloc™ Disc Pads TR (cont.)

Rubber backup pad supports 3M™ Roloc™ Discs in different degrees of hardness for varying grinding applications. Conveniently mounts directly to tools with threaded shafts or used with 3M™ Roloc™ Shank to fit collet chuck tools.

Product Name	UPC	Part No.	Diameter	Thread Size	Color	Density Rating	Max RPM	MOQ	
3M™ Roloc™ Disc Pad TR		051144-45094-7	45094	2"	1/4-20 INT	Black	Soft	20,000	5
		051144-45093-0	45093	3"	1/4-20 INT	Black	Extra Hard	20,000	5
		051144-45091-6	45091	3"	1/4-20 INT	Black	Hard	20,000	5
		051144-88748-4	88748	3"	3/8-24 INT	Black	Hard	20,000	5
		051144-45092-3	45092	3"	1/4-20 INT	Black	Medium	18,000	5
		051144-45090-9	45090	3"	1/4-20 INT	Black	Soft	15,000	5
		051111-55765-5	82879	3"	5/8-11 INT	Black	Soft	15,000	5
		051144-84993-2	84993	75mm	M14-2.0 INT	Black	Extra Hard	20,000	5
		051144-84998-7	84998	75mm	M14-2.0 INT	Black	Hard	20,000	240
		051144-85000-6	85000	75mm	M10-1.5 INT	Black	Hard	20,000	5
		051144-84999-4	84999	75mm	M14-2.0 INT	Black	Medium	18,000	240
		051144-85001-3	85001	75mm	M10-1.5 INT	Black	Medium	18,000	5
		051144-84994-9	84994	75mm	M14-2.0 INT	Black	Soft	15,000	250
		051144-45179-1	45179	4"	1/4-20 INT	Black	Medium	12,000	5
		051144-83980-3	83980	4"	5/8-11 INT	Black	Extra Hard	12,000	5
		051144-83242-2	83242	4"	5/8-11 INT	Black	Medium	12,000	5

3M™ Roloc™ Disc Pads TR (cont.)

Rubber backup pad supports 3M™ Roloc™ Discs in different degrees of hardness for varying grinding applications. Conveniently mounts directly to tools with threaded shafts or used with 3M™ Roloc™ Shank to fit collet chuck tools.

Product Name		UPC	Part No.	Diameter	Thread Size	Color	Density Rating	Max RPM	MOQ
3M™ Roloc™ Disc Pad TR		051144-83489-1	83489	4"	5/8-11 INT	Black	Hard	12,000	5
		051141-28714-0	28714	4"	5/8-11 INT	Black	Extra Hard	12,000	5
		051141-28713-3	28713	4"	5/8-11 INT	Black	Hard	12,000	5
		051141-28712-6	28712	4"	5/8-11 INT	Black	Medium	12,000	5
		051141-28474-3	28474	4"	3/8-24 INT	Black	Hard	12,000	5
		051141-28475-0	28475	4"	3/8-24 INT	Black	Extra Hard	12,000	5







3M™ Roloc™ Disc Pads TP

Backup pad designed to support 3M™ Roloc™ Discs. Pads have a 1/4-20 INT thread which allows it to be mounted directly to tools with 1/4-20 EXT threaded shafts or use with 3M™ Roloc™ Shank to fit collet chuck tools.

Product Name		UPC	Part No.	Diameter	Thread Size	Color	Density Rating	Max RPM	MOQ
3M™ Roloc™ Disc Pad TP		051144-77723-5	77723	1"	1/4-20 INT	Black	Medium	30,000	5
		051144-77726-6	77726	1-1/2"	1/4-20 INT	Black	Medium	30,000	5
		051144-14197-5	14197	2"	1/4-20 INT	Black	Medium	25,000	5
		051144-14198-2	14198	2"	1/4-20 INT	Black	Hard	25,000	5
		051144-14202-6	14202	3"	1/4-20 INT	Black	Hard	20,000	5
		051144-14201-9	14201	3"	1/4-20 INT	Black	Medium	18,000	5





3M™ Roloc™ Disc Pads TS/TSM

Backup pad designed to support 3M™ Roloc™ Discs. Pad has a 1/4–20 INT thread which allows it to be mounted directly to tools with 1/4–20 EXT threaded shafts or use with 3M™ Roloc™ Shank to fit collet chuck tools.

Product Name	UPC	Part No.	Diameter	Thread Size	Color	Density Rating	Max RPM	MOQ
	051144-77724-2	77724	1"	1/4–20 INT	Black	Medium	30,000	5
	051144-77728-0	77728	1-1/2"	1/4–20 INT	Black	Hard	30,000	5
	051144-77729-7	77729	1-1/2"	1/4–20 INT	Black	Medium	30,000	5
	051144-14211-8	14211	2"	1/4–20 INT	Black	Medium	25,000	5
	051144-14212-5	14212	2"	1/4–20 INT	Black	Hard	25,000	5
	051144-77733-4	77733	2"	1/4–20 INT	Black	Extra Hard	25,000	5
	051144-14215-6	14215	3"	1/4–20 INT	Black	Medium	18,000	5
	051144-14216-3	14216	3"	1/4–20 INT	Black	Hard	20,000	5
	051144-77737-2	77737	3"	1/4–20 INT	Black	Extra Hard	18,000	5
	051144-77740-2	77740	4"	1/4–20 INT	Black	Medium	12,000	5
	051144-28576-4	28576	4"	3/8–24 INT	Black	Hard	12,000	5
	051144-28577-1	28577	4"	3/8–24 INT	Black	Extra Hard	12,000	5
	051144-28578-8	28578	4"	5/8–11 INT	Black	Hard	12,000	5
	051144-28579-5	28579	4"	5/8–11 INT	Black	Extra Hard	12,000	5

3M™ Roloc™ Disc Pads TS/TSM (cont.)

Backup pad designed to support 3M™ Roloc™ Discs. Pad has a 1/4–20 INT thread which allows it to be mounted directly to tools with 1/4–20 EXT threaded shafts or use with 3M™ Roloc™ Shank to fit collet chuck tools.

Product Name	UPC	Part No.	Diameter	Thread Size	Color	Density Rating	Max RPM	MOQ	
3M™ Roloc™ Disc Pad TS/TSM		051141-28753-9	28753	4"	M14–2.0 INT	Black	Medium	12,000	100
		051141-28752-2	28752	4"	M14–2.0 INT	Black	Hard	12,000	100
		051141-28742-3	28742	4"	M10–1.5 INT	Black	Extra Hard	12,000	5
		051141-28751-5	28751	4"	M14–2.0 INT	Black	Extra Hard	12,000	100

3M™ Roloc™ Cool Running Disc Pads

For use with tools with vacuum shrouds. (Dust shrouds ordered as KUT accessory item). Use with threaded shank or adapter supplied with vacuum shroud kits. Holes and channels in the pad allow air to flow through the pad which reduces the heat concentration.

Product Name	UPC	Part No.	Diameter	Thread Size	# of Holes	Color	Face Color	Density Rating	Max RPM	MOQ	
3M™ Roloc™ D/F Disc Pad		051144-82974-3	82974	2"	1/4–20 INT	6	Black	Black	Medium	20,000	5
		051144-82975-0	82975	3"	1/4–20 INT	6	Black	Black	Medium	12,000	5
		051111-56479-0	02286	4"	3/8–24 INT	8	Black	Black	Hard	15,000	5
3M™ Roloc™ D/F Cool Running Disc Pad TR		051141-28473-6	28473	4"	5/8–11 INT	8	Black	Black	Hard	15,000	5
3M™ Roloc™ Cool Running Disc Pad TS and TSM		051141-28710-2	28710	3"	1/4–20 INT	6	Black	Black	Hard	12,000	5
		051141-28711-9	28711	2"	1/4–20 INT	6	Black	Black	Hard	20,000	5
3M™ Roloc™ D/F Cool Running Disc Pad TSM		051141-28580-1	28580	4"	3/8–24 INT	8	Black	Black	Hard	15,000	5
		051141-28581-8	28581	4"	5/8–11 INT	8	Black	Black	Hard	15,000	5



3M™ Break Hub Cleaning

Product Name	UPC	Part No.	Diameter	Shank Size	Color	Max RPM	MOQ
3M™ Brake Hub Cleaning Disc Holder	051131-07545-0	07545	—	1/4"	Black	20,000	6
Scotch-Brite™ Roloc™ Brake Hub Cleaning Disc Kit	051131-07547-4	07547	1-1/2"	1/4"	Purple	20,000	5

3M™ Roloc™ + Buttons and Holders

Designed with extended shank which provides added bending strength for applications which require side loads.

Product Name	UPC	Part No.	Diameter	Thread Size	Shank Size	Color	Max RPM	MOQ	
3M™ Roloc™ + Button		048011-15059-8	6	3/8"	Roloc™+	—	Blue	25,000	5
		048011-15060-4	7	3/8"	Roloc™+	—	Red	25,000	5
3M™ Roloc™ + Button Combination Pack		048011-14915-8	1 and 7	1"	Roloc™+	1/4"	Black/Red	25,000	5
3M™ Roloc™ + Holder		051131-07500-9	07500	1"	Roloc™+	1/4"	Black	25,000	1
		048011-15408-4	1	1"	Roloc™+	1/4"	Black	25,000	5
		048011-33734-0	2	1-1/2"	Roloc™+	1/4"	Black	25,000	5
		048011-33732-6	3	2"	Roloc™+	1/4"	Black	25,000	5
		048011-33733-3	4	3"	Roloc™+	1/4"	Black	25,000	5

Dressing and Shaping Tape

Conformable shaping tape used to final dress wheels and finely shape contours into wheels.

Product Name	UPC	Part No.	Grade	Size	MOQ
3M™ Wheel Dressing and Shaping Tape	048011-30201-0	30201	80	2" x 50 yds.	1

3M™ Finesse-it™ System

Specially designed polishes for use on automotive OEM clear coats to remove sand scratches or to remove swirl marks from previous steps. For industrial use only.



Finish Comparison











Cut Comparison



3M™ Finesse-it™ Compounds and Polishes

Specially designed compounds and polishes to be used on OEM and baked refinish paints to remove sand scratches or to remove swirl marks from previously compounded areas.

Product Name	UPC	Part No.	Description	Size	Color	MOQ	
3M™ Finesse-it™ Compounding Material		051144-77340-4	77340	Compounding Material	Gallon	Ivory	4
3M™ Finesse-it™ Final Finish		051144-82877-7	82877	Final Finish	Liter	Gray	12
		051144-82878-4	82878	Final Finish	Gallon	Gray	4
3M™ Finesse-it™ Final Finish Easy Clean Up		051144-88753-8	88753	Final Finish	50 Gallon	Gray	1
3M™ Finesse-it™ Finishing Material		051144-13084-9	13084	Finishing Material	Gallon	White	4
		051144-81235-6	81235	Finishing Material	Liter	White	12
		051144-83058-9	83058	Finishing Material	50 Gallon	White	1
3M™ Finesse-it™ Polish		051141-28695-2	28695	K211	Gallon	White	4
		051131-06002-9	06002	Extra Fine	Gallon	White	4
		051131-06075-3	06075	Extra Fine	50 Gallon	White	1



3M™ Finesse-it™ Compounds and Polishes (cont.)

Specially designed compounds and polishes to be used on OEM and baked refinish paints to remove sand scratches or to remove swirl marks from previously compounded areas.

Product Name	UPC	Part No.	Description	Size	Color	MOQ	
3M™ Finesse-it™ Polish		051111-51157-2	51056	Purple	Gallon	Purple	4
		051111-61104-3	61104	Purple	50 Gallon	Purple	1
		051141-20272-3	20272	Non-pigmented Purple Polish	55 Gallon	White	4
		051141-28696-9	28696	Ultra Fine	Liter	White	12
3M™ Glass Polishing Compound		051111-61009-1	60150	Glass Polishing Compound	Liter	White	6















3M™ Finesse-it™ Disc Pads

Disc pads used to drive 3M™ Finesse-it™ Discs.

Product Name	UPC	Part No.	Desc.	Diameter	Thick-ness	Color	Face Color	Density Rating	Hook Type	Max OPM	Max RPM	MOQ	
3M™ Finesse-it™ PSA Hard Pad		051141-20207-5	3125H	PSA	1-1/4"	1/8"	Black	Blue	Hard	—	7,500	7,500	10
3M™ Finesse-it™ PSA Soft Pad		051111-60537-0	3125P	PSA	1-1/4"	1/8"	Black	Blue	Soft	—	10,000	7,500	20
3M™ Finesse-it™ Hookit™ Disc Pad		051144-14738-0	14738	Hookit	5" x 5/8-11 INT	1"	Orange	Yellow	Soft	1	—	7,000	1

3M™ Finesse-it™ Buffing Pads

3M™ Finesse-it™ Buffing Pads provide a soft, smooth surface for applying 3M™ Finesse-it™ Polishes. 3M™ Hookit™ Attachment System.

Product Name		UPC	Part No.	Desc.	Diameter	Color	Max OPM	Max RPM	MOQ
3M™ Finesse-it™ Buffing Pad		134375-38287-8	09357	Felt	3"	Red/White	12,000	12,000	50
		134375-38286-1	09358	Felt	5"	Red/White	12,000	12,000	50
		051141-20274-7	20274	Foam	1-1/2"	Orange	12,000	12,000	20
		051111-60799-2	01963	Foam	3"	White Foam/ Black Loop	12,000	12,000	10
		051111-51151-0	02648	Foam	3-1/4"	Orange Foam/ White Loop	12,000	12,000	10
		051111-60527-1	02648B	Foam	3-1/4"	Orange Foam/ Black Loop	12,000	12,000	10
		051141-25134-9	25134	Foam	3-1/4"	Gray Foam/ White Loop	12,000	12,000	50
		051141-20271-6	20271	Open Cell Foam	3-3/4"	White Foam/ White Loop	12,000	12,000	10
		051111-51158-9	02637	Foam	3-3/4"	Orange Foam/ White Loop	12,000	12,000	50
		051141-25135-6	25135	Foam	3-3/4"	Gray Foam/ White Loop	12,000	12,000	50
		051135-92500-3	01912	Foam	5-1/4"	White Foam/ Black Loop	12,000	12,000	10
		051111-51076-6	02362	Foam	5-1/4"	Orange Foam/ White Loop	12,000	12,000	10
		051111-60528-8	02362B	Foam	5-1/4"	Orange Foam/ Black Loop	12,000	12,000	10
		051141-28401-9	28401	Open Cell Foam	5-1/4"	White Foam	12,000	12,000	900
		051141-28574-0	28574	Foam	5-1/4"	Gray Foam	12,000	12,000	1,500

3M™ Finesse-it™ Buffing Pads (cont.)

3M™ Finesse-it™ Buffing Pads provide a soft, smooth surface for applying 3M™ Finesse-it™ Polishes. 3M™ Hookit™ Attachment System.

Product Name		UPC	Part No.	Desc.	Diameter	Pile Height	Color	MOQ
3M™ Finesse-it™ Knit Buffing Pad		051144-85078-5	85078	Knit	3"	15/16"	White	10
		051144-85079-2	85079	Knit	5-1/4"	15/16"	White	10
3M™ Finesse-it™ Knit II Buffing Pad		051144-85084-6	85084	Knit II	3"	15/16"	White	10
		051144-85099-0	85099	Knit II	3"	11/16"	White	10
		051144-85083-9	85083	Knit II	5-1/4"	15/16"	White	10
3M™ Finesse-it™ Natural Buffing Pad		051111-50193-1	5730	Natural	3"	1/4"	White	10
		051144-81470-1	81470	Natural	3"	20mm	White	10
		051144-85103-4	85103	Natural	3"	20mm	Black	10
		051144-81471-8	81471	Natural	5-1/4"	20mm	White	10
		051144-85100-3	85100	Natural	5-1/4"	20mm	Black	10
		051141-28410-1	28410	Knit II	5-1/4"	11/16"	White	50
		051144-82531-8	82531	Natural	7"	20mm	White	10

3M™ Perfect-it™ II Wool Compounding Pad

Made of fine wool fibers stitched into a polyester backing with a 11/16" trim length. Pad is pre-washed to reduce lint. Designed with a 3M™ Hookit™ Attachment System for use with 3M™ Finesse-it™ Polishes.

Product Name		UPC	Part No.	Diameter	Color	MOQ
3M™ Perfect-it™ II Wool Compounding Pad		051111-51043-8	01927	5-1/4"	White	2



3M™ Buffing and Polishing Accessories

Product Name	UPC	Part No.	Size	Thread Size	Density Rating	Max RPM (OPM)	MOQ
3M™ Buff Pad Adaptor  	051144-05710-8	05710	1" Hex.	5/8-11	—	—	10
3M™ Hookit™ Backup Pad  	051131-05717-3	05717	7"	5/8-11	Soft	3,000	1
3M™ Perfect-It™ Backup Pad  	051131-05718-0	05718	7"	5/8-11	Soft	3,000	1
3M™ Foam Compounding Pad  	051131-05723-4	05723	8"	—	—	2,000 (2,000)	1
3M™ Perfect-It™ Foam Buffing Pad  	051131-05759-3	05759	3"	—	—	11,000	6
3M™ Perfect-It™ Ultrafine Foam Polishing Pad  	051131-05760-9	05760	3"	—	—	11,000	6
3M™ Perfect-It™ DA Glazing Pad  	051131-05729-6	05729	6-3/4"	—	—	2,000	12
3M™ Foam Polishing Pad  	051131-05725-8	05725	8"	—	—	2,000 (2,000)	1
3M™ Ultrafine Foam Polishing Pad  	051131-05751-7	05751	8"	—	—	2,000 (2,000)	1
3M™ Detailing Squeeze Bottle  	051131-37720-2	37720	12 fl oz	—	—	—	24
3M™ Detailing Spray Bottle  	051131-37716-5	37716	32 fl oz	—	—	—	24



Scotch-Brite™ High Performance Cloth

Ribbon-shaped fibers lift dirt and grease instead of rolling over it. Dirt and particles are trapped within knitted tufts of the fibers. Rows and rows of tufts and valleys trap large and small particles.

Product Name	UPC	Part No.	Size	Color	Material	MOQ
Scotch-Brite™ High Performance Cloth 	048011-26224-1	02021	17" x 19-1/2"	White	Polyester/Nylon	1 case









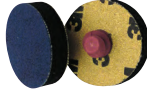

3M™ Finesse-it™ Hand Sanding Pads

Hand pads used to support 3M™ Finesse-it™ Discs.

Product Name	UPC	Part No.	Desc.	Diameter	Color	Face Color	Density Rating	MOQ	
3M™ Finesse-it™ Hand Sanding Pad		051144-13441-0	13441	—	1-1/4"	Red	Red	Firm	20
		051111-50199-3	50199	—	1-1/4"	Red	Black	Soft	20
		051135-92499-0	70437	Contoured	1-1/4"	Red	Black	Soft	20

3M™ Finesse-it™ Roloc™ Backup Pads

Soft foam pads for application of polishes and glazes to remove haze and swirls. Use with 3M™ Hookit™ Discs Pads. 3M™ Hookit™ Attachment System.

Product Name	UPC	Part No.	Diameter	Thick-ness	Thread Size	Density Rating	Hook Type/ Face	Max RPM (OPM)	MOQ	
3M™ Finesse-it™ Roloc™ Finishing Disc Pad		051144-14736-6	14736U	3"	1"	Roloc™ TR	Soft	3	6,000 (10,000)	12
		051111-51168-8	14736V	3"	1"	Roloc™ TR	Soft	1	6,000 (10,000)	12
3M™ Finesse-it™ Roloc™ Sanding Pad		051111-51150-3	02511	1-1/4"	5/16"	Roloc™ TR	Firm	Blue Vinyl	10,000 (12,000)	10
		051144-13442-7	13442	1-1/4"	5/16"	Roloc™ TR	Medium	Black Rubber	6,000 (10,000)	10
		051144-82271-3	82271	1-1/4"	5/16"	Roloc™ TR	Soft	Black Rubber	6,000 (10,000)	10
3M™ Stikit™ Roloc™ Disc Pad		051111-55833-1	02727	1-1/4"	5/16"	Roloc™ TR	Medium	Black Vinyl	10,000 (12,000)	10
3M™ Finesse-it™ Roloc™ Sanding Pad		051111-50198-6	02345	1-1/4"	5/16"	Roloc™ TR	Medium	Blue Vinyl	10,000 (12,000)	10
		051141-28584-9	28584	1-1/4"	5/16"	Roloc™ TR	Medium	Blue Vinyl	10,000 (12,000)	200
		051141-28738-6	28738	3/4"	5/16"	Roloc™ TR	Medium	Blue Vinyl	12,000 (12,000)	10
		051141-28768-3	28768	7/8"	5/16"	Roloc™ TR	Medium	Blue Vinyl	12,000 (12,000)	10

3M™ Hookit™ Polishing Pads

Soft foam pads for application of polishes and glazes to remove haze and swirls. Use with 3M™ Hookit™ Discs Pads. 3M™ Hookit™ Attachment System.

Product Name	UPC	Part No.	Desc.	Diameter	Thickness	Color	Density Rating	MOQ
3M™ Finesse-it™ Hookit™ Type L Polishing Pad	051144-76848-6	76848	Flat	5"	1/2"	White	Soft	100
3M™ Perfect-it™ Hookit™ Foam Polishing Pad	051131-05726-5	05726	Waffle Face	3"	1"	Black	Soft	10
	051131-05727-2	05727	Waffle Face	5-1/4"	1"	Black	Soft	12



3M™ Marine Products

Product Name	UPC	Part No.	Description	Size	MOQ
3M™ Marine Aluminum Restorer and Polish 	051131-09020-0	09020	Pink Paste	18 oz	6
3M™ Marine Black Streak Remover 	051131-09047-7	09047	—	500mL	6
3M™ Marine Boat Soap 	051131-09034-7	09034	Clear	16 oz	6
3M™ Marine Clean & Shine Wax, Clear 	051131-09033-0	09033	—	16.9 oz	6
3M™ Marine Cleaner and Wax 	051131-09009-5	09009	Beige	16 oz	6
	051131-09010-1	09010	Beige	32 oz	6
	051131-09011-8	09011	Beige	Gallon	2
3M™ Marine Color/Gloss Restorer 	051131-09089-7	09089	—	500mL	6



3M™ Marine Products (cont.)

Product Name	UPC	Part No.	Description	Size	MOQ
  3M™ Marine Finesse-it™ II Finishing Material	051131-35929-1	35929	White	Gallon	4
  3M™ Marine Finesse-it™ II Glaze	051131-09048-4	09048	White	1 US Pint	6
  3M™ Marine Finesse-it™ II Glaze	051131-35928-4	35928	White	Quart	6
  3M™ Marine Metal Restorer and Polish	051131-09019-4	09019	Pink Paste	18 oz	6
  3M™ Marine Mildew Block	051131-09065-1	09065	White	16.9 fl oz	6
  3M™ Marine Mildew Stain Remover	051131-09067-5	09067	—	16.9 fl oz	6
  3M™ Marine Non-Skid Cleaner	051131-09063-7	09063	Yellow/Brown	Liter	6
  3M™ Marine Restorer and Wax	051131-09005-7	09005	Tan	16 fl oz	6
  3M™ Marine Restorer and Wax	051131-09006-4	09006	Tan	32 oz	6
  3M™ Marine Restorer and Wax	051131-09007-1	09007	Tan	Gallon	2
  3M™ Marine Restorer and Wax	051131-16896-1	16896	Paste	18 oz	6





3M™ Marine Products (cont.)

Product Name	UPC	Part No.	Description	Size	MOQ	
  3M™ Marine Rubbing Compound	051131-09004-0	09004	Tan	16 oz	6	
  3M™ Marine Vinyl Cleaner and Restorer 09029	051131-16904-3	16904	—	15 fl oz	6	
  3M™ Marine Vinyl Cleaner, Conditioner, Protector	051131-09023-1	09023	White	8 oz	6	
  Scotchgard™ Marine Liquid Wax	051131-09061-3	09061	—	500mL	6	
	  	051131-09062-0	09062	—	Liter	6
  3M™ Marine Ultra Performance Paste Wax	051131-09030-9	09030	Light Yellow	9.5 oz	6	
  3M™ Finesse-it™ Marine Paste Compound	051131-06039-5	06039	White	Gallon	4	
  3M™ Marine Compound and Finishing Material	051131-06044-9	06044	—	32 fl oz	12	
	  	051131-06045-6	06045	—	Gallon	4
	  	051131-06046-3	06046	—	5 Gallon Pail	1
  Photo Not Available	051131-36044-0	36044	Original Imperial Compounding and Finishing Material	32 fl oz	12	
	  Photo Not Available	051131-36045-7	36045	Original Imperial Compounding and Finishing Material	Gallon	4





3M™ Marine Products (cont.)

Product Name	UPC	Part No.	Description	Size	MOQ
 3M™ Marine High Gloss Gelcoat Compound	051131-06025-8	06025	White	Gallon	4
 3M™ Marine High Gloss Gelcoat Compound	051131-06026-5	06026	White	50 lb Pail	1
 3M™ Premium Mold and Tooling Compound	051131-06027-2	06027	White	Gallon	4

3M™ Flange Adapters

Flanges are metal products used to reduce an internal diameter core size to a smaller size.

Product Name	UPC	Part No.	Description	Diameter	Inside Diameter	Width	MOQ
3M™ Flange Adapter 3	 051144-45035-0	3	<ul style="list-style-type: none"> Reduce 1" ID core size, flange size or wheel size to fit shafts smaller than 1" diameter Stamped and formed sheet metal product Fits 5"–8" diameter flap wheels 	1"	1/2"	—	1
	 051144-45033-6	3	<ul style="list-style-type: none"> Reduce 1" ID core size, flange size or wheel size to fit shafts smaller than 1" diameter Stamped and formed sheet metal product Fits 5"–8" diameter flap wheels 	1"	3/4"	—	1
	 051144-45034-3	3	<ul style="list-style-type: none"> Reduce 1" ID core size, flange size or wheel size to fit shafts smaller than 1" diameter Stamped and formed sheet metal product Fits 5"–8" diameter flap wheels 	1"	5/8"	—	1
	 051144-45032-9	3	<ul style="list-style-type: none"> Reduce 1" ID core size, flange size or wheel size to fit shafts smaller than 1" diameter Stamped and formed sheet metal product Fits 5"–8" diameter flap wheels 	1"	7/8"	—	1
3M™ Flange Adapter 5	 048011-16860-9	5	<ul style="list-style-type: none"> Telescoping wheel adapter 1" wide Reduce 1" wheel to fit 1/2", 5/8", 3/4" or 7/8" shafts Use with a set of flat or cupped washers 1/3 the diameter of the wheel for side support 	1"	1/2"	1"	1
	 048011-33966-5	5	<ul style="list-style-type: none"> Telescoping wheel adapter 1" wide Reduce 1" wheel to fit 1/2", 5/8", 3/4" or 7/8" shafts Use with a set of flat or cupped washers 1/3 the diameter of the wheel for side support 	1"	1/2"	1"	50
	 048011-16859-3	5	<ul style="list-style-type: none"> Telescoping wheel adapter 1/2" wide Reduce 1" wheel to fit 1/2", 5/8", 3/4" or 7/8" shafts Use with a set of flat or cupped washers 1/3 the diameter of the wheel for side support 	1"	1/2"	1/2"	1

3M™ RX Hub End Flange

End flanges used to securely hold RX segments in an RX hub.



Product Name	UPC	Part No.	Diameter	Center Hole	MOQ
 3M™ RX Hub End Flange	051141-25132-5	25132	4"	1-1/4"	1



3M™ RX Hub and Heavy Duty Roto Peen Hub Assembly

Hub measures 4" diameter with a 2-1/8" ID and is furnished with flanges. The 4" Diameter Hub has 20 slots.

When ordering specify Hub Diameter x Hub Width x Flange Arbor Hole (D x W x AH).

Product Name	UPC	Part No.	Diameter	Width	Center Hole	MOQ
 3M™ Coated Abrasives, Kut Accessories, RX Hub	051135-92689-5	Determined by width*	4"	Per order	Per order	1
 3M™ Heavy Duty Roto Peen, Hub Assembly	048011-91136-6	91136	4"	Per order	Per order	1

*Make-to-order

3M™ Flap Disc Adapter Nut

Adapter nut to be used with 3M™ Abrasive Flap Discs.

Product Name	UPC	Part No.	Thread Size	MOQ	
3M™ Flap Disc Adapter Nut		051144-88765-1	88765	5/8–11 INT	1



3M™ Flap Disc Holder

Holder for 7-inch diameter 3M™ Abrasive Flap Discs and 6-inch diameter 3M™ Clean and Strip Cup Wheel.

Product Name	UPC	Part No.	Diameter	Thread Size	MOQ	
3M™ Flap Disc Holder T27		051144-88769-9	88769	4"	5/8–11 INT	1

3M™ Flexible Grinding Wheel Backup Pads

Clear plastic support plate used to support flexible grinding wheel.

Product Name	UPC	Part No.	Diameter	Center Hole	Color	MOQ	
3M™ Flexible Grinding Wheel Backup Pad		051111-51045-2	51045	4-5/8"	7/8"	Clear	5
		051111-51046-9	51046	3-3/8"	7/8"	Clear	5

3M™ Center Water Feed Disc Hand Pads

Pads supply water to the job and dispense the proper amount of water for wet sanding of plastics, primer surface, paint, fiberglass, etc. The water flushes the sanding residue off the sanding disc which keeps the disc from loading.

Product Name	UPC	Part No.	Desc.	Shape	Diameter	Center Hole	Color	Face Color	Density Rating	Hook Type	MOQ	
3M™ Center Water Feed Disc Hand Pad Replacement Sponge	051144-82191-4	82191	Sponge	—	7/8"	—	Yellow	—	—	—	10	
3M™ Hookit™ Center Water Feed Disc Hand Pad		051111-56445-5	70147	Hookit	Contoured	3"	7/8"	Yellow	Yellow	Firm	1	10
		051144-82457-1	82457	Hookit	Bullet	3"	7/8"	Yellow	Yellow	Firm	1	10
		051144-88741-5	88741	Hookit	Bullet	2"	7/8"	Yellow	Yellow	Firm	1	10
3M™ Stikit™ Center Water Feed Disc Hand Pad		051144-77749-5	77749	Stikit	Bullet	3"	7/8"	Orange	Blue	Soft	—	10
		051144-82705-3	82705	Stikit	Bullet	3"	7/8"	Yellow	Blue	Firm	—	10
		051111-56453-0	01904	Stikit	Contoured	3"	7/8"	Yellow	Blue	Firm	—	240





3M™ Wetordry™ Bucket

Product Name	UPC	Part No.	Color	MOQ
3M™ Wetordry™ Bucket 	051131-02513-4	02513	Red	10

3M™ Rubber Sanding Blocks

Rectangular sanding blocks for holding abrasive sheets.

Product Name	UPC	Part No.	Size	Color	MOQ
3M™ Rubber Sanding Block 	051144-05519-7	05519	2-3/4" x 5"	Black	1
3M™ Rubber Sanding Block 	051131-05520-9	05520	3" x 8"	Black	1







Pad Holders

Holders used to drive nonwoven surface conditioning products.

Product Name	UPC	Part No.	Description	Size	Color	Face Color	Material	Hook Type	MOQ
3M™ Doodlebug™ Pad Holder	 048011-12929-7	250	Doodlebug	4" x 9-1/4"	Light Gray	Light Gray	Polypropylene	7	5
	 048011-33608-4	250HD	Doodlebug	3-3/4" x 9"	Light Gray	White/Light Gray	Polypropylene	4	5
3M™ Hook-and-Loop Pad Holder	 051141-28384-5	250BP	Doodlebug	3-3/4" x 9"	Light Gray	White	Polypropylene	4	10
3M™ Twist-Lok™ Pad Holder	 048011-09493-4	961	Hand Block	3-1/2" x 4-3/4" (Height: 2-1/2")	Light Gray	Gray	Plastic	7	1
Scotch-Brite™ Conformable Applicator Cleaner Head	 048011-05717-0	261	Conformable	6" x 12"	Dark Gray	Black	Nylon	2	1
3M™ Insta-Lok™ Hand Block	 048011-04013-4	952	Insta-Lok Hand Block, Firm	3-3/8" x 5-3/4"	Blue	Tan	Plastic	4	1

3M™ Hookit™ Hand Pads and Blocks

For use with 3M™ Hookit™ Sheets. Available in various densities and thicknesses for your hand sanding needs.

Product Name	UPC	Part No.	Shape	Size	Thickness	Color	Face Color	Density Rating	Hook Type	MOQ
3M™ Hookit™ Disc Hand Pad	 051111-55766-2	01908	Contoured	3" Dia	—	Yellow	Yellow	Firm	1	10
	 051144-77750-1	77750	—	5" Dia	1	Black	Black	Soft	1	10
	 051144-77752-5	77752	—	5" Dia	1/4"	Black	Black	Soft	1	20
	 051144-85095-2	85095	Contoured	5" Dia	—	Yellow	Yellow	Firm	1	10
	 051111-56493-6	88132	Half Round	5" Dia	1/4"	Black	Black	Medium	1	20
	 CFM 051131-05791-3	05791	—	6" Dia	1/4"	Black	Black	Soft	1	2
	 051141-28777-5	28777	—	8" Dia	1-1/8"	Black	Black	Medium	1	1

3M™ Hookit™ Hand Pads and Blocks (cont.)

For use with 3M™ Hookit™ Sheets. Available in various densities and thicknesses for your hand sanding needs.

Product Name	UPC	Part No.	Shape	Size	Thick-ness	Color	Face Color	Density Rating	Hook Type	MOQ
3M™ Hookit™ Half Round Pad 	051131-05792-0	05792	Half Round	6" Dia	1/4"	Black	Black	Medium	1	1
3M™ Hookit™ Hand Block 	051131-05740-1	05740	—	2-3/4" x 5"	—	Yellow	Black	Firm	1	1
	051131-05741-8	05741	—	2-3/4" x 7-3/4"	—	Yellow	Black	Firm	1	1
3M™ Hookit™ Soft Hand Block 	051131-05742-5	05742	—	2-3/4" x 5"	—	Yellow	Yellow	Soft	1	1
3M™ Hookit™ Sanding Block 	NEW! 051131-05690-9	05690	—	2-1/2" x 5-3/8"	5/8"	Yellow	Yellow	—	1	24
	NEW! 051131-05685-5	05685	—	1-3/8" x 10-3/4"	7/8"	Yellow	Yellow	—	1	24
	NEW! 051131-05686-2	05686	—	2-5/8" x 5-1/4"	1-1/2"	Yellow	Yellow	—	1	24
	NEW! 051131-05687-9	05687	—	2-5/8" x 10-3/4"	1-1/2"	Yellow	Yellow	—	1	12
	NEW! 051131-05688-6	05688	—	2-5/8" x 16"	1-1/2"	Yellow	Yellow	—	1	8
3M™ Hookit™ Sanding Block Round 	051131-05689-3	05689	Round	1-1/4" x 10-3/4"	—	Yellow	Yellow	—	1	24
3M™ Hookit™ Sanding Block Teardrop 	051131-05691-6	05691	Teardrop	2-1/8" x 10-3/4"	—	Yellow	Yellow	—	1	12
3M™ Hookit™ Sanding Stick Kit 	051131-05670-1	05670	—	—	—	Yellow	Yellow	—	1	1
3M™ Hookit™ Sanding Block Kit 	051131-05684-8	05684	—	24" x 18"	—	Yellow	Yellow	—	1	6











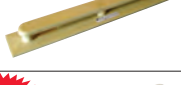

3M™ Dust Free Hand Pads and Blocks

Product Name	UPC	Part No.	Size	Color	Density Rating	Hook Type	MOQ	
3M™ Hookit™ Sanding Block Dust Free	 	051131-05207-9	05207	70mm x 127mm	Purple	Firm	1	5
	 	051131-05208-6	05208	70mm x 198mm	Purple	Firm	1	5
	 	051131-05209-3	05209	70mm x 396mm	Purple	Firm	1	1
	 	051131-05216-1	05216	115mm x 225mm	Purple	Firm	1	3
3M™ Dust Free Hose Extension Kit	 	051131-05215-4	05215	—	Black	—	—	1





3M™ Fairing and Hand File Boards

Designed for fairing, shaping, sanding and finishing boats, plugs and molds. Durable, lightweight construction that combines worker comfort and getting desired results quickly.

Product Name	UPC	Part No.	Size	Color	Face Color	Hook Type	MOQ	
3M™ Hookit™ Marine Fairing Board, Flexible	 	051144-83978-0	83978	4-1/2" x 30"	Yellow	Yellow	1	1
3M™ Imperial™ Hookit™ Marine Fairing Board, Rigid	 	051144-83497-6	83497	4-1/2" x 30"	Yellow	Yellow	1	1
3M™ Hookit™ Marine Rigid Fairing Board II	  	051131-09082-8	09082	4-1/2" x 30"	Yellow	Black	1	1
3M™ Hookit™ Hand File Board	 	051131-05744-9	05744	2-3/4" x 16"	Yellow	Black	1	1
3M™ Stikit™ Hand File Board	 	051144-05444-2	05444	2-3/4" x 16"	Yellow	Blue	—	1

Air File Shoes

For use on Pneumatic Orbital Air Files. Shoes feature a tuck-in clip on the leading edge for easy insertion and quick application and removal.

Product Name	UPC	Part No.	Description	Size	MOQ
 3M™ Hookit™ Straightline Air File Shoe	051131-05748-7	05748	<ul style="list-style-type: none"> For use with Hookit abrasives for multiple sanding applications Hookit pad face provides excellent adhesion and easy removal of the D/F abrasive sheets Hook Type 1 	2-3/4" x 16"	1
 3M™ Stikit™ Air File Shoe	051144-05448-0	05448	<ul style="list-style-type: none"> For use on all straight air files with 3M™ Stikit™ File Sheets 	2-3/4" x 16"	1
 3M™ Hookit™ Short Air File Shoe	051131-05750-0	05750	<ul style="list-style-type: none"> Aluminum Rigid 	2-3/4" x 11"	1
 3M™ Hookit™ Orbital Air File Shoe	051131-05746-3	05746	<ul style="list-style-type: none"> Aluminum Rigid 	2-3/4" x 16"	1
 3M™ Hookit™ Straightline File Shoe D/F	051131-05848-4	05848	<ul style="list-style-type: none"> Aluminum Rigid 	2-3/4" x 16"	1

3M™ Facing Material Rolls

Convert self-made fairing boards to the 3M™ Hookit™ Attachment System. Use 3M™ General Trim Adhesive for bonding 3M™ Hookit™ Facing Roll Material with high performance 3M™ Hookit™ Abrasive Sheets to wood surfaces.

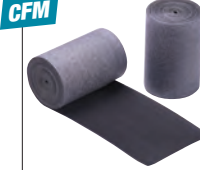
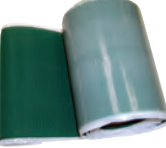
Product Name	UPC	Part No.	Size	Color	Hook Type	MOQ
 3M™ Hookit™ Facing Roll	051111-50197-9	88044	4-1/8" x 12 ft.	Black	1	1
 3M™ Green J Hook PSA Roll	051141-28441-5	28441	8" x 10 ft. (untrimmed)	Green	2	1



















3M™ Stikit™ Hand Pads and Blocks

Hand pads designed to support 3M™ Stikit™ Discs and Sheets.

Product Name	UPC	Part No.	Size	Thickness	Foam Color	Face Color	Density Rating	MOQ	
3M™ Stikit™ Disc Hand Pad		051111-56462-2	06624	5" Dia (Half Round)	3/8"	Black	Blue	Medium	20
		051144-45188-3	45188	5" Dia	1/8"	Black	Blue	Medium	20
		051144-45189-0	45189	5" Dia	1/4"	Black	Blue	Medium	20
		051144-11063-6	11063	5" Dia	1"	Black	Black	Soft	10
		051144-84229-2	84229	5" Dia	1"	Black	Blue	Soft	10
		051144-45198-2	45198	6" Dia	1/8"	Black	Blue	Medium	20
		051131-05591-9	05591	6" Dia	1/4"	Black	Blue	Medium	20
3M™ Stikit™ Hand Pad		051144-05585-2	05585	2-3/4" x 5"	3/8"	Black	Black	Medium	1
		051144-05586-9	05586	2-3/4" x 6"	3/8"	Black	Black	Medium	1
3M™ Stikit™ Hand Block		051144-05440-4	05440	2-3/4" x 5"	—	Yellow	Blue	Hard	1
		051144-05441-1	05441	2-3/4" x 7-3/4"	—	Yellow	Blue	Hard	1
3M™ Stikit™ Soft Hand Block		051144-05442-8	05442	2-3/4" x 5"	—	Yellow	Blue	Soft	1
3M™ Stikit™ Soft Hand Pad		051144-05530-2	05530	2-3/4" x 5-1/2"	3/8"	Black	Black	Soft	5
3M™ Wetordry™ Sponge Pad 20		051131-05526-1	05526	5-1/2" x 2-3/4"	3/8"	Black	Black	Soft	1
3M™ Stikit™ Sanding Block		051144-45203-3	45203	2-1/2"	—	Red	White	Firm	6
		051144-45204-0	45204	3-1/4"	—	Red	White	Firm	6





3M™ Stikit™ Hand Pads and Blocks (cont.)

Hand pads designed to support 3M™ Stikit™ Discs and Sheets.

Product Name	UPC	Part No.	Size	MOQ	
3M™ Stikit™ Sanding Block	 	051131-05693-0	05693	1-3/8" x 10-3/4"	24
	 	051131-05668-8	05668	2-1/2" x 5-3/8"	24
	 	051131-05694-7	05694	2-5/8" x 5-1/4"	24
	 	051131-05695-4	05695	2-5/8" x 10-3/4"	12
	 	051131-05696-1	05696	2-5/8" x 16"	8
3M™ Stikit™ Sanding Block Round	 	051131-05672-5	05672	1-1/4" x 10-3/4"	24
3M™ Stikit™ Sanding Block Teardrop	 	051131-05669-5	05669	2-1/8" x 10-3/4"	12
3M™ Stikit™ Sanding Stick Kit	 	051131-05671-8	05671	—	10
3M™ Stikit™ Sanding Block Kit	 	051131-05692-3	05692	—	6







3M™ Screen Cloth Hand Pads

For use with screen cloth discs with two tabs (Die #500GC, 600JR and 800JM). This two-sided durable pad allows the screen cloth disc to be held onto the pad without using adhesive.

Product Name	UPC	Part No.	Diameter	Thickness	Color	Face Color	Density Rating	MOQ	
3M™ Screen Cloth Disc Hand Pad		051111-55845-4	02712	5"	1"	Gray	Black	Medium	10
		051111-60788-6	99736	6"	1"	Black	Black	Soft	10
		051111-55846-1	02713	8"	1"	Gray	Black	Medium	10
		051144-82793-0	82793	8"	1"	Black	Black	Soft	40

3M™ Cartridge Roll Mandrels

Mandrel for use with cartridge rolls to help you get to all the hard-to-get at areas on your work pieces.

Product Name	UPC	Part No.	Pilot Diameter	Pilot Length	Shank Size	Overall Length	Max RPM	MOQ	
3M™ Cartridge Roll Mandrel		051144-45116-6	45116	1/4"	1-1/2"	1/4"	3-1/2"	24,000	25
		051144-45117-3	45117	3/16"	1"	1/4"	3"	24,000	1
		051144-45118-0	45118	3/16"	1-1/2"	1/4"	3-1/2"	24,000	1
		051144-45119-7	45119	1/8"	1"	1/4"	2-3/4"	24,000	1
		051144-88749-1	88749	1/8"	1"	6mm*	3"	24,000	100
		051144-45120-3	45120	3/32"	3/4"	1/4"	2-3/4"	24,000	25

*OUS only

3M™ Forked Spindle

Forked spindle holder for coated abrasive strips to clean and polish inner diameters and other tight areas.

Product Name	UPC	Part No.	Slot Width	Slot Length	Shank Size	Overall Length	MOQ
3M™ Forked Spindle	051144-45121-0	45121	1/16"	3/4"	1/4"	3"	1

3M™ Mandrels

Product Name	UPC	Part No.	Shank Size	Overall Length	Outside Flange Diameter	Max RPM	MOQ
3M™ Mini Mandrel	048011-04020-2	935	1/4"	2-7/8"	—	14,000	1
3M™ Wheel Mandrel	048011-07491-7	938	1/4"	2"	2"	—	1

3M™ Roloc™ Mandrel TS/TSM

Use with 3/4-inch 3M™ Roloc™ Discs. Designed for cleaning and finishing of airplane seat track channels.

Product Name	UPC	Part No.	Desc.	Thread Size	Shank Size	Overall Length	MOQ
3M™ Roloc™ Mandrel TS/TSM	051144-85097-6	85097	Track Cleaning	Roloc™ TS or TSM	1/4"	2"	5

3M™ Square/Cross Pad Mandrel

Used for tightly securing Square Pads and Cross Pads with internal threaded inserts. Mandrel has external threaded shank.

Product Name	UPC	Part No.	Thread Size	Shank Size	Overall Length	Max RPM	MOQ
3M™ Square/Cross Pad Mandrel	051141-28385-2	28385	3-48 EXT	1/4"	3"	24,100	1
	051144-14307-8	14307	8-32 EXT	1/4"	3"	24,100	1
	051144-14308-5	14308	1/4-20 EXT	1/4"	3"	24,100	1

3M™ Star Mandrel

Mandrel for a surface conditioning star converted into a unique shape for cleaning, polishing and light deburring of inside diameters of pipe and tubing. Dually threaded for either spin-on direction with portable hand tools.

Product Name	UPC	Part No.	Thread Size	Shank Size	Overall Length	Max RPM	MOQ
3M™ Star Mandrel	048011-13928-9	944	1/4-20 EXT	1/4"	3"	24,100	1

3M™ Unitized Wheel Mandrels

Recommended for use on portable tools. Excellent for edge deburring and finishing applications of small or intricate work pieces. They are available in a wide range of diameters, grades and densities and limited to a thickness no more than 1 inch.

Product Name	UPC	Part No.	Description	Shank Size	Overall Length	Outside Flange Diameter	Max RPM	MOQ	
3M™ Unitized Wheel Mandrel		048011-13966-1	931	<ul style="list-style-type: none"> Use with wheels 1" to 1-1/2" diameter x 1/4" wide x 1/8" center hole Maximum wheel width: 1/4" Note: 5/16" center hole is recommended for wheels 6 density or harder 	1/8"	1-1/2"	1/2"	13,000	5
		048011-13967-8	932	<ul style="list-style-type: none"> Use with wheels 1-1/2" to 2" diameter x 1/4" to 1/2" wide x 1/4" center hole Maximum wheel width: 1/2" Note: 5/16" center hole is recommended for wheels 6 density or harder 	1/4"	2"	3/16"	20,000	5
		048011-13968-5	933	<ul style="list-style-type: none"> Use with wheels 2", 2-1/2" or 3" diameter x 1/4", 1/2", 3/4" wide x 1/4" center hole Maximum wheel width: 1" Note: 5/16" center hole is recommended for wheels 6 density or harder 	1/4"	2"	1"	14,000	1
		051144-85004-4	933	<ul style="list-style-type: none"> Use with wheels 2", 2-1/2" or 3" diameter x 1/4", 1/2", 3/4" wide x 1/4" center hole Maximum wheel width: 1" Note: 5/16" center hole is recommended for wheels 6 density or harder 	6mm*	2"	1"	14,000	100
		048011-04021-9	934	<ul style="list-style-type: none"> Use with wheels 3" to 6" diameter x 1/4", 1/2", 3/4" or 1" wide x 1/2" center hole 	1/4"	3-1/6"	2-1/2"	12,000	1
		048011-04018-9	936	<ul style="list-style-type: none"> Use with wheels 1" diameter x 1" wide x 3/16" center hole Plastic mandrel self taps into wheel 	1/4"	2-1/16"	3/4"	22,200	1
		048011-15012-3	990	<ul style="list-style-type: none"> Use with high speed or easy loading Unitized Wheels 2" to 3" diameter x 1/8" to 1/2" wide x 3/8" center hole Includes silver cap for 1/8" and 1/4" wide wheels Includes black cap for 3/8" and 1/2" wide wheels 	1/4"	1-3/4"	1"	25,100	1

*OUS Kut item

3M™ Platen Pad Cover

Silver cloth with Pressure Sensitive Adhesive backing used to protect platen pads.

Product Name	UPC	Part No.	Size	Face Color	MOQ	
3M™ Platen Pad Cover		051111-56599-5	06541	10-1/2" x 53"	Silver	1



3M™ Roto Peen Accessories

Product Name	UPC	Part No.	Description	Length	Slot Width	Width	MOQ
3M™ Roto Peen Almen Strip Holder	048011-03764-6	03764	Use to hold Almen Strips for testing peening intensity	7"	1"	2"	1
3M™ Roto Peen Assembly Kit 09041	048011-17157-9	17157	Convenient kit contains a 3M™ Roto Peen Almen Strip Holder, two sizes of Roto Peen Flap Assemblies TC-330, and Roto Peen Mandrels 7210 and 7211	—	—	—	1
3M™ Roto Peen Mandrel	048011-03768-4	7210	Use with 3M™ Roto Peen Flap Assemblies 9/16" x 1-1/4"	3"	1/16"	1/4" Dia.	1
	048011-03767-7	7211	Use with 3M™ Roto Peen Flap Assemblies 1" x 2"	8"	1/16"	3/8" Dia.	1
	048011-05969-3	7212	Use with 3M™ Roto Peen Flap Assemblies 9/16" x 1"	3"	1/16"	1/4" Dia.	1



















Molding Adhesive and Stripe Removal

Used to remove vinyl stripes, numbers, letters and graphics from gel coat and painted marine surfaces without damaging the finish.

Product Name	UPC	Part No.	Desc.	Diameter	Thick-ness	Center Hole	Thread Size	Color	Density Rating	Max RPM	MOQ
Scotch-Brite™ Molding Adhesive and Stripe Removal Disc	051131-07501-6	07501	Foam Disc	4"	—	3/8"	—	White	—	4,000	5
	051131-07502-3	07502	Foam Disc	6"	—	3/8"	—	White	—	2,800	5
Scotch-Brite™ Large Area Stripe Removal Disc	051131-07517-7	07517	Foam Disc	8"	—	5/8"	—	White	—	3,000	1
3M™ Stripe Off Wheel	051131-07498-9	07498	Wheel With Mandrel	4"	5/8"	—	3/8–16 INT	Beige	Medium	4,000	5
	051131-07499-6	07499	Wheel	4"	5/8"	—	3/8–16 INT	Beige	Medium	4,000	5

3M™ Rubber Cushion Polishing Wheels

A mechanically expandable rubber cushion available in a wide variety of sizes safely keeps 3M™ Bands and Belts from slipping during use with 3M™ Coated Abrasive Bands and Belts.

Product Name	UPC	Part No.	Diameter	Width	Shank Size	Color	Max RPM	MOQ	
3M™ Rubber Cushion Polishing Wheel		051144-45159-3	45159	1/4"	1/2"	1/8"	Black	23,000	1
		051144-45153-1	45153	1/2"	1"	1/4"	Black	15,000	1
		051144-45156-2	45156	1/2"	1/2"	1/4"	Black	30,000	1
		051144-45152-4	45152	1/2"	1-1/2"	1/4"	Black	15,000	1
		051144-45145-6	45145	3/4"	1"	1/4"	Black	17,000	1
		051144-45148-7	45148	3/4"	1/2"	1/4"	Black	30,000	1
		051144-45144-9	45144	3/4"	1-1/2"	1/4"	Black	10,000	1
		051144-45146-3	45146	3/4"	3/4"	1/4"	Black	24,000	1
		051144-45139-5	45139	1"	1"	1/4"	Black	18,000	1
		051144-45138-8	45138	1"	1-1/2"	1/4"	Black	10,000	1
		051144-45137-1	45137	1"	2"	1/4"	Black	8,000	1
		051144-45132-6	45132	1-1/2"	1"	1/4"	Black	14,000	1
		051144-45131-9	45131	1-1/2"	1-1/2"	1/4"	Black	10,000	1
		051144-45130-2	45130	1-1/2"	2"	1/4"	Black	8,000	1
		051144-45129-6	45129	2"	1"	1/4"	Black	11,000	1
		051144-45127-2	45127	2"	2"	1/4"	Black	6,000	1
		051144-45123-4	45123	3"	3"	1/2"	Black	3,000	1
		051144-45124-1	45124	3"	3"	3/8"	Black	3,000	1

3M™ Rubber Slotted Expander Wheels



Slotted wheels available in a wide variety of sizes for use with 3M™ Bands and Belts. Centrifugal force while tool is running holds band on expander wheel.

Product Name		UPC	Part No.	Diameter	Width	Center Hole	Thread Size	Shank Size	Color	Density Rating	Max RPM	MOQ
3M™ Rubber Slotted Expander Wheel		051144-77717-4	77717	1"	1"	—	—	1/4"	Black	Medium	18,000	1
		051144-77718-1	77718	1-1/2"	1"	—	—	1/4"	Black	Medium	14,000	1
		051144-77720-4	77720	2"	1"	—	—	1/4"	Black	Medium	12,000	1
		051144-77721-1	77721	2"	2"	—	—	1/4"	Black	Medium	6,000	1
		051144-77722-8	77722	3"	3"	—	5/8-11 INT	—	Black	Medium	6,000	1
		051141-28349-4	28349*	3.4"	3"	5/8"	—	—	Black	Soft	3,500	1
		051141-28348-7	28348**	5"	3-1/2"	5/8"	—	—	Black	Soft	3,500	1
		051141-28718-8	28718	5"	3-1/2"	1"	—	—	Black	Soft	3,500	1

*3" x 10-11/16" Belt **3-1/2" x 10-15-1/2" Belt

3M™ Wetordry™ Rubber Squeegees

Flexible, sturdy rubber used for removing slush created when sanding or applying glazing putty and plastic filler.

Product Name		UPC	Part No.	Size	Thickness	Color	Density Rating	MOQ
3M™ Wetordry™ Rubber Squeegee		051144-05518-0	05518	2" x 3"	3/16"	Black	Firm	1
		051144-05517-3	05517	2-3/4" x 4-1/4"	3/16"	Black	Firm	1

3M™ All Purpose Tack Cloth

3M™ All Purpose Tack Cloth stays soft for a comfortable cleanup just before painting and is reusable. Use to remove dirt, lint, dust and sanding particles from metal, plastic, fiberglass and wood.

Product Name	UPC	Part No.	Size	Color	Material	MOQ
3M™ Tack Pad	051131-07910-6	07910	175mm x 235mm	White	Foam	1
3M™ Tack Pad Dispenser	051131-07909-0	07909	—	—	—	1
3M™ Tack Cloth	051111-10132-2	10132NA	17" x 36"	White	Woven Synthetic Fiber	48

Power Tool Conversion Replacement Parts

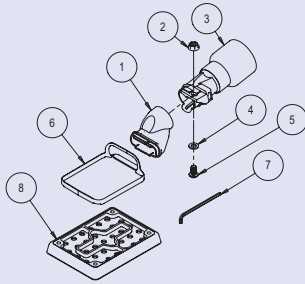

3" x 4" Non-Vacuum to Central Vacuum

Model #	Description	Part #
① A1350	Snap-On Exhaust Adaptor	28162
② A0048	M5 Flanged Nut	28120
③ A1360	Orbital Sander Central Vacuum Swivel Exhaust Assembly, 1" (28mm)	28168
④ A0047	M5 Washer	28119
⑤ A0769	Screw	28145
⑥ A1356	Shroud Seal	28166
⑦ A0864	Hex Wrench, 2.5mm	28147
⑧ 20435	3M™ Hookit™ Clean Sanding Pad, 3" x 4" x 1/2", Red Foam	20435

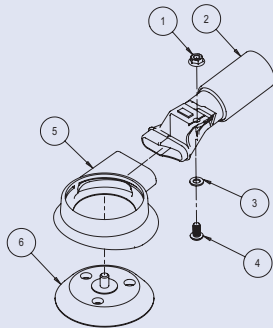

3" Non-Vacuum to Central Vacuum

Model #	Description	Part #
① A0048	M5 Flanged Nut	28120
② A1343	Central Vacuum Random Orbital Sander Swivel Exhaust Assembly	28157
③ A0047	M5 Washer	28119
④ A0769	Screw	28145
⑤ A1335	Random Orbital Sander Skrit/Shroud	28155
⑥ 20350	3M™ Hookit™ Clean Sanding Low Profile Disc Pad, 3" x 1/2" x 1/4-20 EXT, 3 Holes, Red Foam	20350

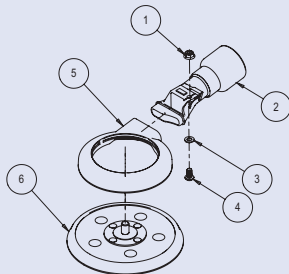

5" Non-Vacuum to Central Vacuum

Model #	Description	Part #
① A0048	M5 Flanged Nut	28120
② A1343	Central Vacuum Random Orbital Sander Swivel Exhaust Assembly	28157
③ A0047	M5 Washer	28119
④ A0769	Screw	28145
⑤ A1347	Shroud	28159
⑥ 20353	3M™ Hookit™ Clean Sanding Low Profile Disc Pad, 5" x 3/8" x 5/16-24 EXT, 44 Holes, Red Foam	20353

Power Tool Conversion Replacement Parts

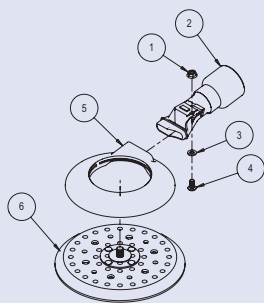

6" Non-Vacuum to Central Vacuum

Model #	Description	Part #
① A0048	M5 Flanged Nut	28120
② A1343	Central Vacuum Random Orbital Sander Swivel Exhaust Assembly	28157
③ A0047	M5 Washer	28119
④ A0769	Screw	28145
⑤ A1348	Random Orbital Sander Clean Sanding Shroud	28160
⑥ 20356	3M™ Hookit™ Clean Sanding Low Profile Disc Pad, 6" x 3/8" x 5/16-24 EXT, 52 Holes, Red Foam	20356

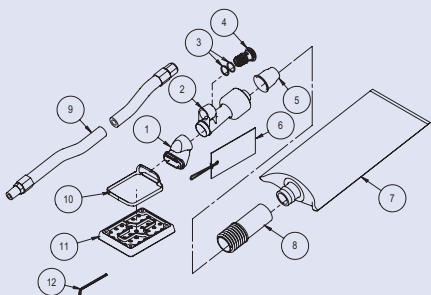

3" x 4" Non-Vacuum to Self-Generated Vacuum

Model #	Description	Part #
① A1350	Snap-On Exhaust Adaptor	28162
② A1338	Self-Generated Vacuum Hose Swivel Exhaust Assembly, 1" (28mm)	28156
③ A0044	O-Ring, 14" x 1-1/2"	28117
④ A0722	Self-Generated Vacuum Retainer	28141
⑤ A00778	Hose Seal	28146
⑥ NA	TAG	NA
⑦ 20452	Clean Sanding Filter Bag, Large	20452
⑧ 20453	Filter Bag Adaptor, 1" EXT Hose Thread x 1" ID	20453
⑨ 20209	Random Orbital Sander Air Line Extension, 3/8" x 4'	20209
⑩ A1356	Shroud Seal	28166
⑪ 20435	3M™ Hookit™ Clean Sanding Pad, 3" x 4" x 1/2", Red Foam	20435
⑫ A0864	Hex Wrench, 2.5mm	28147

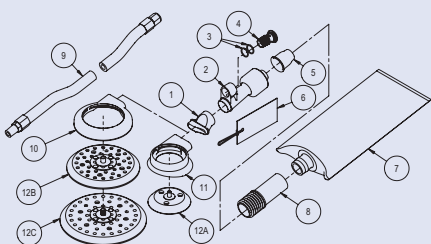

3", 5", 6" Non-Vacuum to Self-Generated Vacuum

Model #	Description	Part #
① A1333	Self-Generated Vacuum Skrit/Shroud Adaptor	28153
② A1338	Self-Generated Vacuum Hose Swivel Exhaust Assembly, 1" (28mm)	28156
③ A0044	O-Ring, 14" x 1-1/2"	28117
④ A0006	Self-Generated Vacuum Retainer	28095
⑤ A00778	Hose Seal	28146
⑥ NA	TAG	NA
⑦ 20452	Clean Sanding Filter Bag, Large	20452
⑧ 20453	Filter Bag Adaptor, 1" EXT Hose Thread x 1" ID	20453
⑨ 20209	Random Orbital Sander Air Line Extension, 3/8" x 4 ft.	20209
⑩ A1347	5"/6" Shroud	28159
⑩ A1348	6" Random Orbital Sander Clean Sanding Shroud	28160
⑪ A1335	3" Random Orbital Sander Skrit/Shroud	28155
⑫A 20350	3M™ Hookit™ Clean Sanding Low Profile Disc Pad, 3" x 1/2" x 1/4-20 EXT, 3 Holes, Red Foam	20350
⑫B 20353	3M™ Hookit™ Clean Sanding Low Profile Disc Pad, 5" x 3/8" x 5/16-24 EXT, 44 Holes, Red Foam	20353
⑫C 20356	3M™ Hookit™ Clean Sanding Low Profile Disc Pad, 6" x 3/8" x 5/16-24 EXT, 52 Holes, Red Foam	20356

Optional		
28301	Vacuum Hose, 1" ID x 6 ft.	28301
28302	Vacuum Hose Adaptor, 1" INT Hose Thread	28302
A1434	Vacuum Bag Cover, 20" x 9"	28303
20338	Vacuum Bag Inserts	20338

UPC Index

UPC	Page	UPC	Page	UPC	Page	UPC	Page
048011-03764-6	63	048011-30201-0	40	051115-06524-8	10	051131-05670-1	55
048011-03767-7	63	048011-33521-6	28	051115-06528-6	8	051131-05671-8	59
048011-03768-4	63	048011-33608-4	54	051115-06529-3	8	051131-05672-5	59
048011-04013-4	54	048011-33732-6	40	051115-06530-9	8	051131-05684-8	55
048011-04018-9	62	048011-33733-3	40	051115-06540-8	8	051131-05685-5	55
048011-04019-6	15	048011-33734-0	40	051115-06541-5	8	051131-05686-2	55
048011-04020-2	61	048011-33966-5	51	051115-06544-6	10	051131-05687-9	55
048011-04021-9	62	048011-91136-6	51	051115-06545-3	8	051131-05688-6	55
048011-04130-8	20	051111-10132-2	66	051115-06546-0	8	051131-05689-3	55
048011-04132-2	20	051111-50193-1	44	051115-06569-9	10	051131-05690-9	55
048011-05673-9	20	051111-50197-9	57	051115-06573-6	8	051131-05691-6	55
048011-05674-6	21	051111-50198-6	46	051115-06574-3	8	051131-05692-3	59
048011-05677-7	21	051111-50199-3	46	051115-06575-0	8	051131-05693-0	59
048011-05680-7	21	051111-51042-1	24, 29	051115-06576-7	8	051131-05694-7	59
048011-05681-4	21	051111-51043-8	44	051115-06577-4	8	051131-05695-4	59
048011-05682-1	21	051111-51045-2	52	051115-06585-9	9	051131-05696-1	59
048011-05717-0	54	051111-51046-9	52	051115-06586-6	10	051131-05717-3	45
048011-05969-3	63	051111-51047-6	19	051115-06590-3	9	051131-05718-0	45
048011-07491-7	61	051111-51076-6	43	051115-06610-8	10	051131-05723-4	45
048011-07492-4	20	051111-51150-3	46	051115-28108-2	10	051131-05725-8	45
048011-07494-8	20	051111-51151-0	43	051115-28134-1	11	051131-05726-5	47
048011-09448-9	21	051111-51155-8	35	051115-28146-4	3	051131-05727-2	47
048011-09449-6	21	051111-51157-2	42	051115-28147-1	10	051131-05729-6	45
048011-09450-2	21	051111-51158-9	43	051115-66901-9	10	051131-05740-1	55
048011-09451-9	21	051111-51168-8	46	051115-66902-6	10	051131-05741-8	55
048011-09493-4	54	051111-55764-8	22	051115-66905-7	6	051131-05742-5	55
048011-12929-7	54	051111-55765-5	36	051115-66906-4	6	051131-05744-9	56
048011-13928-9	61	051111-55766-2	54	051122-01811-4	7	051131-05746-3	57
048011-13966-1	62	051111-55813-3	31	051122-01812-1	7	051131-05748-7	57
048011-13967-8	62	051111-55833-1	46	051131-02513-4	53	051131-05750-0	57
048011-13968-5	62	051111-55845-4	60	051131-05207-9	56	051131-05751-7	45
048011-14111-4	21	051111-55846-1	60	051131-05208-6	56	051131-05759-3	45
048011-14114-5	21	051111-56445-5	53	051131-05209-3	56	051131-05760-9	45
048011-14915-8	40	051111-56453-0	53	051131-05215-4	56	051131-05768-5	23
048011-15012-3	62	051111-56459-2	32	051131-05216-1	56	051131-05771-5	28
048011-15059-8	40	051111-56462-2	58	051131-05520-9	53	051131-05775-3	22, 29
048011-15060-4	40	051111-56472-1	31	051131-05526-1	58	051131-05777-7	28
048011-15408-4	40	051111-56479-0	39	051131-05538-4	35	051131-05779-1	23
048011-16859-3	51	051111-56491-2	27	051131-05541-4	35	051131-05780-7	24
048011-16860-9	51	051111-56493-6	54	051131-05545-2	29, 31	051131-05781-4	24
048011-17157-9	63	051111-56573-5	19	051131-05546-9	29, 31	051131-05782-1	24
048011-18444-9	23	051111-56599-5	62	051131-05551-3	26	051131-05783-8	24
048011-22970-6	14	051111-60306-2	18	051131-05568-1	31	051131-05791-3	54
048011-22971-3	14	051111-60311-6	25	051131-05581-0	30	051131-05792-0	55
048011-22972-0	14	051111-60527-1	43	051131-05582-7	30	051131-05848-4	57
048011-26224-1	45	051111-60528-8	43	051131-05589-6	58	051131-05855-2	24, 29
048011-27628-1	15	051111-60537-0	42	051131-05591-9	58	051131-05858-3	26
048011-27680-9	15	051111-60788-6	60	051131-05637-4	19	051131-05865-1	26
048011-30095-5	15	051111-60799-2	43	051131-05645-9	29, 30	051131-05876-7	24, 29
048011-30096-2	15	051111-61009-1	42	051131-05646-6	29, 30	051131-06002-9	41
048011-30133-4	15	051111-61104-3	42	051131-05668-8	59	051131-06025-8	50
048011-30134-1	15	051115-06522-4	10	051131-05669-5	59	051131-06026-5	50

UPC Index

UPC	Page	UPC	Page	UPC	Page	UPC	Page
051131-06027-2	50	051135-92689-5	51	051141-20453-6	3	051141-28402-6	9
051131-06039-5	49	051141-20206-8	26	051141-20454-3	29, 30	051141-28409-5	21
051131-06044-9	49	051141-20207-5	42	051141-20465-9	26, 29	051141-28410-1	44
051131-06045-6	49	051141-20209-9	2	051141-20466-6	2	051141-28411-8	24
051131-06046-3	49	051141-20215-0	10	051141-20467-3	2	051141-28416-3	18
051131-06075-3	41	051141-20216-7	7	051141-25119-6	2	051141-28417-0	18
051131-07390-6	24	051141-20217-4	7	051141-25122-6	24, 29	051141-28418-7	19
051131-07394-4	23	051141-20218-1	7	051141-25132-5	51	051141-28419-4	14
051131-07493-4	20	051141-20221-1	7	051141-25134-9	43	051141-28434-7	3
051131-07498-9	63	051141-20222-8	7	051141-25135-6	43	051141-28435-4	3
051131-07499-6	63	051141-20223-5	6	051141-27819-5	14	051141-28436-1	3
051131-07500-9	40	051141-20242-6	25	051141-27884-1	23	051141-28441-5	57
051131-07501-6	63	051141-20245-7	21	051141-28301-2	13	051141-28442-2	18
051131-07502-3	63	051141-20246-4	2	051141-28302-9	12	051141-28443-9	17
051131-07517-7	63	051141-20247-1	3	051141-28303-6	12	051141-28472-9	22
051131-07545-0	40	051141-20248-8	23	051141-28304-3	12	051141-28473-6	39
051131-07547-4	40	051141-20256-3	7	051141-28317-3	6	051141-28474-3	37
051131-07715-7	35	051141-20271-6	43	051141-28318-0	7	051141-28475-0	37
051131-07909-0	66	051141-20272-3	42	051141-28319-7	11	051141-28476-7	18
051131-07910-6	66	051141-20274-7	43	051141-28320-3	11	051141-28477-4	18
051131-09004-0	49	051141-20278-5	28	051141-28321-0	28	051141-28478-1	3
051131-09005-7	48	051141-20279-2	21	051141-28322-7	28	051141-28531-3	27
051131-09006-4	48	051141-20290-7	26, 29	051141-28323-4	28	051141-28548-1	23
051131-09007-1	48	051141-20338-6	12	051141-28324-1	28	051141-28574-0	43
051131-09009-5	47	051141-20340-9	12	051141-28325-8	27	051141-28580-1	39
051131-09010-1	47	051141-20341-6	12	051141-28326-5	28	051141-28581-8	39
051131-09011-8	47	051141-20342-3	5	051141-28348-7	65	051141-28584-9	46
051131-09019-4	48	051141-20343-0	5	051141-28349-4	65	051141-28605-1	7
051131-09020-0	47	051141-20344-7	5	051141-28364-7	3	051141-28606-8	7
051131-09023-1	49	051141-20348-5	31	051141-28365-4	3	051141-28607-5	7
051131-09030-9	49	051141-20350-8	26	051141-28368-5	4	051141-28608-2	7
051131-09033-0	47	051141-20351-5	29, 31	051141-28369-2	4	051141-28609-9	7
051131-09034-7	47	051141-20352-2	23, 29	051141-28370-8	4	051141-28610-5	7
051131-09047-7	47	051141-20353-9	26, 29	051141-28371-5	4	051141-28611-2	7
051131-09048-4	48	051141-20354-6	29, 31	051141-28372-2	4	051141-28612-9	7
051131-09061-3	49	051141-20355-3	23, 29	051141-28373-9	4	051141-28613-6	7
051131-09062-0	49	051141-20356-0	26, 29	051141-28374-6	4	051141-28614-3	7
051131-09063-7	48	051141-20425-3	26, 29	051141-28375-3	4	051141-28625-9	17
051131-09065-1	48	051141-20427-7	26	051141-28376-0	4	051141-28626-6	18
051131-09067-5	48	051141-20428-4	26	051141-28377-7	4	051141-28632-7	13
051131-09082-8	56	051141-20432-1	32	051141-28378-4	4	051141-28636-5	15
051131-09089-7	47	051141-20433-8	25	051141-28379-1	4	051141-28637-2	15
051131-16896-1	48	051141-20434-5	32	051141-28380-7	4	051141-28651-8	13
051131-16904-3	49	051141-20435-2	27	051141-28381-4	4	051141-28652-5	13
051131-35928-4	48	051141-20439-0	21	051141-28382-1	4	051141-28653-2	8
051131-35929-1	48	051141-20442-0	29, 30	051141-28383-8	3	051141-28654-9	19
051131-36044-0	49	051141-20443-7	28	051141-28384-5	54	051141-28655-6	25
051131-36045-7	49	051141-20444-4	28	051141-28385-2	61	051141-28656-3	17
051131-37716-5	45	051141-20445-1	28	051141-28393-7	13	051141-28657-0	17
051131-37720-2	45	051141-20446-8	28	051141-28394-4	6	051141-28658-7	17
051135-92499-0	46	051141-20451-2	2	051141-28395-1	9	051141-28660-0	32
051135-92500-3	43	051141-20452-9	3	051141-28401-9	43	051141-28661-7	31

UPC Index

UPC	Page	UPC	Page	UPC	Page	UPC	Page
051141-28662-4	22	051141-55100-5	9	051144-14212-5	38	051144-45138-8	64
051141-28695-2	41	051141-55106-7	13	051144-14215-6	38	051144-45139-5	64
051141-28696-9	42	051141-55108-1	13	051144-14216-3	38	051144-45144-9	64
051141-28709-6	23, 29	051141-55109-8	13	051144-14270-5	16	051144-45145-6	64
051141-28710-2	39	051141-55115-9	11	051144-14307-8	61	051144-45146-3	64
051141-28711-9	39	051141-55146-3	5	051144-14308-5	61	051144-45148-7	64
051141-28712-6	37	051141-55180-7	2	051144-14736-6	46	051144-45152-4	64
051141-28713-3	37	051141-55204-0	5	051144-14738-0	42	051144-45153-1	64
051141-28714-0	37	051141-55205-7	5	051144-28576-4	38	051144-45156-2	64
051141-28718-8	65	051141-55206-4	5	051144-28577-1	38	051144-45159-3	64
051141-28725-6	10	051141-55434-1	6	051144-28578-8	38	051144-45179-1	36
051141-28726-3	4	051141-55435-8	6	051144-28579-5	38	051144-45188-3	58
051141-28727-0	14	051141-55436-5	6	051144-45032-9	51	051144-45189-0	58
051141-28728-7	14	051141-55437-2	6	051144-45033-6	51	051144-45190-6	18
051141-28730-0	12	051141-55752-6	8	051144-45034-3	51	051144-45194-4	16
051141-28738-6	46	051141-55772-4	8	051144-45035-0	51	051144-45198-2	58
051141-28739-3	9	051141-55788-5	10	051144-45038-1	14	051144-45203-3	58
051141-28740-9	9	051144-05440-4	58	051144-45068-8	33	051144-45204-0	58
051141-28741-6	14	051144-05441-1	58	051144-45069-5	33	051144-45205-7	18
051141-28742-3	39	051144-05442-8	58	051144-45070-1	33	051144-45208-8	16
051141-28743-0	14	051144-05444-2	56	051144-45071-8	33	051144-45215-6	29, 31
051141-28751-5	39	051144-05448-0	57	051144-45072-5	33	051144-45217-0	29, 30
051141-28752-2	39	051144-05450-3	32	051144-45073-2	33	051144-45218-7	29, 30
051141-28753-9	39	051144-05452-7	32	051144-45074-9	33	051144-76848-6	47
051141-28754-6	31	051144-05510-4	33	051144-45081-7	14	051144-77340-4	41
051141-28768-3	46	051144-05517-3	65	051144-45090-9	36	051144-77717-4	65
051141-28772-0	29, 31	051144-05518-0	65	051144-45091-6	36	051144-77718-1	65
051141-28777-5	54	051144-05519-7	53	051144-45092-3	36	051144-77720-4	65
051141-30324-6	12	051144-05530-2	58	051144-45093-0	36	051144-77721-1	65
051141-30331-4	6	051144-05539-5	35	051144-45094-7	36	051144-77722-8	65
051141-30334-5	9	051144-05540-1	35	051144-45095-4	35	051144-77723-5	37
051141-30364-2	9	051144-05575-3	29, 31	051144-45096-1	35	051144-77724-2	38
051141-30437-3	10	051144-05579-1	31	051144-45097-8	35	051144-77726-6	37
051141-30439-7	12	051144-05585-2	58	051144-45098-5	35	051144-77728-0	38
051141-30440-3	12	051144-05586-9	58	051144-45099-2	35	051144-77729-7	38
051141-30441-0	12	051144-05620-0	19	051144-45100-5	35	051144-77733-4	38
051141-30442-7	13	051144-05621-7	19	051144-45101-2	35	051144-77737-2	38
051141-30443-4	7	051144-05622-4	19	051144-45102-9	34	051144-77740-2	38
051141-30444-1	7	051144-05710-8	45	051144-45116-6	60	051144-77749-5	53
051141-30445-8	7	051144-11063-6	58	051144-45117-3	60	051144-77750-1	54
051141-30670-4	5	051144-11823-6	18	051144-45118-0	60	051144-77751-8	23
051141-30671-1	4	051144-11824-3	18	051144-45119-7	60	051144-77752-5	54
051141-30672-8	10	051144-13084-9	41	051144-45120-3	60	051144-77855-3	23, 29
051141-30673-5	11	051144-13325-3	16	051144-45121-0	61	051144-77856-0	24, 29
051141-30674-2	11	051144-13441-0	46	051144-45123-4	64	051144-80514-3	17
051141-30831-9	10	051144-13442-7	46	051144-45124-1	64	051144-80515-0	17
051141-30832-6	11	051144-13627-8	23	051144-45127-2	64	051144-80516-7	17
051141-30933-0	5	051144-14197-5	37	051144-45129-6	64	051144-81235-6	41
051141-30948-4	10	051144-14198-2	37	051144-45130-2	64	051144-81470-1	44
051141-55081-7	11	051144-14201-9	37	051144-45131-9	64	051144-81471-8	44
051141-55082-4	9	051144-14202-6	37	051144-45132-6	64	051144-81728-3	17
051141-55085-5	9	051144-14211-8	38	051144-45137-1	64	051144-81729-0	17

UPC Index

UPC	Page	UPC	Page	UPC	Page	UPC	Page
051144-81732-0	17	051144-82705-3	53	051144-84998-7	36	051144-85105-8	22
051144-81733-7	17	051144-82793-0	60	051144-84999-4	36	051144-85287-1	25
051144-81734-4	17	051144-82877-7	41	051144-85000-6	36	051144-88739-2	22
051144-81821-1	29, 31	051144-82878-4	41	051144-85001-3	36	051144-88741-5	53
051144-82178-5	31	051144-82880-7	22	051144-85004-4	62	051144-88743-9	18
051144-82189-1	31	051144-82974-3	39	051144-85078-5	44	051144-88748-4	36
051144-82191-4	53	051144-82975-0	39	051144-85079-2	44	051144-88749-1	60
051144-82271-3	46	051144-83058-9	41	051144-85083-9	44	051144-88753-8	41
051144-82455-7	34	051144-83242-2	36	051144-85084-6	44	051144-88765-1	52
051144-82457-1	53	051144-83489-1	37	051144-85095-2	54	051144-88769-9	52
051144-82531-8	44	051144-83497-6	56	051144-85096-9	22	134375-38286-1	43
051144-82564-6	25	051144-83978-0	56	051144-85097-6	61	134375-38287-8	43
051144-82565-3	25	051144-83980-3	36	051144-85099-0	44		
051144-82566-0	25	051144-84229-2	58	051144-85100-3	44		
051144-82567-7	25	051144-84993-2	36	051144-85103-4	44		
051144-82659-9	24, 29	051144-84994-9	36	051144-85104-1	29, 31		

Part No. Index

Part No.	Page	Part No.	Page	Part No.	Page	Part No.	Page	Part No.	Page	Part No.	Page
01811	7	05440	58	05620	19	05727	47	06025	50	07390	24
01812	7	05441	58	05621	19	05729	45	06026	50	07394	23
01904	53	05442	58	05622	19	5730	44	06027	50	07498	63
01908	54	05444	56	05637	19	05740	55	06039	49	07499	63
01912	43	05448	57	05645	29, 30	05741	55	06044	49	07500	40
01927	44	05450	32	05646	29, 30	05742	55	06045	49	07501	63
01963	43	05452	32	05668	59	05744	56	06046	49	07502	63
02021	45	05510	33	05669	59	05746	57	06075	41	07517	63
02140	19	05517	65	05670	55	05748	57	06522	10	07545	40
02286	39	05518	65	05671	59	05750	57	06524	10	07547	40
02345	46	05519	53	05672	59	05751	45	06528	8	07715	35
02362	43	05520	53	05684	55	05759	45	06529	8	07909	66
02362B	43	05526	58	05685	55	05760	45	06530	8	07910	66
02511	46	05530	58	05686	55	05768	23	06540	8	09004	49
02513	53	05538	35	05687	55	05771	28	06541	8	09005	48
02618	19	05539	35	05688	55	05775	22, 29	06541	62	09006	48
02637	43	05540	35	05689	55	05777	28	06544	10	09007	48
02648	43	05541	35	05690	55	05779	23	06545	8	09009	47
02648B	43	05545	29, 31	05691	55	05780	24	06546	8	09010	47
02700	22	05546	29, 31	05692	59	05781	24	06569	10	09011	47
02712	60	05551	26	05693	59	05782	24	06573	8	09019	48
02713	60	05568	31	05694	59	05783	24	06574	8	09020	47
02727	46	05575	29, 31	05695	59	05791	54	06575	8	09023	49
02795	32	05579	31	05696	59	05792	55	06576	8	09030	49
03764	63	05581	30	05710	45	05848	57	06577	8	09033	47
05207	56	05582	30	05717	45	05855	24, 29	06585	9	09034	47
05208	56	05585	58	05718	45	05858	26	06586	10	09047	47
05209	56	05586	58	05723	45	05865	26	06590	9	09048	48
05215	56	05589	58	05725	45	05876	24, 29	06610	10	09061	49
05216	56	05591	58	05726	47	06002	41	06624	58	09062	49

Part No. Index

Part No.	Page	Part No.	Page	Part No.	Page	Part No.	Page	Part No.	Page	Part No.	Page
09063	48	7493	20	20341	12	28322	28	28576	38	28743	14
09065	48	9145	21	20342	5	28323	28	28577	38	28751	39
09067	48	9145	21	20343	5	28324	28	28578	38	28752	39
09082	56	9215	20	20344	5	28325	27	28579	38	28753	39
09089	47	10132NA	66	20348	31	28326	28	28580	39	28754	31
09357	43	11063	58	20350	26	28348	65	28581	39	28768	46
09358	43	11823	18	20351	29, 31	28349	65	28584	46	28772	29, 31
1	40	11824	18	20352	23, 29	28364	3	28605	7	28777	54
2	40	13084	41	20353	26, 29	28365	3	28606	7	30133	15
3	15, 40, 51	13325	16	20354	29, 31	28368	4	28607	7	30134	15
4	40	13441	46	20355	23, 29	28369	4	28608	7	30201	40
5	51	13442	46	20356	26, 29	28370	4	28609	7	30324	12
6	40	14197	37	20425	26, 29	28371	4	28610	7	30331	6
7	40	14198	37	20427	26	28372	4	28611	7	30334	9
8	15	14201	37	20428	26	28373	4	28612	7	30364	9
9	14	14202	37	20432	32	28374	4	28613	7	30437	10
250	54	14211	38	20433	25	28375	4	28614	7	30439	12
250BP	54	14212	38	20434	32	28376	4	28625	17	30440	12
250HD	54	14215	38	20435	27	28377	4	28626	18	30441	12
261	54	14216	38	20439	21	28378	4	28632	13	30442	13
300	15	14270	16	20442	29, 30	28379	4	28636	15	30443	7
905	21	14307	61	20443	28	28380	4	28637	15	30444	7
906	21	14308	61	20444	28	28381	4	28651	13	30445	7
914	20, 21	14736U	46	20445	28	28382	4	28652	13	30662	5
915	21	14736V	46	20446	28	28383	3	28653	8	30663	5
916	21	14738	42	20451	2	28385	61	28654	19	30664	5
917	21	16896	48	20452	3	28393	13	28655	25	30665	5
917M	21	16904	49	20453	3	28394	6	28656	17	30666	5
918	21	17157	63	20454	29, 30	28395	9	28657	17	30667	5
922	20	18444	23	20465	26, 29	28401	43	28658	17	30668	5
923	20	20206	26	20466	2	28402	9	28660	32	30669	5
924	20	20209	2	20467	2	28410	44	28661	31	30670	5
931	62	20215	10	25119	2	28411	24	28662	22	30671	4
932	62	20216	7	25122	24, 29	28416	18	28695	41	30672	10
933	62	20217	7	25132	51	28417	18	28696	42	30673	11
934	62	20218	7	25134	43	28418	19	28710	39	30674	11
935	61	20221	7	25135	43	28419	14	28711	39	30831	10
936	62	20222	7	27628	15	28434	3	28712	37	30832	11
938	61	20223	6	27680	15	28435	3	28713	37	30933	5
944	61	20242	25	27884	23	28436	3	28714	37	30948	10
947	23	20245	21	28108	10	28441	57	28718	65	33521	28
947TH	21	20246	2	28134	11	28442	18	28719	14	35928	48
952	54	20247	3	28146	3	28443	17	28725	10	35929	48
961	54	20248	23	28147	10	28472	22	28726	4	36044	49
990	62	20256	7	28301	13	28473	39	28727	14	36045	49
A1434	12	20271	43	28302	12	28474	37	28728	14	37716	45
3125H	42	20272	42	28304	12	28475	37	28730	12	37720	45
3125P	42	20274	43	28317	6	28476	18	28738	46	45038	14
7210	63	20278	28	28318	7	28477	18	28739	9	45068	33
7211	63	20290	26, 29	28319	11	28478	3	28740	9	45069	33
7212	63	20338	12	28320	11	28531	27	28741	14	45070	33
		20340	12	28321	28	28574	43	28742	39	45071	33

Part No. Index

Part No.	Page	Part No.	Page	Part No.	Page	Part No.	Page	Part No.	Page	Part No.	Page
45072	33	45139	64	55108	13	77720	65	82191	53	85078	44
45073	33	45144	64	55109	13	77721	65	82271	46	85079	44
45074	33	45145	64	55115	11	77722	65	82455	34	85083	44
45081	14	45146	64	55146	5	77723	37	82457	53	85084	44
45090	36	45148	64	55180	2	77724	38	82531	44	85095	54
45091	36	45152	64	55204	5	77726	37	82564	25	85096	22
45092	36	45153	64	55205	5	77728	38	82565	25	85097	61
45093	36	45156	64	55206	5	77729	38	82566	25	85099	44
45094	36	45159	64	55434	6	77733	38	82567	25	85100	44
45095	35	45179	36	55435	6	77737	38	82659	24, 29	85103	44
45096	35	45188	58	55436	6	77740	38	82705	53	85104	29, 31
45097	35	45189	58	55437	6	77749	53	82793	60	85105	22
45098	35	45190	18	55752	8	77750	54	82877	41	85287	25
45099	35	45194	16	55772	8	77751	23	82878	41	86100	18
45100	35	45198	58	55788	10	77751B	23	82879	36	88044	57
45101	35	45203	58	60150	42	77752	54	82880	22	88132	54
45102	34	45204	58	61104	42	77855	23, 29	82974	39	88739	22
45116	60	45205	18	66901	10	77856	24, 29	82975	39	88741	53
45117	60	45208	16	66902	10	80514	17	83058	41	88743	18
45118	60	45215	29, 31	66905	6	80515	17	83242	36	88748	36
45119	60	45217	29, 30	66906	6	80516	17	83489	37	88749	60
45120	60	45218	29, 30	67415	25	81235	41	83497	56	88753	41
45121	61	50199	46	70138	23, 29	81470	44	83978	56	88765	52
45123	64	51045	52	70147	53	81471	44	83980	36	88769	52
45124	64	51046	52	70166	27	81728	17	84226	24, 29	91136	51
45127	64	51056	42	70234	31	81729	17	84229	58	99736	60
45129	64	51155	35	70437	46	81732	17	84993	36		
45130	64	55081	11	70449	31	81733	17	84994	36		
45131	64	55082	9	76848	47	81734	17	84998	36		
45132	64	55085	9	77340	41	81821	29, 31	84999	36		
45137	64	55100	9	77717	65	82178	31	85000	36		
45138	64	55106	13	77718	65	82189	31	85001	36		



Contact your local 3M authorized distributor directly. For more information on a 3M distributor or sales representative in your area, contact us at the following number:

Contiguous 48 States..... 866-279-1235 (FAX 651-778-4244)

E-mail us at 3MIndustrial@mmm.com

For additional 3M product information or material data sheets contact us at:

866-279-1235

www.3M.com/abrasives

www.3M.com/AccessoriesASD

www.3M.com/SpareParts

Additional accessories are available and may be purchased directly through Contract Production Services/CPS. Please contact Contract Production Services/CPS directly to check availability and other specific information. Use the part number to identify and specify the desired item.

Contract Production Services/CPS

1936 Lyndale Avenue South
Minneapolis, MN 55403
www.cpsabrasives.com
cjones@contactcps.com

Toll Free: 1-800-843-0619
Tel: 612-843-3445
Fax: 612-872-0189

Office Hours: Monday–Thursday, 6:00 a.m.– 4:00 p.m. (Central Time)

Important Notice to Purchaser

Product Use: Many factors beyond 3M’s control and uniquely within user’s knowledge and control can affect the use and performance of a 3M product in a particular application. Given the variety of factors that can affect the use and performance of a 3M product, user is solely responsible for evaluating the 3M product and determining whether it is fit for a particular purpose and suitable for user’s method of application.

Warranty, Limited Remedy and Disclaimer: Unless an additional warranty is specifically stated on the applicable 3M product packaging or product literature, 3M warrants that each 3M product meets the applicable 3M product specification at the time 3M ships the product. 3M MAKES NO OTHER WARRANTIES OR CONDITIONS, EXPRESS OR IMPLIED, INCLUDING, BUT NOT LIMITED TO, ANY IMPLIED WARRANTY OR CONDITION OF MERCHANTABILITY OR FITNESS FOR A PARTICULAR PURPOSE OR ANY IMPLIED WARRANTY OR CONDITION ARISING OUT OF A COURSE OF DEALING, CUSTOM OR USAGE OF TRADE. If the 3M product does not conform to this warranty, then the sole and exclusive remedy is, at 3M’s option, replacement of the 3M product or refund of the purchase price.

Limitation of Liability: Except where prohibited by law, 3M will not be liable for any loss or damage arising from the 3M product, whether direct, indirect, special, incidental or consequential, regardless of the legal theory asserted, including warranty, contract, negligence or strict liability.



3M Abrasive Systems Division

3M Center, Building 223-6S-03
St. Paul, MN 55144-1000
1-866-279-1235
www.3M.com/abrasives

Please Recycle. Printed in U.S.A.
© 3M 2013. All rights reserved.
61-5002-8098-9 REV 2014

3M, Doodlebug, Dual Lock, Finesse-it, Hookit, Imperial, Insta-Lok, Perfect-it, Roloc, Scotch-Brite, Scotchgard, Stikit, Twist-Lok and Wetordry are all trademarks of 3M. Used under license in Canada. All other trademarks are the property of their respective owners.