

3M™ Power Tools, Abrasives and Accessories



3M™ Power Tools

Abrasives Tools from the
Abrasives Experts



3M



3M™ Power Tool Warranty

Warranty and Limited Remedy: 3M warrants this tool against defects in workmanship and materials under normal operating conditions for one (1) year from the date of purchase. 3M MAKES NO OTHER WARRANTIES, EXPRESS OR IMPLIED, INCLUDING, BUT NOT LIMITED TO, ANY IMPLIED WARRANTY OF MERCHANTABILITY OR FITNESS FOR A PARTICULAR PURPOSE OR ANY IMPLIED WARRANTY ARISING OUT OF A COURSE OF DEALING, CUSTOM OR USAGE OF TRADE. User is responsible for determining whether the 3M tool is fit for a particular purpose and suitable for user's application. User must operate the tool in accordance with all applicable operating instructions, safety precautions, and other procedures stated in the operating manual to be entitled to warranty coverage. 3M shall have no obligation to repair or replace any tool or part that fails due to normal wear, inadequate or improper maintenance, inadequate cleaning, non-lubrication, improper operating environment, improper utilities, operator error or misuse, alteration or modification, mishandling, lack of reasonable care, or due to any accidental cause. If a tool or any part thereof is defective within this warranty period, your exclusive remedy and 3M's sole obligation will be, at 3M's option, to repair or replace the tool or refund the purchase price.

Limitation of Liability: Except where prohibited by law, 3M and seller will not be liable for any loss or damage arising from the 3M product, whether direct, indirect, special, incidental or consequential, regardless of the legal theory asserted, including warranty, contract, negligence or strict liability.

Submitting a Warranty Claim: Contact your dealer when submitting a warranty claim in accordance with the restrictions listed above. Please note that all warranty claims are subject to manufacturer's approval. Be sure to keep your sales receipt in a safe place. This must be submitted when filing a warranty claim, within 1 year from the date of purchase. For additional assistance call 1-800-362-3550 (choose option 3, then option 5).

3M™ Power Tool Repair and Refurbish Service

For tools that fall outside the manufacturer's warranty (e.g. after the warranty period has expired, or when the damage is due to use and wear), 3M is pleased to offer the 3M™ Power Tool Repair and Refurbish Service. 3M™ Power Tool Repair Experts will perform a full diagnostic analysis, replace any worn parts, and restore the tool to excellent working condition, all for one flat rate. Available for all 3M™ Power Tools except pistol grip tools, 3M™ PPS™ SUN GUN™ and 3M™ Polisher 28363. Program highlights include:

- Fast turnaround (5 days + shipping time)
- Tool is rebuilt by the 3M™ Power Tool Repair Experts in Cumberland, Wisconsin
- Flat rate includes return shipping
- 90 day warranty on repaired tool



For more information, contact your 3M sales professional or call 1-800-362-3550 (choose option 3, then option 5).



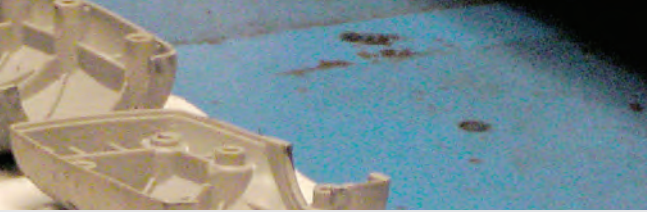

3M™ Power Tools

A full family of innovative tools to optimize your abrasive performance and maximize your comfort.

Table of Contents

■ Tools and Specifications	2–12
3M™ Random Orbital Sanders — Elite Series	2–3
3M™ Random Orbital Sanders — Original Series	4
3M™ Orbital Sanders — Elite and Original Series	4
3M™ Electric Random Orbital Sanders	5
3M™ Mini Sanders	5
3M™ Sanders and Buffers	6
3M™ Electric Variable Speed Polisher	6
3M™ Die Grinders	7
3M™ Disc Sanders	8
3M™ Grinders — Type 27	9
3M™ Cut-Off Wheel Tools	10
Replacement Parts for 1.5 HP Power Tools	10
3M™ Inline Sanders	11
3M™ Match and Finish Sander	11
3M™ File Belt Sander and Attachment Arms	12
■ Tool Accessories	13–24
Orbital/Random Orbital Sander Accessories	13–18
Mini-Random Orbital Sander Accessories	18
Nib Removal Sander Accessories	18
Buffer Accessories	18
Disc Sander Accessories	19–20
Die Grinder Accessories	20
Die Grinder and Inline Sander Accessories	21
Disc Sander/Grinder Accessories	22
File Belt Sander Accessories	23–24
■ Selection Guides for Abrasive Products	25–28
■ Sanding Techniques and Tips	29–30
■ Quick Reference Guide (tear-out sheet)	31–32



3M™ Random Orbital Sanders — Elite Series

We took our best line of air-powered 3M™ Random Orbital Sanders and made it better.



Upgrades from Original Series — Improved durability, ergonomics and noise level

- 1 Aluminum housing for added durability and reduced vibration; Durable composite cover helps prevent cracked housings
- 2 **Recessed Lever** eliminates pinch points
- 3 Extended cover with **3M™ Gripping Material** allows better control with reduced effort, insulates from cold and reduces vibration
- 4 Safer **Thumb Wheel** mounted speed control reduces inadvertent speed changes
- 5 Wider port for **more efficient dust capture**
- 6 **Internal Muffler** results in less breakage, SGV 6 dB quieter
- 7 **Integrated Wrist Support** for comfort and leverage
- 8 Clearance for large inlet coupler
- 9 **Center Mount Exhaust** for more finger room, better dust collection airflow

Red Text = Proprietary 3M Design Feature

3M™ Random Orbital Sanders — Elite Series

3M™ Elite Non-Vacuum Random Orbital Sanders

Our top-of-the-line non-vacuum random orbital sanders featuring the latest in 3M innovation.



Model No.	Tool Dia. Inch (mm)	Max RPM	Motor HP (W)	Orbit Dia. Inch (mm)	Air Flow Rate SCFM (LPM)	Noise Level dBA (power)	Weight Pound (kg)	Length Inch (mm)	Height Inch (mm)	Pad Included	UPC
28494	3 (76)	12,000	0.28 (209)	3/16 (5)	17 (481)	73 (84)	1.5 (.7)	6 (147)	4 (92.5)	Hookit™ 20350	051141-28494-1
28496	3 (76)	12,000	0.28 (209)	3/32 (2.5)	17 (481)	73 (84)	1.3 (.6)	6 (147)	3 (86)	Stikit™ 20348	051141-28496-5
28583	5 (127)	12,000	0.28 (209)	3/8 (9.5)	17 (481)	74 (85)	1.8 (.8)	7 (172)	4 (91)	Stikit™ 20351	051141-28583-2
28495	5 (127)	12,000	0.28 (209)	5/16 (8)	17 (481)	74 (85)	1.8 (.8)	7 (172)	4 (91)	Stikit™ 20351	051141-28495-8
28497	5 (127)	12,000	0.28 (209)	3/16 (5)	17 (481)	74 (85)	1.8 (.8)	7 (172)	4 (91)	Stikit™ 20351	051141-28497-2
28708	5 (127)	12,000	0.28 (209)	3/16 (5)	17 (481)	74 (85)	1.8 (.8)	7 (172)	4 (91)	Hookit™ 20352	051141-28708-9
28498	5 (127)	12,000	0.28 (209)	3/32 (2.5)	17 (481)	74 (85)	1.7 (.8)	7 (172)	4 (91)	Stikit™ 20351	051141-28498-9
28582	6 (152)	12,000	0.28 (209)	3/8 (9.5)	17 (481)	75 (86)	1.9 (.9)	7 (187)	4 (91)	Stikit™ 20354	051141-28582-5
28499	6 (152)	12,000	0.28 (209)	5/16 (8)	17 (481)	75 (86)	1.9 (.9)	7 (187)	4 (91)	Stikit™ 20354	051141-28499-6
28500	6 (152)	12,000	0.28 (209)	3/16 (5)	17 (481)	75 (86)	1.9 (.8)	7 (187)	4 (91)	Stikit™ 20354	051141-28500-9
28501	6 (152)	12,000	0.28 (209)	3/32 (2.5)	17 (481)	75 (86)	2.1 (1.0)	7 (187)	4 (91)	Stikit™ 20354	051141-28501-6

3M™ Elite Self-Generated Vacuum Random Orbital Sanders*

Take dust-management to the next level with powerful self-generated vacuum tools. Featuring 3M patented Clean Sanding system with improved filter bag.



Model No.	Tool Dia. Inch (mm)	Max RPM	Motor HP (W)	Orbit Dia. Inch (mm)	Air Flow Rate SCFM (LPM)	Noise Level dBA (power)	Weight Pound (kg)	Length Inch (mm)	Height Inch (mm)	Pad Included	UPC
28511	3 (76)	12,000	0.28 (209)	3/16 (5)	17 (481)	85 (96)	1.7 (.8)	8 (209)	4 (93)	Hookit™ 20350	051141-28511-5
28513	3 (76)	12,000	0.28 (209)	3/32 (2.5)	17 (481)	85 (96)	1.4 (.7)	8 (207)	3 (88)	Hookit™ 20350	051141-28513-9
28563	5 (127)	12,000	0.28 (209)	3/8 (9.5)	17 (481)	84 (95)	1.9 (.9)	9 (234)	4 (93)	Hookit™ 20353	051141-28563-4
28512	5 (127)	12,000	0.28 (209)	5/16 (8)	17 (481)	86 (97)	1.9 (.9)	9 (234)	4 (93)	Hookit™ 20353	051141-28512-2
28514	5 (127)	12,000	0.28 (209)	3/16 (5)	17 (481)	86 (97)	1.9 (.9)	9 (234)	4 (93)	Hookit™ 20353	051141-28514-6
28515	5 (127)	12,000	0.28 (209)	3/32 (2.5)	17 (481)	86 (97)	1.8 (.8)	9 (234)	4 (93)	Hookit™ 20353	051141-28515-3
28562	6 (152)	12,000	0.28 (209)	3/8 (9.5)	17 (481)	87 (94)	2.1 (.9)	10 (245)	4 (93)	Hookit™ 20356	051141-28562-7
28510	6 (152)	12,000	0.28 (209)	5/16 (8)	17 (481)	88 (99)	2.0 (.9)	10 (245)	4 (93)	Hookit™ 20356	051141-28510-8
28516	6 (152)	12,000	0.28 (209)	3/16 (5)	17 (481)	89 (100)	2.0 (.9)	10 (245)	4 (93)	Hookit™ 20356	051141-28516-0
28517	6 (152)	12,000	0.28 (209)	3/32 (2.5)	17 (481)	88 (99)	1.9 (.9)	10 (245)	4 (93)	Hookit™ 20356	051141-28517-7

*One (1) each of the following included: 3M™ Clean Sanding Filter Bag, Filter Bag Adapter, Hose Seal

3M™ Elite Central-Vacuum-Ready Random Orbital Sanders

Easily attaches to your existing central vacuum system for efficient dust-evacuation.



Model No.	Tool Dia. Inch (mm)	Max RPM	Motor HP (W)	Orbit Dia. Inch (mm)	Airflow Rate SCFM (LPM)	Noise Level dBA (power)	Weight Pound (kg)	Length Inch (mm)	Height Inch (mm)	Pad Included	UPC
28503	3 (76)	12,000	0.28 (209)	3/16 (5)	17 (481)	72 (83)	1.8 (.8)	8 (203)	4 (93)	Hookit™ 20350	051141-28503-0
28505	3 (76)	12,000	0.28 (209)	3/32 (2.5)	17 (481)	72 (83)	1.4 (.6)	8 (201)	3 (88)	Hookit™ 20350	051141-28505-4
28561	5 (127)	12,000	0.28 (209)	3/8 (9.5)	17 (481)	73 (84)	1.9 (.9)	9 (227)	4 (93)	Hookit™ 20353	051141-28561-0
28504	5 (127)	12,000	0.28 (209)	5/16 (8)	17 (481)	73 (84)	1.9 (.9)	9 (227)	4 (93)	Hookit™ 20353	051141-28504-7
28506	5 (127)	12,000	0.28 (209)	3/16 (5)	17 (481)	73 (84)	1.8 (.8)	9 (227)	4 (93)	Hookit™ 20353	051141-28506-1
28507	5 (127)	12,000	0.28 (209)	3/32 (2.5)	17 (481)	73 (84)	1.8 (.8)	9 (227)	4 (93)	Hookit™ 20353	051141-28507-8
28560	6 (152)	12,000	0.28 (209)	3/8 (9.5)	17 (481)	76 (87)	2.0 (.9)	9 (238)	4 (93)	Hookit™ 20356	051141-28560-3
28502	6 (152)	12,000	0.28 (209)	5/16 (8)	17 (481)	76 (87)	2.0 (.9)	9 (238)	4 (93)	Hookit™ 20356	051141-28502-3
28508	6 (152)	12,000	0.28 (209)	3/16 (5)	17 (481)	76 (87)	2.0 (.9)	9 (238)	4 (93)	Hookit™ 20356	051141-28508-5
28509	6 (152)	12,000	0.28 (209)	3/32 (2.5)	17 (481)	76 (87)	1.9 (.9)	9 (238)	4 (93)	Hookit™ 20356	051141-28509-2

3M™ Random Orbital Sanders — Original Series

3M™ Self-Generated Vacuum Random Orbital Sanders*

Take dust-management to the next level with powerful self-generated vacuum tools. Featuring 3M patented Clean Sanding system with improved filter bag.



20319



20208/20327

Model No.	Tool Dia. Inch (mm)	Max RPM	Motor HP (W)	Orbit Dia. Inch (mm)	Air Flow Rate SCFM (LPM)	Noise Level dBA (power)	Weight Pound (kg)	Length Inch (mm)	Height Inch (mm)	Pad Included	UPC
20319	5 (127)	12,000	0.24 (179)	3/16 (5)	17 (481)	85 (93)	1.8 (.8)	9 (219)	3 (85)	Hookit™ 20353	051141-20319-5
20208	6 (150)	12,000	0.24 (179)	5/16 (8)	17 (481)	82 (92)	2.0 (.9)	9 (233)	3 (83)	Hookit™ 20356	051141-20208-2
20327	6 (150)	12,000	0.24 (179)	3/16 (5)	17 (481)	83 (92)	2.0 (.9)	9 (231)	3 (85)	Hookit™ 20356	051141-20327-0

*One (1) each of the following included: 3M™ Clean Sanding Filter Bag, Filter Bag Adapter, Hose Seal

3M™ Non-Vacuum Random Orbital Sanders

Powerful and popular non-vacuum tools meet or exceed highest performance standards.



20317



20324/20325

Model No.	Tool Dia. Inch (mm)	Max RPM	Motor HP (W)	Orbit Dia. Inch (mm)	Air Flow Rate SCFM (LPM)	Noise Level dBA (power)	Weight Pound (kg)	Length Inch (mm)	Height Inch (mm)	Pad Included	UPC
20317	5 (127)	12,000	0.24 (179)	3/16 (5)	17 (481)	80 (88)	1.7 (.8)	6 (150)	3 (83)	Stikit™ 20351	051141-20317-1
20324	6 (152)	12,000	0.24 (179)	5/16 (8)	17 (481)	77 (85)	1.8 (.8)	6 (164)	3 (83)	Stikit™ 20354	051141-20324-9
20325	6 (152)	12,000	0.24 (179)	3/16 (5)	17 (481)	79 (83)	1.7 (.8)	6 (162)	3 (83)	Stikit™ 20354	051141-20325-6

3M™ Orbital Sanders — Elite Series and Original Series

3M™ Elite Series Orbital Sanders

Ideal for sanding in tight areas or on vertical surfaces.



28527



28528



28529

Model No.	Vacuum	Tool Size Inch (mm)	Max OPM	Motor HP (W)	Orbit Dia. Inch (mm)	Air Flow Rate SCFM (LPM)	Noise Level dBA (power)	Weight Pound (kg)	Length Inch (mm)	Height Inch (mm)	Pad Included	UPC
28527	Non-Vac	2-3/4 x 7-3/4 (70 x 198)	10,000	0.28 (209)	1/8 (3)	17 (481)	75 (86)	2.1 (1.0)	8 (206)	4 (104)	Hookit™ 28531	051141-28527-6
28528	Central	2-3/4 x 7-3/4 (70 x 198)	10,000	0.28 (209)	1/8 (3)	17 (481)	72 (83)	2.2 (1.0)	10 (261)	4 (104)	Hookit™ 28531	051141-28528-3
28529	Self-Gen	2-3/4 x 7-3/4 (70 x 198)	10,000	0.28 (209)	1/8 (3)	17 (481)	86 (97)	2.2 (1.0)	11 (268)	4 (104)	Hookit™ 28531	051141-28529-0

3M™ Orbital Sanders

Ideal for sanding in tight areas or on vertical surfaces.



20331



20430



20431

Model No.	Vacuum	Tool Size Inch (mm)	Max OPM	Motor HP (W)	Orbit Dia. Inch (mm)	Air Flow Rate SCFM (LPM)	Noise Level dBA (power)	Weight Pound (kg)	Length Inch (mm)	Height Inch (mm)	Pad Included	UPC
20331	Non-Vac	3 x 4 (75 x 100)	10,000	0.24 (179)	1/8 (3)	17 (481)	73 (81)	1.4 (0.7)	5 (139)	3 (84)	Hookit™ 20433	051141-20331-7
20430	Central	3 x 4 (75 x 100)	10,000	0.24 (179)	1/8 (3)	17 (481)	72 (82)	1.5 (0.7)	5 (139)	3 (84)	Clean Sanding Hookit™ 20435	051141-20430-7
20431	Self-Gen	3 x 4 (75 x 100)	10,000	0.24 (179)	1/8 (3)	17 (481)	88 (93)	1.6 (0.7)	6 (142)	3 (84)	Clean Sanding Hookit™ 20435	051141-20431-4

3M™ Electric Random Orbital Sanders

Consistent performance when air supply is inadequate or mobility is needed.

- Provides significant energy cost savings vs. air-powered sanders
- Low-profile design enables increased operator control and less vibration
- Whisper-quiet operation
- Exclusive 3M™ Gripping Material and ergonomic wrist rest for increased operator comfort
- Variable speed settings — 7,000, 9,000 and 10,000 RPM — enable customized performance



3M™ Electric Random Orbital Sander Kits

Kits include 3M™ Electric Sander, 3M™ Power Supply w/AC Power Cord (PN28436), 3M™ Power Cord (PN28434) and Disc Pad (Non-Vacuum: 3M™ Stikit™ Disc Pad; Central Vacuum: 3M™ Hookit™ Clean Sanding Disc Pad). Kit includes canvas bag.

Model No.	Tool Dia. Inch (mm)	Max RPM	Motor HP (W)	Orbit Dia. Inch (mm)	Noise Level dBA (power)	Weight Pound (kg)	Length Inch (mm)	Height Inch (mm)	Pad Included	UPC
Central Vacuum										
28521	6 (150)	10,000	0.2–0.24 (149–179)	3/32 (2.5)	70 (81)	2.2 (1.0)	9 (225)	4 (97)	Hookit™ 20356	051141-28521-4
28522	6 (150)	10,000	0.2–0.24 (149–179)	3/16 (5)	70 (81)	2.2 (1.0)	9 (225)	4 (97)	Hookit™ 20356	051141-28522-1
Non-Vacuum										
28525	6 (150)	10,000	0.2–0.24 (149–179)	3/32 (2.5)	70 (81)	2.0 (0.9)	7 (185)	4 (97)	Stikit™ 20354	051141-28525-2
28526	6 (150)	10,000	0.2–0.24 (149–179)	3/16 (5)	70 (81)	2.0 (0.9)	7 (185)	4 (97)	Stikit™ 20354	051141-28526-9

Power Supply Input: 100–240 VAC, 47–63 HZ; Power Supply Output: 30 VDC, 5 Amps

3M™ Power Cords and Power Supply

Part No.	Description	UPC
28434	3M™ Power Cord, Low Voltage, 18AWG, 12 ft. (from power supply to sander)	051141-28434-7
28435	3M™ Power Cord, Extra Long, Low Voltage, 24 ft. (from power supply to sander)	051141-28435-4
28436	3M™ Power Supply with 3M™ AC Power Cord (28478)	051141-28436-1
28478	3M™ AC Power Cord, 110 volt (from wall outlet to power supply)	051141-28478-1



3M™ Mini Sanders

3M™ Elite Series Mini Orbital Sander

- Longer life vanes and improved skirt attachment system for greater durability
- Exclusive 3M™ Gripping Material cover for operator comfort
- Aluminum body for lighter weight and improved balance
- 3M™ Roloc™ Attachment System for sanding pad and integral tool hanger for increased usability
- Use with 3M™ Trizact™ Finesse-It™ Paint Repair System



Model No.	PSI	Tool Size Inch (mm)	Max RPM	Motor HP (W)	Orbit Dia. Inch (mm)	Air Flow Rate SCFM (LPM)	Noise Level dBA (power)	Weight Pound (kg)	Length Inch (mm)	Height Inch (mm)	Pad Included	UPC
28737	90	1-1/4 x 3/16	8,000	0.48 (358)	1/8 (3)	23 (651)	76 (87)	0.6 (0.3)	8 (193)	4 (104)	Roloc™ 02345 w/Stikit™ Face	051141-28737-9

3M™ Mini-Random Orbital Sander

- Ergonomically designed for operator comfort and control
- Low profile design reduces chance of tipping and undercutting
- Direct mount 3M™ Roloc™ Sanding Pad allows close proximity to the work surface
- Use with 3M™ Trizact™ Finesse-It™ Paint Repair System



Model No.	PSI	Tool Size Inch (mm)	Max RPM	Motor HP (W)	Orbit Dia. Inch (mm)	Air Flow Rate SCFM (LPM)	Noise Level dBA (power)	Weight Pound (kg)	Length Inch (mm)	Height Inch (mm)	Pad Included	UPC
20244	90	1-1/4 x 3/16	8,000	0.24 (179)	3/16 (5)	15 (425)	73 (80)	1.0 (0.5)	5 (120)	3 (85)	Roloc™ 02345 w/Stikit™ Face	051141-20244-0

3M™ Sanders, Buffers and Electric Polisher



28337/28335

3M™ Random Orbital Sander, 2-Hand

- For extra leverage and power, choose the two-handed 3M™ Random Orbital Sander
- Features a powerful 0.45 HP motor with 3/8" orbit, built-in muffler and rear exhaust

Model No.	Vacuum	Tool Dia. Inch (mm)	Max RPM	Motor HP (W)	Orbit Dia. Inch (mm)	Air Flow Rate SCFM (LPM)	Noise Level dBA (power)	Weight Pound (kg)	Length Inch (mm)	Height Inch (mm)	Clean Sanding Pad Included	UPC
28337	Central/Non-Vac	6 (150)	12,000	0.45 (336)	3/8 (9.5)	21 (594)	81 (89)	3 (1.32)	13 (328)	4 (113)	Hookit™ 20356*	051141-28337-1
28335	Self-Gen Vac	6 (150)	12,000	0.45 (336)	3/8 (9.5)	21 (594)	91 (94)	3 (1.32)	13 (328)	4 (113)	Hookit™ 20356*	051141-28335-7

*For 5" sanding using the 2-Hand Sander, use the 5" 3M™ Hookit™ D/F Disc Pad 28411

3M™ Buffers

- Available in rotary or random orbital motions and in multiple sizes
- Excellent choice for a variety of repairs on different substrates across a wide range of industries — from paint and clear coat to lacquered wood, solid surface to acrylic



Model No.	PSI	Tool Dia. Inch (mm)	Max RPM	Motor HP (W)	Orbit Dia. Inch (mm)	Air Flow Rate SCFM (LPM)	Noise Level dBA (power)	Weight Pound (kg)	Length Inch (mm)	Height Inch (mm)	Air Inlet Thread	UPC
28333	90	3 (75)	11,000	0.26 (194)	1/2 (12)	19 (538)	78 (87)	1.8 (0.8)	9 (233)	4 (99.6)	1/4" NPT	051141-28333-3
28631	90	3 (75)	3,500	0.26 (194)	Rotary	17 (481)	80 (87)	2.1 (0.9)	9 (233)	5 (114)	1/4" NPT	051141-28631-0
28392	90	5 (127)	10,000	0.45 (336)	3/8 (10)	21 (595)	77 (88)	2.9 (1.3)	13 (328)	4 (113)	1/4" NPT	051141-28392-0

3M™ Pistol Grip Buffer

- Powerful 0.45 HP motor for faster buffing
- Offset design for greater surface visibility
- Composite body for user comfort



28354

Model No.	PSI	Tool Dia. Inch (mm)	Max RPM	Motor HP (W)	Orbit Dia. Inch (mm)	Air Flow Rate SCFM (LPM)	Noise Level dBA (power)	Weight Pound (kg)	Length Inch (mm)	Height Inch (mm)	Air Inlet Thread	UPC
28354	90	3 (75)	2,200	0.45 (336)	Rotary	22 (683)	80 (88)	1.8 (0.8)	5 (132)	5 (136)	1/4" NPT	051141-28354-8

3M™ Palm Buffer

- Powerful, lightweight tool designed to fit in the palm of the operator's hand
- Aggressive 1/2-inch orbit for faster buffing or polishing on the clearcoat
- Engineered for maximum operator comfort



28769

Model No.	PSI	Tool Dia. Inch (mm)	Max RPM	Motor HP (W)	Orbit Dia. Inch (mm)	Air Flow Rate SCFM (LPM)	Noise Level dBA (power)	Weight Pound (kg)	Length Inch (mm)	Height Inch (mm)	Air Inlet Thread	UPC
28769	90	3 (77)	12,000	0.28 (209)	1/2 (12)	17 (481)	79 (90)	1.5 (0.7)	5.8 (147)	3.6 (92.5)	1/4" NPT	051141-28769-0

3M™ Electric Variable Speed Polisher

Designed to compound/buff/polish various substrates including but not limited to automotive paint, marine finishes, fiberglass gel coat, acrylics, etc.



28391

Model No.	VAC	Tool Dia. Inch (mm)	Max RPM	Motor Amp	Shaft Size	Weight Pound (kg)	Length Inch (mm)	Height Inch (mm)	UPC
28391	120	7 (178)	3,000	11	5/8-11 EXT	6.6 (3.0)	17 (432)	4 (111)	051141-28391-3

3M™ Sander/Buffer



28773

Model No.	PSI	Tool Dia. Inch (mm)	Max RPM	Motor HP (W)	Orbit Dia. Inch (mm)	Air Flow Rate SCFM (LPM)	Noise Level dBA (power)	Weight Pound (kg)	Length Inch (mm)	Height Inch (mm)	Air Inlet Thread	UPC
28773	90	5-6 (127-152)	3,500	1 (744)	Rotary	37 (1,048)	89 (89)	3.3 (1.5)	10 (254)	4 (95)	1/4" NPT	051141-28773-7

3M™ Die Grinders

NEW! 3M™ Die Grinders — 0.3 HP (224W)

- Ideal for light-duty applications such as deburring, blending, finishing and polishing in intricate and hard-to-reach areas
- Exclusive 3M™ Gripping Material reduces vibration and provides a more secure grip.



Model No.	Max RPM	Air Flow Rate SCFM (LPM)	Noise Level dBA (power)	Weight Pound (kg)	Length Inch (mm)	Height Inch (mm)	Air Inlet Thread	Collet Size	UPC
NEW! 28630	25,000	17 (481)	86 (98)	1.4 (0.6)	10 (248)	1 (35)	1/4" NPT	1/4" [†]	051141-28630-3
NEW! 28629	25,000	17 (481)	78 (90)	0.9 (0.4)	6 (152)	1 (35)	1/4" NPT	1/4" [†]	051141-28629-7
NEW! 28628	18,000	17 (481)	80 (92)	1.5 (0.7)	11 (267)	1 (35)	1/4" NPT	1/4" [†]	051141-28628-0
NEW! 28627	18,000	17 (481)	79 (91)	1.2 (0.5)	7 (184)	1 (35)	1/4" NPT	1/4" [†]	051141-28627-3

[†]Includes 1/8" collet insert (PN55772)

NEW! 3M™ Die Grinders — 0.5 HP (372W)

- Ideal for medium-duty applications such as polishing, buffing, shaping and deburring
- Exclusive 3M™ Gripping Material reduces vibration and provides a more secure grip



Model No.	Max RPM	Air Flow Rate SCFM (LPM)	Noise Level dBA (power)	Weight Pound (kg)	Length Inch (mm)	Height Inch (mm)	Air Inlet Thread	Collet Size	UPC
NEW! 28330	18,000	26 (736)	87 (99)	1.1 (0.5)	7 (175)	3 (70)	1/4" NPT	1/4" [†]	051141-28330-2
NEW! 28331	18,000*	26 (736)	87 (99)	1.5 (0.7)	11 (270)	3 (70)	1/4" NPT	1/4" [†]	051141-28331-9
NEW! 28332	4,000	26 (736)	87 (99)	1.6 (0.7)	9 (200)	3 (70)	1/4" NPT	1/4" [†]	051141-28332-6

*With extension

[†]Available in metric collet

3M™ Die Grinders — 1 HP (744W)

- Excellent for big jobs such as weld or stock removal
- Exclusive 3M™ Gripping Material reduces vibration and provides a more secure grip



Model No.	Max RPM	Air Flow Rate SCFM (LPM)	Noise Level dBA (power)	Weight Pound (kg)	Length Inch (mm)	Height Inch (mm)	Air Inlet Thread	Collet Size	UPC
20237	20,000	37 (1,048)	84 (95)	1.7 (0.8)	8 (197)	3 (73)	1/4" NPT	1/4"	051141-20237-2
20238	18,000	37 (1,048)	84 (95)	1.7 (0.8)	8 (197)	3 (73)	1/4" NPT	1/4"	051141-20238-9
28770	18,000	37 (1,048)	84 (95)	2.6 (1.2)	13 (318)	3 (73)	1/4" NPT	1/4"	051141-28770-6
20239	12,000	37 (1,048)	84 (95)	2.1 (0.9)	10 (254)	3 (81)	1/4" NPT	1/4"	051141-20239-6
20240	8,000	37 (1,048)	84 (95)	2.1 (0.9)	10 (254)	3 (81)	1/4" NPT	1/4"	051141-20240-2

Collet Insert Availability for 3M™ Die Grinders



Tool Model No.	HP	RPM	Length	Collet Insert Size and Part Number								
				1/8" (06573)	1/8" (55772)	3/16" (06574)	1/4" (06575)	1/4" (55752)	3/8" (06545)	3 mm (06576)	6 mm (06577)	8 mm (06546)
28630	0.3	25,000	Extended		■				■			
28629	0.3	25,000	Regular		■				■			
28628	0.3	18,000	Extended		■				■			
28627	0.3	18,000	Regular		■				■			
28330	0.5	18,000	Regular	■		■	■		■	■	■	■
28331	0.5	18,000	Extended	■		■	■		■	■	■	■
28332	0.5	4,000	Regular	■		■	■		■	■	■	■
20237	1	20,000	Regular	■		■	■		■	■	■	■
20238	1	18,000	Regular	■		■	■		■	■	■	■
28770	1	18,000	Extended	■		■	■		■	■	■	■
20239	1	12,000	Regular	■		■	■		■	■	■	■
20240	1	8,000	Regular	■		■	■		■	■	■	■

3M™ Disc Sanders

3M™ Disc Sanders

- 3M™ Gripping Material for reduced vibration and a secure grip with less effort
- 97° head for decreased wrist strain
- Easy-handling, compact design for less vibration
- 3M™ Roloc™ Disc Pads can directly mount to sander without collet
- 1/4" collet included with all 2" and 3" disc sanders



Model No.	Tool Dia. Inch (mm)	Motor HP (W)	Max RPM	Air Flow Rate SCFM (LPM)	Noise Level dBA (power)	Weight Pound (kg)	Length Inch (mm)	Height Inch (mm)	Air Inlet Thread	Collet Size	UPC
NEW! 28341	2 (51)	0.3 (224)	20,000	17 (481)	81 (92)	1.1 (0.5)	6 (150)	3 (63)	1/4" NPT	1/4"†	051141-28341-8
NEW! 28328	2-3 (51-76)	0.3 (224)	12,000	17 (481)	81 (92)	1.1 (0.5)	7 (172)	3 (64)	1/4" NPT	1/4"†	051141-28328-9
NEW! 20231	2 (51)	0.5 (372)	20,000	26 (736)	89 (101)	1.3 (0.6)	7 (172)	3 (70)	1/4" NPT	1/4"†	051141-20231-0
NEW! 28329	2-3 (51-76)	0.5 (372)	12,000	26 (736)	89 (101)	1.3 (0.6)	7 (172)	3 (70)	1/4" NPT	1/4"†	051141-28329-6
20232	2-3 (51-76)	1 (744)	15,000	37 (1,048)	84 (95)	2.0 (0.9)	8 (210)	3 (83)	1/4" NPT	1/4"	051141-20232-7
28408	4-5 (100-127)	1 (744)	12,000	37 (1,048)	84 (95)	3.1 (1.4)	8 (210)	4 (107)	3/8" NPT*	1/4"	051141-28408-8
28622	4-5 (100-127)	1 (744)	12,000	37 (1,048)	84 (95)	4.0 (1.8)	12 (292)	5 (119)	3/8" NPT*	1/4"	051141-28622-8
NEW! 28825	4-1/2-5 (114.3-127)	1.5 (1,120)	12,000	40 (1,133)	90 (82)	4.9 (2.2)	11 (279)	4 (102)	1/2" FNPT	1/4"	051141-28825-3

*Includes 3/8" to 1/4" reducer

†Available in metric collet

3M™ Pistol Grip Disc Sander

- Lightweight, low cost alternative to production tools for customers who need a tool for spot duty or intermittent use
- Excellent balance and generates less noise and vibration than other disc sanders
- Durable composite body for ergonomic feel
- Dual mount feature allows user to switch between direct mount (for maximum control) and collet mount (for extended reach); 1/4" collet included



Model No.	PSI	Tool Dia. Inch (mm)	Max RPM	Motor HP (W)	Orbit Dia. Inch (mm)	Air Flow Rate SCFM (LPM)	Noise Level dBA (power)	Weight Pound (kg)	Length Inch (mm)	Height Inch (mm)	Thread Size	UPC
28547	90	3 (76)	15,000	0.45 (336)	Rotary	23 (651)	74 (85)	1.8 (0.8)	5 (122)	5 (136)	1/4-20 EXT	051141-28547-4

3M™ Pistol Grip Random Orbital Disc Sander

- Primarily intended for sanding in the automotive market
- Powerful, lightweight tool with excellent balance
- Durable composite body for ergonomic feel
- Pistol grip design allows you to sand in hard-to-reach areas such as those found in door jambs, bumpers, headlight lens, etc. with ease



Model No.	PSI	Tool Dia. Inch (mm)	Max RPM	Motor HP (W)	Orbit Dia. Inch (mm)	Air Flow Rate SCFM (LPM)	Noise Level dBA (power)	Weight Pound (kg)	Length Inch (mm)	Height Inch (mm)	Thread Size	UPC
28353*	90	3 (76)	15,000	0.45 (336)	1/8 (3)	22 (623)	75 (82)	1.8 (0.8)	5 (122)	5 (136)	5/16-24 EXT	051141-28353-1

*Replacement Pad PN20427

Collet Insert Availability for 3M™ Disc Sanders



Tool Model No.	HP	RPM	Length	Collet Insert Size and Part Number				
				1/4" (06528)	1/8" (06529)	3/16" (06530)	3 mm (06540)	6 mm (06541)
28341	0.3	20,000	Regular	■	■	■	■	■
28328	0.3	12,000	Regular	■	■	■	■	■
20231	0.5	20,000	Regular	■	■	■	■	■
28329	0.5	12,000	Regular	■	■	■	■	■
20232	1	15,000	Regular	■	■	■	■	■
28408	1	12,000	Regular	■	■	■	■	■
28622	1	12,000	Extended	■	■	■	■	■



3M™ Grinders — Type 27

3M™ Grinders — Type 27

- Steel gear heads for added durability under high force applications
- Thermally balanced motor helps stop tool from getting cold to the touch
- 3M™ Gripping Material for reduced vibration and a secure grip with less effort
- Repositionable steel guards for better visibility



Model No.	Tool Dia. Inch (mm)	Motor HP (W)	Max RPM	Air Flow Rate SCFM (LPM)	Noise Level dBA (power)	Weight Pound (kg)	Length Inch (mm)	Height Inch (mm)	Air Inlet Thread	Thread Size	UPC
28403	4 (100)	1 (744)	12,000	37 (1,048)	86 (98)	2.7 (1.2)	9 (216)	5 (114)	3/8" NPT*	3/8-24 EXT	051141-28403-3
28413	4 (100)	1 (744)	12,000	37 (1,048)	91 (103)	2.6 (1.2)	12 (292)	5 (114)	3/8" NPT*	3/8-24 EXT	051141-28413-2
28405	4-1/2 (114.3)	1 (744)	12,000	37 (1,048)	85 (99)	3.9 (1.8)	9 (216)	5 (119)	3/8" NPT*	5/8-11 EXT	051141-28405-7
28414	4-1/2 (114.3)	1 (744)	12,000	37 (1,048)	86 (95)	4.0 (1.8)	12 (292)	5 (119)	3/8" NPT*	5/8-11 EXT	051141-28414-9
NEW! 28824	4-1/2-5 (114.3-127)	1.5 (1,120)	12,000	40 (1,133)	84 (92)	5.3 (2.4)	11 (279)	4 (105)	1/2" FNPT	5/8-11 EXT	051141-28824-6

*Includes 3/8" to 1/4" reducer

Optional Grinder Guards

Optional guard allows 4" grinder to run larger, thicker 4-1/2" fibre and flap discs.



Model No.	Size	For Use With Tool	Required Accessories	UPC
55106	4-1/2"	3M™ Grinders — 4" (Model No. 28403; 28413)	Accessories with 3/8-24 INT threads	051141-29403-3
28632	5"	3M™ Disc Sanders, 1 HP — 4"-5" (Model No. 28408)	Accessories with 5/8-11 INT threads	051141-28632-7
NEW! 54062	4-1/2" Standard	3M™ Grinders, 1.5 HP — 4.5"-5" (Model No. 28824)	Accessories with 5/8-11 INT threads	051141-54062-7
NEW! 54063	4-1/2" Jumbo	3M™ Grinders, 1.5 HP — 4.5"-5" (Model No. 28824)	Accessories with 5/8-11 INT threads	051141-54063-4
NEW! 54064	4-1/2"	3M™ Cut-Off Wheels, 1.5 HP — 4.5"-5" (Model No. 28826)	Accessories with 5/8-11 INT threads	051141-54064-1
NEW! 54065	5" Standard	3M™ Grinder,s 1.5 HP — 4.5"-5" (Model No. 28824)	Accessories with 5/8-11 INT threads	051141-54065-8
NEW! 54066	5" Jumbo	3M™ Grinders, 1.5 HP — 4.5"-5" (Model No. 28824)	Accessories with 5/8-11 INT threads	051141-54066-5
NEW! 54067	5"	3M™ Cut-Off Wheels, 1.5 HP — 4.5"-5" (Model No. 28826)	Accessories with 5/8-11 INT threads	051141-54067-2

* See page 22 for other appropriate accessories.

3M™ Cut-Off Wheel Tools

3M™ Cut-Off Wheel Tools

- Easily cuts through everything from standard rebar to oversized bolts
- Exclusive 3M™ Gripping Material for added comfort
- Extended model provides greater versatility and control with right angle head and repositionable guard



Model No.	Tool Dia. Inch (mm)	Motor HP (W)	Max RPM	Air Flow Rate SCFM (LPM)	Noise Level dBA (power)	Weight Pound (kg)	Length Inch (mm)	Height Inch (mm)	Air Inlet Thread	UPC
20233	3 (76)	1 (744)	25,000	37 (1,048)	84 (96)	2.1 (1.0)	8 (197)	3 (76)	1/4" NPT	051141-20233-4
20234	4 (100)	1 (744)	20,000	37 (1,048)	84 (96)	2.3 (1.0)	8 (197)	3 (83)	3/8" NPT	051141-20234-1
28771†	4 (100)	1 (744)	19,000	37 (1,048)	84 (96)	2.3 (1.0)	8 (197)	3 (83)	3/8" NPT	051141-28771-3
20235	5 (125)	1 (744)	12,000	37 (1,048)	84 (96)	3.5 (1.6)	9 (222)	5 (133)	3/8" NPT	051141-20235-8
20236	6 (152)	1 (744)	10,000	37 (1,048)	84 (96)	3.7 (1.7)	9 (222)	5 (133)	3/8" NPT	051141-20236-5
28407	4 (100)	1 (744)	18,000	37 (1,048)	86 (97)	2.3 (1.0)	12 (292)	4 (108)	3/8" NPT*	051141-28407-1
NEW! 28826	4-1/2-5 (115-125)	1.5 (1,120)	12,000	40 (1,133)	84 (92)	5.5 (2.5)	11 (279)	4 (111)	1/2" FNPT	051141-28826-0

†Replaces Model No. 20234

*Includes 3/8" to 1/4" reducer

Replacement Parts for 1.5 HP Power Tools

3M™ Wrench, Spanner



Part No.	Size	Description	UPC	Case Quantity
54105	4mm x 30mm B.C.	Replacement Part for 3M™ Sander/Grinder, 1.5 HP. Used to tighten/loosen flange nut.	051141-54105-1	1

Gear Oil

Part No.	Size	Description	UPC	Case Quantity
28827	4 oz.	Replacement Part for 3M™ Sander/Grinder, 1.5 HP. Use to lubricate gears.	051141-28827-7	6



3M™ Rebuild Kits

Part No.	Description	UPC	Case Quantity
54106	Special tools needed to disassemble and reassemble 1.5 HP 3M Power Tools	051141-54106-8	1
54107	Replacement parts most likely needed to rebuild the 1.5 HP 3M Power Tools	051141-54107-5	1

3M™ Inline Sanders

3M™ Inline Sanders — 1 HP (744W)

- Generate straight line scratches for finishing stainless steel and other metals
- Use with inflatable or slotted wheel accessories and many other wheel products



Model No.	Max RPM	Air Flow Rate SCFM (LPM)	Noise Level dBA (power)	Weight Pound (kg)	Length Inch (mm)	Air Inlet Thread	Shaft Size	UPC
28338	1,600	37 (1,048)	83 (95)	3.3 (1.5)	10 (251)	1/4" NPT	5/8"-11 EXT	051141-28338-8
28339	3,500	37 (1,048)	85 (97)	2.6 (1.2)	9 (216)	1/4" NPT	5/8"-11 EXT	051141-28339-5



3M™ Rubber Slotted Expander Wheels

Part No.	Size	Description	UPC
Use with 3M™ Inline Sanders			
77722	3" x 3" x 5/8-11 INT	Rubber slotted expander wheel for use with 3" x 3" bands	051144-77722-8
28348	5" x 3-1/2" x 5/8" AH	Rubber slotted expander wheel for use with 3-1/2" W x 15-1/2" L belts	051141-28348-7
28349	3-2/5" x 3" x 5/8" AH	Rubber slotted expander wheel for use with 3" W x 10-11/16" L belts	051141-28349-4
28718	5" x 3-1/2" x 1" AH	Rubber slotted expander wheel for use with 3-1/2" W x 15-1/2" L belts	051141-28718-8

3M™ Wheel Adapter Kits* Fits wheels with 5/8" or 1" AH

Part No.	Thread Size	Description	UPC	Case Quantity
45038	5/8-11 INT x 5/8-11 EXT	For use with Expander Wheels	051144-45038-1	1
04019	5/8-11 INT x 5/8-11 EXT	For use with Scotch-Brite™ Wheels	048011-04019-6	1
28419	5/8-11 INT x 1/2-20 EXT	For use with 1/2" Center Hole Wheels	051141-28419-4	1



*Kits include spacers, flanges and end nuts to mount expander wheels and other Scotch-Brite™ Wheels.

3M™ Match and Finish Sander

3M™ Match and Finish Sander

- Easy-to-operate tool for generating straight line finishes for stainless steel and other metals
- Use with Scotch-Brite™ Match and Finish Flap Brushes and 3M™ Rubber Slotted Expander Wheels



Model No.	Max RPM	Motor HP (W)	Air Flow Rate SCFM (LPM)	Noise Level dBA (power)	Weight Pound (kg)	Length Inch (mm)	Air Inlet Thread	Shaft Size	UPC
28659	3,500	1 (744)	37 (1,048)	89 (89)	4.6 (2.1)	14 (343)	1/4" NPT	5/8"-11 EXT	051141-28659-4

3M™ Rubber Slotted Expander Wheel and Adapter Kit



Part No.	Size	Description	UPC
Use with 3M™ Match and Finish Sander			
28718	5" x 3-1/2" x 1" AH	Rubber slotted expander wheel for use with 3-1/2" x 15-1/2" belts	051141-28718-8
28719	1" x 5/8-11 INT	Wheel Adapter Kit to mount 28718 wheel on 3M™ Match and Finish Sander	051141-28719-5

3M™ File Belt Sander

3M™ File Belt Sander and Kit*

- Great for deburring, cleaning, blending and finishing in tight or hard-to-reach areas
- Balanced weight distribution and 3M™ Gripping Material for improved ergonomics and reduced wrist strain
- 360° rotatable housing and handle for the ultimate in versatility
- Attached belt cover won't fall off during belt changes
- Optimized belt speed for 3M™ Abrasive Belts and Scotch-Brite™ Belts









Model No.	Motor	Max RPM	Belt Speed SFPM (SMM)	Air Flow Rate SCFM (LPM)	Noise Level dBA (power)	Weight Pound (kg)	Length Inch (mm)	Height Inch (mm)	Width Inch (mm)	UPC
28366	0.6 HP	22,000	4990 (1521)	28 (793)	81 (90)	2.8 (1.3)	15 (370)	3 (75)	6 (151)	051141-28366-1
28367	Kit includes Molded Case, File Belt Sander (PN28366) and two Attachment Arms (PNs 28368, 28370)*									051141-28367-8

*For additional file belt sander accessories, see page 23.



3M™ File Belt Sander Attachment Arms

Part No.	Use With Belt Size	Description	UPC	Case Quantity
 28368	1/2" x 18"	Standard Style: Standard arm included with 3M™ File Belt Sander (PN28366). Sand with contact wheel or platen.	051141-28368-5	1
 28369	1/2" x 18"	Thin Style: Thinner than standard arm. Sand with contact wheel or platen.	051141-28369-2	1
 28370	1/8" x 18" 1/4" x 18" 1/2" x 18"	Corners Style: Sand corners and grooves with contact wheel. Accommodates three belt widths.	051141-28370-8	1
 28371	5/8" x 18" 3/4" x 18"	Thick Standard Style: Thicker than standard arm. Sand with contact wheel or platen. Accommodates two belt widths.	051141-28371-5	1
 28372	1/8" x 18" 1/4" x 18"	Corners Style: Sand corners and grooves with contact wheel. Accommodates two belt widths.	051141-28372-2	1
 28374	1/2" x 18"	Curved Arm: Unique curved arm used for blending flat areas. Sand with contact wheel or platen.	051141-28374-6	1
 28375	1/4" x 24" 1/2" x 24"	Vessel Arm: Unique large arm used for blending weld seams. Sand with 4" contact wheel. Includes tracking/control knob. Accommodates two belt widths.	051141-28375-3	1

3M™ File Belt Sander Extension

Part No.	Description	UPC	Case Quantity
 28376	Use to extend arms to 24" length. Can be used with same attachment arm used for 18" length arms.	051141-28376-0	1



Orbital/Random Orbital Sander Accessories

How to Assemble Self-Generated and Central Vacuum Sanding Systems

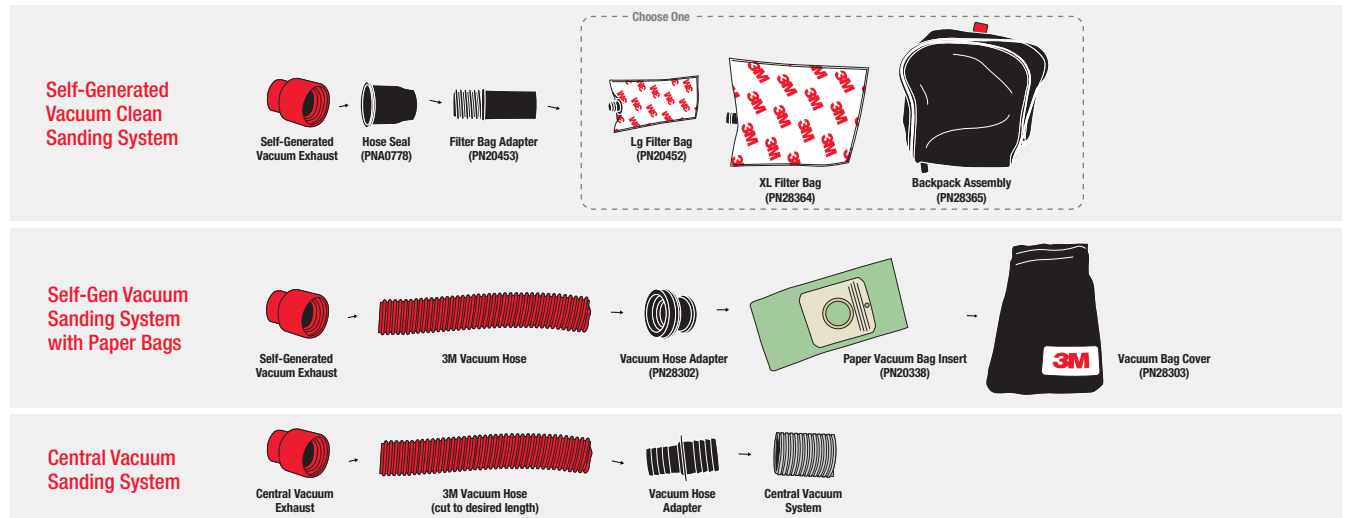

3M™ Clean Sanding Filter Bags and Adapters

Part No.	Description	UPC	MOQ
20452	Large Filter Bag — HEPA-rated (holds up to 0.5 lbs.)	051141-20452-9	50
28364	Extra-Large Filter Bag — HEPA-rated (holds up to 3 lbs.)	051141-28364-7	20
28365	Backpack Assembly (holds PN28364)	051141-28365-4	1
28383	Filter Bag End Cap — 1" Diameter	051141-28383-8	1
20453	Filter Bag Adapter — 1" EXT Hose Thread x 1" Diameter	051141-20453-6	10
A0778	Hose Seal	051115-28146-4	1



3M™ Paper Vacuum Bags and Adapters

Part No.	Item	Description	Size	UPC	MOQ
20338	Paper Vacuum Bag Inserts, Green	Collects dust when used with Self-Gen Vacuum Sander	1" INT	051141-20338-6	50
28303	Vacuum Bag Cover	Holds and protects paper vacuum bag inserts (PN20338)	9" x 20"	051141-28303-6	1
28302	Vacuum Hose Adapter	Connects 1" EXT vacuum hose to paper vacuum inserts (PN20338)	1" INT	051141-28302-9	1



3M™ Vacuum Hoses

Part No.	Item	Inner Dia.	Length	Thread	UPC	MOQ
28730	3M™ Vacuum Hose Anti-Static	1"	4 ft.	1" EXT	051141-28730-0	1
28301	3M™ Vacuum Hose	1"	6 ft.	1" EXT	051141-28301-2	1
28393	3M™ Vacuum Hose	1"	60 ft.	1" EXT	051141-28393-7	1



3M™ Vacuum Hose Adapters

Part No.	Item	End 1	End 2	UPC	MOQ
30442	3M™ Vacuum Hose Adapter	1" INT Thread	1" INT Thread	051141-30442-7	1
20340	3M™ Vacuum Hose Adapter	1" INT Thread	1-1/4" INT Thread	051141-20340-9	1
28304	3M™ Vacuum Hose Adapter	1" EXT Thread	1" Push-On	051141-28304-3	1
30324	3M™ Vacuum Hose Adapter	1" INT Thread	3/4" Push-On	051141-30324-6	1
20341	3M™ Vacuum Hose Adapter	1" INT Thread	1-1/2" Push-On	051141-20341-6	1
30441	3M™ Vacuum Hose Adapter	1" Push-On	1-1/4" Push-On	051141-30441-0	1
30440	3M™ Vacuum Hose Adapter	1" Push-On	1-1/2" Push-On	051141-30440-3	1
30439	3M™ Vacuum Hose Adapter	1" Push-On	2" Push-On	051141-30439-7	1



Scotch™ 48 Thread Sealant and Lubricant Tape

Part No.	Description	Size	UPC	MOQ
06195	Seals and lubricates threaded connections	1/2" x 260"	054007-06195-3	12



Orbital/Random Orbital Sander Accessories

3M™ Random Orbital Sander Grips — Elite and Original Series

Part No.	Sander Series	Size	Diameter	UPC
55204	Elite Series	Small	2-1/2"	051141-55204-0
55205	Elite Series	Medium	2-3/4" (Standard on Tool)	051141-55205-7
55206	Elite Series	Large	3"	051141-55206-4
20342	Original Series	Small	2-1/2"	051141-20342-3
20343	Original Series	Medium	2-3/4" (Standard on Tool)	051141-20343-0
20344	Original Series	Large	3"	051141-20344-7



3M™ Orbital/Random Orbital Sander Drop In Motors



Part No.	Tool Size Inch (mm)	Orbit Diameter Inch (mm)	Description	UPC	MOQ
28318	1-1/4 (32)	3/16 (5)	Mini	051141-28318-0	1
30445	3 (76)	1/2 (12)	for Original ROS	051141-30445-8	1
20216	3 (76)	3/32 (2.5)	for Original ROS	051141-20216-7	1
20217	3 (76)	3/16 (5)	for Original ROS	051141-20217-4	1
20218	5 (127)	3/32 (2.5)	for Original ROS	051141-20218-1	1
01811	5 (127)	3/16 (5)	for Original ROS	051122-01811-4	1
20256	5 (127)	5/16 (8)	for Original ROS	051141-20256-3	1
01812	6 (150)	3/32 (2.5)	for Original ROS	051122-01812-1	1
20221	6 (150)	3/16 (5)	for Original ROS	051141-20221-1	1
20222	6 (150)	5/16 (8)	for Original ROS	051141-20222-8	1
30443	6 (150)	3/16 (5)	Two-Hand	051141-30443-4	1
30444	6 (150)	3/8 (10)	Two-Hand	051141-30444-1	1
20223	3 x 4 (76 x 100)	1/8 (3.2)	for Original ROS	051141-20223-5	1
55434	5 (127)	3/32 (2.5)	for Electric ROS	051141-55434-1	1
55435	5 (127)	3/16 (5)	for Electric ROS	051141-55435-8	1
55436	6 (150)	3/32 (2.5)	for Electric ROS	051141-55436-5	1
55437	6 (150)	3/16 (5)	for Electric ROS	051141-55437-2	1
28605	3 (76)	3/32 (2.5)	for Elite ROS	051141-28605-1	1
28606	3 (76)	3/32 (2.5)	for Elite ROS	051141-28606-8	1
28607	5 (127)	3/32 (2.5)	for Elite ROS	051141-28607-5	1
28608	5 (127)	3/16 (5)	for Elite ROS	051141-28608-2	1
28609	5 (127)	5/16 (8)	for Elite ROS	051141-28609-9	1
28610	5 (127)	3/8 (10)	for Elite ROS	051141-28610-5	1
28611	6 (150)	3/32 (2.5)	for Elite ROS	051141-28611-2	1
28612	6 (150)	3/16 (5)	for Elite ROS	051141-28612-9	1
28613	6 (150)	5/16 (8)	for Elite ROS	051141-28613-6	1
28614	6 (150)	3/8 (10)	for Elite ROS	051141-28614-3	1

Orbital/Random Orbital Sander Accessories

3M™ Service Tool Kit

Part No.	Description	UPC	MOQ
20215	Contains all of the special tools needed to disassemble and reassemble the 3M™ Orbital and Random Orbital Sanders	051141-20215-0	1



3M™ Air Line Extensions — 300 PSI Rated

Part No.	Inside Diameter	Length	Description	Air Inlet Thread	UPC	MOQ
25119	3/8"	5"	Mini	1/4" NPT	051141-25119-6	10
20209	3/8"	4 ft.	—	1/4" NPT	051141-20209-9	1
55180	—	—	Swivel Quick Change Connector	1/4" NPT EXT	051141-55180-7	1



3M™ Air Tool and Compressor Lubricants

Part No.	Size	Description	UPC	MOQ
20466	Quart*	Air Tool and Compressor Lubricant	051141-20466-6	12
20467	Gallon*	Air Tool and Compressor Lubricant	051141-20467-3	4
20451	4 fl. oz. (118mL)	Air Tool Lubricant	051141-20451-2	12
28828	1 fl. oz.	Air Tool and Compressor Lubricant	051141-28828-4	24



*Available as special order, ships within 4 days.

3M™ Power Cords and Power Supply

Part No.	Description	UPC
28434	3M™ Power Cord, Low Voltage, 18AWG, 12 ft. (from power supply to sander)	051141-28434-7
28435	3M™ Power Cord, Extra Long, Low Voltage, 24 ft. (from power supply to sander)	051141-28435-4
28436	3M™ Power Supply with 3M™ AC Power Cord (28478)	051141-28436-1
28478	3M™ AC Power Cord, 110 volt (from wall outlet to power supply)	051141-28478-1



3M™ Hookit™ D/F Disc Pads (Vacuum)

Part No.	Max RPM	Max OPM	Diameter Inch (mm)	Thread Size	# of Holes	Density Rating	Face Color	Hook Type	UPC	MOQ
Standard Profile Disc Pads (Medium)										
LB 82659	12,000	12,000	5 (125)	5/16–24 EXT	5	Medium	Yellow	1	051144-82659-9	10
LB 28411*	12,000	12,000	5 (125)	5/16–24 EXT	5	Medium	Yellow	1	051141-28411-8	10
LB 05876	12,000	12,000	6 (152)	5/16–24 EXT	7	Medium	Yellow	1	051131-05876-7	1
Low Profile Finishing Disc Pads (Soft)										
LB 77856	12,000	12,000	5 (125)	5/16–24 EXT	5	Soft	Yellow	1	051144-77856-0	10



*5" backup pad for 6" Random Orbital Sander

LB = Large Buy Available

Orbital/Random Orbital Sander Accessories

3M™ Hookit™ Clean Sanding Disc Pads

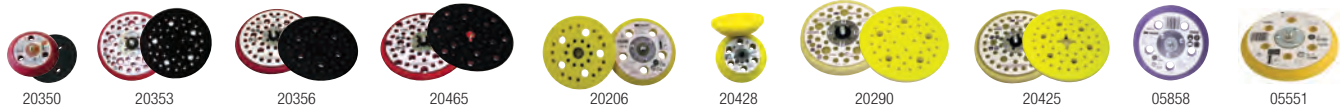

Part No.	Max RPM	Max OPM	Diameter Inch (mm)	Ctr. Hole Dia. Inch	Thread Size	# of Holes	Density Rating	Hook Type	UPC	MOQ
Low Profile Disc Pads (Firm)										
20350	15,000	15,000	3 (76)	—	1/4-20 EXT	3	Firm	2	051141-20350-8	10
LB 20353	12,000	12,000	5 (125)	—	5/16-24 EXT	44	Firm	2	051141-20353-9	10
LB 20356	12,000	12,000	6 (152)	—	5/16-24 EXT	52	Firm	2	051141-20356-0	10
LB 20465	12,000	12,000	6 (152)	5/8	5/16-24 EXT	49	Firm	2	051141-20465-9	10
Standard Profile Disc Pads (Medium)										
LB 20206	12,000	12,000	5 (125)	3/4	5/16-24 EXT	31	Medium	1	051141-20206-8	10
Low Profile Finishing Disc Pads (Soft)										
20428	12,000	12,000	3 (76)	—	1/4-20 EXT	6	Soft	1	051141-20428-4	10
LB 20290	12,000	12,000	5 (125)	—	5/16-24 EXT	44	Soft	1	051141-20290-7	10
LB 20425	10,000	12,000	6 (152)	5/8	5/16-24 EXT	52	Soft	1	051141-20425-3	10
Painter's Pads										
05858	12,000	12,000	5 (125)	3/4	5/16-24 EXT	31	Soft	1	051131-05858-3	1
05551	12,000	12,000	6 (152)	3/4	5/16-24 EXT	25	Soft	1	051131-05551-3	1

3M™ Hookit™ Clean Sanding Interface Pads and Hook Savers also available. See 3M™ Accessories Catalog.

3M™ Hookit™ Clean Sanding Disc Pad Hook Savers



Part No.	Max RPM	Max OPM	Diameter Inch (mm)	Ctr. Hole Dia. Inch	Face Color	# of Holes	Use With	Hook Type	UPC	MOQ
28326	15,000	15,000	3 (76)	—	Black	3	PN20350	2	051141-28326-5	20
20444	12,000	12,000	5 (125)	—	Black	44	PN20353	2	051141-20444-4	20
20443	12,000	12,000	5 (125)	3/4	Black	31	PN20206	2	051141-20443-7	20
20446	12,000	12,000	6 (152)	—	Black	52	PN20356	2	051141-20446-8	20
20445	12,000	12,000	6 (152)	3/4	Black	25	PN05865	2	051141-20445-1	20

3M™ Hookit™ Disc Pads



Part No.	Max RPM	Max OPM	Diameter Inch (mm)	Thread Size	Density Rating	Face Color	Hook Type	UPC	MOQ
Low Profile Disc Pads (Firm)									
LB 20352	12,000	12,000	5 (125)	5/16-24 EXT	Firm	Black	2	051141-20352-2	1
LB 20355	12,000	12,000	6 (152)	5/16-24 EXT	Firm	Black	2	051141-20355-3	10
Standard Profile Disc Pads (Medium)									
LB 85105	12,000	—	5 (125)	5/8-11 INT	Medium	Yellow	1	051144-85105-8	1
LB 85096	12,000	—	5 (125)	5/8-11 INT	Medium	Yellow	1	051144-85096-9	10
LB 05775	12,000	12,000	5 (125)	5/16-24 EXT	Medium	Yellow	1	051131-05775-3	1
LB 70138	12,000	12,000	6 (152)	5/16-24 EXT	Medium	Yellow	1	051141-28209-6	1
Low Profile Finishing Disc Pads (Soft)									
LB 77855	12,000	12,000	5 (125)	5/16-24 EXT	Soft	Yellow	1	051144-77855-3	10

LB = Large Buy Available

Orbital/Random Orbital Sander Accessories

3M™ Hookit™ Sheet Pads



Part No.	Max OPM	Size	Thickness	# of Holes	Density Rating	Hook Type	UPC	MOQ
20433	10,000	3" x 4"	1/2"	—	Medium	1	051141-20433-8	10
Clean Sanding								
20435	10,000	3" x 4"	1/2"	33	Medium	1	051141-20435-2	10
28531	10,000	70mm x 198mm	12.7mm	33	Medium	1	051141-28531-3	5

3M™ Hookit™ Clean Sanding Pad Hook Saver



Part No.	Max OPM	Size	Face Color	# of Holes	Hook Type	UPC	MOQ
28325	12,000	3" x 4"	Black	33	2	051141-28325-8	20

3M™ Stikit™ D/F Disc Pads (Vacuum)



Part No.	Max RPM	Max OPM	Diameter Inch (mm)	Thread Size	# of Holes	Density Rating	Face Color	UPC	MOQ
Low Profile Disc Pads (Firm)									
LB 20442	12,000	12,000	5 (125)	5/16–24 EXT	5	Firm	Blue	051141-20442-0	1
LB 20454	12,000	12,000	6 (152)	5/16–24 EXT	6	Firm	Blue	051141-20454-3	1
Standard Profile Disc Pads (Medium)									
LB 45217	10,000	12,000	5 (125)	5/16–24 EXT	5	Medium	Blue	051144-45217-0	10
LB 45218	10,000	12,000	6 (152)	5/16–24 EXT	6	Medium	Blue	051144-45218-7	10
Low Profile Finishing Disc Pads (Soft)									
LB 05645	12,000	12,000	5 (125)	5/16–24 EXT	5	Soft	Blue	051131-05645-9	10
LB 05646	10,000	12,000	6 (152)	5/16–24 EXT	6	Soft	Blue	051131-05646-6	1

3M™ Stikit™ Disc Pads

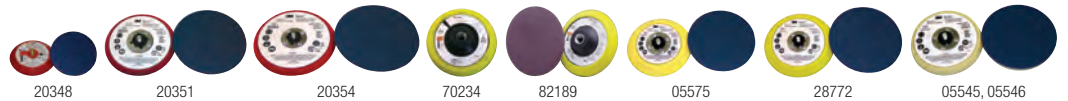

Part No.	Max RPM	Max OPM	Diameter Inch (mm)	Thread Size	Density Rating	Face Color	UPC	MOQ
Low Profile Disc Pads (Firm)								
20348	15,000	15,000	3 (76)	1/4–20 EXT	Firm	Blue	051141-20348-5	10
LB 20351	12,000	12,000	5 (125)	5/16–24 EXT	Firm	Blue	051141-20351-5	1
LB 20354	12,000	12,000	6 (152)	5/16–24 EXT	Firm	Blue	051141-20354-6	1
Standard Profile Disc Pads (Medium)								
LB 70234	12,000	—	5 (125)	5/8–11 INT	Medium	Blue	051111-55813-3	5
LB 82189	12,000	—	5 (125)	5/8–11 INT	Medium	Red	051144-82189-1	10
LB 05575	10,000	12,000	5 (125)	5/16–24 EXT	Medium	Blue	051144-05575-3	1
LB 28772	10,000	12,000	6 (152)	5/16–24 EXT	Medium	Blue	051141-28772-0	1
Low Profile Finishing Disc Pads (Soft)								
LB 05545	12,000	12,000	5 (125)	5/16–24 EXT	Soft	Blue	051131-05545-2	10
LB 05546	10,000	12,000	6 (152)	5/16–24 EXT	Soft	Blue	051131-05546-9	1

LB = Large Buy Available

Orbital/Random Orbital Sander Accessories

3M™ Stikit™ Sheet Pads

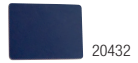

Part No.	Max OPM	Size	Thickness	Density Rating	Face Color	UPC	MOQ
20432	10,000	3" x 4"	1/2"	Medium	Blue	051141-20432-1	10
28660	10,000	2-3/4" x 7-3/4"	1/2"	Medium	Blue	051141-28660-0	5

Mini-Random Orbital Sander Accessories



3M™ Finesse-it™ Roloc™ Sanding Pads TR

Part No.	Max RPM	Max OPM	Diameter Inch (mm)	Density Rating	Description	UPC	MOQ
02345	10,000	12,000	1-1/4 (32)	Medium	PSA	051111-50198-6	10
02511	10,000	12,000	1-1/4 (32)	Firm	PSA	051111-51150-3	10

Nib Removal Sander Accessories

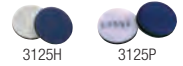

3M™ Finesse-it™ Disc Pads

Part No.	Max RPM	Max OPM	Diameter Inch (mm)	Thickness	Color	Face Color	Density Rating	Description	UPC	MOQ
3125H	7,500	7,500	1-1/4 (32)	1/8"	Black	Blue	Hard	PSA	051141-20207-5	10
3125P	7,500	10,000	1-1/4 (32)	1/8"	Black	Blue	Soft	PSA	051111-60537-0	20

Buffer Accessories

3M™ Finesse-it™ Buffing Pads



Part No.	Max RPM	Max OPM	Diameter Inch (mm)	Description	UPC	MOQ
02648	12,000	12,000	3-1/4 (83)	Orange Foam; White Loop	051111-51151-0	10
25134/25135	12,000	12,000	3-1/4 (83)	Gray Foam; White Loop	051141-25134-9	50
02637	12,000	12,000	3-3/4 (95)	Orange Foam; White Loop	051111-51158-9	50
25135	12,000	12,000	3-3/4 (95)	Gray Foam; White Loop	051141-25135-6	50
20271	12,000	12,000	3-3/4 (95)	White Foam; White Loop	051141-20271-6	10
02362	12,000	12,000	5-1/4 (133)	Orange Foam; White Loop	051111-51076-6	10
85099	—	—	3 (76)	White Wool; Knit II; 11/16" Pile Height	051144-85099-0	10
81470	—	—	3 (76)	White Wool; Natural; 20mm	051144-81470-1	10
NEW! 28401	12,000	12,000	5-1/4 (133)	White Foam; Open Cell	051141-28401-9	900
NEW! 28574	12,000	12,000	5-1/4 (133)	Gray Foam	051141-28574-0	1,500
NEW! 28783	12,000	12,000	3-3/4 (95)	Foam; Open Cell	051141-28783-6	50

3M™ Buffer Backup Pads



Part No.	Max RPM	Max OPM	Diameter Inch (mm)	Thread Size	# of Holes	Density Rating	Hook Type	For Use With	UPC	MOQ
28472	15,000	15,000	3 (76)	1/4-20 EXT	—	Firm	2	3M™ R/O Buffers — 3"	051141-28472-9	5
84226	12,000	12,000	5 (125)	5/16-24 EXT	5	Soft	1	3M™ R/O Buffers — 5"	051111-51042-1	10

Disc Sander Accessories

3M™ Roloc™ Disc Pads TR

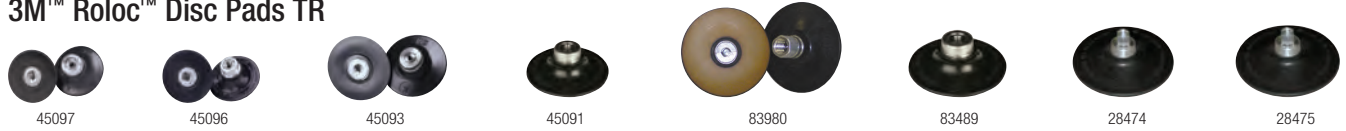

Part No.	Max RPM	Size Inch (mm)	Attachment	Density Rating	Thread Size	UPC	MOQ
45097	25,000	2 (51)	TR	Extra Hard	1/4-20 INT	051144-45097-8	5
45096	25,000	2 (51)	TR	Hard	1/4-20 INT	051144-45096-1	5
45093	20,000	3 (76)	TR	Extra Hard	1/4-20 INT	051144-45093-0	5
45091	20,000	3 (76)	TR	Hard	1/4-20 INT	051144-45091-6	5
83980	12,000	4 (102)	TR	Extra Hard	5/8-11 INT*	051144-83980-3	5
83489	12,000	4 (102)	TR	Hard	5/8-11 INT*	051144-83489-1	5
28474	12,000	4 (102)	TR	Hard	3/8-24 INT*	051141-28474-3	5
28475	12,000	4 (102)	TR	Extra Hard	3/8-24 INT*	051141-28475-0	5

*Extended thread; no spacers required

3M™ Roloc™ Disc Pads TS/TSM



Part No.	Max RPM	Size Inch (mm)	Attachment	Density Rating	Thread Size	UPC	MOQ
77728	30,000	1-1/2 (38)	TS/TSM	Hard	1/4-20 INT	051144-77728-0	5
14212	25,000	2 (51)	TS/TSM	Hard	1/4-20 INT	051144-14212-5	5
14216	20,000	3 (76)	TS/TSM	Hard	1/4-20 INT	051144-14216-3	5
28576	12,000	4 (102)	TS/TSM	Hard	3/8-24 INT	051141-28576-4	5
28577	12,000	4 (102)	TS/TSM	Extra Hard	3/8-24 INT	051141-28577-1	5
28578	12,000	4 (102)	TS/TSM	Hard	5/8-11 INT	051141-28578-8	5
28579	12,000	4 (102)	TS/TSM	Extra Hard	5/8-11 INT	051141-28579-5	5

3M™ Roloc™ Cool Running Disc Pads



Part No.	Max RPM	Size Inch (mm)	# of Holes	Attachment	Density Rating	Thread Size	UPC	MOQ
82974	20,000	2 (51)	6	TR	Medium	1/4-20 INT	051144-82974-3	5
28711	20,000	2 (51)	6	TS/TSM	Hard	1/4-20 INT	051141-28711-9	5
82975	12,000	3 (76)	6	TR	Medium	1/4-20 INT	051144-82975-0	5
28710	12,000	3 (76)	6	TS/TSM	Hard	1/4-20 INT	051141-28710-2	5
02286	15,000	4 (102)	8	TR	Hard	3/8-24 INT	051111-56479-0	5
28473	15,000	4 (102)	8	TR	Hard	5/8-11 INT*	051141-28473-6	5
28580	15,000	4 (102)	8	TS/TSM	Hard	3/8-24 INT	051141-28580-1	5
28581	15,000	4 (102)	8	TS/TSM	Hard	5/8-11 INT*	051141-28581-8	5

*Extended thread; no spacers required

3M™ Hookit™ Roloc™ Disc Pads TR

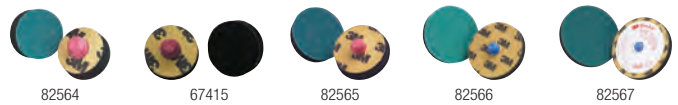

Part No.	Max RPM	Max OPM	Size Inch (mm)	Attachment	Shape	Density Rating	Hook Type	UPC	MOQ
82564	8,000	10,000	1 (25)	TR	15°	Medium	2	051144-82564-6	10
67415	10,000	10,000	1-1/16 (27)	TR	15°	Medium	1	051111-60311-6	20
82565	8,000	10,000	1-1/2 (38)	TR	15°	Medium	2	051144-82565-3	5
82566	8,000	10,000	2 (51)	TR	15°	Medium	2	051144-82566-0	5
82567	8,000	10,000	3 (76)	TR	15°	Medium	2	051144-82567-7	1

Disc Sander Accessories

3M™ Roloc™ Dust Shroud Kits

Part No.	Max RPM	Size Inch (mm)	UPC	MOQ
28727	12,000	2 (51)	051141-28727-0	1
28728	12,000	3 (76)	051141-28728-7	1



3M™ Overhose Kit and Replacement Sleeve

Designed for 0.3 HP metalworking tools

Part No.	Description	UPC	MOQ
28651	Kit Contains: Air Line Extension (PN20209), Adapter (PN20453), Over Hose Cloth Sleeve, Exhaust Spacer, Air Inlet Bushing, Instruction Sheet	051141-28651-8	1 Kit
28652	Overhose Replacement Sleeve — 1-1/2" x 4 ft.	051141-28652-5	5



3M™ Roloc™ Shank

Part No.	Shank Size	Thread Size	UPC	MOQ
45102	1/4"	1/4-20 EXT	051144-45102-9	5

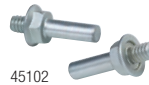

Die Grinder Accessories

3M™ Die Grinder Mandrels 1/4" Shank Diameter

For Use With	Size Pilot Dia. x Pilot Length x Shank Dia.	UPC
Cartridge Rolls	1/8" x 1" x 1/4"	051144-45119-7
Cartridge Rolls	3/16" x 1" x 1/4"	051144-45117-3
Cartridge Rolls	3/16" x 1/2" x 1/4"	051144-45118-0
Cross/Square Pads (and Cross Buffs)	1/4" x 1/4-20 EXT thread	051144-14308-5
Cross/Square Pads (and Cross Buffs)	1/4" x 8-32 EXT thread	051144-14307-8
Cross/Square Pads (and Cross Buffs)	1/4" x 3-48 EXT thread	051141-28385-2

Part No.	For Use With	Size Length x Shank Dia. x Flange Support Dia.	UPC
936	Deburring Wheels/Radial Bristle Discs	2-1/16" x 1/4" x 3/4" (not pictured)	048011-04018-9
990	Deburring Wheels/Radial Bristle Discs	1-3/4" x 1/4"	048011-15012-3
944	Stars	1/4" x 1/4-20 EXT	048011-13928-9
935	Strips/Polishing Rolls	2-7/8" x 1/4"	048011-04020-2



3M™ Forked Spindle

For Use With	Size	UPC
Strips/Polishing Rolls	3" x 1/16" x 1/4"	051144-45121-0



3M™ PG Wheel Adapter 81A

For Use With	Size	UPC
T-84 Flap Wheels	1/4-20 INT thread x 1/4" shank	051144-45081-7



Die Grinder and Inline Sander Accessories

3M™ Rubber Cushion Polishing Wheels for Abrasive Bands

Diameter x W x Shaft	Max RPM	UPC
1/4" x 1/2" x 1/8"	23,000	051144-45159-3
1/2" x 1/2" x 1/4"	30,000	051144-45156-2
1/2" x 1" x 1/4"	15,000	051144-45153-1
1/2" x 1-1/2" x 1/4"	15,000	051144-45152-4
3/4" x 1" x 1/4"	17,000	051144-45145-6
3/4" x 1-1/2" x 1/4"	10,000	051144-45144-9
1" x 1" x 1/4"	18,000	051144-45139-5
1" x 1-1/2" x 1/4"	10,000	051144-45138-8
1-1/2" x 1" x 1/4"	14,000	051144-45132-6
1-1/2" x 1-1/2" x 1/4"	10,000	051144-45131-9
1-1/2" x 2" x 1/4"	8,000	051144-45130-2
2" x 1" x 1/4"	11,000	051144-45129-6



3M™ Rubber Slotted Expander Wheels

Part No.	Size	Description	UPC
Use with 3M™ Die Grinders			
77717	1" x 1" x 1/4" Shank	For use with 1" x 1" bands	051144-77717-4
77718	1-1/2" x 1" x 1/4" Shank	For use with 1-1/2" x 1" bands	051144-77718-1
77720	2" x 1" x 1/4" Shank	For use with 2" x 1" bands	051144-77720-4
77721	2" x 2" x 1/4" Shank	For use with 2" x 2" bands	051144-77721-1
Use with 3M™ Inline Sanders			
77722	3" x 3" x 5/8–11 INT	For use with 3" x 3" bands	051144-77722-8
28348	5" x 3-1/2" x 5/8" AH	For use with 3-1/2" W x 15-1/2" L belts	051141-28348-7
28349	3-2/5" x 3" x 5/8" AH	For use with 3" W x 10-11/16" L belts	051141-28349-4
Use with 3M™ Match and Finish Sander			
28718	5" x 3-1/2" x 1" AH	Rubber slotted expander wheel for use with 3-1/2" W x 15-1/2" L belts	051141-28718-8
28719	1" x 5/8–11 INT	Wheel adapter kit to mount PN28718 wheel on Match and Finish Sander	051141-28719-5



3M™ Wheel Adapter Kits* Fits wheels with 5/8" or 1" AH

Part No.	Thread Size	Description	UPC	Case Quantity
45038	5/8–11 INT x 5/8–11 EXT	For use with Expander Wheels	051144-45038-1	1
04019	5/8–11 INT x 5/8–11 EXT	For use with Scotch-Brite™ Wheels	048011-04019-6	1
28419	5/8–11 INT x 1/2–20 EXT	For use with 1/2" Center Hole Wheels	051141-28419-4	1

*Kits include spacers, flanges and end nuts to mount expander wheels and other Scotch-Brite™ Wheels.



3M™ Replacement Spacers

Part No.	Description	UPC	Case Quantity
28636	1" OD x 5/8" ID x 3/8" thick	051141-28636-5	1
28637	1" OD x 5/8" ID x 3/16" thick	051141-28637-2	1



Disc Sander/Grinder Accessories

3M™ Disc and Wheel Accessories



Part No.	Size	Description	For Use With
28476	2-1/2" Diameter, 5/8–11 INT	Disc Pad Hub — Low Profile	Fibre Discs, 4-1/2" and 5" Diameter
45205	2-1/2" Diameter, 5/8–11 INT	Disc Pad Hub — Standard Profile	Fibre Discs, 4-1/2" and 5" Diameter
28442	2-1/2" Diameter, 3/8–24 INT	Disc Pad Hub — Low Profile	Fibre Discs, 4-1/2" and 5" Diameter
28656	4" Diameter	Disc Pad Face Plates — Ribbed; Red; Extra Hard	Fibre Discs, 4" Diameter x 7/8" CH
28657	4" Diameter	Disc Pad Face Plates — Ribbed; Black; Hard	Fibre Discs, 4" Diameter x 7/8" CH
28658	4" Diameter	Disc Pad Face Plates — Ribbed; Gray; Medium	Fibre Discs, 4" Diameter x 7/8" CH
28443	4-1/2" Diameter	Disc Pad Face Plates — Ribbed; Red; Extra Hard	Fibre Discs, 4-1/2" Diameter x 7/8" CH
14270	4-1/2" Diameter	Disc Pad Face Plates — Smooth; Black; Hard	Fibre Discs, 4-1/2" Diameter x 7/8" CH
13325	4-1/2" Diameter	Disc Pad Face Plates — Smooth; Gray; Medium	Fibre Discs, 4-1/2" Diameter x 7/8" CH
81732	5" Diameter	Disc Pad Face Plates — Ribbed; Red; Extra Hard	Fibre Discs, 5" Diameter
81733	5" Diameter	Disc Pad Face Plates — Ribbed; Black; Hard	Fibre Discs, 5" Diameter
81734	5" Diameter	Disc Pad Face Plates — Ribbed; Gray; Medium	Fibre Discs, 5" Diameter
51047	5/8–11 INT	Disc Retainer Nuts — 5/16" Depth	Fibre Discs, 4-1/2" and 5" Diameter
05622	5/8–11 INT	Disc Retainer Nuts — 3/8" Depth	Fibre Discs, 4-1/2" and 5" Diameter
56573	4-1/2" Diameter	NTN Backup Pad	3M™ Abrasives with Tinneman Nut Attachment, 4-1/2" Diameter (Excludes 3M™ Green Corps™ and General Purpose Wheels)
50146	4-1/2" Diameter	Green Corps™ Flexible Grinding Disc Backup Plate	Bonded Wheels, 4-1/2" Diameter
88765	5/8–11 INT	Flap Disc Adaptor Nut	Flap Discs, 4-1/2" x 7/8" CH
28739	1" x 5/8" x 3/8–24 INT	Flange Nuts	Wheels, 4" Diameter x 5/8" CH on 4" Grinders 28403 and 28413
28740	1" x 5/8–11 INT	Flange Nuts	Wheels, 4" Diameter x 5/8" CH on 4-1/2" Grinders 28405 and 28414

3M™ Disc Pad Holders (Hook and Loop)



Part No.	Size	Thickness	Thread Size	Density	Hook Type	UPC	MOQ
9215	1-1/2" x 1/4" Shank	1/8"	—	Firm	5	048011-04130-8	10
922	2" x 1/4" Shank	1/8"	—	Firm	5	048011-07494-8	1
923	3" x 1/4" Shank	1/8"	—	Firm	5	048011-04132-2	1
924	4" x 1/4" Shank	1/16"	—	Firm	5	048011-07492-4	5
914	4" x 3/8" CH	1/8"	5/8–11 INT	Firm	7	048011-05674-6	1
9145	4-1/2" x 3/8" CH	1/8"	5/8–11 INT	Firm	7	048011-14111-4	1
905	5"	1/4"	5/16–24 EXT	Medium	7	048011-09448-9	1

3M™ Disc Holder Adapter No. 9

Part No.	Thread Size	UPC	MOQ
9	5/8–11 EXT x 3/8–24 INT	048011-22970-6	1



File Belt Sander Accessories

3M™ File Belt Sander Platen Pad Material

Part No.	Size Inches	For Use With	Description	UPC	Case Quantity
28377	1/2 x 7 x 1/8	1/2" wide belts	Soft	051141-28377-7	10
28378	3/4 x 7 x 1/8	5/8" or 3/4" wide belts	Soft	051141-28378-4	10
28379	1/2 x 7 x 1/8	1/2" wide belts	Hard	051141-28379-1	10
28380	3/4 x 7 x 1/8	5/8" or 3/4" wide belts	Hard	051141-28380-7	10
28381	1/2 x 7 x 1/32	1/2" wide belts	Thin	051141-28381-4	10
28382	3/4 x 7 x 1/32	5/8" or 3/4" wide belts	Thin	051141-28382-1	10
NEW! 28726	15-3/4 x 11-13/16	Can be cut to fit any belt size arm	Soft	051141-28726-3	10



3M™ File Belt Sander Extension

Part No.	Description	UPC	Case Quantity
 28376	Use to extend arms to 24" length. Can be used with same attachment arm used for 18" length arms.	051141-28376-0	1



3M™ File Belt Arm Service Tool Kit

Part No.	Description	UPC	Case Quantity
30670	Contains Wheel Positioning Block, Shaft Removal Tool, 2 Bearing Removal Tools, Bearing Mount Tool, Bearing Tool and Retaining Compound	051141-30670-4	1



3M™ File Belt Attachment Arm Repair Kits







Kits contain: Contact wheel, bearing, shaft and platen pad if applicable.
 3M™ File Belt Arm Service Tool Kit (PN30670) recommended for use with repair kits.

Attachment Arm Repair Kit Part No.	For Use With Attachment Arm Part No.
30663	28368
30667	28369
30668	28370
30664	28371
30666	28372
30665	28373
30662	28374
30669	28375



File Belt Sander Accessories

3M™ File Belt Sander Attachment Arms

Part No.	Use With Belt Size	Description	UPC	Case Quantity
 28368	1/2" x 18"	Standard Style: Standard arm included with 3M™ File Belt Sander (PN28366). Sand with contact wheel or platen.	051141-28368-5	1
 28369	1/2" x 18"	Thin Style: Thinner than standard arm. Sand with contact wheel or platen.	051141-28369-2	1
 28370	1/8" x 18" 1/4" x 18" 1/2" x 18"	Corners Style: Sand corners and grooves with contact wheel. Accommodates three belt widths.	051141-28370-8	1
 28371	5/8" x 18" 3/4" x 18"	Thick Standard Style: Thicker than standard arm. Sand with contact wheel or platen. Accommodates two belt widths.	051141-28371-5	1
 28372	1/8" x 18" 1/4" x 18"	Corners Style: Sand corners and grooves with contact wheel. Accommodates two belt widths.	051141-28372-2	1
 28374	1/2" x 18"	Curved Arm: Unique curved arm used for blending flat areas. Sand with contact wheel or platen.	051141-28374-6	1
 28375	1/4" x 24" 1/2" x 24"	Vessel Arm: Unique large arm used for blending weld seams. Sand with 4" contact wheel. Includes tracking/control knob. Accommodates two belt widths.	051141-28375-3	1



Selection Guides for Abrasive Products

Random Orbital Sander Abrasives



	3M ID	Anti-Loading or Grinding Aid	Clean Sanding	Backing
Good	NX	•		C- & D-Paper
	202DZ			J-Cloth
	210U		KUT	A-Paper
	216U	•	•	A-Paper
	426U	•	KUT	A-Paper
Better	236U	•	•	C-Paper
	255L	•		Film
	268L		KUT	Film
	337DC	•		X-Cloth
	341D/348D			X-Cloth
	359F			Y-Cloth
	360L		•	Film
	363I			F-Paper
	375L	•		Film
	468L		KUT	Film
Best	268XA			Film
	366L	•	KUT	Film
	568XA			Film
	675L			Film
	735U	•	•	C-Paper
	763U		KUT	F-Paper
	751I		KUT	E-Paper
	752I			F-Paper
	777F	•		Y-Cloth
	Scotch-Brite™ RO	•		Non-woven
900DZ		•	J-Cloth	

Mini Sander Abrasives



Size	Product	Grade		
		A3	A5	A7
1-1/4"	Trizact™ Finesse-it™ Film Disc 466LA	•	•	•
1-3/8"	Trizact™ Finesse-it™ Film Disc 464LA	•	•	•

Cut-Off Wheel Tool Abrasives

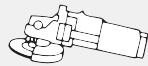

	Product	Mineral	Metal Type	Type
Better	General Purpose	Aluminum Oxide	All Metals	T1
	3M™ Green Corps™	3M™ Ceramic Abrasive Grain	All Metals	T1
	High Performance	3M™ Ceramic Abrasive Grain	All Metals	T1, T27
Best	Cubitron™ II	3M™ Ceramic Abrasive Grain	All Metals	T1, T27

Sander/Grinder Fibre Discs



	3M ID	Mineral	Metal Type
Good	381C	Aluminum Oxide	Carbon Steel
	501C	Alumina Zirconia	Stainless/Aluminum
Better	501C	Alumina Zirconia	Carbon Steel
	785C	Ceramic Aluminum Oxide Blend	Stainless/Aluminum
Best	988C	3M™ Ceramic Abrasive Grain	Carbon Steel
	985C	3M™ Ceramic Abrasive Grain	Stainless/Aluminum
Premium	982C	Precision Shaped Ceramic	Carbon Steel
	987C	Precision Shaped Ceramic	Stainless/Aluminum

Inline Sander Abrasives

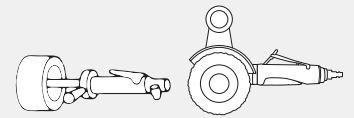

	3M ID
Good	3M™ Belt 577F
Best	3M™ Belt 777F
	Scotch-Brite™ Surface Conditioning Belt A MED for a #4 finish, A CRS for a #3 finish
Premium	3M™ Belt 947A

Scotch-Brite™ Match and Finish Flap Brushes

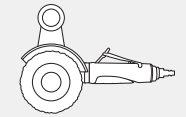

Nonwoven Finish	Coarser Finish	Combi Finish
Flap Brush 5A XCS		Combi Brush Grade A/O 60
HS Flap Brush 7A CRS		Combi Brush Grade A/O 100
HS Flap Brush 7A MED		Combi Brush Grade A/O 150
Flap Brush 5A MED		
Flap Brush 5S MED		
Flap Brush 5A VFN		
	Finer Finish	

File Belt Sander Abrasives

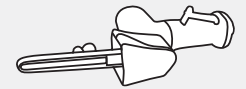

	3M ID	Metal Type
Good	241E	Carbon Steel, Aluminum, Brass, Bronze
Better	577F	Carbon Steel, Stainless Steel, Aluminum, Brass, Bronze, Cobalt and Nickel Alloys, Titanium
	777F	Carbon Steel, Stainless Steel, Aluminum, Brass, Bronze, Cobalt and Nickel Alloys, Titanium
Best	237AA	Mild Steel, Stainless, Nickel, Cobalt Alloys, Aluminum, Brass, Copper, Titanium
	947A	Carbon Steel, Stainless Steel, Aluminum, Brass, Bronze, Cobalt and Nickel Alloys, Titanium
	984F	Carbon Steel, Stainless Steel, Aluminum, Brass, Bronze, Cobalt and Nickel Alloys, Titanium
	Scotch-Brite™ SC	All Metals, General Purpose, Works Best on Flats
	Scotch-Brite™ SE	All Metals, Heavy-Duty Applications
Scotch-Brite™ DF	All Metals, Applications where a sharp edge is present and/or flexibility is desired	

Selection Guides for Abrasive Products

3M™ Coated Abrasive Belts

These belts provide dependable, economic performance for general metalworking applications.

● = Stock M = Make-to-Order – = Not Available



Size (in inches)	Product	Grade									
		36	40	50	60	80	100	120	180	220	320
1/4 x 18	241E	–	–	M	M	M	M	M	M	M	M
	577F	M	M	M	●	●	M	●	M	–	–
	777F	M	M	M	●	●	M	●	M	–	–
	947A	M	M	M	M	M	M	M	M	M	M
	984F	M	–	–	M	M	–	–	–	–	–
1/4 x 24	241E	–	–	M	●	●	M	●	M	M	M
	577F	M	M	M	●	●	M	●	M	–	–
	777F	●	M	M	●	●	M	●	M	–	–
	947A	M	M	M	●	●	M	●	M	M	M
	984F	M	–	–	●	M	–	–	–	–	–
1/2 x 18	241E	–	–	M	●	●	M	M	M	M	M
	577F	●	M	M	●	●	M	●	M	–	–
	777F	●	●	M	●	●	M	●	M	–	–
	947A	M	M	M	●	●	M	●	M	M	M
	984F	●	–	–	●	●	–	–	–	–	–
1/2 x 24	241E	–	–	M	●	●	●	M	●	●	M
	577F	●	M	M	●	●	M	●	M	–	–
	777F	●	●	●	●	●	M	●	M	–	●
	947A	M	M	M	●	●	M	●	M	M	M
	984F	●	–	–	●	●	–	–	–	–	–
3/4 x 18	241E	–	–	M	●	●	M	●	M	M	M
	577F	●	M	M	●	●	M	●	M	–	–
	777F	●	M	M	●	●	M	●	M	–	–
	947A	M	M	M	●	●	M	●	M	M	M
	984F	●	–	–	●	●	–	–	–	–	–
3/4 x 20-1/2	241E	–	–	M	M	M	M	M	M	M	M
	577F	M	M	M	●	●	M	●	M	–	–
	777F	M	M	M	●	●	M	●	M	–	–
	947A	M	M	M	●	●	M	●	M	M	M
	984F	●	–	–	M	●	–	–	–	–	–

241E
Aluminum Oxide on high strength cloth backing

577F
Alumina zirconia on YF wt cloth backing

777F
3M™ Ceramic Aluminum Oxide blend abrasive grain on YF wt cloth backing with grinding aid

947A
Revolutionary 3M precision shaped abrasive grain technology on X wt poly-cotton backing with grinding aid

984F
Revolutionary 3M precision shaped abrasive grain technology on YF wt polyester backing with grinding aid

Scotch-Brite™ Belts

● = Stock M = Make-to-Order – = Not Available

Size (in inches)	Product	Grade			
		A VFN	A FIN	A MED	A CRS
1/4 x 18	SC	M	–	●	M
	SE	–	M	M	●
	DF	–	●	●	●
1/4 x 24	SC	●	–	●	●
	SE	–	M	M	M
	DF	–	●	●	●
1/2 x 18	SC	●	–	●	●
	SE	–	M	M	●
	DF	–	●	●	●
1/2 x 24	SC	●	–	●	●
	SE	–	M	M	●
	DF	–	●	●	●
3/4 x 18	SC	●	–	●	●
	SE	–	M	M	●
	DF	–	●	●	●
3/4 x 20-1/2	SC	M	–	●	M
	SE	–	M	M	M
	DF	–	M	M	M

Selection Guides for Abrasive Products

Disc Sander Abrasives

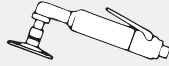

	3M ID	Mineral	Features	Metal Type	Grinding	Light Grinding	Blending	Deburring	Finishing
3M™ Roloc™ Cloth Discs									
Good	361F	Aluminum Oxide	General purpose grinding, light grinding, blending and deburring on all metals	All Metals	•	•	•	•	
	461F	Silicon Carbide	Ideal for grinding glass, titanium and non-ferrous metals	Titanium		•	•	•	
Better	777F	Ceramic Aluminum Oxide Blend	Durable Y wt. Cloth backing; Grinding aid	Stainless Steel, Nickel Alloy	•	•	•	•	
Best	963G	Ceramic Abrasive Grain	Durable backing	Carbon Steel	•	•	•	•	
	984F	Precision Shaped Grain	Durable 2-ply backing; Grinding aid	All Metals	•	•	•	•	
3M™ Roloc™ Fibre Discs									
Good	501C	Aluminum Zirconia	Versatile disc for use on a wide variety of metals; General purpose grinding, blending and finishing on all metals	All Metals	•	•		•	
Better	785C	Ceramic Aluminum Oxide Blend	Excellent for stainless steel; Grinding aid	Stainless Steel	•	•		•	
Best	983C/ 988C	Ceramic Abrasive Grain	Fast cutting; Long life; Designed for a variety of carbon steel applications	Carbon Steel	•	•		•	
	982C	Precision Shaped Grain	Fast cutting; Longer life; Designed for a variety of applications	All Metals	•	•		•	
Scotch-Brite™ Roloc™ Discs									
Best	SC-DR Surface Conditioning	Aluminum Oxide	Versatile disc for use on a variety of metals	All Metals			•	•	•
	PD-DR PD Surface Conditioning	Aluminum Oxide	Lofty, open non-woven abrasive disc resists loading on soft or oily materials	Aluminum, Brass and other soft metals			•	•	•
	GB-DR Light Grinding and Blending	Cubitron™ Ceramic Aluminum Oxide Blend	High cut rate and durable construction	All Metals		•	•	•	

Die Grinder Abrasives — Light-Duty Grinding (0.3 HP)

These die grinders are ideal for light-duty applications. Available in extended shaft models.



Product Name	28627 18,000 Max RPM	28628 (extended) 18,000 Max RPM	28629/28630 (extended) 25,000 Max RPM
Scotch-Brite™ Abrasives			
Cross Buffs	All	All	
Stars	All	All	
EXL Unitized Mounted Points	All shapes and shank sizes	Shape A21 with 1/4" shank; All shapes with 1/8" shank	
EXL Unitized Wheel	All	All	
3M™ Coated Abrasives			
Cartridge Roll Mandrel	All	All	
Cross Pads 341D	All	All	
Radial Bristle Disc	All thick and thin bristle discs	All thick and thin bristle discs	All thick bristle discs

Selection Guides for Abrasive Products

Die Grinder Abrasives — Medium-Duty Grinding (0.5 HP)

These die grinders are ideal for medium-duty applications. Available in extended shaft models.



Product Name	28332 4,000 Max RPM	28330/28331 (extended) 18,000 Max RPM
Scotch-Brite™ Abrasives		
Cross Buffs	3" or less	1-1/2" or less
Cut & Polish Discs	6" x 1/4" A MED	
High Strength Discs	6" x 1/4"	
Flap Brush	3" x 1-3/4" x 1/4" A MED, A CRS, S FIN	
Combi Wheel	3" x 1-3/4" x 1/4"	
EXL Unitized Wheel		1" to 1-1/2" 2, 3 densities; 1" to 2-1/2 and 3" x 1/8"–3/8" 4, 6, 8 densities
3M™ Coated Abrasives		
Flap Wheels 241E/244E	6"	
Cartridge Rolls 341D		1/2" diameter or less
Square Pads 341D	3" x 3" or smaller	
Cross Pads 341D	6" or less	3" or less
Bands* 341D	All	1" x 1" x 1/4"

Die Grinder Abrasives — Heavy-Duty Grinding (1 HP)

These powerful die grinders are excellent for big jobs such as weld or stock removal.



Product Name	20240 8,000 Max RPM	20239 12,000 Max RPM	20238/28770 (extended) 18,000 Max RPM	20237 20,000 Max RPM
Scotch-Brite™ Abrasives				
Cross Buffs	2"	2" or less	1-1/2" or less	1-1/2" or less
Cut & Polish Discs	2" and 3" A MED	2" A MED		
High Strength Discs	3" or less			
Flap Brush	3" x 1-3/4" x 1/4" A MED, A CRS, S FIN	2" x 1" x 1/4" A MED		
Combi Wheel	3" x 1-3/4" x 1/4"			
EXL Unitized Wheel			1" to 1-1/2" 2, 3 densities; 1" to 2-1/2 and 3" x 1/8"–3/8" 4, 6, 8 densities	
Rapid Cut			1" to 3" x 1/8" to 1" 9 density CRS+, XCS+	
3M™ Coated Abrasives				
Flap Wheels 241E/244E				1" x 1", 2" x 1", 3" x 1", 60 & finer
Cartridge Rolls 341D		5/8" – 3/4" diameter	1/2" diameter or less	1/2" diameter or less
Square Pads 341D	3" x 3" or smaller	2" x 2"		
Cross Pads 341D	6" or less	4" and 4-1/2" or less	3" or less	2" (1/4–20 eyelet); <2" (8–32 eyelet)
Bands* 341D	1-1/2" x 2" x 1/4"	2" x 1" x 1/4"	1" x 1" x 1/4"	1/4" x 1/2" x 1/8"; 1/2" x 1/2" x 1/4"

*Use on slotted expander wheels or rubber cushion polishing wheel.
NOTE: Products and dimensions are representative, not comprehensive.

General Sanding Tips

Technical Recommendations for 3M™ Air-Powered Tools

- Use a clean, dry, lubricated air supply that will give a measured air pressure at the tool of 6.2 bar (90 psig) when the tool is running with the lever fully depressed. **Note:** Tools can be run at lower pressures, but should **never be run higher than 6.2 bar (90 psig)**. If run at a lower pressure, the performance of the tool is reduced.
- Use an approved 10mm x 8m (3/8" x 25 ft.) or 13mm x 8m (1/2" x 25 ft.) maximum length air line.
- Connect the tool to the air supply.
- It is strongly recommended that an air filter, regulator and lubricator (FRL) be used to supply clean, lubricated air at the correct pressure to the tool. If such equipment is not used, the tool should be manually lubricated.

To Manually Lubricate the Tool

- Disconnect the air line and put 2–3 drops of suitable pneumatic motor lubricating oil, such as 3M™ Air Tool Lubricant 20451, into the hose end (inlet) of the tool.
- Reconnect tool to the air supply and tap the lever to allow air to circulate the oil. Lubricate at end of day and allow oil to penetrate over night for best results.
- Lubricate daily if the tool is used frequently or if the tool starts to slow or lose power.



Air Basics

To optimize compressed air output and delivery:

90 psi under load — use your gauge

3/8" (10mm) minimum air line inside diameter

Use minimum length of airline hose necessary; no more than 25 ft. (8m)

High flow air fittings (3/16" marginal; 7/32" better; 9/32" best)

Observe compressed air demand throughout the plant

Maximum working air pressure 6.2 bar (90 psig)



Airflow Rates for Metalworking Tools

Tool	Airflow Rate	PSI
0.3 HP	17 SCFM (481 LPM)	90
0.5 HP	26 SCFM (736 LPM)	90
1 HP	37 SCFM (1,048 LPM)	90



Random Orbital Sanding Tips

Select the orbit that's right for your project

 <p>3/32" Diameter Orbit fine finish sanding</p>  <p>Chrome – 3/32"</p>	 <p>3/16" Diameter Orbit general purpose sanding</p>  <p>Silver – 3/16"</p>
 <p>5/16" Diameter Orbit aggressive sanding</p>  <p>Black – 5/16"</p>	 <p>3/8" Diameter Orbit most aggressive sanding</p>  <p>Gold – 3/8"</p>

Lever indicates orbit diameter.

Basic ROS Techniques

- 1) Start the tool ON the surface; stop the tool OFF the surface
- 2) Run the tool flat on work piece (no tipping on edge)
- 3) Light operator hand pressure (let the tool do the work)
- 4) North, south, east, west sanding pattern for a uniform, quality finish

Troubleshooting Checklist

- Check for correct PSI and RPM
- Check airline length, leaks, fitting and inside diameter
- Check tool lubrication schedule
- Look for worn bearings
- Look for damaged disc pad
- Are the tool and disc pad diameter the same?
- Is the lever damaged or the muffler clogged?
- Is the speed control adjuster turned down?

Disc Sander Tips

Lubricating the Gears for Disc Sanders

Lubricate the gear head weekly or as needed with premium grease with the following properties:

- High and low temperature performance
- Shear stable
- Anti-wear protection
- Low viscosity base fluid for high speed applications
- Very low coefficient of friction

3M recommends Mobil XHP 220 or Fuchs Renolit AXS2 or equivalent.

Gear Head Grease (#13388) and Grease Gun (#13389) available through Contract Production Services, 1-800-843-0619, www.cpsabrasives.com

MOS Speed Ratings

The lowest RPM rating of an abrasive or accessory determines the RPM of the tool it can run on. Be very aware of these ratings.

Unique Factors — Be sure to consider operator preference of tool power, size and weight.

Less Aggressive

0.3 HP	Light Blending and Finishing	Mostly Surface Conditioning Discs
0.5 HP	Light Grinding and Deburring	Surface Conditioning/ Coated Abrasive Discs
1 HP	Grinding	Mostly Coated Abrasive Discs

More Aggressive



Versatile Attachment System

SHORT* — “Direct Mount” Backup Pad Attachment

Shorter distance to the work piece generates less vibration and allows for better operator control.

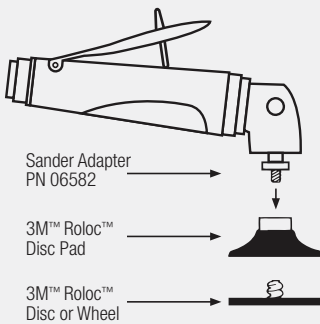

*Direct mount to disc pad.

**For other collet inserts see Owners Manual for part numbers.

TALL — 1/4" Collet Option

Allows for longer reach and mounting of other abrasives and 1/4" accessories.

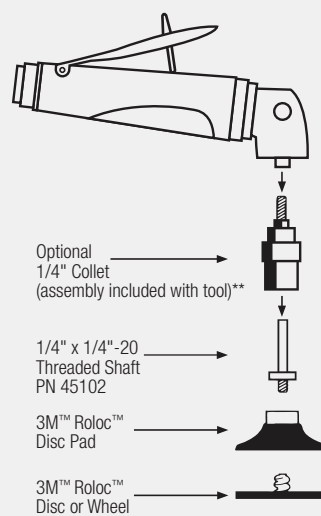

3M™ Roloc™ Attachment Systems

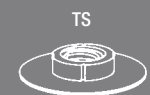

Optimize Results With 3M™ Power Tools

Product Use: Many factors beyond 3M's control and uniquely within user's knowledge and control can affect the use and performance of a 3M product in a particular application. Given the variety of factors that can affect the use and performance of a 3M product, user is solely responsible for determining whether it is fit for a particular purpose and suitable for user's method of application.

Warranty and Limited Remedy: 3M warrants this tool against defects in workmanship and materials under normal operating conditions for one (1) year from the date of purchase. 3M MAKES NO OTHER WARRANTIES, EXPRESS OR IMPLIED, INCLUDING, BUT NOT LIMITED TO, ANY IMPLIED WARRANTY OF MERCHANTABILITY OR FITNESS FOR A PARTICULAR PURPOSE OR ANY IMPLIED WARRANTY ARISING OUT OF A COURSE OF DEALING, CUSTOM OR USAGE OF TRADE. User is responsible for determining whether the 3M tool is fit for a particular purpose and suitable for user's application. User must operate the tool in accordance with all applicable operating instructions, safety precautions, and other procedures stated in the operating manual to be entitled to warranty coverage. 3M shall have no obligation to repair or replace any tool or part that fails due to normal wear, inadequate or improper maintenance, inadequate cleaning, non-lubrication, improper operating environment, improper utilities, operator error or misuse, alteration or modification, mishandling, lack of reasonable care, or due to any accidental cause. If a tool or any part thereof is defective within this warranty period, your exclusive remedy and 3M's sole obligation will be, at 3M's option, to repair or replace the tool or refund the purchase price.

Limitation of Liability: Except where prohibited by law, 3M will not be liable for any loss or damage arising from the 3M product, whether direct, indirect, special, incidental or consequential, regardless of the legal theory asserted, including warranty, contract, negligence or strict liability.

For warranty and repair service, call **1-800-362-3550** (choose option 3, then option 5)

The full line of 3M™ Accessories is available in the
Accessories for Abrasive Products catalog.

3M™ Power Tools. Abrasives Tools from the Abrasives Experts.



3M Abrasive Systems Division
3M Center
Building 223-6S-03
St. Paul, MN 55144-1000
www.3M.com/PowerTools

3M, Cubitron, Finesse-it, Green Corps, Hookit, PPS, Roloc, Scotch, Scotch-Brite, Stikit, SUN GUN and Trizact are trademarks of 3M. Used under license in Canada.

Please recycle. Printed in U.S.A. © 3M 2015. All rights reserved. 61-5002-8217-5 Rev. 6/15