

3M™ Power Tools, Abrasives and Accessories



3M™ Power Tools

Abrasives Tools from the Abrasives Experts



3M



3M™ Power Tool Warranty

Warranty and Limited Remedy: 3M warrants this tool against defects in workmanship and materials under normal operating conditions for one (1) year from the date of purchase. 3M MAKES NO OTHER WARRANTIES, EXPRESS OR IMPLIED, INCLUDING, BUT NOT LIMITED TO, ANY IMPLIED WARRANTY OF MERCHANTABILITY OR FITNESS FOR A PARTICULAR PURPOSE OR ANY IMPLIED WARRANTY ARISING OUT OF A COURSE OF DEALING, CUSTOM OR USAGE OF TRADE. User is responsible for determining whether the 3M tool is fit for a particular purpose and suitable for user's application. User must operate the tool in accordance with all applicable operating instructions, safety precautions, and other procedures stated in the operating manual to be entitled to warranty coverage. 3M shall have no obligation to repair or replace any tool or part that fails due to normal wear, inadequate or improper maintenance, inadequate cleaning, non-lubrication, improper operating environment, improper utilities, operator error or misuse, alteration or modification, mishandling, lack of reasonable care, or due to any accidental cause. If a tool or any part thereof is defective within this warranty period, your exclusive remedy and 3M's sole obligation will be, at 3M's option, to repair or replace the tool or refund the purchase price.

Limitation of Liability: Except where prohibited by law, 3M and seller will not be liable for any loss or damage arising from the 3M product, whether direct, indirect, special, incidental or consequential, regardless of the legal theory asserted, including warranty, contract, negligence or strict liability.

Submitting a Warranty Claim: Contact your dealer when submitting a warranty claim in accordance with the restrictions listed above. Please note that all warranty claims are subject to manufacturer's approval. Be sure to keep your sales receipt in a safe place. This must be submitted when filing a warranty claim, within 1 year from the date of purchase. For additional assistance call 1-800-362-3550 (choose option 3, then option 5).

3M™ Power Tool Repair and Refurbish Service

For tools that fall outside the manufacturer's warranty (e.g. after the warranty period has expired, or when the damage is due to use and wear), 3M is pleased to offer the 3M™ Power Tool Repair and Refurbish Service. 3M™ Power Tool Repair Experts will perform a full diagnostic analysis, replace any worn parts, and restore the tool to excellent working condition, all for one flat rate. Available for all 3M™ Power Tools except pistol grip tools, 3M™ PPS™ SUN GUN™ and 3M™ Polisher 28363. Program highlights include:

- Fast turnaround (5 days + shipping time)
- Tool is rebuilt by the 3M™ Power Tool Repair Experts in Cumberland, Wisconsin
- Flat rate includes return shipping
- 90 day warranty on repaired tool



For more information, contact your 3M sales professional or call 1-800-362-3550 (choose option 3, then option 5).





3M™ Power Tools

A full family of innovative tools to optimize your abrasive performance and maximize your comfort.

Table of Contents

| | |
|---|--------------|
| ■ Tools and Specifications | 2–12 |
| 3M™ Random Orbital Sanders — Elite Series | 2–3 |
| 3M™ Random Orbital Sanders — Original Series | 4 |
| 3M™ Orbital Sanders — Elite and Original Series | 4 |
| 3M™ Electric Random Orbital Sanders | 5 |
| 3M™ Mini Sanders | 5 |
| 3M™ Sanders and Buffers | 6 |
| 3M™ Electric Variable Speed Polisher | 6 |
| 3M™ Die Grinders | 7 |
| 3M™ Disc Sanders | 8 |
| 3M™ Grinders — Type 27 | 9 |
| 3M™ Cut-Off Wheel Tools | 10 |
| Replacement Parts for 1.5 HP Power Tools | 10 |
| 3M™ Inline Sanders | 11 |
| 3M™ Match and Finish Sander | 11 |
| 3M™ File Belt Sander and Attachment Arms | 12 |
| ■ Tool Accessories | 13–24 |
| Orbital/Random Orbital Sander Accessories | 13–18 |
| Mini-Random Orbital Sander Accessories | 18 |
| Nib Removal Sander Accessories | 18 |
| Buffer Accessories | 18 |
| Disc Sander Accessories | 19–20 |
| Die Grinder Accessories | 20 |
| Die Grinder and Inline Sander Accessories | 21 |
| Disc Sander/Grinder Accessories | 22 |
| File Belt Sander Accessories | 23–24 |
| ■ Selection Guides for Abrasive Products | 25–28 |
| ■ Sanding Techniques and Tips | 29–30 |
| ■ Quick Reference Guide (tear-out sheet) | 31–32 |



3M™ Random Orbital Sanders — Elite Series

We took our best line of air-powered 3M™ Random Orbital Sanders and made it better.



Upgrades from Original Series — Improved durability, ergonomics and noise level

- 1 Aluminum housing for added durability and reduced vibration; Durable composite cover helps prevent cracked housings
- 2 **Recessed Lever** eliminates pinch points
- 3 Extended cover with **3M™ Gripping Material** allows better control with reduced effort, insulates from cold and reduces vibration
- 4 Safer **Thumb Wheel** mounted speed control reduces inadvertent speed changes
- 5 Wider port for **more efficient dust capture**
- 6 **Internal Muffler** results in less breakage, SGV 6 dB quieter
- 7 **Integrated Wrist Support** for comfort and leverage
- 8 Clearance for large inlet coupler
- 9 **Center Mount Exhaust** for more finger room, better dust collection airflow

Red Text = Proprietary 3M Design Feature

3M™ Random Orbital Sanders — Elite Series

3M™ Elite Non-Vacuum Random Orbital Sanders

Our top-of-the-line non-vacuum random orbital sanders featuring the latest in 3M innovation.



| Model No. | Tool Dia. Inch (mm) | Max RPM | Motor HP (W) | Orbit Dia. Inch (mm) | Air Flow Rate SCFM (LPM) | Noise Level dBA (power) | Weight Pound (kg) | Length Inch (mm) | Height Inch (mm) | Pad Included | UPC |
|-----------|---------------------|---------|--------------|----------------------|--------------------------|-------------------------|-------------------|------------------|------------------|---------------|----------------|
| 28494 | 3 (76) | 12,000 | 0.28 (209) | 3/16 (5) | 17 (481) | 73 (84) | 1.5 (.7) | 6 (147) | 4 (92.5) | Hookit™ 20350 | 051141-28494-1 |
| 28496 | 3 (76) | 12,000 | 0.28 (209) | 3/32 (2.5) | 17 (481) | 73 (84) | 1.3 (.6) | 6 (147) | 3 (86) | Stikit™ 20348 | 051141-28496-5 |
| 28583 | 5 (127) | 12,000 | 0.28 (209) | 3/8 (9.5) | 17 (481) | 74 (85) | 1.8 (.8) | 7 (172) | 4 (91) | Stikit™ 20351 | 051141-28583-2 |
| 28495 | 5 (127) | 12,000 | 0.28 (209) | 5/16 (8) | 17 (481) | 74 (85) | 1.8 (.8) | 7 (172) | 4 (91) | Stikit™ 20351 | 051141-28495-8 |
| 28497 | 5 (127) | 12,000 | 0.28 (209) | 3/16 (5) | 17 (481) | 74 (85) | 1.8 (.8) | 7 (172) | 4 (91) | Stikit™ 20351 | 051141-28497-2 |
| 28708 | 5 (127) | 12,000 | 0.28 (209) | 3/16 (5) | 17 (481) | 74 (85) | 1.8 (.8) | 7 (172) | 4 (91) | Hookit™ 20352 | 051141-28708-9 |
| 28498 | 5 (127) | 12,000 | 0.28 (209) | 3/32 (2.5) | 17 (481) | 74 (85) | 1.7 (.8) | 7 (172) | 4 (91) | Stikit™ 20351 | 051141-28498-9 |
| 28582 | 6 (152) | 12,000 | 0.28 (209) | 3/8 (9.5) | 17 (481) | 75 (86) | 1.9 (.9) | 7 (187) | 4 (91) | Stikit™ 20354 | 051141-28582-5 |
| 28499 | 6 (152) | 12,000 | 0.28 (209) | 5/16 (8) | 17 (481) | 75 (86) | 1.9 (.9) | 7 (187) | 4 (91) | Stikit™ 20354 | 051141-28499-6 |
| 28500 | 6 (152) | 12,000 | 0.28 (209) | 3/16 (5) | 17 (481) | 75 (86) | 1.9 (.8) | 7 (187) | 4 (91) | Stikit™ 20354 | 051141-28500-9 |
| 28501 | 6 (152) | 12,000 | 0.28 (209) | 3/32 (2.5) | 17 (481) | 75 (86) | 2.1 (1.0) | 7 (187) | 4 (91) | Stikit™ 20354 | 051141-28501-6 |

3M™ Elite Self-Generated Vacuum Random Orbital Sanders*

Take dust-management to the next level with powerful self-generated vacuum tools. Featuring 3M patented Clean Sanding system with improved filter bag.



| Model No. | Tool Dia. Inch (mm) | Max RPM | Motor HP (W) | Orbit Dia. Inch (mm) | Air Flow Rate SCFM (LPM) | Noise Level dBA (power) | Weight Pound (kg) | Length Inch (mm) | Height Inch (mm) | Pad Included | UPC |
|-----------|---------------------|---------|--------------|----------------------|--------------------------|-------------------------|-------------------|------------------|------------------|---------------|----------------|
| 28511 | 3 (76) | 12,000 | 0.28 (209) | 3/16 (5) | 17 (481) | 85 (96) | 1.7 (.8) | 8 (209) | 4 (93) | Hookit™ 20350 | 051141-28511-5 |
| 28513 | 3 (76) | 12,000 | 0.28 (209) | 3/32 (2.5) | 17 (481) | 85 (96) | 1.4 (.7) | 8 (207) | 3 (88) | Hookit™ 20350 | 051141-28513-9 |
| 28563 | 5 (127) | 12,000 | 0.28 (209) | 3/8 (9.5) | 17 (481) | 84 (95) | 1.9 (.9) | 9 (234) | 4 (93) | Hookit™ 20353 | 051141-28563-4 |
| 28512 | 5 (127) | 12,000 | 0.28 (209) | 5/16 (8) | 17 (481) | 86 (97) | 1.9 (.9) | 9 (234) | 4 (93) | Hookit™ 20353 | 051141-28512-2 |
| 28514 | 5 (127) | 12,000 | 0.28 (209) | 3/16 (5) | 17 (481) | 86 (97) | 1.9 (.9) | 9 (234) | 4 (93) | Hookit™ 20353 | 051141-28514-6 |
| 28515 | 5 (127) | 12,000 | 0.28 (209) | 3/32 (2.5) | 17 (481) | 86 (97) | 1.8 (.8) | 9 (234) | 4 (93) | Hookit™ 20353 | 051141-28515-3 |
| 28562 | 6 (152) | 12,000 | 0.28 (209) | 3/8 (9.5) | 17 (481) | 87 (94) | 2.1 (.9) | 10 (245) | 4 (93) | Hookit™ 20356 | 051141-28562-7 |
| 28510 | 6 (152) | 12,000 | 0.28 (209) | 5/16 (8) | 17 (481) | 88 (99) | 2.0 (.9) | 10 (245) | 4 (93) | Hookit™ 20356 | 051141-28510-8 |
| 28516 | 6 (152) | 12,000 | 0.28 (209) | 3/16 (5) | 17 (481) | 89 (100) | 2.0 (.9) | 10 (245) | 4 (93) | Hookit™ 20356 | 051141-28516-0 |
| 28517 | 6 (152) | 12,000 | 0.28 (209) | 3/32 (2.5) | 17 (481) | 88 (99) | 1.9 (.9) | 10 (245) | 4 (93) | Hookit™ 20356 | 051141-28517-7 |

*One (1) each of the following included: 3M™ Clean Sanding Filter Bag, Filter Bag Adapter, Hose Seal

3M™ Elite Central-Vacuum-Ready Random Orbital Sanders

Easily attaches to your existing central vacuum system for efficient dust-evacuation.



| Model No. | Tool Dia. Inch (mm) | Max RPM | Motor HP (W) | Orbit Dia. Inch (mm) | Airflow Rate SCFM (LPM) | Noise Level dBA (power) | Weight Pound (kg) | Length Inch (mm) | Height Inch (mm) | Pad Included | UPC |
|-----------|---------------------|---------|--------------|----------------------|-------------------------|-------------------------|-------------------|------------------|------------------|---------------|----------------|
| 28503 | 3 (76) | 12,000 | 0.28 (209) | 3/16 (5) | 17 (481) | 72 (83) | 1.8 (.8) | 8 (203) | 4 (93) | Hookit™ 20350 | 051141-28503-0 |
| 28505 | 3 (76) | 12,000 | 0.28 (209) | 3/32 (2.5) | 17 (481) | 72 (83) | 1.4 (.6) | 8 (201) | 3 (88) | Hookit™ 20350 | 051141-28505-4 |
| 28561 | 5 (127) | 12,000 | 0.28 (209) | 3/8 (9.5) | 17 (481) | 73 (84) | 1.9 (.9) | 9 (227) | 4 (93) | Hookit™ 20353 | 051141-28561-0 |
| 28504 | 5 (127) | 12,000 | 0.28 (209) | 5/16 (8) | 17 (481) | 73 (84) | 1.9 (.9) | 9 (227) | 4 (93) | Hookit™ 20353 | 051141-28504-7 |
| 28506 | 5 (127) | 12,000 | 0.28 (209) | 3/16 (5) | 17 (481) | 73 (84) | 1.8 (.8) | 9 (227) | 4 (93) | Hookit™ 20353 | 051141-28506-1 |
| 28507 | 5 (127) | 12,000 | 0.28 (209) | 3/32 (2.5) | 17 (481) | 73 (84) | 1.8 (.8) | 9 (227) | 4 (93) | Hookit™ 20353 | 051141-28507-8 |
| 28560 | 6 (152) | 12,000 | 0.28 (209) | 3/8 (9.5) | 17 (481) | 76 (87) | 2.0 (.9) | 9 (238) | 4 (93) | Hookit™ 20356 | 051141-28560-3 |
| 28502 | 6 (152) | 12,000 | 0.28 (209) | 5/16 (8) | 17 (481) | 76 (87) | 2.0 (.9) | 9 (238) | 4 (93) | Hookit™ 20356 | 051141-28502-3 |
| 28508 | 6 (152) | 12,000 | 0.28 (209) | 3/16 (5) | 17 (481) | 76 (87) | 2.0 (.9) | 9 (238) | 4 (93) | Hookit™ 20356 | 051141-28508-5 |
| 28509 | 6 (152) | 12,000 | 0.28 (209) | 3/32 (2.5) | 17 (481) | 76 (87) | 1.9 (.9) | 9 (238) | 4 (93) | Hookit™ 20356 | 051141-28509-2 |

3M™ Random Orbital Sanders — Original Series

3M™ Self-Generated Vacuum Random Orbital Sanders*

Take dust-management to the next level with powerful self-generated vacuum tools. Featuring 3M patented Clean Sanding system with improved filter bag.



20319



20208/20327

| Model No. | Tool Dia. Inch (mm) | Max RPM | Motor HP (W) | Orbit Dia. Inch (mm) | Air Flow Rate SCFM (LPM) | Noise Level dBA (power) | Weight Pound (kg) | Length Inch (mm) | Height Inch (mm) | Pad Included | UPC |
|-----------|---------------------|---------|--------------|----------------------|--------------------------|-------------------------|-------------------|------------------|------------------|---------------|----------------|
| 20319 | 5 (127) | 12,000 | 0.24 (179) | 3/16 (5) | 17 (481) | 85 (93) | 1.8 (.8) | 9 (219) | 3 (85) | Hookit™ 20353 | 051141-20319-5 |
| 20208 | 6 (150) | 12,000 | 0.24 (179) | 5/16 (8) | 17 (481) | 82 (92) | 2.0 (.9) | 9 (233) | 3 (83) | Hookit™ 20356 | 051141-20208-2 |
| 20327 | 6 (150) | 12,000 | 0.24 (179) | 3/16 (5) | 17 (481) | 83 (92) | 2.0 (.9) | 9 (231) | 3 (85) | Hookit™ 20356 | 051141-20327-0 |

*One (1) each of the following included: 3M™ Clean Sanding Filter Bag, Filter Bag Adapter, Hose Seal

3M™ Non-Vacuum Random Orbital Sanders

Powerful and popular non-vacuum tools meet or exceed highest performance standards.



20317



20324/20325

| Model No. | Tool Dia. Inch (mm) | Max RPM | Motor HP (W) | Orbit Dia. Inch (mm) | Air Flow Rate SCFM (LPM) | Noise Level dBA (power) | Weight Pound (kg) | Length Inch (mm) | Height Inch (mm) | Pad Included | UPC |
|-----------|---------------------|---------|--------------|----------------------|--------------------------|-------------------------|-------------------|------------------|------------------|---------------|----------------|
| 20317 | 5 (127) | 12,000 | 0.24 (179) | 3/16 (5) | 17 (481) | 80 (88) | 1.7 (.8) | 6 (150) | 3 (83) | Stikit™ 20351 | 051141-20317-1 |
| 20324 | 6 (152) | 12,000 | 0.24 (179) | 5/16 (8) | 17 (481) | 77 (85) | 1.8 (.8) | 6 (164) | 3 (83) | Stikit™ 20354 | 051141-20324-9 |
| 20325 | 6 (152) | 12,000 | 0.24 (179) | 3/16 (5) | 17 (481) | 79 (83) | 1.7 (.8) | 6 (162) | 3 (83) | Stikit™ 20354 | 051141-20325-6 |

3M™ Orbital Sanders — Elite Series and Original Series

3M™ Elite Series Orbital Sanders

Ideal for sanding in tight areas or on vertical surfaces.



28527



28528



28529

| Model No. | Vacuum | Tool Size Inch (mm) | Max OPM | Motor HP (W) | Orbit Dia. Inch (mm) | Air Flow Rate SCFM (LPM) | Noise Level dBA (power) | Weight Pound (kg) | Length Inch (mm) | Height Inch (mm) | Pad Included | UPC |
|-----------|----------|--------------------------|---------|--------------|----------------------|--------------------------|-------------------------|-------------------|------------------|------------------|---------------|----------------|
| 28527 | Non-Vac | 2-3/4 x 7-3/4 (70 x 198) | 10,000 | 0.28 (209) | 1/8 (3) | 17 (481) | 75 (86) | 2.1 (1.0) | 8 (206) | 4 (104) | Hookit™ 28531 | 051141-28527-6 |
| 28528 | Central | 2-3/4 x 7-3/4 (70 x 198) | 10,000 | 0.28 (209) | 1/8 (3) | 17 (481) | 72 (83) | 2.2 (1.0) | 10 (261) | 4 (104) | Hookit™ 28531 | 051141-28528-3 |
| 28529 | Self-Gen | 2-3/4 x 7-3/4 (70 x 198) | 10,000 | 0.28 (209) | 1/8 (3) | 17 (481) | 86 (97) | 2.2 (1.0) | 11 (268) | 4 (104) | Hookit™ 28531 | 051141-28529-0 |

3M™ Orbital Sanders

Ideal for sanding in tight areas or on vertical surfaces.



20331



20430



20431

| Model No. | Vacuum | Tool Size Inch (mm) | Max OPM | Motor HP (W) | Orbit Dia. Inch (mm) | Air Flow Rate SCFM (LPM) | Noise Level dBA (power) | Weight Pound (kg) | Length Inch (mm) | Height Inch (mm) | Pad Included | UPC |
|-----------|----------|---------------------|---------|--------------|----------------------|--------------------------|-------------------------|-------------------|------------------|------------------|-----------------------------|----------------|
| 20331 | Non-Vac | 3 x 4 (75 x 100) | 10,000 | 0.24 (179) | 1/8 (3) | 17 (481) | 73 (81) | 1.4 (0.7) | 5 (139) | 3 (84) | Hookit™ 20433 | 051141-20331-7 |
| 20430 | Central | 3 x 4 (75 x 100) | 10,000 | 0.24 (179) | 1/8 (3) | 17 (481) | 72 (82) | 1.5 (0.7) | 5 (139) | 3 (84) | Clean Sanding Hookit™ 20435 | 051141-20430-7 |
| 20431 | Self-Gen | 3 x 4 (75 x 100) | 10,000 | 0.24 (179) | 1/8 (3) | 17 (481) | 88 (93) | 1.6 (0.7) | 6 (142) | 3 (84) | Clean Sanding Hookit™ 20435 | 051141-20431-4 |

3M™ Electric Random Orbital Sanders

Consistent performance when air supply is inadequate or mobility is needed.

- Provides significant energy cost savings vs. air-powered sanders
- Low-profile design enables increased operator control and less vibration
- Whisper-quiet operation
- Exclusive 3M™ Gripping Material and ergonomic wrist rest for increased operator comfort
- Variable speed settings — 7,000, 9,000 and 10,000 RPM — enable customized performance



3M™ Electric Random Orbital Sander Kits

Kits include 3M™ Electric Sander, 3M™ Power Supply w/AC Power Cord (PN28436), 3M™ Power Cord (PN28434) and Disc Pad (Non-Vacuum: 3M™ Stikit™ Disc Pad; Central Vacuum: 3M™ Hookit™ Clean Sanding Disc Pad). Kit includes canvas bag.

| Model No. | Tool Dia. Inch (mm) | Max RPM | Motor HP (W) | Orbit Dia. Inch (mm) | Noise Level dBA (power) | Weight Pound (kg) | Length Inch (mm) | Height Inch (mm) | Pad Included | UPC |
|-----------------------|---------------------|---------|--------------------|----------------------|-------------------------|-------------------|------------------|------------------|---------------|----------------|
| Central Vacuum | | | | | | | | | | |
| 28521 | 6 (150) | 10,000 | 0.2–0.24 (149–179) | 3/32 (2.5) | 70 (81) | 2.2 (1.0) | 9 (225) | 4 (97) | Hookit™ 20356 | 051141-28521-4 |
| 28522 | 6 (150) | 10,000 | 0.2–0.24 (149–179) | 3/16 (5) | 70 (81) | 2.2 (1.0) | 9 (225) | 4 (97) | Hookit™ 20356 | 051141-28522-1 |
| Non-Vacuum | | | | | | | | | | |
| 28525 | 6 (150) | 10,000 | 0.2–0.24 (149–179) | 3/32 (2.5) | 70 (81) | 2.0 (0.9) | 7 (185) | 4 (97) | Stikit™ 20354 | 051141-28525-2 |
| 28526 | 6 (150) | 10,000 | 0.2–0.24 (149–179) | 3/16 (5) | 70 (81) | 2.0 (0.9) | 7 (185) | 4 (97) | Stikit™ 20354 | 051141-28526-9 |

Power Supply Input: 100–240 VAC, 47–63 HZ; Power Supply Output: 30 VDC, 5 Amps

3M™ Power Cords and Power Supply

| Part No. | Description | UPC |
|----------|---|----------------|
| 28434 | 3M™ Power Cord, Low Voltage, 18AWG, 12 ft. (from power supply to sander) | 051141-28434-7 |
| 28435 | 3M™ Power Cord, Extra Long, Low Voltage, 24 ft. (from power supply to sander) | 051141-28435-4 |
| 28436 | 3M™ Power Supply with 3M™ AC Power Cord (28478) | 051141-28436-1 |
| 28478 | 3M™ AC Power Cord, 110 volt (from wall outlet to power supply) | 051141-28478-1 |



3M™ Mini Sanders

3M™ Elite Series Mini Orbital Sander

- Longer life vanes and improved skirt attachment system for greater durability
- Exclusive 3M™ Gripping Material cover for operator comfort
- Aluminum body for lighter weight and improved balance
- 3M™ Roloc™ Attachment System for sanding pad and integral tool hanger for increased usability
- Use with 3M™ Trizact™ Finesse-It™ Paint Repair System



| Model No. | PSI | Tool Size Inch (mm) | Max RPM | Motor HP (W) | Orbit Dia. Inch (mm) | Air Flow Rate SCFM (LPM) | Noise Level dBA (power) | Weight Pound (kg) | Length Inch (mm) | Height Inch (mm) | Pad Included | UPC |
|-----------|-----|---------------------|---------|--------------|----------------------|--------------------------|-------------------------|-------------------|------------------|------------------|-----------------------------|----------------|
| 28737 | 90 | 1-1/4 x 3/16 | 8,000 | 0.48 (358) | 1/8 (3) | 23 (651) | 76 (87) | 0.6 (0.3) | 8 (193) | 4 (104) | Roloc™ 02345 w/Stikit™ Face | 051141-28737-9 |

3M™ Mini-Random Orbital Sander

- Ergonomically designed for operator comfort and control
- Low profile design reduces chance of tipping and undercutting
- Direct mount 3M™ Roloc™ Sanding Pad allows close proximity to the work surface
- Use with 3M™ Trizact™ Finesse-It™ Paint Repair System



| Model No. | PSI | Tool Size Inch (mm) | Max RPM | Motor HP (W) | Orbit Dia. Inch (mm) | Air Flow Rate SCFM (LPM) | Noise Level dBA (power) | Weight Pound (kg) | Length Inch (mm) | Height Inch (mm) | Pad Included | UPC |
|-----------|-----|---------------------|---------|--------------|----------------------|--------------------------|-------------------------|-------------------|------------------|------------------|-----------------------------|----------------|
| 20244 | 90 | 1-1/4 x 3/16 | 8,000 | 0.24 (179) | 3/16 (5) | 15 (425) | 73 (80) | 1.0 (0.5) | 5 (120) | 3 (85) | Roloc™ 02345 w/Stikit™ Face | 051141-20244-0 |

3M™ Sanders, Buffers and Electric Polisher



28337/28335

3M™ Random Orbital Sander, 2-Hand

- For extra leverage and power, choose the two-handed 3M™ Random Orbital Sander
- Features a powerful 0.45 HP motor with 3/8" orbit, built-in muffler and rear exhaust

| Model No. | Vacuum | Tool Dia. Inch (mm) | Max RPM | Motor HP (W) | Orbit Dia. Inch (mm) | Air Flow Rate SCFM (LPM) | Noise Level dBA (power) | Weight Pound (kg) | Length Inch (mm) | Height Inch (mm) | Clean Sanding Pad Included | UPC |
|-----------|-----------------|---------------------|---------|--------------|----------------------|--------------------------|-------------------------|-------------------|------------------|------------------|----------------------------|----------------|
| 28337 | Central/Non-Vac | 6 (150) | 12,000 | 0.45 (336) | 3/8 (9.5) | 21 (594) | 81 (89) | 3 (1.32) | 13 (328) | 4 (113) | Hookit™ 20356* | 051141-28337-1 |
| 28335 | Self-Gen Vac | 6 (150) | 12,000 | 0.45 (336) | 3/8 (9.5) | 21 (594) | 91 (94) | 3 (1.32) | 13 (328) | 4 (113) | Hookit™ 20356* | 051141-28335-7 |

*For 5" sanding using the 2-Hand Sander, use the 5" 3M™ Hookit™ D/F Disc Pad 28411

3M™ Buffers

- Available in rotary or random orbital motions and in multiple sizes
- Excellent choice for a variety of repairs on different substrates across a wide range of industries — from paint and clear coat to lacquered wood, solid surface to acrylic



| Model No. | PSI | Tool Dia. Inch (mm) | Max RPM | Motor HP (W) | Orbit Dia. Inch (mm) | Air Flow Rate SCFM (LPM) | Noise Level dBA (power) | Weight Pound (kg) | Length Inch (mm) | Height Inch (mm) | Air Inlet Thread | UPC |
|-----------|-----|---------------------|---------|--------------|----------------------|--------------------------|-------------------------|-------------------|------------------|------------------|------------------|----------------|
| 28333 | 90 | 3 (75) | 11,000 | 0.26 (194) | 1/2 (12) | 19 (538) | 78 (87) | 1.8 (0.8) | 9 (233) | 4 (99.6) | 1/4" NPT | 051141-28333-3 |
| 28631 | 90 | 3 (75) | 3,500 | 0.26 (194) | Rotary | 17 (481) | 80 (87) | 2.1 (0.9) | 9 (233) | 5 (114) | 1/4" NPT | 051141-28631-0 |
| 28392 | 90 | 5 (127) | 10,000 | 0.45 (336) | 3/8 (10) | 21 (595) | 77 (88) | 2.9 (1.3) | 13 (328) | 4 (113) | 1/4" NPT | 051141-28392-0 |

3M™ Pistol Grip Buffer

- Powerful 0.45 HP motor for faster buffing
- Offset design for greater surface visibility
- Composite body for user comfort



28354

| Model No. | PSI | Tool Dia. Inch (mm) | Max RPM | Motor HP (W) | Orbit Dia. Inch (mm) | Air Flow Rate SCFM (LPM) | Noise Level dBA (power) | Weight Pound (kg) | Length Inch (mm) | Height Inch (mm) | Air Inlet Thread | UPC |
|-----------|-----|---------------------|---------|--------------|----------------------|--------------------------|-------------------------|-------------------|------------------|------------------|------------------|----------------|
| 28354 | 90 | 3 (75) | 2,200 | 0.45 (336) | Rotary | 22 (683) | 80 (88) | 1.8 (0.8) | 5 (132) | 5 (136) | 1/4" NPT | 051141-28354-8 |

3M™ Palm Buffer

- Powerful, lightweight tool designed to fit in the palm of the operator's hand
- Aggressive 1/2-inch orbit for faster buffing or polishing on the clearcoat
- Engineered for maximum operator comfort



28769

| Model No. | PSI | Tool Dia. Inch (mm) | Max RPM | Motor HP (W) | Orbit Dia. Inch (mm) | Air Flow Rate SCFM (LPM) | Noise Level dBA (power) | Weight Pound (kg) | Length Inch (mm) | Height Inch (mm) | Air Inlet Thread | UPC |
|-----------|-----|---------------------|---------|--------------|----------------------|--------------------------|-------------------------|-------------------|------------------|------------------|------------------|----------------|
| 28769 | 90 | 3 (77) | 12,000 | 0.28 (209) | 1/2 (12) | 17 (481) | 79 (90) | 1.5 (0.7) | 5.8 (147) | 3.6 (92.5) | 1/4" NPT | 051141-28769-0 |

3M™ Electric Variable Speed Polisher

Designed to compound/buff/polish various substrates including but not limited to automotive paint, marine finishes, fiberglass gel coat, acrylics, etc.



28391

| Model No. | VAC | Tool Dia. Inch (mm) | Max RPM | Motor Amp | Shaft Size | Weight Pound (kg) | Length Inch (mm) | Height Inch (mm) | UPC |
|-----------|-----|---------------------|---------|-----------|------------|-------------------|------------------|------------------|----------------|
| 28391 | 120 | 7 (178) | 3,000 | 11 | 5/8-11 EXT | 6.6 (3.0) | 17 (432) | 4 (111) | 051141-28391-3 |

3M™ Sander/Buffer



28773

| Model No. | PSI | Tool Dia. Inch (mm) | Max RPM | Motor HP (W) | Orbit Dia. Inch (mm) | Air Flow Rate SCFM (LPM) | Noise Level dBA (power) | Weight Pound (kg) | Length Inch (mm) | Height Inch (mm) | Air Inlet Thread | UPC |
|-----------|-----|---------------------|---------|--------------|----------------------|--------------------------|-------------------------|-------------------|------------------|------------------|------------------|----------------|
| 28773 | 90 | 5-6 (127-152) | 3,500 | 1 (744) | Rotary | 37 (1,048) | 89 (89) | 3.3 (1.5) | 10 (254) | 4 (95) | 1/4" NPT | 051141-28773-7 |

3M™ Die Grinders

NEW! 3M™ Die Grinders — 0.3 HP (224W)

- Ideal for light-duty applications such as deburring, blending, finishing and polishing in intricate and hard-to-reach areas
- Exclusive 3M™ Gripping Material reduces vibration and provides a more secure grip.



| Model No. | Max RPM | Air Flow Rate SCFM (LPM) | Noise Level dBA (power) | Weight Pound (kg) | Length Inch (mm) | Height Inch (mm) | Air Inlet Thread | Collet Size | UPC |
|-------------------|---------|-----------------------------|----------------------------|----------------------|---------------------|---------------------|------------------|-------------------|----------------|
| NEW! 28630 | 25,000 | 17 (481) | 86 (98) | 1.4 (0.6) | 10 (248) | 1 (35) | 1/4" NPT | 1/4" [†] | 051141-28630-3 |
| NEW! 28629 | 25,000 | 17 (481) | 78 (90) | 0.9 (0.4) | 6 (152) | 1 (35) | 1/4" NPT | 1/4" [†] | 051141-28629-7 |
| NEW! 28628 | 18,000 | 17 (481) | 80 (92) | 1.5 (0.7) | 11 (267) | 1 (35) | 1/4" NPT | 1/4" [†] | 051141-28628-0 |
| NEW! 28627 | 18,000 | 17 (481) | 79 (91) | 1.2 (0.5) | 7 (184) | 1 (35) | 1/4" NPT | 1/4" [†] | 051141-28627-3 |

[†]Includes 1/8" collet insert (PN55772)

NEW! 3M™ Die Grinders — 0.5 HP (372W)

- Ideal for medium-duty applications such as polishing, buffing, shaping and deburring
- Exclusive 3M™ Gripping Material reduces vibration and provides a more secure grip



| Model No. | Max RPM | Air Flow Rate SCFM (LPM) | Noise Level dBA (power) | Weight Pound (kg) | Length Inch (mm) | Height Inch (mm) | Air Inlet Thread | Collet Size | UPC |
|-------------------|---------|-----------------------------|----------------------------|----------------------|---------------------|---------------------|------------------|-------------------|----------------|
| NEW! 28330 | 18,000 | 26 (736) | 87 (99) | 1.1 (0.5) | 7 (175) | 3 (70) | 1/4" NPT | 1/4" [†] | 051141-28330-2 |
| NEW! 28331 | 18,000* | 26 (736) | 87 (99) | 1.5 (0.7) | 11 (270) | 3 (70) | 1/4" NPT | 1/4" [†] | 051141-28331-9 |
| NEW! 28332 | 4,000 | 26 (736) | 87 (99) | 1.6 (0.7) | 9 (200) | 3 (70) | 1/4" NPT | 1/4" [†] | 051141-28332-6 |

*With extension

[†]Available in metric collet

3M™ Die Grinders — 1 HP (744W)

- Excellent for big jobs such as weld or stock removal
- Exclusive 3M™ Gripping Material reduces vibration and provides a more secure grip



| Model No. | Max RPM | Air Flow Rate SCFM (LPM) | Noise Level dBA (power) | Weight Pound (kg) | Length Inch (mm) | Height Inch (mm) | Air Inlet Thread | Collet Size | UPC |
|-----------|---------|-----------------------------|----------------------------|----------------------|---------------------|---------------------|------------------|-------------|----------------|
| 20237 | 20,000 | 37 (1,048) | 84 (95) | 1.7 (0.8) | 8 (197) | 3 (73) | 1/4" NPT | 1/4" | 051141-20237-2 |
| 20238 | 18,000 | 37 (1,048) | 84 (95) | 1.7 (0.8) | 8 (197) | 3 (73) | 1/4" NPT | 1/4" | 051141-20238-9 |
| 28770 | 18,000 | 37 (1,048) | 84 (95) | 2.6 (1.2) | 13 (318) | 3 (73) | 1/4" NPT | 1/4" | 051141-28770-6 |
| 20239 | 12,000 | 37 (1,048) | 84 (95) | 2.1 (0.9) | 10 (254) | 3 (81) | 1/4" NPT | 1/4" | 051141-20239-6 |
| 20240 | 8,000 | 37 (1,048) | 84 (95) | 2.1 (0.9) | 10 (254) | 3 (81) | 1/4" NPT | 1/4" | 051141-20240-2 |

Collet Insert Availability for 3M™ Die Grinders



| Tool Model No. | HP | RPM | Length | Collet Insert Size and Part Number | | | | | | | | |
|-------------------|-----|--------|----------|------------------------------------|-----------------|------------------|-----------------|-----------------|-----------------|-----------------|-----------------|-----------------|
| | | | | 1/8" (06573) | 1/8" (55772) | 3/16" (06574) | 1/4" (06575) | 1/4" (55752) | 3/8" (06545) | 3 mm (06576) | 6 mm (06577) | 8 mm (06546) |
| 28630 | 0.3 | 25,000 | Extended | | ■ | | | | ■ | | | |
| 28629 | 0.3 | 25,000 | Regular | | ■ | | | | ■ | | | |
| 28628 | 0.3 | 18,000 | Extended | | ■ | | | | ■ | | | |
| 28627 | 0.3 | 18,000 | Regular | | ■ | | | | ■ | | | |
| 28330 | 0.5 | 18,000 | Regular | ■ | | ■ | ■ | | ■ | ■ | ■ | ■ |
| 28331 | 0.5 | 18,000 | Extended | ■ | | ■ | ■ | | ■ | ■ | ■ | ■ |
| 28332 | 0.5 | 4,000 | Regular | ■ | | ■ | ■ | | ■ | ■ | ■ | ■ |
| 20237 | 1 | 20,000 | Regular | ■ | | ■ | ■ | | ■ | ■ | ■ | ■ |
| 20238 | 1 | 18,000 | Regular | ■ | | ■ | ■ | | ■ | ■ | ■ | ■ |
| 28770 | 1 | 18,000 | Extended | ■ | | ■ | ■ | | ■ | ■ | ■ | ■ |
| 20239 | 1 | 12,000 | Regular | ■ | | ■ | ■ | | ■ | ■ | ■ | ■ |
| 20240 | 1 | 8,000 | Regular | ■ | | ■ | ■ | | ■ | ■ | ■ | ■ |

3M™ Disc Sanders

3M™ Disc Sanders

- 3M™ Gripping Material for reduced vibration and a secure grip with less effort
- 97° head for decreased wrist strain
- Easy-handling, compact design for less vibration
- 3M™ Roloc™ Disc Pads can directly mount to sander without collet
- 1/4" collet included with all 2" and 3" disc sanders



| Model No. | Tool Dia. Inch (mm) | Motor HP (W) | Max RPM | Air Flow Rate SCFM (LPM) | Noise Level dBA (power) | Weight Pound (kg) | Length Inch (mm) | Height Inch (mm) | Air Inlet Thread | Collet Size | UPC |
|-------------------|------------------------|-----------------|------------|-----------------------------|----------------------------|----------------------|---------------------|---------------------|---------------------|----------------|----------------|
| NEW! 28341 | 2 (51) | 0.3 (224) | 20,000 | 17 (481) | 81 (92) | 1.1 (0.5) | 6 (150) | 3 (63) | 1/4" NPT | 1/4"† | 051141-28341-8 |
| NEW! 28328 | 2-3 (51-76) | 0.3 (224) | 12,000 | 17 (481) | 81 (92) | 1.1 (0.5) | 7 (172) | 3 (64) | 1/4" NPT | 1/4"† | 051141-28328-9 |
| NEW! 20231 | 2 (51) | 0.5 (372) | 20,000 | 26 (736) | 89 (101) | 1.3 (0.6) | 7 (172) | 3 (70) | 1/4" NPT | 1/4"† | 051141-20231-0 |
| NEW! 28329 | 2-3 (51-76) | 0.5 (372) | 12,000 | 26 (736) | 89 (101) | 1.3 (0.6) | 7 (172) | 3 (70) | 1/4" NPT | 1/4"† | 051141-28329-6 |
| 20232 | 2-3 (51-76) | 1 (744) | 15,000 | 37 (1,048) | 84 (95) | 2.0 (0.9) | 8 (210) | 3 (83) | 1/4" NPT | 1/4" | 051141-20232-7 |
| 28408 | 4-5 (100-127) | 1 (744) | 12,000 | 37 (1,048) | 84 (95) | 3.1 (1.4) | 8 (210) | 4 (107) | 3/8" NPT* | 1/4" | 051141-28408-8 |
| 28622 | 4-5 (100-127) | 1 (744) | 12,000 | 37 (1,048) | 84 (95) | 4.0 (1.8) | 12 (292) | 5 (119) | 3/8" NPT* | 1/4" | 051141-28622-8 |
| NEW! 28825 | 4-1/2-5 (114.3-127) | 1.5 (1,120) | 12,000 | 40 (1,133) | 90 (82) | 4.9 (2.2) | 11 (279) | 4 (102) | 1/2" FNPT | 1/4" | 051141-28825-3 |

*Includes 3/8" to 1/4" reducer

†Available in metric collet

3M™ Pistol Grip Disc Sander

- Lightweight, low cost alternative to production tools for customers who need a tool for spot duty or intermittent use
- Excellent balance and generates less noise and vibration than other disc sanders
- Durable composite body for ergonomic feel
- Dual mount feature allows user to switch between direct mount (for maximum control) and collet mount (for extended reach); 1/4" collet included



| Model No. | PSI | Tool Dia. Inch (mm) | Max RPM | Motor HP (W) | Orbit Dia. Inch (mm) | Air Flow Rate SCFM (LPM) | Noise Level dBA (power) | Weight Pound (kg) | Length Inch (mm) | Height Inch (mm) | Thread Size | UPC |
|-----------|-----|------------------------|------------|-----------------|-------------------------|-----------------------------|----------------------------|----------------------|---------------------|---------------------|----------------|----------------|
| 28547 | 90 | 3 (76) | 15,000 | 0.45 (336) | Rotary | 23 (651) | 74 (85) | 1.8 (0.8) | 5 (122) | 5 (136) | 1/4-20 EXT | 051141-28547-4 |

3M™ Pistol Grip Random Orbital Disc Sander

- Primarily intended for sanding in the automotive market
- Powerful, lightweight tool with excellent balance
- Durable composite body for ergonomic feel
- Pistol grip design allows you to sand in hard-to-reach areas such as those found in door jambs, bumpers, headlight lens, etc. with ease



| Model No. | PSI | Tool Dia. Inch (mm) | Max RPM | Motor HP (W) | Orbit Dia. Inch (mm) | Air Flow Rate SCFM (LPM) | Noise Level dBA (power) | Weight Pound (kg) | Length Inch (mm) | Height Inch (mm) | Thread Size | UPC |
|-----------|-----|------------------------|------------|-----------------|-------------------------|-----------------------------|----------------------------|----------------------|---------------------|---------------------|----------------|----------------|
| 28353* | 90 | 3 (76) | 15,000 | 0.45 (336) | 1/8 (3) | 22 (623) | 75 (82) | 1.8 (0.8) | 5 (122) | 5 (136) | 5/16-24 EXT | 051141-28353-1 |

*Replacement Pad PN20427

Collet Insert Availability for 3M™ Disc Sanders



| Tool Model No. | HP | RPM | Length | Collet Insert Size and Part Number | | | | |
|-------------------|-----|--------|----------|------------------------------------|--------------|---------------|--------------|--------------|
| | | | | 1/4" (06528) | 1/8" (06529) | 3/16" (06530) | 3 mm (06540) | 6 mm (06541) |
| 28341 | 0.3 | 20,000 | Regular | ■ | ■ | ■ | ■ | ■ |
| 28328 | 0.3 | 12,000 | Regular | ■ | ■ | ■ | ■ | ■ |
| 20231 | 0.5 | 20,000 | Regular | ■ | ■ | ■ | ■ | ■ |
| 28329 | 0.5 | 12,000 | Regular | ■ | ■ | ■ | ■ | ■ |
| 20232 | 1 | 15,000 | Regular | ■ | ■ | ■ | ■ | ■ |
| 28408 | 1 | 12,000 | Regular | ■ | ■ | ■ | ■ | ■ |
| 28622 | 1 | 12,000 | Extended | ■ | ■ | ■ | ■ | ■ |



3M™ Grinders — Type 27

3M™ Grinders — Type 27

- Steel gear heads for added durability under high force applications
- Thermally balanced motor helps stop tool from getting cold to the touch
- 3M™ Gripping Material for reduced vibration and a secure grip with less effort
- Repositionable steel guards for better visibility



| Model No. | Tool Dia. Inch (mm) | Motor HP (W) | Max RPM | Air Flow Rate SCFM (LPM) | Noise Level dBA (power) | Weight Pound (kg) | Length Inch (mm) | Height Inch (mm) | Air Inlet Thread | Thread Size | UPC |
|-------------------|------------------------|-----------------|------------|-----------------------------|----------------------------|----------------------|---------------------|---------------------|---------------------|-------------|----------------|
| 28403 | 4 (100) | 1 (744) | 12,000 | 37 (1,048) | 86 (98) | 2.7 (1.2) | 9 (216) | 5 (114) | 3/8" NPT* | 3/8-24 EXT | 051141-28403-3 |
| 28413 | 4 (100) | 1 (744) | 12,000 | 37 (1,048) | 91 (103) | 2.6 (1.2) | 12 (292) | 5 (114) | 3/8" NPT* | 3/8-24 EXT | 051141-28413-2 |
| 28405 | 4-1/2 (114.3) | 1 (744) | 12,000 | 37 (1,048) | 85 (99) | 3.9 (1.8) | 9 (216) | 5 (119) | 3/8" NPT* | 5/8-11 EXT | 051141-28405-7 |
| 28414 | 4-1/2 (114.3) | 1 (744) | 12,000 | 37 (1,048) | 86 (95) | 4.0 (1.8) | 12 (292) | 5 (119) | 3/8" NPT* | 5/8-11 EXT | 051141-28414-9 |
| NEW! 28824 | 4-1/2-5 (114.3-127) | 1.5 (1,120) | 12,000 | 40 (1,133) | 84 (92) | 5.3 (2.4) | 11 (279) | 4 (105) | 1/2" FNPT | 5/8-11 EXT | 051141-28824-6 |

*Includes 3/8" to 1/4" reducer

Optional Grinder Guards

Optional guard allows 4" grinder to run larger, thicker 4-1/2" fibre and flap discs.



| Model No. | Size | For Use With Tool | Required Accessories | UPC |
|-------------------|-----------------|--|-------------------------------------|----------------|
| 55106 | 4-1/2" | 3M™ Grinders — 4" (Model No. 28403; 28413) | Accessories with 3/8-24 INT threads | 051141-29403-3 |
| 28632 | 5" | 3M™ Disc Sanders, 1 HP — 4"-5" (Model No. 28408) | Accessories with 5/8-11 INT threads | 051141-28632-7 |
| NEW! 54062 | 4-1/2" Standard | 3M™ Grinders, 1.5 HP — 4.5"-5" (Model No. 28824) | Accessories with 5/8-11 INT threads | 051141-54062-7 |
| NEW! 54063 | 4-1/2" Jumbo | 3M™ Grinders, 1.5 HP — 4.5"-5" (Model No. 28824) | Accessories with 5/8-11 INT threads | 051141-54063-4 |
| NEW! 54064 | 4-1/2" | 3M™ Cut-Off Wheels, 1.5 HP — 4.5"-5" (Model No. 28826) | Accessories with 5/8-11 INT threads | 051141-54064-1 |
| NEW! 54065 | 5" Standard | 3M™ Grinder,s 1.5 HP — 4.5"-5" (Model No. 28824) | Accessories with 5/8-11 INT threads | 051141-54065-8 |
| NEW! 54066 | 5" Jumbo | 3M™ Grinders, 1.5 HP — 4.5"-5" (Model No. 28824) | Accessories with 5/8-11 INT threads | 051141-54066-5 |
| NEW! 54067 | 5" | 3M™ Cut-Off Wheels, 1.5 HP — 4.5"-5" (Model No. 28826) | Accessories with 5/8-11 INT threads | 051141-54067-2 |

* See page 22 for other appropriate accessories.

3M™ Cut-Off Wheel Tools

3M™ Cut-Off Wheel Tools

- Easily cuts through everything from standard rebar to oversized bolts
- Exclusive 3M™ Gripping Material for added comfort
- Extended model provides greater versatility and control with right angle head and repositionable guard



| Model No. | Tool Dia. Inch (mm) | Motor HP (W) | Max RPM | Air Flow Rate SCFM (LPM) | Noise Level dBA (power) | Weight Pound (kg) | Length Inch (mm) | Height Inch (mm) | Air Inlet Thread | UPC |
|-------------------|---------------------|--------------|---------|--------------------------|-------------------------|-------------------|------------------|------------------|------------------|----------------|
| 20233 | 3 (76) | 1 (744) | 25,000 | 37 (1,048) | 84 (96) | 2.1 (1.0) | 8 (197) | 3 (76) | 1/4" NPT | 051141-20233-4 |
| 20234 | 4 (100) | 1 (744) | 20,000 | 37 (1,048) | 84 (96) | 2.3 (1.0) | 8 (197) | 3 (83) | 3/8" NPT | 051141-20234-1 |
| 28771† | 4 (100) | 1 (744) | 19,000 | 37 (1,048) | 84 (96) | 2.3 (1.0) | 8 (197) | 3 (83) | 3/8" NPT | 051141-28771-3 |
| 20235 | 5 (125) | 1 (744) | 12,000 | 37 (1,048) | 84 (96) | 3.5 (1.6) | 9 (222) | 5 (133) | 3/8" NPT | 051141-20235-8 |
| 20236 | 6 (152) | 1 (744) | 10,000 | 37 (1,048) | 84 (96) | 3.7 (1.7) | 9 (222) | 5 (133) | 3/8" NPT | 051141-20236-5 |
| 28407 | 4 (100) | 1 (744) | 18,000 | 37 (1,048) | 86 (97) | 2.3 (1.0) | 12 (292) | 4 (108) | 3/8" NPT* | 051141-28407-1 |
| NEW! 28826 | 4-1/2-5 (115-125) | 1.5 (1,120) | 12,000 | 40 (1,133) | 84 (92) | 5.5 (2.5) | 11 (279) | 4 (111) | 1/2" FNPT | 051141-28826-0 |

†Replaces Model No. 20234
*Includes 3/8" to 1/4" reducer

Replacement Parts for 1.5 HP Power Tools

3M™ Wrench, Spanner



| Part No. | Size | Description | UPC | Case Quantity |
|----------|-----------------|---|----------------|---------------|
| 54105 | 4mm x 30mm B.C. | Replacement Part for 3M™ Sander/Grinder, 1.5 HP. Used to tighten/loosen flange nut. | 051141-54105-1 | 1 |

Gear Oil

| Part No. | Size | Description | UPC | Case Quantity |
|----------|-------|--|----------------|---------------|
| 28827 | 4 oz. | Replacement Part for 3M™ Sander/Grinder, 1.5 HP. Use to lubricate gears. | 051141-28827-7 | 6 |



3M™ Rebuild Kits

| Part No. | Description | UPC | Case Quantity |
|----------|---|----------------|---------------|
| 54106 | Special tools needed to disassemble and reassemble 1.5 HP 3M Power Tools | 051141-54106-8 | 1 |
| 54107 | Replacement parts most likely needed to rebuild the 1.5 HP 3M Power Tools | 051141-54107-5 | 1 |

3M™ Inline Sanders

3M™ Inline Sanders — 1 HP (744W)

- Generate straight line scratches for finishing stainless steel and other metals
- Use with inflatable or slotted wheel accessories and many other wheel products



| Model No. | Max RPM | Air Flow Rate SCFM (LPM) | Noise Level dBA (power) | Weight Pound (kg) | Length Inch (mm) | Air Inlet Thread | Shaft Size | UPC |
|-----------|---------|-----------------------------|----------------------------|----------------------|---------------------|------------------|-------------|----------------|
| 28338 | 1,600 | 37 (1,048) | 83 (95) | 3.3 (1.5) | 10 (251) | 1/4" NPT | 5/8"-11 EXT | 051141-28338-8 |
| 28339 | 3,500 | 37 (1,048) | 85 (97) | 2.6 (1.2) | 9 (216) | 1/4" NPT | 5/8"-11 EXT | 051141-28339-5 |



3M™ Rubber Slotted Expander Wheels

| Part No. | Size | Description | UPC |
|-----------------------------|-----------------------|---|----------------|
| Use with 3M™ Inline Sanders | | | |
| 77722 | 3" x 3" x 5/8-11 INT | Rubber slotted expander wheel for use with 3" x 3" bands | 051144-77722-8 |
| 28348 | 5" x 3-1/2" x 5/8" AH | Rubber slotted expander wheel for use with 3-1/2" W x 15-1/2" L belts | 051141-28348-7 |
| 28349 | 3-2/5" x 3" x 5/8" AH | Rubber slotted expander wheel for use with 3" W x 10-11/16" L belts | 051141-28349-4 |
| 28718 | 5" x 3-1/2" x 1" AH | Rubber slotted expander wheel for use with 3-1/2" W x 15-1/2" L belts | 051141-28718-8 |

3M™ Wheel Adapter Kits* Fits wheels with 5/8" or 1" AH

| Part No. | Thread Size | Description | UPC | Case Quantity |
|----------|-------------------------|--------------------------------------|----------------|---------------|
| 45038 | 5/8-11 INT x 5/8-11 EXT | For use with Expander Wheels | 051144-45038-1 | 1 |
| 04019 | 5/8-11 INT x 5/8-11 EXT | For use with Scotch-Brite™ Wheels | 048011-04019-6 | 1 |
| 28419 | 5/8-11 INT x 1/2-20 EXT | For use with 1/2" Center Hole Wheels | 051141-28419-4 | 1 |



*Kits include spacers, flanges and end nuts to mount expander wheels and other Scotch-Brite™ Wheels.

3M™ Match and Finish Sander

3M™ Match and Finish Sander

- Easy-to-operate tool for generating straight line finishes for stainless steel and other metals
- Use with Scotch-Brite™ Match and Finish Flap Brushes and 3M™ Rubber Slotted Expander Wheels



| Model No. | Max RPM | Motor HP (W) | Air Flow Rate SCFM (LPM) | Noise Level dBA (power) | Weight Pound (kg) | Length Inch (mm) | Air Inlet Thread | Shaft Size | UPC |
|-----------|---------|-----------------|-----------------------------|----------------------------|----------------------|---------------------|------------------|-------------|----------------|
| 28659 | 3,500 | 1 (744) | 37 (1,048) | 89 (89) | 4.6 (2.1) | 14 (343) | 1/4" NPT | 5/8"-11 EXT | 051141-28659-4 |

3M™ Rubber Slotted Expander Wheel and Adapter Kit



| Part No. | Size | Description | UPC |
|--------------------------------------|---------------------|---|----------------|
| Use with 3M™ Match and Finish Sander | | | |
| 28718 | 5" x 3-1/2" x 1" AH | Rubber slotted expander wheel for use with 3-1/2" x 15-1/2" belts | 051141-28718-8 |
| 28719 | 1" x 5/8-11 INT | Wheel Adapter Kit to mount 28718 wheel on 3M™ Match and Finish Sander | 051141-28719-5 |

3M™ File Belt Sander

3M™ File Belt Sander and Kit*

- Great for deburring, cleaning, blending and finishing in tight or hard-to-reach areas
- Balanced weight distribution and 3M™ Gripping Material for improved ergonomics and reduced wrist strain
- 360° rotatable housing and handle for the ultimate in versatility
- Attached belt cover won't fall off during belt changes
- Optimized belt speed for 3M™ Abrasive Belts and Scotch-Brite™ Belts









| Model No. | Motor | Max RPM | Belt Speed SFPM (SMM) | Air Flow Rate SCFM (LPM) | Noise Level dBA (power) | Weight Pound (kg) | Length Inch (mm) | Height Inch (mm) | Width Inch (mm) | UPC |
|-----------|--|---------|-----------------------|--------------------------|-------------------------|-------------------|------------------|------------------|-----------------|----------------|
| 28366 | 0.6 HP | 22,000 | 4990 (1521) | 28 (793) | 81 (90) | 2.8 (1.3) | 15 (370) | 3 (75) | 6 (151) | 051141-28366-1 |
| 28367 | Kit includes Molded Case, File Belt Sander (PN28366) and two Attachment Arms (PNs 28368, 28370)* | | | | | | | | | 051141-28367-8 |

*For additional file belt sander accessories, see page 23.



3M™ File Belt Sander Attachment Arms

| Part No. | Use With Belt Size | Description | UPC | Case Quantity |
|---|--|---|----------------|---------------|
|  28368 | 1/2" x 18" | Standard Style: Standard arm included with 3M™ File Belt Sander (PN28366). Sand with contact wheel or platen. | 051141-28368-5 | 1 |
|  28369 | 1/2" x 18" | Thin Style: Thinner than standard arm. Sand with contact wheel or platen. | 051141-28369-2 | 1 |
|  28370 | 1/8" x 18" 1/4" x 18" 1/2" x 18" | Corners Style: Sand corners and grooves with contact wheel. Accommodates three belt widths. | 051141-28370-8 | 1 |
|  28371 | 5/8" x 18" 3/4" x 18" | Thick Standard Style: Thicker than standard arm. Sand with contact wheel or platen. Accommodates two belt widths. | 051141-28371-5 | 1 |
|  28372 | 1/8" x 18" 1/4" x 18" | Corners Style: Sand corners and grooves with contact wheel. Accommodates two belt widths. | 051141-28372-2 | 1 |
|  28374 | 1/2" x 18" | Curved Arm: Unique curved arm used for blending flat areas. Sand with contact wheel or platen. | 051141-28374-6 | 1 |
|  28375 | 1/4" x 24" 1/2" x 24" | Vessel Arm: Unique large arm used for blending weld seams. Sand with 4" contact wheel. Includes tracking/control knob. Accommodates two belt widths. | 051141-28375-3 | 1 |

3M™ File Belt Sander Extension

| Part No. | Description | UPC | Case Quantity |
|---|--|----------------|---------------|
|  28376 | Use to extend arms to 24" length. Can be used with same attachment arm used for 18" length arms. | 051141-28376-0 | 1 |



Orbital/Random Orbital Sander Accessories

How to Assemble Self-Generated and Central Vacuum Sanding Systems

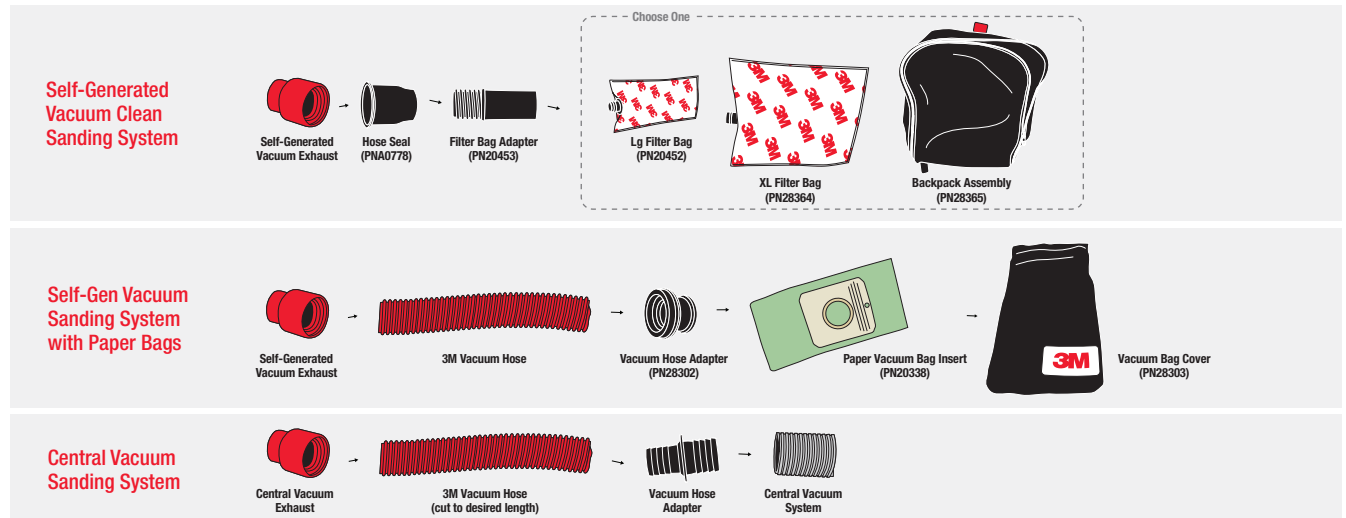

3M™ Clean Sanding Filter Bags and Adapters

| Part No. | Description | UPC | MOQ |
|----------|--|----------------|-----|
| 20452 | Large Filter Bag — HEPA-rated (holds up to 0.5 lbs.) | 051141-20452-9 | 50 |
| 28364 | Extra-Large Filter Bag — HEPA-rated (holds up to 3 lbs.) | 051141-28364-7 | 20 |
| 28365 | Backpack Assembly (holds PN28364) | 051141-28365-4 | 1 |
| 28383 | Filter Bag End Cap — 1" Diameter | 051141-28383-8 | 1 |
| 20453 | Filter Bag Adapter — 1" EXT Hose Thread x 1" Diameter | 051141-20453-6 | 10 |
| A0778 | Hose Seal | 051115-28146-4 | 1 |



3M™ Paper Vacuum Bags and Adapters

| Part No. | Item | Description | Size | UPC | MOQ |
|----------|---------------------------------|---|----------|----------------|-----|
| 20338 | Paper Vacuum Bag Inserts, Green | Collects dust when used with Self-Gen Vacuum Sander | 1" INT | 051141-20338-6 | 50 |
| 28303 | Vacuum Bag Cover | Holds and protects paper vacuum bag inserts (PN20338) | 9" x 20" | 051141-28303-6 | 1 |
| 28302 | Vacuum Hose Adapter | Connects 1" EXT vacuum hose to paper vacuum inserts (PN20338) | 1" INT | 051141-28302-9 | 1 |

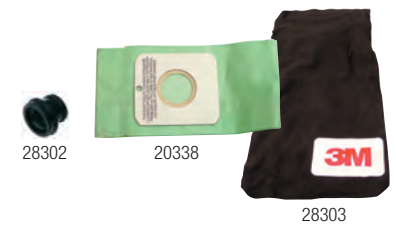

3M™ Vacuum Hoses

| Part No. | Item | Inner Dia. | Length | Thread | UPC | MOQ |
|----------|-----------------------------|------------|--------|--------|----------------|-----|
| 28730 | 3M™ Vacuum Hose Anti-Static | 1" | 4 ft. | 1" EXT | 051141-28730-0 | 1 |
| 28301 | 3M™ Vacuum Hose | 1" | 6 ft. | 1" EXT | 051141-28301-2 | 1 |
| 28393 | 3M™ Vacuum Hose | 1" | 60 ft. | 1" EXT | 051141-28393-7 | 1 |



3M™ Vacuum Hose Adapters

| Part No. | Item | End 1 | End 2 | UPC | MOQ |
|----------|-------------------------|---------------|-------------------|----------------|-----|
| 30442 | 3M™ Vacuum Hose Adapter | 1" INT Thread | 1" INT Thread | 051141-30442-7 | 1 |
| 20340 | 3M™ Vacuum Hose Adapter | 1" INT Thread | 1-1/4" INT Thread | 051141-20340-9 | 1 |
| 28304 | 3M™ Vacuum Hose Adapter | 1" EXT Thread | 1" Push-On | 051141-28304-3 | 1 |
| 30324 | 3M™ Vacuum Hose Adapter | 1" INT Thread | 3/4" Push-On | 051141-30324-6 | 1 |
| 20341 | 3M™ Vacuum Hose Adapter | 1" INT Thread | 1-1/2" Push-On | 051141-20341-6 | 1 |
| 30441 | 3M™ Vacuum Hose Adapter | 1" Push-On | 1-1/4" Push-On | 051141-30441-0 | 1 |
| 30440 | 3M™ Vacuum Hose Adapter | 1" Push-On | 1-1/2" Push-On | 051141-30440-3 | 1 |
| 30439 | 3M™ Vacuum Hose Adapter | 1" Push-On | 2" Push-On | 051141-30439-7 | 1 |



Scotch™ 48 Thread Sealant and Lubricant Tape

| Part No. | Description | Size | UPC | MOQ |
|----------|---|-------------|----------------|-----|
| 06195 | Seals and lubricates threaded connections | 1/2" x 260" | 054007-06195-3 | 12 |



Orbital/Random Orbital Sander Accessories

3M™ Random Orbital Sander Grips — Elite and Original Series

| Part No. | Sander Series | Size | Diameter | UPC |
|----------|-----------------|--------|---------------------------|----------------|
| 55204 | Elite Series | Small | 2-1/2" | 051141-55204-0 |
| 55205 | Elite Series | Medium | 2-3/4" (Standard on Tool) | 051141-55205-7 |
| 55206 | Elite Series | Large | 3" | 051141-55206-4 |
| 20342 | Original Series | Small | 2-1/2" | 051141-20342-3 |
| 20343 | Original Series | Medium | 2-3/4" (Standard on Tool) | 051141-20343-0 |
| 20344 | Original Series | Large | 3" | 051141-20344-7 |



3M™ Orbital/Random Orbital Sander Drop In Motors



| Part No. | Tool Size Inch (mm) | Orbit Diameter Inch (mm) | Description | UPC | MOQ |
|----------|------------------------|-----------------------------|------------------|----------------|-----|
| 28318 | 1-1/4 (32) | 3/16 (5) | Mini | 051141-28318-0 | 1 |
| 30445 | 3 (76) | 1/2 (12) | for Original ROS | 051141-30445-8 | 1 |
| 20216 | 3 (76) | 3/32 (2.5) | for Original ROS | 051141-20216-7 | 1 |
| 20217 | 3 (76) | 3/16 (5) | for Original ROS | 051141-20217-4 | 1 |
| 20218 | 5 (127) | 3/32 (2.5) | for Original ROS | 051141-20218-1 | 1 |
| 01811 | 5 (127) | 3/16 (5) | for Original ROS | 051122-01811-4 | 1 |
| 20256 | 5 (127) | 5/16 (8) | for Original ROS | 051141-20256-3 | 1 |
| 01812 | 6 (150) | 3/32 (2.5) | for Original ROS | 051122-01812-1 | 1 |
| 20221 | 6 (150) | 3/16 (5) | for Original ROS | 051141-20221-1 | 1 |
| 20222 | 6 (150) | 5/16 (8) | for Original ROS | 051141-20222-8 | 1 |
| 30443 | 6 (150) | 3/16 (5) | Two-Hand | 051141-30443-4 | 1 |
| 30444 | 6 (150) | 3/8 (10) | Two-Hand | 051141-30444-1 | 1 |
| 20223 | 3 x 4 (76 x 100) | 1/8 (3.2) | for Original ROS | 051141-20223-5 | 1 |
| 55434 | 5 (127) | 3/32 (2.5) | for Electric ROS | 051141-55434-1 | 1 |
| 55435 | 5 (127) | 3/16 (5) | for Electric ROS | 051141-55435-8 | 1 |
| 55436 | 6 (150) | 3/32 (2.5) | for Electric ROS | 051141-55436-5 | 1 |
| 55437 | 6 (150) | 3/16 (5) | for Electric ROS | 051141-55437-2 | 1 |
| 28605 | 3 (76) | 3/32 (2.5) | for Elite ROS | 051141-28605-1 | 1 |
| 28606 | 3 (76) | 3/32 (2.5) | for Elite ROS | 051141-28606-8 | 1 |
| 28607 | 5 (127) | 3/32 (2.5) | for Elite ROS | 051141-28607-5 | 1 |
| 28608 | 5 (127) | 3/16 (5) | for Elite ROS | 051141-28608-2 | 1 |
| 28609 | 5 (127) | 5/16 (8) | for Elite ROS | 051141-28609-9 | 1 |
| 28610 | 5 (127) | 3/8 (10) | for Elite ROS | 051141-28610-5 | 1 |
| 28611 | 6 (150) | 3/32 (2.5) | for Elite ROS | 051141-28611-2 | 1 |
| 28612 | 6 (150) | 3/16 (5) | for Elite ROS | 051141-28612-9 | 1 |
| 28613 | 6 (150) | 5/16 (8) | for Elite ROS | 051141-28613-6 | 1 |
| 28614 | 6 (150) | 3/8 (10) | for Elite ROS | 051141-28614-3 | 1 |

Orbital/Random Orbital Sander Accessories

3M™ Service Tool Kit

| Part No. | Description | UPC | MOQ |
|----------|---|----------------|-----|
| 20215 | Contains all of the special tools needed to disassemble and reassemble the 3M™ Orbital and Random Orbital Sanders | 051141-20215-0 | 1 |



3M™ Air Line Extensions — 300 PSI Rated

| Part No. | Inside Diameter | Length | Description | Air Inlet Thread | UPC | MOQ |
|----------|-----------------|--------|-------------------------------|------------------|----------------|-----|
| 25119 | 3/8" | 5" | Mini | 1/4" NPT | 051141-25119-6 | 10 |
| 20209 | 3/8" | 4 ft. | — | 1/4" NPT | 051141-20209-9 | 1 |
| 55180 | — | — | Swivel Quick Change Connector | 1/4" NPT EXT | 051141-55180-7 | 1 |



3M™ Air Tool and Compressor Lubricants

| Part No. | Size | Description | UPC | MOQ |
|----------|-------------------|-----------------------------------|----------------|-----|
| 20466 | Quart* | Air Tool and Compressor Lubricant | 051141-20466-6 | 12 |
| 20467 | Gallon* | Air Tool and Compressor Lubricant | 051141-20467-3 | 4 |
| 20451 | 4 fl. oz. (118mL) | Air Tool Lubricant | 051141-20451-2 | 12 |
| 28828 | 1 fl. oz. | Air Tool and Compressor Lubricant | 051141-28828-4 | 24 |



*Available as special order, ships within 4 days.

3M™ Power Cords and Power Supply

| Part No. | Description | UPC |
|----------|---|----------------|
| 28434 | 3M™ Power Cord, Low Voltage, 18AWG, 12 ft. (from power supply to sander) | 051141-28434-7 |
| 28435 | 3M™ Power Cord, Extra Long, Low Voltage, 24 ft. (from power supply to sander) | 051141-28435-4 |
| 28436 | 3M™ Power Supply with 3M™ AC Power Cord (28478) | 051141-28436-1 |
| 28478 | 3M™ AC Power Cord, 110 volt (from wall outlet to power supply) | 051141-28478-1 |



3M™ Hookit™ D/F Disc Pads (Vacuum)

| Part No. | Max RPM | Max OPM | Diameter Inch (mm) | Thread Size | # of Holes | Density Rating | Face Color | Hook Type | UPC | MOQ |
|---|---------|---------|--------------------|-------------|------------|----------------|------------|-----------|----------------|-----|
| Standard Profile Disc Pads (Medium) | | | | | | | | | | |
| LB 82659 | 12,000 | 12,000 | 5 (125) | 5/16–24 EXT | 5 | Medium | Yellow | 1 | 051144-82659-9 | 10 |
| LB 28411* | 12,000 | 12,000 | 5 (125) | 5/16–24 EXT | 5 | Medium | Yellow | 1 | 051141-28411-8 | 10 |
| LB 05876 | 12,000 | 12,000 | 6 (152) | 5/16–24 EXT | 7 | Medium | Yellow | 1 | 051131-05876-7 | 1 |
| Low Profile Finishing Disc Pads (Soft) | | | | | | | | | | |
| LB 77856 | 12,000 | 12,000 | 5 (125) | 5/16–24 EXT | 5 | Soft | Yellow | 1 | 051144-77856-0 | 10 |



*5" backup pad for 6" Random Orbital Sander

LB = Large Buy Available

Orbital/Random Orbital Sander Accessories

3M™ Hookit™ Clean Sanding Disc Pads

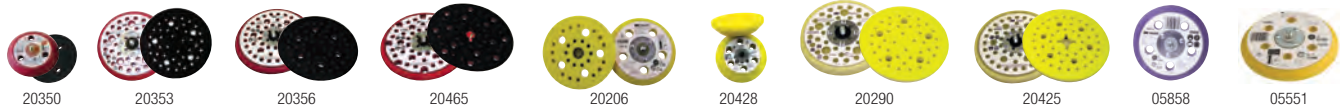

| Part No. | Max RPM | Max OPM | Diameter Inch (mm) | Ctr. Hole Dia. Inch | Thread Size | # of Holes | Density Rating | Hook Type | UPC | MOQ |
|---|---------|---------|--------------------|---------------------|-------------|------------|----------------|-----------|----------------|-----|
| Low Profile Disc Pads (Firm) | | | | | | | | | | |
| 20350 | 15,000 | 15,000 | 3 (76) | — | 1/4-20 EXT | 3 | Firm | 2 | 051141-20350-8 | 10 |
| LB 20353 | 12,000 | 12,000 | 5 (125) | — | 5/16-24 EXT | 44 | Firm | 2 | 051141-20353-9 | 10 |
| LB 20356 | 12,000 | 12,000 | 6 (152) | — | 5/16-24 EXT | 52 | Firm | 2 | 051141-20356-0 | 10 |
| LB 20465 | 12,000 | 12,000 | 6 (152) | 5/8 | 5/16-24 EXT | 49 | Firm | 2 | 051141-20465-9 | 10 |
| Standard Profile Disc Pads (Medium) | | | | | | | | | | |
| LB 20206 | 12,000 | 12,000 | 5 (125) | 3/4 | 5/16-24 EXT | 31 | Medium | 1 | 051141-20206-8 | 10 |
| Low Profile Finishing Disc Pads (Soft) | | | | | | | | | | |
| 20428 | 12,000 | 12,000 | 3 (76) | — | 1/4-20 EXT | 6 | Soft | 1 | 051141-20428-4 | 10 |
| LB 20290 | 12,000 | 12,000 | 5 (125) | — | 5/16-24 EXT | 44 | Soft | 1 | 051141-20290-7 | 10 |
| LB 20425 | 10,000 | 12,000 | 6 (152) | 5/8 | 5/16-24 EXT | 52 | Soft | 1 | 051141-20425-3 | 10 |
| Painter's Pads | | | | | | | | | | |
| 05858 | 12,000 | 12,000 | 5 (125) | 3/4 | 5/16-24 EXT | 31 | Soft | 1 | 051131-05858-3 | 1 |
| 05551 | 12,000 | 12,000 | 6 (152) | 3/4 | 5/16-24 EXT | 25 | Soft | 1 | 051131-05551-3 | 1 |

3M™ Hookit™ Clean Sanding Interface Pads and Hook Savers also available. See 3M™ Accessories Catalog.

3M™ Hookit™ Clean Sanding Disc Pad Hook Savers



| Part No. | Max RPM | Max OPM | Diameter Inch (mm) | Ctr. Hole Dia. Inch | Face Color | # of Holes | Use With | Hook Type | UPC | MOQ |
|----------|---------|---------|--------------------|---------------------|------------|------------|----------|-----------|----------------|-----|
| 28326 | 15,000 | 15,000 | 3 (76) | — | Black | 3 | PN20350 | 2 | 051141-28326-5 | 20 |
| 20444 | 12,000 | 12,000 | 5 (125) | — | Black | 44 | PN20353 | 2 | 051141-20444-4 | 20 |
| 20443 | 12,000 | 12,000 | 5 (125) | 3/4 | Black | 31 | PN20206 | 2 | 051141-20443-7 | 20 |
| 20446 | 12,000 | 12,000 | 6 (152) | — | Black | 52 | PN20356 | 2 | 051141-20446-8 | 20 |
| 20445 | 12,000 | 12,000 | 6 (152) | 3/4 | Black | 25 | PN05865 | 2 | 051141-20445-1 | 20 |

3M™ Hookit™ Disc Pads



| Part No. | Max RPM | Max OPM | Diameter Inch (mm) | Thread Size | Density Rating | Face Color | Hook Type | UPC | MOQ |
|---|---------|---------|--------------------|-------------|----------------|------------|-----------|----------------|-----|
| Low Profile Disc Pads (Firm) | | | | | | | | | |
| LB 20352 | 12,000 | 12,000 | 5 (125) | 5/16-24 EXT | Firm | Black | 2 | 051141-20352-2 | 1 |
| LB 20355 | 12,000 | 12,000 | 6 (152) | 5/16-24 EXT | Firm | Black | 2 | 051141-20355-3 | 10 |
| Standard Profile Disc Pads (Medium) | | | | | | | | | |
| LB 85105 | 12,000 | — | 5 (125) | 5/8-11 INT | Medium | Yellow | 1 | 051144-85105-8 | 1 |
| LB 85096 | 12,000 | — | 5 (125) | 5/8-11 INT | Medium | Yellow | 1 | 051144-85096-9 | 10 |
| LB 05775 | 12,000 | 12,000 | 5 (125) | 5/16-24 EXT | Medium | Yellow | 1 | 051131-05775-3 | 1 |
| LB 70138 | 12,000 | 12,000 | 6 (152) | 5/16-24 EXT | Medium | Yellow | 1 | 051141-28209-6 | 1 |
| Low Profile Finishing Disc Pads (Soft) | | | | | | | | | |
| LB 77855 | 12,000 | 12,000 | 5 (125) | 5/16-24 EXT | Soft | Yellow | 1 | 051144-77855-3 | 10 |

LB = Large Buy Available

Orbital/Random Orbital Sander Accessories

3M™ Hookit™ Sheet Pads



| Part No. | Max OPM | Size | Thickness | # of Holes | Density Rating | Hook Type | UPC | MOQ |
|----------------------|---------|--------------|-----------|------------|----------------|-----------|----------------|-----|
| 20433 | 10,000 | 3" x 4" | 1/2" | — | Medium | 1 | 051141-20433-8 | 10 |
| Clean Sanding | | | | | | | | |
| 20435 | 10,000 | 3" x 4" | 1/2" | 33 | Medium | 1 | 051141-20435-2 | 10 |
| 28531 | 10,000 | 70mm x 198mm | 12.7mm | 33 | Medium | 1 | 051141-28531-3 | 5 |

3M™ Hookit™ Clean Sanding Pad Hook Saver



| Part No. | Max OPM | Size | Face Color | # of Holes | Hook Type | UPC | MOQ |
|----------|---------|---------|------------|------------|-----------|----------------|-----|
| 28325 | 12,000 | 3" x 4" | Black | 33 | 2 | 051141-28325-8 | 20 |

3M™ Stikit™ D/F Disc Pads (Vacuum)



| Part No. | Max RPM | Max OPM | Diameter Inch (mm) | Thread Size | # of Holes | Density Rating | Face Color | UPC | MOQ |
|---|---------|---------|--------------------|-------------|------------|----------------|------------|----------------|-----|
| Low Profile Disc Pads (Firm) | | | | | | | | | |
| LB 20442 | 12,000 | 12,000 | 5 (125) | 5/16-24 EXT | 5 | Firm | Blue | 051141-20442-0 | 1 |
| LB 20454 | 12,000 | 12,000 | 6 (152) | 5/16-24 EXT | 6 | Firm | Blue | 051141-20454-3 | 1 |
| Standard Profile Disc Pads (Medium) | | | | | | | | | |
| LB 45217 | 10,000 | 12,000 | 5 (125) | 5/16-24 EXT | 5 | Medium | Blue | 051144-45217-0 | 10 |
| LB 45218 | 10,000 | 12,000 | 6 (152) | 5/16-24 EXT | 6 | Medium | Blue | 051144-45218-7 | 10 |
| Low Profile Finishing Disc Pads (Soft) | | | | | | | | | |
| LB 05645 | 12,000 | 12,000 | 5 (125) | 5/16-24 EXT | 5 | Soft | Blue | 051131-05645-9 | 10 |
| LB 05646 | 10,000 | 12,000 | 6 (152) | 5/16-24 EXT | 6 | Soft | Blue | 051131-05646-6 | 1 |

3M™ Stikit™ Disc Pads

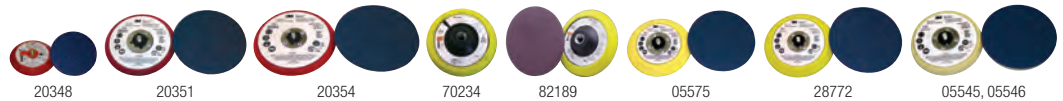

| Part No. | Max RPM | Max OPM | Diameter Inch (mm) | Thread Size | Density Rating | Face Color | UPC | MOQ |
|---|---------|---------|--------------------|-------------|----------------|------------|----------------|-----|
| Low Profile Disc Pads (Firm) | | | | | | | | |
| 20348 | 15,000 | 15,000 | 3 (76) | 1/4-20 EXT | Firm | Blue | 051141-20348-5 | 10 |
| LB 20351 | 12,000 | 12,000 | 5 (125) | 5/16-24 EXT | Firm | Blue | 051141-20351-5 | 1 |
| LB 20354 | 12,000 | 12,000 | 6 (152) | 5/16-24 EXT | Firm | Blue | 051141-20354-6 | 1 |
| Standard Profile Disc Pads (Medium) | | | | | | | | |
| LB 70234 | 12,000 | — | 5 (125) | 5/8-11 INT | Medium | Blue | 051111-55813-3 | 5 |
| LB 82189 | 12,000 | — | 5 (125) | 5/8-11 INT | Medium | Red | 051144-82189-1 | 10 |
| LB 05575 | 10,000 | 12,000 | 5 (125) | 5/16-24 EXT | Medium | Blue | 051144-05575-3 | 1 |
| LB 28772 | 10,000 | 12,000 | 6 (152) | 5/16-24 EXT | Medium | Blue | 051141-28772-0 | 1 |
| Low Profile Finishing Disc Pads (Soft) | | | | | | | | |
| LB 05545 | 12,000 | 12,000 | 5 (125) | 5/16-24 EXT | Soft | Blue | 051131-05545-2 | 10 |
| LB 05546 | 10,000 | 12,000 | 6 (152) | 5/16-24 EXT | Soft | Blue | 051131-05546-9 | 1 |

LB = Large Buy Available

Orbital/Random Orbital Sander Accessories

3M™ Stikit™ Sheet Pads

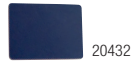

| Part No. | Max OPM | Size | Thickness | Density Rating | Face Color | UPC | MOQ |
|----------|---------|-----------------|-----------|----------------|------------|----------------|-----|
| 20432 | 10,000 | 3" x 4" | 1/2" | Medium | Blue | 051141-20432-1 | 10 |
| 28660 | 10,000 | 2-3/4" x 7-3/4" | 1/2" | Medium | Blue | 051141-28660-0 | 5 |

Mini-Random Orbital Sander Accessories



3M™ Finesse-it™ Roloc™ Sanding Pads TR

| Part No. | Max RPM | Max OPM | Diameter Inch (mm) | Density Rating | Description | UPC | MOQ |
|----------|---------|---------|--------------------|----------------|-------------|----------------|-----|
| 02345 | 10,000 | 12,000 | 1-1/4 (32) | Medium | PSA | 051111-50198-6 | 10 |
| 02511 | 10,000 | 12,000 | 1-1/4 (32) | Firm | PSA | 051111-51150-3 | 10 |

Nib Removal Sander Accessories

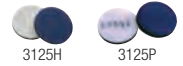

3M™ Finesse-it™ Disc Pads

| Part No. | Max RPM | Max OPM | Diameter Inch (mm) | Thickness | Color | Face Color | Density Rating | Description | UPC | MOQ |
|----------|---------|---------|--------------------|-----------|-------|------------|----------------|-------------|----------------|-----|
| 3125H | 7,500 | 7,500 | 1-1/4 (32) | 1/8" | Black | Blue | Hard | PSA | 051141-20207-5 | 10 |
| 3125P | 7,500 | 10,000 | 1-1/4 (32) | 1/8" | Black | Blue | Soft | PSA | 051111-60537-0 | 20 |

Buffer Accessories

3M™ Finesse-it™ Buffing Pads



| Part No. | Max RPM | Max OPM | Diameter Inch (mm) | Description | UPC | MOQ |
|-------------------|---------|---------|--------------------|---|----------------|-------|
| 02648 | 12,000 | 12,000 | 3-1/4 (83) | Orange Foam; White Loop | 051111-51151-0 | 10 |
| 25134 | 12,000 | 12,000 | 3-1/4 (83) | Gray Foam; White Loop | 051141-25134-9 | 50 |
| 02637 | 12,000 | 12,000 | 3-3/4 (95) | Orange Foam; White Loop | 051111-51158-9 | 50 |
| 25135 | 12,000 | 12,000 | 3-3/4 (95) | Gray Foam; White Loop | 051141-25135-6 | 50 |
| 20271 | 12,000 | 12,000 | 3-3/4 (95) | White Foam; White Loop | 051141-20271-6 | 10 |
| 02362 | 12,000 | 12,000 | 5-1/4 (133) | Orange Foam; White Loop | 051111-51076-6 | 10 |
| 85099 | — | — | 3 (76) | White Wool; Knit II; 11/16" Pile Height | 051144-85099-0 | 10 |
| 81470 | — | — | 3 (76) | White Wool; Natural; 20mm | 051144-81470-1 | 10 |
| NEW! 28401 | 12,000 | 12,000 | 5-1/4 (133) | White Foam; Open Cell | 051141-28401-9 | 900 |
| NEW! 28574 | 12,000 | 12,000 | 5-1/4 (133) | Gray Foam | 051141-28574-0 | 1,500 |
| NEW! 28783 | 12,000 | 12,000 | 3-3/4 (95) | Foam; Open Cell | 051141-28783-6 | 50 |

3M™ Buffer Backup Pads



| Part No. | Max RPM | Max OPM | Diameter Inch (mm) | Thread Size | # of Holes | Density Rating | Hook Type | For Use With | UPC | MOQ |
|----------|---------|---------|--------------------|-------------|------------|----------------|-----------|----------------------|----------------|-----|
| 28472 | 15,000 | 15,000 | 3 (76) | 1/4-20 EXT | — | Firm | 2 | 3M™ R/O Buffers — 3" | 051141-28472-9 | 5 |
| 84226 | 12,000 | 12,000 | 5 (125) | 5/16-24 EXT | 5 | Soft | 1 | 3M™ R/O Buffers — 5" | 051111-51042-1 | 10 |

Disc Sander Accessories

3M™ Roloc™ Disc Pads TR

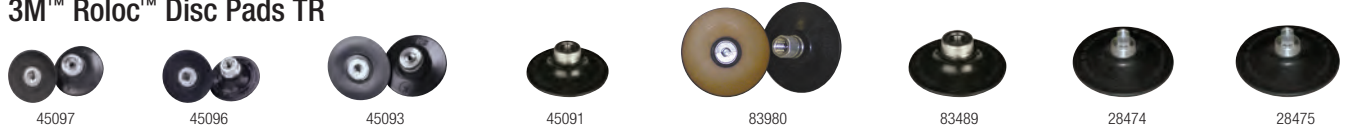

| Part No. | Max RPM | Size Inch (mm) | Attachment | Density Rating | Thread Size | UPC | MOQ |
|----------|---------|----------------|------------|----------------|-------------|----------------|-----|
| 45097 | 25,000 | 2 (51) | TR | Extra Hard | 1/4-20 INT | 051144-45097-8 | 5 |
| 45096 | 25,000 | 2 (51) | TR | Hard | 1/4-20 INT | 051144-45096-1 | 5 |
| 45093 | 20,000 | 3 (76) | TR | Extra Hard | 1/4-20 INT | 051144-45093-0 | 5 |
| 45091 | 20,000 | 3 (76) | TR | Hard | 1/4-20 INT | 051144-45091-6 | 5 |
| 83980 | 12,000 | 4 (102) | TR | Extra Hard | 5/8-11 INT* | 051144-83980-3 | 5 |
| 83489 | 12,000 | 4 (102) | TR | Hard | 5/8-11 INT* | 051144-83489-1 | 5 |
| 28474 | 12,000 | 4 (102) | TR | Hard | 3/8-24 INT* | 051141-28474-3 | 5 |
| 28475 | 12,000 | 4 (102) | TR | Extra Hard | 3/8-24 INT* | 051141-28475-0 | 5 |

*Extended thread; no spacers required

3M™ Roloc™ Disc Pads TS/TSM



| Part No. | Max RPM | Size Inch (mm) | Attachment | Density Rating | Thread Size | UPC | MOQ |
|----------|---------|----------------|------------|----------------|-------------|----------------|-----|
| 77728 | 30,000 | 1-1/2 (38) | TS/TSM | Hard | 1/4-20 INT | 051144-77728-0 | 5 |
| 14212 | 25,000 | 2 (51) | TS/TSM | Hard | 1/4-20 INT | 051144-14212-5 | 5 |
| 14216 | 20,000 | 3 (76) | TS/TSM | Hard | 1/4-20 INT | 051144-14216-3 | 5 |
| 28576 | 12,000 | 4 (102) | TS/TSM | Hard | 3/8-24 INT | 051141-28576-4 | 5 |
| 28577 | 12,000 | 4 (102) | TS/TSM | Extra Hard | 3/8-24 INT | 051141-28577-1 | 5 |
| 28578 | 12,000 | 4 (102) | TS/TSM | Hard | 5/8-11 INT | 051141-28578-8 | 5 |
| 28579 | 12,000 | 4 (102) | TS/TSM | Extra Hard | 5/8-11 INT | 051141-28579-5 | 5 |

3M™ Roloc™ Cool Running Disc Pads



| Part No. | Max RPM | Size Inch (mm) | # of Holes | Attachment | Density Rating | Thread Size | UPC | MOQ |
|----------|---------|----------------|------------|------------|----------------|-------------|----------------|-----|
| 82974 | 20,000 | 2 (51) | 6 | TR | Medium | 1/4-20 INT | 051144-82974-3 | 5 |
| 28711 | 20,000 | 2 (51) | 6 | TS/TSM | Hard | 1/4-20 INT | 051141-28711-9 | 5 |
| 82975 | 12,000 | 3 (76) | 6 | TR | Medium | 1/4-20 INT | 051144-82975-0 | 5 |
| 28710 | 12,000 | 3 (76) | 6 | TS/TSM | Hard | 1/4-20 INT | 051141-28710-2 | 5 |
| 02286 | 15,000 | 4 (102) | 8 | TR | Hard | 3/8-24 INT | 051111-56479-0 | 5 |
| 28473 | 15,000 | 4 (102) | 8 | TR | Hard | 5/8-11 INT* | 051141-28473-6 | 5 |
| 28580 | 15,000 | 4 (102) | 8 | TS/TSM | Hard | 3/8-24 INT | 051141-28580-1 | 5 |
| 28581 | 15,000 | 4 (102) | 8 | TS/TSM | Hard | 5/8-11 INT* | 051141-28581-8 | 5 |

*Extended thread; no spacers required

3M™ Hookit™ Roloc™ Disc Pads TR

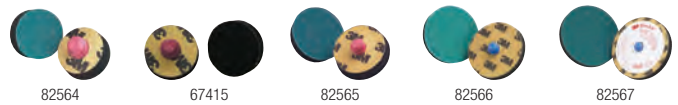

| Part No. | Max RPM | Max OPM | Size Inch (mm) | Attachment | Shape | Density Rating | Hook Type | UPC | MOQ |
|----------|---------|---------|----------------|------------|-------|----------------|-----------|----------------|-----|
| 82564 | 8,000 | 10,000 | 1 (25) | TR | 15° | Medium | 2 | 051144-82564-6 | 10 |
| 67415 | 10,000 | 10,000 | 1-1/16 (27) | TR | 15° | Medium | 1 | 051111-60311-6 | 20 |
| 82565 | 8,000 | 10,000 | 1-1/2 (38) | TR | 15° | Medium | 2 | 051144-82565-3 | 5 |
| 82566 | 8,000 | 10,000 | 2 (51) | TR | 15° | Medium | 2 | 051144-82566-0 | 5 |
| 82567 | 8,000 | 10,000 | 3 (76) | TR | 15° | Medium | 2 | 051144-82567-7 | 1 |

Disc Sander Accessories

3M™ Roloc™ Dust Shroud Kits

| Part No. | Max RPM | Size Inch (mm) | UPC | MOQ |
|----------|---------|-------------------|----------------|-----|
| 28727 | 12,000 | 2 (51) | 051141-28727-0 | 1 |
| 28728 | 12,000 | 3 (76) | 051141-28728-7 | 1 |



3M™ Overhose Kit and Replacement Sleeve

Designed for 0.3 HP metalworking tools

| Part No. | Description | UPC | MOQ |
|----------|---|----------------|-------|
| 28651 | Kit Contains: Air Line Extension (PN20209), Adapter (PN20453), Over Hose Cloth Sleeve, Exhaust Spacer, Air Inlet Bushing, Instruction Sheet | 051141-28651-8 | 1 Kit |
| 28652 | Overhose Replacement Sleeve — 1-1/2" x 4 ft. | 051141-28652-5 | 5 |



3M™ Roloc™ Shank

| Part No. | Shank Size | Thread Size | UPC | MOQ |
|----------|------------|-------------|----------------|-----|
| 45102 | 1/4" | 1/4-20 EXT | 051144-45102-9 | 5 |

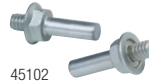

Die Grinder Accessories

3M™ Die Grinder Mandrels 1/4" Shank Diameter

| For Use With | Size Pilot Dia. x Pilot Length x Shank Dia. | UPC |
|-------------------------------------|--|----------------|
| Cartridge Rolls | 1/8" x 1" x 1/4" | 051144-45119-7 |
| Cartridge Rolls | 3/16" x 1" x 1/4" | 051144-45117-3 |
| Cartridge Rolls | 3/16" x 1/2" x 1/4" | 051144-45118-0 |
| Cross/Square Pads (and Cross Buffs) | 1/4" x 1/4-20 EXT thread | 051144-14308-5 |
| Cross/Square Pads (and Cross Buffs) | 1/4" x 8-32 EXT thread | 051144-14307-8 |
| Cross/Square Pads (and Cross Buffs) | 1/4" x 3-48 EXT thread | 051141-28385-2 |

| Part No. | For Use With | Size Length x Shank Dia. x Flange Support Dia. | UPC |
|----------|---------------------------------------|---|----------------|
| 936 | Deburring Wheels/Radial Bristle Discs | 2-1/16" x 1/4" x 3/4" (not pictured) | 048011-04018-9 |
| 990 | Deburring Wheels/Radial Bristle Discs | 1-3/4" x 1/4" | 048011-15012-3 |
| 944 | Stars | 1/4" x 1/4-20 EXT | 048011-13928-9 |
| 935 | Strips/Polishing Rolls | 2-7/8" x 1/4" | 048011-04020-2 |



3M™ Forked Spindle

| For Use With | Size | UPC |
|------------------------|-------------------|----------------|
| Strips/Polishing Rolls | 3" x 1/16" x 1/4" | 051144-45121-0 |



3M™ PG Wheel Adapter 81A

| For Use With | Size | UPC |
|------------------|--------------------------------|----------------|
| T-84 Flap Wheels | 1/4-20 INT thread x 1/4" shank | 051144-45081-7 |



Die Grinder and Inline Sander Accessories

3M™ Rubber Cushion Polishing Wheels for Abrasive Bands

| Diameter x W x Shaft | Max RPM | UPC |
|------------------------|---------|----------------|
| 1/4" x 1/2" x 1/8" | 23,000 | 051144-45159-3 |
| 1/2" x 1/2" x 1/4" | 30,000 | 051144-45156-2 |
| 1/2" x 1" x 1/4" | 15,000 | 051144-45153-1 |
| 1/2" x 1-1/2" x 1/4" | 15,000 | 051144-45152-4 |
| 3/4" x 1" x 1/4" | 17,000 | 051144-45145-6 |
| 3/4" x 1-1/2" x 1/4" | 10,000 | 051144-45144-9 |
| 1" x 1" x 1/4" | 18,000 | 051144-45139-5 |
| 1" x 1-1/2" x 1/4" | 10,000 | 051144-45138-8 |
| 1-1/2" x 1" x 1/4" | 14,000 | 051144-45132-6 |
| 1-1/2" x 1-1/2" x 1/4" | 10,000 | 051144-45131-9 |
| 1-1/2" x 2" x 1/4" | 8,000 | 051144-45130-2 |
| 2" x 1" x 1/4" | 11,000 | 051144-45129-6 |



3M™ Rubber Slotted Expander Wheels

| Part No. | Size | Description | UPC |
|---|--------------------------|---|----------------|
| Use with 3M™ Die Grinders | | | |
| 77717 | 1" x 1" x 1/4" Shank | For use with 1" x 1" bands | 051144-77717-4 |
| 77718 | 1-1/2" x 1" x 1/4" Shank | For use with 1-1/2" x 1" bands | 051144-77718-1 |
| 77720 | 2" x 1" x 1/4" Shank | For use with 2" x 1" bands | 051144-77720-4 |
| 77721 | 2" x 2" x 1/4" Shank | For use with 2" x 2" bands | 051144-77721-1 |
| Use with 3M™ Inline Sanders | | | |
| 77722 | 3" x 3" x 5/8–11 INT | For use with 3" x 3" bands | 051144-77722-8 |
| 28348 | 5" x 3-1/2" x 5/8" AH | For use with 3-1/2" W x 15-1/2" L belts | 051141-28348-7 |
| 28349 | 3-2/5" x 3" x 5/8" AH | For use with 3" W x 10-11/16" L belts | 051141-28349-4 |
| Use with 3M™ Match and Finish Sander | | | |
| 28718 | 5" x 3-1/2" x 1" AH | Rubber slotted expander wheel for use with 3-1/2" W x 15-1/2" L belts | 051141-28718-8 |
| 28719 | 1" x 5/8–11 INT | Wheel adapter kit to mount PN28718 wheel on Match and Finish Sander | 051141-28719-5 |



3M™ Wheel Adapter Kits* Fits wheels with 5/8" or 1" AH

| Part No. | Thread Size | Description | UPC | Case Quantity |
|----------|-------------------------|--------------------------------------|----------------|---------------|
| 45038 | 5/8–11 INT x 5/8–11 EXT | For use with Expander Wheels | 051144-45038-1 | 1 |
| 04019 | 5/8–11 INT x 5/8–11 EXT | For use with Scotch-Brite™ Wheels | 048011-04019-6 | 1 |
| 28419 | 5/8–11 INT x 1/2–20 EXT | For use with 1/2" Center Hole Wheels | 051141-28419-4 | 1 |

*Kits include spacers, flanges and end nuts to mount expander wheels and other Scotch-Brite™ Wheels.



3M™ Replacement Spacers

| Part No. | Description | UPC | Case Quantity |
|----------|-------------------------------|----------------|---------------|
| 28636 | 1" OD x 5/8" ID x 3/8" thick | 051141-28636-5 | 1 |
| 28637 | 1" OD x 5/8" ID x 3/16" thick | 051141-28637-2 | 1 |



Disc Sander/Grinder Accessories

3M™ Disc and Wheel Accessories

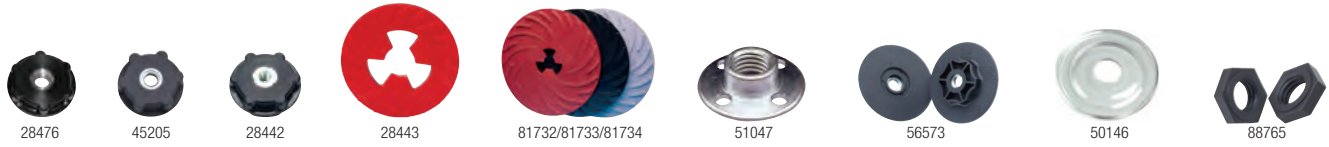

| Part No. | Size | Description | For Use With |
|----------|-----------------------------|--|--|
| 28476 | 2-1/2" Diameter, 5/8–11 INT | Disc Pad Hub — Low Profile | Fibre Discs, 4-1/2" and 5" Diameter |
| 45205 | 2-1/2" Diameter, 5/8–11 INT | Disc Pad Hub — Standard Profile | Fibre Discs, 4-1/2" and 5" Diameter |
| 28442 | 2-1/2" Diameter, 3/8–24 INT | Disc Pad Hub — Low Profile | Fibre Discs, 4-1/2" and 5" Diameter |
| 28656 | 4" Diameter | Disc Pad Face Plates — Ribbed; Red; Extra Hard | Fibre Discs, 4" Diameter x 7/8" CH |
| 28657 | 4" Diameter | Disc Pad Face Plates — Ribbed; Black; Hard | Fibre Discs, 4" Diameter x 7/8" CH |
| 28658 | 4" Diameter | Disc Pad Face Plates — Ribbed; Gray; Medium | Fibre Discs, 4" Diameter x 7/8" CH |
| 28443 | 4-1/2" Diameter | Disc Pad Face Plates — Ribbed; Red; Extra Hard | Fibre Discs, 4-1/2" Diameter x 7/8" CH |
| 14270 | 4-1/2" Diameter | Disc Pad Face Plates — Smooth; Black; Hard | Fibre Discs, 4-1/2" Diameter x 7/8" CH |
| 13325 | 4-1/2" Diameter | Disc Pad Face Plates — Smooth; Gray; Medium | Fibre Discs, 4-1/2" Diameter x 7/8" CH |
| 81732 | 5" Diameter | Disc Pad Face Plates — Ribbed; Red; Extra Hard | Fibre Discs, 5" Diameter |
| 81733 | 5" Diameter | Disc Pad Face Plates — Ribbed; Black; Hard | Fibre Discs, 5" Diameter |
| 81734 | 5" Diameter | Disc Pad Face Plates — Ribbed; Gray; Medium | Fibre Discs, 5" Diameter |
| 51047 | 5/8–11 INT | Disc Retainer Nuts — 5/16" Depth | Fibre Discs, 4-1/2" and 5" Diameter |
| 05622 | 5/8–11 INT | Disc Retainer Nuts — 3/8" Depth | Fibre Discs, 4-1/2" and 5" Diameter |
| 56573 | 4-1/2" Diameter | NTN Backup Pad | 3M™ Abrasives with Tinneman Nut Attachment, 4-1/2" Diameter (Excludes 3M™ Green Corps™ and General Purpose Wheels) |
| 50146 | 4-1/2" Diameter | Green Corps™ Flexible Grinding Disc Backup Plate | Bonded Wheels, 4-1/2" Diameter |
| 88765 | 5/8–11 INT | Flap Disc Adaptor Nut | Flap Discs, 4-1/2" x 7/8" CH |
| 28739 | 1" x 5/8" x 3/8–24 INT | Flange Nuts | Wheels, 4" Diameter x 5/8" CH on 4" Grinders 28403 and 28413 |
| 28740 | 1" x 5/8–11 INT | Flange Nuts | Wheels, 4" Diameter x 5/8" CH on 4-1/2" Grinders 28405 and 28414 |

3M™ Disc Pad Holders (Hook and Loop)



| Part No. | Size | Thickness | Thread Size | Density | Hook Type | UPC | MOQ |
|----------|---------------------|-----------|-------------|---------|-----------|----------------|-----|
| 9215 | 1-1/2" x 1/4" Shank | 1/8" | — | Firm | 5 | 048011-04130-8 | 10 |
| 922 | 2" x 1/4" Shank | 1/8" | — | Firm | 5 | 048011-07494-8 | 1 |
| 923 | 3" x 1/4" Shank | 1/8" | — | Firm | 5 | 048011-04132-2 | 1 |
| 924 | 4" x 1/4" Shank | 1/16" | — | Firm | 5 | 048011-07492-4 | 5 |
| 914 | 4" x 3/8" CH | 1/8" | 5/8–11 INT | Firm | 7 | 048011-05674-6 | 1 |
| 9145 | 4-1/2" x 3/8" CH | 1/8" | 5/8–11 INT | Firm | 7 | 048011-14111-4 | 1 |
| 905 | 5" | 1/4" | 5/16–24 EXT | Medium | 7 | 048011-09448-9 | 1 |

3M™ Disc Holder Adapter No. 9

| Part No. | Thread Size | UPC | MOQ |
|----------|-------------------------|----------------|-----|
| 9 | 5/8–11 EXT x 3/8–24 INT | 048011-22970-6 | 1 |



File Belt Sander Accessories

3M™ File Belt Sander Platen Pad Material

| Part No. | Size Inches | For Use With | Description | UPC | Case Quantity |
|-------------------|-------------------|-------------------------------------|-------------|----------------|---------------|
| 28377 | 1/2 x 7 x 1/8 | 1/2" wide belts | Soft | 051141-28377-7 | 10 |
| 28378 | 3/4 x 7 x 1/8 | 5/8" or 3/4" wide belts | Soft | 051141-28378-4 | 10 |
| 28379 | 1/2 x 7 x 1/8 | 1/2" wide belts | Hard | 051141-28379-1 | 10 |
| 28380 | 3/4 x 7 x 1/8 | 5/8" or 3/4" wide belts | Hard | 051141-28380-7 | 10 |
| 28381 | 1/2 x 7 x 1/32 | 1/2" wide belts | Thin | 051141-28381-4 | 10 |
| 28382 | 3/4 x 7 x 1/32 | 5/8" or 3/4" wide belts | Thin | 051141-28382-1 | 10 |
| NEW! 28726 | 15-3/4 x 11-13/16 | Can be cut to fit any belt size arm | Soft | 051141-28726-3 | 10 |



3M™ File Belt Sander Extension

| Part No. | Description | UPC | Case Quantity |
|---|--|----------------|---------------|
|  28376 | Use to extend arms to 24" length. Can be used with same attachment arm used for 18" length arms. | 051141-28376-0 | 1 |



3M™ File Belt Arm Service Tool Kit

| Part No. | Description | UPC | Case Quantity |
|----------|--|----------------|---------------|
| 30670 | Contains Wheel Positioning Block, Shaft Removal Tool, 2 Bearing Removal Tools, Bearing Mount Tool, Bearing Tool and Retaining Compound | 051141-30670-4 | 1 |



3M™ File Belt Attachment Arm Repair Kits







Kits contain: Contact wheel, bearing, shaft and platen pad if applicable.
 3M™ File Belt Arm Service Tool Kit (PN30670) recommended for use with repair kits.

| Attachment Arm Repair Kit Part No. | For Use With Attachment Arm Part No. |
|------------------------------------|--------------------------------------|
| 30663 | 28368 |
| 30667 | 28369 |
| 30668 | 28370 |
| 30664 | 28371 |
| 30666 | 28372 |
| 30665 | 28373 |
| 30662 | 28374 |
| 30669 | 28375 |



File Belt Sander Accessories

3M™ File Belt Sander Attachment Arms

| Part No. | Use With Belt Size | Description | UPC | Case Quantity |
|--|--|---|----------------|---------------|
|  28368 | 1/2" x 18" | Standard Style: Standard arm included with 3M™ File Belt Sander (PN28366). Sand with contact wheel or platen. | 051141-28368-5 | 1 |
|  28369 | 1/2" x 18" | Thin Style: Thinner than standard arm. Sand with contact wheel or platen. | 051141-28369-2 | 1 |
|  28370 | 1/8" x 18" 1/4" x 18" 1/2" x 18" | Corners Style: Sand corners and grooves with contact wheel. Accommodates three belt widths. | 051141-28370-8 | 1 |
|  28371 | 5/8" x 18" 3/4" x 18" | Thick Standard Style: Thicker than standard arm. Sand with contact wheel or platen. Accommodates two belt widths. | 051141-28371-5 | 1 |
|  28372 | 1/8" x 18" 1/4" x 18" | Corners Style: Sand corners and grooves with contact wheel. Accommodates two belt widths. | 051141-28372-2 | 1 |
|  28374 | 1/2" x 18" | Curved Arm: Unique curved arm used for blending flat areas. Sand with contact wheel or platen. | 051141-28374-6 | 1 |
|  28375 | 1/4" x 24" 1/2" x 24" | Vessel Arm: Unique large arm used for blending weld seams. Sand with 4" contact wheel. Includes tracking/control knob. Accommodates two belt widths. | 051141-28375-3 | 1 |



Selection Guides for Abrasive Products

Random Orbital Sander Abrasives



| | 3M ID | Anti-Loading or Grinding Aid | Clean Sanding | Backing |
|--------|------------------|------------------------------|---------------|--------------|
| Good | NX | • | | C- & D-Paper |
| | 202DZ | | | J-Cloth |
| | 210U | | KUT | A-Paper |
| | 216U | • | • | A-Paper |
| | 426U | • | KUT | A-Paper |
| Better | 236U | • | • | C-Paper |
| | 255L | • | | Film |
| | 268L | | KUT | Film |
| | 337DC | • | | X-Cloth |
| | 341D/348D | | | X-Cloth |
| | 359F | | | Y-Cloth |
| | 360L | | • | Film |
| | 363I | | | F-Paper |
| | 375L | • | | Film |
| | 468L | | KUT | Film |
| Best | 268XA | | | Film |
| | 366L | • | KUT | Film |
| | 568XA | | | Film |
| | 675L | | | Film |
| | 735U | • | • | C-Paper |
| | 763U | | KUT | F-Paper |
| | 751I | | KUT | E-Paper |
| | 752I | | | F-Paper |
| | 777F | • | | Y-Cloth |
| | Scotch-Brite™ RO | • | | Non-woven |
| 900DZ | | • | J-Cloth | |

Mini Sander Abrasives



| Size | Product | Grade | | |
|--------|--------------------------------------|-------|----|----|
| | | A3 | A5 | A7 |
| 1-1/4" | Trizact™ Finesse-it™ Film Disc 466LA | • | • | • |
| 1-3/8" | Trizact™ Finesse-it™ Film Disc 464LA | • | • | • |

Cut-Off Wheel Tool Abrasives

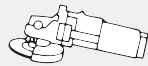

| | Product | Mineral | Metal Type | Type |
|--------|------------------|----------------------------|------------|---------|
| Better | General Purpose | Aluminum Oxide | All Metals | T1 |
| | 3M™ Green Corps™ | 3M™ Ceramic Abrasive Grain | All Metals | T1 |
| | High Performance | 3M™ Ceramic Abrasive Grain | All Metals | T1, T27 |
| Best | Cubitron™ II | 3M™ Ceramic Abrasive Grain | All Metals | T1, T27 |

Sander/Grinder Fibre Discs



| | 3M ID | Mineral | Metal Type |
|---------|-------|------------------------------|--------------------|
| Good | 381C | Aluminum Oxide | Carbon Steel |
| | 501C | Alumina Zirconia | Stainless/Aluminum |
| Better | 501C | Alumina Zirconia | Carbon Steel |
| | 785C | Ceramic Aluminum Oxide Blend | Stainless/Aluminum |
| Best | 988C | 3M™ Ceramic Abrasive Grain | Carbon Steel |
| | 985C | 3M™ Ceramic Abrasive Grain | Stainless/Aluminum |
| Premium | 982C | Precision Shaped Ceramic | Carbon Steel |
| | 987C | Precision Shaped Ceramic | Stainless/Aluminum |

Inline Sander Abrasives

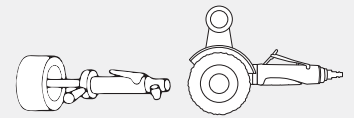

| | 3M ID |
|---------|--|
| Good | 3M™ Belt 577F |
| Best | 3M™ Belt 777F |
| | Scotch-Brite™ Surface Conditioning Belt A MED for a #4 finish, A CRS for a #3 finish |
| Premium | 3M™ Belt 947A |

Scotch-Brite™ Match and Finish Flap Brushes

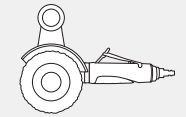

| Nonwoven Finish | Coarser Finish | Combi Finish |
|----------------------|----------------|---------------------------|
| Flap Brush 5A XCS | | Combi Brush Grade A/O 60 |
| HS Flap Brush 7A CRS | | Combi Brush Grade A/O 100 |
| HS Flap Brush 7A MED | | Combi Brush Grade A/O 150 |
| Flap Brush 5A MED | | |
| Flap Brush 5S MED | | |
| Flap Brush 5A VFN | | |
| | Finer Finish | |

File Belt Sander Abrasives

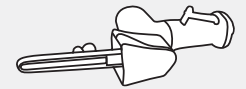

| | 3M ID | Metal Type |
|--------|------------------|--|
| Good | 241E | Carbon Steel, Aluminum, Brass, Bronze |
| Better | 577F | Carbon Steel, Stainless Steel, Aluminum, Brass, Bronze, Cobalt and Nickel Alloys, Titanium |
| | 777F | |
| Best | 237AA | Mild Steel, Stainless, Nickel, Cobalt Alloys, Aluminum, Brass, Copper, Titanium |
| | 947A | Carbon Steel, Stainless Steel, Aluminum, Brass, Bronze, Cobalt and Nickel Alloys, Titanium |
| | 984F | |
| | Scotch-Brite™ SC | All Metals, General Purpose, Works Best on Flats |
| | Scotch-Brite™ SE | All Metals, Heavy-Duty Applications |
| | Scotch-Brite™ DF | All Metals, Applications where a sharp edge is present and/or flexibility is desired |

Selection Guides for Abrasive Products

3M™ Coated Abrasive Belts

These belts provide dependable, economic performance for general metalworking applications.

● = Stock M = Make-to-Order – = Not Available



| Size (in inches) | Product | Grade | | | | | | | | | |
|------------------|---------|-------|----|----|----|----|-----|-----|-----|-----|-----|
| | | 36 | 40 | 50 | 60 | 80 | 100 | 120 | 180 | 220 | 320 |
| 1/4 x 18 | 241E | – | – | M | M | M | M | M | M | M | M |
| | 577F | M | M | M | ● | ● | M | ● | M | – | – |
| | 777F | M | M | M | ● | ● | M | ● | M | – | – |
| | 947A | M | M | M | M | M | M | M | M | M | M |
| | 984F | M | – | – | M | M | – | – | – | – | – |
| 1/4 x 24 | 241E | – | – | M | ● | ● | M | ● | M | M | M |
| | 577F | M | M | M | ● | ● | M | ● | M | – | – |
| | 777F | ● | M | M | ● | ● | M | ● | M | – | – |
| | 947A | M | M | M | ● | ● | M | ● | M | M | M |
| | 984F | M | – | – | ● | M | – | – | – | – | – |
| 1/2 x 18 | 241E | – | – | M | ● | ● | M | M | M | M | M |
| | 577F | ● | M | M | ● | ● | M | ● | M | – | – |
| | 777F | ● | ● | M | ● | ● | M | ● | M | – | – |
| | 947A | M | M | M | ● | ● | M | ● | M | M | M |
| | 984F | ● | – | – | ● | ● | – | – | – | – | – |
| 1/2 x 24 | 241E | – | – | M | ● | ● | ● | M | ● | ● | M |
| | 577F | ● | M | M | ● | ● | M | ● | M | – | – |
| | 777F | ● | ● | ● | ● | ● | M | ● | M | – | ● |
| | 947A | M | M | M | ● | ● | M | ● | M | M | M |
| | 984F | ● | – | – | ● | ● | – | – | – | – | – |
| 3/4 x 18 | 241E | – | – | M | ● | ● | M | ● | M | M | M |
| | 577F | ● | M | M | ● | ● | M | ● | M | – | – |
| | 777F | ● | M | M | ● | ● | M | ● | M | – | – |
| | 947A | M | M | M | ● | ● | M | ● | M | M | M |
| | 984F | ● | – | – | ● | ● | – | – | – | – | – |
| 3/4 x 20-1/2 | 241E | – | – | M | M | M | M | M | M | M | M |
| | 577F | M | M | M | ● | ● | M | ● | M | – | – |
| | 777F | M | M | M | ● | ● | M | ● | M | – | – |
| | 947A | M | M | M | ● | ● | M | ● | M | M | M |
| | 984F | ● | – | – | M | ● | – | – | – | – | – |

241E
Aluminum Oxide on high strength cloth backing

577F
Alumina zirconia on YF wt cloth backing

777F
3M™ Ceramic Aluminum Oxide blend abrasive grain on YF wt cloth backing with grinding aid

947A
Revolutionary 3M precision shaped abrasive grain technology on X wt poly-cotton backing with grinding aid

984F
Revolutionary 3M precision shaped abrasive grain technology on YF wt polyester backing with grinding aid

Scotch-Brite™ Belts

● = Stock M = Make-to-Order – = Not Available

| Size (in inches) | Product | Grade | | | |
|------------------|---------|-------|-------|-------|-------|
| | | A VFN | A FIN | A MED | A CRS |
| 1/4 x 18 | SC | M | – | ● | M |
| | SE | – | M | M | ● |
| | DF | – | ● | ● | ● |
| 1/4 x 24 | SC | ● | – | ● | ● |
| | SE | – | M | M | M |
| | DF | – | ● | ● | ● |
| 1/2 x 18 | SC | ● | – | ● | ● |
| | SE | – | M | M | ● |
| | DF | – | ● | ● | ● |
| 1/2 x 24 | SC | ● | – | ● | ● |
| | SE | – | M | M | ● |
| | DF | – | ● | ● | ● |
| 3/4 x 18 | SC | ● | – | ● | ● |
| | SE | – | M | M | ● |
| | DF | – | ● | ● | ● |
| 3/4 x 20-1/2 | SC | M | – | ● | M |
| | SE | – | M | M | M |
| | DF | – | M | M | M |

Selection Guides for Abrasive Products

Disc Sander Abrasives

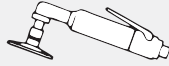

| | 3M ID | Mineral | Features | Metal Type | Grinding | Light Grinding | Blending | Deburring | Finishing |
|-----------------------------------|-----------------------------------|--|--|---------------------------------------|----------|----------------|----------|-----------|-----------|
| 3M™ Roloc™ Cloth Discs | | | | | | | | | |
| Good | 361F | Aluminum Oxide | General purpose grinding, light grinding, blending and deburring on all metals | All Metals | • | • | • | • | |
| | 461F | Silicon Carbide | Ideal for grinding glass, titanium and non-ferrous metals | Titanium | | • | • | • | |
| Better | 777F | Ceramic Aluminum Oxide Blend | Durable Y wt. Cloth backing; Grinding aid | Stainless Steel, Nickel Alloy | • | • | • | • | |
| Best | 963G | Ceramic Abrasive Grain | Durable backing | Carbon Steel | • | • | • | • | |
| | 984F | Precision Shaped Grain | Durable 2-ply backing; Grinding aid | All Metals | • | • | • | • | |
| 3M™ Roloc™ Fibre Discs | | | | | | | | | |
| Good | 501C | Aluminum Zirconia | Versatile disc for use on a wide variety of metals; General purpose grinding, blending and finishing on all metals | All Metals | • | • | | • | |
| Better | 785C | Ceramic Aluminum Oxide Blend | Excellent for stainless steel; Grinding aid | Stainless Steel | • | • | | • | |
| Best | 983C/ 988C | Ceramic Abrasive Grain | Fast cutting; Long life; Designed for a variety of carbon steel applications | Carbon Steel | • | • | | • | |
| | 982C | Precision Shaped Grain | Fast cutting; Longer life; Designed for a variety of applications | All Metals | • | • | | • | |
| Scotch-Brite™ Roloc™ Discs | | | | | | | | | |
| Best | SC-DR Surface Conditioning | Aluminum Oxide | Versatile disc for use on a variety of metals | All Metals | | | • | • | • |
| | PD-DR PD Surface Conditioning | Aluminum Oxide | Lofty, open non-woven abrasive disc resists loading on soft or oily materials | Aluminum, Brass and other soft metals | | | • | • | • |
| | GB-DR Light Grinding and Blending | Cubitron™ Ceramic Aluminum Oxide Blend | High cut rate and durable construction | All Metals | | • | • | • | |

Die Grinder Abrasives — Light-Duty Grinding (0.3 HP)

These die grinders are ideal for light-duty applications. Available in extended shaft models.



| Product Name | 28627 18,000 Max RPM | 28628 (extended) 18,000 Max RPM | 28629/28630 (extended) 25,000 Max RPM |
|--------------------------------|----------------------------------|--|--|
| Scotch-Brite™ Abrasives | | | |
| Cross Buffs | All | All | |
| Stars | All | All | |
| EXL Unitized Mounted Points | All shapes and shank sizes | Shape A21 with 1/4" shank; All shapes with 1/8" shank | |
| EXL Unitized Wheel | All | All | |
| 3M™ Coated Abrasives | | | |
| Cartridge Roll Mandrel | All | All | |
| Cross Pads 341D | All | All | |
| Radial Bristle Disc | All thick and thin bristle discs | All thick and thin bristle discs | All thick bristle discs |

Selection Guides for Abrasive Products

Die Grinder Abrasives — Medium-Duty Grinding (0.5 HP)

These die grinders are ideal for medium-duty applications. Available in extended shaft models.



| Product Name | 28332 4,000 Max RPM | 28330/28331 (extended) 18,000 Max RPM |
|--------------------------------|--|---|
| Scotch-Brite™ Abrasives | | |
| Cross Buffs | 3" or less | 1-1/2" or less |
| Cut & Polish Discs | 6" x 1/4" A MED | |
| High Strength Discs | 6" x 1/4" | |
| Flap Brush | 3" x 1-3/4" x 1/4" A MED, A CRS, S FIN | |
| Combi Wheel | 3" x 1-3/4" x 1/4" | |
| EXL Unitized Wheel | | 1" to 1-1/2" 2, 3 densities; 1" to 2-1/2 and 3" x 1/8"–3/8" 4, 6, 8 densities |
| 3M™ Coated Abrasives | | |
| Flap Wheels 241E/244E | 6" | |
| Cartridge Rolls 341D | | 1/2" diameter or less |
| Square Pads 341D | 3" x 3" or smaller | |
| Cross Pads 341D | 6" or less | 3" or less |
| Bands* 341D | All | 1" x 1" x 1/4" |

Die Grinder Abrasives — Heavy-Duty Grinding (1 HP)

These powerful die grinders are excellent for big jobs such as weld or stock removal.



| Product Name | 20240 8,000 Max RPM | 20239 12,000 Max RPM | 20238/28770 (extended) 18,000 Max RPM | 20237 20,000 Max RPM |
|--------------------------------|---|-------------------------|---|---|
| Scotch-Brite™ Abrasives | | | | |
| Cross Buffs | 2" | 2" or less | 1-1/2" or less | 1-1/2" or less |
| Cut & Polish Discs | 2" and 3" A MED | 2" A MED | | |
| High Strength Discs | 3" or less | | | |
| Flap Brush | 3" x 1-3/4" x 1/4" A MED, A CRS, S FIN | 2" x 1" x 1/4" A MED | | |
| Combi Wheel | 3" x 1-3/4" x 1/4" | | | |
| EXL Unitized Wheel | | | 1" to 1-1/2" 2, 3 densities; 1" to 2-1/2 and 3" x 1/8"–3/8" 4, 6, 8 densities | |
| Rapid Cut | | | 1" to 3" x 1/8" to 1" 9 density CRS+, XCS+ | |
| 3M™ Coated Abrasives | | | | |
| Flap Wheels 241E/244E | | | | 1" x 1", 2" x 1", 3" x 1", 60 & finer |
| Cartridge Rolls 341D | | 5/8" – 3/4" diameter | 1/2" diameter or less | 1/2" diameter or less |
| Square Pads 341D | 3" x 3" or smaller | 2" x 2" | | |
| Cross Pads 341D | 6" or less | 4" and 4-1/2" or less | 3" or less | 2" (1/4–20 eyelet); <2" (8–32 eyelet) |
| Bands* 341D | 1-1/2" x 2" x 1/4" | 2" x 1" x 1/4" | 1" x 1" x 1/4" | 1/4" x 1/2" x 1/8"; 1/2" x 1/2" x 1/4" |

*Use on slotted expander wheels or rubber cushion polishing wheel.
NOTE: Products and dimensions are representative, not comprehensive.

General Sanding Tips

Technical Recommendations for 3M™ Air-Powered Tools

- Use a clean, dry, lubricated air supply that will give a measured air pressure at the tool of 6.2 bar (90 psig) when the tool is running with the lever fully depressed. **Note:** Tools can be run at lower pressures, but should **never be run higher than 6.2 bar (90 psig)**. If run at a lower pressure, the performance of the tool is reduced.
- Use an approved 10mm x 8m (3/8" x 25 ft.) or 13mm x 8m (1/2" x 25 ft.) maximum length air line.
- Connect the tool to the air supply.
- It is strongly recommended that an air filter, regulator and lubricator (FRL) be used to supply clean, lubricated air at the correct pressure to the tool. If such equipment is not used, the tool should be manually lubricated.

To Manually Lubricate the Tool

- Disconnect the air line and put 2–3 drops of suitable pneumatic motor lubricating oil, such as 3M™ Air Tool Lubricant 20451, into the hose end (inlet) of the tool.
- Reconnect tool to the air supply and tap the lever to allow air to circulate the oil. Lubricate at end of day and allow oil to penetrate over night for best results.
- Lubricate daily if the tool is used frequently or if the tool starts to slow or lose power.



Air Basics

To optimize compressed air output and delivery:

90 psi under load — use your gauge

3/8" (10mm) minimum air line inside diameter

Use minimum length of airline hose necessary; no more than 25 ft. (8m)

High flow air fittings (3/16" marginal; 7/32" better; 9/32" best)

Observe compressed air demand throughout the plant

Maximum working air pressure 6.2 bar (90 psig)



Airflow Rates for Metalworking Tools

| Tool | Airflow Rate | PSI |
|--------|---------------------|-----|
| 0.3 HP | 17 SCFM (481 LPM) | 90 |
| 0.5 HP | 26 SCFM (736 LPM) | 90 |
| 1 HP | 37 SCFM (1,048 LPM) | 90 |



Random Orbital Sanding Tips

Select the orbit that's right for your project

| | |
|--|--|
|  <p>3/32" Diameter Orbit fine finish sanding</p>  <p>Chrome – 3/32"</p> |  <p>3/16" Diameter Orbit general purpose sanding</p>  <p>Silver – 3/16"</p> |
|  <p>5/16" Diameter Orbit aggressive sanding</p>  <p>Black – 5/16"</p> |  <p>3/8" Diameter Orbit most aggressive sanding</p>  <p>Gold – 3/8"</p> |

Lever indicates orbit diameter.

Basic ROS Techniques

- 1) Start the tool ON the surface; stop the tool OFF the surface
- 2) Run the tool flat on work piece (no tipping on edge)
- 3) Light operator hand pressure (let the tool do the work)
- 4) North, south, east, west sanding pattern for a uniform, quality finish

Troubleshooting Checklist

- Check for correct PSI and RPM
- Check airline length, leaks, fitting and inside diameter
- Check tool lubrication schedule
- Look for worn bearings
- Look for damaged disc pad
- Are the tool and disc pad diameter the same?
- Is the lever damaged or the muffler clogged?
- Is the speed control adjuster turned down?

Disc Sander Tips

Lubricating the Gears for Disc Sanders

Lubricate the gear head weekly or as needed with premium grease with the following properties:

- High and low temperature performance
- Shear stable
- Anti-wear protection
- Low viscosity base fluid for high speed applications
- Very low coefficient of friction

3M recommends Mobil XHP 220 or Fuchs Renolit AXS2 or equivalent.

Gear Head Grease (#13388) and Grease Gun (#13389) available through Contract Production Services, 1-800-843-0619, www.cpsabrasives.com

MOS Speed Ratings

The lowest RPM rating of an abrasive or accessory determines the RPM of the tool it can run on. Be very aware of these ratings.

Unique Factors — Be sure to consider operator preference of tool power, size and weight.

Less Aggressive

| | | |
|--------|------------------------------|---|
| 0.3 HP | Light Blending and Finishing | Mostly Surface Conditioning Discs |
| 0.5 HP | Light Grinding and Deburring | Surface Conditioning/ Coated Abrasive Discs |
| 1 HP | Grinding | Mostly Coated Abrasive Discs |

More Aggressive



Versatile Attachment System

SHORT* — “Direct Mount” Backup Pad Attachment

Shorter distance to the work piece generates less vibration and allows for better operator control.

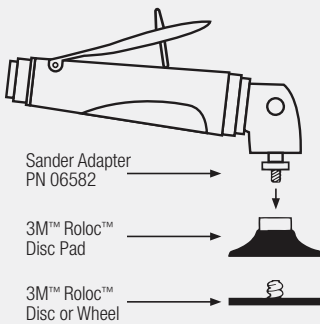

*Direct mount to disc pad.

**For other collet inserts see Owners Manual for part numbers.

TALL — 1/4" Collet Option

Allows for longer reach and mounting of other abrasives and 1/4" accessories.

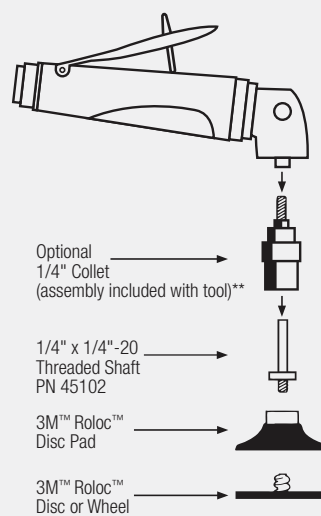

3M™ Roloc™ Attachment Systems

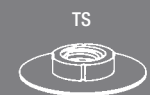



3M™ Elite Series Random Orbital Sanders

| Size | Max RPM | Motor | Orbit Dia. | UPC |
|------------------------------|---------|---------|------------|-----------------|
| Non-Vacuum | | | | |
| 3" | 12,000 | 0.28 HP | 3/16" | 051141-28494-1 |
| 3" | 12,000 | 0.28 HP | 3/32" | 051141-28496-5 |
| 5" | 12,000 | 0.28 HP | 3/8" | 051141-28583-2 |
| 5" | 12,000 | 0.28 HP | 5/16" | 051141-28495-8 |
| 5" | 12,000 | 0.28 HP | 3/16" | 051141-28497-2 |
| 5" | 12,000 | 0.28 HP | 3/16" | 051141-28708-9* |
| 5" | 12,000 | 0.28 HP | 3/32" | 051141-28498-9 |
| 6" | 12,000 | 0.28 HP | 3/8" | 051141-28582-5 |
| 6" | 12,000 | 0.28 HP | 5/16" | 051141-28499-6 |
| 6" | 12,000 | 0.28 HP | 3/16" | 051141-28500-9 |
| 6" | 12,000 | 0.28 HP | 3/32" | 051141-28501-6 |
| Self-Generated Vacuum | | | | |
| 3" | 12,000 | 0.28 HP | 3/16" | 051141-28511-5 |
| 3" | 12,000 | 0.28 HP | 3/32" | 051141-28513-9 |
| 5" | 12,000 | 0.28 HP | 3/8" | 051141-28563-4 |
| 5" | 12,000 | 0.28 HP | 5/16" | 051141-28512-2 |
| 5" | 12,000 | 0.28 HP | 3/16" | 051141-28514-6 |
| 5" | 12,000 | 0.28 HP | 3/32" | 051141-28515-3 |
| 6" | 12,000 | 0.28 HP | 3/8" | 051141-28562-7 |
| 6" | 12,000 | 0.28 HP | 5/16" | 051141-28510-8 |
| 6" | 12,000 | 0.28 HP | 3/16" | 051141-28516-0 |
| 6" | 12,000 | 0.28 HP | 3/32" | 051141-28517-7 |
| Central-Vacuum-Ready | | | | |
| 3" | 12,000 | 0.28 HP | 3/16" | 051141-28503-0 |
| 3" | 12,000 | 0.28 HP | 3/32" | 051141-28505-4 |
| 5" | 12,000 | 0.28 HP | 3/8" | 051141-28561-0 |
| 5" | 12,000 | 0.28 HP | 5/16" | 051141-28504-7 |
| 5" | 12,000 | 0.28 HP | 3/16" | 051141-28506-1 |
| 5" | 12,000 | 0.28 HP | 3/32" | 051141-28507-8 |
| 6" | 12,000 | 0.28 HP | 3/8" | 051141-28560-3 |
| 6" | 12,000 | 0.28 HP | 5/16" | 051141-28502-3 |
| 6" | 12,000 | 0.28 HP | 3/16" | 051141-28508-5 |
| 6" | 12,000 | 0.28 HP | 3/32" | 051141-28509-2 |

*Comes with 3M™ Hookit™ Backup Pad 20352

3M™ Random Orbital Sanders

| Size | Max RPM | Motor | Orbit Dia. | UPC |
|------------------------------|---------|---------|------------|----------------|
| Self-Generated Vacuum | | | | |
| 5" | 12,000 | 0.24 HP | 3/16" | 051141-20319-5 |
| 6" | 12,000 | 0.24 HP | 5/16" | 051141-20208-2 |
| 6" | 12,000 | 0.24 HP | 3/16" | 051141-20327-0 |
| Non-Vacuum | | | | |
| 5" | 12,000 | 0.24 HP | 3/16" | 051141-20317-1 |
| 6" | 12,000 | 0.24 HP | 5/16" | 051141-20324-9 |
| 6" | 12,000 | 0.24 HP | 3/16" | 051141-20325-6 |

3M™ Elite Series Mini Orbital Sander

| Size | Max RPM | Motor | UPC |
|----------------|---------|---------|----------------|
| 1-1/4" x 3/16" | 8,000 | 0.48 HP | 051141-28737-9 |

3M™ Mini-Random Orbital Sander

| Size | Max RPM | Motor | UPC |
|----------------|---------|---------|----------------|
| 1-1/4" x 3/16" | 8,000 | 0.24 HP | 051141-20244-0 |

3M™ Electric Random Orbital Sander Kits

| Size | Max RPM | Motor | Orbit Dia. | UPC |
|-----------------------------|---------|------------|------------|----------------|
| Central-Vacuum-Ready | | | | |
| 6" | 10,000 | .20-.24 HP | 3/32" | 051141-28521-4 |
| 6" | 10,000 | .20-.24 HP | 3/16" | 051141-28522-1 |
| Non-Vacuum | | | | |
| 6" | 10,000 | .20-.24 HP | 3/32" | 051141-28525-2 |
| 6" | 10,000 | .20-.24 HP | 3/16" | 051141-28526-9 |

3M™ Orbital Sanders

| Size | Max RPM | Motor | Orbit Dia. | UPC |
|------------------------|---------|---------|------------|----------------|
| Elite Series | | | | |
| 2-3/4" x 7-3/4" | 10,000 | 0.28 HP | 1/8" | 051141-28527-6 |
| | 10,000 | 0.28 HP | 1/8" | 051141-28528-3 |
| | 10,000 | 0.28 HP | 1/8" | 051141-28529-0 |
| Original Series | | | | |
| 3" x 4" | 10,000 | 0.24 HP | 1/8" | 051141-20331-7 |
| | 10,000 | 0.24 HP | 1/8" | 051141-20430-7 |
| | 10,000 | 0.24 HP | 1/8" | 051141-20431-4 |

3M™ Buffers

| Size | Max RPM | Motor | Orbit Dia. | UPC |
|--------------------|---------|---------|------------|----------------|
| 3" | 11,000 | 0.26 HP | 1/2" | 051141-28333-3 |
| 3" | 3,500 | 0.26 HP | Rotary | 051141-28631-0 |
| 5" | 10,000 | 0.45 HP | 3/8" | 051141-28392-0 |
| Pistol Grip | | | | |
| 3" | 2,200 | 0.45 HP | Rotary | 051141-28354-8 |

3M™ Electric Variable Speed Polisher

| Size | Max RPM | Motor | Orbit Dia. | UPC |
|------|---------|-------|------------|----------------|
| 7" | 3,000 | 11A | — | 051141-28391-3 |

3M™ Random Orbital Sander, 2-Hand

| Size | Max RPM | Motor | Orbit Dia. | UPC |
|--|---------|---------|------------|----------------|
| Non-Vacuum/Central-Vacuum-Ready | | | | |
| 6" | 12,000 | 0.45 HP | 3/8" | 051141-28337-1 |
| Self-Generated Vacuum | | | | |
| 6" | 12,000 | 0.45 HP | 3/8" | 051141-28335-7 |

3M™ Die Grinders

| Max RPM | Motor | Length | UPC |
|---------|--------|----------|----------------|
| 25,000 | 0.3 HP | Extended | 051141-28630-3 |
| 25,000 | 0.3 HP | Regular | 051141-28629-7 |
| 18,000 | 0.3 HP | Extended | 051141-28628-0 |
| 18,000 | 0.3 HP | Regular | 051141-28627-3 |
| 18,000 | 0.5 HP | Regular | 051141-28330-2 |
| 18,000 | 0.5 HP | Extended | 051141-28331-9 |
| 4,000 | 0.5 HP | Regular | 051141-28332-6 |
| 20,000 | 1 HP | Regular | 051141-20237-2 |
| 18,000 | 1 HP | Regular | 051141-20238-9 |
| 18,000 | 1 HP | Extended | 051141-28770-6 |
| 12,000 | 1 HP | Regular | 051141-20239-6 |
| 8,000 | 1 HP | Regular | 051141-20240-2 |

3M™ Grinders (Type 27)

| Size | Max RPM | Motor | Desc. | UPC |
|-----------|---------|--------|----------|----------------|
| 4" | 12,000 | 1 HP | Regular | 051141-28403-3 |
| 4" | 12,000 | 1 HP | Extended | 051141-28413-2 |
| 4-1/2" | 12,000 | 1 HP | Regular | 051141-28405-7 |
| 4-1/2" | 12,000 | 1 HP | Extended | 051141-28414-9 |
| 4-1/2"-5" | 12,000 | 1.5 HP | Regular | 051141-28824-6 |

3M™ Disc Sanders

| Size | Max RPM | Motor | UPC |
|-----------|---------|--------|----------------|
| 2" | 20,000 | 0.3 HP | 051141-28341-8 |
| 2" | 12,000 | 0.3 HP | 051141-28328-9 |
| 2" | 20,000 | 0.5 HP | 051141-20231-0 |
| 2" | 12,000 | 0.5 HP | 051141-28329-6 |
| 3" | 15,000 | 1 HP | 051141-20232-7 |
| 4"-5" | 12,000 | 1 HP | 051141-28408-8 |
| 4"-5" | 12,000 | 1 HP | 051141-28622-8 |
| 4-1/2"-5" | 12,000 | 1.5 HP | 051141-28825-3 |

Pistol Grip

| | | | |
|----|--------|---------|-----------------|
| 3" | 15,000 | 0.45 HP | 051141-28547-4 |
| 3" | 15,000 | 0.45 HP | 051141-28353-1* |

*Random orbital tool with 1/8" orbit

3M™ Cut-Off Wheel Tools

| Size | Max RPM | Motor | UPC |
|-----------|---------|--------|----------------|
| 3" | 25,000 | 1 HP | 051141-20233-4 |
| 4" | 20,000 | 1 HP | 051141-20234-1 |
| 4" | 19,000 | 1 HP | 051141-28771-3 |
| 4" | 18,000 | 1 HP | 051141-28407-1 |
| 5" | 12,000 | 1 HP | 051141-20235-8 |
| 6" | 10,000 | 1 HP | 051141-20236-5 |
| 4-1/2"-5" | 12,000 | 1.5 HP | 051141-28826-0 |

3M™ Sander/Buffer

| Size | Max RPM | Motor | UPC |
|-------|---------|-------|----------------|
| 5"-7" | 3,500 | 1 HP | 051141-28773-7 |

3M™ Sanders

| Size | Max RPM | Motor | UPC |
|------------------------------------|---------|--------|----------------|
| 3M™ Inline Sanders | | | |
| — | 1,600 | 1 HP | 051141-28338-8 |
| — | 3,500 | 1 HP | 051141-28339-5 |
| 3M™ Match and Finish Sander | | | |
| — | 3,500 | 1 HP | 051141-28659-4 |
| 3M™ Sander/Buffer | | | |
| 5"-7" | 3,500 | 1 HP | 051141-28773-7 |
| 3M™ File Belt Sander | | | |
| — | 22,000 | 0.6 HP | 051141-28366-1 |

3M™ Power Tool Accessories

3M™ Filter Bags and Adapters



| UPC | Size |
|---|----------------------------------|
| 3M™ Clean Sanding Filter Bag — HEPA-rated | |
| 051141-20452-9 | Large — Holds up to 1/2 lb. |
| 051141-28364-7 | Extra Large — Holds up to 3 lbs. |
| 3M™ Clean Sanding Filter Bag Backpack Assembly | |
| 051141-28365-4 | — |
| 3M™ Filter Bag Adapter | |
| 051141-20453-6 | 1" EXT Hose Thread x 1" ID |

3M™ Hookit™ Clean Sanding Disc Pads

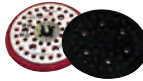

| UPC | Size | Thickness | Density |
|-----------------------------|------------------|-----------|---------|
| Max RPM/OPM = 12,000 | | | |
| 051141-20428-4 | 3" x 1/4-20 EXT | 3/4" | Soft |
| 051141-20290-7 | 5" x 5/16-24 EXT | 11/16" | Soft |
| 051141-20353-9 | 5" x 5/16-24 EXT | 3/8" | Firm |
| 051141-20465-9 | 6" x 5/16-24 EXT | 3/8" | Firm |
| 051141-20356-0 | 6" x 5/16-24 EXT | 3/8" | Firm |
| 051141-20425-3 | 6" x 5/16-24 EXT | 1/2" | Soft |
| Max RPM/OPM = 15,000 | | | |
| 051141-20350-8 | 3" x 1/4-20 EXT | 1/2" | Firm |

3M™ Hookit™ Disc Pads

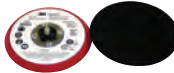

| UPC | Size | Thickness | Density |
|-----------------------------|------------------|-----------|---------|
| Max RPM/OPM = 12,000 | | | |
| 051131-05775-3 | 5" x 5/16-24 EXT | 3/4" | Medium |
| 051141-20352-2 | 5" x 5/16-24 EXT | 3/8" | Firm |
| 051144-77855-3 | 5" x 5/16-24 EXT | 11/16" | Soft |
| 051141-20355-3 | 6" x 5/16-24 EXT | 3/8" | Firm |
| Max RPM/OPM = 15,000 | | | |
| 051141-28472-9 | 3" x 1/4-20 EXT | 1/2" | Firm |

3M™ Stikit™ Disc Pads



| UPC | Diameter | Thickness | Density |
|--|------------------|-----------|---------|
| Max OPM/RPM = 15,000 | | | |
| 051141-20348-5 | 3" x 1/4-20 EXT | 1/2" | Firm |
| Max RPM = 12,000 | | | |
| 051111-55813-3 | 5" x 5/8-11 INT | 1/2" | Medium |
| 051141-28661-7 | 5" x 5/8-11 INT | 1/2" | Medium |
| 051144-82189-1 | 5" x 5/8-11 INT | 3/4" | Medium |
| Max OPM = 12,000 Max RPM = 10,000 | | | |
| 051144-85104-1 | 5" x 5/16-24 EXT | 3/8" | Firm |
| 051144-05575-3 | 5" x 5/16-24 EXT | 3/4" | Medium |
| 051144-45215-6 | 5" x 5/16-24 EXT | 3/4" | Medium |
| 051144-81821-1 | 5" x 5/16-24 EXT | 3/4" | Medium |
| 051131-05546-9 | 6" x 5/16-24 EXT | 11/16" | Soft |
| Max OPM/RPM = 12,000 | | | |
| 051141-20351-5 | 5" x 5/16-24 EXT | 3/8" | Firm |
| 051131-05545-2 | 5" x 5/16-24 EXT | 11/16" | Soft |
| 051141-20354-6 | 6" x 5/16-24 EXT | 3/8" | Firm |

3M™ Hookit™ Clean Sanding Pads



| UPC | Size | Thickness | Density |
|-------------------------|--------------|-----------|---------|
| Max OPM = 10,000 | | | |
| 051141-20435-2 | 3" x 4" | 1/2" | Medium |
| 051141-28531-3 | 70mm x 198mm | 12.7mm | Medium |

3M™ Hookit™ Pad



| UPC | Size | Thickness | Density | Max OPM |
|----------------|---------|-----------|---------|---------|
| 051141-20433-8 | 3" x 4" | 1/2" | Medium | 10,000 |

3M™ Orbital/Random Orbital Sander Grips



| UPC | Diameter |
|----------------|----------|
| 051141-20342-3 | 2-1/2" |
| 051141-20343-0 | 2-3/4" |
| 051141-20344-7 | 3" |

3M™ Finesse-it™ Buffing Pads



| UPC | Diameter | Description |
|-------------------------|----------|------------------------|
| Max OPM = 12,000 | | |
| 051111-51151-0 | 3-1/4" | Orange Foam/White Loop |
| 051141-25134-9 | 3-1/4" | Gray Foam/White Loop |
| 051141-20271-6 | 3-3/4" | White Foam/White Loop |
| 051111-51158-9 | 3-3/4" | Orange Foam/White Loop |
| 051141-25135-6 | 3-3/4" | Gray Foam/White Loop |
| 051111-51076-6 | 5-1/4" | Orange Foam/White Loop |

3M™ Roloc™ Shank

| UPC | Shank Size | Thread Size |
|----------------|------------|-------------|
| 051144-45102-9 | 1/4" | 1/4-20 EXT |

3M™ Roloc™ Disc Pads



| UPC | Size | Max RPM | Density |
|-----------------------------------|-----------------|---------|------------|
| Roloc™ TR (Plastic Button) | | | |
| 051144-45096-1 | 2" x 1/4-20 INT | 25,000 | Hard |
| 051144-45091-6 | 3" x 1/4-20 INT | 20,000 | Hard |
| 051144-83980-3 | 4" x 5/8-11 INT | 12,000 | Extra Hard |
| 051141-28475-0 | 4" x 3/8-24 INT | 12,000 | Extra Hard |
| Roloc™ TS/TSM | | | |
| 051144-14212-5 | 2" x 1/4-20 INT | 25,000 | Hard |
| 051144-14216-3 | 3" x 1/4-20 INT | 20,000 | Hard |
| 051144-28577-1 | 4" x 3/8-24 INT | 12,000 | Extra Hard |
| 051144-28579-5 | 4" x 5/8-11 INT | 12,000 | Extra Hard |

3M™ Hookit™ Roloc™ Disc Pads

| UPC | Diameter | Max OPM | Max RPM |
|-----------------------------------|----------|---------|---------|
| Roloc™ TR (Plastic Button) | | | |
| 051144-82564-6 | 1" | 10,000 | 8,000 |
| 051111-60311-6 | 1-1/16" | 10,000 | 10,000 |
| 051144-82565-3 | 1-1/2" | 10,000 | 8,000 |
| 051144-82566-0 | 2" | 10,000 | 8,000 |
| 051144-82567-7 | 3" | 10,000 | 8,000 |

3M™ Finesse-it™ Roloc™ Backup Pad — TR

| UPC | Size | Max RPM |
|----------------|--------|---------|
| 051111-50198-6 | 1-1/4" | 12,000 |

3M™ Disc Pad Hubs



| UPC | Diameter | Thread Size |
|----------------|----------|-------------------------|
| 051141-28442-2 | 2-1/2" | 3/8-24 INT x 5/8-11 EXT |
| 051141-28476-7 | 2-1/2" | 5/8-11 INT |

Disc Pad Holders (Hook-and-Loop)



| UPC | Size | Max RPM |
|----------------|---------------------|---------|
| 048011-07494-8 | 2" x 1/4" shank | 23,000 |
| 048011-04132-2 | 3" x 1/4" shank | 20,000 |
| 048011-07492-4 | 4" x 1/4" shank | 13,000 |
| 048011-05674-6 | 4" x 5/8-11 INT | 13,000 |
| 048011-14111-4 | 4-1/2" x 5/8-11 INT | 13,000 |

3M™ Disc Pad Face Plates



| UPC | Diameter | Hardness | Max RPM |
|----------------|----------|------------|---------|
| Ribbed | | | |
| 051141-28656-3 | 4" | Extra Hard | 15,000 |
| 051141-28443-9 | 4-1/2" | Extra Hard | 13,300 |
| 051144-81732-0 | 5" | Extra Hard | 12,000 |

3M™ Disc Retainer Nuts



| UPC | Length | Thread Size |
|----------------|--------|-------------|
| 051111-51047-6 | 5/16" | 5/8-11 INT |
| 051144-05622-4 | 3/8" | 5/8-11 INT |

3M™ Air Tool and Compressor Lubricants



| UPC | Size |
|----------------|-------------------|
| 051141-20466-6 | Quart |
| 051141-20467-3 | Gallon |
| 051141-20451-2 | 4 fl. oz. (118mL) |
| 051141-28828-4 | 1 fl. oz. |

3M™ 935 Mini Mandrel



| UPC | Shank Size | Overall Length | Max RPM |
|----------------|------------|----------------|---------|
| 048011-04020-2 | 1/4" | 2-7/8" | 14,000 |

3M™ Square/Cross Pad Mandrels

| UPC | Thread Size | Shank Size | Overall Length |
|-------------------------|-------------|------------|----------------|
| Max RPM = 24,100 | | | |
| 051144-14307-8 | 8-32 EXT | 1/4" | 3" |
| 051144-14308-5 | 1/4-20 EXT | 1/4" | 3" |

3M™ Unitized Wheel Mandrels



| UPC | Part No. | Overall Length | Outside Flange Diameter | Max RPM |
|--------------------------|----------|----------------|-------------------------|---------|
| Shank Size = 1/4" | | | | |
| 048011-04018-9 | 936 | 2-1/16" | 3/4" | 22,200 |
| 048011-15012-3 | 990 | 1-3/4" | 1" | 25,100 |

3M™ Adapters



| UPC | Size |
|------------------------------|-------------------------|
| 3M™ Wheel Adapter Kit | |
| 051141-28419-4 | 1/2-20 EXT x 5/8-11 INT |
| 051144-45038-1 | 5/8-11 EXT x 5/8-11 INT |

3M™ Spindle Extender Kit

| | |
|----------------|-------------------------|
| 048011-04019-6 | 5/8-11 EXT x 5/8-11 INT |
|----------------|-------------------------|

Replacement Spacers

| | |
|----------------|-------------------------------|
| 051141-28636-5 | 1" OD x 5/8" ID x 3/8" thick |
| 051141-28637-2 | 1" OD x 5/8" ID x 3/16" thick |

3M™ Match and Finish Adapter Kit

| | |
|----------------|-----------------|
| 051141-27819-5 | 1" x 5/8-11 INT |
|----------------|-----------------|

3M™ Rubber Cushion Polishing Wheels



| UPC | Diameter | Width | Max RPM |
|--------------------------|----------|-------|---------|
| Shank Size = 1/4" | | | |
| 051144-45139-5 | 1" | 1" | 18,000 |
| 051144-45129-6 | 2" | 1" | 11,000 |
| 051144-45127-2 | 2" | 2" | 6,000 |

3M™ Rubber Slotted Expander Wheels



| UPC | Size | Density | Max RPM |
|----------------|-----------------------|---------|---------|
| 051144-77717-4 | 1" x 1" x 1/4" | Medium | 18,000 |
| 051144-77720-4 | 2" x 1" x 1/4" | Medium | 12,000 |
| 051144-77721-1 | 2" x 2" x 1/4" | Medium | 6,000 |
| 051144-77722-8 | 3" x 3" x 5/8-11 INT | Medium | 6,000 |
| 051141-28349-4 | 3.4" x 3" x 5/8" CH | Soft | 3,500 |
| 051141-28348-7 | 5" x 3-1/2" x 5/8" CH | Soft | 3,500 |
| 051141-28718-8 | 5" x 3-1/2" x 1" AH | Soft | 3,500 |

3M™ File Belt Sander Attachment Arms



| UPC | Description |
|----------------|---------------------------------------|
| 051141-28368-5 | Standard Style |
| 051141-28369-2 | Thin Style |
| 051141-28370-8 | Corners Style |
| 051141-28371-5 | Thick Standard Style |
| 051141-28372-2 | Corners Style |
| 051141-28374-6 | Curved Arm |
| 051141-28375-3 | Vessel Arm |
| 051141-28376-0 | Extension — Extend arms to 24" length |

The full line of 3M™ Accessories is available in the Accessories for Abrasive Products catalog.

Optimize Results With 3M™ Power Tools

Product Use: Many factors beyond 3M's control and uniquely within user's knowledge and control can affect the use and performance of a 3M product in a particular application. Given the variety of factors that can affect the use and performance of a 3M product, user is solely responsible for determining whether it is fit for a particular purpose and suitable for user's method of application.

Warranty and Limited Remedy: 3M warrants this tool against defects in workmanship and materials under normal operating conditions for one (1) year from the date of purchase. 3M MAKES NO OTHER WARRANTIES, EXPRESS OR IMPLIED, INCLUDING, BUT NOT LIMITED TO, ANY IMPLIED WARRANTY OF MERCHANTABILITY OR FITNESS FOR A PARTICULAR PURPOSE OR ANY IMPLIED WARRANTY ARISING OUT OF A COURSE OF DEALING, CUSTOM OR USAGE OF TRADE. User is responsible for determining whether the 3M tool is fit for a particular purpose and suitable for user's application. User must operate the tool in accordance with all applicable operating instructions, safety precautions, and other procedures stated in the operating manual to be entitled to warranty coverage. 3M shall have no obligation to repair or replace any tool or part that fails due to normal wear, inadequate or improper maintenance, inadequate cleaning, non-lubrication, improper operating environment, improper utilities, operator error or misuse, alteration or modification, mishandling, lack of reasonable care, or due to any accidental cause. If a tool or any part thereof is defective within this warranty period, your exclusive remedy and 3M's sole obligation will be, at 3M's option, to repair or replace the tool or refund the purchase price.

Limitation of Liability: Except where prohibited by law, 3M will not be liable for any loss or damage arising from the 3M product, whether direct, indirect, special, incidental or consequential, regardless of the legal theory asserted, including warranty, contract, negligence or strict liability.

For warranty and repair service, call **1-800-362-3550** (choose option 3, then option 5)

The full line of 3M™ Accessories is available in the
Accessories for Abrasive Products catalog.

3M™ Power Tools. Abrasives Tools from the Abrasives Experts.



3M Abrasive Systems Division
3M Center
Building 223-6S-03
St. Paul, MN 55144-1000
www.3M.com/PowerTools

3M, Cubitron, Finesse-it, Green Corps, Hookit, PPS, Roloc, Scotch, Scotch-Brite, Stikit, SUN GUN and Trizact are trademarks of 3M. Used under license in Canada.

Please recycle. Printed in U.S.A. © 3M 2015. All rights reserved. 61-5002-8217-5 Rev. 6/15