

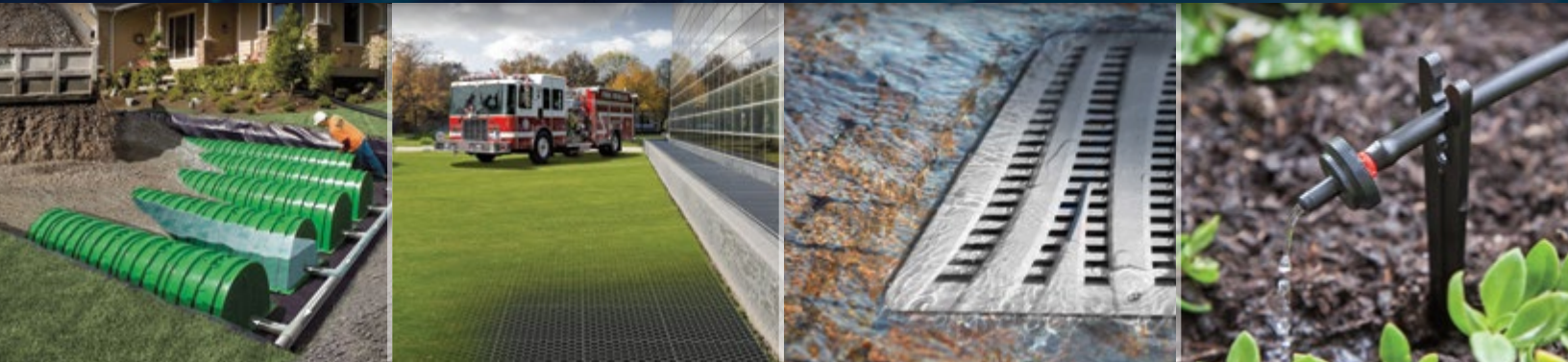

NDS®
We put water in its place

Your knowledgeable and
trusted partner for the best in
water management solutions



2016/2017 Product Catalog

Commercial Stormwater Management

Residential Stormwater Management

Professional Irrigation

Flow Management



FITTINGS



FITTINGS

Our comprehensive line of sewer and drain fittings includes valves, couplings, and connectors in PVC and styrene. NDS continues its tradition of innovation with the new patent pending Swivel-Fit™ variable angle fitting that combines two fixed fittings into one adjustable fitting solution.

SOLVENT WELD SEWER & DRAIN FITTINGS

Standards

Styrene A.S.T.M. D-2852

PVC A.S.T.M. D-3034, D-2751, D-2729

Abbreviations Used for Connections

HUB = HUB Socket

MPT = Male Pipe Thread

FPT = Female Pipe Thread

SPT = Spigot

DWV = Drain, Waste and Vent

S&D = Sewer and Drain



One Adjustable Fitting for Any Job

The patent-pending Swivel Fit® Variable Angle Fitting can be set to any angle from 0° to 90°. It is a convenient solution to tackle any job and is easy and less expensive than connecting multiple fixed angle fittings.

FITTINGS

Variable Angle Fittings

Patent Pending



Part No.	Description	Color	Pkg. Qty.	Wt. Ea. (lbs.)	Product Class
4PVAF	NDS 4" Swivel Fit®	White	12	1.00	30PV

SOLVENT WELD SEWER & DRAIN FITTINGS

Tee

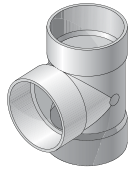

	Part No.	Description	Color	Pkg. Qty.	Wt. Ea. (lbs.)	Product Class
PVC	3P01	3" PVC Tee (HUB x HUB x HUB)	White	35	0.57	30PV
	4P01	4" PVC Tee (HUB x HUB x HUB)	White	20	0.95	30PV
	6P01	6" PVC Tee (HUB x HUB x HUB)	White	9	3.66	30PV
	64P01	6" x 4" PVC Tee (HUB x HUB x HUB)	White	8	2.38	30PV
	8P01	8" PVC Tee (HUB x HUB x HUB)	White	2	3.00	30PV
	84P01	8" x 4" PVC Tee (HUB x HUB x HUB)	White	7	4.72	30PV
	86P01	8" x 6" PVC Tee (HUB x HUB x HUB)	White	3	5.00	30PV
STYRENE	301	3" Styrene Tee (HUB x HUB x HUB)	White	35	0.43	30ST
	401	4" Styrene Tee (HUB x HUB x HUB)	White	20	0.60	30ST
	601	6" Styrene Tee (HUB x HUB x HUB)	White	9	2.78	30ST

Double Cleanout

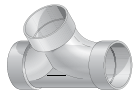

	Part No.	Description	Color	Pkg. Qty.	Wt. Ea. (lbs.)	Product Class
PVC	417P	4" PVC Double Cleanout (HUB x HUB x HUB)	White	24	1.41	30PV

90 Degree Elbow

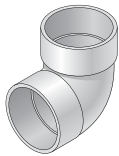

	Part No.	Description	Color	Pkg. Qty.	Wt. Ea. (lbs.)	Product Class
PVC	3P02	3" PVC 90 Degree Elbow (HUB x HUB)	White	40	0.40	30PV
	4P02	4" PVC 90 Degree Elbow (HUB x HUB)	White	25	0.68	30PV
	6P02	6" PVC 90 Degree Elbow (HUB x HUB)	White	6	3.00	30PV
	8P02	8" PVC 90 Degree Elbow (HUB x HUB)	White	4	6.50	30PV
	STYRENE	302	3" Styrene 90 Degree Elbow (HUB x HUB)	White	40	0.33
402		4" Styrene 90 Degree Elbow (HUB x HUB)	White	25	0.48	30ST
602		6" Styrene 90 Degree Elbow (HUB x HUB)	White	6	2.33	30ST

90 Degree Long Turn Elbow

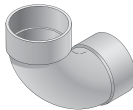

	Part No.	Description	Color	Pkg. Qty.	Wt. Ea. (lbs.)	Product Class
PVC	31P0	3" PVC 90 Degree Long Turn Elbow (HUB x HUB)	White	30	0.46	30PV
	41P0	4" PVC 90 Degree Long Turn Elbow (HUB x HUB)	White	20	0.85	30PV
	61P0	6" PVC 90 Degree Long Turn Elbow (HUB x HUB)	White	8	3.10	30PV
STYRENE	310	3" Styrene 90 Degree Long Turn Elbow (HUB x HUB)	White	30	0.30	30ST
	410	4" Styrene 90 Degree Long Turn Elbow (HUB x HUB)	White	20	0.65	30ST

90 Degree Long Turn Street Elbow

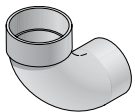

	Part No.	Description	Color	Pkg. Qty.	Wt. Ea. (lbs.)	Product Class
PVC	31POST	3" PVC 90 Degree Long Turn Street Elbow (SPT x HUB)	White	20	0.90	30PV
	41POST	4" PVC 90 Degree Long Turn Street Elbow (SPT x HUB)	White	20	1.25	30PV
STYRENE	310ST	3" Styrene 90 Degree Long Turn Street Elbow (SPT x HUB)	White	20	0.65	30ST
	410ST	4" Styrene 90 Degree Long Turn Street Elbow (SPT x HUB)	White	20	1.00	30ST

45 Degree Elbow

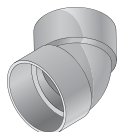

	Part No.	Description	Color	Pkg. Qty.	Wt. Ea. (lbs.)	Product Class
PVC	3P03	3" PVC 45 Degree Elbow (HUB x HUB)	White	40	0.32	30PV
	4P03	4" PVC 45 Degree Elbow (HUB x HUB)	White	30	0.53	30PV
	6P03	6" PVC 45 Degree Elbow (HUB x HUB)	White	8	2.12	30PV
	8P03	8" PVC 45 Degree Elbow (HUB x HUB)	White	6	4.33	30PV
STYRENE	303	3" Styrene 45 Degree Elbow (HUB x HUB)	White	40	0.25	30ST
	403	4" Styrene 45 Degree Elbow (HUB x HUB)	White	30	0.35	30ST
	603	6" Styrene 45 Degree Elbow (HUB x HUB)	White	8	1.63	30ST

SOLVENT WELD SEWER & DRAIN FITTINGS

45 Degree Street Elbow

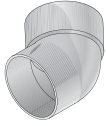

	Part No.	Description	Color	Pkg. Qty.	Wt. Ea. (lbs.)	Product Class
PVC	3P03ST	3" PVC 45 Degree Street Elbow (SPT x HUB)	White	30	0.33	30PV
	4P03ST	4" PVC 45 Degree Street Elbow (SPT x HUB)	White	30	0.86	30PV
	6P03ST	6" PVC 45 Degree Street Elbow (SPT x HUB)	White	10	1.80	30PV
STYRENE	303ST	3" Styrene 45 Degree Street Elbow (SPT x HUB)	White	30	0.27	30ST
	403ST	4" Styrene 45 Degree Street Elbow (SPT x HUB)	White	30	0.67	30ST

22 1/2 Degree Elbow

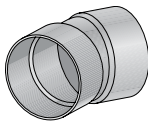

	Part No.	Description	Color	Pkg. Qty.	Wt. Ea. (lbs.)	Product Class
PVC	3P04	3" PVC 22-1/2 Degree Street Elbow (HUB x HUB)	White	25	0.32	30PV
	4P04	4" PVC 22-1/2 Degree Street Elbow (HUB x HUB)	White	20	0.45	30PV
	6P04	6" PVC 22-1/2 Degree Street Elbow (HUB x HUB)	White	20	1.60	30PV
STYRENE	304	3" Styrene 22-1/2 Degree Street Elbow (HUB x HUB)	White	25	0.24	30ST
	404	4" Styrene 22-1/2 Degree Street Elbow (HUB x HUB)	White	20	0.30	30ST

Coupling

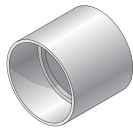

	Part No.	Description	Color	Pkg. Qty.	Wt. Ea. (lbs.)	Product Class
PVC	3P05	3" PVC Coupling (HUB x HUB)	White	120	0.22	30PV
	4P05	4" PVC Coupling (HUB x HUB)	White	45	0.37	30PV
	6P05	6" PVC Coupling (HUB x HUB)	White	10	1.30	30PV
	8P05	8" PVC Coupling (HUB x HUB)	White	6	3.33	30PV
STYRENE	305	3" Styrene Coupling (HUB x HUB)	White	120	0.17	30ST
	405	4" Styrene Coupling (HUB x HUB)	White	45	0.30	30ST
	605	6" Styrene Coupling (HUB x HUB)	White	10	0.89	30ST

Sewer and Drain Repair Coupling

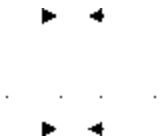

	Part No.	Description	Color	Pkg. Qty.	Wt. Ea. (lbs.)	Product Class
PVC	3P05R	3" PVC Sewer and Drain Repair Coupling (HUB x HUB)	White	60	0.25	30PV
	4P05R	4" PVC Sewer and Drain Repair Coupling (HUB x HUB)	White	45	0.46	30PV

Reducer Bushing (SPTxHUB)



	Part No.	Description	Color	Pkg. Qty.	Wt. Ea. (lbs.)	Product Class
PVC	3P07	4" x 3" PVC Reducer Bushing (SPT x HUB) (SPT x HUB)	White	20	0.45	30PV
	6P07S	6" x 4" PVC Reducer Bushing (SPT x HUB) (SPT x HUB)	White	20	1.10	30PV
STYRENE	307	4" x 3" Styrene Reducer Bushing (SPT x HUB) (SPT x HUB)	White	20	0.35	30ST

Reducer Coupling

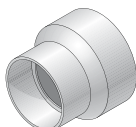

	Part No.	Description	Color	Pkg. Qty.	Wt. Ea. (lbs.)	Product Class
PVC	4P07	4" x 3" PVC Reducer Coupling (HUB x HUB)	White	30	0.36	30PV
	6P07	4" x 6" PVC Reducer Coupling (HUB x HUB)	White	20	1.10	30PV
	8P07	8" x 6" PVC Reducer Coupling (HUB x HUB)	White	1	3.00	30PV
STYRENE	407	4" x 3" Styrene Reducer Coupling (HUB x HUB)	White	30	0.30	30ST
	607	4" x 6" Styrene Reducer Coupling (HUB x HUB)	White	20	0.80	30ST

SOLVENT WELD SEWER & DRAIN FITTINGS

45 Degree Street Wye

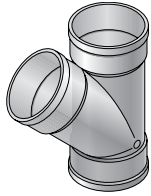

	Part No.	Description	Color	Pkg. Qty.	Wt. Ea. (lbs.)	Product Class
PVC	3P08	3" PVC 45 Degree Wye (HUB x HUB x HUB)	White	25	0.88	30PV
	4P08	4" PVC 45 Degree Wye (HUB x HUB x HUB)	White	20	1.25	30PV
	6P08	6" PVC 45 Degree Wye (HUB x HUB x HUB)	White	6	4.66	30PV
	64P08	6" x 4" PVC 45 Degree Wye (HUB x HUB x HUB)	White	8	2.88	30PV
	8P08	8" PVC 45 Degree Wye (HUB x HUB x HUB)	White	2	11.00	30PV
	84P08	8" x 4" PVC 45 Degree Wye (HUB x HUB x HUB)	White	6	5.33	30PV
	86P08	8" x 6" PVC 45 Degree Wye (HUB x HUB x HUB)	White	3	3.33	30PV
STYRENE	308	3" Styrene 45 Degree Wye (HUB x HUB x HUB)	White	25	0.72	30ST
	408	4" Styrene 45 Degree Wye (HUB x HUB x HUB)	White	20	1.00	30ST
	608	6" Styrene 45 Degree Wye (HUB x HUB x HUB)	White	6	3.67	30ST

Sanitary Tee

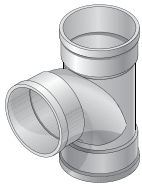

	Part No.	Description	Color	Pkg. Qty.	Wt. Ea. (lbs.)	Product Class
PVC	3P09	3" PVC Sanitary Tee (HUB x HUB x HUB)	White	30	0.66	30PV
	4P09	4" PVC Sanitary Tee (HUB x HUB x HUB)	White	20	1.60	30PV
	6P09	6" PVC Sanitary Tee (HUB x HUB x HUB)	White	5	4.20	30PV
	8P09	8" PVC Sanitary Tee (HUB x HUB x HUB)	White	1	15.00	30PV
STYRENE	309	3" Styrene Sanitary Tee (HUB x HUB x HUB)	White	30	0.53	30ST
	409	4" Styrene Sanitary Tee (HUB x HUB x HUB)	White	20	1.25	30ST

Drain Cap

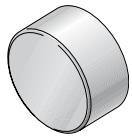

	Part No.	Description	Color	Pkg. Qty.	Wt. Ea. (lbs.)	Product Class
PVC	3P06	3" PVC Drain Cap	White	25	0.20	30PV
	4P06	4" PVC Drain Cap	White	25	0.28	30PV
	6P06	6" PVC Drain Cap	White	15	0.93	30PV
	8P06	8" PVC Drain Cap	White	10	2.40	30PV
STYRENE	306	3" Styrene Drain Cap	White	25	0.16	30ST
	406	4" Styrene Drain Cap	White	25	0.30	30ST
	606	6" Styrene Drain Cap	White	15	0.73	30ST

Female Adapter



	Part No.	Description	Color	Pkg. Qty.	Wt. Ea. (lbs.)	Product Class
PVC	3P11	3" PVC Female Adapter (HUB x FPT)	White	25	0.36	30PV
	4P11	4" PVC Female Adapter (HUB x FPT)	White	20	0.55	30PV
	613P	6" PVC Female Adapter (HUB x FPT)	White	24	1.08	30PV
STYRENE	311	3" Styrene Female Adapter (HUB x FPT)	White	25	0.15	30ST
	411	4" Styrene Female Adapter (HUB x FPT)	White	20	0.45	30ST

Fitting Cleanout



	Part No.	Description	Color	Pkg. Qty.	Wt. Ea. (lbs.)	Product Class
PVC	413P	4" PVC Fitting Cleanout (SPT x FPT)	White	20	0.50	30PV
STYRENE	413	4" Styrene Fitting Cleanout (SPT x FPT)	White	20	0.40	30ST

MPT Plug

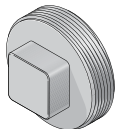

	Part No.	Description	Color	Pkg. Qty.	Wt. Ea. (lbs.)	Product Class
PVC	31P8	3" PVC MPT Plug	White	50	0.30	30PV
	41P8	4" PVC MPT Plug	White	30	0.36	30PV
	61P8	6" PVC MPT Plug	White	24	0.62	30PV
STYRENE	418	4" Styrene MPT Plug	White	30	0.27	30ST

SOLVENT WELD SEWER & DRAIN FITTINGS

Variable Angle Fittings

Patent Pending



Cross

Part No.	Description	Color	Pkg. Qty.	Wt. Ea. (lbs.)	Product Class
4PVAF	NDS 4" Swivel Fit®	White	12	1.00	30PV



	Part No.	Description	Color	Pkg. Qty.	Wt. Ea. (lbs.)	Product Class
PVC	4P1X	4" PVC Cross (HUB x HUB x HUB x HUB)	White	20	1.40	30PV
STYRENE	401X	4" Styrene Cross (HUB x HUB x HUB x HUB)	White	20	1.20	30ST

Corrugated Adapter

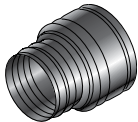

Part No.	Description	Color	Pkg. Qty.	Wt. Ea. (lbs.)	Product Class
351	3" Polyethylene Corrugated Adapter (CORR HUB x S&D SPT or HUB)	Black	50	0.10	30ST
451	4" Polyethylene Corrugated Adapter (CORR HUB x S&D SPT or HUB)	Black	25	0.20	30ST
651	6" Polyethylene Corrugated Adapter (HUB x S&D SPT)	Black	12	0.25	30ST

DWV to Sewer and Drain Adapter

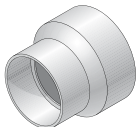

	Part No.	Description	Color	Pkg. Qty.	Wt. Ea. (lbs.)	Product Class
PVC	3P12	3" x 4" PVC DWV to Sewer and Drain Adapter (DWV HUB x S&D HUB)	White	50	0.50	30PV
	3P15	3" x 3" PVC DWV to Sewer and Drain Adapter (DWV HUB x S&D HUB)	White	60	0.41	30PV
	3P16	4" x 4" PVC DWV to Sewer and Drain Adapter (DWV HUB x S&D HUB)	White	30	0.80	30PV
	3P17	3" x 4" PVC DWV to Sewer and Drain Adapter (DWV HUB x S&D SPT)	White	30	0.50	30PV

DWV to Sewer & Drain Adapter Bushing



	Part No.	Description	Color	Pkg. Qty.	Wt. Ea. (lbs.)	Product Class
PVC	2P41	3" PVC DWV to S&D Adapter Bushing (DWV SPT x S&D HUB)	White	50	0.12	30PV
	2P42	4" PVC DWV to S&D Adapter Bushing (DWV SPT x S&D HUB)	White	25	0.24	30PV
	2P43	6" PVC DWV to S&D Adapter Bushing (DWV SPT x S&D HUB)	White	20	0.70	30PV

Reducer Bushing (SCH. 40 HUB x S&D SPT)



	Part No.	Description	Color	Pkg. Qty.	Wt. Ea. (lbs.)	Product Class
PVC	532	2" x 3" PVC Reducer Bushing (SCH. 40 HUB x S&D SPT)	White	20	0.20	30PV
	533	2" x 4" PVC Reducer Bushing (SCH. 40 HUB x S&D SPT)	White	20	0.35	30PV

Reducer Bushing (6-inch S&D SPT)



	Part No.	Description	Color	Pkg. Qty.	Wt. Ea. (lbs.)	Product Class
STYRENE	643	6" x 4" x 3" Styrene Reducer Bushing (6" S&D SPT)	Black	20	0.75	30ST

SOLVENT WELD SEWER & DRAIN FITTINGS - DOWNSPOUT ADAPTER

PVC for Standard Sewer & Drain Pipe

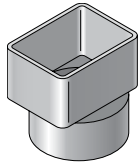

	Part No.	Description	Color	Pkg. Qty.	Wt. Ea. (lbs.)	Product Class
PVC	9P03	2" x 3" x 3" Offset Downspout Adapter (Fits 3" pipe)	White	40	0.42	30PV
	9P04	2" x 3" x 4" Offset Downspout Adapter (Fits 4" pipe)	White	30	0.53	30PV
	9P06	3" x 4" x 4" Downspout Adapter (Fits 4" pipe)	White	25	0.50	30PV
	9P10	4" x 6" x 6" Offset Downspout Adapter (Fits 6" pipe)	White	15	1.00	30PV
	9P13	3" x 4" x 4" Offset Downspout Adapter (Fits 4" pipe)	White	25	0.50	30PV
STYRENE	903	2" x 3" x 3" Offset Downspout Adapter (Fits 3" pipe)	White	40	0.33	30ST
	904	2" x 3" x 4" Offset Downspout Adapter (Fits 4" pipe)	White	30	0.40	30ST
	906	3" x 4" x 4" Downspout Adapter (Fits 4" pipe)	White	30	0.40	30ST

PVC for DWV or SCH. 40 Pipe

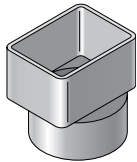

	Part No.	Description	Color	Pkg. Qty.	Wt. Ea. (lbs.)	Product Class
PVC	9P07	2" x 3" x 3" Downspout Adapter (Fits 3" pipe)	White	40	0.30	30PV
	9P08	2" x 3" x 4" Downspout Adapter (Fits 4" pipe)	White	30	1.10	30PV
	9P09	3" x 4" x 4" Downspout Adapter (Fits 4" pipe)	White	30	0.44	30PV

SOLVENT WELD FITTINGS - POOL ACCESSORIES

Drain Grate



	Part No.	Description	Color	Pkg. Qty.	Wt. Ea. (lbs.)	Product Class
PVC	9P12	3" PVC Drain Grate (S&D SPT)	White	50	0.16	30PV
	9P11	4" PVC Drain Grate (S&D SPT)	White	25	0.36	30PV
STYRENE	912	3" Styrene Drain Grate (S&D SPT)	White	50	0.12	30ST
	911	4" Styrene Drain Grate (S&D SPT)	White	25	0.24	30ST

Deck Drain



	Part No.	Description	Color	Pkg. Qty.	Wt. Ea. (lbs.)	Product Class
STYRENE	WC100	3" Styrene Deck Drain (3" S&D HUB)	White	50	0.16	30ST
	WC100G	3" Styrene Deck Drain (3" S&D HUB)	Gray	50	0.16	30ST
	WC100T	3" Styrene Deck Drain (3" S&D HUB)	Tan	50	0.16	30ST

Deck Drain Adapter



	Part No.	Description	Color	Pkg. Qty.	Wt. Ea. (lbs.)	Product Class
STYRENE	WC150	2" Styrene Deck Drain Adapter (2" SCH.40 HUB)	White	10	0.70	30ST

Pool Backflush Fitting

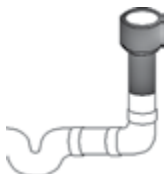

	Part No.	Description	Color	Pkg. Qty.	Wt. Ea. (lbs.)	Product Class
	650	4" Polyethylene Pool Backflush Fitting (Includes 4" grate)	Black	35	0.16	30ST

DIVERTER AND BACKWATER VALVES

Diverter Valve

Here's the simplest, strongest and most economical diverter valve ever invented for septic tank leach fields. It is made of tough molded plastic that will not shatter, bend, rust or corrode. It is lighter in weight, easier to handle and less expensive to ship.

Functional

The diverter valve stem flow may be controlled to individual or multiple fields (up to three) in any combination. With a three-way valve stem, flow may be diverted to any two outlets. To allow flow through all outlets, the valve stem may be removed from the assembly.

Easy to Install

Connect 4" plastic sewer and drain pipe to inlets and outlets on the four-way distribution box. (Unwanted outlets may be sealed by installing caps.) The diverter shield which houses the diverter stem may be cut to desired length.

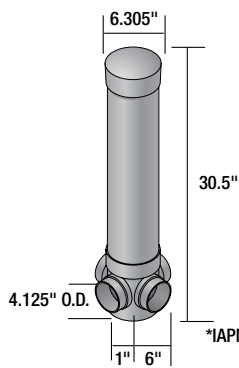

	Part No.	Description	Color	Pkg. Qty.	Wt. Ea. (lbs.)	Product Class
PVC	575P	4" PVC Diverter Valve	White	4	9.50	35PV
ABS*	575	4" ABS Diverter Valve	Black	4	7.50	35AB

*IAPMO Listed.

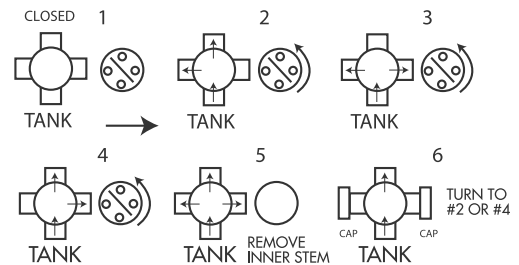

Gravity Backwater Valve

The NDS gravity flow Backwater Valve is designed to protect low areas or basements from the backflow of waste from street sewers. It is available in 2", 3", 4" and 6" sizes, PVC material. It is a cost-effective and a chemically resistant alternative to cast iron valves.

Backwater Valve

The quick action flapper allows unrestricted uni-directional flow. Elastomeric gasket in the flapper ensures a watertight seal. Flapper can be easily removed and replaced if required. Threaded access cap is designed for hand tightening. Access cap neoprene gasket provides a positive seal. Valve hub outlets fit 2", 3", 4" or 6" DWV pipe and may be adapted to 2", 3", 4" or 6" sewer and drain pipe with NDS DWV to Sewer & Drain Adapters. Lightweight, easy to install. Horizontal installation required, with arrows on top of the valve hub pointing in the direction of the flow of water. Access riser with cover offers a simple, economical access to the valve for inspection and maintenance. The riser may be cut to the desired length.

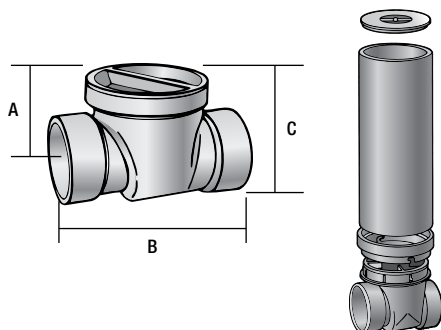

Item Number	A	B	C	Riser Height	Riser Diameter
275P, 275	2.18"	5.03"	3.53"	16"	4"
275PR	2.18"	5.03"	3.53"	16"	4"
375P, 375	3.51"	7.56"	6.10"	16"	6"
375PR, 375R	3.51"	7.56"	6.10"	16"	6"
475P, 475	4.47"	11.18"	7.18"	16"	8"
475PR, 475R	4.47"	11.18"	7.18"	16"	8"
675P, 675	5.50"	15.25"	9.90"	16"	10"

Approvals applicable to valve only.



DIVERTER AND BACKWATER VALVES

Backwater Valve

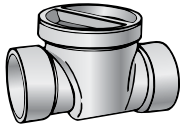

	Part No.	Description	Color	Pkg. Qty.	Wt. Ea. (lbs.)	Product Class
PVC	275P	2" PVC Backwater Valve	White	8	1.00	35PV
	275PR	2" PVC Backwater Valve with Riser and Cover	White	1	5.00	35PV
	375P	3" PVC Backwater Valve	White	6	2.33	35PV
	375PR	3" PVC Backwater Valve with Riser and Cover	White	1	5.00	35PV
	475P	4" PVC Backwater Valve	White	6	4.33	35PV
	475PR	4" PVC Backwater Valve with Riser and Cover	White	1	8.00	35PV
	675P	6" PVC Backwater Valve	White	1	9.00	35PV
ABS	275	2" ABS Backwater Valve	Black	8	1.00	35AB
	375	3" ABS Backwater Valve	Black	6	1.83	35AB
	375R	3" ABS Backwater Valve with Riser and Cover	Black	1	4.00	35AB
	475	4" ABS Backwater Valve	Black	6	3.33	35AB
	475R	4" ABS Backwater Valve with Riser and Cover	Black	1	7.00	35AB
	675	6" ABS Backwater Valve and Cover	Black	1	7.00	35AB

PVC Backwater Valve Components

FITTINGS

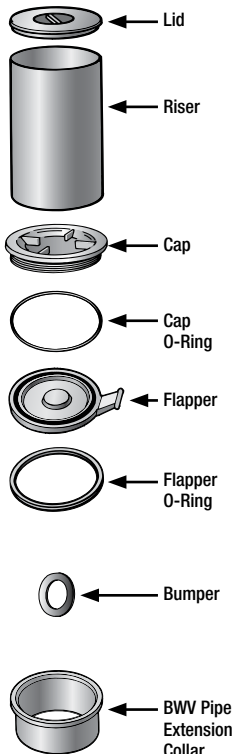

Part No.	Description	Color	Carton Qty.	Product Class
8051-020-040	2" Lid	White	20	80CS
822-040-16	2" Riser	White	4	80CS
1530202	2" Cap	White	10	80CS
880-237	2" Cap O-Ring	Black	10	80CS
1530203	2" Flapper	White	10	80CS
880-136	2" Flapper O-Ring	Black	10	80CS
1530204	2" Backwater Valve Pipe Extension Collar	White	10	80CS
8051-030-060	3" Lid	White	25	80CS
822-060-16	3" Riser	White	2	80CS
1530302	3" Cap	White	10	80CS
880-253	3" Cap O-Ring	Black	10	80CS
1530303	3" Flapper	White	10	80CS
880-234	3" Flapper O-Ring	Black	10	80CS
1530304	3" Backwater Valve Pipe Extension Collar	White	10	80CS
8051-040-080	4" Lid	White	20	80CS
822-080-16	4" Riser	White	1	80CS
1530402	4" Cap	White	10	80CS
880-364	4" Cap O-Ring	Black	10	80CS
1530403	4" Flapper	White	10	80CS
880-243	4" Flapper O-Ring	Black	10	80CS
1530404	4" Backwater Valve Pipe Extension Collar	White	10	80CS
8051-060-100	6" Lid	White	15	80CS
1530602	6" Cap	White	2	80CS
880-271	6" Cap O-Ring	Black	2	80CS
1530603	6" Flapper	White	5	80CS
880-259	6" Flapper O-Ring	Black	5	80CS
880-202	Bumper (fits all sizes of valves)	Black	1	80CS
1530405	4" BWV Sewer Adapt Flange	White	1	80CS
1530605	6" BWV Sewer Adapt Flange	White	1	80CS

Backwater Valve Box

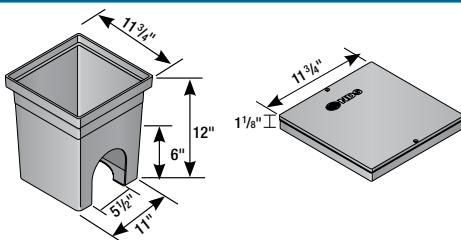

Part No.	Description	Color	Pkg. Qty.	Wt. Ea. (lbs.)	Product Class
1219	12" x 12" Backwater Valve Box	Black	4	5.75	10ND
1220	12" x 12" Valve Box Cover	Black	8	2.00	10ND

NDS FLEXIBLE COUPLINGS AND CONNECTORS

- Choose the high-quality couplings and connectors that easily adapt to any situation
- Innovative, flexible couplings for sewer, drain, waste and vent piping allow any two pipes to be connected quickly and easily
- Dimensional flexibility ensures leakproof seals with virtually any pipe material
- Utility and plumbing applications

Details

- Couplings and connectors fit over the ends of plain-end or spigot pipe to form a positive seal against infiltration and exfiltration in non-pressure environments
- Durable PVC construction allows couplings to flex with normal earth movement
- Completely unaffected by soil conditions and resistant to chemicals, UV rays and normal sewer gases

Materials and Standards

- Flexible couplings are made of elastomeric polyvinyl chloride (PVC) for long-lasting performance and durability
- Bactericides and fungicides are added to PVC for extra protection
- All NDS clamps, including the band and housing, are made from series 300 stainless steel, offering corrosion-resistant, rustproof reliability
- NDS Flexible Couplings have listings from the following code agencies: ICC (International Code Council), CSA (Canadian Standards Association) and IAPMO (International Association of Plumbing and Mechanical Officials)

Installation

- Clamps install easily with a screwdriver, 5/16" nut driver or socket to 60 inch-lbs. pounds torque
- All couplings are marked with size and pipe materials that the coupling will connect, eliminating guesswork on the job

NDS Flexible Coupling Sizing Chart

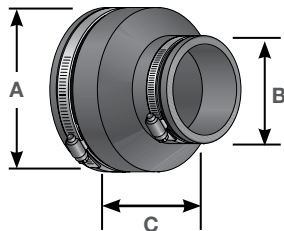

- All dimensions given in inches and mm.
- Couplings available to connect 1-1/4" to 15" pipe.
- 300 Series stainless steel clamps supplied with all couplings.
- All couplings will fit any pipe type within +/- 5% OD on chart.

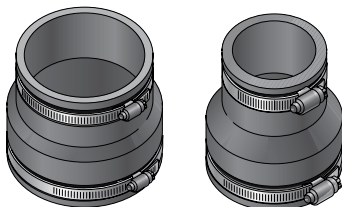

Clay to Clay

Part No.	A		B		C		Pkg. Qty.	Weight	Product Class
	Inches	mm	Inches	mm	Inches	mm			
01-44	5.25	133	5.25	133	4.00	101	18	1.27	45C0

Clay to Cast Iron or Plastic

Part No.	A		B		C		Pkg. Qty.	Weight	Product Class
	Inches	mm	Inches	mm	Inches	mm			
02-43	5.25	133	3.38	85	4.00	101	36	1.25	45C0
02-44	5.25	133	4.38	111	4.00	101	24	1.04	45C0
02-55	USE PART NO. 56-65								
02-64	7.38	187	4.38	111	6.00	152	12	2.50	45C0
02-66	7.38	187	6.38	162	6.00	152	18	2.38	45C0
02-88	9.65	245	8.50	215	6.00	152	6	3.16	45C0
02-1010	11.80	299	10.60	269	6.00	152	3	4.00	45C0
02-1212	14.38	365	12.60	320	6.00	152	5	5.20	45C0
02-1515	17.85	453	15.40	391	6.00	152	5	6.00	45C0

Concrete to Cast Iron or Plastic

Part No.	A		B		C		Pkg. Qty.	Weight	Product Class
	Inches	mm	Inches	mm	Inches	mm			
06-44	5.62	142	4.38	111	4.00	101	18	1.66	45C0
06-64	7.80	198	4.38	111	6.00	152	12	2.41	45C0
06-66	7.80	198	6.38	162	6.00	152	12	2.58	45C0
06-88	10.25	260	8.50	215	6.00	152	6	3.33	45C0

NDS FLEXIBLE COUPLINGS AND CONNECTORS

NDS Flexible Coupling Sizing Chart

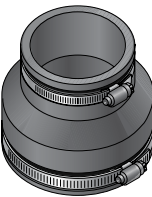
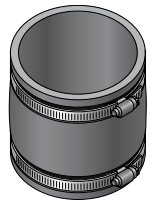
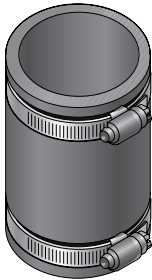

Asbestos Cement, Fibre or Ductile Iron to Cast Iron or Plastic

Part No.	A		B		C		Pkg. Qty.	Weight	Product Class
	Inches	mm	Inches	mm	Inches	mm			
51-44	4.75	120	4.38	111	4.00	101	24	1.08	45CO
51-66	7.00	177	6.38	162	6.00	152	15	2.73	45CO

Cast Iron, Plastic, Copper, Steel or Lead to Cast Iron, Plastic, Copper, Steel or Lead

Part No.	A		B		C		Pkg. Qty.	Weight	Product Class
	Inches	mm	Inches	mm	Inches	mm			
56-125	1.65	40	1.65	40	4.00	101	90	0.36	45CO
56-150/125	1.90	48	1.65	40	4.00	101	75	0.41	45CO
56-150	1.90	48	1.90	48	4.00	101	75	0.41	45CO
56-2150	2.40	60	1.90	48	4.00	101	54	0.51	45CO
56-22	2.40	60	2.40	60	4.00	101	54	0.50	45CO
56-32	3.38	85	2.40	60	4.00	101	45	0.71	45CO
56-33	3.38	85	3.38	85	4.00	101	45	0.75	45CO
56-42	4.38	111	2.40	60	4.00	101	30	0.93	45CO
56-E43	4.38	111	3.38	85	4.00	101	24	1.37	45CO
56-43	4.38	111	3.38	85	4.00	101	25	1.08	45CO
56-44	4.42	112	4.42	112	4.00	101	24	1.66	45CO
56-44W	4.42	112	4.42	112	4.00	101	24	1.17	45CO
56-55	5.62	142	5.62	142	4.00	101	18	1.38	45CO
56-63	6.38	162	3.38	85	6.00	152	12	1.67	45CO
56-E64	6.38	162	4.38	111	6.00	152	10	2.20	45CO
56-64	6.38	162	4.38	111	6.00	152	12	2.16	45CO
56-66	6.38	162	6.38	162	6.00	152	15	2.13	45CO
56-86	8.50	215	6.38	162	6.00	152	8	3.37	45CO
56-88	8.50	215	8.50	215	6.00	152	12	3.50	45CO
56-1010	10.60	269	10.60	269	7.00	178	2	6.00	45CO
56-1212	12.83	326	12.83	326	6.00	152	3	5.00	45CO

NDS FLEXIBLE COUPLING SIZING CHART

Drain and Trap Connectors

NDS Drain & Trap Connectors are ideal for new installation, alterations and repairs. These connectors offer a quick, low-cost alternative to gluing or soldering and eliminate the need for special tools or threading. Simply place the ends over the pipes and tighten the stainless steel clamps.

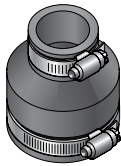

Part No.	Description	Color	Pkg. Qty.	Wt. Ea. (lbs.)	Product Class
57-125	1-1/4" or 1-1/2" Drain Piping x 1-1/4" or 1-1/2" Drain Piping	Black	180	0.17	45CO
57-125/125	1-1/4" DWV or 1-1/2" Copper x 1-1/4" or 1-1/2" Drain Piping	Black	140	0.22	45CO
57-150/125	1-1/2" DWV or 1-1/2" Copper x 1-1/4" or 1-1/2" Drain Piping	Black	120	0.25	45CO

Large Diameter Couplings

Large Diameter Couplings are available through NDS. The large couplings are engineered for use with all the common pipe material: clay, concrete, cast iron, plastic, fiberglass, ductile iron and asbestos/cement. When ordering please remember to provide the exact O.D. size in inches for both pipes. A difference of 6" between the two pipe O.D. sizes cannot be made. Please call for details 1-800-726-1994.

Expansion Joints

NDS Flexible Expansion Joints have a one-piece design which allows for the thermal contraction and expansion of drain, waste and vent. These couplings are maintenance free and rustproof. They are secured by series 300 stainless steel clamps. NDS expansion joints are made of tough elastomeric polyvinyl chloride (PVC). They are strong and resilient. Available in 2" and 3" sizes.

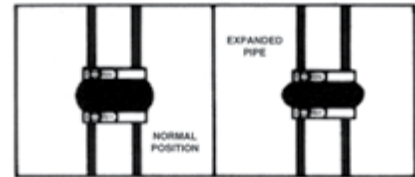

Part No.	Description	Color	Pkg. Qty.	Wt. Ea. (lbs.)	Product Class
XJ3	3" Expansion Joints	Black	24	0.67	45CO

Clamps for Flexible Couplings

CLAMP MIN. & MAX. DIAMETERS & OVERALL LENGTH							
Part No.	Max. Dia.	Min. Dia.	Length	Color	Weight	Pkg. Qty.	Product Class
33H020 CLAMP	1.75"	.75"	6-1/2"	Stainless Steel	0.05	500	45CO
33H032 CLAMP	2.50"	1.00"	8-3/4"	Stainless Steel	0.05	400	45CO
33H040 CLAMP	3.00"	2.06"	10-3/8"	Stainless Steel	0.05	400	45CO
33H056 CLAMP	4.00"	1.00"	13-1/2"	Stainless Steel	0.10	300	45CO
33H080 CLAMP	5.50"	2.57"	18-1/4"	Stainless Steel	0.10	200	45CO
33H088 CLAMP	6.00"	2.00"	19-3/4"	Stainless Steel	0.10	200	45CO
33H104 CLAMP	7.00"	2.00"	23"	Stainless Steel	0.10	100	45CO
33H116 CLAMP	7.75"	1.75"	25"	Stainless Steel	0.10	100	45CO
33H132 CLAMP	8.75"	6.75"	28-3/4"	Stainless Steel	0.15	100	45CO
33H152 CLAMP	10.00"	4.00"	32-3/8"	Stainless Steel	0.15	100	45CO
33H164 CLAMP	10.75"	1.75"	34-5/8"	Stainless Steel	0.15	100	45CO
33H188 CLAMP	12.25"	6.25"	39-1/2"	Stainless Steel	0.15	100	45CO
33H212 CLAMP	13.75"	11.75"	44"	Stainless Steel	0.20	100	45CO
33H250 CLAMP	12.62"	8.75"	40-1/2"	Stainless Steel	0.25	100	45CO
33S248 CLAMP	16"	3.625"	51-1/2"	Stainless Steel	0.25	100	45FS

NDS CONNECTORS AND O-RINGS

NDS Connectors for sewer pipe joints and drain waste & vent piping allow several points of seal between most types of sockets, hubs, bells and spigots. NDS Connectors are donut-shaped rings made of tough elastomeric polyvinyl chloride (PVC) and are available in a range of sizes up to 6". They install quickly and easily and offer the dimensional flexibility that ensures leakproof seals. They are also resistant to chemicals, fungus growth and normal sewer gases due to the inert nature and physical properties of the material. NDS O-Rings provide a quick and easy connection between most 4" house pipes and 6" sewer pipes. *NOTE: Connectors may not perform as intended due to improper or insufficient description of the pipes being connected or changes in pipe dimensions or design by the various manufacturers.*

SV Cast Iron Connectors



Part No.	Description	Color	Pkg. Qty.	Wt. Ea. (lbs.)	Product Class
44U-405	4" x 4" SV HUB x Sch40 (DWV) or Sch40 Steel or C.I.XH	Black	35	0.48	45C0

Asbestos Cement Connectors – John Manville and Capco



Part No.	Description	Color	Pkg. Qty.	Wt. Ea. (lbs.)	Product Class
44U-405	4" x 4" SW Duplex Adapter x C.I.XH or ABS/PVC DWV	Black	35	0.48	45C0

Cleanout or Test Caps

NDS Cleanout or Test Caps are designed to fit drain, waste and vent pipe materials. The 1-1/2" thru 4" NDS Caps are designed to fit schedule 40 nominal pipe sizes. The 6" thru 10" NDS Caps are designed to fit SDR 35 nominal pipe sizes. Our caps offer a quick and easy way to cap pipe ends and cleanouts. The reinforced convex face allows the cap to withstand greater pressure for testing and minimize ballooning. They are also low cost and reusable.

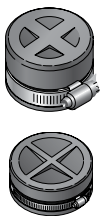

Part No.	Description	Color	Pkg. Qty.	Wt. Ea. (lbs.)	Product Calss	Product Class
150	1-1/2" Cap	Black	100	0.19	45CP	IAMPO Listed.
102	2" Cap	Black	100	0.21	45CP	
103	3" Cap	Black	50	0.90	45CP	
104	4" Cap	Black	50	0.44	45CP	
105	5" Cap	Black	24	0.87	45CP	
106	6" Cap	Black	24	0.95	45CP	
108	8" Cap	Black	16	1.81	45CP	

CORRUGATED FITTINGS

Coupling



Part No.	Description	Color	Pkg. Qty.	Product Class
3C05	3" Corrugated Coupling	Black	60	30PE
4C07	4" Corrugated Coupling	Black	36	30PE
6C05	6" Corrugated Coupling	Black	12	30PE

Endcap



Part No.	Description	Color	Pkg. Qty.	Product Class
3C06	3" Corrugated Endcap	Black	33	30PE
4C06	4" Corrugated Endcap	Black	32	30PE
6C06	6" Corrugated Endcap	Black	15	30PE

Downspout Adapter



Part No.	Description	Color	Pkg. Qty.	Product Class
234CDS	2" x 3" x 4" Corrugated Downspout Adapter	Black	24	30PE
344CDS	3" x 4" x 4" Corrugated Downspout Adapter	Black	24	30PE

CONCRETE MANHOLE COVER ADAPTERS

NDS Concrete Manhole Cover Adapters are made of elastomeric polyvinyl chloride (PVC) and are available for 4", 6", 8", 10", and 12" pipe. Our adapters help eliminate leaks around pipe entering manhole walls and are flexible enough to permit some lateral pipe movement without compromising the integrity of the seal. However, NDS does not warrant this product as a positive water seal due to the many varying factors that can influence the product's effectiveness as a positive seal, such as: field conditions, quality of grout, workmanship and high-ground water tables.

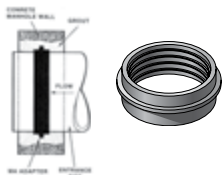

Part No.	Description	Color	Pkg. Qty.	Wt. Ea. (lbs.)	Product Class
4MA	4" Manhole Adapter	Black	24	1.00	45CO
6MA	6" Manhole Adapter	Black	24	0.62	45CO
8MA	8" Manhole Adapter	Black	14	1.00	45CO
12MA	12" Manhole Adapter	Black	6	1.50	45CO

NDS FLEXIBLE SADDLES

For superior durability and flexibility, saddle up. A breakthrough in saddle design, the patented NDS Flexible Saddle demonstrates superior flexibility in more than one way. The saddle's elastomeric construction allows a single description to securely fit 6" sewer main pipe diameters and up. The saddle's flexibility eliminates the need for a large inventory of rigid PVC saddles of various descriptions.

NDS Flexible Saddle offers the following product benefits:

- Two configurations, a "Tee" and a "Wye" are available in 4" or 6" inlet descriptions
- Elastomeric construction provides maximum strength and flexibility
- Saddle design will accommodate polyethylene pipe used in slip lining sewer systems
- Inlet range from SCH-40 down to SDR-35 includes standard weight soil pipe
- Stainless steel series 300 clamps ensure tight seal
- Steel-reinforced edges prevent distortion when torque is applied to clamps
- Durable design and low unit price make the Flexible Saddle economical and environmentally wise
- Available saddle blanket, attached to pipe prior to saddle installation, will mend imperfections and cracks on clay pipe taps

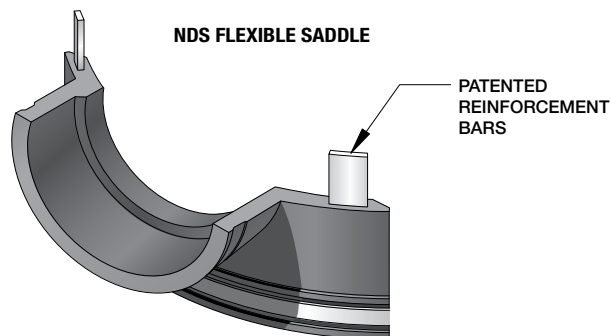

NDS Flexible Saddles

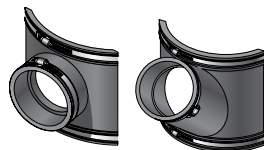

Part No.	Description	Color	Pkg. Qty.	Wt. Ea. (lbs.)	Product Class
4T/C	4" Tees with Clamps	Black	12	3.16	45FS
4T/WOC	4" Tees without Clamps	Black	12	2.66	45FS
4Y/C	4" Wyes with Clamps	Black	6	7.66	45FS
4Y/WOC	4" Wyes without Clamps	Black	6	7.12	45FS
6T/C	6" Tees with Clamps	Black	6	6.50	45FS
6Y/WOC	6" Flex Wye without Clamps	Black	4	11.75	45FS

FITTINGS

Saddle Clamps

Part No.	Description	Color	Pkg. Qty.	Wt. Ea. (lbs.)	Product Class
33S248 CLAMP	Clamp for Flexible Coupling	Stainless Steel	100	0.25	45FS

ASTM Material Specification

Test	NDS Material	ASTM Test Material
Chemical Resistance		
1N sulfuric acid	No weight loss	D543
1N hydrochloric acid	No weight loss	
Tensile Strength Elongation	1000 psi (7/Mpa) min. 200% min. elongation @ break	D412 Die "C"
Duration Hardness	Shore durometer 50 min. to 75 max.	D2240
Compression Set	30% max. of original deflection	D395, Method B Type 2
Water Absorption	5% max.	D471, immersed 7 days @158 Method A
Ozone Resistance	No visible cracking under 7x magnification	D1149, D518 Method A
Oven Aging	75% min. of original tensile strength 65% min. of original elongation	D573 (158°F for 70 hours)
Cold Brittleness	Cold brittleness was determined to be -43°C	D476
Tear Strength	125 lbs./in.	D624 Die "C"

WORM DRIVE HOSE CLAMPS



Superior Longevity – 100% stainless steel construction

Added strength – 4 piece design includes underside plate, Conical arched perforated slots

Smoother Worm Drive – Buttressed threads and more threads per screw

Primarily use to tighten around and secure pliable (soft) hose or tube

Plumbing: Connections for dishwashers, garbage disposals, water softeners, air conditioning

Irrigation: Secure poly tubing, stabilize risers to stake

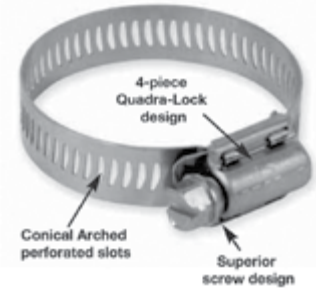

Part No.	Description	Pkg. Qty.	Case. Qty.	Product Class
3604	SAE 6, 5/16" Band Width, Effective Diameter Range: 7/16" Min., 25/32" Max.	10	200	45HC
3606	SAE 8, 5/16" Band Width, Effective Diameter Range: 1/2" Min., 29/32" Max.	10	200	45HC
64006H	SAE 6, 1/2" Band Width, Effective Diameter Range: 7/16" Min., 25/32" Max.	10	200	45HC
64008H	SAE 8, 1/2" Band Width, Effective Diameter Range: 1/2" Min., 29/32" Max.	10	200	45HC
64010H	SAE 10, 1/2" Band Width, Effective Diameter Range: 9/16" Min., 1-1/8" Max.	10	500	45HC
64012H	SAE 12, 1/2" Band Width, Effective Diameter Range: 11/16" Min., 1-1/4" Max.	10	500	45HC
64016H	SAE 16, 1/2" Band Width, Effective Diameter Range: 13/16" Min., 1-1/2" Max.	10	500	45HC
64020H	SAE 20, 1/2" Band Width, Effective Diameter Range: 13/16" Min., 1-3/4" Max.	10	500	45HC
64024H	SAE 24, 1/2" Band Width, Effective Diameter Range: 1-1/16" Min., 2" Max.	10	500	45HC
64028H	SAE 28, 1/2" Band Width, Effective Diameter Range: 1-5/16" Min., 2-1/4" Max.	10	500	45HC
64032H	SAE 32, 1/2" Band Width, Effective Diameter Range: 1-9/16" Min., 2-1/2" Max.	10	500	45HC
64036H	SAE 36, 1/2" Band Width, Effective Diameter Range: 1-13/16" Min., 2-3/4" Max.	10	500	45HC
64040H	SAE 40, 1/2" Band Width, Effective Diameter Range: 2-1/16" Min., 3" Max.	10	200	45HC
64044H	SAE 44, 1/2" Band Width, Effective Diameter Range: 2-5/16" Min., 3-1/4" Max.	10	200	45HC
64048H	SAE 48, 1/2" Band Width, Effective Diameter Range: 2-9/16" Min., 3-1/2" Max.	10	200	45HC
64052H	SAE 52, 1/2" Band Width, Effective Diameter Range: 2-13/16" Min., 3-3/4" Max.	10	200	45HC
64056H	SAE 56, 1/2" Band Width, Effective Diameter Range: 3-1/16" Min., 4" Max.	10	200	45HC
64064H	SAE 62, 1/2" Band Width, Effective Diameter Range: 3-9/16" Min., 4-1/2" Max.	10	200	45HC
64072H	SAE 72, 1/2" Band Width, Effective Diameter Range: 1-7/8" Min., 5" Max.	10	100	45HC
64080H	SAE 80, 1/2" Band Width, Effective Diameter Range: 2-1/2" Min., 5-1/2" Max.	10	100	45HC
64088H	SAE 88, 1/2" Band Width, Effective Diameter Range: 3-1/8" Min., 6" Max.	10	100	45HC
64096H	SAE 96, 1/2" Band Width, Effective Diameter Range: 3-5/8" Min., 6-1/2" Max.	10	100	45HC
64104H	SAE 104, 1/2" Band Width, Effective Diameter Range: 4-1/8" Min., 7" Max.	10	100	45HC
200 06 H	SAE 6, 9/16" Band Width, Effective Diameter Range: 7/16" Min., 25/32" Max.	10	200	45HC
200 08 H	SAE 8, 9/16" Band Width, Effective Diameter Range: 1/2" Min., 29/32" Max.	10	200	45HC
200 10 H	SAE 10, 9/16" Band Width, Effective Diameter Range: 9/16" Min., 1-1/8" Max.	10	500	45HC
200 12 H	SAE 12, 9/16" Band Width, Effective Diameter Range: 11/16" Min., 1-1/4" Max.	10	500	45HC
200 16 H	SAE 16, 9/16" Band Width, Effective Diameter Range: 13/16" Min., 1-1/2" Max.	10	500	45HC
200 20 H	SAE 20, 9/16" Band Width, Effective Diameter Range: 13/16" Min., 1-3/4" Max.	10	500	45HC
200 24 H	SAE 24, 9/16" Band Width, Effective Diameter Range: 1-1/16" Min., 2" Max.	10	500	45HC
200 28 H	SAE 28, 9/16" Band Width, Effective Diameter Range: 1-5/16" Min., 2-1/4" Max.	10	500	45HC
200 32 H	SAE 32, 9/16" Band Width, Effective Diameter Range: 1-9/16" Min., 2-1/2" Max.	10	500	45HC
200 36 H	SAE 36, 9/16" Band Width, Effective Diameter Range: 1-13/16" Min., 2-3/4" Max.	10	500	45HC
200 40 H	SAE 40, 9/16" Band Width, Effective Diameter Range: 2-1/16" Min., 3" Max.	10	200	45HC
200 44 H	SAE 44, 9/16" Band Width, Effective Diameter Range: 2-5/16" Min., 3-1/4" Max.	10	200	45HC
200 48 H	SAE 48, 9/16" Band Width, Effective Diameter Range: 2-9/16" Min., 3-1/2" Max.	10	200	45HC
200 52 H	SAE 52, 9/16" Band Width, Effective Diameter Range: 2-13/16" Min., 3-3/4" Max.	10	200	45HC
200 56 H	SAE 56, 9/16" Band Width, Effective Diameter Range: 3-1/16" Min., 4" Max.	10	200	45HC
200 64 H	SAE 62, 9/16" Band Width, Effective Diameter Range: 3-9/16" Min., 4-1/2" Max.	10	200	45HC
200 72 H	SAE 72, 9/16" Band Width, Effective Diameter Range: 1-7/8" Min., 5" Max.	10	100	45HC
200 80 H	SAE 80, 9/16" Band Width, Effective Diameter Range: 2-1/2" Min., 5-1/2" Max.	10	100	45HC
200 88 H	SAE 88, 9/16" Band Width, Effective Diameter Range: 3-1/8" Min., 6" Max.	10	100	45HC
200 96 H	SAE 96, 9/16" Band Width, Effective Diameter Range: 3-5/8" Min., 6-1/2" Max.	10	100	45HC
200 104 H	SAE 104, 9/16" Band Width, Effective Diameter Range: 4-1/8" Min., 7" Max.	10	100	45HC
200 128 H	SAE 128, 9/16" Band Width, Effective Diameter Range: 5-5/8" Min., 8-1/2" Max.	10	100	45HC
200 152 H	SAE 152, 9/16" Band Width, Effective Diameter Range: 7-1/8" Min., 10" Max.	10	100	45HC
200 188 H	SAE 188, 9/16" Band Width, Effective Diameter Range: 9-3/8" Min., 12-1/4" Max.	10	100	45HC
200 212 H	SAE 212, 9/16" Band Width, Effective Diameter Range: 10-7/8" Min., 13-3/4" Max.	10	100	45HC

FITTINGS

Our products are engineered and produced for performance, durability, ease of installation and the efficient use of resources.

