

A large, faint watermark of the company logo is centered in the background. It features a circular border with the word "CHICAGO" at the top and "Since 1912" at the bottom. In the center is a stylized anchor.

# Chicago Hardware and Fixture Company

Look For

Made in USA



Quality

# Catalog

# CHICAGO HARDWARE & FIXTURE COMPANY

Manufacturers of Wire Rope and Chain Fittings, Industrial and Marine Hardware and Allied Products



Sales offices and warehouse stocks are maintained in the principal cities to enable Distributors to promptly service your requirements for The Chicago Line, whether they are stock products or products manufactured to your specifications.

- Franklin Park, IL
- Atlanta, GA (Tucker)
- Chino, CA
- Houston, TX

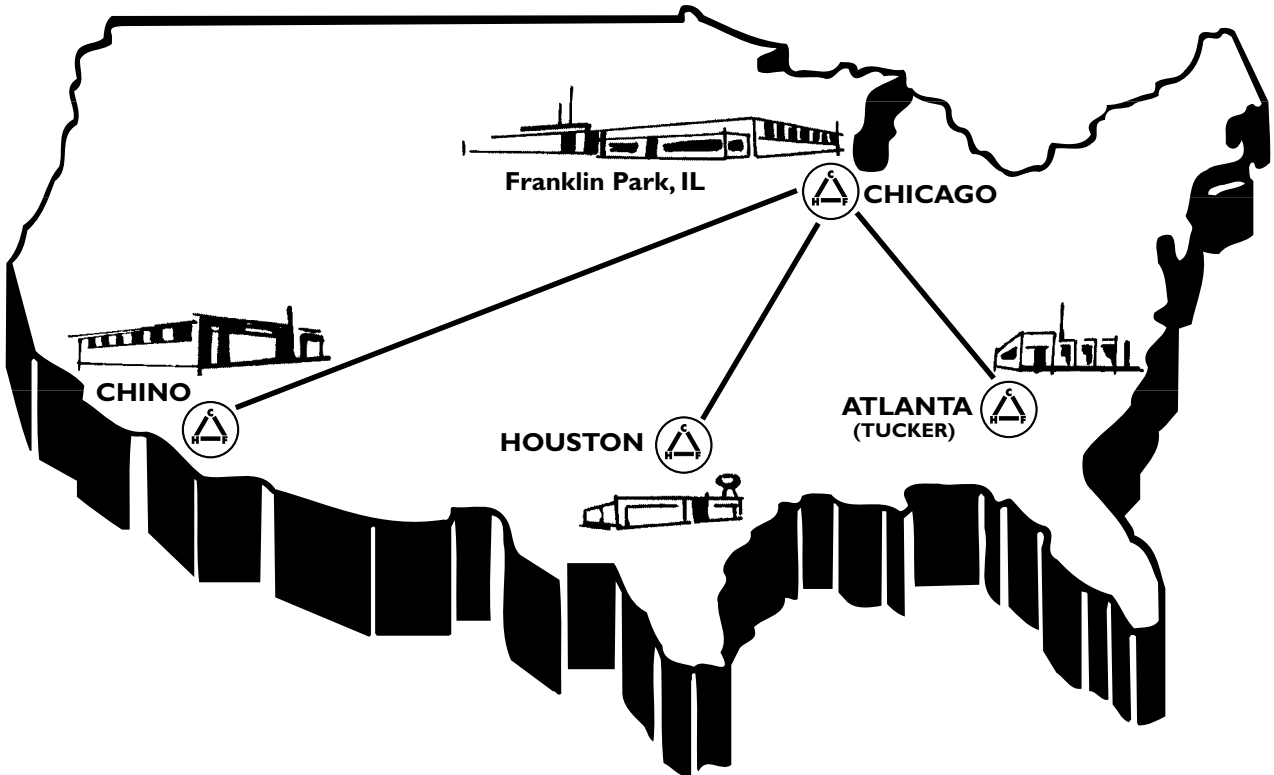

**NOTE:** "N.A." denoted in this catalog indicates particular size and or type of product is *Not Available*.

## HOW TO REACH US



### Chicago Hardware and Fixture Company

9100 Parklane Avenue  
Franklin Park, Illinois 60131

Phone: (847) 455-6609

Fax: (847) 455-0012

Email: [info@chicagohardware.com](mailto:info@chicagohardware.com)

INTERNET BUSINESS CENTER ADDRESS:  
[www.chicagohardware.com](http://www.chicagohardware.com)

MEMBER

 **National Fastener  
Distributors Association**



# TABLE OF CONTENTS

Drop Forged Turnbuckles	Drop Forged Blank Rod Ends . . . . .	29
Body Only / Body & Stubs . . . . .	Clevis Pins – Heat Treated & SAE . . . . .	28, 30
Eye & Eye / Hook & Hook . . . . .	Drop Forged Yoke Ends . . . . .	30
Hook & Eye . . . . .	Malleable Bevel Washers / Zinc Plated S-hooks . . . . .	31
Jaw & Eye / Jaw & Jaw / Rod End Eye & Eye . . . . .	Round Bend U-bolts	
Midget . . . . .	Zinc Plated . . . . .	32
Drop Forged Shackles	Hot Galvanized . . . . .	33
Anchor – Round Pin, Screw Pin, Safety . . . . .	Aluminium . . . . .	34
Chain – Round Pin, Screw Pin, Safety . . . . .	Long Tangent – Zinc Plated & Hot Galvanized . . . . .	35
Wire Rope Clips	Square Bend U-Bolts – Zinc Plated/Hot Galvanized . . . . .	36
Malleable . . . . .	Zinc Plated Turned Eye Bolts	
Drop Forged . . . . .	Machine Thread . . . . .	37
Wire Rope Thimbles . . . . .	Lag Threads / Welded – Machine Threads . . . . .	38
Drop Forged Eye Bolts	Continuous Threaded Rod	
Regular – Machine Thread . . . . .	Steel-Oil Finish . . . . .	39
Shoulder – Machine Thread / Regular &	Zinc Plated Steel . . . . .	40
Shoulder – Screw Thread . . . . .	Brass / 304 Stainless Steel . . . . .	41
Drop Forged Ring Bolts	Hot Galvanized / B7-Alloy / Coupling Nuts . . . . .	42
Regular & Shoulder – Machine Thread . . . . .	Zinc Plated Steel “Shapes”	
Regular & Shoulder – Screw Thread . . . . .	Square Key / Slotted Angles / Slotted Flats . . . . .	43
Machinery Eye Bolts	Rounds / Flats / Angles . . . . .	44
Standard Shank Lengths – Specifications . . . . .	Brass – Rounds, Flats & Angles . . . . .	45
Standard Shank Lengths – Plain & Shoulder . . . . .	Steel Center Display – Full-Size . . . . .	46
Zinc Plated / Hot Galvanized – Plain & Shoulder . . . . .	Stainless Steel Section	
Special Shank Lengths – Plain & Shoulder . . . . .	Thimbles / Eye Bolts / Wire Rope Clips . . . . .	47
Metric . . . . .	Machinery Eye Bolts / Regular Drop Forged	
Drop Forged Lifting Eyes . . . . .	Eye Nuts / Drop Forged Blank Rod Ends . . . . .	48
Alloy Steel Hoist Rings . . . . .	Turned Eye Bolts – Machine / S-Hooks . . . . .	49
Drop Forged Hooks	Round Bend U-Bolts . . . . .	50
Safety, Eye, Latch Kits . . . . .	Round Bend U-Bolts Long Tangent /	
High-Test Chain / Safety Snap . . . . .	Square Bend U-Bolts . . . . .	51
Drop Forged Swivels . . . . .	Formed or Forged Fittings Schematics . . . . .	52
Drop Forged Pad Eyes / Drop Forged Eye Nuts . . . . .	Index . . . . .	53
Drop Forged Heavy Duty Eye Nuts . . . . .		

REVISED 01/03





# DROP FORGED TURNBUCKLES

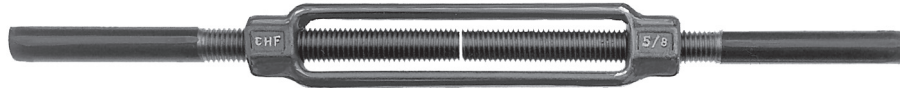

(Class C)



(Class B)



(Class B)

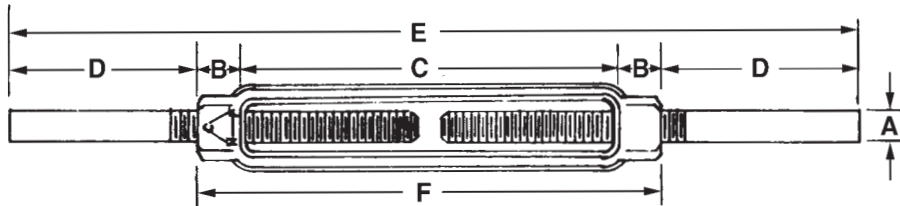

Turnbuckles Meet Performance Requirements of ASTM Specification F1145-92 Type 1 Grade 1 (Supercedes FF-T-791B)

Diameter & Take-up Dimensions A x C	Body Only						Body and Stubs					Working Load Limit in Lbs.
	Drilled & Tapped		Overall Length (F)	Weight per 100 D&T	Blanks		SC Part No.	Dimensions - Inches			Weight per 100	
	SC Part No.	Galv. Part No.			SC Part No.	Galv. Part No.		B	D	E		
1/4" x 4"	03805 8	03955 0	4-13/16"	14	00105 2	00255 4	04105 8	13/32"	2-5/8"	10"	25	500
5/16" x 4-1/2"	03810 2	03960 4	5-9/16"	21.5	00110 6	00260 8	04110 2	1-7/32"	2-25/32"	11"	42.5	800
3/8" x 6"	03815 7	03965 9	7-1/8"	37.5	00115 1	00265 3	04115 7	9/16"	4-7/16"	16"	85	1200
1/2" x 2"	03820 1	03970 3	3-1/2"	34	00120 5	00270 7	04120 1	3/4"	3-1/4"	10-1/4"	84	2200
1/2" x 6"	03823 2	03973 4	7-1/2"	66	00123 6	00273 8	04123 2	3/4"	4-1/4"	16"	142.5	2200
1/2" x 9"	03826 3	03976 5	10-1/2"	84.5	00126 7	00276 9	04126 3	3/4"	4-1/4"	19"	170	2200
1/2" x 12"	03829 4	03979 6	13-1/2"	102	00129 8	00279 0	04129 4	3/4"	4-1/4"	22"	200	2200
5/8" x 6"	03834 8	03984 0	7-7/8"	90.5	00134 2	00284 4	04134 8	15/16"	4-1/16"	16"	212.5	3500
5/8" x 9"	03837 9	03987 1	10-7/8"	131	00137 3	00287 5	04137 9	15/16"	4-1/16"	19"	285	3500
5/8" x 12"	03840 9	03990 1	13-7/8"	172.5	00140 3	00290 5	04140 9	15/16"	4-1/16"	22"	317.5	3500
5/8" x 18"	03843 0	03993 2	20-1/4"	345	00143 4	00293 6	04143 0	15/16"	4-1/16"	28"	577.5	3500
3/4" x 6"	03848 5	03998 7	8-1/4"	129	00148 9	00298 1	04148 5	1-1/8"	4-3/8"	17"	320	5200
3/4" x 9"	03851 5	04001 3	11-1/4"	191	00151 9	00301 8	04151 5	1-1/8"	4-3/8"	20"	412.5	5200
3/4" x 12"	03854 6	04004 4	14-1/4"	243	00154 0	00304 9	04154 6	1-1/8"	4-3/8"	23"	497.5	5200
3/4" x 18"	03857 7	04007 5	20-1/4"	336.5	00157 1	00307 0	04157 7	1-1/8"	4-3/8"	29"	677.5	5200
7/8" x 6"	03862 1	04012 9	8-5/8"	196	00162 5	00312 4	04162 1	1-5/16"	4-11/16"	18"	467.5	7200
7/8" x 12"	03865 2	04015 0	14-5/8"	309.5	00165 6	00315 5	04165 2	1-5/16"	4-11/16"	24"	661	7200
7/8" x 18"	03868 3	04018 1	20-5/8"	583.5	00168 7	00318 6	04168 3	1-5/16"	4-11/16"	30"	1039	7200
1" x 6"	03873 7	04023 5	9"	279	00173 1	00323 0	04173 7	1-1/2"	5"	19"	610	9800
1" x 12"	03876 8	04026 6	15"	383	00176 2	00326 1	04176 8	1-1/2"	5"	25"	920	9800
1" x 18"	03879 9	04029 7	21"	566	00179 3	00329 2	04179 9	1-1/2"	5"	31"	1176.5	9800
1-1/8" x 6"	03884 3	04034 1	9"	228	00184 7	00334 6	04184 3	1-11/16"	4-5/8"	19"	693	11500
1-1/8" x 12"	03887 4	04037 2	15"	467.5	00187 8	00337 7	04187 4	1-11/16"	4-5/8"	25"	1017.5	11500
1-1/4" x 6"	03892 8	04042 6	9-3/4"	449	00192 2	00342 1	04192 8	1-7/8"	5-1/8"	20"	1093	14800
1-3/8" x 6"	03897 3	04047 1	9-3/4"	430	00197 7	00347 6	04197 3	2-3/16"	5-1/2"	20-1/2"	1195	17500
1-1/2" x 6"	03902 4	04052 5	10-3/8"	684	00202 8	00352 0	04202 4	2-3/16"	5-1/2"	20-1/2"	1580	21000

Maximum load ratings are based on a straight vertical lift in a gradually increasing manner. Any deviations as angular lifts, shock loads, modification of the basic part, etc., will result in drastically reduced maximum loads.



# DROP FORGED TURNBUCKLES



Turnbuckles Meet Performance Requirements of ASTM Specification F1145-92 Type 1 Grade 1  
(Supersedes FF-T-791B)

Available with hot galvanized or self-colored finish.



Diameter & Take-up	Eye and Eye			Hook and Hook			Weight per 100 in Lbs.
	Part No.		Closed Length	Part No.		Closed Length	
	SC	Galv.		SC	Galv.		
1/4" x 4"	01105 1	01255 3	8"	02005 3	02155 5	8-1/2"	35
5/16" x 4-1/2"	01110 5	01260 7	9"	02010 7	02160 9	9-1/2"	47.5
3/8" x 6"	01115 0	01265 2	11-1/2"	02015 2	02165 4	12"	90.6
1/2" x 2"	01120 4	01270 6	8-1/2"	02020 6	02170 8	10"	111
1/2" x 6"	01123 5	01273 7	13"	02023 7	02173 9	14-1/4"	170
1/2" x 9"	01126 6	01276 8	16"	02026 8	02176 0	17-1/4"	202
1/2" x 12"	01129 7	01279 9	19"	02029 9	02179 1	20-1/4"	232.5
5/8" x 6"	01134 1	01284 3	13-1/2"	02034 3	02184 5	14-3/4"	260
5/8" x 9"	01137 2	01287 4	17"	02037 4	02187 6	17-3/4"	320
5/8" x 12"	01140 2	01290 4	20-1/2"	02040 4	02190 6	20-3/4"	392.5
5/8" x 18"	01143 3	01293 5	26-1/2"	02043 5	02193 7	26-3/4"	557
3/4" x 6"	01148 8	01298 0	14-3/4"	02048 0	02198 2	16-3/4"	397.5
3/4" x 9"	01151 8	01301 7	18"	02051 0	02201 9	19-3/4"	512.5
3/4" x 12"	01154 9	01304 8	21-3/4"	02054 1	02204 0	22-3/4"	581
3/4" x 18"	01157 0	01307 9	27-3/4"	02057 2	02207 1	28-3/4"	666
7/8" x 6"	01162 4	01312 3	18"	02062 6	02212 5	19"	650
7/8" x 12"	01165 5	01315 4	22-1/2"	02065 7	02215 6	23-3/4"	787.5
7/8" x 18"	01168 6	01318 5	28-1/2"	02068 8	02218 7	29-3/4"	1212
1" x 6"	01173 0	01323 9	17"	02073 2	02223 1	20"	805
1" x 12"	01176 1	01326 0	25"	02076 3	02226 2	25-1/2"	1077.5
1" x 18"	01179 2	01329 1	31"	02079 4	02229 3	31-1/2"	1386

(Class D)

To ascertain extended length add amount of take-up to length in closed position.

(Class E)

Eye, Jaw and Hook fittings are heat treated.

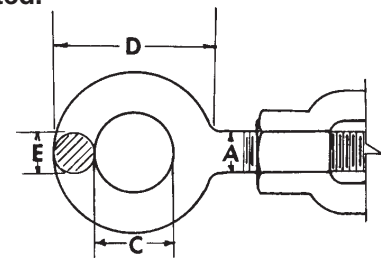
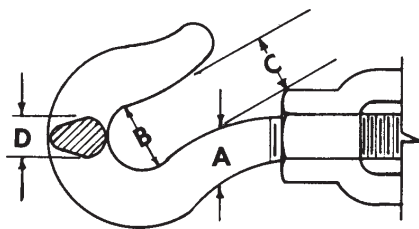

## Hook

Dimensions – Inches				Working Load Limit in Lbs.†
A	B	C	D	
1/4"	5/16"	9/32"	7/32"	400
5/16"	1/2"	1/2"	5/16"	700
3/8"	1/2"	1/2"	3/8"	1,000
1/2"	7/8"	13/16"	17/32"	1,500
5/8"	29/32"	27/32"	5/8"	2,250
3/4"	1-1/8"	29/32"	11/16"	3,000
7/8"	1-3/16"	1-1/16"	13/16"	3,200
1"	1-3/8"	1-1/4"	7/8"	5,000

## EYE

Dimensions – Inches				Working Load Limit in Lbs.†
A	C	D	E	
1/4"	1/2"	1"	7/32"	500
5/16"	5/8"	1-1/4"	9/32"	800
3/8"	3/4"	1-1/2"	11/32"	1,200
1/2"	1"	2"	7/16"	2,200
5/8"	1-1/4"	2-5/16"	17/32"	3,500
3/4"	1-1/2"	2-3/4"	5/8"	5,200
7/8"	1-3/4"	3-1/2"	7/8"	7,200
1"	2"	3-3/4"	7/8"	10,000

† Loads are based on a safety factor of 5 to 1. Maximum load ratings are based on a straight vertical lift in a gradually increasing manner. Any deviations as angular lifts, shock loads, modification of the basic part, etc., will result in drastically reduced maximum loads.



# DROP FORGED TURNBUCKLES

Turnbuckles Meet Performance Requirements of ASTM Specification F1145-92 Type 1 Grade 1 (Supercedes FF-T-791B)



(Class F)

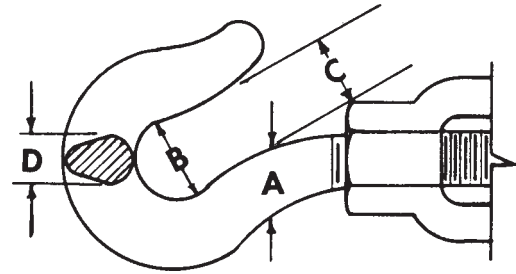

## HOOK DIMENSIONS - STRENGTH

Dimensions - Inches				Working Load Limit in Lbs. †
A	B	C	D	
1/4"	5/16"	9/32"	7/32"	400
5/16"	1/2"	1/2"	5/16"	700
3/8"	1/2"	1/2"	3/8"	1,000
1/2"	7/8"	13/16"	17/32"	1,500
5/8"	29/32"	27/32"	5/8"	2,250
3/4"	1-1/8"	29/32"	11/16"	3,000
7/8"	1-3/16"	1-1/16"	13/16"	3,200
1"	1-3/8"	1-1/4"	7/8"	5,000

† Loads are based on a safety factor of 5 to 1.

Available with hot galvanized or self-colored finish.  
Eye, Jaw and Hook fittings are heat treated.

Diameter & Take-up	Hook and Eye		Closed Length	Weight per 100 in Lbs.
	Part No.			
	SC	Galv.		
1/4" x 4"	01555 4	01705 3	8-1/4"	35
5/16" x 4-1/2"	01560 8	01710 7	9-1/4"	47.5
3/8" x 6"	01565 3	01715 2	11-3/4"	90.6
1/2" x 2"	01570 7	01720 6	9-1/4"	109
1/2" x 6"	01573 8	01723 7	13-5/8"	170
1/2" x 9"	01576 9	01726 8	16-3/8"	202
1/2" x 12"	01579 0	01729 9	19-5/8"	232.5
5/8" x 6"	01584 4	01734 3	14-1/8"	260
5/8" x 9"	01587 5	01737 4	17-3/8"	320
5/8" x 12"	01590 5	01740 4	20-5/8"	392.5
5/8" x 18"	01593 6	01743 5	26-5/8"	557
3/4" x 6"	01598 1	01748 0	15-3/4"	397.5
3/4" x 9"	01601 8	01751 0	18-7/8"	512.5
3/4" x 12"	01604 9	01754 1	22-1/8"	581
3/4" x 18"	01607 0	01757 2	28-1/8"	666
7/8" x 6"	01612 4	01762 6	18-1/2"	650
7/8" x 12"	01615 5	01765 7	23-1/8"	787.5
7/8" x 18"	01618 6	01768 8	29-1/8"	1212
1" x 6"	01623 0	01773 2	19-1/2"	805
1" x 12"	01626 1	01776 3	25-1/4"	1077.5
1" x 18"	01629 2	01779 4	31-1/4"	1386

To ascertain extended length add amount of take-up to length in closed position.

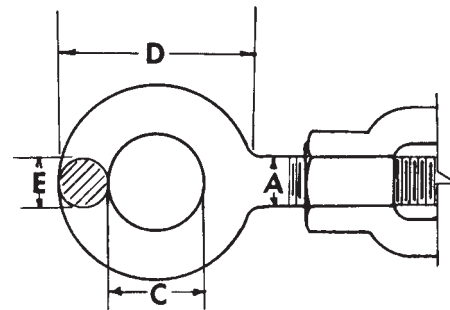

## EYE DIMENSIONS - STRENGTH

Dimensions - Inches				Working Load Limit in Lbs. †
A	C	D	E	
1/4"	1/2"	1"	7/32"	500
5/16"	5/8"	1-1/4"	9/32"	800
3/8"	3/4"	1-1/2"	11/32"	1,200
1/2"	1"	2"	7/16"	2,200
5/8"	1-1/4"	2-5/16"	17/32"	3,500
3/4"	1-1/2"	2-3/4"	5/8"	5,200
7/8"	1-3/4"	3-1/2"	7/8"	7,200
1"	2"	3-3/4"	7/8"	10,000

† Loads are based on a safety factor of 5 to 1.

Maximum load ratings are based on a straight vertical lift in a gradually increasing manner. Any deviations as angular lifts, shock loads, modification of the basic part, etc., will result in drastically reduced maximum loads.

# DROP FORGED TURNBUCKLES



Turnbuckles Meet Performance Requirements of ASTM Specification F1145-92 Type 1 Grade 1  
(Supercedes FF-T-791B)

Eye, Jaw and Hook fittings are heat treated.



Diameter & Take-up	Jaw and Eye Hot Galvanized			Jaw and Jaw Hot Galvanized		
	Part No.	Closed Length	Weight per 100	Part No.	Closed Length	Weight per 100
1/4" x 4"	02605 5	8-1/4"	37.5	03055 7	8-1/2"	40
5/16" x 4-1/2"	02610 9	9-1/8"	52.5	03060 1	9-1/4"	52.5
3/8" x 6"	02615 4	11-1/2"	96.5	03065 6	11-1/2"	97.5
1/2" x 2"	02620 8	8-3/4"	109	03070 0	8-7/8"	119
1/2" x 6"	02623 9	13-1/4"	160	03073 1	13-1/2"	170
1/2" x 9"	02626 0	16-1/4"	198.5	03076 2	16-1/2"	202.5
1/2" x 12"	02629 1	19-1/4"	225	03079 3	19-1/2"	227.5
5/8" x 6"	02634 5	14-5/8"	257.5	03084 7	15-3/4"	260.5
5/8" x 9"	02637 6	17-7/8"	330	03087 8	18-3/4"	330
5/8" x 12"	02640 6	21-1/8"	402	03090 8	21-3/4"	407
5/8" x 18"	02643 7	27-1/8"	581	03093 9	27-3/4"	607
3/4" x 6"	02648 2	15-5/8"	402.5	03098 4	16-1/2"	417.5
3/4" x 9"	02651 2	18-3/4"	522.5	03101 1	19-1/2"	545
3/4" x 12"	02654 3	22"	602.5	03104 2	22-1/2"	619.5
3/4" x 18"	02657 4	28"	702	03107 3	28-1/2"	753
7/8" x 6"	02662 8	19"	655	03112 7	19-1/2"	668
7/8" x 12"	02665 9	23-1/2"	842.5	03115 8	24-1/2"	862.5
7/8" x 18"	02668 0	29-1/2"	1252	03118 9	30-1/2"	1281
1" x 6"	02673 4	19-1/8"	872	03123 3	21-3/16"	911
1" x 12"	02676 5	25-1/4"	1137.5	03126 4	25-1/2"	1165
1" x 18"	02679 6	31-1/4"	1463	03129 5	31-1/2"	1518



(Class H)



(Class G)

Available with hot galvanized or self-colored finish. Jaw types supplied with round pins and cotter keys unless nuts and bolts are specified. Locking nuts are also available.

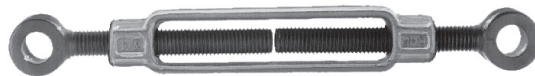

Diameter & Take-up	Rod End Eye & Eye Self-Colored		
	Part No.	Closed Length	Weight per 100
1/2" x 6"	03373 2	13"	131
5/8" x 6"	03384 8	13-1/4"	205
3/4" x 6"	03398 5	13-1/2"	293
7/8" x 6"	03412 8	14"	456
1" x 6"	03423 4	14-1/8"	589

## JAW DIMENSIONS - STRENGTH

Dimensions - Inches								Working Load Limit in Lbs.†
A	B	C	D	*E	F	**H	P	
1/4"	7/32"	5/16"	25/32"	3/8"	5/8"	9/32"	1/4"	500
5/16"	1/4"	5/16"	7/8"	15/32"	5/8"	9/32"	1/4"	800
3/8"	9/32"	13/32"	1"	1/2"	13/16"	11/32"	5/16"	1,200
1/2"	5/16"	1/2"	1-9/32"	5/8"	1"	15/32"	7/16"	2,200
5/8"	3/8"	21/32"	1-21/32"	7/8"	1-5/16"	35/64"	1/2"	3,500
3/4"	1/2"	13/16"	1-27/32"	15/16"	1-5/8"	43/64"	5/8"	5,200
7/8"	9/16"	29/32"	1-31/32"	1-5/32"	1-7/8"	25/32"	3/4"	7,200
1"	11/16"	1-1/16"	2-13/32"	1-3/16"	2"	15/16"	7/8"	10,000

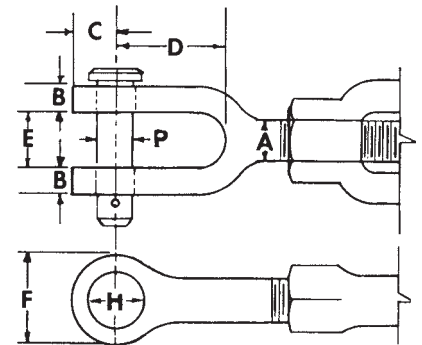

\* At parting line: includes 7° draft.

\*\* Hole size.

† Loads are based on a safety factor of 5 to 1.



# MIDGET TURNBUCKLES

All sizes and types available with sand cast Aluminum bodies, hex heads and zinc plated steel hooks or eyes. Cast malleable iron bodies, zinc plated also available with zinc plated fittings only in sizes denoted. Standard package quantity – 10 pieces. When ordering specify Aluminum or Malleable iron.

## EYE & EYE

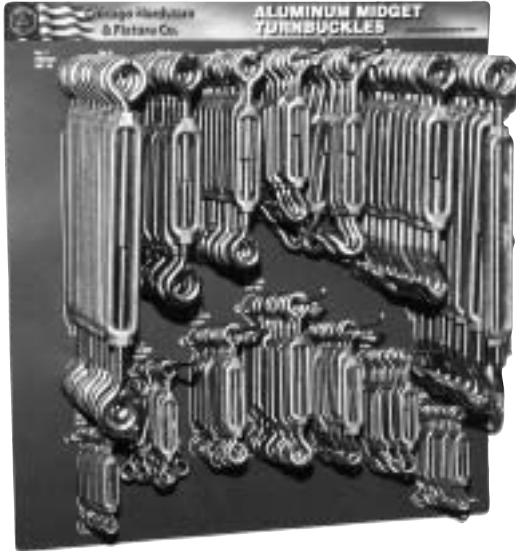

Thread Diameter	Stock No.	Dimensions – Inches Overall Length		Aluminum		Malleable	
		Closed	Open	Part No.	Weight Per 100	Part No.	Weight Per 100
8 - 32	1	3-3/8"	4-5/8"	05105 7	4	05128 6	N.A.
10 - 24	2	4"	5-5/8"	05108 8	6	05131 6	N.A.
12 - 24	3	4-1/2"	6-3/8"	05111 8	8	05134 7	N.A.
1/4" - 20	4	5-1/2"	7-5/8"	05114 9	13	05137 8	13
5/16" - 18	5	6-3/4"	9-1/4"	05117 0	22	05140 8	22
3/8" - 16	6	7-1/2"	10-1/2"	05120 0	38	05143 9	40
3/8" - 16	7	11-3/8"	17-3/8"	05123 1	54	05146 0	N.A.

## HOOK & EYE



Thread Diameter	Stock No.	Dimensions – Inches Overall Length		Aluminum		Malleable	
		Closed	Open	Part No.	Weight Per 100	Part No.	Weight Per 100
8 - 32	11	3-3/8"	4-5/8"	05205 4	4	05228 3	N.A.
10 - 24	12	4"	5-5/8"	05208 5	6	05231 3	N.A.
12 - 24	13	4-1/2"	6-3/8"	05211 5	8	05234 4	N.A.
1/4" - 20	14	5-1/2"	7-5/8"	05214 6	13	05237 5	13
5/16" - 18	15	6-3/4"	9-1/4"	05217 7	22	05240 5	22
3/8" - 16	16	7-1/2"	10-1/2"	05220 7	38	05243 6	40
3/8" - 16	17	11-3/8"	17-3/8"	05223 8	54	05246 7	N.A.

## HOOK & HOOK



Thread Diameter	Stock No.	Dimensions – Inches Overall Length		Aluminum		Malleable	
		Closed	Open	Part No.	Weight Per 100	Part No.	Weight Per 100
8 - 32	21	3-3/8"	4-5/8"	05305 1	4	05328 0	N.A.
10 - 24	22	4"	5-5/8"	05308 2	6	05331 0	N.A.
12 - 24	23	4-1/2"	6-3/8"	05311 2	8	05334 1	N.A.
1/4" - 20	24	5-1/2"	7-5/8"	05314 3	13	05337 2	13
5/16" - 18	25	6-3/4"	9-1/4"	05317 4	22	05340 2	22
3/8" - 16	26	7-1/2"	10-1/2"	05320 4	38	05343 3	40
3/8" - 16	27	11-3/8"	17-3/8"	05323 5	54	05346 4	N.A.

TURNBUCKLE DISPLAY ALUMINUM ONLY PART # 60010 1			
Qty.	Stock No.	Type	Thread Diameter
10	1	Eye & Eye	8 - 32
10	2	Eye & Eye	10 - 24
10	3	Eye & Eye	12 - 24
10	4	Eye & Eye	1/4" - 20
10	5	Eye & Eye	5/16" - 18
10	6	Eye & Eye	3/8" - 16
10	7	Eye & Eye	3/8" - 16
10	11	Hook & Eye	8 - 32
10	12	Hook & Eye	10 - 24
10	13	Hook & Eye	12 - 24
10	14	Hook & Eye	1/4" - 20
10	15	Hook & Eye	5/16" - 18
10	16	Hook & Eye	3/8" - 16
10	17	Hook & Eye	3/8" - 16
<b>140 Turnbuckles</b>			
<b>Shipping Wt. ....34 lbs.</b>			



Load Ratings	Thread Diameter								
	6-32	8-32	10-24	12-24	1/4"-20	5/16"-18	3/8"-16	7/16"-14	1/2"-13
	Working Load Limit (Pounds)								
Eyebolt (Not Welded)	22	36	38	52	74	96	144	216	298
Turnbuckle Hook	—	36	44	52	68	112	174	—	—
Eyebolt Welded	—	—	—	—	—	240	400	—	1000



# DROP FORGED ANCHOR SHACKLES



Size, working load limit, and trademark are permanently marked on all shackles. All shackles and pins are heat treated. Loads are based on a safety factor of 6 to 1, except (\*\*), which is 5 to 1. When tested all shackles are pulled at a uniform rate of speed in a direct tension.

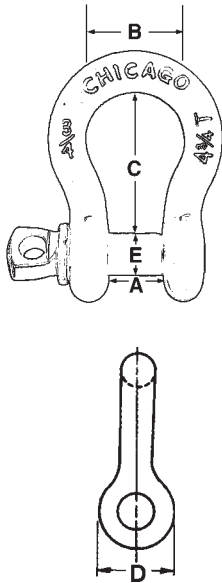

## Shackles Meet Performance Requirements of Federal Specifications RR-C-271D Type IVA\*

Working Load Limit in Tons	Anchor - Round Pin - S crew Pin - S safety								Estimated Weight Per 100 in lbs.
	Dimensions - Inches						O.D. Eyes (D)	Pin or Bolt Dia. (E)	
	Size Dia.	Width @ Eyes (A)	Tol. ±	Width @ Bow (B)	Length (C)	Tol. ±			
1/3	3/16"	3/8"	1/16"	9/16"	7/8"	1/16"	5/8"	1/4"	7
1/2	1/4"	15/32"	1/16"	3/4"	1-1/8"	1/16"	3/4"	5/16"	13.5
3/4	5/16"	17/32"	1/16"	15/16"	1-1/4"	1/16"	7/8"	3/8"	22
1	3/8"	21/32"	1/16"	1-1/8"	1-7/16"	1/8"	1"	7/16"	33
1-1/2	7/16"	23/32"	1/16"	1-5/16"	1-11/16"	1/8"	1-1/8"	1/2"	53.5
2	1/2"	13/16"	1/16"	1-1/2"	1-15/16"	1/8"	1-1/4"	5/8"	76.5
3-1/4	5/8"	1-1/16"	1/16"	1-7/8"	2-1/2"	1/8"	1-11/16"	3/4"	150.5
4-3/4	3/4"	1-1/4"	1/16"	2"	3"	1/4"	1-7/8"	7/8"	245.5
6-1/2	7/8"	1-7/16"	1/16"	2-5/8"	3-1/4"	1/4"	2-1/8"	1"	375
8-1/2	1"	1-11/16"	1/16"	2-3/4"	3-3/4"	1/4"	2-1/2"	1-1/8"	537.5
9-1/2	1-1/8"	1-13/16"	1/16"	2-15/16"	4-1/4"	1/4"	2-5/8"	1-1/4"	765
12	1-1/4"	2"	1/16"	3-1/4"	4-1/2"	1/4"	3"	1-3/8"	1007.5
13 1/2	**1-3/8"	2-1/4"	1/8"	3-1/2"	5-1/4"	1/4"	3-1/4"	1-1/2"	1232.5
17	1-1/2"	2-3/8"	1/8"	3-3/4"	5-3/4"	1/4"	3-1/2"	1-5/8"	1777.5

### WARNING:

Any deviations such as angular lifts, shock loads, modification of the basic forging, etc., will result in drastically reduced working load limits.

All types of shackles are available in a self-colored or hot galvanized finish. When ordering specify the size, finish, and type of shackle. Other rust preventative coatings are available on a special basis.

Safety shackles are of the same specifications as the regular types except for the bolt, nut and cotter.

\*Class 1



ROUND PIN

Size	Galvanized	Self-Colored
	Part No.	Part No.
3/16"	21105 5	21005 8
1/4"	21110 9	21010 2
5/16"	21115 4	21015 7
3/8"	21120 8	21020 1
7/16"	21125 3	21025 6
1/2"	21130 7	21030 0
5/8"	21135 2	21035 5
3/4"	21140 6	21040 9
7/8"	21145 1	21045 4
1"	21150 5	21050 8
1-1/8"	21155 0	21055 3
1-1/4"	21160 4	21060 7
1-3/8"	21165 9	21065 2
1-1/2"	21170 3	21070 6

\*Class 2



SCREW PIN

Size	Galvanized	Self-Colored
	Part No.	Part No.
3/16"	20105 6	20005 9
1/4"	20110 0	20010 3
5/16"	20115 5	20015 8
3/8"	20120 9	20020 2
7/16"	20125 4	20025 7
1/2"	20130 8	20030 1
5/8"	20135 3	20035 6
3/4"	20140 7	20040 0
7/8"	20145 2	20045 5
1"	20150 6	20050 9
1-1/8"	20155 1	20055 4
1-1/4"	20160 5	20060 8
1-3/8"	20165 0	20065 3
1-1/2"	20170 4	20070 7

\*Class 3



SAFETY

Size	Galvanized	Self-Colored
	Part No.	Part No.
1/4"	20610 5	20510 8
5/16"	20615 0	20515 3
3/8"	20620 4	20520 7
7/16"	20625 9	20525 2
1/2"	20630 3	20530 6
5/8"	20635 8	20535 1
3/4"	20640 2	20540 5
7/8"	20645 7	20545 0
1"	20650 1	20550 4
1-1/8"	20655 6	20555 9
1-1/4"	20660 0	20560 3
1-1/2"	20670 9	20570 2





# DROP FORGED CHAIN SHACKLES

Size, working load, and trademark are permanently marked on all shackles. All shackles and pins are heat treated. Loads are based on a safety factor of 6 to 1. When tested all shackles are pulled at a uniform rate of speed in a direct tension.

Shackles Meet Performance Requirements of Federal Specifications RR-C-271D Type IVB\*

Working Load Limit in Tons	Chain — Round Pin — Screw Pin — Safety							Estimated Weight Per 100 in lbs.
	Dimensions — Inches					O.D. Eyes (C)	Pin or Bolt Dia. (D)	
	Size Dia.	Width (A)	Tol. ±	Length (B)	Tol. ±			
1/2	1/4"	15/32"	1/16"	7/8"	1/16"	3/4"	5/16"	11
3/4	5/16"	17/32"	1/16"	1"	1/16"	7/8"	3/8"	20
1	3/8"	21/32"	1/16"	1-1/4"	1/8"	1"	7/16"	31.5
1-1/2	7/16"	23/32"	1/16"	1-1/2"	1/8"	1-1/8"	1/2"	45.5
2	1/2"	13/16"	1/16"	1-11/16"	1/8"	1-1/4"	5/8"	69.5
3-1/4	5/8"	1-1/16"	1/16"	2"	1/8"	1-5/8"	3/4"	132.5
4-3/4	3/4"	1-1/4"	1/16"	2-5/16"	1/4"	1-7/8"	7/8"	212
6-1/2	7/8"	1-7/16"	1/16"	2-7/8"	1/4"	2-1/8"	1"	320
8-1/2	1"	1-11/16"	1/16"	3-1/4"	1/4"	2-1/2"	1-1/8"	500

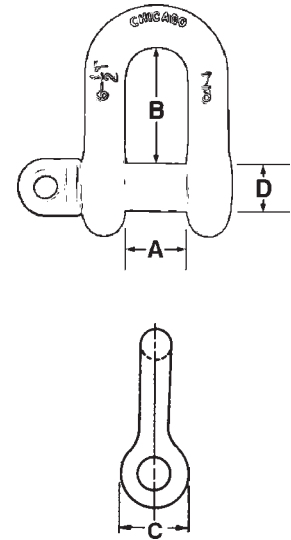

## WARNING:

Any deviations such as angular lifts, shock loads, modification of the basic forging, etc., will result in drastically reduced working load limits.

All types of shackles are available in a self-colored or hot galvanized finish. When ordering specify the size, finish, and type of shackle. Other rust preventative coatings are available on a special basis.

Safety shackles are of the same specifications as the regular types except for the bolt, nut and cotter.

\*Class 1



## ROUND PIN

Size	Galvanized	Self-Colored
	Part No.	Part No.
1/4"	21310 3	21210 6
5/16"	21315 8	21215 1
3/8"	21320 2	21220 5
7/16"	21325 7	21225 0
1/2"	21330 1	21230 4
5/8"	21335 6	21235 9
3/4"	21340 0	21240 3
7/8"	21345 5	21245 8
1"	21350 9	21250 2

\*Class 2



## SCREW PIN

Size	Galvanized	Self-Colored
	Part No.	Part No.
1/4"	20310 4	20210 7
5/16"	20315 9	20215 2
3/8"	20320 3	20220 6
7/16"	20325 8	20225 1
1/2"	20330 2	20230 5
5/8"	20335 7	20235 0
3/4"	20340 1	20240 4
7/8"	20345 6	20245 9
1"	20350 0	20250 3

\*Class 3



## SAFETY

Size	Galvanized	Self-Colored
	Part No.	Part No.
1/4"	20810 9	20710 2
5/16"	20815 4	20715 7
3/8"	20820 8	20720 1
7/16"	20825 3	20725 6
1/2"	20830 7	20730 0
5/8"	20835 2	20735 5
3/4"	20840 6	20740 9
7/8"	20845 1	20745 4
1"	20850 5	20750 8



# MALLEABLE WIRE ROPE CLIPS



Clips supplied with self-colored, galvanized or hot galvanized finish. U-bolts for clips are available with or without nuts — price on application.



Should be used  
only in  
light duty applications

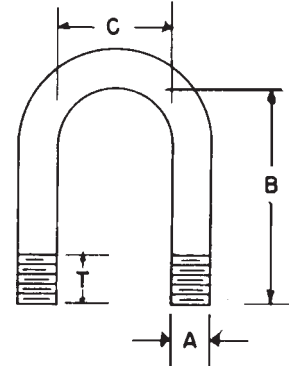

Meets Performance Requirements of Federal Specification FF-C-450, Type 1, Class 2  
Some sizes available in Stainless Steel. See page 47.

Rope Size	Self-Colored	Galvanized	Hot Galvanized	U-Bolt Dimensions				Weight
	Part No.	Part No.	Part No.	A	B	C	T	Per 100
3/32"	23005 6	23155 8	N.A.	10-24	3/4"	19/64"	1/2"	3.7
1/8"	23010 0	23160 2	N.A.	1/4"-20	15/16"	5/16"	5/8"	6.5
3/16"	23015 5	23165 7	N.A.	1/4"-20	15/16"	5/16"	5/8"	6.8
1/4"	23020 9	23170 1	23320 0	5/16"-18	1-5/32"	3/8"	3/4"	12.2
5/16"	23025 4	23175 6	23325 5	5/16"-18	1-5/32"	3/8"	3/4"	12.2
3/8"	23030 8	23180 0	23330 9	3/8"-16	1-1/2"	1/2"	1"	18.5
7/16"	23035 3	23185 5	23335 4	3/8"-16	1-1/2"	1/2"	1"	24
1/2"	23040 7	23190 9	23340 8	7/16"-14	1-13/16"	9/16"	1-1/8"	33.3
9/16"	23045 2	23195 4	23345 3	1/2"-13	2-1/8"	11/16"	1-3/8"	51.5
5/8"	23050 6	23200 5	23350 7	1/2"-13	2-1/8"	11/16"	1-3/8"	55.9
3/4"	23055 1	23205 0	23355 2	9/16"-12	2-11/16"	13/16"	1-5/8"	80.8
7/8"	23060 5	23210 4	23360 6	5/8"-11	3-1/4"	1-1/8"	1-7/8"	140
1"	23065 0	23215 9	23365 1	5/8"-11	3-1/4"	1-1/8"	1-7/8"	150
1-1/8"	23070 4	23220 3	N.A.	3/4"-10	4-3/8"	1-5/16"	2-1/2"	263
1-1/4"	23075 9	23225 8	N.A.	3/4"-10	4-3/8"	1-5/16"	2-1/2"	300
1-3/8"	23080 3	23230 2	N.A.	7/8"-9	5-1/8"	1-11/16"	2-3/4"	441
1-1/2"	23085 8	23235 7	N.A.	7/8"-9	5-1/8"	1-11/16"	2-3/4"	488
1-3/4"	23095 7	23245 6	N.A.	1"-8	6-1/4"	2-1/16"	3-3/4"	899.5
2"	23100 8	23250 0	N.A.	1"-8	7-1/4"	2-1/2"	4"	1285

## TILLER ROPE CLAMPS



Rope Diameter	Part No.	Overall Length	Overall Width	Weight Per 100
1/8"	27910 9	1-5/8"	3/4"	10 Lbs.
3/16"	27920 8	1-3/4"	3/4"	12 Lbs.

Malleable iron castings hot galvanized finish. Furnished with brass flat head machine screws.



# DROP FORGED WIRE ROPE CLIPS

“CHICAGO” the Trade-Mark of quality in wire rope fittings is embossed on all forged steel clip bases. This identification symbolizes wire rope clips that are manufactured to rigid specifications. Component parts are galvanized. U-bolts, with or without nuts, price on application.

Should be used in heavy duty applications



	Hot Galvanized	U-Bolt Dimensions				Weight
Rope Size	Part No.	A	B	C	T	Per 100
1/8"	23460 3	12-24	3/4"	9/32"	1/2"	6.5
3/16"	23465 8	1/4"-20	15/16"	5/16"	5/8"	10
1/4"	23470 2	5/16"-18	1-5/32"	3/8"	3/4"	18.5
5/16"	23475 7	3/8"-16	1-1/2"	1/2"	1"	29.5
3/8"	23480 1	7/16"-14	1-5/8"	9/16"	7/8"	44
7/16"	23485 6	1/2"-13	1-7/8"	5/8"	1-1/4"	64
1/2"	23490 0	1/2"-13	1-7/8"	5/8"	1-1/4"	75
9/16"	23495 5	9/16"-12	2-3/8"	3/4"	1-3/8"	106
5/8"	23500 6	9/16"-12	2-3/8"	3/4"	1-3/8"	106
3/4"	23505 1	5/8"-11	2-3/4"	7/8"	1-5/8"	153
7/8"	23510 5	3/4"-10	3-1/4"	1"	1-7/8"	237.5
1"	23515 0	3/4"-10	3-5/8"	1-1/8"	2"	272.5
1-1/8"	23520 4	3/4"-10	3-13/16"	1-1/4"	2-1/4"	325
1-1/4"	23525 9	7/8"-9	4-3/8"	1-11/32"	2-1/2"	441
1-1/2"	23535 8	7/8"-9	5-1/8"	1-11/16"	2-3/4"	550

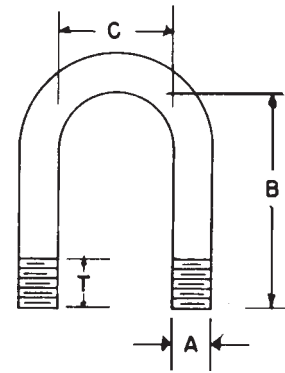

Meets Performance Requirements of Federal Specification FF-C-450, Type 1, Class 1

1



2



3



## RECOMMENDED APPLICATION FOR CHICAGO DROP FORGED WIRE ROPE CLIPS

Clip Size Inches	Minimum No. of Clips	Amount of Rope to Turn Back in Inches	Torque in Ft. Lbs.
1/8"	2	3-1/4"	4.5
3/16"	2	3-3/4"	7.5
1/4"	2	4-3/4"	15
5/16"	2	5-1/4"	30
3/8"	2	6-1/2"	45
7/16"	2	7"	65
1/2"	3	11-1/2"	65
9/16"	3	12"	95
5/8"	3	12"	95
3/4"	4	18"	130
7/8"	4	19"	225
1"	5	26"	225
1-1/8"	6	34"	225
1-1/4"	7	44"	360
1-1/2"	8	54"	360

1. The correct way to attach wire rope clips is illustrated above. Apply the first clip one base width from the dead end of the wire rope. The base or saddle should bear on the line end of the rope – U-bolt on the short end. Tighten nuts firmly.

2. Attach second clip as close to loop as possible. Tighten nuts but not firmly.

3. Attach balance of clips spaced equally between first two clips. Tighten all nuts completely. Apply initial load – inspect nuts and retighten. Inspect all clips periodically.

The number of clips shown is based on using right regular or Lang lay wire rope, 6x19 class or 6x37 class, fibre core IWRC, IPS or XIPS. The number of clips shown also applies to right regular lay wire rope, 8x19 class and 18x7 class, fibre core, IPS or XIPS, sizes 1-1/2-inch and smaller.

If Seale construction or similar large outer wire type construction in the 6x19 class is to be used for sizes 1-inch and larger, add one additional clip. For other classes or wire rope not mentioned, it may be necessary to add additional clips to the number shown. If more clips are used than shown, amount of rope turn back should be increased proportionately.



# WIRE ROPE THIMBLES



Available in closed or open pattern with galvanized finish.



**CLOSED**



**OPEN**

## STANDARD

Rope Diameter	Closed Part No.	Open Part No.	Dimensions – Inches					Weight Per 100
			Length		Width			
			Overall	Inside	Inside	Opening	Inside score	
1/8"	22505 2	22405 5	1-5/8"	1-7/32"	19/32"	3/8"	3/16"	2.1
3/16"	22510 6	22410 9	1-5/8"	1-7/32"	19/32"	3/8"	7/32"	2.1
1/4"	22515 1	22415 4	1-7/8"	1-3/8"	11/16"	1/2"	1/4"	3.4
5/16"	22520 5	22420 8	2-1/8"	1-1/2"	3/4"	5/8"	5/16"	4.6
3/8"	22525 0	22425 3	2-5/8"	1-7/8"	7/8"	5/8"	13/32"	9
7/16"	22530 4	22430 7	2-3/4"	1-7/8"	1-1/16"	3/4"	15/32"	17
1/2"	22535 9	22435 2	2-7/8"	2"	1-1/8"	3/4"	19/32"	17
5/8"	22540 3	22440 6	3-3/8"	2-7/32"	1-5/16"	7/8"	23/32"	30
3/4"	22545 8	22445 1	3-7/8"	2-1/2"	1-1/2"	1"	13/16"	39.5
7/8"	22550 2	22450 5	4-9/16"	3"	1-11/16"	1-1/8"	15/16"	58.5
1"	22555 7	22455 0	5"	3-7/32"	2"	1-1/8"	1-1/8"	96
1-1/8"	22560 1	N.A.	5-3/8"	3-9/16"	2-1/4"	N.A.	1-1/4"	108.5
1-1/4"	22565 6	N.A.	5-3/4"	3-9/16"	2-7/16"	N.A.	1-5/16"	145.5
1-1/2"	22570 0	N.A.	7"	4-5/16"	2-7/8"	N.A.	1-9/16"	246.5
1-3/4"	22575 5	N.A.	8-1/2"	5-1/4"	3-5/16"	N.A.	1-7/8"	460
2"	22580 9	N.A.	10"	6-5/8"	3-1/2"	N.A.	2-3/32"	590

Recommended for light duty applications.

Some sizes also available in Stainless Steel. See page 47.

## HEAVY DUTY



Rope Diameter	Part No.	Dimensions – Inches				Weight Per 100
		Length		Width		
		Overall	Inside	Inside	Inside score	
1/4"	22105 4	2-3/16"	1-5/8"	7/8"	1/4"	6.5
5/16"	22110 8	2-1/2"	1-7/8"	1-1/16"	11/32"	11.8
3/8"	22115 3	2-7/8"	2-1/8"	1-1/8"	13/32"	21.6
7/16"	22120 7	3-1/4"	2-3/8"	1-1/4"	15/32"	34.7
1/2"	22125 2	3-5/8"	2-3/4"	1-1/2"	17/32"	51
9/16"-5/8"	22130 6	4-1/4"	3-1/4"	1-3/4"	21/32"	51
3/4"	22135 1	5"	3-3/4"	2"	25/32"	158
7/8"	22140 5	5-1/2"	4-1/4"	2-1/4"	15/16"	178
1"	22145 0	6-1/8"	4-1/2"	2-1/2"	1-1/16"	314
1-1/8"-1-1/4"	22150 4	7"	5-1/8"	2-7/8"	1-5/16"	400
1-3/8"-1-1/2"	22155 9	9"	6-1/4"	3-1/2"	1-9/16"	1295

Recommended for heavy duty applications.



# DROP FORGED EYE BOLTS

Regular, shoulder and screw thread (see page 15) drop forged heat treated steel eye bolts supplied as standard with hot galvanized finish. Machine thread eye bolts are threaded National Course before galvanizing and assembled with hex nuts tapped oversize. Loads are based on a safety factor of 5 to 1. When tested all eye bolts are pulled at a uniform rate of speed in a direct tension.

## REGULAR - MACHINE THREAD

Diameter (A) & Shank Length (B)	Part No.	Dimensions - Inches				Weight Per 100 pcs	Working Load Limit
		Outside Eye (C)	Inside Eye (D)	Overall Length (E)	Thread Length (T)		
1/4" x 2"	08005 7	1"	1/2"	3"	1-1/2"	6.4	500
1/4" x 3"	08008 8	1"	1/2"	4"	1-1/2"	8	500
1/4" x 4"	08011 8	1"	1/2"	5"	2"	9.3	500
1/4" x 5"	08014 9	1"	1/2"	6"	2-1/2"	10.4	500
1/4" x 6"	08017 0	1"	1/2"	7"	3"	11.8	500
5/16" x 2-1/4"	08022 4	1-1/4"	5/8"	3-1/2"	1-1/2"	12.7	800
5/16" x 3-1/4"	08025 5	1-1/4"	5/8"	4-1/2"	1-1/2"	15	800
5/16" x 4-1/4"	08028 6	1-1/4"	5/8"	5-1/2"	2-1/2"	16.5	800
5/16" x 5"	08031 6	1-1/4"	5/8"	6-1/4"	2-1/2"	18.6	800
5/16" x 6"	08034 7	1-1/4"	5/8"	7-1/4"	3"	24.5	800
3/8" x 2-1/2"	08039 2	1-1/2"	3/4"	4"	1-1/2"	19.2	1200
3/8" x 3"	08042 2	1-1/2"	3/4"	4-1/2"	1-1/2"	21.2	1200
3/8" x 4-1/4"	08045 3	1-1/2"	3/4"	6"	2"	24.4	1200
3/8" x 5"	08048 4	1-1/2"	3/4"	6-1/2"	2-1/2"	27.8	1200
3/8" x 6"	08051 4	1-1/2"	3/4"	7-1/2"	3"	30	1200
3/8" x 8"	08054 5	1-1/2"	3/4"	9-1/2"	4"	36	1200
1/2" x 2"	08059 0	2"	1"	4"	1-7/8"	38.5	2200
1/2" x 3-1/4"	08062 0	2"	1"	5-1/4"	1-1/2"	46	2200
1/2" x 4-1/2"	08065 1	2"	1"	6-1/2"	2"	53	2200
1/2" x 6"	08068 2	2"	1"	8"	3"	60	2200
1/2" x 8"	08071 2	2"	1"	10"	4"	71	2200
1/2" x 10"	08074 3	2"	1"	12"	4"	83	2200
1/2" x 12"	08077 4	2"	1"	14"	4"	96	2200
5/8" x 4-1/2"	08082 8	2-5/16"	1-1/4"	6-13/16"	2"	79	3500
5/8" x 6"	08085 9	2-5/16"	1-1/4"	8-5/16"	3"	96	3500
5/8" x 8"	08088 0	2-5/16"	1-1/4"	10-5/16"	4"	128	3500
5/8" x 10"	08091 0	2-5/16"	1-1/4"	12-5/16"	4"	129.5	3500
5/8" x 12"	08094 1	2-5/16"	1-1/4"	14-5/16"	4"	146	3500
5/8" x 15"	08097 2	2-5/16"	1-1/4"	17-5/16"	6"	168	3500
5/8" x 18"	08100 9	2-5/16"	1-1/4"	20-5/16"	6"	195	3500
5/8" x 24"	08103 0	2-5/16"	1-1/4"	26-5/16"	6"	246	3500
3/4" x 4-1/2"	08108 5	2-3/4"	1-1/2"	7-1/4"	2-1/2"	126	5200
3/4" x 6"	08111 5	2-3/4"	1-1/2"	8-3/4"	3"	160	5200
3/4" x 8"	08114 6	2-3/4"	1-1/2"	10-3/4"	4"	180	5200
3/4" x 10"	08117 7	2-3/4"	1-1/2"	12-3/4"	4"	200	5200
3/4" x 12"	08120 7	2-3/4"	1-1/2"	14-3/4"	4"	233	5200
3/4" x 15"	08123 8	2-3/4"	1-1/2"	17-3/4"	6"	254	5200
3/4" x 18"	08126 9	2-3/4"	1-1/2"	20-3/4"	6"	290	5200
3/4" x 24"	08129 0	2-3/4"	1-1/2"	26-3/4"	6"	369	5200
7/8" x 5"	08134 4	3-1/2"	1-3/4"	8-1/2"	2-1/2"	245	7000
7/8" x 8"	08137 5	3-1/2"	1-3/4"	11-1/2"	4"	296	7000
7/8" x 12"	08140 5	3-1/2"	1-3/4"	15-1/2"	4"	366	7000
7/8" x 18"	08143 6	3-1/2"	1-3/4"	21-1/2"	6"	464	7000
7/8" x 24"	08146 7	3-1/2"	1-3/4"	27-1/2"	6"	556	7000
1" x 6"	08151 1	3-3/4"	2"	9-3/4"	3"	301	10000
1" x 9"	08154 2	3-3/4"	2"	12-3/4"	4"	383	10000
1" x 12"	08157 3	3-3/4"	2"	15-3/4"	4"	450	10000
1" x 18"	08160 3	3-3/4"	2"	21-3/4"	6"	584	10000
1" x 24"	08163 4	3-3/4"	2"	27-3/4"	6"	716	10000



### WARNING:

Any deviations such as angular lifts, shock loads, modification of the basic forging, etc., will result in drastically reduced working load limits.

Special shank and thread lengths are also available.

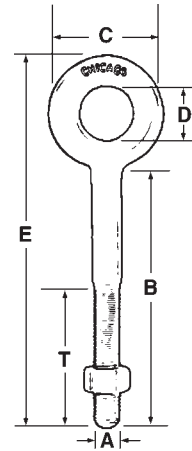

Some sizes also available in Stainless Steel. See page 47.



# DROP FORGED EYE BOLTS



**MACHINE THREAD** (As noted on page 14)

**WARNING:**

Any deviations such as angular lifts, shock loads, modification of the basic forging, etc., will result in drastically reduced working load limits.

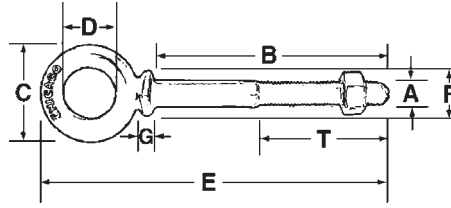

**SHOULDER**

Diameter (A) & Shank Length (B)	Part No.	Dimensions – Inches						Weight Per 100 pcs	Working Load Limit†
		Outside Eye (C)	Inside Eye (D)	Overall Length (E)	Outside Shoulder (F)	Thickness at Shoulder (G)	Thread Length (T)		
1/4" x 2"	08405 5	1"	1/2"	3-1/8"	7/16"	5/64"	1-1/2"	7.4	500
1/4" x 4"	08411 6	1"	1/2"	5-1/8"	7/16"	5/64"	2"	10.7	500
5/16" x 2-1/4"	08422 2	1-1/4"	5/8"	3-5/8"	9/16"	3/32"	1-1/2"	12.9	800
5/16" x 4-1/4"	08428 4	1-1/4"	5/8"	5-5/8"	9/16"	3/32"	2-1/2"	16.8	800
3/8" x 2-1/2"	08439 0	1-1/2"	3/4"	4-1/4"	11/16"	1/8"	1-1/2"	21	1200
3/8" x 4-1/2"	08445 1	1-1/2"	3/4"	6-1/4"	11/16"	1/8"	2"	29	1200
1/2" x 2"	08459 8	2"	1"	4-5/16"	7/8"	5/32"	1-7/8"	44	2200
1/2" x 3-1/4"	08462 8	2"	1"	5-1/2"	7/8"	5/32"	1-1/2"	46	2200
1/2" x 6"	08468 0	2"	1"	8-1/4"	7/8"	5/32"	3"	63	2200
5/8" x 4-1/2"	08482 6	2-5/16"	1-1/4"	7-1/4"	1-1/8"	13/64"	2"	99	3500
5/8" x 6"	08485 7	2-5/16"	1-1/4"	8-9/16"	1-1/8"	13/64"	3"	103	3500
3/4" x 4-1/2"	08508 3	2-3/4"	1-1/2"	7-3/4"	1-3/8"	1/4"	2-1/2"	152	5200
3/4" x 6"	08511 3	2-3/4"	1-1/2"	9-1/8"	1-3/8"	1/4"	3"	166	5200
7/8" x 5"	08534 2	3-1/2"	1-3/4"	9-1/4"	1-1/2"	9/32"	2-1/2"	222	7000
7/8" x 8"	08537 3	3-1/2"	1-3/4"	12-1/8"	1-1/2"	9/32"	4"	269	7000
1" x 6"	08551 9	3-3/4"	2"	10-1/2"	1-3/4"	5/16"	3"	331	10000
1" x 9"	08554 0	3-3/4"	2"	13-1/4"	1-3/4"	5/16"	4"	404	10000



† Loads are based on a safety factor of 5 to 1. Some sizes also available in Stainless Steel. See page 47. Special shank and thread lengths are also available.

# SCREW THREAD EYE BOLTS

**REGULAR**

Diameter (A) & Shank Length (B)	Part No.	Dimensions – Inches				Weight Per 100
		Outside Eye (C)	Inside Eye (D)	Overall Length (E)	Thread Length (T)	
1/4" x 2"	08805 3	1"	1/2"	3"	1-1/2"	5.3
5/16" x 2-1/4"	08810 7	1-1/4"	5/8"	3-1/2"	1-5/8"	9
3/8" x 2-1/2"	08815 2	1-1/2"	3/4"	4"	1-3/4"	16
1/2" x 3-1/4"	08820 6	2"	1"	5-1/4"	2-1/8"	39
5/8" x 4-1/2"	08825 1	2-5/16"	1-1/4"	6-13/16"	2-1/2"	67
3/4" x 4-1/2"	08830 5	2-3/4"	1-1/2"	7-1/4"	3"	108
7/8" x 5"	08835 0	3-1/2"	1-3/4"	8-1/4"	3-1/4"	166
1" x 6"	08840 4	3-3/4"	2"	9-3/4"	3-1/2"	265

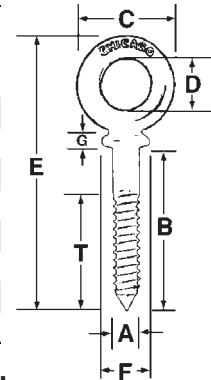

Screw eye bolts supplied with cone points – lag screw thread.

**SHOULDER**

Diameter (A) & Shank Length (B)	Part No.	Dimensions – Inches						Weight Per 100 pcs
		Outside Eye (C)	Inside Eye (D)	Overall Length (E)	Outside Shoulder (F)	Thickness at Shoulder (G)	Thread Length (T)	
1/4" x 2"	08905 0	1"	1/2"	3-1/8"	7/16"	5/64"	1-1/2"	6.7
5/16" x 2-1/4"	08910 4	1-1/4"	5/8"	3-3/4"	9/16"	3/32"	1-5/8"	12
3/8" x 2-1/2"	08915 9	1-1/2"	3/4"	4-1/4"	11/16"	1/8"	1-3/4"	19
1/2" x 3-1/4"	08920 3	2"	1"	5-1/2"	7/8"	5/32"	2-1/8"	42
5/8" x 4-1/2"	08925 8	2-5/16"	1-1/4"	7-1/4"	1-1/8"	13/64"	2-1/2"	86
3/4" x 4-1/2"	08930 2	2-3/4"	1-1/2"	7-3/4"	1-3/8"	1/4"	3"	120
7/8" x 5"	08935 7	3-1/2"	1-3/4"	9"	1-1/2"	9/32"	3-1/4"	189
1" x 6"	08940 1	3-3/4"	2"	10-1/2"	1-3/4"	5/16"	3-1/2"	297





# DROP FORGED \*RING BOLTS

Ring bolts are only available in hot galvanized finish. Eye bolts are drop forged steel; eye bolt specifications are identical to those shown on pages 14-15. Ring dimensions are shown in table below. **RING BOLTS ARE NOT TO BE USED FOR LIFTING APPLICATIONS.**

## REGULAR – MACHINE THREAD

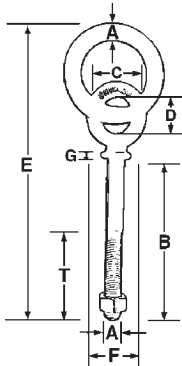

Diameter (A) & Shank Length (B)	Part No.	Dimensions – Inches					Weight Per 100 pcs	Working Load Limit
		O.D. Eye of Bolt (C)	I.D. Eye of Bolt (D)	I.D. Eye of Ring	Overall Length (E)	Thread Length (T)		
1/4" x 2"	09205 0	1"	1/2"	1-3/4"	4-3/4"	1-1/2"	16	250
1/4" x 4"	09211 1	1"	1/2"	1-3/4"	6-3/4"	2"	18	250
5/16" x 2-1/4"	09216 6	1-1/4"	5/8"	2"	5-1/2"	1-1/2"	29	400
5/16" x 4-1/4"	09219 7	1-1/4"	5/8"	2"	7-1/2"	2-1/2"	32.5	400
3/8" x 2-1/2"	09224 1	1-1/2"	3/4"	2-1/2"	6-1/2"	1-1/2"	47.5	600
3/8" x 4-1/4"	09227 2	1-1/2"	3/4"	2-1/2"	8-1/4"	2"	52	600
3/8" x 6"	09230 2	1-1/2"	3/4"	2-1/2"	10"	3"	56	600
3/8" x 8"	09233 3	1-1/2"	3/4"	2-1/2"	12"	4"	62	600
1/2" x 3-1/4"	09238 8	2"	1"	3"	8-1/4"	1-1/2"	108	1100
1/2" x 6"	09241 8	2"	1"	3"	11"	3"	121	1100
1/2" x 8"	09244 9	2"	1"	3"	13"	4"	135.5	1100
1/2" x 10"	09247 0	2"	1"	3"	15"	4"	142.5	1100
5/8" x 4-1/2"	09252 4	2-5/16"	1-1/4"	2-3/4"	9-9/16"	2"	175	1750
5/8" x 6"	09255 5	2-5/16"	1-1/4"	2-3/4"	11-1/16"	3"	190	1750
5/8" x 8"	09258 6	2-5/16"	1-1/4"	2-3/4"	13-1/16"	4"	200	1750
5/8" x 10"	09261 6	2-5/16"	1-1/4"	2-3/4"	15-1/16"	4"	231	1750
5/8" x 12"	09264 7	2-5/16"	1-1/4"	2-3/4"	17-1/16"	4"	242	1750
3/4" x 4-1/2"	09269 2	2-3/4"	1-1/2"	3"	10-1/4"	2-1/2"	281	2600
3/4" x 6"	09272 2	2-3/4"	1-1/2"	3"	11-3/4"	3"	311.5	2600
3/4" x 8"	09275 3	2-3/4"	1-1/2"	3"	13-3/4"	4"	312.5	2600
3/4" x 10"	09278 4	2-3/4"	1-1/2"	3"	15-3/4"	4"	315	2600
3/4" x 12"	09281 4	2-3/4"	1-1/2"	3"	17-3/4"	4"	317.5	2600
7/8" x 5"	09286 9	3-1/2"	1-3/4"	3-1/4"	11-1/2"	2-1/2"	520	3500
7/8" x 8"	09289 0	3-1/2"	1-3/4"	3-1/4"	14-1/2"	4"	538	3500
1" x 6"	09294 4	3-3/4"	2"	3-3/4"	13-1/2"	3"	645	4900
1" x 9"	09297 5	3-3/4"	2"	3-3/4"	16-1/2"	4"	741	4900

\*Welded Rings



## SHOULDER – MACHINE THREAD

Diameter (A) & Shank Length (B)	Part No.	Dimensions – Inches							Weight Per 100 pcs	Working Load Limit
		O.D. Eye of Bolt (C)	I.D. Eye of Bolt (D)	I.D. Eye of Ring	Overall Length (E)	Outside Shoulder (F)	Thickness at Shoulder (G)	Thread Length (T)		
1/4" x 2"	09505 1	1"	1/2"	1-3/4"	4-3/4"	7/16"	5/64"	1-1/2"	17	250
1/4" x 4"	09511 2	1"	1/2"	1-3/4"	6-1/4"	7/16"	5/64"	2"	19	250
5/16" x 2-1/4"	09516 7	1-1/4"	5/8"	2"	5-3/4"	9/16"	3/32"	1-1/2"	30	400
5/16" x 4-1/4"	09519 8	1-1/4"	5/8"	2"	6-5/8"	9/16"	3/32"	2"	33.5	400
3/8" x 2-1/2"	09524 2	1-1/2"	3/4"	2-1/2"	6-1/2"	11/16"	1/8"	1-1/2"	51	600
3/8" x 4-1/2"	09527 3	1-1/2"	3/4"	2-1/2"	8-3/4"	11/16"	1/8"	2"	58	600
1/2" x 3-1/4"	09538 9	2"	1"	3"	8-7/16"	7/8"	5/32"	1-1/2"	115	1100
1/2" x 6"	09541 9	2"	1"	3"	11"	7/8"	5/32"	3"	127	1100
5/8" x 4-1/2"	09552 5	2-5/16"	1-1/4"	2-3/4"	10"	1-1/8"	13/64"	2"	187.5	1750
5/8" x 6"	09555 6	2-5/16"	1-1/4"	2-3/4"	11-1/2"	1-1/8"	13/64"	3"	208	1750
3/4" x 4-1/2"	09569 3	3"	1-1/2"	3"	11"	1-3/8"	1/4"	2-1/2"	288	2600
3/4" x 6"	09572 3	3"	1-1/2"	3"	12-1/8"	1-3/8"	1/4"	3"	310	2600
7/8" x 5"	09586 0	3-1/2"	1-3/4"	3-1/4"	12"	1-1/2"	9/32"	2-1/2"	445	3500
7/8" x 8"	09589 1	3-1/2"	1-3/4"	3-1/4"	15"	1-1/2"	9/32"	4"	482	3500
1" x 6"	09594 5	3-3/4"	2"	3-3/4"	14"	1-3/4"	5/16"	3"	681	4900
1" x 9"	09597 6	3-3/4"	2"	3-3/4"	17"	1-3/4"	5/16"	4"	750	4900



# DROP FORGED \*RING BOLTS



Ring bolts are only available in hot galvanized finish. Eye bolts are drop forged steel; screw thread eye bolt specifications are identical to those shown on the bottom of page 15. Ring dimensions are shown in table below. **RING BOLTS ARE NOT TO BE USED FOR LIFTING APPLICATIONS.**

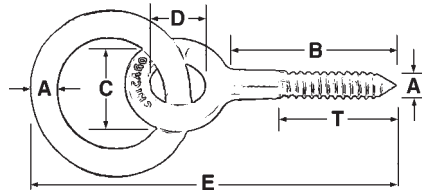

## REGULAR – SCREW THREAD

Diameter (A) & Shank Length (B)	Part No.	Dimensions – Inches					Weight Per 100 pcs
		O.D. Eye of Bolt (C)	I.D. Eye of Bolt (D)	I.D. Eye of Ring	Overall Length (E)	Thread Length (T)	
1/4" x 2"	09005 6	1"	1/2"	1-3/4"	4-3/4"	1-1/2"	16.7
5/16" x 2-1/4"	09010 0	1-1/4"	5/8"	2"	5-1/2"	1-5/8"	25.9
3/8" x 2-1/2"	09015 5	1-1/2"	3/4"	2-1/2"	6-1/2"	1-3/4"	44.3
1/2" x 3-1/4"	09020 9	2"	1"	3"	8-1/4"	2-1/8"	100.7
5/8" x 4-1/2"	09025 4	2-5/16"	1-1/4"	2-3/4"	9-9/16"	2-1/2"	162
3/4" x 4-1/2"	09030 8	2-3/4"	1-1/2"	3"	10-1/4"	3"	253
7/8" x 5"	09035 3	3-1/4"	1-3/4"	3-1/4"	11-1/2"	3-1/4"	403
1" x 6"	09040 7	3-3/4"	2"	3-3/4"	13-1/2"	3-1/2"	599

### \*Welded Rings

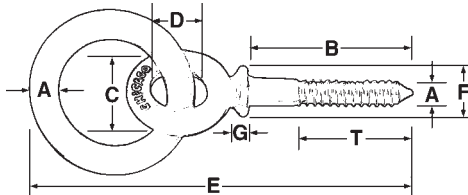

## SHOULDER – SCREW THREAD

Diameter (A) & Shank Length (B)	Part No.	Dimensions – Inches							Weight Per 100 pcs
		O.D. Eye of Bolt (C)	I.D. Eye of Bolt (D)	I.D. Eye of Ring	Overall Length (E)	Outside Shoulder (F)	Thickness at Shoulder (G)	Thread Length (T)	
1/4" x 2"	09105 3	1"	1/2"	1-3/4"	4-3/4"	7/16"	5/64"	1-1/2"	15.3
5/16" x 2-1/4"	09110 7	1-1/4"	5/8"	2"	5-1/2"	9/16"	3/32"	1-5/8"	28.9
3/8" x 2-1/2"	09115 2	1-1/2"	3/4"	2-1/2"	6-1/2"	11/16"	1/8"	1-3/4"	45.8
1/2" x 3-1/4"	09120 6	2"	1"	3"	8-1/4"	7/8"	5/32"	2-1/8"	105.8
5/8" x 4-1/2"	09125 1	2-5/16"	1-1/4"	2-3/4"	10-1/4"	1-1/8"	13/64"	2-1/2"	170
3/4" x 4-1/2"	09130 5	2-3/4"	1-1/2"	3"	11"	1-3/8"	1/4"	3"	272
7/8" x 5"	09135 0	3-1/4"	1-3/4"	3-1/4"	12"	1-1/2"	9/32"	3-1/4"	429
1" x 6"	09140 4	3-3/4"	2"	3-3/4"	14-1/2"	1-3/4"	5/16"	3-1/2"	647

### \*Welded Rings





# MACHINERY EYE BOLTS

Maximum blank lengths, either pattern indicated in column (1). Vertical loads are based on a safety factor of 5 to 1. Variation in quantity: on special items we reserve the right to a maximum 10% variation for allowances in manufacture.

## STANDARD SHANK LENGTHS – PLAIN & SHOULDER PATTERN

Stock Numbers		Dimensions – Inches						
Plain Pattern	Shoulder Pattern	Shank		Eye		Overall Length Plain	Overall Length Shoulder	Maximum Lengths (1)
		Dia. & Thread	Length	I.D.	O.D.			
1	21	1/4"-20	1"	3/4"	1-1/4"	2-1/4"	2-3/8"	3"
2	22	5/16"-18	1-1/8"	7/8"	1-1/2"	2-5/8"	2-3/4"	4"
3	23	3/8"-16	1-1/4"	1"	1-21/32"	2-29/32"	3-1/4"	4-1/2"
4	24	7/16"-14	1-3/8"	1-3/32"	1-27/32"	3-7/32"	3-5/8"	4-1/2"
5	25	1/2"-13	1-1/2"	1-3/16"	2-1/16"	3-9/16"	4"	4-1/2"
6	26	9/16"-12	1-5/8"	1-9/32"	2-9/32"	3-29/32"	4-1/2"	4-1/2"
7	27	5/8"-11	1-3/4"	1-3/8"	2-1/2"	4-1/4"	4-7/8"	4-1/2"
8	28	3/4"-10	2"	1-1/2"	2-13/16"	4-13/16"	5-1/4"	5"
9	29	7/8"-9	2-1/4"	1-11/16"	3-1/4"	5-1/2"	6"	5"
10	30	1"-8	2-1/2"	1-13/16"	3-9/16"	6-1/16"	7"	5"
11	31	1-1/8"-7	2-3/4"	2"	4"	6-3/4"	7-1/2"	2-3/4"
12	32	1-1/4"-7	3"	2-3/16"	4-7/16"	7-7/16"	8-1/2"	3"
14	34	1-1/2"-6	3-1/2"	2-1/2"	5-3/16"	8-11/16"	9-1/2"	3-1/2"

Working load limits for eye bolts are based on a straight vertical lift in a gradually increasing manner. Angular lifts will significantly lower working load limits (see Shoulder Pattern) and should be avoided whenever possible. If an angular lift is required, a properly seated Shoulder Pattern eye bolt must be used. Loads should always be applied to eye bolts in the plane of the eye, not at an angle to this plane. Angular lifts must never be more than a 45° pull. For angular lifting see page 23.

Diameter and Thread	Working Load Limit	
	Straight Pull (X)	45° Pull (Y) Shoulder Only
1/4"-20	500	125
5/16"-18	900	225
3/8"-16	1400	350
7/16"-14	2000	500
1/2"-13	2600	650
9/16"-12	3200	750
5/8"-11	4000	1000
3/4"-10	6000	1500
7/8"-9	7000	1750
1"-8	9000	2250
1-1/8"-7	12000	2500
1-1/4"-7	15000	3750
1-1/2"-6	21000	4900

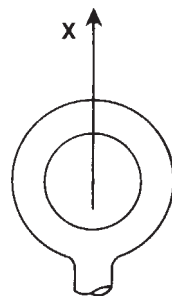

Plain Pattern

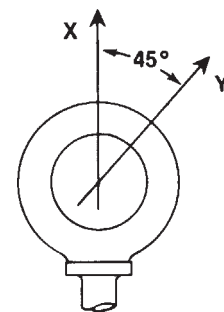

Shoulder Pattern

**ANGULAR LIFTS SHOULD BE AVOIDED WHENEVER POSSIBLE.**



# MACHINERY EYE BOLTS



Drop forged steel. Heat treated after forging. Self-colored, zinc plated, or hot galvanized. Plain or shoulder type, blank or threaded. Threaded will be supplied unless otherwise specified. See additional specifications and dimensions on page 18.

## STANDARD SHANK LENGTHS

### PLAIN PATTERN



Available in Zinc Plated and Hot Galvanized. See page 20.

Some sizes available in Stainless Steel. See page 48.

Available in Metric See page 22.

Plain Pattern No.	Bolt Diameter N.C.	Standard Shank Length	Threaded		Blank	
			Part No.	Weight Per 100	Part No.	Weight Per 100
1	1/4"	1"	11605 3	5	11005 1	5.5
2	5/16"	1-1/8"	11625 1	10.5	11025 9	11.5
3	3/8"	1-1/4"	11645 9	15.5	11045 7	16.5
4	7/16"	1-3/8"	11665 7	20.5	11065 5	22
5	1/2"	1-1/2"	11685 5	33	11085 3	35
6	9/16"	1-5/8"	11705 0	44.5	11105 8	45
7	5/8"	1-3/4"	11725 8	64	11125 6	66
8	3/4"	2"	11748 7	90.5	11148 5	97
9	7/8"	2-1/4"	11768 5	135	11168 3	142
10	1"	2-1/2"	11788 3	190.5	11188 1	199
11	1-1/8"	2-3/4"	11808 8	299.5	11208 6	312
12	1-1/4"	3"	11831 6	399	11231 4	412
14	1-1/2"	3-1/2"	11851 4	662.5	11251 2	691



## STANDARD SHANK LENGTHS

### SHOULDER PATTERN



Shoulder Pattern No.	Bolt Diameter N.C.	Standard Shank Length	Threaded		Blank	
			Part No.	Weight Per 100	Part No.	Weight Per 100
21	1/4"	1"	12805 6	6	12205 4	6
22	5/16"	1-1/8"	12825 4	10	12225 2	10.5
23	3/8"	1-1/4"	12845 2	16	12245 0	17
24	7/16"	1-3/8"	12865 0	26.5	12265 8	28
25	1/2"	1-1/2"	12885 8	38	12285 6	39
26	9/16"	1-5/8"	12905 3	49	12305 1	52.5
27	5/8"	1-3/4"	12925 1	73.5	12325 9	76.5
28	3/4"	2"	12948 0	99.5	12348 8	104
29	7/8"	2-1/4"	12968 8	172.5	12368 6	178
30	1"	2-1/2"	12988 6	235	12388 4	242
31	1-1/8"	2-3/4"	13008 0	342.5	12408 9	347
32	1-1/4"	3"	13031 8	462.5	12431 7	485
34	1-1/2"	3-1/2"	13051 6	752.5	12451 5	780



# PLATED MACHINERY EYE BOLTS

## ZINC PLATED

### PLAIN PATTERN - ZINC

Plain Pattern No.	Bolt Diameter N.C.	Standard Shank Length	Part No.
1	1/4"	1"	26005 3
2	5/16"	1-1/8"	26008 4
3	3/8"	1-1/4"	26011 4
4	7/16"	1-3/8"	26014 5
5	1/2"	1-1/2"	26017 6
6	9/16"	1-5/8"	26020 6
7	5/8"	1-3/4"	26023 7
8	3/4"	2"	26026 8
9	7/8"	2-1/4"	26029 9
10	1"	2-1/2"	26032 9
11	1-1/8"	2-3/4"	26035 0
12	1-1/4"	3"	26038 1
14	1-1/2"	3-1/2"	26041 1

### SHOULDER PATTERN - ZINC

Shoulder Pattern No.	Bolt Diameter N.C.	Standard Shank Length	Part No.
21	1/4"	1"	26050 3
22	5/16"	1-1/8"	26053 4
23	3/8"	1-1/4"	26056 5
24	7/16"	1-3/8"	26059 6
25	1/2"	1-1/2"	26062 6
26	9/16"	1-5/8"	26065 7
27	5/8"	1-3/4"	26068 8
28	3/4"	2"	26071 8
29	7/8"	2-1/4"	26074 9
30	1"	2-1/2"	26077 0
31	1-1/8"	2-3/4"	26080 0
32	1-1/4"	3"	26083 1
34	1-1/2"	3-1/2"	26086 2



## HOT GALVANIZED

### PLAIN PATTERN - GALVANIZED

Plain Pattern No.	Bolt Diameter N.C.	Standard Shank Length	Part No.
1	1/4"	1"	26105 0
2	5/16"	1-1/8"	26108 1
3	3/8"	1-1/4"	26111 1
4	7/16"	1-3/8"	26114 2
5	1/2"	1-1/2"	26117 3
6	9/16"	1-5/8"	26120 3
7	5/8"	1-3/4"	26123 4
8	3/4"	2"	26126 5
9	7/8"	2-1/4"	26129 6
10	1"	2-1/2"	26132 6
11	1-1/8"	2-3/4"	26135 7
12	1-1/4"	3"	26138 8
14	1-1/2"	3-1/2"	26141 8

### SHOULDER PATTERN - GALVANIZED

Shoulder Pattern No.	Bolt Diameter N.C.	Standard Shank Length	Part No.
21	1/4"	1"	26155 5
22	5/16"	1-1/8"	26158 6
23	3/8"	1-1/4"	26161 6
24	7/16"	1-3/8"	26164 7
25	1/2"	1-1/2"	26167 8
26	9/16"	1-5/8"	26170 8
27	5/8"	1-3/4"	26173 9
28	3/4"	2"	26176 0
29	7/8"	2-1/4"	26179 1
30	1"	2-1/2"	26182 1
31	1-1/8"	2-3/4"	26185 2
32	1-1/4"	3"	26188 3
34	1-1/2"	3-1/2"	26191 3



# MACHINERY EYE BOLTS



Variation in quantity: on special items we reserve the right to a maximum 10% variation for allowances in manufacture.



## SPECIAL SHANK LENGTHS PLAIN PATTERN

Bolt Diameter N.C.	Special Shank Length	Threaded		Blank	
		Part No.	Weight Per 100	Part No.	Weight Per 100
1/4"	2"	11608 4	6	11008 2	8
1/4"	3"	11611 4	10	11011 2	14
5/16"	2"	11628 2	12	11028 0	14
5/16"	3"	11631 2	14	11031 0	16
5/16"	4"	11634 3	14	11034 1	18
3/8"	2"	11648 0	16	11048 8	18
3/8"	3"	11651 0	18	11051 8	23
3/8"	4"	11654 1	22	11054 9	24
3/8"	4-1/2"	11657 2	22	11057 0	26
7/16"	2"	11668 8	22	11068 6	24
7/16"	3"	11671 8	26	11071 6	30
7/16"	4"	11674 9	30	11074 7	34
7/16"	4-1/2"	11677 0	30	11077 8	36
1/2"	2"	11688 6	32	11088 4	34
1/2"	3"	11691 6	38	11091 4	42
1/2"	4"	11694 7	42	11094 5	48
1/2"	4-1/2"	11697 8	42	11097 6	50
9/16"	2"	11708 1	48	11108 9	52
9/16"	3"	11711 1	54	11111 9	60
9/16"	4"	11714 2	60	11114 0	68
9/16"	4-1/2"	11717 3	60	11117 1	68
5/8"	2"	11728 9	62	11128 7	68
5/8"	3"	11731 9	70	11131 7	74
5/8"	4"	11734 0	74	11134 8	86
5/8"	4-1/2"	11737 1	76	11137 9	90
3/4"	3"	11751 7	96	11151 5	120
3/4"	4"	11754 8	104	11154 6	126
3/4"	4-1/2"	11757 9	108	11157 7	144
3/4"	5"	11760 9	132	11160 7	154
7/8"	3"	11771 5	188	11171 3	196
7/8"	4"	11774 6	202	11174 4	218
7/8"	4-1/2"	11777 7	210	11177 5	224
7/8"	5"	11780 7	218	11180 5	230
1"	3"	11791 3	210	11191 1	232
1"	4"	11794 4	230	11194 2	254
1"	4-1/2"	11797 5	236	11197 3	264
1"	5"	11800 2	254	11200 0	276



## SPECIAL SHANK LENGTHS SHOULDER PATTERN

Bolt Diameter N.C.	Special Shank Length	Threaded		Blank	
		Part No.	Weight Per 100	Part No.	Weight Per 100
1/4"	2"	12808 7	8	12208 5	10
1/4"	3"	12811 7	10	12211 5	12
5/16"	2"	12828 5	12	12228 3	14
5/16"	3"	12831 5	14	12231 3	16
5/16"	4"	12834 6	16	12234 4	18
3/8"	2"	12848 3	20	12248 1	22
3/8"	3"	12851 3	22	12251 1	24
3/8"	4"	12854 4	24	12254 2	28
3/8"	4-1/2"	12857 5	26	12257 3	28
7/16"	2"	12868 1	26	12268 9	30
7/16"	3"	12871 1	30	12271 9	32
7/16"	4"	12874 2	34	12274 0	36
7/16"	4-1/2"	12877 3	36	12277 1	38
1/2"	2"	12888 9	40	12288 7	42
1/2"	3"	12891 9	44	12291 7	46
1/2"	4"	12894 0	46	12294 8	50
1/2"	4-1/2"	12897 1	48	12297 9	52
9/16"	2"	12908 4	48	12308 2	52
9/16"	3"	12911 4	52	12311 2	58
9/16"	4"	12914 5	58	12314 3	60
9/16"	4-1/2"	12917 6	60	12317 4	68
5/8"	2"	12928 2	74	12328 0	80
5/8"	3"	12931 2	82	12331 0	86
5/8"	4"	12934 3	90	12334 1	102
5/8"	4-1/2"	12937 4	92	12337 2	104
3/4"	3"	12951 0	116	12351 8	126
3/4"	4"	12954 1	130	12354 9	140
3/4"	4-1/2"	12957 2	132	12357 0	146
3/4"	5"	12960 2	138	12360 0	154
7/8"	3"	12971 8	186	12371 6	198
7/8"	4"	12974 9	202	12374 7	218
7/8"	4-1/2"	12977 0	208	12377 8	226
7/8"	5"	12980 0	216	12380 8	232
1"	3"	12991 6	254	12391 4	270
1"	4"	12994 7	266	12394 5	290
1"	4-1/2"	12997 8	280	12397 6	304
1"	5"	13000 4	290	12400 3	318

See page 18 for specifications and dimensions.

Additional special shank lengths available upon request.





# METRIC MACHINERY EYE BOLTS

Dimensions in Millimeters – Some Sizes Available in Stainless Steel on a Special Basis.



**FORGED • CARBON STEEL • SELF-COLORED • SHOULDER PATTERN**

Part No.	Metric Size	Approx. Equivalent in Inches	A Thread Size	B Shank Length, mm	C I.D. Eye, mm	Approx. Wt. Per 100 Pcs. in Lbs.	Working Load Limit in Kgs.	Working Load Limit in Lbs.
13805 5	M6	1/4"	M6 x 1.0	25.4	19	6	210	462
13825 3	M7	5/16"	M7 x 1.0	28.5	22	10	370	814
13845 1	M8	3/8"	M8 x 1.25	31.7	25	16	450	992
13865 9	M10	7/16"	M10 x 1.5	35.0	28	21	740	1,628
13885 7	M12	1/2"	M12 x 1.75	38.0	30	38	1,030	2,266
13905 2	M14	9/16"	M14 x 2.0	44.5	35	73	1,600	3,520
13925 0	M16	5/8"	M16 x 2.0	44.5	35	73	1,600	3,520
13948 9	M18	3/4"	M18 x 2.5	51.0	38	104	2,140	4,708
13968 7	M20	7/8"	M20 x 2.5	57.0	43	161	2,860	6,292
13988 5	M24	1"	M24 x 3.0	63.5	46	231	3,850	8,470
14008 9	M27	1-1/8"	M27 x 3.0	70.0	51	335	5,200	11,440
14031 7	M30	1-1/4"	M30 x 3.5	76.0	55	439	6,400	14,080
14051 5	M36	1-1/2"	M36 x 4.0	89.0	63	731	8,970	19,734

## DROP FORGED LIFTING EYES

Drop forged from C-1035 steel, heat treated. Available blank or threaded. Self-colored finish is standard; hot galvanized or other finishes supplied on a special basis. Used in lifting applications where larger eyes are required. When ordering prefix stock number with letter "B" (blank) or "T" (threaded) as required. Loads are based on a safety factor of 5 to 1. Working loading limits for lifting eyes are based on a straight vertical lift in a gradually increasing manner, and should never be used for angular lifts.



### LIFTING EYES – SELF-COLORED

Stock Number	Bail Size	Blank Part No.	Threaded Part No.	Threaded Working Load Limit
C-186	1/4"	15005 7	15505 2	860
C-187	5/16"	15010 1	15510 6	1260
C-185	3/8"	15015 6	15515 1	2200
C-181	1/2"	15020 0	15520 5	3600
C-184	5/8"	15025 5	15525 0	5200
C-188	3/4"	15030 9	15530 4	7000

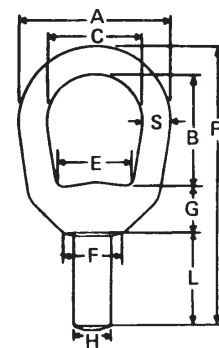

Stock Number	Shank		Dimensions – Inches								Thread Length	Weight Per 100	
	H	L	A	C	B	E	F	G	S	R		Blank	Threaded
C-186	5/16"	1"	1-1/4"	3/4"	1-1/16"	19/32"	1/2"	3/8"	1/4"	2-11/16"	7/8"	12	11
C-187	3/8"	1-1/8"	1-5/8"	1"	1-1/4"	3/4"	9/16"	1/2"	5/16"	3-3/16"	1"	22	22
C-185	1/2"	1-1/4"	2"	1-1/4"	1-1/2"	1"	13/16"	5/8"	3/8"	3-3/4"	1-1/8"	41	38
C-181	5/8"	1-1/2"	2-1/2"	1-1/2"	2"	1-3/16"	1"	11/16"	1/2"	4-11/16"	1-3/8"	81	74
C-184	3/4"	1-7/8"	3"	1-3/4"	2-3/8"	1-3/8"	1-1/8"	7/8"	5/8"	5-3/4"	1-3/4"	139	129
C-188	7/8"	2"	3-1/2"	2"	2-5/8"	1-5/8"	1-5/16"	15/16"	3/4"	6-5/16"	1-7/8"	222	214

# ALLOY STEEL SWIVEL HOIST RINGS



Chicago Hardware is proud to announce the addition of Center Pull Style Swivel Hoist Rings to its product line. This is the ideal product for angular lift applications. These Swivel Hoist Rings have full swivel and pivot action.

Our hoist rings are alloy steel with a black oxide finish. They adhere to the same rigid quality standards that have been a part of Chicago Hardware's proud tradition since 1912. Individually proof tested and magnetic particle inspected. From 800 to 24,000 lb load capacities (Rated at 5:1 safety factor).

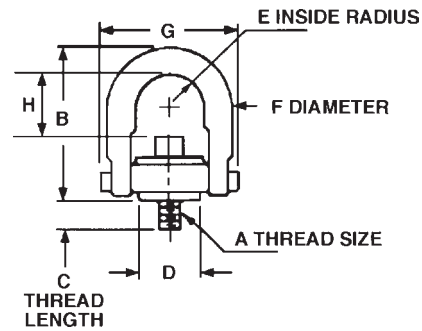

Part No.	Thread Size (A)	Working Load Limit	Thread Length (C)	B	D	E	F	G	H	Torque
86004 8	5/16"-18	800	9/16"	2.67"	0.75"	0.43"	0.38"	1.84"	1-1/4"	7
86007 9	3/8"-16	1000	9/16"	2.67"	0.75"	0.43"	0.38"	1.84"	1-1/4"	12
86013 0	1/2"-13	2500	3/4"	4.78"	1.5"	0.88"	0.75"	3.52"	2-3/8"	28
86016 1	1/2"-13	2500	1"	4.78"	1.5"	0.88"	0.75"	3.52"	2-3/8"	28
86019 2	1/2"-13	2500	1-1/4"	4.78"	1.5"	0.88"	0.75"	3.52"	2-3/8"	28
86022 2	5/8"-11	4000	1"	4.78"	1.5"	0.88"	0.75"	3.52"	2-1/4"	60
86025 3	5/8"-11	4000	1-1/4"	4.78"	1.5"	0.88"	0.75"	3.52"	2-1/4"	60
86028 4	3/4"-10	5000	1"	4.78"	1.5"	0.88"	0.75"	3.52"	2-1/8"	100
86031 4	3/4"-10	5000	1-1/2"	4.78"	1.5"	0.88"	0.75"	3.52"	2-1/8"	100
86034 5	3/4"-10	7000	1"	6.52"	2.31"	1.4"	1"	5.14"	2-15/16"	100
86037 6	3/4"-10	7000	1-1/2"	6.52"	2.31"	1.4"	1"	5.14"	2-15/16"	100
86043 7	7/8"-9	8000	1-1/4"	6.52"	2.31"	1.4"	1"	5.14"	2-13/16"	160
86046 8	1"-8	10000	1-1/4"	6.52"	2.31"	1.4"	1"	5.14"	2-11/16"	230
86049 9	1"-8	10000	1-1/2"	6.52"	2.31"	1.4"	1"	5.14"	2-11/16"	230
86052 9	1"-8	10000	2-1/4"	6.52"	2.31"	1.4"	1"	5.14"	2-11/16"	230
86055 0	1-1/4"-7	15000	1-7/8"	8.73"	3.19"	1.75"	1.25"	6.5"	4-1/4"	470
86061 1	1-1/2"-6	24000	2-3/4"	12.47"	4.19"	2.25"	1.75"	8.55"	6-1/2"	800

**WARNING: DO NOT EXCEED SAFE WORK LOAD**





# DROP FORGED HOOKS

Hooks are drop forged steel and heat treated. Latch, spring, machine screw and nut are stainless steel. These hooks are also available without the latch kit.

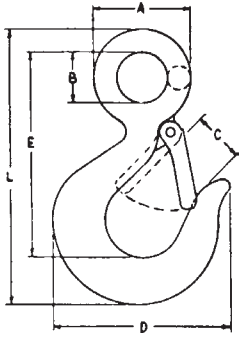

## SAFETY

Stock No.	Working Load Limit in Tons	Self-Colored	Galvanized
		Part No.	Part No.
22	3/4	22605 9	22655 4
23	1	22610 3	22660 8
24	1-1/2	22615 8	22665 3
25	2	22620 2	22670 7
26	3	22625 7	22675 2

## EYE

Stock No.	Working Load Limit in Tons	Self-Colored	Galvanized
		Part No.	Part No.
22	3/4	22705 6	22755 1
23	1	22710 0	22760 5
24	1-1/2	22715 5	22765 0
25	2	22720 9	22770 4
26	3	22725 4	22775 9

## SPECIFICATIONS

Stock Number	Dimensions – Inches						Weight Per 100	Working Load Limit (Tons)
	A	B	C	D	E	L		
22	1-1/2"	3/4"	13/16"	2-7/8"	3-1/4"	4-3/8"	59.5	3/4
23	1-3/4"	7/8"	29/32"	3-3/16"	3-23/32"	4-31/32"	87	1
24	2"	1"	27/32"	3-15/32"	4"	5-13/32"	113.5	1-1/2
25	2-1/4"	1-1/8"	1-1/8"	4-1/16"	4-5/8"	6-5/16"	169.5	2
26	2-1/2"	1-1/4"	1-5/32"	4-1/2"	4-31/32"	6-27/32"	258.5	3



## LATCH KITS

Hook		Stainless Steel
Stock No.	Working Load Limit in Tons	Part No. Per Set
22	3/4	25105 1
23	1	25105 1
24	1-1/2	25110 5
25	2	25115 0
26	3	25115 0



# DROP FORGED HIGH-TEST CHAIN HOOKS



Made in USA

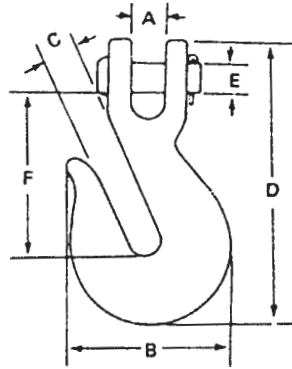

- Made for use on High-Test Chain. All hooks are heat treated. Also can be used on BBB and proof coil.
- High Test stamped on every hook.
- Available Self-Colored and Zinc Plated.

## CLEVIS GRAB HOOKS / DROP FORGED HIGH-TEST

Chain Size	Working Load Limit in Pounds	A	B	C	D	E	F	Weight Per 100 in Pounds	Self-Colored	Zinc Plated
									Part No.	Part No.
1/4"	2600	5/16"	1-15/16"	3/8"	3-3/8"	5/16"	2"	31.5	23705 5	23805 2
5/16"	4000	3/8"	2-1/4"	7/16"	3-15/16"	3/8"	2-3/8"	58.5	23710 9	23810 6
3/8"	5400	7/16"	2-11/16"	1/2"	4-1/2"	7/16"	2-11/16"	93.5	23715 4	23815 1
7/16"	7200	1/2"	3"	9/16"	5-1/32"	1/2"	3"	147	23720 8	23820 5
1/2"	9200	19/32"	3-5/16"	21/32"	5-5/8"	9/16"	3-23/64"	184	23725 3	23825 0
5/8"	11500	3/4"	4-1/4"	25/32"	6-7/8"	11/16"	4"	370	23730 7	23830 4
3/4"	16200	7/8"	5-1/4"	15/16"	8"	3/4"	4-19/32"	604	23735 2	23835 9

# DROP FORGED SAFETY SNAP HOOKS



- Hooks are drop forged steel and heat treated.
- Latch, spring, machine screw and nut are stainless steel.
- Vertical loads are based on a safety factor of 5 to 1.

Made in USA



## HEAT TREATED SAFETY SNAP HOOKS

Hook Size	Working Load Limit in Pounds	I.D. Eye	Throat Opening	Overall Length	Est. Wt. Per 100	Self-Colored	Galvanized
						Part No.	Part No.
7/16"	750 Lbs.	3/4"	3/4"	3-15/16"	28.8 Lbs.	22905 0	22955 5
9/16"	1000 Lbs.	1-1/8"	13/16"	4-3/4"	57.6 Lbs.	22910 4	22960 9





# DROP FORGED SWIVELS

Drop forged steel – all threaded components are heat treated. All swivels are hot galvanized. Jaws (jaw and eye type) supplied with flat head pin and cotter. Vertical loads are based on a safety factor of 5 to 1.

## EYE AND EYE

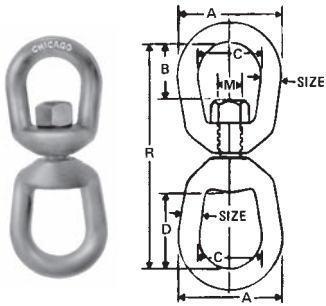

Part No.	Dimensions – Inches							Working Load Limit (Tons)	Weight Per 100
	Size	A	B	C	D	M	R		
21505 3	1/4"	1-1/4"	5/8"	3/4"	1-1/16"	5/16"	2-15/16"	.43	20.2
21510 7	5/16"	1-5/8"	3/4"	1"	1-1/4"	3/8"	3-9/16"	.63	36.5
21515 2	3/8"	2"	7/8"	1-1/4"	1-1/2"	1/2"	4-5/16"	1.1	70
21520 6	1/2"	2-1/2"	1-3/16"	1-1/2"	2"	5/8"	5-3/8"	1.8	141
21525 1	5/8"	3"	1-1/2"	1-3/4"	2-3/8"	3/4"	6-5/8"	2.6	249.5
21530 5	3/4"	3-1/2"	1-5/8"	2"	2-5/8"	7/8"	7-3/8"	3.5	413.5

## CHAIN

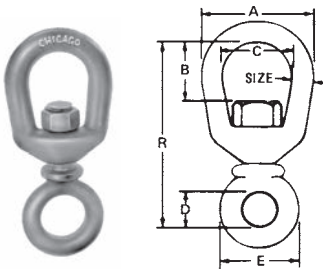

Part No.	Dimensions – Inches							Working Load Limit (Tons)	Weight Per 100
	Size	A	B	C	D	E	R		
21705 7	1/4"	1-1/4"	5/8"	3/4"	1/2"	1"	2-7/16"	.26	14
21710 1	5/16"	1-5/8"	3/4"	1"	5/8"	1-1/4"	2-15/16"	.46	27
21715 6	3/8"	2"	7/8"	1-1/4"	3/4"	1-1/2"	3-9/16"	.62	47.5
21720 0	1/2"	2-1/2"	1-1/4"	1-1/2"	1"	2"	4-9/16"	1.1	100
21725 5	5/8"	3"	1-9/16"	1-3/4"	1-1/4"	2-5/16"	5-5/8"	1.6	169
21730 9	3/4"	3-1/2"	1-3/4"	2"	1-1/2"	2-3/4"	6-1/8"	2.0	268

## JAW AND EYE

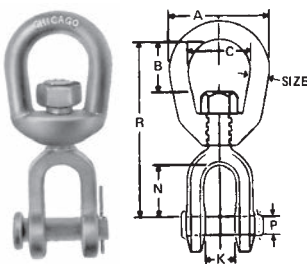

Part No.	Dimensions – Inches								Working Load Limit (Tons)	Weight Per 100
	Size	A	B	C	N	K	P	R		
21605 0	1/4"	1-1/4"	5/8"	3/4"	25/32"	15/32"	1/4"	2-1/2"	.43	18.5
21610 4	5/16"	1-5/8"	3/4"	1"	27/32"	1/2"	5/16"	2-7/8"	.63	35
21615 9	3/8"	2"	7/8"	1-1/4"	1-1/16"	5/8"	7/16"	3-1/2"	1.1	67.5
21620 3	1/2"	2-1/2"	1-1/4"	1-1/2"	1-15/32"	7/8"	1/2"	4-9/16"	1.8	131
21625 8	5/8"	3"	1-9/16"	1-3/4"	1-17/32"	1"	5/8"	5-5/16"	2.6	240
21630 2	3/4"	3-1/2"	1-3/4"	2"	1-3/4"	1-1/8"	3/4"	6"	3.5	360

## SAFETY SWIVEL HOOKS

Drop forged steel. Hook is heat treated. Latch, spring, machine screw and nut are stainless steel.

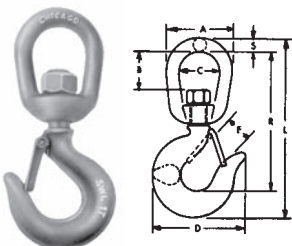

Part No.	Dimensions – Inches								Working Load Limit (Tons)	Weight Per 100
	A	B	C	D	F	L	R	S		
21905 1	2"	15/16"	1-1/4"	2-7/8"	7/8"	5-9/16"	4-15/32"	3/8"	.75	91
21910 5	2-1/2"	1-5/16"	1-1/2"	3-3/16"	31/32"	6-5/8"	5-9/32"	1/2"	1	148



# DROP FORGED PAD EYES



## DROP FORGED PAD EYES

Stock No.	Part No.	Dimensions – Inches					*Overall Height	Weight Per 100 in Lbs.
		Eye		Shoulder				
		I.D.	O.D.	O.D.	*Thickness			
C-351	22005 7	1/4"	5/8"	5/8"	3/32"	3/4"	3.3	
C-350	22010 1	3/4"	1-1/2"	1-1/16"	3/16"	1-5/8"	18.6	
C-155	22015 6	1-3/16"	2-1/16"	1-11/16"	3/16"	2-3/8"	49	
C-169	22020 0	1-1/4"	2-3/8"	2"	3/16"	2-7/8"	81	

- Forged from carbon steel suitable for welding.
- Supplied with self-colored finish.
- \*Not including draft.



# DROP FORGED EYE NUTS



Regular

Stock Eye Nuts listed below, other than Blanks, are drilled and tapped standard regardless of finish. Both types drilled only, with special tapping or finish supplied to specification. Loads are based on a safety factor of 5 to 1. Blanks are self-colored.

NOTE: Loads shown apply to Eye Nuts only, based on a vertical pull, and not to any connecting bolt or stud.

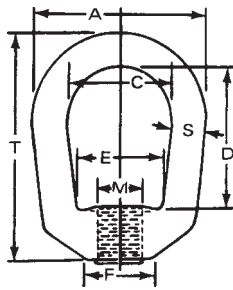

## REGULAR EYE NUTS

Stock No.	Bail Size	Tap Size	Blank	Drilled & Tapped	
			Self-Colored Part No.	Self-Colored Part No.	Hot Galvanized Part No.
C-186A	1/4"	1/4"-20	16005 6	16255 5	16755 5
C-186B	1/4"	5/16"-18	16010 0	16260 9	16760 9
C-187A	5/16"	3/8"-16	16015 5	16265 4	16765 9
C-185B	3/8"	7/16"-14	16020 9	16270 8	16770 8
C-185A	3/8"	1/2"-13	16025 4	16275 3	16775 8
C-181A	1/2"	5/8"-11	16030 8	16280 7	16780 2
C-184A	5/8"	3/4"-10	16035 3	16285 2	16785 7
C-188A	3/4"	7/8"-9	16040 7	16290 6	16790 1
C-188B	3/4"	1"-8	16045 2	16295 1	16795 6

Some sizes also available in Stainless Steel. See page 48.

## SPECIFICATIONS

Stock No.	Tap Sizes		Dimensions – Inches							Working Load Limit (Tons)	Drilled & Tapped Wgt. Per 100	Blank Wgt. Per 100
	Std. M	Max. N	A	C	D	E	F	S	T			
C-186A	1/4"-20	3/8"	1-1/4"	3/4"	1-1/16"	19/32"	1/2"	1/4"	1-11/16"	.26	8.2	9
C-186B	5/16"-18	3/8"	1-1/4"	3/4"	1-1/16"	19/32"	1/2"	1/4"	1-11/16"	.42	8	9
C-187A	3/8"-16	7/16"	1-5/8"	1"	1-1/4"	3/4"	9/16"	5/16"	2-1/16"	.62	15.7	16
C-185B	7/16"-14	1/2"	2"	1-1/4"	1-1/2"	1"	13/16"	3/8"	2-1/2"	.85	29.7	31
C-185A	1/2"-13	1/2"	2"	1-1/4"	1-1/2"	1"	13/16"	3/8"	2-1/2"	1.12	29.3	31
C-181A	5/8"-11	3/4"	2-1/2"	1-1/2"	2"	1-3/16"	1"	1/2"	3-3/16"	1.8	61.5	66
C-184A	3/4"-10	7/8"	3"	1-3/4"	2-3/8"	1-3/8"	1-1/8"	5/8"	3-7/8"	2.6	103	112
C-188A	7/8"-9	1"	3-1/2"	2"	2-5/8"	1-5/8"	1-5/16"	3/4"	4-5/16"	3.6	163	183
C-188B	1"-8	1"	3-1/2"	2"	2-5/8"	1-5/8"	1-5/16"	3/4"	4-5/16"	3.6	161	183



# DROP FORGED HEAVY DUTY EYE NUTS

Stock Eye Nuts listed below, other than Blanks, are drilled and tapped standard regardless of finish. Both types drilled only, with special tapping or finish supplied to specification. Loads are based on a safety factor of 5 to 1. Self-colored finish is standard.

NOTE: Loads shown apply to Eye Nuts only, based on a vertical pull, and not to any connecting bolt or stud.

## SELF-COLORED – BLANK OR DRILLED AND TAPPED



Stock No.	Bail Size	Blank	Drilled & Tapped	
		Part No.	Tap Size	Part No.
100	5/16"	17005 5	3/8"-16	17255 4
101	7/16"	17010 9	1/2"-13	17260 8
102	9/16"	17015 4	5/8"-11	17265 3
103	3/4"	17020 8	3/4"-10	17270 7
104	7/8"	17025 3	7/8"-9	17275 2
105	1"	17030 7	1"-8	17280 6
105A	1"	17035 2	1-1/8"-7	17285 1
106	1-1/4"	17040 6	1-1/4"-7	17290 5
107	1-3/8"	17045 1	1-1/2"-6	17295 0



Blank



Drilled & Tapped

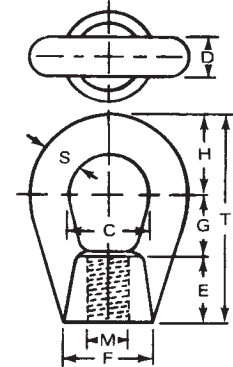

## SPECIFICATIONS

Stock No.	Dimensions – Inches									Working Load Limit (Tons)	Drilled & Tapped Wgt. Per 100	Blank Wgt. Per 100
	C	S	D	M	F	E	G	H	T			
100	7/8"	5/16"	5/16"	3/8-16"	3/4"	3/4"	3/4"	3/4"	2-1/4"	.9	15	16
101	1-1/8"	7/16"	7/16"	1/2-13"	1"	1"	1"	1"	3"	1.8	37.5	43
102	1-3/8"	9/16"	9/16"	5/8-11"	1-1/4"	1-1/4"	1-1/4"	1-1/4"	3-3/4"	2.9	82.5	94
103	1-1/2"	3/4"	3/4"	3/4-10"	1-3/4"	1-1/4"	1-1/8"	1-1/2"	3-7/8"	5.3	145	160
104	1-5/8"	7/8"	7/8"	7/8-9"	2"	1-1/4"	1"	1-11/16"	3-15/16"	7.2	202.5	210
105	1-3/4"	1"	1"	1-8"	2-1/4"	1-5/8"	1-1/4"	1-7/8"	4-3/4"	9.4	327.5	340
105A	1-3/4"	1"	1"	1-1/8-7"	2-1/4"	1-5/8"	1-1/4"	1-7/8"	4-3/4"	11.3	297	340
106	2"	1-1/4"	1-1/4"	1-1/4-7"	2-7/8"	1-7/8"	1-3/8"	2-1/4"	5-1/2"	14.7	550	623
107	2-1/2"	1-3/8"	1-3/8"	1-1/2-6"	3-1/8"	2-1/8"	1-3/4"	2-5/8"	6-1/2"	17.8	807.5	919

# CLEVIS PINS – HEAT TREATED

## SELF-COLORED OR HOT GALVANIZED



Self-Colored Part No.	Hot Galvanized Part No.	Shank Diameter	Dimensions in Inches							Weight Per 100 In Lbs.
			Lengths		Head		Hole			
			Overall	Under Head	O.D.	Thickness	I.D.	*Center		
19005 3	19105 0	1/4"	1-1/4"	1-1/8"	7/16"	1/8"	7/64"	1-1/32"	1.9	
19010 7	19110 4	5/16"	1-1/2"	1-3/8"	1/2"	1/8"	7/64"	1-1/4"	3.4	
19015 2	19115 9	3/8"	1-11/16"	1-1/2"	9/16"	3/16"	1/8"	1-11/32"	5.7	
19020 6	19120 3	7/16"	1-11/16"	1-1/2"	3/4"	3/16"	1/8"	1-23/64"	8.4	
19025 1	19125 8	7/16"	1-15/16"	1-3/4"	3/4"	3/16"	1/8"	1-5/8"	9.5	
19030 5	19130 2	1/2"	2-5/32"	1-15/16"	13/16"	7/32"	1/8"	1-13/16"	13.3	
19035 0	19135 7	5/8"	2-17/32"	2-5/16"	1-1/32"	7/32"	5/32"	2-5/32"	24	
19040 4	19140 1	3/4"	3"	2-3/4"	1-3/16"	1/4"	3/16"	2-9/16"	40	
19045 9	19145 6	7/8"	3-1/2"	3-1/4"	1-1/4"	1/4"	13/64"	3"	62	
19050 3	19150 0	1"	4-5/32"	3-25/32"	1-7/16"	3/8"	13/64"	3-17/32"	96	
19055 8	19155 5	1-1/8"	4-5/8"	4-1/4"	1-5/8"	3/8"	13/64"	3-15/16"	134	

\*From under head

# DROP FORGED BLANK ROD ENDS



Drop forged. Listed diameters and lengths carried in stock blank, self-colored. Drilling, threading, other machining and plating furnished to specification.

NOTE: Average properties of 1035 natural hot rolled steel 75/85,000 lbs. P.S.I. tensile, 40/55,000 lbs. P.S.I. yield.

## DROP FORGED BLANK ROD ENDS

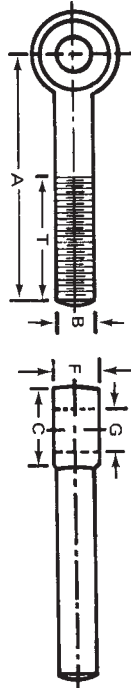

Some sizes also available in Stainless Steel. See page 48.

Stock No.	Part No.	Dimensions – Inches				Weight Per 100
		Shank Diameter (B)	Boss Diameter (C)	Boss Thickness (F)	*Length (A) in Inches	
C-134	18005 4	1/4"	1/2"	9/32"	3"	6.1
C-134-A	18010 8	1/4"	1/2"	9/32"	6"	11
C-135	18015 3	5/16"	5/8"	11/32"	3"	9.5
C-135-A	18020 7	5/16"	5/8"	11/32"	6"	18
C-163-A	18025 2	3/8"	11/16"	3/8"	2-1/8"	12
C-162	18030 6	3/8"	3/4"	3/8"	2-1/2"	12.5
C-217	18035 1	3/8"	3/4"	7/16"	3"	14
C-136	18040 5	3/8"	3/4"	7/16"	6"	25.5
C-137	18045 0	7/16"	7/8"	1/2"	6"	35
C-245	18050 4	1/2"	15/16"	9/16"	1-3/4"	22
C-163	18055 9	1/2"	15/16"	9/16"	3-1/8"	27.5
C-212	18060 3	1/2"	1"	9/16"	3-1/2"	30
C-138	18065 8	1/2"	1"	9/16"	6"	47
C-195	18070 2	1/2"	1"	9/16"	10"	70
C-189	18075 7	5/8"	1-1/4"	11/16"	3"	45.5
C-303	18080 1	5/8"	1-3/16"	5/8"	3-1/2"	48
C-139	18085 6	5/8"	1-1/4"	11/16"	6"	77.5
C-172	18090 0	5/8"	1-1/4"	11/16"	8"	92
C-196	18095 5	5/8"	1-1/4"	11/16"	10"	119
C-216	18100 6	3/4"	1-1/2"	13/16"	3-1/2"	82
C-140	18105 1	3/4"	1-1/2"	13/16"	6"	112
C-197	18110 5	3/4"	1-1/2"	13/16"	10"	163.5
C-141	18115 0	7/8"	1-3/4"	15/16"	6"	164
C-211	18120 4	7/8"	1-3/4"	15/16"	12"	377
C-142	18125 9	1"	2"	1-1/16"	6"	216
C-142-A	18130 3	1"	2"	1-1/16"	12"	354
C-282	18135 8	1-1/4"	2-1/2"	1-5/16"	12"	595

# BLACK OXIDE MACHINED ROD ENDS

(MADE IN USA)

Part No.	Thread Pitch	Dimensions – Inches					Weight Per 100
		Length in Inches (A)*	Thread Length (T)	Hole I.D. (G)	Boss Diameter (C)	Boss Thickness (F)	
18205 8	1/4"-20	2"	3/4"	3/16"	1/2"	9/32"	4
18210 2	5/16"-18	3"	1-1/2"	5/16"	5/8"	11/32"	8
18215 7	3/8"-16	3"	1-1/2"	5/16"	3/4"	7/16"	12
18220 1	3/8"-16	3"	1-1/2"	3/8"	3/4"	7/16"	12
18225 6	3/8"-16	3-3/4"	2"	3/8"	3/4"	7/16"	14
18230 0	3/8"-16	4"	1-1/2"	3/8"	3/4"	7/16"	16
18235 5	3/8"-16	5"	2-1/2"	3/8"	3/4"	7/16"	18
18245 4	1/2"-13	3-3/4"	1-1/2"	3/8"	1"	9/16"	29
18250 8	1/2"-13	4"	1-1/2"	3/8"	1"	9/16"	30
18240 9	1/2"-13	5"	1-1/2"	3/8"	1"	9/16"	36
18255 3	1/2"-13	5"	2"	3/8"	1"	9/16"	36
18260 7	5/8"-11	4-1/2"	2"	5/8"	1-1/4"	11/16"	50
18265 2	5/8"-11	5"	1-3/4"	5/8"	1-1/4"	11/16"	55
18270 6	5/8"-11	6"	2-1/2"	5/8"	1-1/4"	11/16"	63
18280 5	3/4"-10	4-1/2"	2"	3/4"	1-1/2"	13/16"	77
18275 1	3/4"-10	6"	2-1/2"	3/4"	1-1/2"	13/16"	95

\* Measured from center of boss



# DROP FORGED YOKE ENDS

## SELF-COLORED DROP FORGED YOKE ENDS

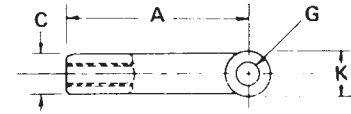
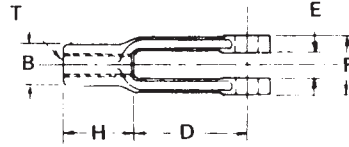
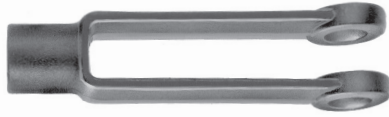

### ADJUSTABLE

Stock No.	Part No.	"T" Tap Size	Dimensions in Inches – Machined									Est. Wt. Per 100 Pcs.
			A	B	C	D	E	F	G	H	K	
51	19505 8	1/4"-28	2"	7/16"	7/16"	1-1/4"	9/32"	5/8"	1/4"	3/4"	1/2"	7.5 Lbs.
52	19510 2	5/16"-24	2-1/4"	1/2"	1/2"	1-7/16"	11/32"	3/4"	5/16"	13/16"	19/32"	10.7 Lbs.
53	19515 7	3/8"-24	2-1/2"	5/8"	5/8"	1-5/8"	7/16"	7/8"	3/8"	7/8"	11/16"	16 Lbs.
54	19520 1	7/16"-20	2-7/8"	23/32"	23/32"	1-7/8"	1/2"	1"	7/16"	1"	13/16"	24 Lbs.
55	19525 6	1/2"-20	3"	13/16"	13/16"	1-7/8"	9/16"	1-1/8"	1/2"	1-1/8"	15/16"	32.2 Lbs.
56	19530 0	5/8"-18	4-15/16"	1-1/16"	1-1/16"	3-11/16"	11/16"	1-3/8"	5/8"	1-1/4"	1-3/16"	80 Lbs.
57	19535 5	3/4"-16	6-1/16"	1-1/4"	1-1/4"	4-9/16"	13/16"	1-5/8"	3/4"	1-1/2"	1-7/16"	135 Lbs.

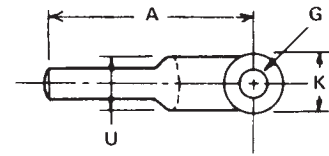
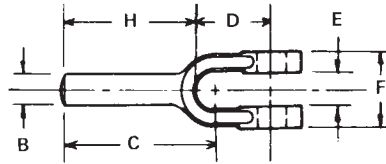
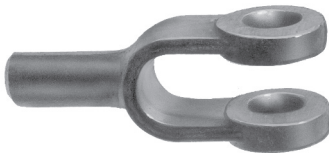

### PLAIN TYPE

Stock No.	Part No.	Dimensions in Inches – Machined										Est. Wt. Per 100 Pcs.
		A	B	C	D	E	F	G	H	K	U	
61	19705 2	1-3/4"	1/4"	1-19/32"	5/8"	9/32"	5/8"	1/4"	1-1/8"	1/2"	7/16"	4.7 Lbs.
62	19710 6	2"	5/16"	1-7/16"	3/4"	11/32"	3/4"	5/16"	1-1/4"	19/32"	1/2"	7.8 Lbs.
63	19715 1	2-1/8"	3/8"	1-33/64"	27/32"	7/16"	7/8"	3/8"	1-9/32"	11/16"	5/8"	11.1 Lbs.
64	19720 5	2-1/4"	7/16"	1-57/64"	1"	1/2"	1"	7/16"	1-1/4"	13/16"	23/32"	15.1 Lbs.
65	19725 0	2-1/2"	1/2"	1-11/16"	1-1/8"	9/16"	1-1/8"	1/2"	1-3/8"	15/16"	13/16"	23.1 Lbs.
66	19730 4	2-7/8"	5/8"	1-53/64"	1-7/16"	11/16"	1-3/8"	5/8"	1-7/16"	1-3/16"	1-1/16"	43 Lbs.
67	19735 9	3-5/8"	3/4"	2-25/64"	1-11/16"	13/16"	1-5/8"	3/4"	1-15/16"	1-7/16"	1-1/8"	75 Lbs.

## SELF-COLORED SAE CLEVIS PINS FOR YOKE ENDS



Part No.	Shank Diameter	Dimensions in Inches – Machined						Weight Per 100 in Lbs.
		Lengths		Head		Hole		
		Overall	Under Head	O.D.	Thickness	I.D.	*Center	
19305 4	1/4"	55/64"	49/64"	3/8"	3/32"	5/64"	43/64"	1.3
19310 8	5/16"	1-1/32"	15/16"	7/16"	3/32"	7/64"	13/16"	2.3
19315 3	3/8"	1-3/16"	1-1/16"	1/2"	1/8"	7/64"	15/16"	3.7
19320 7	7/16"	1-11/32"	1-3/16"	9/16"	5/32"	7/64"	1-1/16"	5.9
19330 6	1/2"	1-33/64"	1-23/64"	5/8"	5/32"	9/64"	1-13/64"	8.6
19335 1	5/8"	1-13/16"	1-39/64"	13/16"	13/64"	9/64"	1-29/64"	16.2
19340 5	3/4"	2-5/32"	1-29/32"	15/16"	1/4"	11/64"	1-23/32"	27.5

\*From under head

Produced from 1018 cold heading quality wire.





# MALLEABLE BEVEL WASHERS



Bevelled 2" in 12" which is standard for flanges of beams and channels. Available in self-colored or hot galvanized finish.

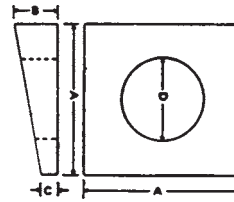

## MALLEABLE BEVEL WASHERS

Bolt Diameter	Black Part No.	Hot Galvanized Part No.	Dimensions – Inches				Weight Per 100 (Lbs.)
			A	B	C	D	
1/4"	06305 0	06355 5	11/16"	7/32"	5/64"	5/16"	2
5/16"	06308 1	06358 6	1"	5/16"	9/64"	3/8"	6
3/8"	06311 1	06361 6	1-1/4"	11/32"	5/32"	7/16"	9.3
1/2"	06314 2	06364 7	1-1/4"	11/32"	5/32"	9/16"	8.8
5/8"	06317 3	06367 8	1-1/2"	13/32"	5/32"	11/16"	12.4
3/4"	06320 3	06370 8	1-1/2"	15/32"	7/32"	13/16"	15
7/8"	06323 4	06373 9	2"	9/16"	7/32"	15/16"	34
1"	06326 5	06376 0	2"	9/16"	7/32"	1-3/32"	31.5
1-1/8"	06329 6	06379 1	2-1/4"	5/8"	9/32"	1-3/16"	43.5
1-1/4"	06332 6	06382 1	2-1/4"	23/32"	5/16"	1-11/32"	68.5



# ZINC PLATED S-HOOKS



### WARNING:

Any deviations such as angular lifts, shock loads, modification of the "S" hook will result in drastically reduced working load limits.

## ZINC PLATED S-HOOKS

Low carbon cold drawn steel wire. Supplied with blunt ends and zinc plated finish. Standard Pack – 50 pieces. Other rust preventive coatings and self-colored (black) available on a special basis. "S" Hooks also manufactured to specifications.

Stock No.	Part No.	Dimensions – Inches				Weight Per 100 (Lbs.)	Working Load Limit (Lbs.)
		Wire Diameter	Overall Length	Hooks Inside Dia.	Opening Hooks		
S-1	06105 6	.080"	3/4"	1/4"	1/8"	.26	7
S-1A	06108 7	.105"	1"	5/16"	5/32"	.55	16
S-2	06111 7	.114"	1-1/4"	3/8"	3/16"	.83	17
S-2A	06114 8	.148"	1-1/2"	7/16"	7/32"	1.62	26
S-3	06117 9	.186"	1-3/4"	1/2"	1/4"	2.97	40
S-4	06120 9	.220"	2-1/8"	5/8"	5/16"	5.15	58
S-5	06123 0	.250"	2-1/2"	3/4"	7/16"	7.5	70
S-6	06126 1	.312"	3"	7/8"	1/2"	13.9	132
S-7	06129 2	.375"	3-1/2"	1"	1/2"	23.44	170

Some sizes available in stainless steel. See page 49.



# ROUND BEND U-BOLTS

Round Bend U-Bolts for Steel or Wrought Iron pipe sizes 1/4"-18" inclusive, as listed on this and next pages, are produced from low carbon steel and supplied with NC rolled threads and two (2) hex nuts. In addition, U-Bolt plate is available if required.



Standard Pack:  
10 Pieces

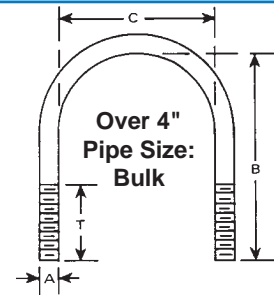

**ZINC PLATED**

Some sizes also available in Stainless Steel. See page 50.

U-Bolt Dimensions – Inches				For Pipe Size	U-Bolts & 2 Nuts			U-Bolts, Plates & 2 Nuts		
Diameter & Thread (A)	I.D. (C)	Inside Length (B)	Thread Length (T)		Stock No.	Part No.	Weight Per 100	Stock No.	Part No.	Weight Per 100
1/4"-20	9/16"	1-1/4"	3/4"	1/4"	01	50005 0	5	1	50205 4	7
1/4"-20	3/4"	1-1/4"	5/8"	3/8"	02	50008 1	5	2	50208 5	7
1/4"-20	3/4"	2-1/4"	1-1/2"	3/8"	03	50011 1	7	3	50211 5	9
1/4"-20	1"	1-3/4"	1"	1/2"	04	50014 2	7	4	50214 6	9
1/4"-20	1"	2-3/4"	1-1/4"	1/2"	04L	50017 3	8	4L	50217 7	11
1/4"-20	1-1/8"	2"	1"	3/4"	05	50020 3	7	5	50220 7	9
1/4"-20	1-1/8"	3-1/8"	1-1/2"	3/4"	05L	50023 4	9	5L	50223 8	12
1/4"-20	1-1/4"	2-1/4"	1-1/4"	3/4"	06	50026 5	7.5	6	50226 9	10
1/4"-20	1-1/2"	2-3/4"	1-3/8"	1"	07	50029 6	9	7	50229 0	12
1/4"-20	1-3/4"	3"	1-3/8"	1-1/4"	08	50032 6	9	8	50232 0	12
1/4"-20	2"	3-1/4"	1-3/8"	1-1/2"	09	50035 7	9.5	9	50235 1	14
5/16"-18	1"	2-3/16"	1-3/8"	1/2"	010	50038 8	11	10	50238 2	14
5/16"-18	1-1/8"	2-3/16"	1"	3/4"	0101	50041 8	12	101	50241 2	14.5
5/16"-18	1-3/8"	2-3/16"	1"	1"	011	50044 9	12	11	50244 3	15
5/16"-18	1-3/8"	3-5/8"	2"	1"	011L	50047 0	16	11L	50247 4	20
5/16"-18	1-1/2"	2-3/16"	1"	1"	012	50050 0	12	12	50250 4	15
5/16"-18	1-3/4"	2-11/16"	1-1/8"	1-1/4"	013	50053 1	13	13	50253 5	17.5
5/16"-18	1-3/4"	4-1/2"	2"	1-1/4"	013L	50056 2	19	13L	50256 6	24
5/16"-18	2"	2-11/16"	1"	1-1/2"	014	50059 3	14	14	50259 7	19
5/16"-18	2"	4-3/4"	3"	1-1/2"	014L	50062 3	20	14L	50262 7	25
5/16"-18	2-1/2"	3-3/16"	1"	2"	015	50065 4	16	15	50265 8	21
5/16"-18	2-1/2"	5-5/8"	3"	2"	015L	50068 5	23	15L	50268 9	29
5/16"-18	3"	3-11/16"	1"	2-1/2"	016	50071 5	18	16	50271 9	24
3/8"-16	1"	2-1/4"	1-1/4"	1/2"	017	50074 6	17.5	17	50274 0	22.5
3/8"-16	1-1/4"	2-1/4"	1-1/4"	3/4"	018	50077 7	18	18	50277 1	24
3/8"-16	1-1/2"	2-1/2"	1-1/4"	1"	019	50080 7	18.5	19	50280 1	26
3/8"-16	1-3/4"	2-3/4"	1-1/8"	1-1/4"	020	50083 8	20	20	50283 2	27.5
3/8"-16	2"	2-5/8"	1-1/4"	1-1/2"	021	50086 9	20	21	50286 3	29
3/8"-16	2-1/2"	3-1/8"	1-1/4"	2"	022	50089 0	24.5	22	50289 4	33
3/8"-16	3"	3-5/8"	1-1/4"	2-1/2"	023	50092 0	26	23	50292 4	38
3/8"-16	3"	6-5/8"	3"	2-1/2"	023L	50095 1	41	23L	50295 5	52.5
3/8"-16	3-1/2"	4-1/8"	1-1/4"	3"	024	50098 2	30	24	50298 6	42.5
1/2"-13	3"	4-1/2"	1-5/8"	2-1/2"	025	50101 9	59	25	50301 3	71
1/2"-13	3-1/2"	5"	1-1/2"	3"	026	50104 0	64	26	50304 4	78
1/2"-13	3-1/2"	8-1/2"	3"	3"	026L	50107 1	95	26L	50307 5	110
1/2"-13	4"	5-1/2"	1-1/2"	3-1/2"	027	50110 1	70	27	50310 5	87
1/2"-13	4-1/2"	6"	1-1/2"	4"	028	50113 2	75	28	50313 6	92.5
1/2"-13	5-5/8"	7-1/4"	2"	5"	029	50116 3	90	N.A.	N.A.	N.A.
1/2"-13	6-3/4"	8-3/8"	2"	6"	030	50119 4	101	N.A.	N.A.	N.A.
1/2"-13	8-3/4"	10-3/8"	2"	8"	031	50122 4	120	N.A.	N.A.	N.A.
*3/4"-10	10-7/8"	13-13/16"	4"	10"	032	50125 5	440	N.A.	N.A.	N.A.
*7/8"-9	12-7/8"	16-1/16"	4-1/4"	12"	033	50128 6	710	N.A.	N.A.	N.A.
*7/8"-9	14-1/8"	17-5/16"	4-1/4"	14"	034	50131 6	755	N.A.	N.A.	N.A.
*7/8"-9	16-1/8"	19-5/16"	4-1/4"	16"	035	50134 7	850	N.A.	N.A.	N.A.
*1"-8	18-1/8"	21-11/16"	4-3/4"	18"	036	50137 8	1245	N.A.	N.A.	N.A.

\*Full Stock Diameter with Cut Thread. See page 34 for dimensions of steel pipe.

# ROUND BEND U-BOLTS



Zinc plated and hot galvanized finishes are standard. Other types of rust preventative coatings or self-colored (black) available on a special basis. Round, Square or "V" type U-Bolts to 1" diameter manufactured to specifications in both ferrous and non-ferrous metals.



Stock numbers followed by "L" denote long length u-bolts designed for use in applications requiring longer tangents.

See additional specifications and dimensions on the next page.

## HOT GALVANIZED

Some sizes also available in Stainless Steel. See page 50.

U-Bolt Dimensions – Inches				For Pipe Size	U-Bolts & 2 Nuts			U-Bolts, Plates & 2 Nuts		
Diameter & Thread (A)	I.D. (C)	Inside Length (B)	Thread Length (T)		Stock No.	Part No.	Weight Per 100	Stock No.	Part No.	Weight Per 100
1/4"-20	9/16"	1-1/4"	3/4"	1/4"	01HG	53005 7	5	1HG	53605 9	7
1/4"-20	3/4"	1-1/4"	5/8"	3/8"	02HG	53008 8	5	2HG	53608 0	7
1/4"-20	3/4"	2-1/4"	1-1/2"	3/8"	03HG	53011 8	7	3HG	53611 0	9
1/4"-20	1"	1-3/4"	1"	1/2"	04HG	53014 9	7	4HG	53614 1	9
1/4"-20	1"	2-3/4"	1-1/4"	1/2"	04LHG	53017 0	8	4LHG	53617 2	11
1/4"-20	1-1/8"	2"	1"	3/4"	05HG	53020 0	7	5HG	53620 2	9
1/4"-20	1-1/8"	3-1/8"	1-1/2"	3/4"	05LHG	53023 1	9	5LHG	53623 3	12
1/4"-20	1-1/4"	2-1/4"	1-1/4"	3/4"	06HG	53026 2	7.5	6HG	53626 4	10
1/4"-20	1-1/2"	2-3/4"	1-3/8"	1"	07HG	53029 3	9	7HG	53629 5	12
1/4"-20	1-3/4"	3"	1-3/8"	1-1/4"	08HG	53032 3	9	8HG	53632 5	12
1/4"-20	2"	3-1/4"	1-3/8"	1-1/2"	09HG	53035 4	9.5	9HG	53635 6	14
5/16"-18	1"	2-3/16"	1-3/8"	1/2"	010HG	53038 5	11	10HG	53638 7	14
5/16"-18	1-1/8"	2-3/16"	1"	3/4"	0101HG	53041 5	12	101HG	53641 7	14.5
5/16"-18	1-3/8"	2-3/16"	1"	1"	011HG	53044 6	12	11HG	53644 8	15
5/16"-18	1-3/8"	3-5/8"	2"	1"	011LHG	53047 7	16	11LHG	53647 9	20
5/16"-18	1-1/2"	2-3/16"	1"	1"	012HG	53050 7	12	12HG	53650 9	15
5/16"-18	1-3/4"	2-11/16"	1-1/8"	1-1/4"	013HG	53053 8	13	13HG	53653 0	17.5
5/16"-18	1-3/4"	4-1/2"	2"	1-1/4"	013LHG	53056 9	19	13LHG	53656 1	24
5/16"-18	2"	2-11/16"	1"	1-1/2"	014HG	53059 0	14	14HG	53659 2	19
5/16"-18	2"	4-3/4"	3"	1-1/2"	014LHG	53062 0	20	14LHG	53662 2	25
5/16"-18	2-1/2"	3-3/16"	1"	2"	015HG	53065 1	16	15HG	53665 3	21
5/16"-18	2-1/2"	5-5/8"	3"	2"	015LHG	53068 2	23	15LHG	53668 4	29
5/16"-18	3"	3-11/16"	1"	2-1/2"	016HG	53071 2	18	16HG	53671 4	24
3/8"-16	1"	2-1/4"	1-1/4"	1/2"	017HG	53074 3	17.5	17HG	53674 5	22.5
3/8"-16	1-1/4"	2-1/4"	1-1/4"	3/4"	018HG	53077 4	18	18HG	53677 6	24
3/8"-16	1-1/2"	2-1/2"	1-1/4"	1"	019HG	53080 4	18.5	19HG	53680 6	26
3/8"-16	1-3/4"	2-3/4"	1-1/8"	1-1/4"	020HG	53083 5	20	20HG	53683 7	27.5
3/8"-16	2"	2-5/8"	1-1/4"	1-1/2"	021HG	53086 6	20	21HG	53686 8	29
3/8"-16	2-1/2"	3-1/8"	1-1/4"	2"	022HG	53089 7	24.5	22HG	53689 9	33
3/8"-16	3"	3-5/8"	1-1/4"	2-1/2"	023HG	53092 7	26	23HG	53692 9	38
3/8"-16	3"	6-5/8"	3"	2-1/2"	023LHG	53095 8	41	23LHG	53695 0	52.5
3/8"-16	3-1/2"	4-1/8"	1-1/4"	3"	024HG	53098 9	30	24HG	53698 1	42.5
1/2"-13	3"	4-1/2"	1-5/8"	2-1/2"	025HG	53101 6	59	25HG	53701 8	71
1/2"-13	3-1/2"	5"	1-1/2"	3"	026HG	53104 7	64	26HG	53704 9	78
1/2"-13	3-1/2"	8-1/2"	3"	3"	026LHG	53107 8	95	26LHG	53707 0	110
1/2"-13	4"	5-1/2"	1-1/2"	3-1/2"	027HG	53110 8	70	27HG	53710 0	87
1/2"-13	4-1/2"	6"	1-1/2"	4"	028HG	53113 9	75	28HG	53713 1	92.5
1/2"-13	5-5/8"	7-1/4"	2"	5"	029HG	53116 0	90	N.A.	N.A.	N.A.
1/2"-13	6-3/4"	8-3/8"	2"	6"	030HG	53119 1	101	N.A.	N.A.	N.A.
1/2"-13	8-3/4"	10-3/8"	2"	8"	031HG	53122 1	120	N.A.	N.A.	N.A.
*3/4"-10	10-7/8"	13-13/16"	4"	10"	032HG	53125 2	440	N.A.	N.A.	N.A.
*7/8"-9	12-7/8"	16-1/16"	4-1/4"	12"	033HG	53128 3	710	N.A.	N.A.	N.A.
*7/8"-9	14-1/8"	17-5/16"	4-1/4"	14"	034HG	53131 3	755	N.A.	N.A.	N.A.
*7/8"-9	16-1/8"	19-5/16"	4-1/4"	16"	035HG	53134 4	850	N.A.	N.A.	N.A.
*1"-8	18-1/8"	21-11/16"	4-3/4"	18"	036HG	53137 5	1245	N.A.	N.A.	N.A.

\*Full Stock Diameter with Cut Thread



# ROUND BEND U-BOLTS



## ALUMINUM

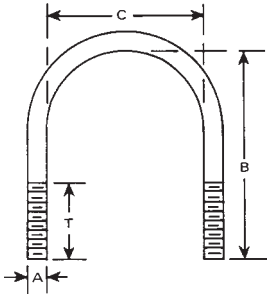

U-Bolt Dimensions – Inches				For Pipe Size	U-Bolts & 2 Nuts		
Diameter & Thread (A)	I.D. (C)	Inside Length (B)	Thread Length (T)		Stock No.	Part No.	Weight Per 100
1/4"-20	3/4"	1-1/4"	5/8"	3/8"	02AL	60008 8	1.5
1/4"-20	1"	1-3/4"	1"	1/2"	04AL	60014 9	2
1/4"-20	1-1/8"	2"	1"	3/4"	05AL	60020 0	2
1/4"-20	1-1/2"	2-3/4"	1-3/8"	1"	07AL	60029 3	3.5
1/4"-20	1-3/4"	3"	1-3/8"	1-1/4"	08AL	60032 3	4
1/4"-20	2"	3-1/4"	1-3/8"	1-1/2"	09AL	60035 4	4
5/16"-18	1-3/8"	2-3/16"	1"	1"	011AL	60044 6	5
5/16"-18	2"	2-11/16"	1"	1-1/2"	014AL	60059 0	5.2
5/16"-18	2-1/2"	3-3/16"	1"	2"	015AL	60065 1	5.5
3/8"-16	1-1/2"	2-1/2"	1-1/4"	1"	019AL	60080 4	6.5
3/8"-16	2"	2-5/8"	1-1/4"	1-1/2"	021AL	60086 6	7
3/8"-16	2-1/2"	3-1/8"	1-1/4"	2"	022AL	60089 7	7.1
3/8"-16	3-1/2"	4-1/8"	1-1/4"	3"	024AL	60098 9	10.5
1/2"-13	3-1/2"	5"	1-1/2"	3"	026AL	60104 7	22.5
1/2"-13	4-1/2"	6"	1-1/2"	4"	028AL	60113 9	27
1/2"-13	6-3/4"	8-3/8"	2"	6"	030AL	60119 1	36

\*Full Stock Diameter with Cut Thread

## DIMENSIONS OF WELDED AND SEAMLESS STEEL PIPE

Pipe Size	Outside Diameter
1/4"	.540"
3/8"	.675"
1/2"	.840"
3/4"	1.05"
1"	1.315"
1-1/4"	1.66"
1-1/2"	1.90"
2"	2.375"
2-1/2"	2.875"
3"	3.500"
3-1/2"	4.000"
4"	4.500"
5"	5.563"
6"	6.625"
8"	8.625"
10"	10.750"
12"	12.750"
14"	14.000"
16"	16.000"
18"	18.000"

Some sizes also available in Stainless Steel. See page 50.



## U-BOLT PLATES

U-Bolt plates are low carbon cold rolled steel with rounded edges and zinc plated or hot galvanized finish. Plate holes are punched "on centers" of corresponding size U-Bolt and identified by stock numbers.

Dimensions – Inches		
For U-Bolt Diameter	Gauge	Width
1/4" and 5/16"	.078"	.750"
3/8" and 1/2"	.109"	1.000"

# ROUND BEND LONG TANGENT U-BOLTS



## ZINC PLATED U-BOLTS WITH 4 NUTS

Stock No.	Part No.	Pipe Size	A Diameter	C Inside Width	B Inside Length	T Thread Length	Weight Per 100	
							U-Bolt Only	U-Bolt & 4 Nuts
LT-B	51460 6	1/2"	1/4"-20	7/8"	2-15/16"	2-1/2"	6	9
LT-C	51465 1	3/4"	1/4"-20	1-1/8"	3-3/16"	2-1/2"	7	10
LT-D	51470 5	1"	1/4"-20	1-3/8"	3-7/16"	2-1/2"	8	11
LT-1	51505 4	1/2"	3/8"-16	15/16"	3"	2-3/8"	17.5	24
LT-2	51510 8	3/4"	3/8"-16	1-1/8"	3-5/16"	2-3/8"	19	25.5
LT-3	51515 3	1"	3/8"-16	1-3/8"	3-7/16"	2-3/8"	20	26.5
LT-4	51520 7	1-1/4"	3/8"-16	1-11/16"	3-23/32"	2-3/8"	21.5	28
LT-5	51525 2	1-1/2"	3/8"-16	2"	4"	2-1/2"	23.5	30
LT-6	51530 6	2"	3/8"-16	2-7/16"	4-7/16"	2-1/2"	26.5	33
LT-7	51535 1	2-1/2"	1/2"-13	2-15/16"	5-7/32"	3"	57	71
LT-8	51540 5	3"	1/2"-13	3-9/16"	5-3/4"	3"	62	77
LT-9	51545 0	3-1/2"	1/2"-13	4-1/16"	6-1/4"	3"	68	82
LT-10	51550 4	4"	1/2"-13	4-9/16"	6-3/4"	3"	74	89
LT-11	51555 9	5"	1/2"-13	5-5/8"	7-13/16"	3"	86	101
LT-12	51560 3	6"	5/8"-11	6-3/4"	9-1/2"	3-3/4"	167	194.5
LT-13	51565 8	8"	5/8"-11	8-3/4"	11-1/8"	3-3/4"	196	223.5
LT-14	51570 2	10"	3/4"-10	10-7/8"	13-13/16"	4"	440	460



Zinc Plated

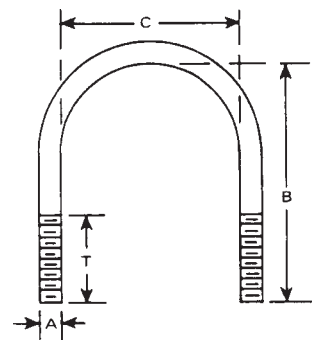

## HOT GALVANIZED U-BOLTS WITH 4 NUTS

Stock No.	Part No.	Pipe Size	A Diameter	C Inside Width	B Inside Length	T Thread Length	Weight Per 100	
							U-Bolt Only	U-Bolt & 4 Nuts
LT-BHG	53165 8	1/2"	1/4"-20	7/8"	2-15/16"	2-1/2"	7	9
LT-CHG	53175 7	3/4"	1/4"-20	1-1/8"	3-3/16"	2-1/2"	8	10
LT-DHG	53180 1	1"	1/4"-20	1-3/8"	3-7/16"	2-1/2"	9	11
LT-1 HG	53205 1	1/2"	3/8"-16	15/16"	3"	2-3/8"	17.5	24
LT-2 HG	53210 5	3/4"	3/8"-16	1-1/8"	3-5/16"	2-3/8"	19	25.5
LT-3 HG	53215 0	1"	3/8"-16	1-3/8"	3-7/16"	2-3/8"	20	26.5
LT-4 HG	53220 4	1-1/4"	3/8"-16	1-11/16"	3-23/32"	2-3/8"	21.5	28
LT-5 HG	53225 9	1-1/2"	3/8"-16	2"	4"	2-1/2"	23.5	30
LT-6 HG	53230 3	2"	3/8"-16	2-7/16"	4-7/16"	2-1/2"	26.5	33
LT-7 HG	53235 8	2-1/2"	1/2"-13	2-15/16"	5-7/32"	3"	57	71
LT-8 HG	53240 2	3"	1/2"-13	3-9/16"	5-3/4"	3"	62	77
LT-9 HG	53245 7	3-1/2"	1/2"-13	4-1/16"	6-1/4"	3"	68	82
LT-10 HG	53250 1	4"	1/2"-13	4-9/16"	6-3/4"	3"	74	89
LT-11 HG	53255 6	5"	1/2"-13	5-5/8"	7-13/16"	3"	86	101
LT-12 HG	53260 0	6"	5/8"-11	6-3/4"	9-1/2"	3-3/4"	167	194.5
LT-13 HG	53265 5	8"	5/8"-11	8-3/4"	11-1/8"	3-3/4"	196	223.5
LT-14 HG	53270 9	10"	3/4"-10	10-7/8"	13-13/16"	4"	440	460



Hot Galvanized

Some sizes also available in Stainless Steel. See page 51.







# SQUARE BEND U-BOLTS

Furnished with 3/8" nuts and flat washers.

## ZINC PLATED U-BOLTS WITH 2 NUTS AND 2 WASHERS



Zinc Plated

Stock No.	Part No.	A Diameter	C Inside Width	B Overall Length	T Thread Length	Weight Per 100	
						U-Bolt Only	U-Bolt & 4 Nuts
SB-1	51005 9	3/8"-16	2"	3"	1-1/2"	19	25.5
SB-2	51010 3	3/8"-16	2"	5"	3"	29	35.5
SB-3	51015 8	3/8"-16	2"	7"	3-3/4"	38.5	44.5
SB-4	51020 2	3/8"-16	4"	3"	1-1/2"	23.5	29.5
SB-5	51025 7	3/8"-16	4"	5"	3"	33.5	40
SB-6	51030 1	3/8"-16	4"	7"	3-3/4"	43.5	49.5
SB-7	51035 6	3/8"-16	6"	5"	3"	38.5	44.5
SB-8	51040 0	3/8"-16	6"	7"	3-3/4"	48	56
SB-9	51045 5	3/8"-16	6"	9"	5-5/8"	57	63

Also available in Stainless Steel. See page 51.



## HOT GALVANIZED U-BOLTS WITH 2 NUTS AND 2 WASHERS

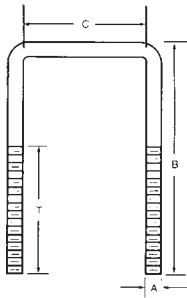

Stock No.	Part No.	A Diameter	C Inside Width	B Overall Length	T Thread Length	Weight Per 100	
						U-Bolt Only	U-Bolt & 4 Nuts
SB-1HG	53405 5	3/8"-16	2"	3"	1-1/2"	19	25.5
SB-2HG	53410 9	3/8"-16	2"	5"	3"	29	35.5
SB-3HG	53415 4	3/8"-16	2"	7"	3-3/4"	38.5	44.5
SB-4HG	53420 8	3/8"-16	4"	3"	1-1/2"	23.5	29.5
SB-5HG	53425 3	3/8"-16	4"	5"	3"	33.5	40
SB-6HG	53430 7	3/8"-16	4"	7"	3-3/4"	43.5	49.5
SB-7HG	53435 2	3/8"-16	6"	5"	3"	38.5	44.5
SB-8HG	53440 6	3/8"-16	6"	7"	3-3/4"	48	56
SB-9HG	53445 1	3/8"-16	6"	9"	5-5/8"	57	63



Hot Galvanized

## U-BOLT DISPLAY



### U-BOLT DISPLAY PART # 60040 8

Qty.	Stock No.	Pipe Size	Thread Diameter
10	4	1/2"	1/4"-20
10	5	3/4"	1/4"-20
10	5L	3/4"	1/4"-20
10	7	1"	1/4"-20
10	11	1"	5/16"-18
10	11L	1"	5/16"-18
10	13	1-1/4"	5/16"-18
10	13L	1-1/4"	5/16"-18
10	14	1-1/2"	5/16"-18
10	14L	1-1/2"	5/16"-18
10	15	2"	5/16"-18
10	15L	2"	5/16"-18
10	22	2"	3/8"-16
10	24	3"	3/8"-16

140 U-Bolts  
Shipping Wt. ....35 lbs.

# ZINC PLATED TURNED EYE BOLTS



Turned eye bolts are manufactured from low carbon cold drawn steel wire and are supplied with NC rolled machine threads with one hex nut unassembled. Zinc plated finish is standard; other rust preventive finishes or self-colored available on a special basis. When it is not feasible to utilize a standard eye bolt, we can manufacture to your specifications.

## MACHINE THREAD

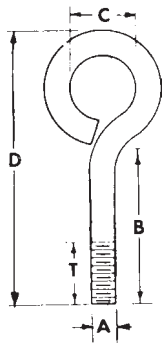

Some sizes also  
available in  
Stainless Steel.  
See page 49.

Stock No.	Part No.	Dimensions – Inches					Weight Per 100 in lbs.	Working Load Limit (lbs.)
		Thread Diameter (A)	Shank Length (B)	I.D. Eye (C)	Overall Length (D)	Thread Length (T)		
A-1	07005 8	1/8" (6-32)	3/4"	1/4"	1-1/4"	5/8"	.75	22
B-1	07010 2	5/32" (8-32)	1-1/8"	1/4"	1-11/16"	1"	1.31	36
C-1	07015 7	3/16" (10-24)	1"	3/8"	1-11/16"	7/8"	1.81	38
C-2	07020 1	3/16" (10-24)	1-3/8"	5/16"	2"	1-1/4"	1.875	38
C-3	07025 6	3/16" (10-24)	2"	3/8"	2-11/16"	1"	2.375	38
C-4	07030 0	3/16" (10-24)	3"	3/8"	3-11/16"	1-1/2"	2.94	38
D-1	07035 5	7/32" (12-24)	1-1/2"	3/8"	2-1/4"	1-3/8"	1.67	52
E-1	07040 9	1/4"-20	1"	1/2"	2"	7/8"	3.75	74
E-2	07045 4	1/4"-20	1-1/2"	1/2"	2-1/2"	1-1/4"	4.375	74
E-2A	07050 8	1/4"-20	1-7/8"	7/16"	2-3/4"	1-5/8"	5.2	74
E-3	07055 3	1/4"-20	2"	1/2"	3"	1-1/4"	5	74
E-4	07060 7	1/4"-20	2-1/2"	1/2"	3-1/2"	1-1/4"	5.6	74
E-5	07065 2	1/4"-20	3"	1/2"	4"	1-1/2"	6.3	74
E-6	07070 6	1/4"-20	3-1/2"	1/2"	4-1/2"	2"	6.9	74
E-7	07075 1	1/4"-20	4"	1/2"	5"	2-1/2"	7.5	74
E-8	07080 5	1/4"-20	5"	1/2"	6"	3"	8	74
E-9	07085 0	1/4"-20	6"	1/2"	7"	4"	9	74
F-1	07090 4	5/16"-18	1"	5/8"	2-1/8"	7/8"	7	96
F-2	07095 9	5/16"-18	2"	5/8"	3-1/8"	1-1/4"	9	96
F-2A	07100 0	5/16"-18	2-1/4"	9/16"	3-3/8"	2"	9.7	96
F-3	07105 5	5/16"-18	2-1/2"	5/8"	3-5/8"	1-1/4"	10	96
F-4	07110 9	5/16"-18	3"	5/8"	4-1/8"	1-1/2"	11	96
F-5	07115 4	5/16"-18	3-1/2"	5/8"	4-5/8"	2"	11	96
F-6	07120 8	5/16"-18	4"	5/8"	5-1/8"	2-1/2"	12	96
F-7	07125 3	5/16"-18	5"	5/8"	6-1/8"	3"	14	96
F-8	07130 7	5/16"-18	6"	5/8"	7-1/8"	4"	15	96
F-9	07135 2	5/16"-18	6-1/2"	7/8"	7-3/4"	4"	18	96
G-1	07140 6	3/8"-16	1"	3/4"	2-1/2"	7/8"	12	144
G-2	07145 1	3/8"-16	2"	3/4"	3-1/2"	1-1/4"	15	144
G-2A	07150 5	3/8"-16	2-1/2"	21/32"	3-3/4"	2-1/4"	15.7	144
G-3	07155 0	3/8"-16	2-1/2"	3/4"	4"	1-1/2"	15.5	144
G-4	07160 4	3/8"-16	3"	3/4"	4-1/2"	1-1/2"	17	144
G-5	07165 9	3/8"-16	3-1/2"	3/4"	5"	2"	18	144
G-6	07170 3	3/8"-16	4"	3/4"	5-1/2"	2-1/2"	21	144
G-7	07175 8	3/8"-16	5"	3/4"	6-1/2"	3"	22	144
G-8	07180 2	3/8"-16	6"	3/4"	7-1/2"	4"	24	144
G-9	07185 7	3/8"-16	8"	3/4"	9-1/2"	4"	30	144
G-10	07190 1	3/8"-16	10"	3/4"	11-1/2"	4"	34	144
G-11	07195 6	3/8"-16	12"	3/4"	13-1/2"	4"	39	144
H-1	07200 7	7/16"-14	6"	7/8"	7-3/4"	4"	36	216
H-2	07205 2	7/16"-14	8"	7/8"	9-3/4"	4"	42	216
J-1	07210 6	1/2"-13	2"	1"	4"	1-1/2"	33	298
J-2	07215 1	1/2"-13	4"	1"	6"	2-1/2"	41	298
J-3	07220 5	1/2"-13	6"	1"	8"	4"	50	298
J-4	07225 0	1/2"-13	8"	1"	10"	4"	58	298
J-5	07230 4	1/2"-13	10"	1"	12"	4"	68	298

### Standard Pack

A-1 through D-1: 50 Pieces

E-1 through J-5: 10 Pieces



# ZINC PLATED TURNED EYE BOLTS

## LAG THREADS

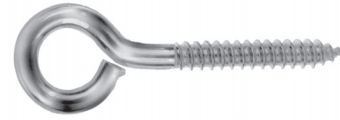

Lag Screw threaded Turned Eye Bolts are comparable in steel specification, finish and packaging to machine thread Turned Eye Bolts listed on page 37. Lag screw threads are rolled to fit standard anchors and shields and supplied with gimlet point.

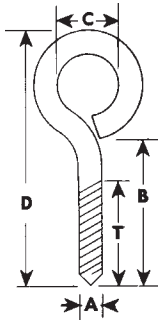

Stock No.	Part No.	Dimensions – Inches					Weight Per 100 in lbs.
		Thread Diameter (A)	Shank Length (B)	I.D. Eye (C)	Overall Length (D)	Thread Length (T)	
LS-1	07855 9	1/4"	2-3/4"	1/2"	3-11/16"	2"	5
LS-2	07860 3	1/4"	4"	1/2"	4-7/8"	2"	6
LS-3	07865 8	5/16"	2-3/4"	5/8"	3-7/8"	2"	8
LS-4	07870 2	5/16"	4-3/4"	5/8"	5-13/16"	2"	11
LS-5	07875 7	3/8"	3"	3/4"	4-3/8"	2-1/2"	13
LS-6	07880 1	3/8"	6"	3/4"	7-5/16"	2-1/2"	19
LS-7	07885 6	1/2"	3-1/2"	1"	5-1/4"	2-3/4"	30

Standard Pack – 10 Pieces

### TURNED EYE BOLT DISPLAY PART # 60030 9

Qty.	Stock No.	Diameter & Shank Length
10	C-1	3/16" x 1"
10	C-2	3/16" x 1-3/8"
10	C-3	3/16" x 2"
10	E-1	1/4" x 1"
10	E-2	1/4" x 1-1/2"
10	E-3	1/4" x 2"
10	E-5	1/4" x 3"
10	E-7	1/4" x 4"
10	F-2	5/16" x 2"
10	F-4	5/16" x 3"
10	F-6	5/16" x 4"
10	F-7	5/16" x 5"
10	G-3	3/8" x 2-1/2"
10	G-5	3/8" x 3-1/2"
10	G-6	3/8" x 4"
10	G-8	3/8" x 6"
10	J-2	1/2" x 4"
10	J-3	1/2" x 6"
10	J-4	1/2" x 8"

190 Eyebolts

Shipping Wt. .... 37 lbs.

## TURNED EYE BOLT DISPLAY



## WELDED – MACHINE THREADS

Comparable in specifications, finish and standard packaging with exception Eyes are resistance welded closed.

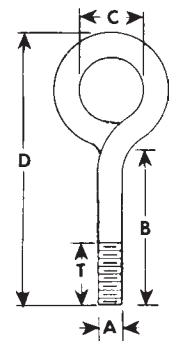

Stock No.	Part No.	Dimensions – Inches					Weight Per 100 in lbs.	Working Load Limit (lbs.)
		Thread Diameter (A)	Shank Length (B)	I.D. Eye (C)	Overall Length (D)	Thread Length (T)		
F-3W	07755 2	5/16"-18	2-1/2"	5/8"	3-5/8"	1-1/4"	10	240
G-3W	07760 6	3/8"-16	2-1/2"	3/4"	4"	1-1/2"	16	400
G-6W	07765 1	3/8"-16	4"	3/4"	5-1/2"	2-1/2"	20	400
J-2W	07770 5	1/2"-13	4"	1"	6"	2-1/2"	41	1000
J-3W	07775 0	1/2"-13	6"	1"	8"	4"	50	1000

Standard Pack – 10 Pieces



# CONTINUOUS THREADED ROD



Manufactured from Low Carbon Domestic Steel – 12", 24" and 36" lengths, color coded, bundled and packed in standard cartons, as noted, for convenience. 72", 120" and 144" lengths not coded or bundled, but packed in standard identified cartons. Lengths, other than standard and fully threaded or double end carbon steel studs, manufactured to specification. NC and NF rolled threads.



## STEEL-OIL FINISH

### 12" - 24" - 36" LENGTHS

Thread Diameter	Color Code	12" RODS			24" RODS				36" RODS					
		Part No.	Bundle		Part No.	Bundle		Carton		Part No.	Bundle		Carton	
			Quantity	Weight (lbs)		Quantity	Weight (lbs)	Quantity	Weight (lbs)		Quantity	Weight (lbs)	Quantity	Weight (lbs)
6 - 32	Blue	39005 7	5	0.2	39008 8	5	0.4	*	*	39011 8	5	0.6	*	*
8 - 32	Red	39025 5	5	0.3	39028 6	5	0.5	*	*	39031 6	5	0.8	*	*
10 - 24	Green	39045 3	5	0.3	39048 4	5	0.6	*	*	39051 4	5	0.9	*	*
12 - 24	Red	39065 1	5	0.4	39068 2	5	0.9	*	*	39071 2	5	1.3	*	*
1/4" - 20	Blue	39085 9	5	0.6	39088 0	5	1.3	200	48	39091 0	5	1.9	200	72
5/16" - 18	Red	39105 4	5	1	39108 5	5	2	125	50	39111 5	5	3	125	75
3/8" - 16	Yellow	39125 2	5	1.4	39128 3	5	2.9	100	57	39131 3	5	4.3	100	86
7/16" - 14	Green	39145 0	5	2	39148 1	5	4	70	56	39151 1	5	6	70	84
1/2" - 13	Blue	39165 8	5	2.6	39168 9	5	5.3	50	53	39171 9	5	7.9	50	79
9/16" - 12	Yellow	39185 6	3	2	39188 7	3	4	33	44	39191 7	3	6	33	66
5/8" - 11	Red	39205 1	3	2.5	39208 2	3	5	33	55	39211 2	3	7.5	33	83
3/4" - 10	Yellow	39225 9	3	3.7	39228 0	3	7.4	24	59	39231 0	3	11.1	24	88
7/8" - 9	Green	39245 7	3	5.1	39248 8	3	10.1	15	51	39251 8	3	15.2	15	76
1" - 8	Red	39265 5	3	6.7	39268 6	3	13.4	12	54	39271 6	3	20.1	12	81
1-1/8" - 7	Yellow	39285 3	N.A.	N.A.	39288 4	N.A.	N.A.	10	56	39291 4	N.A.	N.A.	10	84
1-1/4" - 7	Green	39305 8	N.A.	N.A.	39308 9	N.A.	N.A.	10	70	39311 9	N.A.	N.A.	10	105
1-3/8" - 6	Blue	39325 6	N.A.	N.A.	39328 7	N.A.	N.A.	10	84	39331 7	N.A.	N.A.	10	126
1-1/2" - 6	Red	39345 4	N.A.	N.A.	39348 5	N.A.	N.A.	5	51	39351 5	N.A.	N.A.	5	76

\*No established quantity.

### 72" - 120" - 144" LENGTHS

Thread Diameter	Color Code	72" RODS			120" RODS			144" RODS			Estimated Weight Per 100 Ft. (lbs)
		Part No.	Carton		Part No.	Carton		Part No.	Carton		
			Quantity	Weight (lbs)		Quantity	Weight (lbs)		Quantity	Weight (lbs)	
6 - 32	Blue	39014 9	*	*	39017 0	*	*	39020 0	*	*	3.6
8 - 32	Red	39034 7	*	*	39037 8	*	*	39040 8	*	*	5.3
10 - 24	Green	39054 5	*	*	39057 6	*	*	39060 6	*	*	6.7
12 - 24	Red	39074 3	*	*	39077 4	*	*	39080 4	*	*	9.2
1/4" - 20	Blue	39094 1	150	109	39097 2	90	109	39100 9	75	109	12.1
5/16" - 18	Red	39114 6	100	117	39117 7	60	117	39120 7	50	117	19.6
3/8" - 16	Yellow	39134 4	70	120	39137 5	42	120	39140 5	35	120	28.7
7/16" - 14	Green	39154 2	50	119	39157 3	30	119	39160 3	25	119	39.8
1/2" - 13	Blue	39174 0	36	114	39177 1	22	116	39180 1	18	114	52.6
9/16" - 12	Yellow	39194 8	24	96	39197 9	14	93	39200 6	12	96	66.7
5/8" - 11	Red	39214 3	24	120	39217 4	14	117	39220 4	12	120	83.3
3/4" - 10	Yellow	39234 1	16	118	39237 2	9	110	39240 2	8	118	123
7/8" - 9	Green	39254 9	12	122	39257 0	7	118	39260 0	6	122	170
1" - 8	Red	39274 7	9	120	39277 8	5	112	39280 8	4	107	223
1-1/8" - 7	Yellow	39294 5	6	101	39297 6	4	112	39300 3	3	101	280
1-1/4" - 7	Green	39314 0	5	106	39317 1	3	106	39320 1	2	84	352
1-3/8" - 6	Blue	39334 8	5	126	39337 9	3	126	39340 9	2	101	421
1-1/2" - 6	Red	39354 6	4	123	39357 7	2	102	39360 7	2	123	510





# CONTINUOUS THREADED ROD

Manufactured from Low Carbon Domestic Steel – 12", 24" and 36" lengths, color coded, bundled and packed in standard cartons, as noted, for convenience. 72", 120" and 144" lengths not coded or bundled, but packed in standard identified cartons. Lengths, other than standard and fully threaded or double end carbon steel studs, manufactured to specification. NC and NF rolled threads.



## ZINC PLATED STEEL

### 12" - 24" - 36" LENGTHS

Thread Diameter	Color Code	12" RODS			24" RODS					36" RODS				
		Part No.	Bundle		Part No.	Bundle		Carton		Part No.	Bundle		Carton	
			Quantity	Weight (lbs)		Quantity	Weight (lbs)	Quantity	Weight (lbs)		Quantity	Weight (lbs)	Quantity	Weight (lbs)
6 - 32	Blue	35005 1	5	0.2	35008 2	5	0.4	*	*	35011 2	5	0.6	*	*
8 - 32	Red	35025 9	5	0.3	35028 0	5	0.5	*	*	35031 0	5	0.8	*	*
10 - 24	Green	35045 7	5	0.3	35048 8	5	0.6	*	*	35051 8	5	0.9	*	*
12 - 24	Red	35065 5	5	0.4	35068 6	5	0.9	*	*	35071 6	5	1.3	*	*
1/4" - 20	Blue	35085 3	5	0.6	35088 4	5	1.3	200	48	35091 4	5	1.9	200	72
5/16" - 18	Red	35105 8	5	1	35108 9	5	2	125	50	35111 9	5	3	125	75
3/8" - 16	Yellow	35125 6	5	1.4	35128 7	5	2.9	100	57	35131 7	5	4.3	100	86
7/16" - 14	Green	35145 4	5	2	35148 5	5	4	70	56	35151 5	5	6	70	84
1/2" - 13	Blue	35165 2	5	2.6	35168 3	5	5.3	50	53	35171 3	5	7.9	50	79
9/16" - 12	Yellow	35185 0	3	2	35188 1	3	4	33	44	35191 1	3	6	33	66
5/8" - 11	Red	35205 5	3	2.5	35208 6	3	5	33	55	35211 6	3	7.5	33	83
3/4" - 10	Yellow	35225 3	3	3.7	35228 4	3	7.4	24	59	35231 4	3	11.1	24	88
7/8" - 9	Green	35245 1	3	5.1	35248 2	3	10.1	15	51	35251 2	3	15.2	15	76
1" - 8	Red	35265 9	3	6.7	35268 0	3	13.4	12	54	35271 0	3	20.1	12	81
1-1/8" - 7	Yellow	35285 7	N.A.	N.A.	35288 8	N.A.	N.A.	10	56	35291 8	N.A.	N.A.	10	84
1-1/4" - 7	Green	35305 2	N.A.	N.A.	35308 3	N.A.	N.A.	10	70	35311 3	N.A.	N.A.	10	105
1-3/8" - 6	Blue	35325 0	N.A.	N.A.	35328 1	N.A.	N.A.	10	84	35331 1	N.A.	N.A.	10	126
1-1/2" - 6	Red	35345 8	N.A.	N.A.	35348 9	N.A.	N.A.	5	51	35351 9	N.A.	N.A.	5	76

\*No established quantity.

### 72" - 120" - 144" LENGTHS

Thread Diameter	Color Code	72" RODS			120" RODS			144" RODS			Estimated Weight Per 100 Ft. (lbs)
		Part No.	Carton		Part No.	Carton		Part No.	Carton		
			Quantity	Weight (lbs)		Quantity	Weight (lbs)		Quantity	Weight (lbs)	
6 - 32	Blue	35014 3	*	*	35017 4	*	*	35020 4	*	*	3.6
8 - 32	Red	35034 1	*	*	35037 2	*	*	35040 2	*	*	5.3
10 - 24	Green	35054 9	*	*	35057 0	*	*	35060 0	*	*	6.7
12 - 24	Red	35074 7	*	*	35077 8	*	*	35080 8	*	*	9.2
1/4" - 20	Blue	35094 5	150	109	35097 6	90	109	35100 3	75	109	12.1
5/16" - 18	Red	35114 0	100	117	35117 1	60	117	35120 1	50	117	19.6
3/8" - 16	Yellow	35134 8	70	120	35137 9	42	120	35140 9	35	120	28.7
7/16" - 14	Green	35154 6	50	119	35157 7	30	119	35160 7	25	119	39.8
1/2" - 13	Blue	35174 4	36	114	35177 5	22	116	35180 5	18	114	52.6
9/16" - 12	Yellow	35194 2	24	96	35197 3	14	93	35200 0	12	96	66.7
5/8" - 11	Red	35214 7	24	120	35217 8	14	117	35220 8	12	120	83.3
3/4" - 10	Yellow	35234 5	16	118	35237 6	9	110	35240 6	8	118	123
7/8" - 9	Green	35254 3	12	122	35257 4	7	118	35260 4	6	122	170
1" - 8	Red	35274 1	9	120	35277 2	5	112	35280 2	4	107	223
1-1/8" - 7	Yellow	35294 9	6	101	35297 0	4	112	35300 7	3	101	280
1-1/4" - 7	Green	35314 4	5	106	35317 5	3	106	35320 5	2	84	352
1-3/8" - 6	Blue	35334 2	5	126	35337 3	3	126	35340 3	2	101	421
1-1/2" - 6	Red	35354 0	4	123	35357 1	2	102	35360 1	2	123	510





# CONTINUOUS THREADED ROD



## BRASS

Brass Threaded Rod, both in National Coarse and National Fine Thread Series, is also available in 120" and 144" lengths on a special basis. Intermediate lengths and studs are also available on a special basis.

### 36" AND 72" LENGTHS



Thread Diameter	36" Length					72" Length		
	Part No.	Bundle		Carton		Part No.	Carton	
		Quantity	Weight (lbs)	Quantity	Weight (lbs)		Quantity	Weight (lbs)
6 - 32	36011 1	10	1.2	*	*	36014 2	*	*
8 - 32	36031 9	10	1.7	*	*	36034 0	*	*
10 - 24	36051 7	10	2.2	*	*	36054 8	*	*
12 - 24	36071 5	10	2.9	*	*	36074 6	*	*
1/4" - 20	36091 3	5	2.0	200	79	36094 4	150	129
5/16" - 18	36111 8	5	3.0	125	75	36114 9	160	129
3/8" - 16	36131 6	5	4.5	100	90	36134 7	70	134
7/16" - 14	36151 4	5	6.3	70	88	36154 5	50	130
1/2" - 13	36171 2	5	8.4	50	84	36174 3	36	125
5/8" - 11	36211 5	3	8.1	33	89	36214 6	24	132
3/4" - 10	36231 3	3	12.0	24	94	36234 4	16	129



## 304 STAINLESS STEEL

### 36", 72" AND 144" LENGTHS

Thread Diameter	36" Length					72" Length			144" Length			Estimated Weight Per 100 Ft. (lbs)
	Part No.	Bundle		Carton		Part No.	Carton		Part No.	Carton		
		Quantity	Weight (lbs)	Quantity	Weight (lbs)		Quantity	Weight (lbs)		Quantity	Weight (lbs)	
6 - 32	37011 0	5	.50	*	*	37014 1	*	*	37020 2	*	*	3.6
8 - 32	37031 8	5	.75	*	*	37034 9	*	*	37040 0	*	*	5.3
10 - 24	37051 6	5	1	*	*	37054 7	*	*	37060 8	*	*	6.7
12 - 24	37071 4	5	1.35	*	*	37074 5	*	*	37080 6	*	*	9.2
1/4" - 20	37091 2	5	1.8	200	72	37094 3	150	109	37100 1	75	107	12.1
5/16" - 18	37111 7	5	3.0	125	75	37114 8	100	117	37120 9	50	117	19.6
3/8" - 16	37131 5	5	4.3	100	86	37134 6	70	120	37140 7	35	120	28.7
7/16" - 14	37151 3	5	6	70	84	37154 4	50	119	37160 5	25	119	39.8
1/2" - 13	37171 1	5	8.1	50	81	37174 2	36	114	37180 3	18	114	52.6
9/16" - 12	37191 9	3	6	33	68	37194 0	24	96	37200 8	12	96	66.7
5/8" - 11	37211 4	5	7.7	33	85	37214 5	24	120	37220 6	12	120	83.3
3/4" - 10	37231 2	3	11.2	24	90	37234 3	16	118	37240 4	8	118	123
7/8" - 9	37251 0	3	16	15	76	37254 1	12	122	37260 2	6	122	170
1" - 8	37271 8	3	20.3	12	80	37274 9	9	120	37280 0	4	107	223



# CONTINUOUS THREADED ROD



## HOT GALVANIZED CARBON STEEL 36" AND 72" LENGTHS



### ZINC PLATED ONE FOOT THREADED ROD DISPLAY:



#### CHICAGO ONE FOOT ZINC PLATED THREADED ROD DISPLAY Part No. 60160 3

Each Assortment Contains  
The Following:

35 Each 1/4" - 20 x 1'	35 Each 3/8" - 16 x 1'
35 Each 5/16" - 18 x 1'	30 Each 1/2" - 13 x 1'
<b>Shipping Weight: 38 Lbs.</b>	
Each size is color coded for easy identification	

One Foot Threaded Rod Display  
can be substituted for Key Stock.

Thread Diameter	Color Code	36" Length Part No.	72" Length Part No.	Weight Per 100 Ft. (lbs)
3/8" - 16	Yellow	46131 3	46134 4	28.7
7/16" - 14	Green	46151 1	46154 2	39.8
1/2" - 13	Blue	46171 9	46174 0	52.6
5/8" - 11	Red	46211 2	46214 3	83.3
3/4" - 10	Yellow	46231 0	46234 1	123
7/8" - 9	Green	46251 8	46254 9	170
1" - 8	Red	46271 6	46274 7	223
1-1/4" - 7	Green	46311 9	46314 0	352

## B7-ALLOY - SELF-COLORED 36", 72" AND 144" LENGTHS

Thread Diameter	Color Code	36" Length Part No.	72" Length Part No.	144" Length Part No.	Weight Per 100 Ft. (lbs)
1/4" - 20	Blue	38091 1	38094 2	38100 0	12.1
5/16" - 18	Red	38111 6	38114 7	38120 8	19.6
3/8" - 16	Yellow	38131 4	38134 5	38140 6	28.7
7/16" - 14	Green	38151 2	38154 3	38160 4	39.8
1/2" - 13	Blue	38171 0	38174 1	38180 2	52.6
5/8" - 11	Red	38211 3	38214 4	38220 5	83.3
3/4" - 10	Yellow	38231 1	38234 2	38240 3	123
7/8" - 9	Green	38251 9	38254 0	38260 1	170
1" - 8	Red	38271 7	38274 8	38280 9	223
1-1/8" - 7	Yellow	38291 5	38294 6	38300 4	280
1-1/8" - 8	Yellow	38311 0	38314 1	38320 2	292
1-1/4" - 7	Green	38331 8	38334 9	38340 0	352
1-1/4" - 8	Green	38351 6	38354 7	38360 8	366
1-1/2" - 6	Red	38391 2	38394 3	38400 1	510
1-1/2" - 8	Red	38411 7	38414 8	38420 9	534

# ZINC PLATED STEEL COUPLING NUTS

Tap Size	Part No.	Outside Hex	Overall Length	Pieces Per Package	Estimated Weight Per Package (lbs)	Estimated Weight Per 100 (lbs)
10 - 24	25505 9	5/16"	3/4"	50	.35	.7
1/4" - 20	25510 3	3/8"	7/8"	50	1	2
5/16" - 18	25515 8	1/2"	1-1/8"	25	.75	3
3/8" - 16	25520 2	5/8"	1-3/4"	25	2.9	11
7/16" - 14	25525 7	11/16"	1-3/4"	25	2.6	10
1/2" - 13	25530 1	11/16"	1-3/4"	25	3	12
5/8" - 11	25535 6	13/16"	2-1/8"	20	3.7	18
3/4" - 10	25540 0	1"	2-1/4"	20	6	29
7/8" - 9	25545 5	1-1/4"	2-1/2"	10	5.3	53
1" - 8	25550 9	1-3/8"	2-3/4"	10	7	70
1-1/8" - 7	25555 4	1-1/2"	3"	10	9	90
1-1/4" - 7	25560 8	1-5/8"	3"	10	9.8	97

National Coarse Right Hand Thread. For joining threaded rods where span of application exceeds 144" or where a threaded fitting is used with threaded rod in suspension applications.



# ZINC PLATED STEEL "SHAPES"



Special lengths available upon request.

## SQUARE KEY

Size	12" Length			24" Length			36" Length			Estimated Weight Per 100 Ft. (lbs)
	Part No.	Bundle		Part No.	Bundle		Part No.	Bundle		
		Quantity	Weight (lbs)		Quantity	Weight (lbs)		Quantity	Weight (lbs)	
1/8"	31005 5	6	.32	31505 0	N.A.	N.A.	31250 9	N.A.	N.A.	5.3
5/32"	31010 9	6	.50	31510 4	N.A.	N.A.	31253 0	N.A.	N.A.	8.3
3/16"	31015 4	6	.72	31515 9	N.A.	N.A.	31256 1	N.A.	N.A.	12
1/4"	31020 8	6	1.32	31520 3	6	2.64	31259 2	6	3.96	22
5/16"	31025 3	6	1.98	31525 8	6	3.96	31262 2	6	5.94	33
3/8"	31030 7	6	2.88	31535 7	6	5.76	31265 3	6	8.64	48
7/16"	31035 2	3	1.95	31540 1	3	3.90	31268 4	3	5.85	65
1/2"	31040 6	3	2.55	31545 6	3	5.10	31271 4	3	7.65	85
9/16"	31045 1	3	3.24	31550 0	3	6.48	31274 5	3	9.72	108
5/8"	31050 5	3	3.99	31555 5	3	7.98	31277 6	3	11.97	133
11/16"	31055 0	3	4.80	31560 9	3	9.60	31280 6	3	14.40	160
3/4"	31060 4	3	5.70	31565 4	3	11.40	31283 7	3	17.10	190
13/16"	31065 9	3	6.75	31570 8	3	13.50	31286 8	3	20.25	225
7/8"	31070 3	3	7.80	31575 3	3	15.60	31289 9	3	23.40	260
1"	31075 8	3	10.2	31580 7	3	20.40	31292 9	3	30.60	340



**NOTE: Standard carton quantities shown for information purposes. Standard bundle quantities should be observed.**



CHICAGO SQUARE KEYSTOCK DISPLAY PART # 60150 4
<b>Contains the Following</b>
<b>Zinc Plated Sizes</b>
<b>12" Lengths Square Keystock:</b>
<b>12 Each: 1/8", 5/32", 3/16", 1/4", 5/16", 3/8"</b>
<b>6 Each: 7/16", 1/2"</b>
Shipping Weight 36 lbs.

## SLOTTED ANGLES

Size	Part No.	Length Inches	Stock				Estimated Weight Per 100 Feet (lbs)
			Bundle		Carton		
			Quantity	Weight (lbs)	Quantity	Weight (lbs)	
.074" x 1-1/2" x 1-1/2"	31705 4	36"	12	25	36	75	69
.074" x 1-1/2" x 1-1/2"	31710 8	48"	12	33	12	33	69
.074" x 1-1/2" x 1-1/2"	31715 3	60"	12	42	12	42	69
.074" x 1-1/2" x 1-1/2"	31720 7	72"	12	50	12	50	69
.074" x 1-1/2" x 1-1/2"	31725 2	120"	12	84	12	84	69
.074" x 1-1/2" x 1-1/2"	31730 6	144"	12	100	12	100	69
.080" x 2-1/4" x 1-1/2"	31735 1	72"	6	33	12	66	93
.080" x 2-1/4" x 1-1/2"	31740 5	120"	6	56	6	56	93
.080" x 2-1/4" x 1-1/2"	31745 0	144"	6	67	6	67	93

Two sizes of framing materials, .074" for light duty and .080" for standard applications, are offered as Angles. Easily assembled with 5/16" x 3/4" hex head bolts with nuts – storage racks, tables, benches and carts to cite a few end uses.

## SLOTTED FLATS

Size	Part No.	Length Inches	Stock				Estimated Weight Per 100 Feet (lbs)
			Bundle		Carton		
			Quantity	Weight (lbs)	Quantity	Weight (lbs)	
.080" x 1-3/8"	29705 9	36"	5	5.2	90	94	35
.080" x 1-3/8"	29710 3	48"	5	7	50	70	35
.080" x 1-3/8"	29715 8	60"	5	8.6	50	86	35
.080" x 1-3/8"	29720 2	72"	5	10.4	50	105	35

For use in tensioning angles, load dividers or hangers.





# ZINC PLATED\* STEEL "SHAPES"

\* Also available in self-colored finish for welding.

Diameters 3/16" to 3/4" inclusive are cold drawn steel. Produced to cold finish tolerances. 7/8" and 1" rounds are Hot Rolled. 72", 120" and 144" lengths are also available.

## ROUNDS



Diameter or Size	Color Code	Part No.	Length Inches	Stock				Estimated Weight Per 100 Feet (lbs)
				Bundle		Carton		
				Quantity	Weight (lbs)	Quantity	Weight (lbs)	
3/16"	Green	28105 8	36"	5	1.4	200	56	9.4
1/4"	Blue	28110 2	36"	5	2.5	170	85	16.7
5/16"	Red	28115 7	36"	5	3.9	110	86	26.1
3/8"	Yellow	28120 1	36"	5	5.6	75	84	37.6
7/16"	Green	28125 6	36"	5	7.7	55	85	51.1
1/2"	Blue	28130 0	36"	5	11	40	80	66.8
5/8"	Red	28135 5	36"	3	9.4	27	85	104.3
3/4"	Yellow	28140 9	36"	3	13.5	18	81	150.2
7/8"	Green	28145 4	36"	3	18.2	15	91	204
1"	Red	28150 8	36"	3	24	12	96	267

Some sizes are available in stainless steel on a special basis.

## FLATS

Produced from Mild Carbon Cold Finished Steel with Round Edges. 12 foot maximum length available.

Stock Sizes & Lengths	Part No.	Stock				Estimated Weight Per 100 Feet (lbs)
		Bundle		Carton		
		Quantity	Weight (lbs)	Quantity	Weight (lbs)	
1/8" x 3/4" x 36"	29105 7	5	4.8	90	86	31.9
1/8" x 3/4" x 48"	29110 1	5	6.4	70	90	31.9
1/8" x 3/4" x 72"	29120 0	5	9.6	45	86	31.9
1/8" x 1" x 36"	29125 5	5	6.4	70	90	42.5
1/8" x 1" x 48"	29130 9	5	8.5	50	85	42.5
1/8" x 1" x 72"	29140 8	5	12.8	35	90	42.5
1/8" x 1-1/4" x 36"	29145 3	5	7.1	50	80	53.1
1/8" x 1-1/4" x 48"	29150 7	5	10.6	40	85	53.1
1/8" x 1-1/4" x 72"	29160 6	5	15.9	25	80	53.1

## Zinc Plated Mild Carbon Steel.

## ANGLES



Stock Sizes & Lengths	Part No.	Stock				Estimated Weight Per 100 Feet (lbs)
		Bundle		Carton		
		Quantity	Weight (lbs)	Quantity	Weight (lbs)	
1/8" x 3/4" x 3/4" x 36"	30105 3	3	5.3	36	64	59
1/8" x 3/4" x 3/4" x 48"	30110 7	3	7.1	24	57	59
1/8" x 3/4" x 3/4" x 60"	30115 2	3	8.9	24	71	59
1/8" x 3/4" x 3/4" x 72"	30120 6	3	10.6	24	85	59
1/8" x 1" x 1" x 36"	30125 1	3	7.2	30	72	80
1/8" x 1" x 1" x 48"	30130 5	3	9.6	18	58	80
1/8" x 1" x 1" x 60"	30135 0	3	12	18	72	80
1/8" x 1" x 1" x 72"	30140 4	3	14.4	18	86	80
1/8" x 1-1/4" x 1-1/4" x 36"	30145 9	3	9.1	24	73	101
1/8" x 1-1/4" x 1-1/4" x 48"	30150 3	3	12.1	15	61	101
1/8" x 1-1/4" x 1-1/4" x 60"	30155 8	3	15.1	15	76	101
1/8" x 1-1/4" x 1-1/4" x 72"	30160 2	3	18.1	15	91	101
3/16" x 2" x 2" x 36"	30165 7	3	21.9	6	44	244
3/16" x 2" x 2" x 48"	30170 1	3	29.2	6	59	244
3/16" x 2" x 2" x 60"	30175 6	3	36.6	6	73	244
3/16" x 2" x 2" x 72"	30180 0	3	43.9	6	88	244

**NOTE:**  
Standard carton quantities shown for information purposes. Standard bundle quantities should be observed.



# BRASS ROUNDS, FLATS & ANGLES



## BRASS ROUNDS

72", 120" and 144" lengths are also available from stock; intermediate lengths on a special basis.

Diameter or Size	Part No.	Length Inches	Stock				Estimated Weight Per 100 Feet (lbs)
			Bundle		Carton		
			Quantity	Weight (lbs)	Quantity	Weight (lbs)	
3/16"	28005 1	36"	5	1.5	170	51	10.2
1/4"	28010 5	36"	5	2.7	170	92	18.1
5/16"	28015 0	36"	5	4.2	110	92	28.3
3/8"	28020 4	36"	5	6.1	75	92	40.7
7/16"	28025 9	36"	5	8.3	55	92	55.4
1/2"	28030 3	36"	5	10.8	40	86	72.3
5/8"	28035 8	36"	3	10.1	27	91	113
3/4"	28040 2	36"	3	14.6	18	88	163



## BRASS FLATS

Lengths, in addition to those listed below, can be supplied up to 144".



Stock Sizes & Lengths	Part No.	Stock				Estimated Weight Per 100 Feet (lbs)
		Bundle		Carton		
		Quantity	Weight (lbs)	Quantity	Weight (lbs)	
1/8" x 3/4" x 36"	29005 0	5	5.2	90	94	34.5
1/8" x 3/4" x 48"	29010 4	5	6.9	70	97	34.5
1/8" x 3/4" x 72"	29020 3	5	10.4	45	94	34.5
1/8" x 1" x 36"	29025 8	5	6.9	70	97	46.1
1/8" x 1" x 48"	29030 2	5	9.2	50	92	46.1
1/8" x 1" x 72"	29040 1	5	13.8	35	97	46.1
1/8" x 1-1/4" x 36"	29045 6	5	8.6	50	86	57.6
1/8" x 1-1/4" x 48"	29050 0	5	11.5	40	92	57.6
1/8" x 1-1/4" x 72"	29060 9	5	13.8	25	86	57.8

## BRASS ANGLES

For Structural and Marine repair applications which require non-ferrous metals. Maximum length available 144".

Stock Sizes & Lengths	Part No.	Stock				Estimated Weight Per 100 Feet (lbs)
		Bundle		Carton		
		Quantity	Weight (lbs)	Quantity	Weight (lbs)	
1/8" x 3/4" x 3/4" x 36"	30005 6	3	5.6	36	67	62.9
1/8" x 3/4" x 3/4" x 48"	30010 0	3	7.5	24	60	62.9
1/8" x 3/4" x 3/4" x 60"	30015 5	3	9.4	24	75	62.9
1/8" x 3/4" x 3/4" x 72"	30020 9	3	11.3	24	90	62.9
1/8" x 1-1/4" x 1-1/4" x 36"	30045 2	3	9.8	24	78	109
1/8" x 1-1/4" x 1-1/4" x 48"	30050 6	3	13	15	65	109
1/8" x 1-1/4" x 1-1/4" x 60"	30055 1	3	16.3	15	82	109
1/8" x 1-1/4" x 1-1/4" x 72"	30060 5	3	19.6	15	98	109



**NOTE: Standard carton quantities shown for information purposes. Standard bundle quantities should be observed.**







# FULL-SIZE STEEL CENTER DISPLAY

**FULL-SIZE STEEL CENTER ..... Part No. 60060 6**

**Shipping Weight ..... 586 lbs.**



## Display Contains the Following:

### 24" ZINC PLATED THREADED ROD

Size	No. Pcs.	Part No.
1/4" - 20	15	35088 4
5/16" - 18	15	35108 9
3/8" - 16	15	35128 7
1/2" - 13	15	35168 3
5/8" - 11	6	35208 6
3/4" - 10	6	35228 4

### 36" ZINC PLATED ROUNDS

Size	No. Pcs.	Part No.
3/16"	10	28105 8
1/4"	10	28110 2
5/16"	10	28115 7
3/8"	10	28120 1
1/2"	5	28130 0
5/8"	3	28135 5

### 36" ZINC PLATED THREADED ROD

Size	No. Pcs.	Part No.
1/4" - 20	20	35091 4
5/16" - 18	20	35111 9
3/8" - 16	20	35131 7
1/2" - 13	10	35171 3
5/8" - 11	6	35211 6
3/4" - 10	6	35231 4

### ZINC PLATED SLOTTED ANGLES

Size	No. Pcs.	Part No.
.074" x 1-1/2" x 1-1/2" x 36"	6	31705 4
.074" x 1-1/2" x 1-1/2" x 48"	6	31710 8
.074" x 1-1/2" x 1-1/2" x 72"	6	31720 7
.080" x 2-1/4" x 1-1/4" x 72"	6	31735 1

### 72" ZINC PLATED THREADED ROD

Size	No. Pcs.	Part No.
1/4" - 20	6	35094 5
5/16" - 18	6	35114 0
3/8" - 16	6	35134 8
1/2" - 13	6	35174 4
5/8" - 11	3	35214 7
3/4" - 10	3	35234 5

### ZINC PLATED ANGLES

Size	No. Pcs.	Part No.
1/8" x 3/4" x 3/4" x 36"	6	30105 3
1/8" x 3/4" x 3/4" x 72"	3	30120 6
1/8" x 1" x 1" x 36"	6	30125 1
1/8" x 1" x 1" x 72"	3	30140 4
1/8" x 1-1/4" x 1-1/4" x 36"	3	30145 9
1/8" x 1-1/4" x 1-1/4" x 72"	3	30160 2

### 12" ZINC PLATED KEY STOCK

Size	No. Pcs.	Part No.
1/8"	12	31005 5
5/32"	12	31010 9
3/16"	12	31015 4
1/4"	12	31020 8
5/16"	12	31025 3
3/8"	12	31030 7
7/16"	6	31035 2
1/2"	6	31040 6

### ZINC PLATED FLATS

Size	No. Pcs.	Part No.
1/8" x 3/4" x 36"	5	29105 7
1/8" x 3/4" x 72"	5	29120 0
1/8" x 1" x 36"	5	29125 5
1/8" x 1" x 72"	5	29140 8
1/8" x 1-1/4" x 36"	5	29145 3
1/8" x 1-1/4" x 72"	5	29160 6



Display Stand Dimensions:  
65" High  
16-1/2" Wide  
21" Deep (at the base)

### ZINC PLATED SLOTTED FLATS

Size	No. Pcs.	Part No.
.080" x 1-3/8" x 36"	5	29705 9
.080" x 1-3/8" x 72"	5	29720 2

One Foot Threaded Rod Display can be substituted for Key Stock.



# STAINLESS STEEL SECTION



## THIMBLES TYPE 304 STAINLESS STEEL

Rope Diameter	Part No.	Weight Per 100
1/8"	22305 8	2.1
3/16"	22310 2	2.1
1/4"	22315 7	3.4
5/16"	22320 1	4.6
3/8"	22325 6	9
1/2"	22335 5	17



See page 13 for additional dimensional information.

## DROP FORGED EYE BOLTS TYPE 316 STAINLESS STEEL

Diameter & Shank Length	Regular		Shoulder	
	Part No.	Weight Per 100	Part No.	Weight Per 100
1/4" x 2"	08205 1	6.4	08605 9	7.4
1/4" x 3"	08208 2	8	N.A.	N.A.
1/4" x 4"	08211 2	9.3	08611 0	10.7
1/4" x 5"	08214 3	10.4	N.A.	N.A.
1/4" x 6"	08217 4	11.8	N.A.	N.A.
5/16" x 2-1/4"	08222 8	12.7	08622 6	12.9
5/16" x 3-1/4"	08225 9	15	N.A.	N.A.
5/16" x 4-1/4"	08228 0	16.5	08628 8	16.8
3/8" x 2-1/2"	08239 6	19.2	08639 4	21
3/8" x 4-1/4"	08245 7	24.4	08645 5	29
1/2" x 3-1/4"	08262 4	46	08662 2	46
1/2" x 6"	08268 6	60	08668 4	63
5/8" x 4-1/2"	08282 2	79	08682 0	99



Regular



Shoulder

See pages 14-15 for additional dimensional information.

# STAINLESS STEEL SECTION

## WIRE ROPE CLIPS TYPE 304 STAINLESS STEEL



Stock No.	Rope Size	Part No.	Weight Per 100
2	1/16" - 3/32"	23605 8	5
4	1/8" - 5/32"	23610 2	7
6	3/16" - 7/32"	23615 7	11
8	1/4" - 5/16"	23620 1	18
10	3/8"	23630 0	38
12	7/16" - 1/2"	23635 5	55



# STAINLESS STEEL SECTION



Shoulder

## MACHINERY EYE BOLTS SHOULDER PATTERN – THREADED TYPE 316 STAINLESS STEEL

Shoulder Pattern No.	Bolt Diameter	Shank Length	Part No.	Weight Per 100
21SS	1/4"	1"	13105 6	6
22SS	5/16"	1-1/8"	13125 4	10
23SS	3/8"	1-1/4"	13145 2	16
25SS	1/2"	1-1/2"	13185 8	38
27SS	5/8"	1-3/4"	13225 1	73.5
28SS	3/4"	2"	13248 0	99.5

See page 18 for additional dimensional information.



Plain

## MACHINERY EYE BOLTS PLAIN PATTERN – THREADED TYPE 316 STAINLESS STEEL

Plain Pattern No.	Bolt Diameter	Shank Length	Part No.	Weight Per 100
1SS	1/4"	1"	14205 2	5
2SS	5/16"	1-1/8"	14210 6	10.5
3SS	3/8"	1-1/4"	14215 1	15.5
5SS	1/2"	1-1/2"	14220 5	33
7SS	5/8"	1-3/4"	14225 0	64
8SS	3/4"	2"	14230 4	90.5



## DROP FORGED BLANK ROD ENDS TYPE 316 STAINLESS STEEL

Stock No.	Part No.	Diameter Inches	*Length Inches	Weight Per 100
C-134SS-A	18555 4	1/4"	6"	11
C-135SS-A	18560 6	5/16"	6"	18
C-217SS	18535 6	3/8"	3"	14
C-138SS	18565 3	1/2"	6"	47
C-139SS	18585 1	5/8"	6"	77.5
C-140SS	18605 6	3/4"	6"	112
C-141SS	18615 5	7/8"	6"	164

\* Measured from center of boss

See page 29 for additional dimensional information.



## REGULAR DROP FORGED EYE NUTS TYPE 316 STAINLESS STEEL

Drilled & Tapped			
Bail Size	Tap Size	Part No.	Weight Per 100
1/4"	1/4" - 20	16505 1	8.2
1/4"	5/16" - 18	16510 5	8
3/8"	3/8" - 16	16520 4	34
3/8"	1/2" - 13	16525 9	29.3
1/2"	5/8" - 11	16530 3	61.5
5/8"	3/4" - 10	16535 8	103

See page 27 for additional dimensional information.

# STAINLESS STEEL SECTION



## TURNED EYE BOLTS – MACHINE THREAD TYPE 304 STAINLESS STEEL



Stock No.	Thread Diameter	Part No.	Shank Length	Weight Per 100
A-1SS	1/8" (6-32)	07255 7	3/4"	.75
B-1SS	5/32" (8-32)	07260 1	1-1/8"	1.31
C-1SS	3/16" (10-24)	07265 6	1"	1.81
C-2SS	3/16" (10-24)	07270 0	1-3/8"	1.875
C-3SS	3/16" (10-24)	07275 5	2"	2.375
C-4SS	3/16" (10-24)	07280 9	3"	2.94
E-1SS	1/4"-20	07290 8	1"	3.75
E-2SS	1/4"-20	07295 3	1-1/2"	4.375
E-2SS-A	1/4"-20	07300 4	1-7/8"	5.2
E-3SS	1/4"-20	07305 9	2"	5
E-4SS	1/4"-20	07310 3	2-1/2"	5.6
E-5SS	1/4"-20	07315 8	3"	6.3
E-6SS	1/4"-20	07320 2	3-1/2"	6.9
E-7SS	1/4"-20	07325 7	4"	7.5
E-8SS	1/4"-20	07330 1	5"	8
E-9SS	1/4"-20	07335 6	6"	9
F-1SS	5/16"-18	07340 0	1"	7
F-2SS	5/16"-18	07345 5	2"	9
F-2SS-A	5/16"-18	07350 9	2-1/4"	9.7
F-3SS	5/16"-18	07355 4	2-1/2"	10

Stock No.	Thread Diameter	Part No.	Shank Length	Weight Per 100
F-4SS	5/16"-18	07360 8	3"	11
F-5SS	5/16"-18	07365 3	3-1/2"	11
F-6SS	5/16"-18	07370 7	4"	12
F-7SS	5/16"-18	07375 2	5"	14
F-8SS	5/16"-18	07380 6	6"	15
F-9SS	5/16"-18	07385 1	6-1/2"	18
G-1SS	3/8"-16	07390 5	1"	12
G-2SS	3/8"-16	07395 0	2"	15
G-2SS-A	3/8"-16	07400 1	2-1/2"	15.7
G-3SS	3/8"-16	07405 6	2-1/2"	15.5
G-4SS	3/8"-16	07410 0	3"	17
G-5SS	3/8"-16	07415 5	3-1/2"	18
G-6SS	3/8"-16	07420 9	4"	21
G-7SS	3/8"-16	07425 4	5"	22
G-8SS	3/8"-16	07430 8	6"	24
G-9SS	3/8"-16	07435 3	8"	30
J-1SS	1/2"-13	07460 5	2"	33
J-2SS	1/2"-13	07465 0	4"	41
J-3SS	1/2"-13	07470 4	6"	50
J-4SS	1/2"-13	07475 9	8"	58

See page 37 for additional dimensional information.

## S-HOOKS – TYPE 304 STAINLESS STEEL

Stock No.	Part No.	Dimensions – Inches				Weight Per 100 (lbs)	Working Load Limit (lbs)
		Wire Diameter	Overall Length	Hooks Inside Dia.	Opening Hooks		
S-1SS	06211 4	.080"	3/4"	1/4"	1/8"	.26	7
S-1SS-A	06213 8	.105"	1"	5/16"	5/32"	.55	16
S-2SS	06214 5	.114"	1-1/4"	3/8"	3/16"	.83	17
S-2SS-A	06215 2	.148"	1-1/2"	7/16"	7/32"	1.62	26
S-3SS	06217 6	.186"	1-3/4"	1/2"	1/4"	2.97	40
S-4SS	06220 8	.220"	2-1/8"	5/8"	5/16"	5.15	58
S-5SS	06223 7	.250"	2-1/2"	3/4"	7/16"	7.5	70
S-6SS	06226 8	.312"	3"	7/8"	1/2"	13.9	132
S-7SS	06229 9	.375"	3-1/2"	1"	1/2"	23.44	170



See page 31 for additional dimensional information.



# STAINLESS STEEL SECTION



## ROUND BEND U-BOLTS - TYPE 304 STAINLESS STEEL

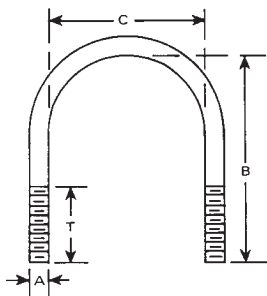

Dimensions U-Bolts Only (A x C x B)	Pipe Size	Stainless Steel U-Bolts & 2 Nuts			Stainless Steel U-Bolts Plates & 2 Nuts		
		Stock No.	Part No.	Weight Per 100	Stock No.	Part No.	Weight Per 100
1/4" x 9/16" x 1-1/4"	1/4"	01SS	50405 8	5	1SS	50605 2	7
1/4" x 3/4" x 1-1/4"	3/8"	02SS	50408 9	5	2SS	50608 3	7
1/4" x 3/4" x 2-1/4"	3/8"	03SS	50411 9	7	3SS	50611 3	9
1/4" x 1" x 1-3/4"	1/2"	04SS	50414 0	7	4SS	50614 4	9
1/4" x 1-1/8" x 2"	3/4"	05SS	50420 1	7	5SS	50620 5	9
1/4" x 1-1/4" x 2-1/4"	3/4"	06SS	50426 3	7.5	6SS	50626 7	10
1/4" x 1-1/2" x 2-3/4"	1"	07SS	50429 4	9	7SS	50629 8	12
1/4" x 1-3/4" x 3"	1-1/4"	08SS	50432 4	9	8SS	50632 8	12
1/4" x 2" x 3-1/4"	1-1/2"	09SS	50435 5	9.5	9SS	50635 9	14
5/16" x 1" x 2-3/16"	1/2"	010SS	50438 6	11	10SS	50638 0	14
5/16" x 1-3/8" x 2-3/16"	1"	011SS	50444 7	12	11SS	50644 1	15
5/16" x 1-1/2" x 2-3/16"	1"	012SS	50450 8	12	12SS	50650 2	15
5/16" x 1-3/4" x 2-11/16"	1-1/4"	013SS	50453 9	13	13SS	50653 3	17.5
5/16" x 2" x 2-11/16"	1-1/2"	014SS	50459 1	14	14SS	50659 5	19
5/16" x 2-1/2" x 3-3/16"	2"	015SS	50465 2	16	15SS	50665 6	21
5/16" x 3" x 3-11/16"	2-1/2"	016SS	50471 3	18	16SS	50671 7	24
3/8" x 1" x 2-1/4"	1/2"	017SS	50474 4	17.5	17SS	50674 8	22.5
3/8" x 1-1/4" x 2-1/4"	3/4"	018SS	50477 5	18	18SS	50677 9	24
3/8" x 1-1/2" x 2-1/2"	1"	019SS	50480 5	18.5	19SS	50680 9	26
3/8" x 1-3/4" x 2-3/4"	1-1/4"	020SS	50483 6	20	20SS	50683 0	27.5
3/8" x 2" x 2-5/8"	1-1/2"	021SS	50486 7	20	21SS	50686 1	29
3/8" x 2-1/2" x 3-1/8"	2"	022SS	50489 8	24.5	22SS	50689 2	33
3/8" x 3" x 3-5/8"	2-1/2"	023SS	50492 8	26	23SS	50692 2	38
3/8" x 3-1/2" x 4-1/8"	3"	024SS	50495 9	30	24SS	50698 4	42.5
1/2" x 3" x 4-1/2"	2-1/2"	025SS	50497 3	59	25SS	50701 1	71
1/2" x 3-1/2" x 5"	3"	026SS	50500 0	64	26SS	50704 2	78
1/2" x 4" x 5-1/2"	3-1/2"	027SS	50503 1	70	27SS	50710 3	87
1/2" x 4-1/2" x 6"	4"	028SS	50506 2	75	28SS	50713 4	92.5
1/2" x 5-5/8" x 7-1/4"	5"	029SS	50509 3	90	N.A.	N.A.	N.A.
1/2" x 6-3/4" x 8-3/8"	6"	030SS	50512 3	101	N.A.	N.A.	N.A.
1/2" x 8-3/4" x 10-3/8"	8"	031SS	50515 4	120	N.A.	N.A.	N.A.
*3/4" x 10-7/8" x 13-13/16"	10"	032SS	50560 4	440	N.A.	N.A.	N.A.
*7/8" x 12-7/8" x 16-1/16"	12"	033SS	50570 3	710	N.A.	N.A.	N.A.
*7/8" x 14-1/8" x 17-5/16"	14"	034SS	50574 1	755	N.A.	N.A.	N.A.
*7/8" x 16-1/8" x 19-5/16"	16"	035SS	50578 9	850	N.A.	N.A.	N.A.

\*Full Stock Diameter with Cut Thread

See pages 32-34 for additional dimensional information.

# STAINLESS STEEL SECTION



## ROUND BEND LONG TANGENT U-BOLTS WITH 4 NUTS TYPE 304 STAINLESS STEEL

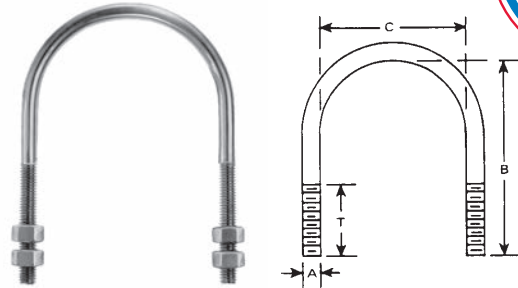

Stock No.	Part No.	Pipe Size	Diameter (A)	Inside Width (C)	Inside Length (B)	Thread Length (T)	Weight Per 100
LT-BSS	51660 0	1/2"	1/4" - 20	7/8"	2-15/16"	2-1/2"	9
LT-CSS	51665 5	3/4"	1/4" - 20	1-1/8"	3-3/16"	2-1/2"	10
LT-DSS	51670 9	1"	1/4" - 20	1-3/8"	3-7/16"	2-1/2"	11
LT-1SS	51705 8	1/2"	3/8" - 16	15/16"	3"	2-3/8"	24
LT-2SS	51710 2	3/4"	3/8" - 16	1-1/8"	3-5/16"	2-3/8"	25.5
LT-3SS	51715 7	1"	3/8" - 16	1-3/8"	3-7/16"	2-3/8"	26.5
LT-4SS	51720 1	1-1/4"	3/8" - 16	1-11/16"	3-23/32"	2-3/8"	28
LT-5SS	51725 6	1-1/2"	3/8" - 16	2"	4"	2-1/2"	30
LT-6SS	51730 0	2"	3/8" - 16	2-7/16"	4-7/16"	2-1/2"	33
LT-7SS	51735 5	2-1/2"	1/2" - 13	2-15/16"	5-7/32"	3"	71
LT-8SS	51740 9	3"	1/2" - 13	3-9/16"	5-3/4"	3"	77
LT-9SS	51745 4	3-1/2"	1/2" - 13	4-1/16"	6-1/4"	3"	82
LT-10SS	51750 8	4"	1/2" - 13	4-9/16"	6-3/4"	3"	89
LT-11SS	51755 3	5"	1/2" - 13	5-5/8"	7-13/16"	3"	101
LT-12SS	51760 7	6"	5/8" - 11	6-3/4"	9-1/2"	3-3/4"	194.5
LT-13SS	51765 2	8"	5/8" - 11	8-3/4"	11-1/8"	3-3/4"	223.5
LT-14SS	51770 6	10"	3/4" - 10	10 -7/8"	13-13/16"	4"	460

See page 35 for additional dimensional information.



## SQUARE BEND U-BOLTS WITH 2 NUTS AND 2 WASHERS TYPE 304 STAINLESS STEEL

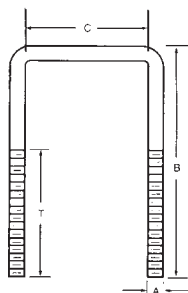

Stock No.	Part No.	Diameter (A)	Inside Width (C)	Overall Length (B)	Thread Length (T)	Weight Per 100
SB-1SS	51105 6	3/8" - 16	2"	3"	1-1/2"	25.5
SB-2SS	51110 0	3/8" - 16	2"	5"	3"	35.5
SB-3SS	51115 5	3/8" - 16	2"	7"	3-3/4"	44.5
SB-4SS	51120 9	3/8" - 16	4"	3"	1-1/2"	29.5
SB-5SS	51125 4	3/8" - 16	4"	5"	3"	40
SB-6SS	51130 8	3/8" - 16	4"	7"	3-3/4"	49.5
SB-7SS	51135 3	3/8" - 16	6"	5"	3"	44.5
SB-8SS	51140 7	3/8" - 16	6"	7"	3-3/4"	56
SB-9SS	51145 2	3/8" - 16	6"	9"	5-5/8"	63

See page 36 for additional dimensional information.



# FORMED OR FORGED FITTINGS

The schematic drawings in adjoining columns represent basic rod or wire forms and steel eye bolt forgings. Space does not permit the design illustrations of all parts that we are capable of manufacturing.

A review of complete catalog literature will indicate an extensive listing of standard stock sizes of round bend U-bolts, turned or formed eye bolts and forged steel eye bolts in several patterns.

When it is not feasible to utilize a standard product, we are prepared and equipped to manufacture requirements to specification. Inquiries are solicited.

Variation in quantity: on special items we reserve the right to a maximum 10% variation for allowances in manufacture.

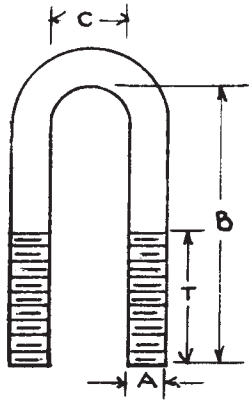

Figure No. 1

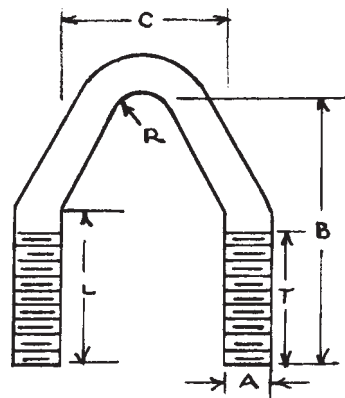

Figure No. 2

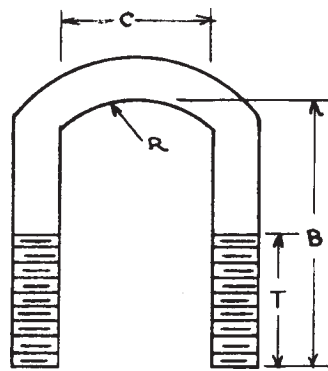

Figure No. 3

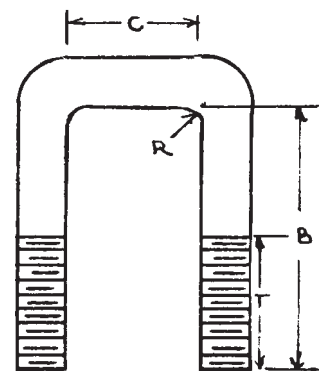

Figure No. 4

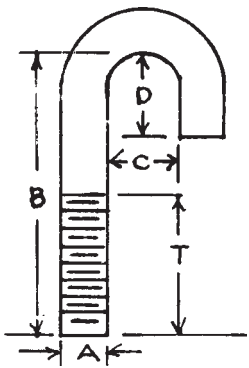

Figure No. 5

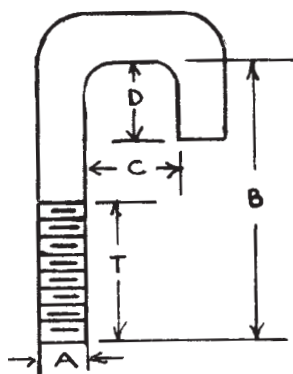

Figure No. 6

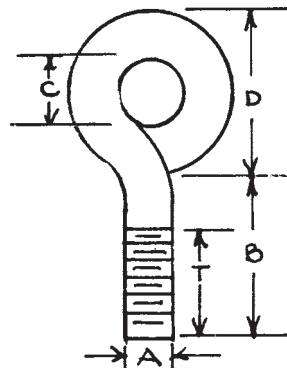

Figure No. 7

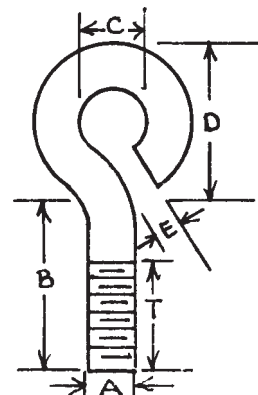

Figure No. 8

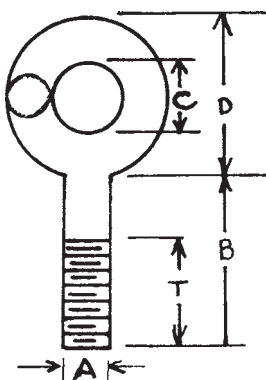

Figure No. 9

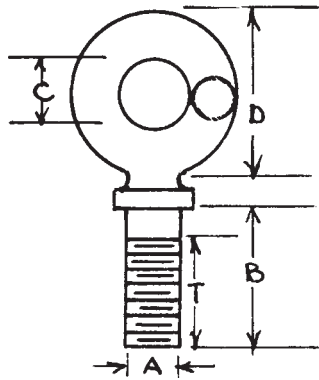

Figure No. 10

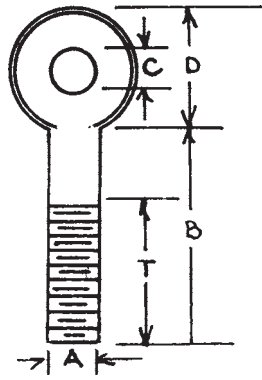
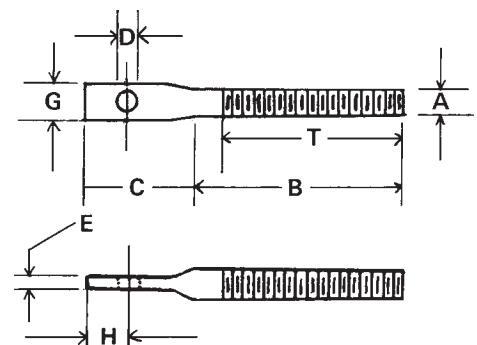

Figure No. 11



Spade Bolt



# INDEX

<b>Item</b>	<b>Page</b>	<b>Item</b>	<b>Page</b>
<b>-A-</b>			
Alloy, (B7 4140) Threaded Rod	42	Keystock, Square	43
Alloy Steel Hoist Rings	23	<b>-L-</b>	
Anchor Shackles, Round Pin, Screw Pin & Safety	9	Latch Kits for Hoist - Eye Hooks	24
Angles, Steel	44	Lifting Eyes	22
Angles, Slotted Steel	43	<b>-M-</b>	
<b>-B-</b>			
Bolts		Machinery Eye Bolts, Metric	22
Eyes, Lifting	22	Machinery Eye Bolts, Plain Pattern & Shoulder	18, 19, 20, 21
Eyes, Pad	27	Machinery Eye Bolts, Stainless Steel	48
Eye Drop Forged, Plain & Shoulder Pattern Machinery	18, 19, 21	Metric Machinery, Eye Bolts	22
Eye Drop Forged, Zinc-Plated, Hot Galvanized, Plain & Shoulder Machinery	20	<b>-N-</b>	
Eye Drop Forged, Shoulder & Plain Pattern Machinery		Nuts, Coupling	42
Stainless Steel	48	Nuts, Eye	27, 28
Eye Drop Forged Stainless Steel Regular & Shoulder Nut	47	Nuts, Eye, Stainless Steel	48
Eye Drop Forged Galvanized Regular & Shoulder Nut	14, 15	<b>-P-</b>	
Eye Drop Forged Galvanized Regular & Shoulder Screw	15	Pins, Clevis	28
Regular & Shoulder Nut Ring	16	Pins, Clevis SAE	30
Regular & Shoulder Screw Ring	17	Pad Eyes	27
Rod Ends, Blank and Black Oxide	29	<b>-R-</b>	
Rod Ends, Stainless Steel	48	Ring Bolts, Drop Forged, Galvanized Regular & Shoulder Nut	16
Turned Eye, Machine, Lag & Welded	37, 38	Ring Bolts, Drop Forged, Galvanized Regular & Shoulder Screw	17
Turned Eye, Stainless Steel	49	Rod, Threaded, Self Colored, Zinc Plated, Galvanized & Stainless Steel	39, 40, 41, 42
U-Bolts	32, 33, 34, 35, 36	Rod Ends, Drop Forged Blank, Black Oxide	29
U-Bolts, Stainless Steel	50, 51	Rod Ends, Stainless Steel	48
U-Bolts, Hot Dip Galvanized	33, 35, 36	Rod Ends, Turnbuckle	7
U-Bolt, Display	36	Rounds, Unthreaded Rod, Brass & Steel	44, 45
Brass Rounds, Flats & Angles	45	Round Pin, Anchor & Chain Shackles	9, 10
Brass Threaded Rod	41	<b>-S-</b>	
<b>-C-</b>			
Chain Shackles	10	Safety Snap Hook	25
Chain Swivels	26	Safety Swivel Hook	26
Clips, Wire Rope, Forged & Malleable	11, 12	S-Hooks	31
Clips, Wire Rope, Stainless Steel	47	S-Hooks, Stainless Steel	49
Clevis Grab Hooks	25	Shackles	
Clevis Pins	28	Round Pin, Anchor & Chain	9, 10
Clevis Pins, SAE	30	Safety, Anchor & Chain	9, 10
Coupling Nuts	42	Screw Pin, Anchor & Chain	9, 10
<b>-D-</b>			
Displays		Slotted Angles, Zinc Plated Steel	43
Full-Size Steel Center	46	Slotted Flats, Zinc Plated Steel	43
Midget Aluminum Turnbuckles	8	Square Keystock	43
Zinc Plated One Foot Threaded Rod	42	Stainless Steel	
Square Keystock	43	Eye Bolts, Regular & Shoulder Nut	47
Turned Eye Bolts	38	Machinery Eye Bolts	48
U-Bolts	36	Rod Ends	48
<b>-E-</b>			
Eye Bolts		S-Hooks	49
Machinery, Metric	22	Threaded Rod	41
Machinery, Plain & Shoulder Pattern	18, 19, 21	Turned Eye Bolts	49
Machinery, Stainless Steel	48	U-Bolts	50, 51
Machinery, Zinc Plated & Hot Galvanized	20	Wire Rope Clips	47
Regular & Shoulder Nut	14, 15	Wire Rope Thimbles	47
Regular & Shoulder Nut, Stainless Steel	47	Stub End Turnbuckles	4
Regular & Shoulder Screw	15	Swivels	
Regular & Shoulder Nut Rings Bolts	16	Eye & Eye, Jaw & Eye, Chain	26
Regular & Shoulder Screw Ring Bolts	17	<b>-T-</b>	
Turned, Machine Thread, Lag & Welded	37, 38	Thimbles, Wire Rope Regular & Heavy Duty	13
Turned, Stainless Steel	49	Thimbles, Wire Rope Stainless Steel	47
Eye Hoist Hooks	24	Threaded Rod Display	46
Eye Nuts	27, 28	Threaded Rod, Brass, Stainless Steel, B-7, Self-Colored, Zinc Plated & Hot Dip Galvanized	39, 40, 41, 42
Eye Nuts, Stainless Steel	48	Tiller Rope Clamps	11
Eye, Pad	27	Turnbuckles, Aluminum, Midget	8
Eye & Eye Swivels	26	Turnbuckles, Midget Aluminum Display	8
Eye & Eye Turnbuckles	5	Turnbuckles, Drop Forged	4, 5, 6, 7
<b>-F-</b>			
Flats, Zinc Plated Steel	44	Turnbuckles, Malleable, Midget	8
Flats, Zinc Plated Slotted Steel	43	Turned Eye Bolts, Machine & Lag Thread	37, 38
Flats, Brass	45	Turned Eye Bolts, Welded Eye	38
<b>-H-</b>			
Hoist Rings, Alloy Steel	23	Turned Eye Bolt Display	38
Hook Clevis Grab	25	Turned Eye Bolts, Stainless Steel	49
Hook & Eye Turnbuckles	6	<b>-U-</b>	
Hook & Hook Turnbuckles	5	U-Bolts, Zinc Plated Round Bend, Square Bend, Long Tangent	32, 35, 36
Hooks, Hoist, Eye	24	U-Bolt Displays	36
Hooks, S-	31	U-Bolts Hot Dip Galvanized	33, 35, 36
Hook, Safety Snap	25	U-Bolts Stainless Steel	50, 51
Hooks, Safety Swivel	26	<b>-W-</b>	
<b>-J-</b>			
Jaw & Eye Swivels	26	Washers, Bevel	31
Jaw & Eye Turnbuckles	7	Wire Rope Clips, Drop Forged & Malleable	11, 12
Jaw & Jaw Turnbuckles	7	Wire Rope Clips, Stainless Steel	47
		Wire Rope Thimbles, Regular & Heavy Duty	13
		Wire Rope Thimbles, Stainless Steel	47
		<b>-Y-</b>	
		Yoke Ends, Adjustable & Plain	30

# Notes



***Chicago Hardware and Fixture Company***

9100 Parklane Avenue • Franklin Park, Illinois 60131

Phone: (847) 455-6609 • Fax: (847) 455-0012

Web: [www.chicagohardware.com](http://www.chicagohardware.com)

Email: [info@chicagohardware.com](mailto:info@chicagohardware.com)



Look For

Made in USA



Quality

**Chicago Hardware  
and Fixture Company**

9100 Parklane Avenue · Franklin Park, Illinois 60131 · Phone: (847) 455-6609 · [www.chicagohardware.com](http://www.chicagohardware.com)