



PRODUCT CATALOG



CHISELS

SCRAPERS

PUNCHES

SPECIALTY

PRY BARS

PNEUMATIC



MAYHEW™

Since 1856

The Pros Know

Divided into two sections, this catalog lists the full breadth of MayheWPro (black-tabbed pages) and MayheWSelect (red-tabbed pages) products. Within each section, our high-quality tools are categorized by the following:



Pro Line

- Dominator
- Hard Cap
- 150
- Chisels
- Punches
- Pry Bars
- Scrapers
- Specialty
- Pneumatic
- Sets and Kits



Select Line

- Chisels
- Punches
- Pry Bars
- Scrapers
- Hand Guarded
- Picks, Awls, Hooks, Other
- Specialty
- Pneumatic
- Inspection
- Sets and Kits

For further information about any of our tools listed, please contact your sales representative or call us directly: 1.800.872.0037

Table of Contents

| Pro Line | |
|-----------------------------------------------------------------------------------|---------------------------------|
|  | Dominator 2 |
| | Pry Bars 8 |
| | Scrapers 12 |
| | Chisels 13 |
| | Punches 14 |
| | Steel Sets/Kits 18 |
| | Specialty & Extractors 26 |
| | Retail Displays 28 |
| | Brass Sets/Kits 30 |
| | 150 35 |
| | Hard Cap 36 |
| | Hollow Punch Sets 37 |
| | Automotive/Specialty 43 |
| | Pneumatic 44 |

| Select Line | |
|-------------------------------------------------------------------------------------|----------------------|
|  | Chisels 48 |
| | Punches 51 |
| | Pry Bars 53 |
| | Handguarded 55 |
| | Specialty 56 |
| | Inspection 58 |
| | Sets/Kits 60 |



The Dominator[®]

Go Ahead and Whack It!

Dominator tools mean business. With a hardened and tempered steel shaft extending through the handle and strikeable capped end, Dominator delivers the prying power and force you need to take on the toughest jobs.

Some Jobs are Tough; These Tools are Tougher

Dominator is the workhorse of the MayhewPro™ series. Uniquely designed for unparalleled strength and durability, this exclusive collection of professional-grade capped end pry bars and specialty tools stands up to punishment just as easily as it dishes it out.



- Capped end is in direct contact with the shaft and allows the user to strike the tool without damaging the handle
- Patented two-composite handle is ergonomically designed, providing superior comfort and grip

- Hardened, tempered-steel shaft runs from the cutting edge through the handle, delivering maximum durability and prying power





Pry Bars

- Used for lifting and prying
- Available in both curved and straight blade styles
- Ergonomically designed handle with a capped end that is forged through the handle for unparalleled strength and durability
- Heat treated along the entire length of the steel
- Black oxide finish for additional rust protection
- Made in the USA

| Item | Description | UPC Code | OAL | Body Size | Body Type | Blade Width | Blade Style | Weight (Lbs) | Pkg. Type |
|-------|-----------------------------------------------|-----------------|-----|-----------|-----------|-------------|-------------|--------------|-----------|
| 40128 | 36-S Dominator Straight Screwdriver Pry Bar | 0 45256 40128 7 | 36 | 5/8 | Square | N/A | Straight | 4.00 | Bulk |
| 40129 | 42-S Dominator Straight Screwdriver Pry Bar | 0 45256 40129 4 | 42 | 5/8 | Square | N/A | Straight | 4.61 | Bulk |
| 40138 | 36-C Dominator 36" Curved Screwdriver Pry Bar | 0 45256 40138 6 | 36 | 5/8 | Square | N/A | Curved | 3.95 | Bulk |
| 40139 | 42-C Dominator 42" Curved Screwdriver Pry Bar | 0 45256 40139 3 | 42 | 5/8 | Square | N/A | Curved | 4.60 | Bulk |
| 40160 | 48-C Dominator 48" Curved Screwdriver Pry Bar | 0 45256 40160 7 | 48 | 3/4 | Square | N/A | Curved | 7.95 | Bulk |
| 40162 | 58-C Dominator 58" Curved Screwdriver Pry Bar | 0 45256 40162 1 | 58 | 3/4 | Square | N/A | Curved | 9.27 | Bulk |
| 40164 | 44-C Dominator 44" Curved Screwdriver Pry Bar | 0 45256 40164 5 | 44 | 7/8 | Square | N/A | Curved | 9.80 | Bulk |
| 40166 | 45-C Dominator 45" Curved Screwdriver Pry Bar | 0 45256 40166 9 | 45 | 1 | Square | N/A | Curved | 13.20 | Bulk |
| 40170 | Dominator 30" Modified Die Bar | 0 45256 40170 6 | 30 | 1/2 | Square | N/A | N/A | 2.39 | Bulk |
| 40172 | Dominator 30" Modified Rolling Head Pry Bar | 0 45256 40172 0 | 30 | 1/2 | Square | N/A | N/A | 3.26 | Bulk |
| 60137 | 5-C Dominator | 0 45256 60137 3 | 10 | 3/8 | Square | N/A | Curved | 0.66 | Clamshell |
| 60140 | 7-C Dominator | 0 45256 60140 3 | 12 | 3/8 | Square | N/A | Curved | 0.74 | Clamshell |
| 60141 | 7-S Dominator | 0 45256 60141 0 | 12 | 3/8 | Square | N/A | Straight | 0.74 | Clamshell |
| 60143 | 12-S Dominator | 0 45256 60143 4 | 17 | 3/8 | Square | N/A | Straight | 0.93 | Clamshell |
| 60144 | 12-C Dominator | 0 45256 60144 1 | 17 | 3/8 | Square | N/A | Curved | 0.93 | Clamshell |
| 60145 | 18-S Dominator | 0 45256 60145 8 | 25 | 1/2 | Square | N/A | Straight | 2.03 | Clamshell |
| 60146 | 18-C Dominator | 0 45256 60146 5 | 25 | 1/2 | Square | N/A | Curved | 2.00 | Clamshell |
| 60147 | 24-S Dominator | 0 45256 60147 2 | 31 | 1/2 | Square | N/A | Straight | 2.45 | Clamshell |
| 60148 | 24-C Dominator | 0 45256 60148 9 | 31 | 1/2 | Square | N/A | Curved | 2.45 | Clamshell |
| 80029 | Dominator Bar Vault | 0 45256 80029 5 | 14 | N/A | N/A | N/A | N/A | 12.40 | Bulk |

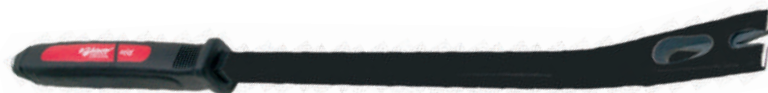

Ripping Chisel

- Used to rip apart building materials and pull apart studs
- Has handy nail slots to help remove stubborn nails when separating wood
- Black oxide finish for additional rust protection
- Made in the USA

| Item | Description | UPC Code | OAL | Body Size | Body Type | Blade Width | Blade Style | Weight (Lbs) | Pkg. Type |
|-------|------------------------------|-----------------|-----|-----------|-----------|-------------|-------------|--------------|-----------|
| 60305 | 30" Dominator Ripping Chisel | 0 45256 60305 6 | 30 | 3/4 | Square | N/A | N/A | 4.85 | Clamshell |

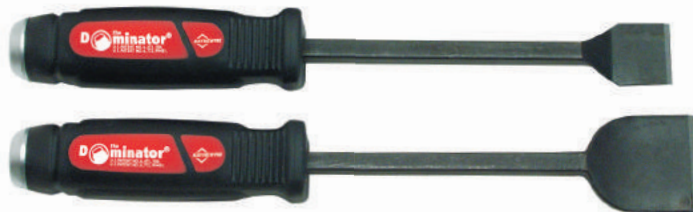

Scrapers – Straight

- Used for a multitude of applications, such as removing gaskets, rust, paint, carbon buildup, and floor tile
- Blades are ground for a sharp edge and can be resharpened after heavy use to return the cutting edge to its original sharpness
- Capped end in direct contact with the tempered steel shaft
- Patented, two-composite ergonomically designed handle provides a comfortable and secure grip
- Black oxide finish for additional rust protection
- Made in the US

| Item | Description | UPC Code | OAL | Body Size | Body Type | Blade Width | Blade Style | Weight (Lbs) | Pkg. Type |
|-------|-------------------------------------|-----------------|------|-----------|-----------|-------------|-------------|--------------|-----------|
| 42004 | 1/2" Dominator HD Scraper | 0 45256 42004 2 | 12 | 3/8 | Square | 1/2 | N/A | 0.56 | Bulk |
| 42005 | 3/4" Dominator HD Scraper | 0 45256 42005 9 | 12 | 3/8 | Square | 3/4 | N/A | 0.58 | Bulk |
| 42006 | 1" Dominator HD Scraper | 0 45256 42006 6 | 12 | 3/8 | Square | 1 | N/A | 3.89 | Bulk |
| 42007 | 1-1/2" Dominator HD Scraper | 0 45256 42007 3 | 12 | 3/8 | Square | 1-1/2 | N/A | 1.00 | Bulk |
| 62006 | 1" Dominator HD All Purpose Scraper | 0 45256 62006 0 | 10.5 | 3/8 | Square | 1 | N/A | 0.66 | Clamshell |
| 42018 | 2" Dominator HD Long Scraper | 0 4525642018 9 | 14.5 | 1/2 | Square | 2 | N/A | 1.03 | Bulk |
| 42019 | 3" Dominator HD Long Scraper | 0 4525642019 6 | 17 | 5/8 | Square | 3 | N/A | 1.62 | Bulk |



Carbon Scrapers – Angled

- U.S. Patent No. D594720
- Used for a multitude of applications, such as removing gaskets, rust, paint, carbon buildup, and floor tile
- Blades are ground for a sharp edge and can be resharpened after heavy use to return the cutting edge to sharpness
- Blade is offset for hand clearance and better scraping force in hard-to-reach places
- Capped end in direct contact with the tempered steel shaft
- Patented, two-composite ergonomically designed handle provides a comfortable and secure grip
- Black oxide finish for additional rust protection
- Made in the USA with U.S. and global components

| Item | Description | UPC Code | OAL | Body Size | Body Type | Blade Width | Blade Style | Weight (Lbs) | Pkg. Type |
|-------|---------------------------------|-----------------|-----|-----------|-----------|-------------|-------------|--------------|-----------|
| 42014 | 1/2" Dominator Angled Scraper | 0 45256 42014 1 | 12 | 3/8 | Square | 1/2 | N/A | 0.65 | Bulk |
| 42015 | 3/4" Dominator Angled Scraper | 0 45256 42015 8 | 12 | 3/8 | Square | 3/4 | N/A | 0.67 | Bulk |
| 42016 | 1" Dominator Angled Scraper | 0 45256 42016 5 | 12 | 3/8 | Square | 1 | N/A | 0.68 | Bulk |
| 42017 | 1-1/2" Dominator Angled Scraper | 0 45256 42017 2 | 12 | 3/8 | Square | 1-1/2 | N/A | 0.69 | Bulk |



Hooks & Picks

- Used for a wide variety of applications, such as automotive and electrical work in confined spaces, scribing lines, o-ring and cotter pin removal, and to break radiator connections
- Made of larger shank steel for heavy-duty applications
- Available in multiple shapes and angles for the perfect tool for the application
- Black oxide finish for additional rust protection
- Made in the US

| Item | Description | UPC Code | OAL | Body Size | Body Type | Blade Width | Blade Style | Weight (Lbs) | Pkg. Type |
|----------|----------------------------------|-----------------|-----|-----------|-----------|-------------|-------------|--------------|-----------|
| 42000 | Dominator HD Scratch Awl | 0 45256 42000 4 | 10 | 1/4 | Round | N/A | N/A | 0.35 | Bulk |
| 42001 | Dominator HD 90 Degree Hook | 0 45256 42001 1 | 10 | 1/4 | Round | N/A | N/A | 0.35 | Bulk |
| 42003 | Dominator HD Complex Hook | 0 45256 42003 5 | 10 | 1/4 | Round | N/A | N/A | 0.35 | Bulk |
| 42008 | Dominator HD C-Hook | 0 45256 42008 0 | 10 | 1/4 | Round | N/A | N/A | 0.36 | Bulk |
| 42009 | Dominator HD 15 Degree Hook | 0 45256 42009 7 | 10 | 1/4 | Round | N/A | N/A | 0.36 | Bulk |
| 42010 | Dominator HD 45 Degree Hook | 0 45256 42010 3 | 10 | 1/4 | Round | N/A | N/A | 0.36 | Bulk |
| 42011 | Dominator HD 45 Degree Long Hook | 0 45256 42011 0 | 16 | 1/4 | Round | N/A | N/A | 0.44 | Bulk |
| 42012 | Dominator HD 60 Degree Long Hook | 0 45256 42012 7 | 16 | 1/4 | Round | N/A | N/A | 0.44 | Bulk |
| 42013 | Dominator HD 90 Degree Long Hook | 0 45256 42013 4 | 16 | 1/4 | Round | N/A | N/A | 0.44 | Bulk |
| 42022 | Dominator Cotter Pin Puller | 0 45256 42022 6 | 10 | 1/4 | Round | N/A | N/A | 0.37 | Bulk |
| 42023 | Dominator 45 Degree Long Hook | 0 45256 42023 3 | 10 | 1/4 | Round | N/A | N/A | 0.37 | Bulk |
| 42024 | Dominator 90 Degree Long Hook | 0 45256 42024 0 | 10 | 1/4 | Round | N/A | N/A | 0.37 | Bulk |
| 62002 | Dominator HD Scratch Awl & Pick | 0 45256 62002 2 | 10 | 1/4 | Round | N/A | N/A | 0.42 | Clamshell |
| 42002MAY | Dominator HD Curved Hook | 0 45256 42002 8 | 10 | 1/4 | Round | N/A | Curved | 0.35 | Bulk |



Weld Wakker™

- Used to break apart spot welds or bonded panels
- Strikeable handle end cap and side edge of tool
- Patented, two-composite soft-grip handle with metal end cap for striking
- Unique two-sided cutting bevels
- Black oxide finish for additional rust protection
- Made in the US

| Item | Description | UPC Code | OAL | Body Size | Body Type | Blade Width | Blade Style | Weight (Lbs) | Pkg. Type |
|-------|-------------------------------------|-----------------|--------|-----------|-----------|-------------|-------------|--------------|-----------|
| 42020 | 3/8" X 11.75" Dominator Weld Wakker | 0 45256 42020 2 | 12-1/4 | 3/8 | Square | 1 | N/A | 0.66 | Bulk |
| 42021 | 1/2" X 14.5" Dominator Weld Wakker | 0 45256 42021 9 | 15-1/4 | 1/2 | Square | 1-1/4 | N/A | 1.19 | Bulk |



Mayhew Steel Products, Inc.
199 Industrial Blvd.
Turners Falls, MA 01376

U.S. Toll-Free Customer Service: 800-872-0037
Visit us online at www.Mayhew.com
Always wear safety goggles when using hand tools.

Version 2.2016
For the latest version, visit us
online at www.Mayhew.com

The Pros Know

Dominator

Pry Bars

Scrapers

Chisels

Punches

Steel Sets/
Kits

Specialty &
Extractors

Retail
Displays

Brass Sets/
Kits

150

Hard Cap

Hollow Punch
Sets

Automotive/
Specialty

Pneumatic

5

Sets and Kits

Dominator
 Pry Bars
 Scrapers
 Chisels
 Punches
 Steel Sets/
 Kits
 Specialty &
 Extractors
 Retail
 Displays
 Brass Sets/
 Kits
 150
 Hard Cap
 Hollow Punch
 Sets
 Automotive/
 Specialty
 Pneumatic

| Item | Description | UPC Code | OAL | Body Size | Body Type | Blade Width | Blade Style | Weight (Lbs) | Pkg. Type |
|-------|----------------------------------------------------------------------------------------------------------------------------------------------------------------------------------------------------------------------------------------------------------------------------------------------|-----------------|-----|-----------|-----------|-------------|-------------|--------------|-----------|
| 61353 | 2 Pc Dominator Screwdriver Pry Bar Set | 0 45256 61353 6 | N/A | N/A | Square | N/A | N/A | 4.31 | Tray |
| 61354 | 3 Pc Dominator Straight Screwdriver Pry Bar Set 60141 – 7-S Dominator 60143 – 12-S Dominator 60145 – 18-S Dominator | 0 45256 61354 3 | N/A | N/A | Square | N/A | Straight | 4.02 | Tray |
| 61355 | 3 Pc Dominator Curved Screwdriver Pry Bar Set 60140 – 7-C Dominator 60144 – 12-C Dominator 60146 – 18-C Dominator | 0 45256 61355 0 | N/A | N/A | Square | N/A | Curved | 4.03 | Tray |
| 61356 | 3 Pc Dominator HD Pry Bar Set 40138 – 36-C Dominator 36" Curved Screwdriver Pry Bar 60145 – 18-S Dominator 60148 – 24-C Dominator | 0 45256 61356 7 | N/A | N/A | Square | N/A | N/A | 9.10 | Tray |
| 61361 | 2 Pc Dominator Specialty Pry Bar Set 40170 – Dominator 30" Modified Die Bar 40172 – Dominator 30" Modified Rolling Head Pry Bar | 0 45256 61361 1 | N/A | N/A | Square | N/A | N/A | 5.65 | Tray |
| 61366 | 5 Pc Dominator Curved Pry Bar Set 60137 – 5-C Dominator 60140 – 7-C Dominator 60144 – 12-C Dominator 60146 – 18-C Dominator 60148 – 24-C Dominator | 0 45256 61366 6 | N/A | N/A | Square | N/A | Curved | 7.30 | Tray |
| 80027 | Dominator 8 Pc Large Pry Bar Display 40138 – 36-C Dominator 36" Curved Screwdriver Pry Bar 40139 – 42-C Dominator 42" Curved Screwdriver Pry Bar 40160 – 48-C Dominator 48" Curved Screwdriver Pry Bar 40162 – 58-C Dominator 58" Curved Screwdriver Pry Bar | 0 45256 80027 1 | N/A | N/A | Square | N/A | N/A | 3.96 | Rack |
| 60001 | 4 Pc Dominator HD Carbon Scraper Set 42004 – 1/2" Dominator HD Carbon Scraper 42005 – 3/4" Dominator HD Carbon Scraper 42006 – 1" Dominator HD Carbon Scraper 42007 – 1-1/2" Dominator HD Carbon Scraper | 0 45256 60001 7 | N/A | N/A | Square | N/A | N/A | 2.50 | Clamshell |
| 60026 | 2 Pc Dominator HD Long Carbon Scraper Set 42018 – 2" Dominator HD Long Carbon Scraper 42019 – 3" Dominator HD Long Carbon Scraper | 0 4525660026 0 | N/A | N/A | Square | N/A | N/A | 2.80 | Clamshell |
| 60004 | 4 Pc Dominator Angled Scraper Set 42014 – 1/2" Dominator HD Carbon Scraper 42015 – 3/4" Dominator HD Carbon Scraper 42016 – 1" Dominator HD Carbon Scraper 42017 – 1-1/2" Dominator HD Carbon Scraper | 0 45256 60004 8 | N/A | N/A | Square | N/A | N/A | 2.88 | Clamshell |
| 60025 | 4 Pc Dominator Utility Set 42004 – 1/2" Dominator HD Carbon Scraper 42007 – 1-1/2" Dominator HD Carbon Scraper 42000 – Dominator HD Scratch Awl 42002MAY – Dominator HD Curved Hook | 0 45256 60025 3 | N/A | N/A | Square | N/A | N/A | 2.08 | Clamshell |
| 60000 | 4 Pc Dominator HD Hook & Pick Set 42000 – Dominator HD Scratch Awl 42001 – Dominator HD 90 Degree Hook 42002MAY – Dominator HD Curved Hook 42003 – Dominator HD Complex Hook | 0 45256 60000 0 | N/A | N/A | Round | N/A | N/A | 1.62 | Clamshell |
| 60002 | 6 Pc Dominator Professional Hook & Pick Set 42008 – Dominator HD C-Hook 42009 – Dominator HD 15 Degree Hook 42010 – Dominator HD 45 Degree Hook 42011 – Dominator HD 45 Degree Long Hook 42012 – Dominator HD 60 Degree Long Hook 42013 – Dominator HD 90 Degree Long Hook | 0 45256 60002 4 | N/A | N/A | Round | N/A | N/A | 2.81 | Clamshell |
| 60008 | 4 Pc Dominator Radiator Hose Pick Set 42008 – Dominator HD C-Hook 42022 – Dominator Cotter Pin Puller 42023 – Dominator 45 Degree Long Hook 42024 – Dominator 90 Degree Long Hook | 0 45256 60008 6 | N/A | N/A | Round | N/A | N/A | 1.69 | Clamshell |
| 60005 | 2 Pc Dominator Weld Wakker Set 42020 – 3/8" x 11.75" Dominator Weld Wakker 42021 – 1/2" x 14.5" Dominator Weld Wakker | 0 45256 60005 5 | N/A | N/A | Square | N/A | N/A | 1.96 | Clamshell |



60000 – 4 Pc Dominator HD Hook & Pick Set



60008 – 4 Pc Dominator Radiator Hose Pick Set

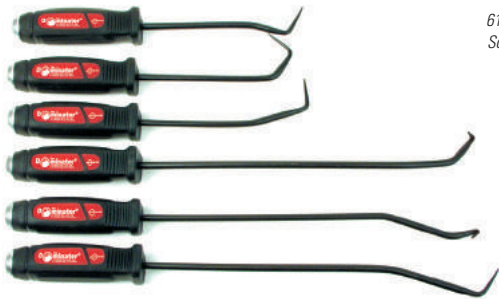

60002 – 6 Pc Dominator Professional Hook & Pick Set



60001 – 4 Pc Dominator HD Carbon Scraper Set



60004 – 4 Pc Dominator Angled Scraper Set



61353 – 2 Pc Dominator Screwdriver Pry Bar Set



61354 – 3 Pc Dominator Straight Screwdriver Pry Bar Set



61361 – 2 Pc Dominator Specialty Pry Bar Set

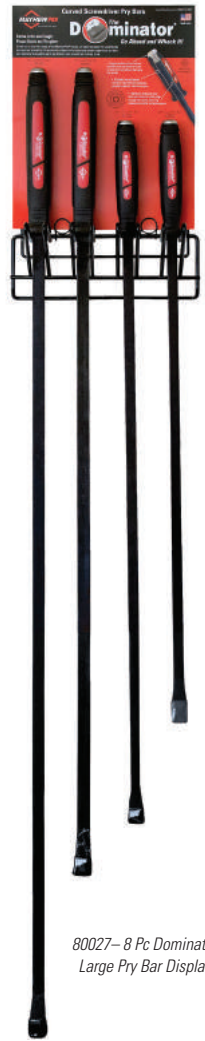

80027 – 8 Pc Dominator Large Pry Bar Display



61366 – 5 Pc Dominator Curved Pry Bar Set



60005 – 2 Pc Dominator Weld Wakker Set



60025 – 4 Pc Dominator Utility Set

Dominator

Pry Bars

Scrapers

Chisels

Punches

Steel Sets/
Kits

Specialty &
Extractors

Retail
Displays

Brass Sets/
Kits

150

Hard Cap

Hollow Punch
Sets

Automotive/
Specialty

Pneumatic



Mayhew Steel Products, Inc.
199 Industrial Blvd.
Turners Falls, MA 01376

U.S. Toll-Free Customer Service: 800-872-0037
Visit us online at www.Mayhew.com
Always wear safety goggles when using hand tools.

Version 2.2016
For the latest version, visit us
online at www.Mayhew.com

The Pros Know

Leverage Your Time Right... Now

This isn't about casual tinkering or an occasional repair. Professionals depend on their tools to work properly each and every time they pick them up—anything less than that amounts to lost time and revenue. The MayhewPro™ series is for the men and women who understand and depend on effectiveness, reliability, and durability for their livelihood. Backed by a lifetime warranty and more than 150 years of manufacturing experience, MayhewPro professional-grade tools are designed for unmatched, unwavering performance, ensuring you always have what you need to get the job done.





Professional Grade Plated Bars

- Zinc Plated
- Meets or Exceeds ASME B107.410 specs

| Item | Description | UPC Code | OAL | Body Size | Body Type | Blade Width | Weight (Lbs) | Pkg. Type |
|-------|------------------------------------|-----------------|-----|-----------|-----------|-------------|--------------|-----------|
| 49000 | 1/2" x 15" Plated Jimmy Bar | 0 45256 49000 7 | 15 | 1/2 | Round | 0.60 | 0.75 | Bulk |
| 49001 | 5/8" x 19" Plated Jimmy Bar | 0 45256 49001 4 | 19 | 5/8 | Round | 0.75 | 1.45 | Bulk |
| 49003 | 3/4" x 25" Plated Jimmy Bar | 0 45256 49003 8 | 25 | 3/4 | Round | 0.83 | 2.75 | Bulk |
| 49004 | 7/8" x 30" Plated Jimmy Bar | 0 45256 49004 5 | 30 | 7/8 | Round | 1.00 | 4.65 | Bulk |
| 49112 | 18-C Plated Curved Pry Bar | 0 45256 49112 7 | 18 | 1/2 | Square | 0.78 | 1.90 | Bulk |
| 49150 | 1/2" x 12" Plated Rolling Head Bar | 0 45256 49150 9 | 12 | 1/2 | Round | 0.63 | 0.70 | Bulk |
| 49152 | 5/8" x 16" Rolling Head Bar | 0 45256 49152 3 | 16 | 5/8 | Round | 0.75 | 1.28 | Bulk |
| 49154 | 3/4" x 25" Rolling Head Bar | 0 45256 49154 7 | 25 | 3/4 | Round | 0.88 | 2.52 | Bulk |

- If you are looking for individual UPC labeling, add UL to the end of the item number (12345UL)
- If you are looking for individual Hang Tags, add HT to the end of the item number (12345HT)

Mayhew's plated rolling head and alignment pry bars feature two work ends that are preferred during vehicle assembly, disassembly and adjustment operations. Ideal for prying, positioning, lifting and aligning applications that need greater leverage. When the job is done these specialty plated pry bars are easy to clean and ready for the next heavy duty project. While perfect for the automotive mechanic, Mayhew's plated bars are also ideally suited for agriculture, mining, industrial MRO, construction, oil and gas, rigging operations and more. USA made, professional grade, lifetime warranty. Available in open stock and in three piece assorted sets.



Professional Grade Plated Bar Sets

| Item | Description | UPC Code | OAL | Body Size | Body Type | Weight (Lbs) | Pkg. Type |
|-------|-----------------------------------------------------------------------------------------------------------------------------------------------------------|-----------------|-----|-----------|-----------|--------------|-----------|
| 69150 | 3 Pc Rolling Head Pry Bar Set 49150 – 1/2" x 12" Plated Rolling Head Bar 49152 – 5/8" x 16" Rolling Head Bar 49154 – 3/4" x 21" Rolling Head Bar | 0 45256 69150 3 | N/A | N/A | Round | 5.05 | Tray |
| 69151 | 3 Pc Jimmy Bar Set 49000 – 1/2" x 15" Plated Jimmy Bar 49001 – 5/8" x 19" Plated Jimmy Bar 49003 – 3/4" x 25" Plated Jimmy Bar | 0 45256 69151 0 | N/A | N/A | Round | 5.35 | Tray |
| 69152 | 3 Pc Pry Bar Set 49150 – 1/2" x 12" Plated Rolling Head Bar 49000 – 1/2" x 15" Plated Jimmy Bar 49112 – 18-C Plated Curved Pry Bar | 0 45256 69152 7 | N/A | N/A | Round | 3.85 | Tray |

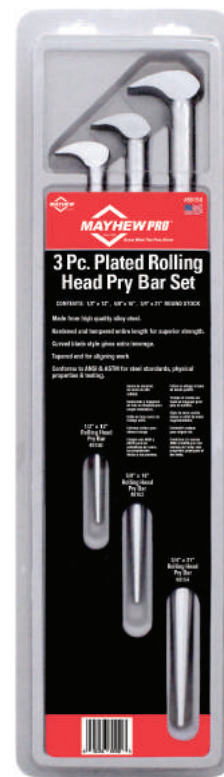

Mayhew Steel Products, Inc.
199 Industrial Blvd.
Turners Falls, MA 01376

U.S. Toll-Free Customer Service: 800-872-0037
Visit us online at www.Mayhew.com
Always wear safety goggles when using hand tools.

Version 2.2016
For the latest version, visit us
online at www.Mayhew.com

The Pros Know

Dominator

Pry Bars

Scrapers

Chisels

Punches

Steel Sets/
Kits

Specialty &
Extractors

Retail
Displays

Brass Sets/
Kits

150

Hard Cap

Hollow Punch
Sets

Automotive/
Specialty

Pneumatic

9



Die Separating Bar

- Used to separate and remove die blocks and plates; pointed end to separate and curved end to help remove them
- Made in the USA

| Item | Description | UPC Code | OAL | Body Size | Body Type | Blade Width | Blade Style | Weight (Lbs) | Pkg. Type |
|-------|----------------------------------|-----------------|-----|-----------|-----------|-------------|-------------|--------------|-----------|
| 41285 | 30" Die Bar (Shot-Blast Finish) | 0 45256 41285 6 | 30 | 5/8 | Hex | 0 | N/A | 2.95 | Bulk |
| 41280 | 18" Die Bar (Black Oxide Finish) | 0 45256 41280 1 | 18 | 5/8 | Hex | 0 | N/A | 1.92 | Bulk |



Ladyfoot Pry Bar

- Rocking head used for prying in small areas; other end used to align
- Solid forged head for superior strength
- Variable lengths available for use in hard-to-reach or confined locations
- Black oxide finish for additional rust protection
- Made in the USA

| Item | Description | UPC Code | OAL | Body Size | Body Type | Blade Width | Blade Style | Weight (Lbs) | Pkg. Type |
|-------|-----------------------------|-----------------|-----|-----------|-----------|-------------|-------------|--------------|-----------|
| 40150 | 1/2" X 12" Ladyfoot Pry Bar | 0 45256 40150 8 | 12 | 7/16 | Round | 0 | N/A | 0.46 | Bulk |
| 40152 | 5/8" X 16" Ladyfoot Pry Bar | 0 45256 40152 2 | 16 | 5/8 | Round | 0 | N/A | 1.05 | Bulk |
| 40154 | 3/4" X 21" Ladyfoot Pry Bar | 0 45256 40154 6 | 21 | 1-1/16 | Round | 0 | N/A | 1.99 | Bulk |



Line-Up Pry Bar

- Long, tapered end for aligning and adjusting metal or wood
- Angled chisel end for extra leverage when prying
- Available in a variety of lengths for work in hard-to-reach spots and more leverage
- Available in black oxide finish for additional rust protection
- Made in the USA

| Item | Description | UPC Code | OAL | Body Size | Body Type | Blade Width | Blade Style | Weight (Lbs) | Pkg. Type |
|-------|---------------------|-----------------|-----|-----------|-----------|-------------|-------------|--------------|-----------|
| 40000 | 14" Line-Up Pry Bar | 0 45256 40000 6 | 14 | 1/2 | Hex | 5/8 | N/A | 0.72 | Bulk |
| 40001 | 16" Line-Up Pry Bar | 0 45256 40001 3 | 16 | 5/8 | Hex | 3/4 | N/A | 1.21 | Bulk |
| 40002 | 20" Line-Up Pry Bar | 0 45256 40002 0 | 20 | 3/4 | Hex | 7/8 | N/A | 2.23 | Bulk |
| 40003 | 24" Line-Up Pry Bar | 0 45256 40003 7 | 24 | 3/4 | Hex | 7/8 | N/A | 2.76 | Bulk |
| 40022 | 38" Line-Up Pry Bar | 0 45256 40022 8 | 38 | 3/4 | Hex | 3/8 | N/A | 4.81 | Bulk |
| 40023 | 42" Line-Up Pry Bar | 0 45256 40023 5 | 42 | 7/8 | Hex | 7/16 | N/A | 7.34 | Bulk |
| 40024 | 60" Line-Up Pry Bar | 0 45256 40024 2 | 60 | 1 | Hex | 3/8 | N/A | 14.23 | Bulk |
| 75004 | 30" Line-Up Pry Bar | 0 45256 75004 0 | 30 | 7/8 | Hex | 1.0 | N/A | 4.10 | Bulk |



Rolling Head Pry Bar

- Long, tapered end for aligning and adjusting metal or wood
- 90 degree angled chisel end for extra leverage when prying
- Rolling head provides extra leverage and helps dislodge heavy items
- Available in variable lengths for applications in hard-to-reach locations
- Black oxide finish for additional rust protection
- Made in the USA

| Item | Description | UPC Code | OAL | Body Size | Body Type | Blade Width | Blade Style | Weight (Lbs) | Pkg. Type |
|-------|--------------------------|-----------------|-----|-----------|-----------|-------------|-------------|--------------|-----------|
| 40100 | 9" Rolling Head Pry Bar | 0 45256 40100 3 | 9 | 3/8 | Hex | 0 | N/A | 0.92 | Bulk |
| 40101 | 16" Rolling Head Pry Bar | 0 45256 40101 0 | 16 | 1/2 | Hex | 0 | N/A | 0.92 | Bulk |
| 40102 | 18" Rolling Head Pry Bar | 0 45256 40102 7 | 18 | 5/8 | Hex | 0 | N/A | 1.55 | Bulk |
| 40104 | 22" Rolling Head Pry Bar | 0 45256 40104 1 | 22 | 3/4 | Hex | 0 | N/A | 2.75 | Bulk |

Dominator

Pry Bars

Scrapers

Chisels

Punches

Steel Sets/
Kits

Specialty &
Extractors

Retail
Displays

Brass Sets/
Kits

150

Hard Cap

Hollow Punch
Sets

Automotive/
Specialty

Pneumatic

10



76295 – 4 Pc Utility Pry Bar Set

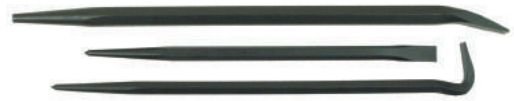

61306 – 3 Pc Line-Up Pry Bar Set

Pry Bar Sets

| Item | Description | UPC Code | OAL | Body Size | Body Type | Blade Width | Blade Style | Weight (Lbs) | Pkg. Type |
|-------|---------------------------------------------------------------------------------------------------------------------------------------------------------------------------------------------------------------------------------------------------------------------------------------------------------------------------------------------------------------------------------------------------------------------------------------|-----------------|--------|-----------|-----------|-------------|-------------|--------------|-----------|
| 60150 | 3 Pc Ladyfoot Pry Bar Set 40150 – 1/2 X 12" Ladyfoot Pry Bar 40152 – 5/8 X 16" Ladyfoot Pry Bar 40154 – 3/4 X 21" Ladyfoot Pry Bar | 0 45256 60150 2 | N/A | N/A | Round | N/A | N/A | 3.75 | Tray |
| 61306 | 3 Pc Line-Up Pry Bar Set 40000 – Reg 14" Line-Up Pry Bar 40002 – Reg 20" Line-Up Pry Bar 40101 – Reg 16" Rolling Head Pry Bar | 0 45256 61306 2 | N/A | N/A | Hex | N/A | N/A | 4.25 | Tray |
| 61350 | 3 Pc Screwdriver Pry Bar Set 40110 – 7-C Reg 12" OAL Curved Screwdriver Pry Bar 40111 – 12-C Reg 17" OAL Curved Screwdriver Pry Bar 40112 – 18-C Reg 25" OAL Curved Screwdriver Pry Bar | 0 45256 61350 5 | N/A | N/A | Square | N/A | Curved | 3.65 | Tray |
| 61352 | 2 Pc Screwdriver Pry Bar Set 40109 – 24-C Reg 31" OAL Curved Screwdriver Pry Bar 40112 – 18-C Reg 25" OAL Curved Screwdriver Pry Bar | 0 45256 61352 9 | N/A | N/A | Square | N/A | Curved | 4.65 | Tray |
| 76295 | 4 Pc Utility Pry Bar Set 40001 – Reg 16" Line-Up Pry Bar 40152 – 5/8 X 16" Ladyfoot Pry Bar 60144 – 12-C Dominator 98602 – Mini Utility Bar | 0 45256 76295 1 | 20-1/4 | N/A | N/A | N/A | N/A | 4.03 | Tray |
| 80026 | #16 Singles Display, Pry Bars 60000 – 4 Pc Dominator HD Hook & Pick Set 60001 – 4 Pc Dominator HD Carbon Scraper 60137 – 5-C Dominator 60140 – 7-C Dominator 60144 – 12-C Dominator 60146 – 18-C Dominator 60148 – 24-C Dominator 60150 – 3 Pc Ladyfoot Pry Bar Set 61353 – 2 Pc Dominator Screwdriver Pry Bar Set 61355 – 3 Pc Dominator Curved Screwdriver Pry Bar Set 76284 – 4 Pc Ec Pry Bar Set | 0 45256 80026 4 | N/A | N/A | Square | N/A | N/A | 97.06 | Wire Rack |



Deck Wrecker

- Mayhew's specialty demolition tool, the Deck Wrecker, is used to rip up boards of any decking material used in the construction of decks and other similar structures
- The double prying head fits over a double or single joist for maximum leverage
- Available in a powder-coated finish
- Made in the USA

| Item | Description | UPC Code | OAL | Body Size | Body Type | Blade Width | Blade Style | Weight (Lbs) | Pkg. Type |
|-------|------------------------------|-----------------|--------|-----------|-----------|-------------|-------------|--------------|-----------|
| 41104 | Deck Wrecker | 0 45256 41104 0 | 45-1/2 | 0 | Round | 0 | N/A | 8.70 | Bulk |
| 41105 | Deck Wrecker w/Indexing Head | 0 45256 41105 0 | 33-1/2 | 1" | Round | 0 | N/A | 8.70 | Bulk |

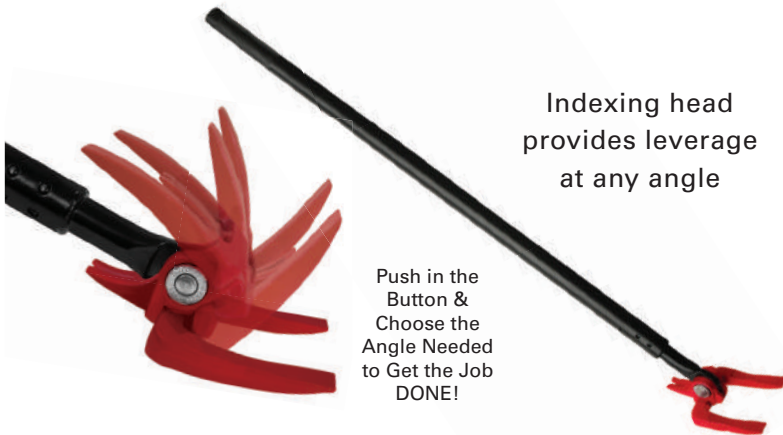

Indexing head provides leverage at any angle

Push in the Button & Choose the Angle Needed to Get the Job DONE!

- Easy to adjust indexing feature works with the touch of a button
- Adjusting the head angle provides the most leverage and comfortable working position
- Designed for removing decking and general deconstruction
- Made from forged alloy steel
- Reverse the indexing head to remove nails with the nail puller.



Mayhew Steel Products, Inc.
199 Industrial Blvd.
Turners Falls, MA 01376

U.S. Toll-Free Customer Service: 800-872-0037
Visit us online at www.Mayhew.com
Always wear safety goggles when using hand tools.

Version 2.2016
For the latest version, visit us
online at www.Mayhew.com

The Pros Know

Dominator

Pry Bars

Scrapers

Chisels

Punches

Steel Sets/
Kits

Specialty &
Extractors

Retail
Displays

Brass Sets/
Kits

150

Hard Cap

Hollow Punch
Sets

Automotive/
Specialty

Pneumatic

11



Screwdriver-Style Pry Bars

- Used for prying and lifting
- Available in both a curved and straight blade style
- Variable lengths available for work in hard-to-reach locations
- Durable acetate handle provides a more comfortable and secure grip
- Black oxide finish for additional rust protection
- Made in the USA

| Item | Description | UPC Code | OAL | Body Size | Body Type | Blade Width | Blade Style | Weight (Lbs) | Pkg. Type |
|-------|------------------------------------------|-----------------|-----|-----------|-----------|-------------|-------------|--------------|-----------|
| 35724 | Screwdriver 5/16" X 28" | 0 45256 35724 9 | 28 | 1/4 | Square | 5/16 | N/A | 2.19 | Bulk |
| 40106 | 17" Straight Screwdriver Pry Bar | 0 45256 40106 5 | 17 | 3/8 | Square | 0 | Straight | 5.38 | Bulk |
| 40108 | 25" Straight Screwdriver Pry Bar | 0 45256 40108 9 | 25 | 1/2 | Square | 0 | Straight | 1.50 | Bulk |
| 40109 | 31" OAL Curved Screwdriver Pry Bar | 0 45256 40109 6 | 31 | 1/2 | Square | 0 | Curved | 2.00 | Bulk |
| 40110 | 12" OAL Curved Screwdriver Pry Bar | 0 45256 40110 2 | 12 | 3/8 | Square | 0 | Curved | 0.33 | Bulk |
| 40111 | 17" OAL Curved Screwdriver Pry Bar | 0 45256 40111 9 | 17 | 3/8 | Square | 0 | Curved | 0.53 | Bulk |
| 40112 | 25" OAL Curved Screwdriver Pry Bar | 0 45256 40112 6 | 25 | 1/2 | Square | 0 | Curved | 1.50 | Bulk |
| 40113 | 24S Reg 31" Straight Screwdriver Pry Bar | 0 45256 40113 3 | 31 | 1/2 | Square | 0 | Straight | 2.00 | Bulk |



Scrapers

- Used for a multitude of applications, such as removing gaskets, rust, paint, carbon buildup, and floor tile
- Blades are ground for a sharp edge and can be resharpened after heavy use to return the cutting edge to sharpness
- Available in straight and curved blades
- Black oxide finish for additional rust protection
- Made in the USA

| Item | Description | UPC Code | OAL | Body Size | Body Type | Blade Width | Blade Style | Weight (Lbs) | Pkg. Type |
|-------|----------------|-----------------|-------|-----------|-----------|-------------|-------------|--------------|-----------|
| 37039 | Carbon Scraper | 0 45256 37039 2 | 9-3/4 | 1/4 | Square | 1 | N/A | 1.08 | Bulk |
| 37040 | Carbon Scraper | 0 45256 37040 8 | 13 | 3/8 | Square | 1-1/2 | N/A | 2.10 | Bulk |
| 37241 | Offset Scraper | 0 45256 37241 9 | 6-1/4 | 1/4 | Square | 5/8 | N/A | 1.03 | Bulk |
| 37243 | 5/8" Scraper | 0 45256 37243 3 | 5-1/4 | 1/4 | Square | 5/8 | N/A | 0.74 | Bulk |
| 37245 | Stubby Scraper | 0 45256 37245 7 | 7 | 1/4 | Square | 1 | N/A | 0.71 | Bulk |

Scraper Set

| Item | Description | UPC Code | OAL | Body Size | Body Type | Blade Width | Blade Style | Weight (Lbs) | Pkg. Type |
|-------|------------------------------------------------------------------------------------------------------------------------|-----------------|-----|-----------|-----------|-------------|-------------|--------------|-----------|
| 37365 | 4 Pc Scraper Set 37039 – Carbon Scraper 37241 – Offset Scraper 37243 – 5/8" Scraper 37245 – Stubby Scraper | 0 45256 37365 2 | N/A | N/A | N/A | N/A | N/A | 1.05 | Clamshell |



Cold Chisels

- Used to cut and shape metals softer than the cutting edge of the chisel
- Cutting-edge angle designed to provide greater strength
- Not intended to be used on masonry materials
- Available in a variety of lengths and sizes to fit any application
- Available in black oxide finish for additional rust protection
- Made in the USA

| Item | Description | UPC Code | OAL | Body Size | Body Type | Blade Width | Blade Style | Weight (Lbs) | Pkg. Type |
|---------------------------|------------------------------|--------------|-------|-----------|-----------|-------------|-------------|--------------|-----------|
| 10200 | COLD CHISEL 1/4-6MM X 5 | 045256102009 | 5 | 0.25 | hex | 1/4-6mm | N/A | 0.0772 | Bulk |
| 10237 | COLD CHISEL 9/32-7mm X 5 | 045256102375 | 5 | 0.25 | hex | 9/32-7mm | N/A | 0.0772 | Bulk |
| 10201 | COLD CHISEL 5/16-8mm X 5 | 045256102016 | 5 | 0.25 | hex | 5/16-8mm | N/A | 0.0772 | Bulk |
| 10202MAY | COLD CHISEL 3/8-10mm X 5-1/2 | 045256102023 | 5-1/2 | 0.312 | hex | 3/8-10mm | N/A | 0.1204 | Bulk |
| 10204 | COLD CHISEL 7/16-11mm X 6 | 045256102047 | 6 | 0.375 | hex | 7/16-11mm | N/A | 0.208 | Bulk |
| 10205 | COLD CHISEL 1/2-13mm X 6 | 045256102054 | 6 | 0.437 | hex | 1/2-13mm | N/A | 0.26 | Bulk |
| 10209 | COLD CHISEL 5/8-16mm X 6-1/2 | 045256102092 | 6-1/2 | 0.5 | hex | 5/8-16mm | N/A | 0.4004 | Bulk |
| 10212 | COLD CHISEL 3/4-19mm X 7 | 045256102122 | 7 | 0.625 | hex | 3/4-19mm | N/A | 0.6737 | Bulk |
| 10216 | COLD CHISEL 7/8-22mm X 7-1/2 | 045256102160 | 7-1/2 | 0.75 | hex | 7/8-22mm | N/A | 1.0394 | Bulk |
| 10220 | COLD CHISEL 1-25mm X 8 | 045256102207 | 8 | 0.875 | hex | 1-25mm | N/A | 1.5085 | Bulk |
| Long Chisels | | | | | | | | | |
| 10206 | COLD CHISEL 1/2-13mm X 9 | 045256102061 | 9 | 0.437 | hex | 1/2-13mm | N/A | 0.39 | Bulk |
| 10207 | COLD CHISEL 1/2-13mm X 12 | 045256102078 | 12 | 0.437 | hex | 1/2-13mm | N/A | 0.5636 | Bulk |
| 10210 | COLD CHISEL 5/8-16mm X 12 | 045256102108 | 12 | 0.5 | hex | 5/8-16mm | N/A | 0.7376 | Bulk |
| 10213 | COLD CHISEL 3/4-19mm X 12 | 045256102139 | 12 | 0.625 | hex | 3/4-19mm | N/A | 1.1528 | Bulk |
| 10217 | COLD CHISEL 7/8-22mm X 12 | 045256102177 | 12 | 0.75 | hex | 7/8-22mm | N/A | 1.66 | Bulk |
| 10221 | COLD CHISEL 1-25mm X 12 | 045256102214 | 12 | 0.75 | hex | 1-25mm | N/A | 1.6605 | Bulk |
| Extra Long chisels | | | | | | | | | |
| 10215 | COLD CHISEL 3/4-19mm X 18 | 045256102153 | 18 | 0.625 | hex | 3/4-19mm | N/A | 1.7278 | Bulk |
| 10219 | COLD CHISEL 7/8-22mm X 18 | 045256102191 | 18 | 0.75 | hex | 7/8-22mm | N/A | 2.4887 | Bulk |
| 10222 | COLD CHISEL 1-25mm X 18 | 045256102221 | 18 | 0.75 | hex | 1-25mm | N/A | 2.4887 | Bulk |



Cape Chisels

- Also known as a slot chisel
- Used to cut flat grooves for keyways or slots
- Narrows to a flat cutting end for precision
- Available in varying cuts and lengths, for varying sizes of grooves
- Black oxide finish for additional rust prevention
- Made in the USA

| Item | Description | UPC Code | OAL | Body Size | Body Type | Blade Width | Blade Style | Weight (Lbs) | Pkg. Type |
|----------|-----------------------|-----------------|-------|-----------|-----------|-------------|-------------|--------------|-----------|
| 10400 | 1/8" Reg Cape Chisel | 0 45256 10400 3 | 5-1/2 | 5/16 | Hex | 1/8 | N/A | 0.10 | Bulk |
| 10401 | 3/16" Reg Cape Chisel | 0 45256 10401 0 | 5-5/8 | 3/8 | Hex | 3/16 | N/A | 0.15 | Bulk |
| 10402MAY | 1/4" Reg Cape Chisel | 0 45256 10402 7 | 5-5/8 | 3/8 | Hex | 1/4 | N/A | 0.12 | Bulk |
| 10403 | 5/16" Reg Cape Chisel | 0 45256 10403 4 | 6-1/4 | 1/2 | Hex | 5/16 | N/A | 0.30 | Bulk |
| 10404 | 3/8" Reg Cape Chisel | 0 45256 10404 1 | 7 | 5/8 | Hex | 3/8 | N/A | 0.50 | Bulk |
| 10405 | 1/2" Reg Cape Chisel | 0 45256 10405 8 | 8 | 3/4 | Hex | 1/2 | N/A | 0.85 | Bulk |



Half Round Nose Chisels

- Also known as gouge chisels
- Used for cutting round grooves in metal
- Many specialized uses such as cutting semicircular grooves for oilways in bearings
- Available in varying cuts for the perfect groove
- Black oxide finish for additional rust protection
- Made in the USA

| Item | Description | UPC Code | OAL | Body Size | Body Type | Blade Width | Blade Style | Weight (Lbs) | Pkg. Type |
|----------|------------------------------|-----------------|-------|-----------|-----------|-------------|-------------|--------------|-----------|
| 10500 | 1/8" Half Round Nose Chisel | 0 45256 10500 0 | 5-1/2 | 5/16 | Hex | 1/8 | N/A | 0.10 | Bulk |
| 10501 | 3/16" Half Round Nose Chisel | 0 45256 10501 7 | 5-1/2 | 3/8 | Hex | 3/16 | N/A | 0.15 | Bulk |
| 10502MAY | 1/4" Half Round Nose Chisel | 0 45256 10502 4 | 5-3/4 | 3/8 | Hex | 1/4 | N/A | 0.32 | Bulk |
| 10503 | 5/16" Half Round Nose Chisel | 0 45256 10503 1 | 6-1/4 | 1/2 | Hex | 5/16 | N/A | 0.32 | Bulk |
| 10504 | 3/8" Half Round Nose Chisel | 0 45256 10504 8 | 7 | 5/8 | Hex | 3/8 | N/A | 0.53 | Bulk |
| 10505 | 1/2" Half Round Nose Chisel | 0 45256 10505 5 | 8 | 3/4 | Hex | 1/2 | N/A | 0.86 | Bulk |



Mayhew Steel Products, Inc.
199 Industrial Blvd.
Turners Falls, MA 01376

U.S. Toll-Free Customer Service: 800-872-0037
Visit us online at www.Mayhew.com
Always wear safety goggles when using hand tools.

Version 2.2016
For the latest version, visit us
online at www.Mayhew.com

The Pros Know

Dominator
Pry Bars
Scrapers
Chisels
Punches
Steel Sets/
Kits
Specialty &
Extractors
Retail
Displays
Brass Sets/
Kits
150
Hard Cap
Hollow Punch
Sets
Automotive/
Specialty
Pneumatic
13



Diamond Point Chisels

- Used to make a v-shaped groove in metal, provides a sharp pointed bottom to the grooves
- Available in varying cuts and lengths, for varying sizes of grooves
- Black oxide finish for additional rust protection
- Made in the USA

| Item | Description | UPC Code | OAL | Body Size | Body Type | Blade Width | Blade Style | Weight (Lbs) | Pkg. Type |
|----------|--------------------------------|-----------------|-------|-----------|-----------|-------------|-------------|--------------|-----------|
| 10600 | 1/8" Reg Diamond Point Chisel | 0 45256 10600 3 | 5 | 5/16 | Hex | 1/8 | N/A | 0.10 | Bulk |
| 10601 | 3/16" Reg Diamond Point Chisel | 0 45256 10601 0 | 5-1/2 | 3/8 | Hex | 3/16 | N/A | 0.12 | Bulk |
| 10602MAY | 1/4" Reg Diamond Point Chisel | 0 45256 10602 7 | 5-3/4 | 3/8 | Hex | 1/4 | N/A | 0.17 | Bulk |
| 10603 | 5/16" Reg Diamond Point Chisel | 0 45256 10603 8 | 6 | 1/2 | Hex | 5/16 | N/A | 0.31 | Bulk |
| 10604 | 3/8" Reg Diamond Point Chisel | 0 45256 10604 5 | 7 | 5/8 | Hex | 3/8 | N/A | 0.55 | Bulk |
| 10605MAY | 1/2" Reg Diamond Point Chisel | 0 45256 10605 2 | 7 | 3/4 | Hex | 1/2 | N/A | 0.78 | Bulk |



Bearing Race Punches

- Used to remove bearing races in automotive and industrial settings
- Larger tips are designed for larger bearing sizes
- Specially heat-treated steel makes these tools ideal for stubborn bearing races
- Black oxide finish for additional rust protection
- Made in the USA

| Item | Description | UPC Code | OAL | Body Size | Body Type | Blade Width | Blade Style | Weight (Lbs) | Pkg. Type |
|-------|--------------------------|-----------------|-----|-----------|-----------|-------------|-------------|--------------|-----------|
| 24548 | 7/16" Bearing Race Punch | 0 45256 24548 5 | 6 | 3/8 | Hex | 7/16 | N/A | 0.20 | Bulk |
| 24549 | 1/2" Bearing Race Punch | 0 45256 24549 2 | 10 | 7/16 | Hex | 1/2 | N/A | 0.50 | Bulk |
| 24550 | 5/8" Bearing Race Punch | 0 45256 24550 8 | 20 | 9/16 | Hex | 5/8 | N/A | 1.51 | Bulk |
| 24551 | 9/16" Bearing Race Punch | 0 45256 24551 5 | 14 | 1/2 | Hex | 9/16 | N/A | 0.83 | Bulk |



Center Punches

- Used for piercing, or marking for starting drills, in metal and other materials
- Point sizes vary for larger or smaller holes
- If you want to scribe lines in metal, consider a prick punch
- Available in black oxide finish for additional rust protection
- Made in the USA

| Item | Description | UPC Code | OAL | Body Size | Body Type | Point Size | Blade Style | Weight (Lbs) | Pkg. Type |
|-------|-------------------------------|--------------|-------|-----------|-----------|------------|-------------|--------------|-----------|
| 24005 | CENTER PUNCH 1/16-1.5mm x 4 | 045256240053 | 4 | 0.25 | hex | 1/16-1.5mm | N/A | 0.05 | Bulk |
| 24006 | CENTER PUNCH 5/64-2mm x 4 | 045256240060 | 4 | 0.25 | hex | 5/64-2mm | N/A | 0.05 | Bulk |
| 24000 | CENTER PUNCH 3/32-2.5mm x 4 | 045256240008 | 4 | 0.25 | hex | 3/32-2.5mm | N/A | 0.04 | Bulk |
| 24007 | CENTER PUNCH 1/8-3mm x 4-1/4 | 045256240077 | 4-1/4 | 0.312 | hex | 1/8-3mm | N/A | 0.09 | Bulk |
| 24001 | CENTER PUNCH 5/32-4mm x 4-1/2 | 045256240015 | 4-1/2 | 0.312 | hex | 5/32-4mm | N/A | 0.09 | Bulk |
| 24002 | CENTER PUNCH 3/16-5mm x 5 | 045256240022 | 5 | 0.375 | hex | 3/16-5mm | N/A | 0.15 | Bulk |
| 24008 | CENTER PUNCH 1/4-6mm x 5-1/2 | 045256240084 | 5-1/2 | 0.437 | hex | 1/4-6mm | N/A | 0.23 | Bulk |
| 24003 | CENTER PUNCH 5/16-8mm x 6 | 045256240039 | 6 | 0.5 | hex | 5/16-8mm | N/A | 0.34 | Bulk |
| 24004 | CENTER PUNCH 3/8-10mm x 6-1/4 | 045256240046 | 6-1/4 | 0.625 | hex | 3/8-10mm | N/A | 0.5 | Bulk |



Prick Punches

- Used to scribe lines in metal before cutting or riveting
- Variable point sizes for different width marks
- Sharper angle specifically designed to scribe lines in metal
- Available in black oxide finish for additional rust protection
- Made in the USA

| Item | Description | UPC Code | OAL | Body Size | Body Type | Point Size | Blade Style | Weight (Lbs) | Pkg. Type |
|-------|------------------------------|--------------|-------|-----------|-----------|------------|-------------|--------------|-----------|
| 23000 | PRICK PUNCH 3/32-2.5mm x 4 | 045256230009 | 4 | 0.25 | hex | 3/32-2.5mm | N/A | 0.04 | Bulk |
| 23001 | PRICK PUNCH 3/16-5mm x 4-1/2 | 045256230016 | 4-1/2 | 0.312 | hex | 3/16-5mm | N/A | 0.09 | Bulk |
| 23002 | PRICK PUNCH 5/32-4mm x 5 | 045256230023 | 5 | 0.375 | hex | 5/32-4mm | N/A | 0.15 | Bulk |
| 23003 | PRICK PUNCH 1/8-3mm x 6 | 045256230030 | 6 | 0.5 | hex | 1/8-3mm | N/A | 0.28 | Bulk |

Dominator
Pry Bars
Scrapers
Chisels
Punches
Steel Sets/
Kits
Specialty &
Extractors
Retail
Displays
Brass Sets/
Kits
150
Hard Cap
Hollow Punch
Sets
Automotive/
Specialty
Pneumatic
14



Line-Up Punches or Drift Punches

- Used to align holes through which rivets, pins, or bolts will be inserted
- Not for use when driving pins, rivets, or bolts
- Variable point size, shank size, and taper length for the perfect alignment
- Available in black oxide finish for additional rust protection
- Made in the USA

| Item | Description | UPC Code | OAL | Body Size | Body Type | Point Size | Taper Length | Weight (Lbs) | Pkg. Type |
|---------------------------------------|-----------------------------|--------------|-----|-----------|-----------|------------|--------------|--------------|-----------|
| Regular Line-Up or Drift Punch | | | | | | | | | |
| 22021 | LINE-UP PUNCH 3/32 X 8 | 045256220215 | 8 | 0.312 | hex | 3/32 | 3-1/2 | 0.13 | Bulk |
| 22010 | LINE-UP PUNCH 1/8-3mm X 8 | 045256220109 | 8 | 0.312 | hex | 1/8 - 3mm | 3-1/2 | 0.15 | Bulk |
| 22011 | LINE-UP PUNCH 5/32-4mm X 9 | 045256220116 | 9 | 0.375 | hex | 5/32 - 4mm | 4-1/2 | 0.23 | Bulk |
| 22000 | LINE-UP PUNCH 5/32 X 8 | 045256220000 | 8 | 0.5 | hex | 5/32 - 4mm | 4-1/2 | 0.35 | Bulk |
| 22012 | LINE-UP PUNCH 3/16 X 10 | 045256220123 | 10 | 0.5 | hex | 3/16 | 5 | 0.44 | Bulk |
| 22025 | LINE-UP PUNCH 7/32 X 10 | 045256220253 | 10 | 0.5 | hex | 7/32 | 5 | 0.45 | Bulk |
| 22003 | LINE-UP PUNCH 1/4 X 12 | 045256220031 | 12 | 0.625 | hex | 1/4 | 6-3/4 | 0.82 | Bulk |
| 22005 | LINE-UP PUNCH 1/4 X 15 | 045256220055 | 15 | 0.75 | hex | 1/4 | 7-1/4 | 1.867 | Bulk |
| 22009 | LINE-UP PUNCH 1/4 X 18 | 045256220093 | 18 | 0.625 | hex | 1/4 | 7-1/4 | 1.41 | Bulk |
| 22013 | LINE-UP PUNCH 5/16-8mm X 12 | 045256220130 | 12 | 0.625 | hex | 5/16 - 8mm | 7 | 0.85 | Bulk |
| 22017 | LINE-UP PUNCH 3/8 X 15 | 045256220178 | 15 | 0.75 | hex | 3/8 | 7-1/4 | 1.9708 | Bulk |
| 22024 | LINE-UP PUNCH 1/2 X 18 | 045256220246 | 18 | 0.875 | hex | 1/2 | 7-1/2 | 2.87 | Bulk |
| Extra Long aligning punches | | | | | | | | | |
| 22006 | LINE-UP PUNCH 3/16 X 12 | 045256220062 | 12 | 0.75 | hex | 3/16 | 6 | 0.33 | Bulk |
| 22007 | LINE-UP PUNCH 1/4 X 14 | 045256220079 | 14 | 0.5 | hex | 1/4 | 7 | 0.64 | Bulk |
| 22008 | LINE-UP PUNCH 5/16 X 16 | 045256220086 | 16 | 0.625 | hex | 5/16 | 7-1/4 | 1.16 | Bulk |



Pilot® or Roll Pin Punches

- Original Mayhew patented design with a rounded end that fits snugly within a roll pin
- Also known as a roll pin punch
- Used to drive in and remove roll pins or other hollow tension pins
- Variable point sizes available for variable radius sizes for all pin configurations
- Available in fractional or metric sizes
- Made in the USA

| Item | Description | UPC Code | OAL | Body Size | Body Type | Point Size | Pin Length | Weight (Lbs) | Pkg. Type |
|-----------------------------|---------------------------|--------------|-------|-----------|-----------|------------|------------|--------------|-----------|
| 25000 | PILOT PUNCH 1/16 x 2-3/4 | 045256250007 | 2-3/4 | 1/4 | Round | 1/16 | 1 | 0.0108 | Bulk |
| 25001 | PILOT PUNCH 5/64 X 3-1/4 | 045256250014 | 3-1/4 | 1/4 | Round | 5/64 | 1.5 | 0.0116 | Bulk |
| 25002 | PILOT PUNCH 3/32 X 3-1/2 | 045256250021 | 3-1/2 | 1/4 | Round | 3/32 | 1.5 | 0.0125 | Bulk |
| 25003 | PILOT PUNCH 1/8 X 4 | 045256250038 | 4 | 1/4 | Round | 1/8 | 2 | 0.0138 | Bulk |
| 25004 | PILOT PUNCH 5/32 X 4-1/2 | 045256250045 | 4-1/2 | 1/4 | Round | 5/32 | 2.5 | 0.0244 | Bulk |
| 25005 | PILOT PUNCH 3/16 X 4-1/2 | 045256250052 | 4-1/2 | 3/8 | Round | 3/16 | 2.5 | 0.0261 | Bulk |
| 25006 | PILOT PUNCH 7/32 X 5 | 045256250069 | 5 | 3/8 | Round | 7/32 | 3 | 0.0386 | Bulk |
| 25007 | PILOT PUNCH 1/4 X 5-1/2 | 045256250076 | 5-1/2 | 7/16 | Round | 1/4 | 3.5 | 0.0417 | Bulk |
| 25008 | PILOT PUNCH 5/16 X 6 | 045256250083 | 6 | 7/16 | Round | 5/16 | 4 | 0.061 | Bulk |
| 25009 | PILOT PUNCH 3/8 X 6 | 045256250090 | 6 | 1/2 | Round | 3/8 | 4 | 0.0868 | Bulk |
| 25010 | PILOT PUNCH 7/16 X 6 | 045256250106 | 6 | 5/8 | Round | 7/16 | 4 | 0.1395 | Bulk |
| 25011 | PILOT PUNCH 1/2 X 6 | 045256250113 | 6 | 5/8 | Round | 1/2 | 4 | 0.1605 | Bulk |
| Metric Pilot Punches | | | | | | | | | |
| 25014 | PUNCH PILOT 1.5mm X 2-3/4 | 045256250144 | 2-3/4 | 1/4 | Round | 1.5mm | 1.5 | 0.0108 | Bulk |
| 25015 | PILOT PUNCH 2mm X 3-1/4 | 045256250151 | 3-1/4 | 1/4 | Round | 2mm | 1.5 | 0.0116 | Bulk |
| 25016 | PILOT PUNCH 2.5mm X 3-1/2 | 045256250168 | 3-1/2 | 1/4 | Round | 2.5mm | 1.5 | 0.013 | Bulk |
| 25017 | PILOT PUNCH 3mm X 4 | 045256250175 | 4 | 1/4 | Round | 3mm | 2 | 0.0135 | Bulk |
| 25018 | PUNCH PILOT 3.5mm X 4 | 045256250182 | 4 | 1/4 | Round | 3.5mm | 2 | 0.0227 | Bulk |
| 25019 | PILOT PUNCH 4mm X 4-1/2 | 045256250199 | 4-1/2 | 3/8 | Round | 4mm | 2.5 | 0.0244 | Bulk |
| 25021 | PILOT PUNCH 5mm X 4-1/2 | 045256250212 | 4-1/2 | 3/8 | Round | 5mm | 2.625 | 0.0269 | Bulk |
| 25023 | PILOT PUNCH 6mm X 5-1/2 | 045256250236 | 5-1/2 | 7/16 | Round | 6mm | 3.5 | 0.0403 | Bulk |
| 25029 | PILOT PUNCH 8mm X 6 | 045256250298 | 6 | 1/2 | Round | 8mm | 4 | 0.061 | Bulk |
| 25026 | PUNCH PILOT 10mm X 6 | 045256250267 | 6 | 5/8 | Round | 10mm | 4 | 0.0927 | Bulk |
| 25028 | PUNCH PILOT 12mm X 6 | 045256250281 | 6 | 5/8 | Round | 12mm | 4 | 0.1511 | Bulk |



Mayhew Steel Products, Inc.
199 Industrial Blvd.
Turners Falls, MA 01376

U.S. Toll-Free Customer Service: 800-872-0037
Visit us online at www.Mayhew.com
Always wear safety goggles when using hand tools.

Version 2.2016
For the latest version, visit us
online at www.Mayhew.com

The Pros Know

Dominator
Pry Bars
Scrapers
Chisels
Punches
Steel Sets/
Kits
Specialty &
Extractors
Retail
Displays
Brass Sets/
Kits
150
Hard Cap
Hollow Punch
Sets
Automotive/
Specialty
Pneumatic
15



- Used to drive out and remove already loosened pins and keys after initial movement by a solid punch
- Variable point sizes and lengths for different applications
- Not for use on seized pins and keys; loosen with a solid punch first
- Available in fractional and metric sizes
- Available in black oxide finish for additional rust protection
- Made in the USA

Pin Punches

| Item | Description | UPC Code | OAL | Body Size | Body Type | Point Size | Pin Length | Weight (Lbs) | Pkg. Type |
|-------------------------------------|--------------------------|--------------|-------|-----------|-----------|------------|------------|--------------|-----------|
| REGULAR PIN LENGTH | | | | | | | | | |
| 21000 | PIN PUNCH 1/16X 4" | 045256210001 | 4 | 0.25 | hex | 1/16 | 3/4 | 0.0509 | Bulk |
| 21010 | PIN PUNCH 5/64X 4-1/4" | 045256210100 | 4-1/4 | 0.25 | hex | 5/64 | 13/16 | 0.052 | Bulk |
| 21001 | PIN PUNCH 3/32X 4-1/2" | 045256210018 | 4-1/2 | 0.25 | hex | 3/32 | 7/8 | 0.0531 | Bulk |
| 21002 | PIN PUNCH 1/8X 4-3/4" | 045256210025 | 4-3/4 | 0.312 | hex | 1/8 | 1 | 0.0618 | Bulk |
| 21003 | PIN PUNCH 5/32X 5" | 045256210032 | 5 | 0.312 | hex | 5/32 | 1 | 0.1052 | Bulk |
| 21004 | PIN PUNCH 3/16X 5-1/4" | 045256210049 | 5-1/4 | 0.312 | hex | 3/16 | 1-1/4 | 0.1171 | Bulk |
| 21011 | PIN PUNCH 7/32X 5-1/2" | 045256210117 | 5-1/2 | 0.375 | hex | 7/32 | 1-1/4 | 0.1231 | Bulk |
| 21005 | PIN PUNCH 1/4X 5-3/4" | 045256210056 | 5-3/4 | 0.375 | hex | 1/4 | 1-1/4 | 0.1864 | Bulk |
| 21019 | PIN PUNCH 5/16X 6" | 045256210193 | 6 | 0.437 | hex | 5/16 | 1-1/4 | 0.208 | Bulk |
| 21014 | PIN PUNCH 3/8 X 7-1/8" | 045256210148 | 7-1/8 | 0.5 | hex | 3/8 | 2 | 0.3549 | Bulk |
| 21016 | PIN PUNCH 7/16 X 8" | 045256210162 | 8 | 0.625 | hex | 7/16 | 2-1/2 | 0.3623 | Bulk |
| 21017 | PIN PUNCH 1/2 X 8" | 045256210179 | 8 | 0.625 | hex | 1/2 | 2-1/2 | 0.5778 | Bulk |
| Extra Long Pin length | | | | | | | | | |
| 21500 | PIN PUNCH 1/8 X 8" | 045256215006 | 8 | 0.312 | hex | 1/8 | 3 | 0.12 | Bulk |
| 21506 | PIN PUNCH 5/32 X 8" | 045256215068 | 8 | 0.312 | hex | 5/32 | 3 | 0.12 | Bulk |
| 21501 | PIN PUNCH 3/16 X 8" | 045256215013 | 8 | 0.375 | hex | 3/16 | 3-1/2 | 0.16 | Bulk |
| 21505 | PIN PUNCH P 7/32 x 8 | 045256215051 | 8 | 0.375 | hex | 7/32 | 3-1/2 | 0.16 | Bulk |
| 21502 | PIN PUNCH 1/4 X 8" | 045256215020 | 8 | 0.375 | hex | 1/4 | 3-1/2 | 0.19 | Bulk |
| 21503 | PIN PUNCH 5/16 X 8" | 045256215037 | 8 | 0.437 | hex | 5/16 | 3-1/2 | 0.28 | Bulk |
| 21504 | PIN PUNCH 3/8 X 8" | 045256215044 | 8 | 0.5 | hex | 3/8 | 3-1/2 | 0.38 | Bulk |
| METRIC PIN PUNCHES | | | | | | | | | |
| Metric regular pin length | | | | | | | | | |
| 21240 | PIN PUNCH 1.5mm X 4" | 045256212401 | 4 | 0.25 | hex | 1.5mm | 3/4 | 0.0509 | Bulk |
| 21241 | PIN PUNCH 2mm X 4-1/4" | 045256212418 | 4-1/4 | 0.25 | hex | 2mm | 3/4 | 0.052 | Bulk |
| 21242 | PIN PUNCH 2.5mm X 4-1/2" | 045256212425 | 4-1/2 | 0.25 | hex | 2.5mm | 1 | 0.0531 | Bulk |
| 21243 | PINPUNCH 3mm X 4-5/8" | 045256212432 | 4-5/8 | 0.312 | hex | 3mm | 1 | 0.0618 | Bulk |
| 21244 | PIN PUNCH 4mm | 045256212449 | 5 | 0.312 | hex | 4mm | 1 | 0.1052 | Bulk |
| 21245 | PIN PUNCH 5mm X 5-3/8 | 045256212456 | 5-3/8 | 0.312 | hex | 5mm | 1-1/4 | 0.1171 | Bulk |
| 21246 | PIN PUNCH 6mm X 5-5/8 | 045256212463 | 5-5/8 | 0.375 | hex | 6mm | 1-1/4 | 0.1864 | Bulk |
| 21247 | PIN PUNCH 8mm X 6 | 045256212470 | 6 | 0.437 | hex | 8mm | 1-1/4 | 0.208 | Bulk |
| 21248 | PIN PUNCH 10mm x 7 1/8 | 45256212487 | 7-1/8 | 0.5 | hex | 10mm | 2 | 0.3549 | Bulk |
| Metric extra long pin length | | | | | | | | | |
| 21249 | PIN PUNCH 12mm x8 | 045256212494 | 8 | 0.625 | hex | 12mm | 3-1/2 | 0.3623 | Bulk |
| 21508 | PIN PUNCH 3mm x8 | 045256215082 | 8 | 0.312 | hex | 3mm | 3 | 0.1 | Bulk |
| 21510 | PIN PUNCH 4mm x8 | 045256215105 | 8 | 0.312 | hex | 4mm | 3 | 0.13 | Bulk |
| 21512 | PIN PUNCH 5mm X 8 | 045256215129 | 8 | 0.375 | hex | 5mm | 3-1/2 | 0.17 | Bulk |
| 21514 | PIN PUNCH 6mm X 8 | 045256215143 | 8 | 0.375 | hex | 6mm | 3-1/2 | 0.19 | Bulk |
| 21516 | PIN PUNCH 7mm X 8 | 045256215167 | 8 | 0.375 | hex | 7mm | 3-1/2 | 0.2 | Bulk |
| 21518 | PIN PUNCH 8mm X 8 | 045256215181 | 8 | 0.437 | hex | 8mm | 3-1/2 | 0.27 | Bulk |
| 21519 | PIN PUNCH 9mm X 8 | 045256215198 | 8 | 0.5 | hex | 9mm | 3-1/2 | 0.36 | Bulk |
| 21520 | PIN PUNCH 10mm x8 | 045256215204 | 8 | 0.5 | hex | 10mm | 3-1/2 | 0.39 | Bulk |

Dominator
 Pry Bars
 Scrapers
 Chisels
Punches
 Steel Sets/
 Kits
 Specialty &
 Extractors
 Retail
 Displays
 Brass Sets/
 Kits
 150
 Hard Cap
 Hallow Punch
 Sets
 Automotive/
 Specialty
 Pneumatic
 16



Solid or Starter Punches

- For loosening frozen or tight pins and keys, or knocking out rivets
- Variable point sizes for different sized pins and keys
- Once loosened, follow up with a pin punch to drive the pin or key out
- Available in black oxide finish for additional rust protection
- Made in the USA

| Item | Description | UPC Code | OAL | Body Size | Body Type | Point Size | Taper Length | Weight (Lbs) | Pkg. Type |
|-------|----------------------------|--------------|-------|-----------|-----------|------------|--------------|--------------|-----------|
| 20004 | SOLID PUNCH 1/16-1.5mm X 5 | 045256200040 | 5 | 0.375 | hex | 1/16-1.5mm | 1-1/2 | 0.15 | Bulk |
| 20000 | SOLID PUNCH 3/32-2.5mm X 5 | 045256200002 | 5 | 0.375 | hex | 3/32-2.5mm | 1-1/2 | 0.15 | Bulk |
| 20020 | SOLID PUNCH 3mm X 5 | 045256200200 | 5 | 0.375 | hex | 3mm | 1-1/2 | 0.15 | Bulk |
| 20001 | SOLID PUNCH 1/8 X 5 | 045256200019 | 5 | 0.375 | hex | 1/8 | 1-1/2 | 0.15 | Bulk |
| 20005 | SOLID PUNCH 5/32-4mm X 5 | 045256200057 | 5 | 0.375 | hex | 5/32-4mm | 1-1/2 | 0.15 | Bulk |
| 20002 | SOLID PUNCH 3/16 X 5 | 045256200026 | 5 | 0.375 | hex | 3/16 | 1-1/2 | 0.15 | Bulk |
| 20026 | SOLID PUNCH 6mm X 5 | 045256200262 | 5 | 0.375 | hex | 6mm | 1-1/2 | 0.15 | Bulk |
| 20003 | SOLID PUNCH 1/4 X 5 | 045256200033 | 5 | 0.375 | hex | 1/4 | 1-1/2 | 0.15 | Bulk |
| 20105 | SOLID PUNCH 5/16-8mm X 6 | 045256201054 | 6 | 0.5 | hex | 5/16-8mm | 2 | 0.33 | Bulk |
| 20301 | SOLID PUNCH 3/8 X 6-1/2 | 045256203010 | 6-1/2 | 0.5 | hex | 3/8 | 2-1/4 | 0.54 | Bulk |



Rivet Set

- Used for mushrooming and setting rivet heads
- Made in the USA

| Item | Description | UPC Code | OAL | Body Size | Body Type | Blade Width | Blade Style | Weight (Lbs) | Pkg. Type |
|-------|---------------|-----------------|-----|-----------|-----------|-------------|-------------|--------------|-----------|
| 20900 | Reg Rivet Set | 0 45256 20900 5 | 5 | 5/8 | Hex | 3/8 | N/A | 0.42 | Bulk |



Rivet Buster

- Used for cutting the heads off rivets for easy removal
- Made in the USA

| Item | Description | UPC Code | OAL | Body Size | Body Type | Blade Width | Blade Style | Weight (Lbs) | Pkg. Type |
|-------|------------------|-----------------|-----|-----------|-----------|-------------|-------------|--------------|-----------|
| 11300 | Reg Rivet Buster | 0 45256 11300 5 | 5 | 3/4 | Hex | 3/4 | N/A | 0.51 | Bulk |

Steel Punch and Chisel Sets

| Item | Description | UPC Code | Item Length | Item Height | Item Width | Item Weight | COO |
|-------|--------------------------------------|--------------|-------------|-------------|------------|-------------|-----|
| 60560 | 6 pc Cold Chisel Set | 045256605609 | 8.00 | 0.75 | 2.50 | 1.56 | US |
| 61510 | 10 PC COLD CHISEL | 045256615103 | 9.25 | 3.25 | 2.225 | 4.16 | US |
| 61512 | 5 PC LONG COLD CHISEL | 045256615127 | 14.00 | 3.00 | 3.00 | 3.75 | US |
| 61518 | 3 PC XL COLD CHISEL | 045256615189 | 24.00 | 2.00 | 2.00 | 2.85 | US |
| 62078 | 12 PC PIN PUNCH (INCH) | 045256620787 | 9 | 3.75 | 2.5 | 3 | US |
| 60007 | 7 PC CENTER PUNCH | 045256600079 | 6.75 | 2 | 2 | 1.11 | US |
| 62212 | 12 PC CENTER & PRICK | 045256622125 | 9.25 | 3.5 | 1.75 | 2.15 | US |
| 61810 | 4 PC ALIGNING PUNCH KIT | 045256618104 | 21 | 2.5 | 2.25 | 7.775 | US |
| 66251 | 6 PC PIN PUNCH (MM) | 045256662510 | 9 | 2.75 | 1.5 | 1.29 | US |
| 62078 | 12 PC PIN PUNCH (INCH) | 045256620787 | 9 | 3.75 | 2.5 | 3 | US |
| 66257 | 9 PC PUNCH & CHISEL (MM) | 45256662572 | 7 | 2.75 | 1.25 | 0.88 | US |
| 62081 | 6 PC LONG PIN PUNCH (MM) | 045256620817 | 9 | 2.5 | 1.5 | 1.445 | US |
| 61406 | 6 PC PUNCH & CHISEL (INCH) | 045256614069 | 9 | 2.75 | 1.5 | 1.125 | US |
| 61409 | 9 PC PUNCH & CHISEL (INCH) | 045256614090 | 7.25 | 3 | 1.25 | 0.89 | US |
| 66256 | 6 PC PUNCH AND CHISEL SET (MM) | 045256622569 | 9 | 2.75 | 1.5 | 1.19 | US |
| 66258 | 12 PC PUNCH & CHISEL (MM) | 045256622583 | 7.25 | 4.38 | 2.63 | 2.41 | US |
| 62207 | 7 PC CENTER & PRICK | 045256622071 | 9.00 | 4.50 | 2.50 | 3.50 | US |
| 66252 | 9 PC PIN PUNCH (MM) | 045256662527 | 7.00 | 3.50 | 1.50 | 1.95 | US |
| 66253 | 11 PC PIN PUNCH (MM) | 045256662534 | 9.00 | 4.00 | 2.00 | 2.56 | US |
| 61411 | 11 PC PUNCH & CHISEL (INCH) | 045256614113 | 6 | 4.5 | 1 | 1.21 | US |
| 66287 | 20 PC PUNCH & CHISEL (MM) | 045256662879 | 11.00 | 6.50 | 4.50 | 4.25 | US |
| 61005 | 6 PC PUNCH AND CHISEL SET (INCH) | 45256610054 | 8.50 | 1.00 | 3.00 | 1.25 | US |
| 61406 | 6 PC PUNCH AND CHISEL SET (INCH) | 045256614069 | 9.00 | 1.50 | 2.78 | 1.13 | US |
| 61409 | 9 PC PUNCH AND CHISEL (INCH) | 045256614090 | 7.25 | 1.25 | 3.00 | 0.89 | US |
| 61412 | 12 PUNCH AND CHISEL (INCH) | 045256614120 | 9.00 | 2.00 | 3.50 | 2.81 | US |
| 61044 | 14 PC PUNCH AND CHISEL SET (INCH) | 45256610443 | 8.50 | 2.25 | 3.25 | 2.85 | US |
| 61019 | 19 PC PUNCH AND CHISEL SET (INCH) | 45256610191 | 8.00 | 2.50 | 5.00 | 3.82 | US |
| 61050 | 24 PC PUNCH AND CHISEL (INCH) | 45256610504 | 8.50 | 2.00 | 4.00 | 4.56 | US |
| 62256 | 6 PC PUNCH AND CHISEL (MM) | 045256622569 | 9.00 | 1.50 | 2.75 | 1.19 | US |
| 66287 | 20 PC PUNCH AND CHISEL (MM) | 045256662879 | 11.00 | 6.50 | 4.50 | 4.25 | US |
| 62250 | 6 PC ROLL PIN OR PILOT PUNCH (INCH) | 45256622507 | 7.50 | 0.75 | 2.00 | 0.60 | US |
| 62253 | 6 PC ROLL PIN OR PILOT PUNCH (INCH) | 045256622538 | 7.50 | 1.00 | 4.50 | 0.60 | US |
| 62255 | 6 PC ROLL PIN OR PILOT PUNCH (INCH) | 045256622552 | 11.00 | 1.00 | 4.00 | 0.65 | US |
| 62252 | 9 PC ROLL PIN OR PILOT PUNCH (INCH) | 45256622521 | 7.50 | 1.00 | 2.25 | 0.66 | US |
| 62254 | 12 PC ROLL PIN OR PILOT PUNCH (INCH) | 45256622545 | 7.50 | 1.00 | 4.50 | 1.61 | US |
| 62258 | 12 PC ROLL PIN OR PILOT PUNCH (INCH) | 45256622583 | 7.50 | 2.63 | 4.38 | 2.41 | US |
| 66265 | 6 PC ROLL PIN OR PILOT PUNCH (MM) | 045256662657 | 7.50 | 1.00 | 2.50 | 0.50 | US |
| 66264 | 5 PC ROLL PIN OR PILOT PUNCH (MM) | 045256662640 | 11.00 | 1.00 | 4.00 | 0.50 | US |
| 66261 | 6 PC ROLL PIN OR PILOT PUNCH (MM) | 045256662619 | 9.25 | 1.00 | 3.00 | 0.64 | US |
| 66262 | 9 PC ROLL PIN OR PILOT PUNCH (MM) | 045256662626 | 7.50 | 0.75 | 3.50 | 0.55 | US |
| 66263 | 11 PC ROLL PIN OR PILOT PUNCH (MM) | 045256662633 | 7.50 | 1.00 | 3.50 | 0.90 | US |
| 62076 | 6 PC PIN PUNCH (INCH) | 045256620763 | 7.50 | 0.50 | 2.00 | 1.05 | US |
| 62074 | 6 PC PIN PUNCH (INCH) | 045256620749 | 11.00 | 0.75 | 4.00 | 1.85 | US |
| 62065 | 5 PC LONG PIN PUNCH (INCH) | 045256620657 | 9.50 | 1.00 | 2.25 | 1.23 | US |
| 61811 | 6 PC ALIGNING PUNCH | 045256618111 | 13.50 | 0.75 | 4.00 | 3.32 | US |
| 62235 | 4 PC ALIGNING PUNCH KIT | 045256622354 | 13.00 | 1.25 | 1.75 | 1.78 | US |
| 61505 | 5 PC COLD CHISEL | 045256615059 | 9.50 | 2.00 | 2.00 | 1.89 | US |
| 61506 | 5 PC COLD CHISEL | 045256615066 | 10.50 | 1.50 | 4.50 | 2.28 | US |
| 62214 | 5 PC CENTER PUNCH' | 045256622149 | 7.25 | 1.50 | 2.50 | 1.15 | US |
| 62215 | 4 PC CENTER PUNCH | 045256622156 | 11.00 | 0.50 | 4.00 | 0.75 | US |
| 61340 | 6 PC SOLID OR STARTING PUNCH | 045256613406 | 7.25 | 1.50 | 2.00 | 1.16 | US |
| 62077 | 10 PC PUNCH MIX | 045256620770 | 9.00 | 1.00 | 4.00 | 1.76 | US |
| 61341 | 16 PC PUNCH MIX | 045256613413 | 7.50 | 1.75 | 3.25 | 3.10 | US |

Dominator
 Pry Bars
 Scrapers
 Chisels
 Punches
 Steel Sets/
 Kits
 Specialty &
 Extractors
 Retail
 Displays
 Brass Sets/
 Kits
 150
 Hard Cap
 Hollow Punch
 Sets
 Automotive/
 Specialty
 Pneumatic
 18

The following category matrices provide a detailed breakdown by SKU for the sets listed previously.

Chisels



60560
6 PC COLD CHISEL



61506
5 PC COLD CHISEL

| SET NO. | | 60560 | 61505 | 61506 | 61510 | 61512 | 61518 |
|-----------------------------------------------------------------------------------------------------------------------------------------|-----------------------------------------|------------------|------------------|------------------|-------------------|-----------------------|---------------------|
| SET DESCRIPTION | | 6 PC COLD CHISEL | 5 PC COLD CHISEL | 5 PC COLD CHISEL | 10 PC COLD CHISEL | 5 PC LONG COLD CHISEL | 3 PC XL COLD CHISEL |
| ITEM NO. | ITEM DESCRIPTION | SET CONTENTS | | | | | |
| 10200 | CHISEL COLD 1/4-6mm X 5 ON 1/4 HX | • | • | | • | | |
| 10237 | CHISEL COLD 9/32-7mm X 5 ON 1/4 HX | | | • | • | | |
| 10201 | CHISEL COLD 5/16-8mm X 5 ON 1/4 HX | • | • | | • | | |
| 10202MAY | CHISEL COLD 3/8-10mm X 5-1/2 ON 5/16 HX | • | | • | • | | |
| 10204 | CHISEL COLD 7/16-11mm X 6 ON 3/8 HX | | • | | • | | |
| 10205 | CHISEL COLD 1/2-13mm X 6 ON 7/16 HX | • | | • | • | | |
| 10209 | CHISEL COLD 5/8-16mm X 6-1/2 ON 1/2 HX | • | • | | • | | |
| 10212 | CHISEL COLD 3/4-19mm X 7 ON 5/8 HX | • | | • | • | | |
| 10216 | CHISEL COLD 7/8-22mm X 7-1/2 ON 3/4 HX | | • | | • | | |
| 10220 | CHISEL COLD 1-25mm X 8 ON 7/8 HX | | | • | • | | |
| 10207 | CHISEL COLD 1/2-13mm X 12 ON 7/16 HX | | | | | • | |
| 10210 | CHISEL COLD 5/8-16mm X 12 ON 1/2 HX | | | | | • | |
| 10213 | CHISEL COLD 3/4-19mm X 12 ON 5/8 HX | | | | | • | |
| 10217 | CHISEL COLD 7/8-22mm X 12 ON 3/4 HX | | | | | • | |
| 10221 | CHISEL COLD 1-25mm X 12 ON 3/4 HX | | | | | • | |
| 10215 | CHISEL COLD 3/4-19mm X 18 ON 5/8 HX | | | | | | • |
| 10219 | CHISEL COLD 7/8-22mm X 18 ON 3/4 HX | | | | | | • |
| 10222 | CHISEL COLD 1-25mm X 18 ON 3/4 HX | | | | | | • |
| Package Type: B = Blister C = Clamshell T = Tray R = Rack KB=Kit Bag P=Pouch X = Bulk Box W = Wooden Box | | KB | KB | P | KB | X | X |
| Build-A-Set: 1 = Set in Full Storage Unit 1a = Set in Storage Unit with room for expansion 1b = Set in Pouch to fill Storage Unit | | | 1a | 1b | 1 | 2 | 3 |

Build your full range assortment, one set at a time, or go complete with one kit.

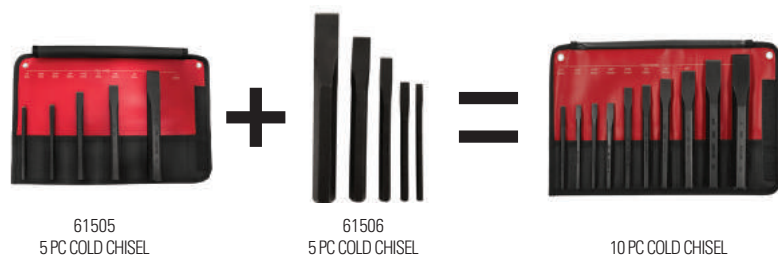

61505
5 PC COLD CHISEL

61506
5 PC COLD CHISEL

10 PC COLD CHISEL

1A

1B

1

Build-A-Set: 1 = Set in Full Storage Unit

1a = Set in Storage Unit with room for expansion

1b = Set in Pouch to fill Storage Unit



Mayhew Steel Products, Inc.
199 Industrial Blvd.
Turners Falls, MA 01376

U.S. Toll-Free Customer Service: 800-872-0037
Visit us online at www.Mayhew.com
Always wear safety goggles when using hand tools.

Version 2.2016
For the latest version, visit us
online at www.Mayhew.com

The Pros Know

Dominator

Pry Bars

Scrapers

Chisels

Punches

Steel Sets/
Kits

Specialty &
Extractors

Retail
Displays

Brass Sets/
Kits

150

Hard Cap

Hollow Punch
Sets

Automotive/
Specialty

Pneumatic

19

Center-Solid Punch

- Dominator
- Pry Bars
- Scrapers
- Chisels
- Punches
- Steel Sets/
Kits
- Specialty &
Extractors
- Retail
Displays
- Brass Sets/
Kits
- 150
- Hard Cap
- Hollow Punch
Sets
- Automotive/
Specialty
- Pneumatic



62212
12 PC CENTER & PRICK



62207
7 PC CENTER & PRICK



61340
6 PC SOLID PUNCH



| SET NO. | | 62207 | 60007 | 62214 | 62212 | 62215 | 61340 |
|-------------------------------------------------------------------------------------------------------------|------------------------------------------|---------------------------|-------------------------|-------------------------|----------------------------|-------------------------|------------------------|
| SET DESCRIPTION | | 7 PC CENTER & PRICK | 7 PC CENTER PUNCH | 5 PC CENTER PUNCH | 12 PC CENTER & PRICK | 4 PC CENTER PUNCH | 6 PC SOLID PUNCH |
| ITEM NO. | ITEM DESCRIPTION | SET CONTENTS | | | | | |
| 23000 | PUNCH PRICK 3/32-2.5mm x 4 ON 1/4 HX | • | | | • | | |
| 23003 | PUNCH PRICK 1/8-3mm x 6 ON 1/2 HX | | | | | | |
| 23002 | PUNCH PRICK 5/32-4mm x 5 ON 3/8 HX | • | | | • | | |
| 23001 | PUNCH PRICK 3/16-5mm x 4-1/2 ON 5/16 HX | • | | | • | | |
| 24005 | PUNCH CENTER 1/16-1.5mm x 4 ON 1/4 HX | • | • | | • | | |
| 24006 | PUNCH CENTER 5/64-2mm x 4 ON 1/4 HX | • | • | | • | • | |
| 24000 | PUNCH CENTER 3/32-2.5mm x 4 ON 1/4 HX | | • | • | • | | |
| 24007 | PUNCH CENTER 1/8-3mm x 4-1/4 ON 5/16 HX | • | • | | • | • | |
| 24001 | PUNCH CENTER 5/32-4mm x 4-1/2 ON 5/16 HX | | • | • | • | | |
| 24002 | PUNCH CENTER 3/16-5mm x 5 ON 3/8 HX | | • | • | • | • | |
| 24008 | PUNCH CENTER 1/4-6mm x 5-1/2 ON 7/16 HX | • | • | | • | | |
| 24003 | PUNCH CENTER 5/16-8mm x 6 ON 1/2 HX | | | • | • | • | |
| 24004 | PUNCH CENTER 3/8-10mm x 6-1/4 ON 5/8 HX | | | • | • | | |
| 20000 | PUNCH SOLID 3/32-2.5mm X 5 ON 3/8 HX | | | | | | • |
| 20001 | PUNCH SOLID 1/8 X 5 ON 3/8 HX | | | | | | • |
| 20005 | PUNCH SOLID 5/32-4mm X 5 ON 3/8 HX | | | | | | • |
| 20002 | PUNCH SOLID 3/16 X 5 ON 3/8 HX | | | | | | • |
| 20003 | PUNCH SOLID 1/4 X 5 ON 3/8 HX | | | | | | • |
| 20105 | PUNCH SOLID 5/16-8mm X 6 ON 1/2 HX | | | | | | • |
| Package Type: B = Blister C = Clamshell T = Tray R = Rack KB=Kit Bag P=Pouch X = Bulk Box W = Wooden Box | | KB | KB | P | KB | P | P |
| Build-A-Set: 1 = Set in Full Storage Unit | | | | | | | |
| 1a = Set in Storage Unit with room for expansion | | 1a | | 1b | 1 | | 2 |
| 1b = Set in Pouch to fill Storage Unit | | | | | | | |

Build your full range assortment, one set at a time, or go complete with one kit.

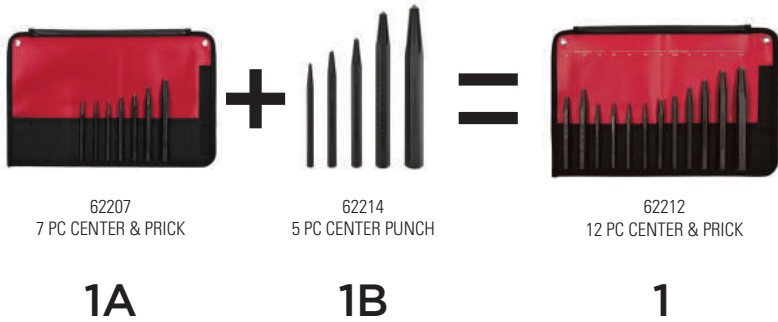



61341
16 PC PUNCH MIX



62077
10 PC PUNCH MIX



61810
4 PC ALIGNING PUNCH



61811
6 PC ALIGNING PUNCH

Punch Mix

| SET NO. | | 62077 | 61341 |
|-------------------------------------------------------------------------------------------------------------|------------------------------------------|-----------------|-----------------|
| SET DESCRIPTION | | 10 PC PUNCH MIX | 16 PC PUNCH MIX |
| ITEM NO. | ITEM DESCRIPTION | SET CONTENTS | |
| 24001 | PUNCH CENTER 5/32-4mm x 4-1/2 ON 5/16 HX | • | |
| 20000 | PUNCH SOLID 3/32-2.5mm X 5 ON 3/8 HX | | • |
| 20001 | PUNCH SOLID 1/8 X 5 ON 3/8 HX | • | • |
| 20005 | PUNCH SOLID 5/32-4mm X 5 ON 3/8 HX | | • |
| 20002 | PUNCH SOLID 3/16 X 5 ON 3/8 HX | | • |
| 20003 | PUNCH SOLID 1/4 X 5 ON 3/8 HX | | • |
| 20105 | PUNCH SOLID 5/16-8mm X 6 ON 1/2 HX | | • |
| 20301 | PUNCH SOLID 3/8 X 6-1/2 ON 1/2 HX | | • |
| 21000 | PUNCH PIN 1/16 X 3/4 X 4 ON 1/4 HX | | • |
| 21001 | PUNCH PIN 3/32 X 7/8 X 4-1/2 ON 5/16 HX | • | • |
| 21002 | PUNCH PIN 1/8 X 1 X 4-3/4 ON 5/16 HX | • | • |
| 21003 | PUNCH PIN 5/32 X 1 X 5 ON 5/16 HX | • | • |
| 21004 | PUNCH PIN 3/16 X 1-1/4 X 5-1/4 ON 3/8 HX | • | • |
| 21011 | PUNCH PIN 7/32 X 1-1/4 X 5-1/2 ON 3/8 HX | • | • |
| 21005 | PUNCH PIN 1/4 X 1-1/4 X 5-3/4 ON 3/8 HX | • | • |
| 21019 | PUNCH PIN 5/16 X 1-1/4 X 6 ON 7/16 HX | | • |
| 21014 | PUNCH PIN 3/8 X 1-1/4 X 6-1/4 ON 1/2 HX | | • |
| 21503 | PUNCH PIN 5/16 X 3-1/2 X 8 ON 7/16 HX | • | |
| 21504 | PUNCH PIN 3/8 X 3-1/2 X 8 ON 1/2 HX | • | |
| Package Type: B = Blister C = Clamshell T = Tray R = Rack KB=Kit Bag P=Pouch X = Bulk Box W = Wooden Box | | KB | KB |
| Build-A-Set: 1 = Set in Full Storage Unit | | | |
| 1a = Set in Storage Unit with room for expansion | | | |
| 1b = Set in Pouch to fill Storage Unit | | | |

Aligning Punches

| SET NO. | | 61810 | 61811 | 62235 |
|-------------------------------------------------------------------------------------------------------------|------------------------------------------|---------------------|---------------------|--------------------|
| SET DESCRIPTION | | 4 PC ALIGNING PUNCH | 6 PC ALIGNING PUNCH | 4 PC LINE-UP PUNCH |
| ITEM NO. | ITEM DESCRIPTION | SET CONTENTS | | |
| 22021 | PUNCH ALIGNING 3/32-2.5mm X 8 ON 5/16 HX | | | |
| 22010 | PUNCH ALIGNING 1/8-3mm X 8 ON 5/16 HX | | • | • |
| 22011 | PUNCH ALIGNING 5/32-4mm X 9 ON 3/8 HX | | • | • |
| 22006 | PUNCH ALIGNING 3/16 X 12 ON 3/8 HX | | | |
| 22012 | PUNCH ALIGNING 3/16 X 10 ON 1/2 HX | | • | • |
| 22025 | PUNCH ALIGNING 7/32 X 10 ON 1/2 HX | | • | |
| 22003 | PUNCH ALIGNING 1/4 X 12 ON 5/8 HX | | • | • |
| 22005 | PUNCH ALIGNING 1/4 X 15 ON 3/4 HX | • | | |
| 22013 | PUNCH ALIGNING 5/16-8mm X 12 ON 5/8 HX | | • | |
| 22008 | PUNCH ALIGNING 5/16 X 16 ON 5/8 HX | • | | |
| 22017 | PUNCH ALIGNING 3/8 X 15 ON 3/4 HX | • | | |
| 22024 | PUNCH ALIGNING 1/2 X 18 ON .875 HX | • | | |
| Package Type: B = Blister C = Clamshell T = Tray R = Rack KB=Kit Bag P=Pouch X = Bulk Box W = Wooden Box | | KB | KB | KB |
| Build-A-Set: 1 = Set in Full Storage Unit | | | | |
| 1a = Set in Storage Unit with room for expansion | | 1 | 2 | |
| 1b = Set in Pouch to fill Storage Unit | | | | |

Pin Punches

Dominator
 Pry Bars
 Scrapers
 Chisels
 Punches
 Steel Sets/
 Kits
 Specialty &
 Extractors
 Retail
 Displays
 Brass Sets/
 Kits
 150
 Hard Cap
 Hollow Punch
 Sets
 Automotive/
 Specialty
 Pneumatic



62078
12 PC PIN PUNCH (INCH)



62065
5 PC LONG PIN PUNCH (INCH)



62081
6 PC LONG PIN PUNCH (MM)

| SET NO. | | 62076 | 62074 | 62078 | 62065 | 66254 | 66255 | 66252 | 66253 | 62081 |
|-----------------------------------------------------------------------------------------------------------------------------------------|------------------------------------------|--------------------------------|--------------------------------|---------------------------------|----------------------------------------|------------------------------|------------------------------|------------------------------|-------------------------------|--------------------------------------|
| SET DESCRIPTION | | 6 PC PIN PUNCH (INCH) | 6 PC PIN PUNCH (INCH) | 12 PC PIN PUNCH (INCH) | 5 PC LONG PIN PUNCH (INCH) | 6 PC PIN PUNCH (MM) | 5 PC PIN PUNCH (MM) | 9 PC PIN PUNCH (MM) | 11 PC PIN PUNCH (MM) | 6 PC LONG PIN PUNCH (MM) |
| ITEM NO. | ITEM DESCRIPTION | SET CONTENTS | | | | | | | | |
| 21000 | PUNCH PIN 1/16 X 3/4 X 4 ON 1/4 HX | | • | • | | | | | | |
| 21010 | PUNCH PIN 5/64 X 13/16 X 4-1/4 ON 1/4 HX | | • | • | | | | | | |
| 21001 | PUNCH PIN 3/32 X 7/8 X 4-1/2 ON 5/16 HX | | • | • | | | | | | |
| 21002 | PUNCH PIN 1/8 X 1 X 4-3/4 ON 5/16 HX | • | | • | | | | | | |
| 21003 | PUNCH PIN 5/32 X 1 X 5 ON 5/16 HX | • | | • | | | | | | |
| 21004 | PUNCH PIN 3/16 X 1-1/4 X 5-1/4 ON 3/8 HX | • | | • | | | | | | |
| 21011 | PUNCH PIN 7/32 X 1-1/4 X 5-1/2 ON 3/8 HX | • | | • | | | | | | |
| 21005 | PUNCH PIN 1/4 X 1-1/4 X 5-3/4 ON 3/8 HX | • | | • | | | | | | |
| 21019 | PUNCH PIN 5/16 X 1-1/4 X 6 ON 7/16 HX | • | | • | | | | | | |
| 21014 | PUNCH PIN 3/8 X 2 X 7-1/8 ON 1/2 HX | | • | • | | | | | | |
| 21016 | PUNCH PIN 7/16 X 3-1/2 X 8 ON 5/8 HX | | • | • | | | | | | |
| 21017 | PUNCH PIN 1/2 X 3-1/2 X 8 ON 5/8 HX | | • | • | | | | | | |
| 21500 | PUNCH PIN 1/8 X 3 X 8 ON 5/16 HX | | | | • | | | | | |
| 21501 | PUNCH PIN 3/16 X 3-1/2 X 8 ON 3/8 HX | | | | • | | | | | |
| 21502 | PUNCH PIN 1/4 X 3-1/2 X 8 ON 3/8 HX | | | | • | | | | | |
| 21503 | PUNCH PIN 5/16 X 3-1/2 X 8 ON 7/16 HX | | | | • | | | | | |
| 21504 | PUNCH PIN 3/8 X 3-1/2 X 8 ON 1/2 HX | | | | • | | | | | |
| 21240 | PUNCH PIN 1.5mm X 3/4 X 4 ON 1/4 HX | | | | | • | | • | • | |
| 21241 | PUNCH PIN 2mm X 3/4 X 4-1/4 ON 1/4 HX | | | | | • | | • | • | |
| 21242 | PUNCH PIN 2.5mm X 7/8 X 4-1/2 ON 5/16 HX | | | | | • | | • | • | |
| 21243 | PUNCH PIN 3mm X 1 X 4-5/8 ON 5/16 HX | | | | | • | | • | • | |
| 21244 | PUNCH PIN 4mm X 1 X 5 ON 5/16 HX | | | | | • | | • | • | |
| 21245 | PUNCH PIN 5mm X 1-1/4 X 5-3/8 ON 3/8 HX | | | | | • | | • | • | |
| 21246 | PUNCH PIN 6mm X 1-1/4 X 5-5/8 ON 3/8 HX | | | | | • | | • | • | |
| 21247 | PUNCH PIN 8mm X 1-1/4 X 6 ON 7/16 HX | | | | | • | | • | • | |
| 21248 | PUNCH PIN 10mm X 2 X 7-1/8 ON 1/2 HX | | | | | • | | • | • | |
| 21249 | PUNCH PIN 12mm X 3-1/2 X 8 ON 5/8 HX | | | | | • | | • | • | |
| 21227 | PUNCH PIN 7mm X 2-5/8 X 6 ON 3/8 HX | | | | | • | | • | • | |
| 21508 | PUNCH PIN 3mm X 3 X 8 ON 5/16 HX | | | | | | | | | • |
| 21510 | PUNCH PIN 4mm X 3 X 8 ON 5/16 HX | | | | | | | | | • |
| 21512 | PUNCH PIN 5mm X 3-1/2 X 8 ON 3/8 HX | | | | | | | | | • |
| 21514 | PUNCH PIN 6mm X 3-1/2 X 8 ON 3/8 HX | | | | | | | | | • |
| 21518 | PUNCH PIN 8mm X 3-1/2 X 8 ON 7/16 HX | | | | | | | | | • |
| 21520 | PUNCH PIN 10mm X 3-1/2 X 8 ON 1/2 HX | | | | | | | | | • |
| Package Type: B = Blister C = Clamshell T = Tray R = Rack KB=Kit Bag P=Pouch X= Bulk Box W= Wooden Box | | KB | P | KB | KB | KB | P | KB | KB | KB |
| Build-A-Set: 1 = Set in Full Storage Unit 1a = Set in Storage Unit with room for expansion 1b = Set in Pouch to fill Storage Unit | | 1a | 1b | 1 | 2 | 3a | 3b | | 3 | 4 |

Build your full range assortment, one set at a time, or go complete with one kit.

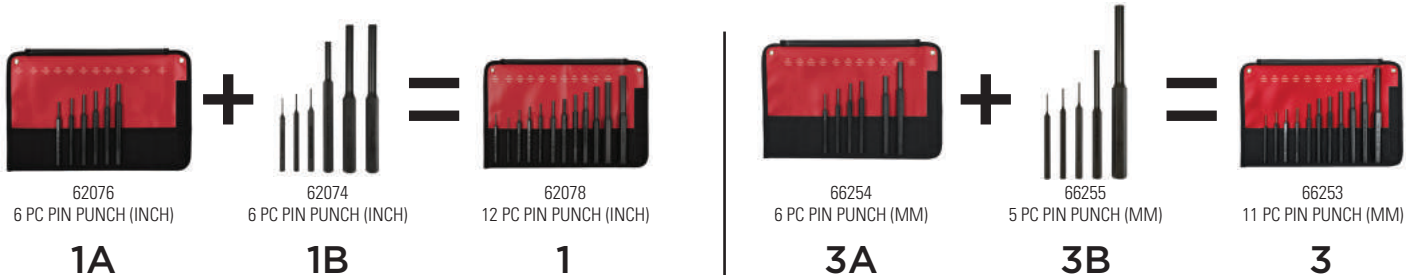

Punch & Chisel Mix



61005
6 PC PUNCH & CHISEL (INCH)



61050
24 PC PUNCH & CHISEL (INCH)



61044
14 PC PUNCH & CHISEL (INCH)



61019
19 PC PUNCH & CHISEL (INCH)

| SET NO. | | 61005 | 61406 | 61409 | 61412 | 61044 | 61019 | 62287 | 61050 | 62256 | 62257 | 66258 | 66287 | 61080 | |
|----------|---------------------------------------------------------------------------------------------------------|----------------------------|----------------------------|----------------------------|-----------------------------|-----------------------------|-----------------------------|-----------------------------|-----------------------------|--------------------------|--------------------------|---------------------------|---------------------------|---------------------------|---|
| | SET DESCRIPTION | 6 PC PUNCH & CHISEL (INCH) | 6 PC PUNCH & CHISEL (INCH) | 9 PC PUNCH & CHISEL (INCH) | 12 PC PUNCH & CHISEL (INCH) | 14 PC PUNCH & CHISEL (INCH) | 19 PC PUNCH & CHISEL (INCH) | 20 PC PUNCH & CHISEL (INCH) | 24 PC PUNCH & CHISEL (INCH) | 6 PC PUNCH & CHISEL (MM) | 9 PC PUNCH & CHISEL (MM) | 12 PC PUNCH & CHISEL (MM) | 20 PC PUNCH & CHISEL (MM) | 24 PC MECHANICS BENCH SET | |
| ITEM NO. | ITEM DESCRIPTION | SET CONTENTS | | | | | | | | | | | | | |
| 10200 | CHISEL COLD 1/4-6mm X 5 ON 1/4 HX | | • | | | | • | • | • | • | | | | • | • |
| 10237 | CHISEL COLD 9/32-7mm X 5 ON 1/4 HX | | | | • | | | | | | • | | | | |
| 10201 | CHISEL COLD 5/16-8mm X 5 ON 1/4 HX | | | | • | | | | • | | | • | | | • |
| 10202MAY | CHISEL COLD 3/8-10mm X 5-1/4 ON 5/16 HX | | | | • | | • | • | • | | • | | | • | • |
| 10204 | CHISEL COLD 7/16-11mm X 6 ON 3/8 HX | | • | | | | | | | • | | | | | |
| 10205 | CHISEL COLD 1/2-13mm X 6 ON 7/16 HX | • | | | • | • | • | • | • | | | • | • | • | • |
| 10209 | CHISEL COLD 5/8-16mm X 6-1/2 ON 1/2 HX | • | • | | • | • | • | • | • | • | | • | • | • | • |
| 10212 | CHISEL COLD 3/4-19mm X 7 ON 5/8 HX | | | | • | • | • | • | • | | | • | • | • | • |
| 23000 | PUNCH PRICK 3/32-2.5mm x 4 ON 1/4 HX | | | | • | | | | | | • | | | | |
| 23003 | PUNCH PRICK 1/8-3mm x 6 ON 1/2 HX | | | | | | | | | | | | | | • |
| 23002 | PUNCH PRICK 5/32-4mm x 5 ON 3/8 HX | | | | | • | | | | | | | • | | • |
| 23001 | PUNCH PRICK 3/16-5mm x 4-1/2 ON 5/16 HX | | | | | | | | • | • | | | | • | |
| 24007 | PUNCH CENTER 1/8-3mm x 4-1/4 ON 5/16 HX | | | | • | | | | | | • | | | | |
| 24001 | PUNCH CENTER 5/32-4mm x 4-1/2 ON 5/16 HX | | | | | | | • | | | | | | | |
| 24002 | PUNCH CENTER 3/16-5mm x 5 ON 3/8 HX | • | • | | | • | • | • | • | • | | | | • | • |
| 24003 | PUNCH CENTER 5/16-8mm x 6 ON 1/2 HX | | | | • | | | | • | • | | | • | • | • |
| 20000 | PUNCH SOLID 3/32-2.5mm X 5 ON 3/8 HX | | | | | | • | • | • | • | | | | • | • |
| 20020 | PUNCH SOLID 3mm X 5 ON 3/8 HX | | | | | | | | | | • | | | • | • |
| 20001 | PUNCH SOLID 1/8 X 5 ON 3/8 HX | | | | • | | • | • | • | • | | | | • | • |
| 20005 | PUNCH SOLID 5/32-4mm X 5 ON 3/8 HX | | • | | | | | | • | • | | | | • | • |
| 20002 | PUNCH SOLID 3/16 X 5 ON 3/8 HX | • | | | | • | • | • | • | • | | | | • | • |
| 20026 | PUNCH SOLID 6mm X 5 ON 3/8 HX | | | | | | | | | | | | • | • | • |
| 20003 | PUNCH SOLID 1/4 X 5 ON 3/8 HX | | | | | • | | • | • | • | | | | • | • |
| 20105 | PUNCH SOLID 5/16-8mm X 6 ON 1/2 HX | | | | | | | | • | • | | | | | |
| 22021 | PUNCH ALIGNING 3/32-2.5MM X 8 ON 5/16 HX | | | | | | | | • | • | | | | | |
| 22010 | PUNCH ALIGNING 1/8-3mm X 8 ON 5/16 HX | | | | | | | | | | | | • | • | |
| 21000 | PUNCH PIN 1/16 X 3/4 X 4 ON 1/4 HX | | | | • | | | | | | | | | | |
| 21010 | PUNCH PIN 5/64 X 3/4 X 4-1/4 ON 1/4 HX | | | | • | | | | | | | | | | |
| 21001 | PUNCH PIN 3/32 X 7/8 X 4-1/2 ON 5/16 HX | | | | • | | • | • | • | • | | | | | • |
| 21002 | PUNCH PIN 1/8 X 1 X 4-3/4 ON 5/16 HX | • | • | • | | | • | • | • | • | | | | | • |
| 21003 | PUNCH PIN 5/32 X 1 X 5 ON 5/16 HX | | | | | • | • | • | • | • | | | | | • |
| 21004 | PUNCH PIN 3/16 X 1-1/4 X 5-1/4 ON 3/8 HX | • | | | • | • | • | • | • | • | | | | | • |
| 21011 | PUNCH PIN 7/32 X 1-1/4 X 5-1/2 ON 3/8 HX | | | | | • | • | • | • | • | | | | | • |
| 21005 | PUNCH PIN 1/4 X 1-1/4 X 5-3/4 ON 3/8 HX | | | | | • | • | • | • | • | | | | | • |
| 21019 | PUNCH PIN 5/16 X 1-1/4 X 6 ON 7/16 HX | | | | | • | • | • | • | • | | | | | • |
| 21014 | PUNCH PIN 3/8 X 1-1/4 X 6-1/4 ON 1/2 HX | | | | | • | | | | | | | | | • |
| 21240 | PUNCH PIN 1.5mm X 3/4 X 4 ON 1/4 HX | | | | | | | | | | • | | | | |
| 21241 | PUNCH PIN 2mm X 3/4 X 4-1/4 ON 1/4 HX | | | | | | | | | | • | | | | |
| 21242 | PUNCH PIN 2.5mm X 7/8 X 4-1/2 ON 5/16 HX | | | | | | | | | | • | | | • | |
| 21243 | PUNCH PIN 3mm X 1 X 4-3/4 ON 5/16 HX | | | | | | | | | | • | | | • | |
| 21244 | PUNCH PIN 4mm X 1 X 5 ON 5/16 HX | | | | | | | | | | • | | | • | |
| 21245 | PUNCH PIN 5mm X 1-1/4 X 5-1/4 ON 3/8 HX | | | | | | | | | | • | | | • | |
| 21246 | PUNCH PIN 6mm X 1-1/4 X 5-1/2 ON 3/8 HX | | | | | | | | | | • | | | • | |
| 21247 | PUNCH PIN 8mm X 1-1/4 X 6 ON 7/16 HX | | | | | | | | | | • | | | • | |
| 21248 | PUNCH PIN 10mm X 1-1/4 X 6-1/4 ON 1/2 HX | | | | | | | | | | • | | | • | |
| 21249 | PUNCH PIN 12mm X 1-1/4 X 6-1/2 ON 5/8 HX | | | | | | | | | | • | | | • | |
| 50301 | PUNCH-CHISEL HOLDER IN HANDLE | | | | | | | | • | | | | | • | |
| 10402MAY | CHISEL CAPE 1/4 X 5-5/8 ON 3/8 HX | | | | | | | | • | | | | | | • |
| 10502MAY | CHISEL CAPE R-NOSE 1/4 X 5-5/8 ON 3/8 HX | | | | | | | | • | | | | | | • |
| 10602MAY | CHISEL DIA PT 1/4 X 5-3/4 ON 3/8 HX | | | | | | | | • | | | | | | • |
| 10404 | CAPE CHISEL 3/8 X 7 ON 5/8 HEX | | | | | | | | | | | | | | • |
| 11300 | RIVET BUSTER | | | | | | | | | | | | | | • |
| | Package Type: B = Blister C = Clamshell T = Tray R = Rack KB=Kit Bag P=Pouch X=Bulk Box W=Wooden Box | KB | KB | KB | KB | KB | KB | KB | KB | KB | KB | KB | KB | KB | W |
| | Build-A-Set: 1 = Set in Full Storage Unit | | | | | | | | | | | | | | |
| | 1a = Set in Storage Unit with room for expansion | | 1a | 1b | 1c | | | | | 2a | 2b | 2c | | | |
| | 1b = Set in Pouch to fill Storage Unit | | | | | | | | | | | | | | |

Dominator
 Pry Bars
 Scrapers
 Chisels
 Punches
 Steel Sets/
 Kits
 Specialty &
 Extractors
 Retail
 Displays
 Brass Sets/
 Kits
 150
 Hard Cap
 Hollow Punch
 Sets
 Automotive/
 Specialty
 Pneumatic



Mayhew Steel Products, Inc.
199 Industrial Blvd.
Turners Falls, MA 01376

U.S. Toll-Free Customer Service: 800-872-0037
Visit us online at www.Mayhew.com
Always wear safety goggles when using hand tools.

Version 2.2016
For the latest version, visit us
online at www.Mayhew.com

The Pros Know

Pilot Punches

| SET NO. | | 62250 | 62253 | 62255 | 62252 | 62254 | 62258 | 66265 | 66264 | 66261 | 66262 | 66263 |
|-----------------------------------------------------------------------------------------------------------------------------------------|-------------------------------------------|-------------------------|-------------------------|-------------------------|-------------------------|--------------------------|--------------------------|-----------------------|-----------------------|-----------------------|-----------------------|------------------------|
| SET DESCRIPTION | | 6 PC PILOT PUNCH (INCH) | 6 PC PILOT PUNCH (INCH) | 6 PC PILOT PUNCH (INCH) | 9 PC PILOT PUNCH (INCH) | 12 PC PILOT PUNCH (INCH) | 12 PC PILOT PUNCH (INCH) | 6 PC PILOT PUNCH (MM) | 5 PC PILOT PUNCH (MM) | 6 PC PILOT PUNCH (MM) | 9 PC PILOT PUNCH (MM) | 11 PC PILOT PUNCH (MM) |
| ITEM NO. | ITEM DESCRIPTION | SET CONTENTS | | | | | | | | | | |
| 25000 | PUNCH PILOT 1/16 X 2-3/4 ON 1/4 RD-KNURL | | | • | • | • | • | | | | | |
| 25001 | PUNCH PILOT 5/64 X 3-1/4 ON 1/4 RD-KNURL | | | • | • | • | • | | | | | |
| 25002 | PUNCH PILOT 3/32 X 3-1/2 ON 1/4 RD-KNURL | | | • | • | • | • | | | | | |
| 25003 | PUNCH PILOT 1/8 X 4 ON 1/4 RD-KNURL | • | • | | • | • | • | | | | | |
| 25004 | PUNCH PILOT 5/32 X 4-1/2 ON 1/4 RD-KNURL | • | • | | • | • | • | | | | | |
| 25005 | PUNCH PILOT 3/16 X 4-1/2 ON 3/8 RD-KNURL | • | • | | • | • | • | | | | | |
| 25006 | PUNCH PILOT 7/32 X 5 ON 3/8 RD-KNURL | • | • | | • | • | • | | | | | |
| 25007 | PUNCH PILOT 1/4 X 5-1/2 ON 7/16 RD-KNURL | • | • | | • | • | • | | | | | |
| 25008 | PUNCH PILOT 5/16 X 6 ON 7/16 RD-KNURL | • | • | | • | • | • | | | | | |
| 25009 | PUNCH PILOT 3/8 X 6 ON 1/2 RD-KNURL | | | • | | • | • | | | | | |
| 25010 | PUNCH PILOT 7/16 X 6 ON 5/8 RD-KNURL | | | • | | • | • | | | | | |
| 25011 | PUNCH PILOT 1/2 X 6 ON 5/8 RD-KNURL | | | • | | • | • | | | | | |
| 25014 | PUNCH PILOT 1.5mm X 2-3/4 ON 1/4 RD-KNURL | | | | | | | | • | | • | • |
| 25015 | PUNCH PILOT 2mm X 3-1/4 ON 1/4 RD-KNURL | | | | | | | | • | | • | • |
| 25016 | PUNCH PILOT 2.5mm X 3-1/2 ON 1/4 RD-KNURL | | | | | | | | • | | • | • |
| 25017 | PUNCH PILOT 3mm X 4 ON 1/4 RD-KNURL | | | | | | | • | | • | • | • |
| 25018 | PUNCH PILOT 3.5mm X 4 ON 1/4 RD-KNURL | | | | | | | • | | • | • | • |
| 25019 | PUNCH PILOT 4mm X 4-1/2 ON 1/4 RD-KNURL | | | | | | | • | | • | • | • |
| 25021 | PUNCH PILOT 5mm X 4-1/2 ON 3/8 RD-KNURL | | | | | | | • | | • | • | • |
| 25023 | PUNCH PILOT 6mm X 5-1/2 ON 7/16 RD-KNURL | | | | | | | • | | • | • | • |
| 25029 | PUNCH PILOT 8mm X 6 ON 7/16 RD-KNURL | | | | | | | • | | • | • | • |
| 25026 | PUNCH PILOT 10mm X 6 ON 1/2 RD-KNURL | | | | | | | | • | | | • |
| 25028 | PUNCH PILOT 12mm X 6 ON 5/8 RD-KNURL | | | | | | | | • | | | • |
| Package Type: B = Blister C = Clamshell T = Tray R = Rack KB=Kit Bag P=Pouch X = Bulk Box W = Wooden Box | | KB | KB | P | KB | KB | W | KB | P | KB | KB | KB |
| Build-A-Set: 1 = Set in Full Storage Unit 1a = Set in Storage Unit with room for expansion 1b = Set in Pouch to fill Storage Unit | | | 1a | 1b | | 1 | | 2a | 2b | | | 2 |

Build your full range assortment, one set at a time, or go complete with one kit.

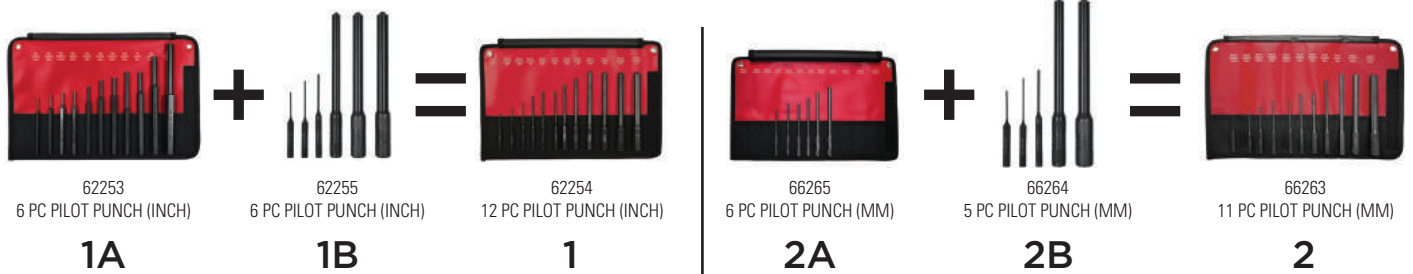



62250
6 PC PILOT PUNCH (INCH)



62254
12 PC PILOT PUNCH (INCH)



62252
9 PC PILOT PUNCH (INCH)



66263
11 PC PILOT PUNCH (MM)



66261
6 PC PILOT PUNCH (MM)



66262
9 PC PILOT PUNCH (MM)



Mayhew Steel Products, Inc.
199 Industrial Blvd.
Turners Falls, MA 01376

U.S. Toll-Free Customer Service: 800-872-0037
Visit us online at www.Mayhew.com
Always wear safety goggles when using hand tools.

Version 2.2016
For the latest version, visit us
online at www.Mayhew.com

The Pros Know



37019 - Seal Puller

Specialty Tools

| Item | Description | UPC Code | OAL | Body Size | Body Type | Blade Width | Blade Style | Weight (Lbs) | Pkg. Type |
|-------|------------------------------------------|--------------|-------|-----------|-----------|-------------|-------------|--------------|-----------|
| 01300 | 5/8" X 7-3/4" Short Nose Caulk Iron | 081243013002 | 7-3/4 | 1/2 | Hex | 5/8 | N/A | 0.41 | Bulk |
| 01360 | 5/8" X 7-3/4" Short Nose Caulk Iron | 081243013606 | 7-3/4 | 1/2 | Hex | 5/8 | N/A | 0.4 | Bulk |
| 01370 | 5/8" X 7-3/4" Short Nose Caulk Iron | 081243013705 | 7-3/4 | 1/2 | Hex | 5/8 | N/A | 0.41 | Bulk |
| 02400 | 5/8" X 12" Packing Tool | 081243024008 | 12 | 1/2 | Hex | 5/8 | N/A | 0.62 | Bulk |
| 02800 | 1-1/2" X 8" Broad Curved Nose Caulk Iron | 081243028006 | 8-1/8 | 5/8 | Hex | 1-1/2 | N/A | 0.4 | Bulk |
| 37002 | 12 oz Welders Chip Hammer | 045256370026 | 6 | 1/2 | Hex | 1/4 | N/A | 2.81 | Bulk |
| 37003 | 16 oz Welders Chip Hammer | 045256370033 | 7-1/2 | 3/4 | Hex | 7/8 | N/A | 2.57 | Bulk |
| 37019 | Seal Puller | 045256370194 | 14 | 1/2 | Hex | 1/4 | N/A | 1.19 | Bulk |
| 50301 | PUNCH-CHISEL HOLDER | 045256503011 | N/A | HANDLE | N/A | N/A | N/A | 0.61 | Bulk |



Screw Extractors

- Used for removing broken or seized screws
- A wide range of sizes available for any screw size
- Hardened steel edges for easy removal of damaged screws
- Fluted cutting edges for cutting into screw shaft
- Made in the USA

| Item | Description | UPC Code | OAL | Body Size | Body Type | Blade Width | Blade Style | Weight (Lbs) | Pkg. Type |
|-------|------------------------------------|-----------------|--------|-----------|-----------|-------------|-------------|--------------|-----------|
| 36961 | Screw Extractor D 1/8" S 1/4"-5/16 | 0 45256 36961 7 | 2-7/16 | 3/16 | Square | 1/8 | N/A | 0.02 | Bulk |
| 36962 | Screw Extractor D 3/16" S 3/8" | 0 45256 36962 4 | 2-5/8 | 3/16 | Square | 3/8 | N/A | 0.02 | Bulk |
| 36963 | Screw Extractor D 15/64" S 7/16" | 0 45256 36963 1 | 2-7/8 | 1/4 | Square | 15/64 | N/A | 0.04 | Bulk |
| 36964 | Screw Extractor D 5/16" S 1/2-9/16 | 0 45256 36964 8 | 3 | 5/16 | Square | 5/16 | N/A | 0.07 | Bulk |
| 36965 | Screw Extractor D 3/8" S 5/8" | 0 45256 36965 5 | 3-1/4 | 3/8 | Square | 11/32 | N/A | 0.11 | Bulk |
| 36966 | Screw Extractor D 15/32" S 3/4" | 0 45256 36966 2 | 3-7/8 | 1/2 | Square | 7/16 | N/A | 0.21 | Bulk |
| 36967 | Screw Extractor D 9/16" D 7/8" | 0 45256 36967 9 | 4-1/2 | 1/2 | Square | 1/2 | N/A | 0.27 | Bulk |
| 36968 | Screw Extractor 21/32" S 1-1/8" | 0 45256 36968 6 | 4-7/8 | 5/8 | Square | 21/32 | N/A | 0.44 | Bulk |
| 36969 | Screw Extractor D 13/16" S 1-3/8" | 0 45256 36969 3 | 5-3/8 | 3/4 | Square | 23/32 | N/A | 0.70 | Bulk |



- 10 piece set includes sizes 6.00mm (1/4") - 38.00mm (1-1/2")
- Manufactured from hardened steel with fluted edges makes for easy removal of broken or damaged screws, bolts, studs, and pipes
- An open space for the proper drill size has been molded into the case for the storage of the corresponding drills.
- Made in USA

10 PC Screw Extractor Set

| Item | Description | UPC Code | OAL | Body Size | Body Type | Blade Width | Blade Style | Weight (Lbs) | Pkg. Type |
|-------|-------------------------------------------|----------------|-----|-----------|-----------|-------------|-------------|--------------|-----------|
| 37345 | 10 PC Bolt Extractor Set in Case (SAE) | 0 4525637345 5 | XX | N/A | N/A | N/A | N/A | 0.XX | Box |
| 37348 | 10 PC Bolt Extractor Set in Case (Metric) | 0 4525637348 5 | XX | N/A | N/A | N/A | N/A | 0.XX | Box |

Dominator
Pry Bars
Scrapers
Chisels
Punches
Steel Sets/
Kits
Specialty &
Extractors
Retail
Displays
Brass Sets/
Kits
150
Hard Cap
Hollow Punch
Sets
Automotive/
Specialty
Pneumatic
26

27 PC Screw Extractor Set



80002 – 36 Pc Pilot Punch Display

| Item | Description | UPC Code | OAL | Body Size | Body Type | Blade Width | Blade Style | Weight (Lbs) | Pkg. Type |
|-------|--------------------------------------------------------------------------------------------------------------------------------------------------------------------------------------------------------------------------------------------------------------------------------------------------------------------------------------------------------------------------------------|-----------------|-----|-----------|-----------|-------------|-------------|--------------|-----------|
| 80246 | 27 Pc Screw Extractor Set (3 ea) 36961 – D - 1/8" / S#10 - 5/16" (3) 36962 – D - 3/16" / S - 3/8" (3) 36963 – D - 15/64" / S - 7/16" (3) 36964 – D - 5/16" / S - 1/2-9/16" (3) 36965 – D - 3/8" / S - 5/8" (3) 36966 – D - 15/32" / S - 3/4" (3) 36967 – D - 9/16" / S - 7/8" (3) 36968 – D - 21/32" / S - 1-1/8" (3) 36969 – D - 13/16" / S - 1-3/8" (3) | 0 45256 80002 8 | N/A | N/A | N/A | N/A | N/A | 3.2 | Bulk |



37331 – 4 Pc Screw Extractor Set



37332 – 5 Pc Screw Extractor Set

Extractor Sets

| Item | Description | UPC Code | OAL | Body Size | Body Type | Blade Width | Blade Style | Weight (Lbs) | Pkg. Type |
|-------|---------------------------------------------------------------------------------------------------------------------------------------------------------------------------------------------------------------------------------------------|-----------------|-----|-----------|-----------|-------------|-------------|--------------|-----------|
| 37331 | 4 Pc Screw Extractor Set 36966 – Screw Extractor D15/32" S3/4" 36967 – Screw Extractor D9/16" D7/8" 36968 – Screw Extractor 21/32" S1-1/8" 36969 – Screw Extractor D13/16" S1-3/8" | 0 45256 37331 7 | N/A | N/A | N/A | N/A | N/A | 1.69 | Pouch |
| 37332 | 5 Pc Screw Extractor Set 36961 – Screw Extractor D1/8" S1/4"-5/16" 36962 – Screw Extractor D3/16" S3/8" 36963 – Screw Extractor D15/64" S7/16" 36964 – Screw Extractor D5/16" S1/2-9/16" 36965 – Screw Extractor D3/8" S5/8" | 0 45256 37332 4 | N/A | N/A | N/A | N/A | N/A | 0.28 | Pouch |
| 65085 | 5 Pc Spiral Screw Extractor Kit | 0 45256 65085 2 | N/A | N/A | N/A | N/A | N/A | 0.24 | Pouch |

Deck Wrecker Set

| Item | Description | UPC Code | OAL | Body Size | Body Type | Blade Width | Blade Style | Weight (Lbs) | Pkg. Type |
|-------|---------------------------------------------------|-----------------|--------|-----------|-----------|-------------|-------------|--------------|-----------|
| 80030 | 3 Pc Deck Wrecker Display 41104 – Deck Wrecker | 0 45256 80030 1 | 45-1/2 | N/A | N/A | N/A | N/A | 8.76 | N/A |

Screwdriver Set

| Item | Description | UPC Code | OAL | Body Size | Body Type | Blade Width | Blade Style | Weight (Lbs) | Pkg. Type |
|-------|------------------------------------------------------------------------------------------------------------------|-----------------|-----|-----------|-----------|-------------|-------------|--------------|-----------|
| 37343 | 3 Pc Screwdriver Set 35218 – Screwdriver Phil #2 Pt 35724 – Screwdriver 5/16" x 28" 36019 – Screwdriver | 0 45256 37343 0 | N/A | N/A | N/A | N/A | N/A | 3.18 | Bulk |



Mayhew Steel Products, Inc.
199 Industrial Blvd.
Turners Falls, MA 01376

U.S. Toll-Free Customer Service: 800-872-0037
Visit us online at www.Mayhew.com
Always wear safety goggles when using hand tools.

Version 2.2016
For the latest version, visit us
online at www.Mayhew.com

The Pros Know

Dominator

Pry Bars

Scrapers

Chisels

Punches

Steel Sets/
Kits

Specialty &
Extractors

Retail
Displays

Brass Sets/
Kits

150

Hard Cap

Hollow Punch
Sets

Automotive/
Specialty

Pneumatic

27

Retail Displays

Dominator
 Pry Bars
 Scrapers
 Chisels
 Punches
 Steel Sets/
 Kits
 Specialty &
 Extractors
**Retail
 Displays**
 Brass Sets/
 Kits
 150
 Hard Cap
 Hallow Punch
 Sets
 Automotive/
 Specialty
 Pneumatic
 28



80002 – 36PC PILOT PUNCH DISPLAY



80242 – 102 PC PUNCH AND CHISEL DISPLAY



80244 – 18 PC MASONARY DISPLAY



80246 – 27 PC SCREW EXTRACTOR DISPLAY



80247 – 57 PC PUNCH & CHISEL DISPLAY



80018 - 80019 – 24" DISPLAY, PUNCH&CHISEL 33/2-33/3



80235 – 90 PC PRO PUNCH & CHISEL DISPLAY

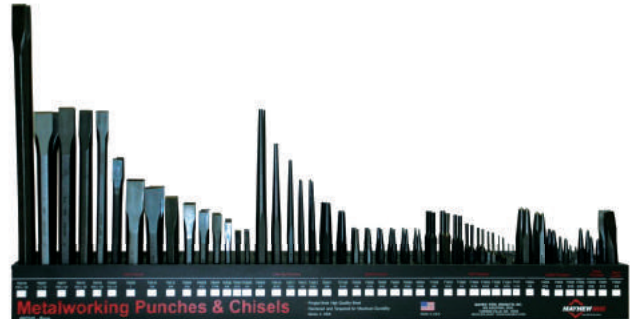

80240 – 132 PC, Punch & Chisel Display



80027 – Dominator 8 PC Large Pry Bar DISPLAY



80026 – STARTER PRY BAR DISPLAY



80260 – LARGE CLAMP DISPLAY

Dominator
 Pry Bars
 Scrapers
 Chisels
 Punches
 Steel Sets/
 Kits
 Specialty &
 Extractors
 Retail
 Displays
 Brass Sets/
 Kits
 150
 Hard Cap
 Hollow Punch
 Sets
 Automotive/
 Specialty
 Pneumatic



Mayhew Steel Products, Inc.
 199 Industrial Blvd.
 Turners Falls, MA 01376

U.S. Toll-Free Customer Service: 800-872-0037
 Visit us online at www.Mayhew.com
 Always wear safety goggles when using hand tools.

Version 2.2016
 For the latest version, visit us
 online at www.Mayhew.com

The Pros Know

Non marring, non sparking USA brass punches and scrapers now offered in an improved smooth polished finish with a double knurled feature for more effective use. Whether the job requires a limited or the widest range of brass tools, Mayhew is the only professional solution to provide the requisite number of tools, within spec and with packaging that withstands typical harsh workplace environments.



Designed to remove gaskets and softer material where there is a concern of damaging the surface or causing sparks.

Brass Scraper

| ITEM | DESCRIPTION | UPC | WEIGHT | LENGTH | WIDTH | BODY SIZE | CUT WIDTH | COO |
|-------|--------------------------------|--------------|--------|--------|-------|-----------|-----------|-----|
| 10655 | BRASS SCRAPER 3/8-10mm X 5-1/2 | 045256106557 | 0.22 | 5.5 | N/A | .375 | 3/8" | US |
| 10657 | BRASS SCRAPER 1/2-13mm X 6 | 045256106571 | .43 | 6 | N/A | .500 | 1/2" | US |
| 10658 | BRASS SCRAPER 5/8-16mm X 6-1/2 | 045256106588 | .79 | 6.5 | N/A | .625 | 5/8" | US |



Designed for loosening frozen or tight pins or knocking out rivets.

Brass Solid Punch

| ITEM | DESCRIPTION | UPC | WEIGHT | LENGTH | BODY SIZE | TAPER LENGTH | TIP WIDTH | COO |
|-------|---------------------|--------------|--------|--------|-----------|--------------|------------|-----|
| 25080 | PUNCH SOLID 1/4 X 6 | 045256250809 | 0.43 | 6 | .500 | 2 | 1/4" & 6mm | US |



Used for driving out and removing already loosened pins after initial movement by a solid punch.

Brass Pin Punch

| ITEM | DESCRIPTION | UPC | WEIGHT | LENGTH | BODY SIZE | TIP LENGTH | TIP WIDTH | COO |
|-------|---------------------|--------------|--------|--------|-----------|------------|-----------|-----|
| 25700 | PUNCH PIN 1/16 X 4 | 045256257006 | 0.07 | 4 | .250 | 1/2 | 1/16" | US |
| 25701 | PUNCH PIN 5/64 X 4 | 045256257013 | 0.07 | 4 | .250 | 5/8 | 5/64" | US |
| 25702 | PUNCH PIN 3/32 X 4 | 045256257020 | 0.07 | 4 | .250 | 7/8 | 3/32" | US |
| 25723 | PUNCH PIN 1/8 X 4 | 045256257235 | 0.07 | 4 | .250 | 1 | 1/8" | US |
| 25704 | PUNCH PIN 5/32 X 4 | 045256257044 | 0.17 | 4 | .375 | 1-1/8 | 5/32" | US |
| 25705 | PUNCH PIN 3/16 X 4 | 045256257051 | 0.17 | 4 | .375 | 1-1/4 | 3/16" | US |
| 25706 | PUNCH PIN 7/32 X 4 | 045256257068 | 0.17 | 4 | .375 | 1-1/4 | 7/32" | US |
| 25707 | PUNCH PIN 1/4 X 4 | 045256257075 | 0.17 | 4 | .375 | 1-1/4 | 1/4" | US |
| 25708 | PUNCH PIN 5/16 X 4 | 045256257082 | 0.30 | 4 | .500 | 1-1/4 | 5/16" | US |
| 25091 | PUNCH PIN 3/8 X 6 | 045256250915 | 0.44 | 6 | .500 | 1-3/4 | 3/8" | US |
| 25709 | PUNCH PIN 7/16 X 6 | 045256257099 | 0.73 | 6 | .625 | 2 | 7/16" | US |
| 25710 | PUNCH PIN 1/2 X 6 | 045256257105 | 0.73 | 6 | .625 | 2 | 1/2" | US |
| 25711 | PUNCH PIN 1.5MM X 4 | 045256257112 | 0.07 | 4 | .250 | 1/2 | 1.5mm | US |
| 25712 | PUNCH PIN 2MM X 4 | 045256257129 | 0.07 | 4 | .250 | 5/8 | 2mm | US |
| 25713 | PUNCH PIN 2.5MM X 4 | 045256257136 | 0.07 | 4 | .250 | 7/8 | 2.5mm | US |
| 25714 | PUNCH PIN 3MM X 4 | 045256257143 | 0.07 | 4 | .250 | 1 | 3mm | US |
| 25715 | PUNCH PIN 4MM X 4 | 045256257150 | 0.17 | 4 | .375 | 1-1/8 | 4mm | US |
| 25716 | PUNCH PIN 5MM X 4 | 045256257167 | 0.17 | 4 | .375 | 1-1/4 | 5mm | US |
| 25717 | PUNCH PIN 6MM X 4 | 045256257174 | 0.17 | 4 | .375 | 1-1/4 | 6mm | US |
| 25718 | PUNCH PIN 8MM X 5 | 045256257181 | 0.30 | 5 | .500 | 1-1/4 | 8mm | US |
| 25719 | PUNCH PIN 10MM X 6 | 045256257198 | 0.44 | 6 | .500 | 1-3/4 | 10mm | US |
| 25720 | PUNCH PIN 12MM X 6 | 045256257204 | 0.73 | 6 | .625 | 2 | 12mm | US |

Dominator
Pry Bars
Scrapers
Chisels
Punches
Steel Sets/
Kits
Specialty &
Extractors
Retail
Displays
Brass Sets/
Kits
150
Hard Cap
Hollow Punch
Sets
Automotive/
Specialty
Pneumatic
30

Non marring, non sparking USA brass punches and scrapers now offered in an improved smooth polished finish with a double knurled feature for more effective use. Whether the job requires a limited or the widest range of brass tools, Mayhew is the only professional solution to provide the requisite number of tools, within spec and with packaging that withstands typical harsh workplace environments.



Used to transfer the force of a hammer blow to a specific location to remove or loosen a part or pin.

Brass Drift Punch

| ITEM | DESCRIPTION | UPC | WEIGHT | LENGTH | WIDTH | BODY SIZE | TIP WIDTH | COO |
|-------|---------------------------|--------------|--------|--------|-------|-----------|-------------|-----|
| 25074 | PUNCH DRIFT 1/4-6mm X 4 | 045256250748 | 0.07 | 4 | N/A | .250 | 1/4" & 6mm | US |
| 25077 | PUNCH DRIFT 3/8-10mm X 6 | 045256250779 | 0.24 | 6 | N/A | .375 | 3/8" & 10mm | US |
| 25076 | PUNCH DRIFT 1/2-13mm X 7 | 045256250762 | 0.50 | 7 | N/A | .500 | 1/2" & 13mm | US |
| 25073 | PUNCH DRIFT 5/8-16mm X 8 | 045256250731 | 0.97 | 8 | N/A | .625 | 5/8" & 16mm | US |
| 25075 | PUNCH DRIFT 3/4-19mm X 8 | 045256250755 | 1.40 | 8 | N/A | .750 | 3/4" & 19mm | US |
| 25078 | PUNCH DRIFT 3/4-19mm X 12 | 045256250786 | 2.10 | 12 | N/A | .750 | 3/4" & 19mm | US |



Designed for aligning holes or parts in which rivets, pins, or bolts are inserted. By inserting the tapered end into semi-aligned holes, the punch can then be driven through the holes for perfect alignment.

Brass Line Up Punch

| ITEM | DESCRIPTION | UPC | WEIGHT | LENGTH | BODY SIZE | TAPER LENGTH | TIP WIDTH | COO |
|-------|------------------------------|--------------|--------|--------|-----------|--------------|--------------|-----|
| 25081 | PUNCH LINE UP 11/32-9mm X 10 | 045256250816 | 1.75 | 10 | .750 | 5.25 | 11/32" & 9mm | US |
| 25095 | PUNCH LINE UP 3/8-10mm X 10 | 045256250953 | 1.75 | 10 | .750 | 5.25 | 3/8" & 10mm | US |
| 25096 | PUNCH LINE UP 7/16-11mm X 14 | 045256250809 | 2.45 | 14 | .750 | 7.875 | 7/16" & 11mm | US |



Originally invented by Mayhew. Also known as a rollpin punch. Designed for the small ball in the center of the pin tip to support the outer edge of the roll pin. Regular pin punches should not be used on roll or spring pins.

Brass Pilot Punch

| ITEM | DESCRIPTION | UPC | WEIGHT | LENGTH | BODY SIZE | TIP LENGTH | TIP WIDTH | COO |
|-------|-----------------------|--------------|--------|--------|-----------|------------|-----------|-----|
| 25064 | PUNCH PILOT 1/16 X 4 | 045256250649 | 0.07 | 4 | .250 | 1/4 | 1/16" | US |
| 25065 | PUNCH PILOT 5/64 X 4 | 045256250656 | 0.07 | 4 | .250 | 5/16 | 5/64" | US |
| 25066 | PUNCH PILOT 3/32 X 4 | 045256250663 | 0.07 | 4 | .250 | 3/8 | 3/32" | US |
| 25067 | PUNCH PILOT 1/8 X 4 | 045256250670 | 0.07 | 4 | .250 | 1/2 | 1/8" | US |
| 25055 | PUNCH PILOT 5/32 X 4 | 045256250557 | 0.17 | 4 | .375 | 3/4 | 5/32" | US |
| 25056 | PUNCH PILOT 3/16 X 4 | 045256250564 | 0.17 | 4 | .375 | 3/4 | 3/16" | US |
| 25057 | PUNCH PILOT 7/32 X 4 | 045256250571 | 0.17 | 4 | .375 | 7/8 | 7/32" | US |
| 25058 | PUNCH PILOT 1/4 X 4 | 045256250588 | 0.17 | 4 | .375 | 1 | 1/4" | US |
| 25068 | PUNCH PILOT 5/16 X 4 | 045256250687 | 0.30 | 4 | .500 | 1-1/8 | 5/16" | US |
| 25061 | PUNCH PILOT 3/8 X 6 | 045256250618 | 0.44 | 6 | .500 | 1-3/4 | 3/8" | US |
| 25062 | PUNCH PILOT 7/16 X 6 | 045256250625 | 0.73 | 6 | .625 | 1-7/8 | 7/16" | US |
| 25063 | PUNCH PILOT 1/2 X 6 | 045256250632 | 0.73 | 6 | .625 | 2 | 1/2" | US |
| 25151 | PUNCH PILOT 1.5MM X 4 | 045256251516 | 0.07 | 4 | .250 | 1/4 | 1.5mm | US |
| 25152 | PUNCH PILOT 2MM X 4 | 045256251523 | 0.07 | 4 | .250 | 5/16 | 2mm | US |
| 25153 | PUNCH PILOT 2.5MM X 4 | 045256251530 | 0.07 | 4 | .250 | 3/8 | 2.5mm | US |
| 25154 | PUNCH PILOT 3MM X 4 | 045256251547 | 0.07 | 4 | .250 | 1/2 | 3mm | US |
| 25155 | PUNCH PILOT 3.5MM X 4 | 045256251554 | 0.17 | 4 | .375 | 5/8 | 3.5mm | US |
| 25156 | PUNCH PILOT 4MM X 4 | 045256251561 | 0.17 | 4 | .375 | 3/4 | 4mm | US |
| 25157 | PUNCH PILOT 5MM X 4 | 045256251578 | 0.17 | 4 | .375 | 7/8 | 5mm | US |
| 25158 | PUNCH PILOT 6MM X 4 | 045256251585 | 0.17 | 4 | .375 | 1 | 6mm | US |
| 25159 | PUNCH PILOT 8MM X 4 | 045256251592 | 0.26 | 4 | .500 | 1-1/8 | 8mm | US |
| 25161 | PUNCH PILOT 10MM X 6 | 045256251615 | 0.38 | 6 | .500 | 1-3/4 | 10mm | US |
| 25162 | PUNCH PILOT 12MM X 6 | 045256251622 | 0.73 | 6 | .625 | 2 | 12mm | US |



Mayhew Steel Products, Inc.
199 Industrial Blvd.
Turners Falls, MA 01376

U.S. Toll-Free Customer Service: 800-872-0037
Visit us online at www.Mayhew.com
Always wear safety goggles when using hand tools.

Version 2.2016
For the latest version, visit us
online at www.Mayhew.com

The Pros Know

Dominator

Pry Bars

Scrapers

Chisels

Punches

Steel Sets/
Kits

Specialty &
Extractors

Retail
Displays

Brass Sets/
Kits

150

Hard Cap

Hollow Punch
Sets

Automotive/
Specialty

Pneumatic

31

Brass Sets

| ITEM | DESCRIPTION | UPC | WEIGHT | LENGTH | WIDTH | HEIGHT | TIP WIDTH | COO |
|-------|------------------------------------------|--------------|--------|--------|-------|--------|-----------|-----|
| 61360 | 3 PC BRASS DRIFT PUNCH SET | 045256613604 | 1.75 | 10.5 | 3.75 | 1 | N/A | US |
| 67002 | 3 PC BRASS DRIFT PUNCH SET | 045256670027 | 1.475 | 10.5 | 3.75 | 1 | N/A | US |
| 67003 | 5 PC BRASS DRIFT PUNCH SET | 045256670034 | 2.685 | 9 | 2.5 | 1.75 | N/A | US |
| 61365 | 3 PC BRASS EXTRA LONG PUNCH SET | 045256613659 | 4.35 | 15 | 2.5 | 1.5 | N/A | US |
| 61363 | 4 PC X-LONG BRASS PUNCH SET | 045256613635 | 6.75 | 16 | 2 | 2 | N/A | US |
| 67004 | 3 PC BRASS PIN PUNCH (INCH) SET | 045256670041 | 0.99 | 10.5 | 3.75 | 1 | N/A | US |
| 67007 | 6 PC BRASS PIN PUNCH (INCH) SET | 045256670072 | 1.025 | 9 | 2.5 | 1.25 | N/A | US |
| 67009 | 4 PC BRASS PIN PUNCH (INCH) SET | 045256670096 | 0.77 | 10.5 | 3.75 | 1 | N/A | US |
| 67008 | 12 PC BRASS PIN PUNCH (INCH) SET | 045256670089 | 2.165 | 9 | 3 | 2 | N/A | US |
| 61387 | 10 PC BRASS PIN PUNCH (METRIC) SET | 045256613871 | 1.735 | 9.25 | 3.25 | 1.75 | N/A | US |
| 62277 | 4 PC BRASS PUNCH (INCH) SET | 045256622774 | 1.04 | 10 | 2.75 | 1 | N/A | US |
| 62278 | 4 PC BRASS PUNCH (INCH) SET | 045256622781 | 1.04 | 10 | 2.75 | 1 | N/A | US |
| 61367 | 9 PC BRASS PILOT PUNCH (INCH) SET | 045256613673 | 1.15 | 7 | 3 | 1.5 | N/A | US |
| 61388 | 9 PC BRASS PILOT PUNCH (METRIC) SET | 045256613888 | 0.96 | 7 | 3 | 1.5 | N/A | US |
| 67001 | 3 PC BRASS SCRAPER SET | 045256670010 | 1.13 | 9 | 1.75 | 1.5 | N/A | US |
| 67012 | 12 PC BRASS PUNCH & SCRAPER (INCH) SET | 045256670126 | 2.375 | 9 | 3.5 | 2 | N/A | US |
| 61397 | 12 PC BRASS PUNCH & SCRAPER (METRIC) SET | 045256613970 | 2.745 | 9 | 3.5 | 1.75 | N/A | US |
| 67015 | 15 PC BRASS PUNCH & SCRAPER SET | 045256670157 | 9 | 21.5 | 8.5 | 1.5 | N/A | US |
| 67019 | 19 PC BRASS PUNCH & SCRAPER KIT | 045256670195 | 5.55 | 8 | 5 | 2.5 | N/A | US |
| 61386 | 6 PC BRASS PIN PUNCH KIT (METRIC) | 045256613864 | 1.2 | 9 | 2.5 | 1.25 | N/A | US |
| 61389 | 17 PC PUNCH & SCRAPER (METRIC) | 045256613895 | 4.05 | 10 | 4 | 2 | N/A | US |



61365
3 PC BRASS EXTRA LONG
PUNCH SET



67004
3 PC BRASS PIN
PUNCH (INCH) SET



67003
5 PC BRASS DRIFT PUNCH SET



67002
3 PC BRASS DRIFT
PUNCH SET

The following category matrices provide a detailed breakdown by SKU for the sets listed previously.

Brass Drift & PC Line Up Punch Kits

| SET NO. | | 67003 | 61363 | 67002 | 61360 |
|---------------------------------------------------------|-----------------------------------------|------------------|-----------------------|------------------|------------------|
| SET DESCRIPTION | | 5 PC DRIFT PUNCH | 4 PC EXTRA LONG PUNCH | 3 PC DRIFT PUNCH | 3 PC DRIFT PUNCH |
| ITEM NO. | ITEM DESCRIPTION | SET CONTENTS | | | |
| 25074 | DRIFT PUNCH 1/4"-6mm X 4 ON 1/4 RD | • | | | |
| 25077 | DRIFT PUNCH 3/8"-10mm X 6 ON 3/8 RD | • | | • | • |
| 25076 | DRIFT PUNCH 1/2"-13mm X 7 ON 1/2 RD | • | | • | • |
| 25073 | DRIFT PUNCH 5/8"-16mm X 8 ON 5/8 RD | • | | • | |
| 25075 | DRIFT PUNCH 3/4"-19mm X 8 ON 3/4 RD | • | | | • |
| 25078 | DRIFT PUNCH 3/4"-19mm X 12 ON 3/4 RD | | • | | |
| 25081 | LINE-UP PUNCH 11/32"-9mm X 10 ON 3/4 RD | | • | | |
| 25095 | LINE-UP PUNCH 3/8"-10mm X 10 ON 3/4 RD | | • | | |
| 25096 | LINE-UP PUNCH 7/16"-11mm X 14 ON 3/4 RD | | • | | |
| Package Type: B = Blister C = Clamshell T = Tray | | KB | KB | T | T |
| R = Rack KB=Kit Bag P=Pouch X = Bulk Box W = Wooden Box | | | | | |

Dominator
Pry Bars
Scrapers
Chisels
Punches
Steel Sets/
Kits
Specialty &
Extractors
Retail
Displays
Brass Sets/
Kits
150
Hard Cap
Hollow Punch
Sets
Automotive/
Specialty
Pneumatic
32

Brass Multi PC Punch Kits



67001
3 PC SCRAPER



67012
12 PC PUNCH & SCRAPER (INCH)



61397
12 PC PUNCH & SCRAPER (MM)



67015
15 PC PUNCH & SCRAPER

| SET NO. | | 67001 | 62277 | 62278 | 67012 | 61397 | 67015 | 67019 | 61389 |
|---------------------------------------------------|-----------------------------------------|--------------|-------------------|-------------------|------------------------------|----------------------------|-----------------------|------------------------------|----------------------------|
| SET DESCRIPTION | | 3 PC SCRAPER | 4 PC PUNCH (INCH) | 4 PC PUNCH (INCH) | 12 PC PUNCH & SCRAPER (INCH) | 12 PC PUNCH & SCRAPER (MM) | 15 PC PUNCH & SCRAPER | 19 PC PUNCH & SCRAPER (INCH) | 17 PC PUNCH & SCRAPER (MM) |
| ITEM NO. | ITEM DESCRIPTION | SET CONTENTS | | | | | | | |
| 10655 | SCRAPER 3/8"-10MM X 5-1/2 ON 3/8 RD | • | | | • | • | • | • | • |
| 10657 | SCRAPER 1/2"-13MM X 6 ON 1/2 RD | • | | | • | • | • | • | • |
| 10658 | SCRAPER 5/8"-16MM X 6-1/2 ON 5/8 RD | • | | | | | | | |
| 25080 | SOLID PUNCH 1/4" X 6 ON 1/2 RD | | • | | | | • | | |
| 25074 | DRIFT PUNCH 1/4"-6mm X 4 ON 1/4 RD | | | | • | • | | • | • |
| 25077 | DRIFT PUNCH 3/8"-10mm X 6 ON 3/8 RD | | • | • | • | • | • | • | • |
| 25076 | DRIFT PUNCH 1/2"-13mm X 7 ON 1/2 RD | | | | • | • | • | • | • |
| 25073 | DRIFT PUNCH 5/8"-16mm X 8 ON 5/8 RD | | | | | | | • | • |
| 25075 | DRIFT PUNCH 3/4"-19mm X 8 ON 3/4 RD | | | | | | • | • | • |
| 25078 | DRIFT PUNCH 3/4"-19mm X 12 ON 3/4 RD | | | | | | • | | |
| 25081 | LINE-UP PUNCH 11/32"-9mm X 10 ON 3/4 RD | | | | | | | | |
| 25095 | LINE-UP PUNCH 3/8"-10mm X 10 ON 3/4 RD | | | | | | • | | |
| 25096 | LINE-UP PUNCH 7/16"-11mm X 14 ON 3/4 RD | | | | | | • | | |
| 25700 | PIN PUNCH 1/16" X 1/2 X 4 ON 1/4 RD | | | | | | | • | |
| 25701 | PIN PUNCH 5/64" X 5/8 X 4 ON 1/4 RD | | | | | | | • | |
| 25702 | PIN PUNCH 3/32" X 7/8 X 4 ON 1/4 RD | | | | | | | • | |
| 25723 | PIN PUNCH 1/8" X 1 X 4 ON 1/4 RD | | | • | • | | • | • | |
| 25704 | PIN PUNCH 5/32" X 1-1/8 X 4 ON 3/8 RD | | | | • | | | • | |
| 25705 | PIN PUNCH 3/16" X 1-1/4 X 4 ON 3/8 RD | | | • | • | | • | • | |
| 25706 | PIN PUNCH 7/32" X 1-1/4 X 4 ON 3/8 RD | | | | • | | | • | |
| 25707 | PIN PUNCH 1/4" X 1-1/4 X 4 ON 3/8 RD | | | | • | | • | • | |
| 25090 | PIN PUNCH 1/4" X 1-1/8 X 4 ON 1/2 RD | | • | | | | | | |
| 25708 | PIN PUNCH 5/16" X 1-1/2 X 4 ON 1/2 RD | | | • | • | | • | • | |
| 25091 | PIN PUNCH 3/8" X 1-3/4 X 6 ON 1/2 RD | | • | | • | | • | • | |
| 25709 | PIN PUNCH 7/16" X 2 X 6 ON 1/2 RD | | | | | | | • | |
| 25710 | PIN PUNCH 1/2" X 2 X 6 ON 5/8 RD | | | | | | | • | |
| 25711 | PIN PUNCH 1.5mm X 1/2 X 4 ON 1/4 RD | | | | | | | | • |
| 25712 | PIN PUNCH 2mm X 5/8 X 4 ON 1/4 RD | | | | | | | | • |
| 25713 | PIN PUNCH 2.5mm X 7/8 X 4 ON 1/4 RD | | | | | | | | • |
| 25714 | PIN PUNCH 3mm X 1 X 4 ON 1/4 RD | | | | | • | | | • |
| 25715 | PIN PUNCH 4mm X 1-1/8 X 4 ON 3/8 RD | | | | | • | | | • |
| 25716 | PIN PUNCH 5mm X 1-1/4 X 4 ON 3/8 RD | | | | | • | | | • |
| 25717 | PIN PUNCH 6mm X 1-1/4 X 4 ON 3/8 RD | | | | | • | | | • |
| 25718 | PIN PUNCH 8mm X 1-1/2 X 4 ON 1/2 RD | | | | | • | | | • |
| 25719 | PIN PUNCH 10mm X 1-3/4 X 6 ON 1/2 RD | | | | | • | | | • |
| 25720 | PIN PUNCH 12mm X 2 X 6 ON 5/8 RD | | | | | • | | | • |
| 25800 | #1 BRASS HAMMER | | | | | | • | | |
| Package Type: B=Blister C=Clamshell T=Tray | | KB | B | B | KB | KB | T | KB | KB |
| R=Rack KB=Kit Bag P=Pouch X=Bulk Box W=Wooden Box | | | | | | | | | |



Mayhew Steel Products, Inc.
199 Industrial Blvd.
Turners Falls, MA 01376

U.S. Toll-Free Customer Service: 800-872-0037
Visit us online at www.Mayhew.com
Always wear safety goggles when using hand tools.

Version 2.2016
For the latest version, visit us
online at www.Mayhew.com

The Pros Know

Dominator
Pry Bars
Scrapers
Chisels
Punches
Steel Sets/
Kits
Specialty &
Extractors
Retail
Displays
Brass Sets/
Kits
150
Hard Cap
Hollow Punch
Sets
Automotive/
Specialty
Pneumatic
33

Brass Pin Punch Kits



67004
3 PC PIN PUNCH SET



67009
4 PC PIN PUNCH SET



67007
6 PC BRASS PIN PUNCH SET



67008
12 PC BRASS PIN PUNCH SET



61387
10 PC BRASS PIN PUNCH SET



61367
9 PC PILOT PUNCH (INCH)



61388
9 PC PILOT PUNCH (METRIC)

| SET NO. | | 67004 | 67007 | 67008 | 67009 | 61386 | 61387 |
|---------------------------------------------------|---------------------------------------|--------------------------------|--------------------------------|---------------------------------|--------------------------------|----------------------------------|-----------------------------------|
| SET DESCRIPTION | | 3 PC PIN PUNCH (INCH) | 6 PC PIN PUNCH (INCH) | 12 PC PIN PUNCH (INCH) | 4 PC PIN PUNCH (INCH) | 6 PC PIN PUNCH (METRIC) | 10 PC PIN PUNCH (METRIC) |
| ITEM NO. | ITEM DESCRIPTION | SET CONTENTS | | | | | |
| 25700 | PIN PUNCH 1/16" X 1/2 X 4 ON 1/4 RD | | | • | | | |
| 25701 | PIN PUNCH 5/64" X 5/8 X 4 ON 1/4 RD | | | • | | | |
| 25702 | PIN PUNCH 3/32" X 7/8 X 4 ON 1/4 RD | | | • | | | |
| 25723 | PIN PUNCH 1/8" X 1 X 4 ON 1/4 RD | | • | • | • | | |
| 25704 | PIN PUNCH 5/32" X 1-1/8 X 4 ON 3/8 RD | | • | • | | | |
| 25705 | PIN PUNCH 3/16" X 1-1/4 X 4 ON 3/8 RD | | • | • | • | | |
| 25706 | PIN PUNCH 7/32" X 1-1/4 X 4 ON 3/8 RD | | | • | | | |
| 25707 | PIN PUNCH 1/4" X 1-1/4 X 4 ON 3/8 RD | • | • | • | | | |
| 25708 | PIN PUNCH 5/16" X 1-1/2 X 4 ON 1/2 RD | | • | • | • | | |
| 25091 | PIN PUNCH 3/8" X 1-3/4 X 6 ON 1/2 RD | • | • | • | | | |
| 25709 | PIN PUNCH 7/16" X 2 X 6 ON 1/2 RD | | | • | • | | |
| 25710 | PIN PUNCH 1/2" X 2 X 6 ON 5/8 RD | • | | • | | | |
| 25711 | PIN PUNCH 1.5mm X 1/2 X 4 ON 1/4 RD | | | | | | • |
| 25712 | PIN PUNCH 2mm X 5/8 X 4 ON 1/4 RD | | | | | | • |
| 25713 | PIN PUNCH 2.5mm X 7/8 X 4 ON 1/4 RD | | | | | | • |
| 25714 | PIN PUNCH 3mm X 1 X 4 ON 1/4 RD | | | | | • | • |
| 25715 | PIN PUNCH 4mm X 1-1/8 X 4 ON 3/8 RD | | | | | • | • |
| 25716 | PIN PUNCH 5mm X 1-1/4 X 4 ON 3/8 RD | | | | | • | • |
| 25717 | PIN PUNCH 6mm X 1-1/4 X 4 ON 3/8 RD | | | | | • | • |
| 25718 | PIN PUNCH 8mm X 1-1/2 X 4 ON 1/2 RD | | | | | • | • |
| 25719 | PIN PUNCH 10mm X 1-3/4 X 6 ON 1/2 RD | | | | | • | • |
| 25720 | PIN PUNCH 12mm X 2 X 6 ON 5/8 RD | | | | | | • |
| Package Type: B=Blister C=Clamshell T=Tray | | T | T | KB | KB | KB | KB |
| R=Rack KB=Kit Bag P=Pouch X=Bulk Box W=Wooden Box | | | | | | | |

Brass Pilot Punch Kits

| SET NO. | | 61367 | 61388 |
|---------------------------------------------------|-----------------------------------------|----------------------------------|------------------------------------|
| SET DESCRIPTION | | 9 PC PILOT PUNCH (INCH) | 9 PC PILOT PUNCH (METRIC) |
| ITEM NO. | ITEM DESCRIPTION | SET CONTENTS | |
| 25064 | PILOT PUNCH 1/16" X 1/4 X 4 ON 1/4 RD | • | |
| 25065 | PILOT PUNCH 5/64" X 5/16 X 4 ON 1/4 RD | • | |
| 25066 | PILOT PUNCH 3/32" X 3/8 X 4 ON 1/4 RD | • | |
| 25067 | PILOT PUNCH 1/8" X 1/2 X 4 ON 1/4 RD | • | |
| 25055 | PILOT PUNCH 5/32" X 3/4 X 4 ON 3/8 RD | • | |
| 25056 | PILOT PUNCH 3/16" X 3/4 X 4 ON 3/8 RD | • | |
| 25058 | PILOT PUNCH 1/4" X 1 X 4 ON 3/8 RD | • | |
| 25068 | PILOT PUNCH 5/16" X 1-1/8 X 4 ON 1/2 RD | • | |
| 25061 | PILOT PUNCH 3/8" X 1-3/4 X 6 ON 1/2 RD | • | |
| 25151 | PILOT PUNCH 1.5mm X 1/4 X 4 ON 1/4 RD | | • |
| 25152 | PILOT PUNCH 2mm X 5/16 X 4 ON 1/4 RD | | • |
| 25153 | PILOT PUNCH 2.5mm X 3/8 X 4 ON 1/4 RD | | • |
| 25154 | PILOT PUNCH 3mm X 1/2 X 4 ON 1/4 RD | | • |
| 25155 | PILOT PUNCH 3.5mm X 5/8 X 4 ON 3/8 RD | | • |
| 25156 | PILOT PUNCH 4mm X 3/4 X 4 ON 3/8 RD | | • |
| 25157 | PILOT PUNCH 5mm X 7/8 X 4 ON 3/8 RD | | • |
| 25158 | PILOT PUNCH 6mm X 1 X 4 ON 3/8 RD | | • |
| 25159 | PILOT PUNCH 8mm X 1-1/4 X 4 ON 1/2 RD | | • |
| 25161 | PILOT PUNCH 10mm X 1-3/4 X 6 ON 1/2 RD | | • |
| Package Type: B=Blister C=Clamshell T=Tray | | | |
| R=Rack KB=Kit Bag P=Pouch X=Bulk Box W=Wooden Box | | KB | KB |

Dominator
Pry Bars
Scrapers
Chisels
Punches
Steel Sets/
Kits
Specialty &
Extractors
Retail
Displays
Brass Sets/
Kits
150
Hard Cap
Hollow Punch
Sets
Automotive/
Specialty
Pneumatic
34

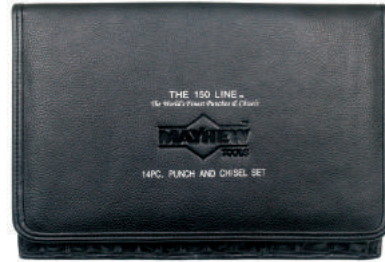

- High-grade S-2 steel for superior tensile strength, toughness, and long life
- Full shank heat treating and parabolic head to reduce mushrooming and chipping of struck end
- Professional black oxide finish for enhanced corrosion resistance
- Full, unconditional lifetime warranty

150 Line Chisels

| Item | Description | UPC Code | OAL | Body Size | Body Type | Blade Width | Blade Style | Weight (Lbs) | Pkg. Type |
|-------|----------------------------|-----------------|-------|-----------|-----------|-------------|-------------|--------------|-----------|
| 15010 | 1/4" Cold Chisel, 150 Line | 0 45256 15010 9 | 5 | 1/4 | Hex | 1/4 | N/A | 0.07 | Bulk |
| 15012 | 3/8" Cold Chisel, 150 Line | 0 45256 15012 3 | 5-1/4 | 5/16 | Hex | 3/8 | N/A | 0.78 | Bulk |
| 15013 | 1/2" Cold Chisel, 150 Line | 0 45256 15013 0 | 6 | 7/16 | Hex | 1/2 | N/A | 0.25 | Bulk |
| 15014 | 5/8" Cold Chisel, 150 Line | 0 45256 15014 7 | 6-1/2 | 1/2 | Hex | 5/8 | N/A | 0.35 | Bulk |
| 15015 | 3/4" Cold Chisel, 150 Line | 0 45256 15015 4 | 7 | 5/8 | Hex | 3/4 | N/A | 0.58 | Bulk |

150 Line Punches

| Item | Description | UPC Code | OAL | Body Size | Body Type | Blade Width | Blade Style | Weight (Lbs) | Pkg. Type |
|-------|---------------------------------|-----------------|-------|-----------|-----------|-------------|-------------|--------------|-----------|
| 15020 | 3/32" Center Punch, 150 Line | 0 45256 15020 8 | 4 | 1/4 | Hex | 3/32 | N/A | 0.06 | Bulk |
| 15022 | 3/16" Pt Center Punch, 150 Line | 0 45256 15022 2 | 5 | 3/8 | Hex | 3/16 | N/A | 0.15 | Bulk |
| 15040 | 1/8" Solid Punch, 150 Line | 0 45256 15040 6 | 5 | 3/8 | Hex | 1/8 | N/A | 0.15 | Bulk |
| 15041 | 3/16" Solid Punch, 150 Line | 0 45256 15041 3 | 5 | 3/8 | Hex | 3/16 | N/A | 0.15 | Bulk |
| 15060 | 1/16" Pin Punch, 150 Line | 0 45256 15060 4 | 4 | 1/4 | Hex | 1/16 | N/A | 0.05 | Bulk |
| 15061 | 3/32" Pin Punch, 150 Line | 0 45256 15061 1 | 4-1/2 | 5/16 | Hex | 3/32 | N/A | 0.08 | Bulk |
| 15062 | 1/8" Pin Punch, 150 Line | 0 45256 15062 8 | 4-3/4 | 5/16 | Hex | 1/8 | N/A | 0.05 | Bulk |
| 15063 | 5/32" Pin Punch, 150 Line | 0 45256 15063 5 | 5 | 5/16 | Hex | 5/32 | N/A | 0.10 | Bulk |
| 15064 | 3/16" Pin Punch, 150 Line | 0 45256 15064 2 | 5-1/4 | 3/8 | Hex | 3/16 | N/A | 0.16 | Bulk |
| 15065 | 1/4" Pin Punch, 150 Line | 0 45256 15065 9 | 5-3/4 | 3/8 | Hex | 1/4 | N/A | 0.17 | Bulk |
| 15081 | 1/8" Long Pin Punch, 150 Line | 0 45256 15081 9 | 7-7/8 | 5/16 | Hex | 1/8 | Extra Long | 0.12 | Bulk |
| 15082 | 3/16" Long Pin Punch, 150 Line | 0 45256 15082 6 | 7-7/8 | 3/8 | Hex | 3/16 | Extra Long | 0.16 | Bulk |
| 15083 | 1/4" Long Pin Punch, 150 Line | 0 45256 15083 3 | 7-7/8 | 3/8 | Hex | 1/4 | Extra Long | 0.19 | Bulk |
| 15084 | 5/16" Long Pin Punch, 150 Line | 0 45256 15084 0 | 7-7/8 | 7/16 | Hex | 5/16 | Extra Long | 0.28 | Bulk |

150 Line Set

| Item | Description | UPC Code | OAL | Body Size | Body Type | Blade Width | Blade Style | Weight (Lbs) | Pkg. Type |
|-------|-------------------------------------|-----------------|-----|-----------|-----------|-------------|-------------|--------------|-----------|
| 15070 | 150 Line – 14 Pc Punch & Chisel Set | 0 45256 15070 3 | 0 | 0 | Hex | 0 | N/A | 3.16 | Leather |



Mayhew Steel Products, Inc.
199 Industrial Blvd.
Turners Falls, MA 01376

U.S. Toll-Free Customer Service: 800-872-0037
Visit us online at www.Mayhew.com
Always wear safety goggles when using hand tools.

Version 2.2016
For the latest version, visit us
online at www.Mayhew.com

The Pros Know

Dominator

Pry Bars

Scrapers

Chisels

Punches

Steel Sets/
Kits

Specialty &
Extractors

Retail
Displays

Brass Sets/
Kits

150

Hard Cap

Hollow Punch
Sets

Automotive/
Specialty

Pneumatic

35



- Impact disc efficiently transfers blow
- Reinforced polymer by DuPont reduces noise by up to 80%
- Cap-and-cushion grip reduces the amount of shock by up to 90%
- Striking surface enlarged by 2 1/2 times
- Eliminates flying metal fragments
- Reduces glancing blows
- Reduces hammer kickback and trauma to wrist and elbow

Hard Cap Chisels

| Item | Description | UPC Code | OAL | Body Size | Body Type | Blade Width | Blade Style | Weight (Lbs) | Pkg. Type |
|-------|----------------------------------|-----------------|-------|-----------|-----------|-------------|-------------|--------------|--------------|
| 66104 | 1/2" X 7" Hard Cap Cold Chisel | 0 81243 66104 3 | 7 | 3/8 | Hex | 1/2 | N/A | 0.33 | Blister Pack |
| 66106 | 3/4" X 8" Hard Cap Cold Chisel | 0 81243 66106 7 | 8 | 5/8 | Hex | 3/4 | N/A | 0.83 | Blister Pack |
| 66107 | 7/8" X 8.5" Hard Cap Cold Chisel | 0 81243 66107 4 | 8-1/2 | 5/8 | Hex | 7/8 | N/A | 1.01 | Blister Pack |
| 66122 | 3/4" X 11" Hard Cap Cold Chisel | 0 81243 66122 7 | 11 | 5/8 | Hex | 3/4 | N/A | 1.12 | Blister Pack |
| 66124 | 1" X 11" Hard Cap Cold Chisel | 0 81243 66124 1 | 11 | 3/4 | Hex | 1 | N/A | 1.58 | Blister Pack |



Hard Cap Punches

| Item | Description | UPC Code | OAL | Body Size | Body Type | Blade Width | Blade Style | Weight (Lbs) | Pkg. Type |
|-------|-------------------------------------|-----------------|-----|-----------|-----------|-------------|-------------|--------------|-----------|
| 66401 | 1/8" X 7" Hard Cap Star Punch | 0 81243 66401 3 | 7 | 3/8 | Hex | 1/8 | N/A | 0.29 | Clamshell |
| 66412 | 7/32" X 7" Hard Cap Center Punch | 0 81243 66412 9 | 7 | 3/8 | Hex | 7/32 | N/A | 0.31 | Clamshell |
| 66414 | 1/4" X 7" Hard Cap Center Punch | 0 81243 66414 3 | 7 | 7/16 | Hex | 1/4 | N/A | 0.38 | Clamshell |
| 66422 | 1/8" X 7" Hard Cap Pin Punch | 0 81243 66422 8 | 7 | 5/8 | Hex | 1/8 | N/A | 0.27 | Clamshell |
| 66423 | 5/32" X 7" Hard Cap Pin Punch | 0 81243 66423 5 | 7 | 3/8 | Hex | 5/32 | N/A | 0.27 | Clamshell |
| 66424 | 3/16" X 7" Hard Cap Pin Punch | 0 81243 66424 2 | 7 | 3/8 | Hex | 3/16 | N/A | 0.28 | Clamshell |
| 66427 | 1/4" X 7" Hard Cap Pin Punch | 0 81243 66427 3 | 7 | 7/16 | Hex | 1/4 | N/A | 0.35 | Clamshell |
| 66435 | 7/32" X 7" Hard Cap Prick Punch | 0 81243 66435 8 | 7 | 3/8 | Hex | 7/32 | N/A | 0.29 | Clamshell |
| 66440 | 3/16" X 9" Hard Cap Aligning Punch | 0 81243 66440 2 | 9 | 3/8 | Hex | 3/16 | N/A | 0.35 | Clamshell |
| 66441 | 1/4" X 10" Hard Cap Aligning Punch | 0 81243 66441 9 | 10 | 7/16 | Hex | 1/4 | N/A | 0.51 | Clamshell |
| 66442 | 5/16" X 11" Hard Cap Aligning Punch | 0 81243 66442 6 | 11 | 5/8 | Hex | 5/16 | N/A | 1.04 | Clamshell |

Hard Cap Sets

| Item | Description | UPC Code | OAL | Body Size | Body Type | Blade Width | Blade Style | Weight (Lbs) | Pkg. Type |
|-------|-----------------------------------|-----------------|-----|-----------|-----------|-------------|-------------|--------------|-----------|
| 66900 | 4 Pc Hard Cap Cold Chisel Set | 0 81243 66900 1 | 0 | 0 | Hex | 0 | N/A | 3.20 | Pouch |
| 66475 | 3 Pc Hard Cap Nail Set | 0 81243 66475 4 | 0 | 0 | Round | 0 | N/A | 1.00 | Carded |
| 66901 | 4 Pc Hard Cap Pin Punch Set | 0 81243 66901 8 | 0 | 0 | Hex | 0 | N/A | 1.09 | Pouch |
| 66902 | 4 Pc Hard Cap Punch Set | 0 81243 66902 5 | 0 | 0 | Hex | 0 | N/A | 1.19 | Pouch |
| 66907 | 3 Pc Hard Cap Alignment Punch Set | 0 81243 66907 0 | 0 | 0 | Hex | 0 | N/A | 1.87 | Pouch |



66900 – 4 Pc Hard Cap Cold Chisel Set



66475 – 3 Pc Hard Cap Nail Set



66901 – 4 Pc Hard Cap Pin Punch Set



66902 – 4 Pc Hard Cap Punch Set



66907 – 3 Pc Hard Cap Alignment Punch Set

Dominator
Pry Bars
Scrapers
Chisels
Punches
Steel Sets/
Kits
Specialty &
Extractors
Retail
Displays
Brass Sets/
Kits
150
Hard Cap
Hollow Punch
Sets
Automotive/
Specialty
Pneumatic
36

Hollow Punch Sets

| Item | Description | UPC Code | OAL | Body Size | Body Type | Blade Width | Blade Style | Weight (Lbs) | Pkg. Type |
|------------------------------------------------------------------------------------------------------------------------------------|--------------------------------------------------------------------------------------------------------------------------------------------------------------------------------------------------------------------------------------------------------------------------------------------------------------------------------------------------------------------------------------------------------------------------------------------------------------------------------------------------------------------------------------------------------------------------------------------------------------------------------------------------------------------------------------------------------------------------------------------------------------------------------------------------------------------------------------------------------------------------------------------------------------------------------------------------------------------------------------------------|-----------------|-----|-----------|-----------|-------------|-------------|--------------|--------------|
| 66004 | 16 Pc Hollow Punch Set (Metric) 50500 – Handle for 16 Pc Hollow Punch Kit 50551 – 3mm Hollow Punch 50552 – 4mm Hollow Punch 50554 – 6mm Hollow Punch 50556 – 8mm Hollow Punch 50558 – 10mm Hollow Punch 50559 – 12mm Hollow Punch 50560 – 14mm Hollow Punch 50561 – 16mm Hollow Punch 50562 – 18mm Hollow Punch 50563 – 20mm Hollow Punch 50564 – 22mm Hollow Punch 50565 – 24mm Hollow Punch 50566 – 26mm Hollow Punch 50567 – 28mm Hollow Punch 50568 – 30mm Hollow Punch | 0 45256 66004 2 | N/A | N/A | N/A | N/A | N/A | 2.47 | Plastic Case |
| 66006 | 31 Pc Hollow Punch Set (Metric) 50530 – Handle for 27 & 36 Pc Hollow Punch Kit 50540 – Mandril for 27 Pc Hollow Punch Kit 50550 – 2mm Hollow Punch 50551 – 3mm Hollow Punch 50552 – 4mm Hollow Punch 50553 – 5mm Hollow Punch 50554 – 6mm Hollow Punch 50555 – 7mm Hollow Punch 50556 – 8mm Hollow Punch 50557 – 9mm Hollow Punch 50558 – 10mm Hollow Punch 50559 – 12mm Hollow Punch 50560 – 14mm Hollow Punch 50561 – 16mm Hollow Punch 50562 – 18mm Hollow Punch 50563 – 20mm Hollow Punch 50564 – 22mm Hollow Punch 50565 – 24mm Hollow Punch 50566 – 26mm Hollow Punch 50567 – 28mm Hollow Punch 50568 – 30mm Hollow Punch 50569 – 32mm Hollow Punch 50570 – 34mm Hollow Punch 50571 – 36mm Hollow Punch 50572 – 38mm Hollow Punch 50573 – 40mm Hollow Punch 50574 – 42mm Hollow Punch 50575 – 44mm Hollow Punch 50576 – 46mm Hollow Punch 50577 – 48mm Hollow Punch 50578 – 50mm Hollow Punch | 0 45256 66006 6 | N/A | N/A | N/A | N/A | N/A | 6.06 | Plastic Case |
|  <p>66006 – 31 Pc Hollow Punch Set (Metric)</p> | | | | | | | | | |
| 66010 | 11 Pc Hollow Punch Set (Metric) 50490 – Handle for 11 Pc Hollow Punch Kit 50551 – 3mm Hollow Punch 50552 – 4mm Hollow Punch 50554 – 6mm Hollow Punch 50556 – 8mm Hollow Punch 50558 – 10mm Hollow Punch 50559 – 12mm Hollow Punch 50560 – 14mm Hollow Punch 50561 – 16mm Hollow Punch 50562 – 18mm Hollow Punch 50563 – 20mm Hollow Punch | 0 45256 66010 3 | N/A | N/A | N/A | N/A | N/A | 1.32 | Plastic Case |
| 50580 | 2 Pc Conversion Handle Set | 0 45256 50580 0 | N/A | N/A | N/A | N/A | N/A | 1.40 | Plastic Bag |

Dominator
 Pry Bars
 Scrapers
 Chisels
 Punches
 Steel Sets/
 Kits
 Specialty &
 Extractors
 Retail
 Displays
 Brass Sets/
 Kits
 150
 Hard Cap
**Hollow Punch
 Sets**
 Automotive/
 Specialty
 Pneumatic



Mayhew Steel Products, Inc.
199 Industrial Blvd.
Turners Falls, MA 01376

U.S. Toll-Free Customer Service: 800-872-0037
Visit us online at www.Mayhew.com
Always wear safety goggles when using hand tools.

Version 2.2016
For the latest version, visit us
online at www.Mayhew.com

Hollow Punch Sets – Cont.

| Item | Description | UPC Code | OAL | Body Size | Body Type | Blade Width | Blade Style | Weight (Lbs) | Pkg. Type |
|---------------------------------------------|-----------------------------------------------------------------------------------------------------------------------------------------------------------------------------------------------------------------------------------------------------------------------------------------------------------------------------------------------------------------------------------------------------------------------------------------------------------------------------------------------------------------------------------------------------------------------------------------------------------------------------------------------------------------------------------------------------------------------------------------------------------------------------------------------------------------------------------------------------------------------------------------------------------------|-----------------|-----|-----------|-----------|-------------|-------------|--------------|--------------|
| 66002 | 27 Pc Hollow Punch Set (SAE) 50501 – 1/8" Hollow Punch 50502 – 3/16" Hollow Punch 50503 – 1/4" Hollow Punch 50504 – 5/16" Hollow Punch 50505 – 3/8" Hollow Punch 50506 – 7/16" Hollow Punch 50507 – 1/2" Hollow Punch 50508 – 9/16" Hollow Punch 50509 – 5/8" Hollow Punch 50510 – 3/4" Hollow Punch 50511 – 7/8" Hollow Punch 50512 – 1" Hollow Punch 50513 – 1-1/16" Hollow Punch 50514 – 1-1/8" Hollow Punch 50515 – 1-3/16" Hollow Punch 50516 – 1-1/4" Hollow Punch 50517 – 1-5/16" Hollow Punch 50518 – 1-3/8" Hollow Punch 50519 – 1-7/16" Hollow Punch 50520 – 1-1/2" Hollow Punch 50521 – 1-5/8" Hollow Punch 50522 – 1-11/16" Hollow Punch 50523 – 1-3/4" Hollow Punch 50524 – 1-7/8" Hollow Punch 50525 – 2" Hollow Punch 50530 – Handle for 27 & 36 Pc Hollow Punch Kit 50540 – Mandril for 27 Pc Hollow Punch Kit | 0 45256 66002 8 | N/A | N/A | N/A | N/A | N/A | 5.74 | Plastic Case |
| 66000 | 16 Pc Hollow Punch Set (SAE) 50500 – Handle 50501 – 1/8" Hollow Punch 50502 – 3/16" Hollow Punch 50503 – 1/4" Hollow Punch 50504 – 5/16" Hollow Punch 50505 – 3/8" Hollow Punch 50506 – 7/16" Hollow Punch 50507 – 1/2" Hollow Punch 50508 – 9/16" Hollow Punch 50509 – 5/8" Hollow Punch 50510 – 3/4" Hollow Punch 50511 – 7/8" Hollow Punch 50512 – 1" Hollow Punch 50513 – 1-1/16" Hollow Punch 50514 – 1-1/8" Hollow Punch 50515 – 1-3/16" Hollow Punch | 0 45256 66000 4 | N/A | N/A | N/A | N/A | N/A | 2.42 | Plastic Case |
| <p>66000 – 16 Pc Hollow Punch Set (SAE)</p> | | | | | | | | | |
| 66008 | 11 Pc Hollow Punch Set (SAE) 50490 – Handle for 11 Pc Hollow Punch Kit 50501 – 1/8" Hollow Punch 50502 – 3/16" Hollow Punch 50503 – 1/4" Hollow Punch 50504 – 5/16" Hollow Punch 50505 – 3/8" Hollow Punch 50506 – 7/16" Hollow Punch 50507 – 1/2" Hollow Punch 50508 – 9/16" Hollow Punch 50509 – 5/8" Hollow Punch 50510 – 3/4" Hollow Punch | 0 45256 66008 0 | N/A | N/A | N/A | N/A | N/A | 1.32 | Plastic Case |
| 66012 | 10 Pc Hollow Punch Set (SAE) 50500 – Handle 50501 – 1/8" Hollow Punch 50502 – 3/16" Hollow Punch 50503 – 1/4" Hollow Punch 50504 – 5/16" Hollow Punch 50505 – 3/8" Hollow Punch 50526 – 5/32" Hollow Punch 50527 – 7/32" Hollow Punch 50528 – 9/32" Hollow Punch 50529 – 11/32" Hollow Punch | 0 45256 66012 7 | N/A | N/A | N/A | N/A | N/A | 0.62 | Plastic Case |

Dominator
 Pry Bars
 Scrapers
 Chisels
 Punches
 Steel Sets/
 Kits
 Specialty &
 Extractors
 Retail
 Displays
 Brass Sets/
 Kits
 150
 Hard Cap
 Hollow Punch
 Sets
 Automotive/
 Specialty
 Pneumatic
 38

Hollow Punch Sets – Cont.

| Item | Description | UPC Code | OAL | Body Size | Body Type | Blade Width | Blade Style | Weight (Lbs) | Pkg. Type |
|-------|-------------------------------------------------------------------------------------------------------------------------------------------------------------------------------------------------------------------------------------------------------------------------------------------------------------------------------------------------------------------------------------------------------------------------------------------------------------------------------------------------------------------------------------------------------------------------------------------------------------------------------------------------------------------------------------------------------------------------------------------------------------------------------------------------------------------------------------------------------------------------------------------------------------------------------------------------------------------------------------------------------------------------------------------------------------------------------------------------------------------------------------------------------------------------------------------------------|-----------------|-----|-----------|-----------|-------------|-------------|--------------|--------------|
| 66016 | 36 Pc Hollow Punch Set (SAE) 50501 – 1/8" Hollow Punch 50502 – 3/16" Hollow Punch 50503 – 1/4" Hollow Punch 50504 – 5/16" Hollow Punch 50505 – 3/8" Hollow Punch 50506 – 7/16" Hollow Punch 50507 – 1/2" Hollow Punch 50508 – 9/16" Hollow Punch 50509 – 5/8" Hollow Punch 50510 – 3/4" Hollow Punch 50511 – 7/8" Hollow Punch 50512 – 1" Hollow Punch 50513 – 1-1/16" Hollow Punch 50514 – 1-1/8" Hollow Punch 50515 – 1-3/16" Hollow Punch 50516 – 1-1/4" Hollow Punch 50517 – 1-5/16" Hollow Punch 50518 – 1-3/8" Hollow Punch 50519 – 1-7/16" Hollow Punch 50520 – 1-1/2" Hollow Punch 50521 – 1-5/8" Hollow Punch 50522 – 1-11/16" Hollow Punch 50523 – 1-3/4" Hollow Punch 50524 – 1-7/8" Hollow Punch 50525 – 2" Hollow Punch 50526 – 5/32" Hollow Punch 50527 – 7/32" Hollow Punch 50528 – 9/32" Hollow Punch 50529 – 11/32" Hollow Punch 50530 – Handle for 27 & 36 Pc Hollow Punch Kit 50539 – Mandril for 36 Pc Hollow Punch Kit 50541 – 2-1/8" Hollow Punch 50542 – 2-3/16" Hollow Punch 50543 – 2-1/4" Hollow Punch 50544 – 2-5/16" Hollow Punch 50546 – 2-3/8" Hollow Punch | 0 45256 66016 5 | N/A | N/A | N/A | N/A | N/A | 11.47 | Plastic Case |
| 66080 | 28 Pc Hollow Punch Set (SAE) 50501 – 1/8" Hollow Punch 50502 – 3/16" Hollow Punch 50503 – 1/4" Hollow Punch 50504 – 5/16" Hollow Punch 50505 – 3/8" Hollow Punch 50506 – 7/16" Hollow Punch 50507 – 1/2" Hollow Punch 50508 – 9/16" Hollow Punch 50509 – 5/8" Hollow Punch 50510 – 3/4" Hollow Punch 50511 – 7/8" Hollow Punch 50512 – 1" Hollow Punch 50513 – 1-1/16" Hollow Punch 50514 – 1-1/8" Hollow Punch 50515 – 1-3/16" Hollow Punch 50516 – 1-1/4" Hollow Punch 50517 – 1-5/16" Hollow Punch 50518 – 1-3/8" Hollow Punch 50519 – 1-7/16" Hollow Punch 50520 – 1-1/2" Hollow Punch 50521 – 1-5/8" Hollow Punch 50522 – 1-11/16" Hollow Punch 50523 – 1-3/4" Hollow Punch 50524 – 1-7/8" Hollow Punch 50525 – 2" Hollow Punch 50580 – 2 Pc Conversion Handle Set | 0 45256 66080 6 | N/A | N/A | N/A | N/A | N/A | 5.8 | Plastic Case |



66080 – 28 Pc Hollow Punch Set (SAE)

| |
|---------------------------|
| Dominator |
| Pry Bars |
| Scrapers |
| Chisels |
| Punches |
| Steel Sets/ Kits |
| Specialty & Extractors |
| Retail Displays |
| Brass Sets/ Kits |
| 150 |
| Hard Cap |
| Hollow Punch Sets |
| Automotive/ Specialty |
| Pneumatic |
| 39 |



Mayhew Steel Products, Inc.
199 Industrial Blvd.
Turners Falls, MA 01376

U.S. Toll-Free Customer Service: 800-872-0037
Visit us online at www.Mayhew.com
Always wear safety goggles when using hand tools.

Version 2.2016
For the latest version, visit us
online at www.Mayhew.com

The Pros Know



- Used to create precise gaskets and washers in softer materials, e.g., cloth, vinyl, leather, light sheet metal, and gasket material
- Wide array of sizes available for numerous ID and OD configurations
- Available in kits or sold individually; various mandrels and handles available to use with striking tools
- Dual cutting heads allow the user to punch concentric circles in one strike
- Made in France

Hollow Punches (Metric)

| Item | Description | UPC Code | OAL | Body Size | Body Type | Blade Width | Blade Style | Weight (Lbs) | Pkg. Type |
|-------|-------------------|-----------------|-----|-----------|-----------|-------------|-------------|--------------|-------------|
| 50550 | 2mm Hollow Punch | 0 45256 50550 3 | 0 | 0 | N/A | 2mm | N/A | 0.02 | Plastic Bag |
| 50551 | 3mm Hollow Punch | 0 45256 50551 0 | 0 | 0 | N/A | 3mm | N/A | 0.02 | Plastic Bag |
| 50552 | 4mm Hollow Punch | 0 45256 50552 7 | 0 | 0 | N/A | 4mm | N/A | 0.02 | Plastic Bag |
| 50553 | 5mm Hollow Punch | 0 45256 50553 4 | 0 | 0 | N/A | 5mm | N/A | 0.02 | Plastic Bag |
| 50554 | 6mm Hollow Punch | 0 45256 50554 1 | 0 | 0 | N/A | 6mm | N/A | 0.02 | Plastic Bag |
| 50555 | 7mm Hollow Punch | 0 45256 50555 8 | 0 | 0 | N/A | 7mm | N/A | 0.02 | Plastic Bag |
| 50556 | 8mm Hollow Punch | 0 45256 50556 5 | 0 | 0 | N/A | 8mm | N/A | 0.02 | Plastic Bag |
| 50557 | 9mm Hollow Punch | 0 45256 50557 2 | 0 | 0 | N/A | 9mm | N/A | 0.02 | Plastic Bag |
| 50558 | 10mm Hollow Punch | 0 45256 50558 9 | 0 | 0 | N/A | 10mm | N/A | 0.02 | Plastic Bag |
| 50559 | 12mm Hollow Punch | 0 45256 50559 6 | 0 | 0 | N/A | 12mm | N/A | 0.05 | Plastic Bag |
| 50560 | 14mm Hollow Punch | 0 45256 50560 2 | 0 | 0 | N/A | 14mm | N/A | 0.05 | Plastic Bag |
| 50561 | 16mm Hollow Punch | 0 45256 50561 9 | 0 | 0 | N/A | 16mm | N/A | 0.05 | Plastic Bag |
| 50562 | 18mm Hollow Punch | 0 45256 50562 6 | 0 | 0 | N/A | 18mm | N/A | 0.05 | Plastic Bag |
| 50563 | 20mm Hollow Punch | 0 45256 50563 3 | 0 | 0 | N/A | 20mm | N/A | 0.09 | Plastic Bag |
| 50564 | 22mm Hollow Punch | 0 45256 50564 0 | 0 | 0 | N/A | 22mm | N/A | 0.09 | Plastic Bag |
| 50565 | 24mm Hollow Punch | 0 45256 50565 7 | 0 | 0 | N/A | 24mm | N/A | 0.09 | Plastic Bag |
| 50566 | 26mm Hollow Punch | 0 45256 50566 4 | 0 | 0 | N/A | 26mm | N/A | 0.09 | Plastic Bag |
| 50567 | 28mm Hollow Punch | 0 45256 50567 1 | 0 | 0 | N/A | 28mm | N/A | 0.09 | Plastic Bag |
| 50568 | 30mm Hollow Punch | 0 45256 50568 8 | 0 | 0 | N/A | 30mm | N/A | 0.09 | Plastic Bag |
| 50569 | 32mm Hollow Punch | 0 45256 50569 5 | 0 | 0 | N/A | 32mm | N/A | 0.15 | Plastic Bag |
| 50570 | 34mm Hollow Punch | 0 45256 50570 1 | 0 | 0 | N/A | 34mm | N/A | 0.15 | Plastic Bag |
| 50571 | 36mm Hollow Punch | 0 45256 50571 8 | 0 | 0 | N/A | 36mm | N/A | 0.15 | Plastic Bag |
| 50572 | 38mm Hollow Punch | 0 45256 50572 5 | 0 | 0 | N/A | 38mm | N/A | 0.15 | Plastic Bag |
| 50573 | 40mm Hollow Punch | 0 45256 50573 2 | 0 | 0 | N/A | 40mm | N/A | 0.15 | Plastic Bag |
| 50574 | 42mm Hollow Punch | 0 45256 50574 9 | 0 | 0 | N/A | 42mm | N/A | 0.23 | Plastic Bag |
| 50575 | 44mm Hollow Punch | 0 45256 50575 6 | 0 | 0 | N/A | 44mm | N/A | 0.23 | Plastic Bag |
| 50576 | 46mm Hollow Punch | 0 45256 50576 3 | 0 | 0 | N/A | 46mm | N/A | 0.23 | Plastic Bag |
| 50577 | 48mm Hollow Punch | 0 45256 50577 0 | 0 | 0 | N/A | 48mm | N/A | 0.23 | Plastic Bag |
| 50578 | 50mm Hollow Punch | 0 45256 50578 7 | 0 | 0 | N/A | 50mm | N/A | 0.23 | Plastic Bag |
| 50579 | 51mm Hollow Punch | 0 45256 50579 4 | 0 | 0 | N/A | 51mm | N/A | 0.23 | Plastic Bag |



Hollow Punch Handles

| Item | Description | UPC Code | OAL | Body Size | Body Type | Blade Width | Blade Style | Weight (Lbs) | Pkg. Type |
|-------|----------------------------------------|-----------------|-----|-----------|-----------|-------------|-------------|--------------|-------------|
| 50490 | Handle for 11 Pc Hollow Punch Kit | 0 45256 50490 2 | 4 | 1-1/2 | N/A | 0 | N/A | 0.76 | Plastic Bag |
| 50500 | Handle for 16 Pc Hollow Punch Kit | 0 45256 50500 8 | 5 | 1-1/2 | N/A | 0 | N/A | 1.04 | Plastic Bag |
| 50530 | Handle for 27 & 36 Pc Hollow Punch Kit | 0 45256 50530 5 | 0 | 0 | N/A | 0 | N/A | 1.14 | Plastic Bag |
| 50539 | Mandril for 36 Pc Hollow Punch Kit | 0 45256 50539 8 | 0 | 0 | N/A | 0 | N/A | 1.25 | Plastic Bag |
| 50540 | Mandril for 27 Pc Hollow Punch Kit | 0 45256 50540 4 | 0 | 0 | N/A | 0 | N/A | 0.78 | Plastic Bag |
| 50545 | 2 Pc Handle & Mandril for 27 Pc Kit | 0 45256 50545 9 | 5 | 0 | N/A | 0 | N/A | 1.04 | Plastic Bag |
| 50580 | 2 Pc Pistol Grip Conversion Handle Set | 0 45256 50580 0 | N/A | N/A | N/A | N/A | N/A | 1.40 | Plastic Bag |

Dominator
Pry Bars
Scrapers
Chisels
Punches
Steel Sets/
Kits
Specialty &
Extractors
Retail
Displays
Brass Sets/
Kits
150
Hard Cap
Hollow Punch
Sets
Automotive/
Specialty
Pneumatic
40



- Used to create precise gaskets and washers in softer materials; e.g. cloth, vinyl, leather, light sheet metal, and gasket material
- Wide array of sizes available for numerous ID and OD configurations
- Available in kits or sold individually; various mandrels and handles available to use with striking tools
- Dual cutting heads allow the user to punch concentric circles in one strike
- Made in France

Hollow Punches (Imperial)

| Item | Description | UPC Code | OAL | Body Size | Body Type | Blade Width | Blade Style | Weight (Lbs) | Pkg. Type |
|-------|-----------------------|-----------------|-----|-----------|-----------|-------------|-------------|--------------|-------------|
| 50501 | 1/8" Hollow Punch | 0 45256 50501 5 | 0 | 0 | N/A | 1/8 | N/A | 0.02 | Plastic Bag |
| 50502 | 3/16" Hollow Punch | 0 45256 50502 2 | 0 | 0 | N/A | 3/16 | N/A | 0.02 | Plastic Bag |
| 50503 | 1/4" Hollow Punch | 0 45256 50503 9 | 0 | 0 | N/A | 1/4 | N/A | 0.02 | Plastic Bag |
| 50504 | 5/16" Hollow Punch | 0 45256 50504 6 | 0 | 0 | N/A | 5/16 | N/A | 0.02 | Plastic Bag |
| 50505 | 3/8" Hollow Punch | 0 45256 50505 3 | 0 | 0 | N/A | 3/8 | N/A | 0.02 | Plastic Bag |
| 50506 | 7/16" Hollow Punch | 0 45256 50506 0 | 0 | 0 | N/A | 7/16 | N/A | 0.05 | Plastic Bag |
| 50507 | 1/2" Hollow Punch | 0 45256 50507 7 | 0 | 0 | N/A | 1/2 | N/A | 0.05 | Plastic Bag |
| 50508 | 9/16" Hollow Punch | 0 45256 50508 4 | 0 | 0 | N/A | 9/16 | N/A | 0.05 | Plastic Bag |
| 50509 | 5/8" Hollow Punch | 0 45256 50509 1 | 0 | 0 | N/A | 5/8 | N/A | 0.05 | Plastic Bag |
| 50510 | 3/4" Hollow Punch | 0 45256 50510 7 | 0 | 0 | N/A | 3/4 | N/A | 0.05 | Plastic Bag |
| 50511 | 7/8" Hollow Punch | 0 45256 50511 4 | 0 | 0 | N/A | 7/8 | N/A | 0.08 | Plastic Bag |
| 50512 | 1" Hollow Punch | 0 45256 50512 1 | 0 | 0 | N/A | 1 | N/A | 0.08 | Plastic Bag |
| 50513 | 1-1/16" Hollow Punch | 0 45256 50513 8 | 0 | 0 | N/A | 1-1/16 | N/A | 0.08 | Plastic Bag |
| 50514 | 1-1/8" Hollow Punch | 0 45256 50514 5 | 0 | 0 | N/A | 1-1/8 | N/A | 0.08 | Plastic Bag |
| 50515 | 1-3/16" Hollow Punch | 0 45256 50515 2 | 0 | 0 | N/A | 1-3/16 | N/A | 0.08 | Plastic Bag |
| 50516 | 1-1/4" Hollow Punch | 0 45256 50516 9 | 0 | 0 | N/A | 1-1/4 | N/A | 0.16 | Plastic Bag |
| 50517 | 1-5/16" Hollow Punch | 0 45256 50517 6 | 0 | 0 | N/A | 1-5/16 | N/A | 0.16 | Plastic Bag |
| 50518 | 1-3/8" Hollow Punch | 0 45256 50518 3 | 0 | 0 | N/A | 1-3/8 | N/A | 0.16 | Plastic Bag |
| 50519 | 1-7/16" Hollow Punch | 0 45256 50519 0 | 0 | 0 | N/A | 1-7/16 | N/A | 0.16 | Plastic Bag |
| 50520 | 1-1/2" Hollow Punch | 0 45256 50520 6 | 0 | 0 | N/A | 1-1/2 | N/A | 0.16 | Plastic Bag |
| 50521 | 1-5/8" Hollow Punch | 0 45256 50521 3 | 0 | 0 | N/A | 1-5/8 | N/A | 0.22 | Plastic Bag |
| 50522 | 1-11/16" Hollow Punch | 0 45256 50522 0 | 0 | 0 | N/A | 1-11/16 | N/A | 0.22 | Plastic Bag |
| 50523 | 1-3/4" Hollow Punch | 0 45256 50523 7 | 0 | 0 | N/A | 1-3/4 | N/A | 0.22 | Plastic Bag |
| 50524 | 1-7/8" Hollow Punch | 0 45256 50524 4 | 0 | 0 | N/A | 1-7/8 | N/A | 0.22 | Plastic Bag |
| 50525 | 2" Hollow Punch | 0 45256 50525 1 | 0 | 0 | N/A | 2 | N/A | 0.22 | Plastic Bag |
| 50526 | 5/32" Hollow Punch | 0 45256 50526 8 | 0 | 0 | N/A | 5/32 | N/A | 0.02 | Plastic Bag |
| 50527 | 7/32" Hollow Punch | 0 45256 50527 5 | 0 | 0 | N/A | 7/32 | N/A | 0.02 | Plastic Bag |
| 50528 | 9/32" Hollow Punch | 0 45256 50528 2 | 0 | 0 | N/A | 9/32 | N/A | 0.02 | Plastic Bag |
| 50529 | 11/32" Hollow Punch | 0 45256 50529 9 | 0 | 0 | N/A | 11/32 | N/A | 0.02 | Plastic Bag |
| 50541 | 2-1/8" Hollow Punch | 0 45256 50541 1 | 0 | 0 | N/A | 2-1/8 | N/A | 0.32 | Plastic Bag |
| 50542 | 2-3/16" Hollow Punch | 0 45256 50542 8 | 0 | 0 | N/A | 2-3/16 | N/A | 0.29 | Plastic Bag |
| 50543 | 2-1/4" Hollow Punch | 0 45256 50543 5 | 0 | 0 | N/A | 2-1/4 | N/A | 0.29 | Plastic Bag |
| 50544 | 2 5/16" Hollow Punch | 0 45256 50544 2 | 0 | 0 | N/A | 2-5/16 | N/A | 0.29 | Plastic Bag |
| 50546 | 2-3/8" Hollow Punch | 0 45256 50546 6 | 0 | 0 | N/A | 2-3/8 | N/A | 0.29 | Plastic Bag |

Dominator
 Pry Bars
 Scrapers
 Chisels
 Punches
 Steel Sets/
 Kits
 Specialty &
 Extractors
 Retail
 Displays
 Brass Sets/
 Kits
 150
 Hard Cap
 Hollow Punch
 Sets
 Automotive/
 Specialty
 Pneumatic
 41



Mayhew Steel Products, Inc.
 199 Industrial Blvd.
 Turners Falls, MA 01376

U.S. Toll-Free Customer Service: 800-872-0037
 Visit us online at www.Mayhew.com
 Always wear safety goggles when using hand tools.

Version 2.2016
 For the latest version, visit us
 online at www.Mayhew.com

The Pros Know



31000 – 4 Pc Upholstery Clip Set

Automotive

| Item | Description | UPC Code | OAL | Body Size | Body Type | Blade Width | Blade Style | Weight (Lbs) | Pkg. Type |
|-------|--------------------------------------------------------------------------------------------------------------------------------------------------------------------------------|-----------------|-----|-----------|-----------|-------------|-------------|--------------|-----------|
| 31000 | 4 Pc Upholstery Clip Set 31001 – Upholstery Clip Remover 31002 – Upholstery Clip Remover 31008 – Mini Upholstery Clip Remover 31009 – Mini Upholstery Clip Remover | 0 45256 31000 8 | N/A | N/A | Square | N/A | N/A | 1.12 | Bulk |



Upholstery Clip Remover

- Used to remove upholstery clips
- Acetate handle for a more secure grip
- Made in the USA

| Item | Description | UPC Code | OAL | Body Size | Body Type | Blade Width | Blade Style | Weight (Lbs) | Pkg. Type |
|-------|------------------------------|-----------------|--------|-----------|-----------|-------------|-------------|--------------|-----------|
| 31001 | Upholstery Clip Remover | 0 45256 31001 5 | 9-9/16 | 5/16 | Square | 7/8 | N/A | 0.96 | Bulk |
| 31002 | Upholstery Clip Remover | 0 45256 31002 2 | 9-9/16 | 5/16 | Square | 1 | N/A | 0.96 | Bulk |
| 31008 | Mini Upholstery Clip Remover | 0 45256 31008 4 | 9-3/8 | 3/16 | Round | 1/24 | N/A | 0.65 | Bulk |
| 31009 | Mini Upholstery Clip Remover | 0 45256 31009 1 | 9-3/8 | 3/16 | Round | 1/24 | N/A | 0.65 | Bulk |

Hose Clamp Pliers

- Used to loosen and remove a wide variety of automotive hose clamps

| Item | Description | UPC Code | OAL | Weight (Lbs) | Pkg. Type |
|-------|-----------------------------------------------------------------------------------------------------------------------|-----------------|--------|--------------|-------------|
| 28690 | Rigiflex™ Hose Clamp Pliers | 0 45256 28690 7 | 15-1/8 | 1.72 | Box |
| 28691 | Rigiflex™ Replacement Kit | 0 45256 28691 4 | 17-1/2 | 1.72 | Plastic Bag |
| 28680 | Professional Hose Clamp Pliers | 0 45256 28680 8 | 14-1/2 | 1.02 | Bulk |
| 28682 | Replacement Cable | 0 45256 28682 2 | N/A | 0.07 | Plastic Bag |
| 45680 | Hose Clamp Pliers | 0 45256 45680 5 | N/A | 0.25 | Plastic Bag |
| 28657 | Hose Clamp Pliers, Easy Access | 0 45256 28657 0 | 14-1/2 | 0.88 | Clamshell |
| 28658 | Replacement Jaws for Easy-Access Hose Clamp Pliers | 0 45256 28658 7 | N/A | 0.04 | Plastic Bag |
| 28665 | Clic Hose Clamp Pliers | 0 45256 28665 5 | 7 | 0.50 | Clamshell |
| 28655 | Hose Clamp Pliers, 2 Pc Set 28650 – Cable Op/Ratcheting Hose Clamp Pliers 28657 – Hose Clamp Plier, Easy Access | 0 45256 28655 1 | N/A | 0.04 | Bulk |



Made in France *Exclusive USA Distributor



- Patent Pending
- Used to remove and mount inner tie rods on vehicles
- Fits 35-45mm tie rods with no additional interchangeable adapters
- For use on round, hexagonal, and octagonal tie rods
- Extended shaft and narrow profile allows for use in hard-to-reach and confined spaces
- Made in France

Tie Rod Tools

| Item | Description | UPC Code | OAL | Body Size | Body Type | Blade Width | Blade Style | Weight (Lbs) | Pkg. Type |
|-------|------------------------------|-----------------|--------|-----------|-----------|-------------|-------------|--------------|-----------|
| 29910 | Universal Inner Tie Rod Tool | 0 45256 29910 5 | 16-1/2 | N/A | Round | N/A | N/A | 4.4 | Bulk |
| 29915 | 35-45mm Speedy Roller Cage | 0 45256 29915 0 | 2 | N/A | Round | N/A | N/A | 0.25 | Box |
| 29916 | 28-38mm Speedy Roller Cage | 0 45256 29916 7 | 2 | N/A | Round | N/A | N/A | 0.19 | Box |

Dominator
Pry Bars
Scrapers
Chisels
Punches
Steel Sets/
Kits
Specialty &
Extractors
Retail
Displays
Brass Sets/
Kits
150
Hard Cap
Hollow Punch
Sets
Automotive/
Specialty
Pneumatic
42

Professional Hose Clamp Pliers with Flexible Cable

28690 - Rigiflex Pliers

Replaces 28630

*Flexes and holds to
any desired position*



**Multi-stop
Jaw-Piece
Lock**



**Easy to
replace cable**



28680 - Hose Clamp Pliers

Replaces 28650

- Unique Jaw design fits clamps up to 2" (51mm)
- Extra-heavy duty 5/64" (2mm) cable
- Bi-material grips with snap feature
- Easy to replace cable



45680 - Hose Clamp Pliers

Replaces 45650

*If you want to replace this, please ask for repair kit
with complete instructions: 28682*



Mayhew Steel Products, Inc.
199 Industrial Blvd.
Turners Falls, MA 01376

U.S. Toll-Free Customer Service: 800-872-0037
Visit us online at www.Mayhew.com
Always wear safety goggles when using hand tools.

Version 2.2016
For the latest version, visit us
online at www.Mayhew.com







The Pros Know

| |
|---------------------------|
| Dominator |
| Pry Bars |
| Scrapers |
| Chisels |
| Punches |
| Steel Sets/ Kits |
| Specialty & Extractors |
| Retail Displays |
| Brass Sets/ Kits |
| 150 |
| Hard Cap |
| Hollow Punch Sets |
| Automotive/ Specialty |
| Pneumatic |
| 43 |

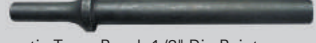

Pneumatic Punches, Chisels, & Hammers

- Used with a pneumatic tool
- Available in standard and heavy-duty shank sizes, in multiple sizes, and points
- Black oxide finish for additional rust protection
- Made in the USA

| Item | Description | UPC Code | OAL | Body Size | Body Type | Blade Width | Blade Style | Weight (Lbs) | Pkg. Type |
|-------|--------------------------------------------------------------------------------------------------------------------------|-----------------|-------|-----------|-----------|-------------|-------------|--------------|-----------|
| 31970 |  2" Pneumatic Chisel | 0 45256 31970 4 | 8-1/2 | 0.401 | Round | 2 | N/A | 0.50 | Bulk |
| 81970 | 2" Pneumatic Chisel Carded | 0 45256 81970 9 | 8-1/2 | 0.401 | Round | 2 | N/A | 0.50 | Carded |
| 31972 |  6" Pneumatic Cold Chisel | 0 45256 31972 8 | 6 | 0.401 | Round | 5/8 | N/A | 0.38 | Bulk |
| 31989 | 6" Pneumatic Cold Chisel .498 | 0 45256 31989 6 | 6 | 0.498 | Round | 3/16 | N/A | 0.57 | Bulk |
| 31973 | 8" Pneumatic Cold Chisel | 0 45256 31973 5 | 8 | 0.401 | Round | 5/8 | N/A | 0.43 | Bulk |
| 81989 | 6" Pneumatic Cold Chisel, .498, Carded | 0 45256 81989 1 | 6 | 0.498 | Round | 3/16 | N/A | 0.57 | Carded |
| 31974 | 10" Pneumatic Cold Chisel | 0 45256 31974 2 | 10 | 0.401 | Round | 5/8 | N/A | 0.53 | Bulk |
| 31986 | 18" Pneumatic Cold Chisel | 0 45256 31986 5 | 18 | 0.401 | Round | 5/8 | N/A | 0.95 | Bulk |
| 81972 | 6" Pneumatic Cold Chisel, Carded | 0 45256 81972 3 | 6 | 0.401 | Round | 5/8 | N/A | 0.38 | Carded |
| 81973 | 8" Pneumatic Cold Chisel, Carded | 0 45256 81973 0 | 8 | 0.401 | Round | 5/8 | N/A | 0.43 | Carded |
| 81974 | 10" Pneumatic Cold Chisel Carded | 0 45256 81974 7 | 10 | 0.401 | Round | 5/8 | N/A | 0.53 | Carded |
| 81986 | 18" Pneumatic Cold Chisel, Carded | 0 45256 81986 0 | 18 | 0.401 | Round | 5/8 | N/A | 0.95 | Carded |
| 31977 |  6" Pneumatic Taper Punch Sharp Point | 0 45256 31977 3 | 6-1/4 | 0.401 | Round | 0 | N/A | 0.31 | Bulk |
| 31978 | 18" Pneumatic Taper Punch Sharp Point | 0 45256 31978 0 | 18 | 0.401 | Round | 0 | N/A | 0.94 | Bulk |
| 31979 |  Pneumatic Taper Punch 3/8" Dia Point | 0 45256 31979 7 | 6 | 0.401 | Round | 3/8 | N/A | 0.32 | Bulk |
| 31980 |  Pneumatic Taper Punch 1/2" Dia Point | 0 45256 31980 3 | 6 | 0.401 | Round | 1/2 | N/A | 0.32 | Bulk |
| 81977 | 6" Pneumatic Taper Punch Sharp Point, Carded | 0 45256 81977 8 | 6-1/4 | 0.401 | Round | 0 | N/A | 0.31 | Carded |
| 31999 | Pneumatic Taper Punch .498 | 0 45256 31999 5 | 7-1/2 | 0.498 | Round | 3/4 | N/A | 0.49 | Bulk |
| 32011 | 3/8"-18 Pneumatic Taper Punch | 0 45256 32011 3 | 18 | 0.401 | Round | 3/8 | N/A | 0.96 | Bulk |
| 32012 | 1/8"-18 Pneumatic Taper Punch | 0 45256 32012 0 | 18 | 0.401 | Round | 1/8 | N/A | 0.95 | Bulk |
| 31997 | Pneumatic Taper Punch | 0 45256 31997 1 | 6-1/2 | 0.401 | Round | 1/8 | N/A | 0.31 | Bulk |
| 81979 | 3/8 Dia Point Pneumatic Taper Punch, Carded | 0 45256 81979 2 | 6 | 0.401 | Round | 3/8 | N/A | 0.32 | Carded |
| 81980 | 1/2 Dia Point Pneumatic Taper Punch, Carded | 0 45256 81980 8 | 6 | 0.401 | Round | 1/2 | N/A | 0.32 | Carded |
| 81997 | Pneumatic Taper Punch, Carded | 0 45256 81997 6 | 6-1/2 | 0.401 | Round | 1/8 | N/A | 0.31 | Carded |
| 81999 | Pneumatic Taper Punch .498, Carded | 0 45256 81999 0 | 7-1/2 | 0.498 | Round | 3/4 | N/A | 0.49 | Carded |
| 82012 | 1/8 X 18 Pneumatic Taper Punch, Carded | 0 45256 82012 5 | 18 | 0.401 | Round | 1/8 | N/A | 0.95 | Carded |
| 31981 |  Pneumatic Hammer | 0 45256 31981 0 | 3.5 | 0.401 | Round | 1 | N/A | 0.28 | Bulk |
| 31982 | 4" Pneumatic Hammer | 0 45256 31982 7 | 4 | 0.401 | Round | 1 | N/A | 0.30 | Bulk |
| 31987 | 6" Pneumatic Hammer | 0 45256 31987 2 | 6 | 0.401 | Round | 1 | N/A | 0.41 | Bulk |
| 31994 | 1-1/4" Pneumatic Hammer Dia .498 | 0 45256 31994 0 | 4 | 0.498 | Round | 1-1/4 | N/A | 0.48 | Bulk |
| 32005 | 1-1/4" X 4" Pneumatic Extra-Wide Hammer | 0 45256 32005 2 | 4 | 0.401 | Round | 1-1/4 | N/A | 0.40 | Bulk |
| 81981 | 1 X 3.5" Pneumatic Hammer, Carded | 0 45256 81981 5 | 4 | 0.401 | Round | 1 | N/A | 0.28 | Carded |
| 81982 | 4" Pneumatic Hammer, Carded | 0 45256 81982 2 | 4 | 0.401 | Round | 1 | N/A | 0.30 | Carded |
| 81987 | 6" Pneumatic Hammer, Carded | 0 45256 81987 7 | 6 | 0.401 | Round | 1 | N/A | 0.41 | Carded |
| 81994 | 1-1/4" Dia Pneumatic Hammer 498, Carded | 0 45256 81994 5 | 4 | 0.498 | Round | 1-1/4 | N/A | 0.48 | Carded |
| 81975 | Pneumatic Rivet/Bolt Cutter, Carded | 0 45256 81975 4 | 6-1/4 | 0.401 | Round | 5/8 | N/A | 0.32 | Carded |

Pneumatic Retainer Chuck



| Item | Description | UPC Code | OAL | Body Size | Body Type | Blade Width | Blade Style | Weight (Lbs) | Pkg. Type |
|-------|--------------------------|-----------------|-----|-----------|-----------|-------------|-------------|--------------|-----------|
| 32053 | Pneumatic Retainer Chuck | 0 45256 32053 3 | 2 | N/A | N/A | N/A | N/A | 0.15 | Bulk |



Pneumatic Scrapers











- Used with a pneumatic tool on applications such as gaskets, rust, paint, and surface retouching
- Available in a wide range of sizes and shapes for the perfect tool for the job
- Black oxide finish for additional rust protection
- Made in the USA

| Item | Description | UPC Code | OAL | Body Size | Body Type | Blade Width | Blade Style | Weight (Lbs) | Pkg. Type |
|-------|--------------------------------|-----------------|-----|-----------|-----------|-------------|-------------|--------------|-----------|
| 31976 | Pneumatic Scraper | 0 45256 31976 6 | 8 | 0.401 | Round | 1-1/8 | N/A | 0.42 | Bulk |
| 32010 | Pneumatic Scraper 1 1/8" - 18" | 0 45256 32010 6 | 18 | 0.401 | Round | 1-1/8 | N/A | 0.94 | Bulk |
| 81976 | Pneumatic Scraper | 0 45256 81976 1 | 8 | 0.401 | Round | 1-1/8 | N/A | 0.42 | Carded |
| 82010 | Pneumatic Scraper 1-1/8" X 18" | 0 45256 82010 1 | 18 | 0.401 | Round | 1-1/8 | N/A | 0.94 | Carded |



Automotive









- Used for body, chassis, and exhaust applications
- Available in standard .401 shank sizes and many different styles for any application
- Black oxide finish for additional rust protection
- Made in the USA

| Item | Description | UPC Code | OAL | Body Size | Body Type | Blade Width | Blade Style | Weight (Lbs) | Pkg. Type |
|-------|------------------------------------------------------------------------------------------------------------------------|-----------------|-------|-----------|-----------|-------------|-------------|--------------|-----------|
| 31955 |  Pneumatic Body Ripper | 0 45256 31955 1 | 6 | 0.401 | Round | 5/8 | N/A | 0.32 | Bulk |
| 31956 |  Pneumatic Double-Cut Body Ripper | 0 45256 31956 8 | 6 | 0.401 | Round | 7/8 | N/A | 0.31 | Bulk |
| 31957 |  Pneumatic Panel Cutter | 0 45256 31957 5 | 6 | 0.401 | Round | 3/4 | N/A | 0.31 | Bulk |
| 31958 |  Pneumatic Slotted Panel Cutter | 0 45256 31958 2 | 6 | 0.401 | Round | 3/4 | N/A | 0.3 | Bulk |
| 31959 |  Pneumatic Sheet Metal Trimmer | 0 45256 31959 9 | 6 | 0.401 | Round | 3/4 | N/A | 0.3 | Bulk |
| 31960 |  Pneumatic Spot Weld Breaker | 0 45256 31960 5 | 6 | 0.401 | Round | 3/4 | N/A | 0.31 | Bulk |
| 31961 |  Pneumatic Radius Cutter | 0 45256 31961 2 | 6-1/2 | 0.401 | Round | 21/32 | N/A | 0.31 | Bulk |
| 31965 |  Pneumatic Muffler/Tailpipe Remover | 0 45256 31965 0 | 8-1/4 | 0.401 | Round | 5/8 | N/A | 0.39 | Bulk |
| 31966 |  Pneumatic Inside Muffler Cutter | 0 45256 31966 7 | 8-1/4 | 0.401 | Round | 3/16 | N/A | 0.42 | Bulk |
| 31967 |  Pneumatic Outside Muffler Cutter | 0 45256 31967 4 | 8-1/4 | 0.401 | Round | 3/16 | N/A | 0.43 | Bulk |
| 31968 |  Pneumatic Tailpipe Cutoff | 0 45256 31968 1 | 7-1/2 | 0.401 | Round | 1-25/64 | N/A | 0.4 | Bulk |



Automotive

- Used for body, chassis, and exhaust applications
- Available in standard .401 shank sizes and many different styles for any application
- Black oxide finish for additional rust protection
- Made in the USA

| Item | Description | UPC Code | OAL | Body Size | Body Type | Blade Width | Blade Style | Weight (Lbs) | Pkg. Type |
|-------|----------------------------------------------------------------------------------------------------------------------------|-----------------|-------|-----------|-----------|-------------|-------------|--------------|-----------|
| 31971 |  Pneumatic Splitting Tool | 0 45256 31971 1 | 8-1/4 | 0.401 | Round | 5/8 | N/A | 0.36 | Bulk |
| 31975 |  Pneumatic Rivet/Bolt Cutter | 0 45256 31975 9 | 6-1/4 | 0.401 | Round | 5/8 | N/A | 0.32 | Bulk |
| 31985 | Pneumatic 18" Nut Splitting Tool | 0 45256 31985 8 | 18 | 0.401 | Round | 3/4 | N/A | 0.94 | Bulk |
| 31988 | Pneumatic Retainer Spring | 0 45256 31988 9 | 2 | 0.401 | N/A | 0 | N/A | 0.12 | Bulk |
| 31991 |  Pneumatic Control Arm Bushing Remover | 0 45256 31991 9 | 6 | 0.401 | Round | 1-5/16 | N/A | 0.31 | Bulk |
| 31992 |  Pneumatic Rivet/Bolt Cutter .498 | 0 45256 31992 6 | 7-1/2 | 0.498 | Round | 3/4 | N/A | 0.57 | Bulk |
| 31993 |  Pneumatic Tie Rod Sleeve Breaker | 0 45256 31993 3 | 4 | 0.401 | Round | 1 | N/A | 0.29 | Bulk |
| 31995 | Pneumatic Tie Rod Separator | 0 45256 31995 7 | 7-1/2 | 0.401 | Round | 1-9/16 | N/A | 0.67 | Bulk |
| 31996 |  Pneumatic Ball Joint Separator | 0 45256 31996 4 | 7-1/2 | 0.401 | Round | 1-13/16 | N/A | 0.72 | Bulk |
| 32006 |  Pneumatic Valve Guide Remover/Installer | 0 45256 32006 9 | 6 | 0.401 | Round | 5/16 | N/A | 0.28 | Bulk |
| 81955 | Pneumatic Body Ripper, Carded | 0 45256 81955 6 | 6 | 0.401 | Round | 11/16 | N/A | 0.32 | Carded |
| 81956 | Pneumatic Double-Cut Body Ripper | 0 45256 81956 3 | 6 | 0.401 | Round | 7/8 | N/A | 0.31 | Carded |
| 81957 | Pneumatic Panel Cutter | 0 45256 81957 0 | 6 | 0.401 | Round | 3/4 | N/A | 0.31 | Carded |
| 81958 | Pneumatic Slotted Panel Cutter | 0 45256 81958 7 | 6 | 0.401 | Round | 3/4 | N/A | 0.3 | Carded |
| 81959 | Pneumatic Sheet Metal Cutter | 0 45256 81959 4 | 6 | 0.401 | Round | 3/4 | N/A | 0.3 | Carded |
| 81960 | Pneumatic Spot Weld Breaker | 0 45256 81960 0 | 6 | 0.401 | Round | 3/4 | N/A | 0.31 | Carded |
| 81961 |  Pneumatic Radius Cutter | 0 45256 81961 7 | 6-1/2 | 0.401 | Round | 21/32 | N/A | 0.31 | Carded |
| 81968 | Pneumatic Tailpipe Cutoff | 0 45256 81968 6 | 7-1/2 | 0.401 | Round | 1-25/64 | N/A | 0.4 | Carded |
| 81992 | Pneumatic Rivet/Bolt Cutter .498 | 0 45256 81992 1 | 7-1/2 | 0.498 | Round | 3/4 | N/A | 0.57 | Carded |
| 81993 | Pneumatic Tie Rod Sleeve Breaker | 0 45256 81993 8 | 4 | 0.401 | Round | 1 | N/A | 0.29 | Carded |
| 81996 | Pneumatic Ball Joint Separator | 0 45256 81996 9 | 7-1/2 | 0.401 | Round | 1-13/16 | N/A | 0.72 | Carded |
| 82006 | Pneumatic Valve Guide Remover/Installer | 0 45256 82006 4 | 6 | 0.401 | Round | 5/16 | N/A | 0.28 | Carded |



Shake 'n Break

- Attaches to air hammer to provide vibration while removing stubborn/frozen fasteners or torx bolts/nuts
- Other end of each Shake 'n Break has either a 1/2" or 3/8" square drive to be used with impact sockets
- Built-in hex (19mm-3/4") on shaft of tool to be used in conjunction with open-end wrench when loosening stubborn fastener
- Applications include bearing removal and GM caliper removal
- Made in the USA

| Item | Description | UPC Code | OAL | Body Size | Body Type | Blade Width | Blade Style | Weight (Lbs) | Pkg. Type |
|-------|---------------------------------------|----------------|-----|-----------|-----------|-------------|-------------|--------------|-----------|
| 37315 | 3/8" Shake 'n Break Torx Bolt Breaker | 0 4525637315 7 | 5 | 0.401 | Round | N/A | N/A | 0.32 | Bulk |
| 37316 | 1/2" Shake 'n Break Torx Bolt Breaker | 0 4525637316 4 | 5 | 0.401 | Round | N/A | N/A | 0.35 | Bulk |

Dominator
Pry Bars
Scrapers
Chisels
Punches
Steel Sets/
Kits
Specialty &
Extractors
Retail
Displays
Brass Sets/
Kits
150
Hard Cap
Hollow Punch
Sets
Automotive/
Specialty
Pneumatic
46



37323 – 3 Pc Long Pneumatic Tool Set



37322 – 9 Pc Pneumatic Tool Set



37394 – 18 Pc Pneumatic Display Block

Pneumatic Sets

| Item | Description | UPC Code | OAL | Body Size | Body Type | Blade Width | Blade Style | Weight (Lbs) | Pkg. Type |
|-------|---------------------------------------------------------------------------------------------------------------------------------------------------------------------------------------------------------------------------------------------------------------------------------------------------------------------------------------------------------------------------------------------------------------------------------------------------------------------------------------------------------------------------------------------------------------------------------------------------------------------------------------------------------------------------------------------------------------------------------------------------------------------------|-----------------|-----|-----------|-----------|-------------|-------------|--------------|--------------|
| 37320 | 4 Pc Basic Pneumatic Set 31965 – Pneumatic Muffler/Tailpipe Remover 31971 – Pneumatic Splitting Tool 31972 – Pneumatic Cold Chisel 6" 31975 – Pneumatic Rivet/Bolt Cutter | 0 45256 37320 1 | N/A | N/A | N/A | N/A | N/A | 1.48 | Pouch |
| 37322 | 9 Pc Pneumatic Tool Set 31955 – Pneumatic Body Ripper 31957 – Pneumatic Panel Cutter 31958 – Pneumatic Slotted Panel Cutter 31959 – Pneumatic Sheet Metal Trimmer 31965 – Pneumatic Muffler/Tailpipe Remover 31971 – Pneumatic Splitting Tool 31972 – Pneumatic Cold Chisel 6" 31975 – Pneumatic Rivet/Bolt Cutter 31997 – Pneumatic Taper Punch | 0 45256 37322 5 | N/A | N/A | N/A | N/A | N/A | 3.08 | Pouch |
| 37323 | 3 Pc Long Pneumatic Tool Set 32010 – Pneumatic Scraper 1 1/8"-18" 32011 – Pneumatic Taper Punch 3/8"-18" 32012 – Pneumatic Taper Punch 1/8"-18" | 0 45256 37323 2 | N/A | N/A | N/A | N/A | N/A | 3.16 | Bulk |
| 37394 | 18 Pc Pneumatic Display Block 31956 – Pneumatic Double-Cut Body Ripper 31958 – Pneumatic Slotted Panel Cutter 31959 – Pneumatic Sheet Metal Trimmer 31960 – Pneumatic Spot Weld Breaker 31965 – Pneumatic Muffler/Tailpipe Remover 31968 – Pneumatic Tailpipe Cutoff 31972 – Pneumatic Cold Chisel 6" 31973 – Pneumatic Cold Chisel 8" 31974 – Pneumatic Cold Chisel 10" 31975 – Pneumatic Rivet/Bolt Cutter 31976 – Pneumatic Scraper 31977 – Pneumatic 6in Taper Punch Sharp Point 31979 – Pneumatic Taper Punch 3/8" Dia Point 31980 – Pneumatic Taper Punch 1/2" Dia Point 31982 – Pneumatic 4" Hammer 31995 – Pneumatic Tie Rod Separator 31996 – Pneumatic Ball Joint Separator 31997 – Pneumatic Taper Punch | 0 45256 37394 2 | N/A | N/A | N/A | N/A | N/A | 8.05 | Plastic Case |



Long Pneumatic Scrapers & Hammers

| Item | Description | UPC Code | OAL | Body Size | Body Type | Blade Width | Blade Style | Weight (Lbs) | Pkg. Type |
|-------|--------------------------|-----------------|-----|-----------|-----------|-------------|-------------|--------------|-----------|
| 32001 | 12" Pneumatic Hammer | 0 45256 32001 4 | 12 | 0.401 | Round | N/A | N/A | 0.76 | Bulk |
| 32002 | 18" Pneumatic Hammer | 0 45256 32002 1 | 18 | 0.401 | Round | N/A | N/A | 1.08 | Bulk |
| 32003 | 24" Pneumatic Hammer | 0 45256 32003 8 | 24 | 0.401 | Round | N/A | N/A | 1.40 | Bulk |
| 32016 | 2"x18" Pneumatic Scraper | 0 45256 32016 8 | 18 | 0.401 | Round | 3/4 | N/A | 1.00 | Bulk |
| 32017 | 2"x18" Pneumatic Scraper | 0 45256 32017 5 | 24 | 0.401 | Round | 2 | N/A | 1.82 | Bulk |



Mayhew Steel Products, Inc.
199 Industrial Blvd.
Turners Falls, MA 01376

U.S. Toll-Free Customer Service: 800-872-0037
Visit us online at www.Mayhew.com
Always wear safety goggles when using hand tools.

Version 2.2016
For the latest version, visit us
online at www.Mayhew.com

The Pros Know

Dominator
 Pry Bars
 Scrapers
 Chisels
 Punches
 Steel Sets/
 Kits
 Specialty &
 Extractors
 Retail
 Displays
 Brass Sets/
 Kits
 150
 Hard Cap
 Hollow Punch
 Sets
 Automotive/
 Specialty
 Pneumatic
 47

From the Seasoned Pros to the Regular Joes

Just because it's not what you do for a living doesn't mean you don't want professional quality tools. From the car enthusiasts who take repair as seriously as the professional to the home improvement folks with a new deck under way, the MayhewSelect series offers high-quality tools that allow you to perform mechanical and tradesman-specific work as well as the men and women who do it for a living. Backed by the same experience and insights that have made Mayhew the professionals' choice for more than 150 years, as well as a two-year quality warranty on every tool, MayhewSelect turns weekend projects into weekend passions.



MAYHEW SELECT™

Since 1856

Know What The Pros Know



Brick & Mason Chisels

- Used in a multitude of masonry applications, from brick to stone to concrete
- Allows for specific cuts, sizes, and scores. Different cutting-edge lengths provide the perfect sized tool for the perfect finished look
- Shot-blasted finish
- Made in the USA

| Item | Description | UPC Code | OAL | Body Size | Body Type | Blade Width | Blade Style | Weight (Lbs) | Pkg. Type |
|-------|----------------------------------|-----------------|-------|-----------|-----------|-------------|-------------|--------------|-----------|
| 12300 | 3" Mason Chisel | 0 45256 12300 4 | 7-1/2 | 7/8 | Hex | 3 | N/A | 1.32 | Bulk |
| 12301 | 3-1/2" Mason Chisel | 0 45256 12301 1 | 7-1/2 | 1 | Hex | 3-1/2 | N/A | 1.70 | Bulk |
| 12302 | 4" Mason Chisel | 0 45256 12302 8 | 7-1/2 | 1 | Hex | 4 | N/A | 1.66 | Bulk |
| 30210 | 12" Mason Chisel | 0 45256 30210 2 | 12 | 3/8 | Square | 1-1/8 | N/A | 0.66 | Bulk |
| 34502 | 1-1/8" X 12" Flat Utility Chisel | 0 81243 34502 8 | 12 | 3/8 | Hex | 1-1/8 | N/A | 1.23 | Carded |
| 35002 | 3" X 7" Mason Chisel, Carded | 0 81243 35002 2 | 7 | 7/8 | Hex | 3 | N/A | 1.32 | Carded |
| 35102 | 3-1/2" X 7-1/4" Mason Chisel | 0 81243 35102 9 | 7-1/4 | 7/8 | Hex | 3-1/2 | N/A | 1.70 | Carded |
| 35202 | 4" X 7" Mason Chisel | 0 81243 35202 6 | 7 | 7/8 | Hex | 4 | N/A | 1.66 | Carded |
| 30211 | 18" Mason Chisel | 0 45256 30211 9 | 18 | 3/8 | Square | 1-1/8 | N/A | 1.51 | Bulk |
| 30200 | 1-3/4" Mason Chisel | 0 45256 30200 3 | 7-1/2 | 1/2 | Hex | 1-3/4 | N/A | 0.66 | Bulk |
| 30202 | 2-1/4" Mason Chisel | 0 45256 30202 7 | 7-1/2 | 5/8 | Hex | 2-1/4 | N/A | 0.70 | Bulk |
| 35602 | 1-3/4" X 7-1/2" Mason Chisel | 0 81243 35602 4 | 7-1/2 | 3/4 | Hex | 1-3/4 | N/A | 0.66 | Carded |
| 35702 | 2-1/4" X 7-3/4" Mason Chisel | 0 81243 35702 1 | 7-3/4 | 7/8 | Hex | 2-1/4 | N/A | 0.70 | Carded |
| 35802 | 2-3/4" X 7-1/2" Mason Chisel | 0 81243 35802 8 | 7-1/2 | 7/8 | Hex | 2-3/4 | N/A | 1.33 | Carded |



Bull Point Chisel

- Used to break up and demolish concrete
- Used where an air chisel is impractical
- Shot-blasted finish
- Made in the USA

| Item | Description | UPC Code | OAL | Body Size | Body Type | Blade Width | Blade Style | Weight (Lbs) | Pkg. Type |
|-------|---------------------------|-----------------|-----|-----------|-----------|-------------|-------------|--------------|-----------|
| 30100 | 3/4" X 12" Reg Bull Point | 0 45256 30100 6 | 12 | 3/4 | Hex | 5/16 | N/A | 1.55 | Bulk |



Clapboard Chisel

- Used to remove siding for access to wall cavities and trimming wood; also used to pull tongue and groove materials together
- Extra-long handle allows better leverage when cutting and trimming wood
- Shot-blasted finish
- Made in the USA

| Item | Description | UPC Code | OAL | Body Size | Body Type | Blade Width | Blade Style | Weight (Lbs) | Pkg. Type |
|-------|-----------------------------|-----------------|-----|-----------|-----------|-------------|-------------|--------------|-----------|
| 12312 | 18" Clapboard Chisel 2" Cut | 0 45256 12312 7 | 18 | 5/8 | Hex | 2 | N/A | 1.30 | Bulk |



Floor Chisel

- Used to cut and trim wood and to pull tongue and groove materials together
- Thin blade allows for access to tight spaces
- Shot-blasted finish
- Made in the USA

| Item | Description | UPC Code | OAL | Body Size | Body Type | Blade Width | Blade Style | Weight (Lbs) | Pkg. Type |
|-------|-------------------------------|-----------------|--------|-----------|-----------|-------------|-------------|--------------|-----------|
| 12310 | 2-1/2" Floor Chisel | 0 45256 12310 3 | 10-1/2 | 5/8 | Hex | 2-1/2 | N/A | 0.92 | Bulk |
| 12311 | 3" Floor Chisel | 0 45256 12311 0 | 11 | 3/4 | Hex | 3 | N/A | 1.38 | Bulk |
| 94202 | 3" X 12" Floor Chisel, Carded | 0 81243 94202 9 | 12 | 3/4 | Hex | 3 | N/A | 1.38 | Carded |



Mayhew Steel Products, Inc.
199 Industrial Blvd.
Turners Falls, MA 01376

U.S. Toll-Free Customer Service: 800-872-0037
Visit us online at www.Mayhew.com
Always wear safety goggles when using hand tools.

Version 2.2016
For the latest version, visit us
online at www.Mayhew.com

The Pros Know

Chisels

Punches

Pry Bars

Handguarded

Specialty

Inspection

Sets and Kits



Cold Chisels

- Used to cut and shape metals softer than the cutting edge of the chisel
- Cutting edge angle designed to provide greater strength
- Not intended to be used on masonry materials
- Available in a variety of lengths and sizes to fit any application
- Shot-blasted finish
- Made in the USA

| Item | Description | UPC Code | OAL | Body Size | Body Type | Blade Width | Blade Style | Weight (Lbs) | Pkg. Type |
|-------|-------------------------------|-----------------|-------|-----------|-----------|-------------|-------------|--------------|-----------|
| 10102 | 1/4" X 4-1/2" Cold Chisel | 0 81243 10102 0 | 4-1/2 | 1/4 | Hex | 1/4 | N/A | 0.07 | Carded |
| 10202 | 5/16" X 5" Cold Chisel | 0 81243 10202 7 | 4-3/4 | 1/4 | Hex | 5/16 | N/A | 0.07 | Carded |
| 10302 | 3/8" X 5" Cold Chisel | 0 81243 10302 4 | 5 | 5/16 | Hex | 3/8 | N/A | 0.12 | Carded |
| 10402 | 1/2" X 6" Cold Chisel | 0 81243 10402 1 | 6 | 3/8 | Hex | 1/2 | N/A | 0.19 | Carded |
| 10502 | 5/8" X 6-1/2" Cold Chisel | 0 81243 10502 8 | 6-1/2 | 7/16 | Hex | 5/8 | N/A | 0.30 | Carded |
| 10602 | 3/4" X 7" Cold Chisel | 0 81243 10602 5 | 7 | 5/8 | Hex | 3/4 | N/A | 0.41 | Carded |
| 10702 | 7/8" X 7-1/2" Cold Chisel | 0 81243 10702 2 | 7-1/2 | 5/8 | Hex | 7/8 | N/A | 0.67 | Carded |
| 10802 | 1" X 8" Cold Chisel | 0 81243 10802 9 | 8 | 3/4 | Hex | 1 | N/A | 1.00 | Carded |
| 12002 | 1/2" X 12" Cold Chisel | 0 81243 12002 1 | 12 | 7/16 | Hex | 1/2 | N/A | 0.55 | Carded |
| 12102 | 5/8" X 12" Cold Chisel | 0 81243 12102 8 | 12 | 1/2 | Hex | 5/8 | N/A | 0.54 | Carded |
| 12202 | 3/4" X 12" Cold Chisel | 0 81243 12202 5 | 12 | 5/8 | Hex | 3/4 | N/A | 0.69 | Carded |
| 12402 | 1" X 12" Cold Chisel | 0 81243 12402 9 | 12 | 3/4 | Hex | 1 | N/A | 1.54 | Carded |
| 70200 | 1/4" Reg Ec Cold Chisel | 0 45256 70200 1 | 5 | 1/4 | Hex | 1/4 | N/A | 0.07 | Bulk |
| 70201 | 5/16" Reg Ec Cold Chisel | 0 45256 70201 8 | 5 | 1/4 | Hex | 5/16 | N/A | 0.07 | Bulk |
| 70202 | 3/8" Reg Ec Cold Chisel | 0 45256 70202 5 | 5-1/2 | 5/16 | Hex | 3/8 | N/A | 0.13 | Bulk |
| 70204 | 7/16" Reg Ec Cold Chisel | 0 45256 70204 9 | 6 | 3/8 | Hex | 7/16 | N/A | 0.20 | Bulk |
| 70205 | 1/2" Reg Ec Cold Chisel | 0 45256 70205 6 | 6 | 7/16 | Hex | 1/2 | N/A | 0.25 | Bulk |
| 70207 | 1/2" X 12" Reg Ec Cold Chisel | 0 45256 70207 0 | 12 | 7/16 | Hex | 1/2 | Extra Long | 0.53 | Bulk |
| 70209 | 5/8" Reg Ec Cold Chisel | 0 45256 70209 4 | 6-1/2 | 1/2 | Hex | 5/8 | N/A | 0.37 | Bulk |
| 70210 | 5/8" X 12" Reg Ec Cold Chisel | 0 45256 70210 0 | 12 | 1/2 | Hex | 5/8 | Extra Long | 0.69 | Bulk |
| 70212 | 3/4" Reg Ec Cold Chisel | 0 45256 70212 4 | 7 | 5/8 | Hex | 3/4 | N/A | 0.60 | Bulk |
| 70213 | 3/4" X 12" Reg Ec Cold Chisel | 0 45256 70213 1 | 12 | 5/8 | Hex | 3/4 | Extra Long | 1.09 | Bulk |
| 70216 | 7/8" Reg Ec Cold Chisel | 0 45256 70216 2 | 7-1/2 | 3/4 | Hex | 7/8 | N/A | 0.90 | Bulk |
| 70217 | 7/8" X 12" Ec Cold Chisel | 0 45256 70217 9 | 12 | 3/4 | Hex | 7/8 | Extra Long | 1.51 | Bulk |
| 70219 | 7/8" X 18" Ec Cold Chisel | 0 45256 70219 3 | 18 | 3/4 | Hex | 7/8 | Extra Long | 2.40 | Bulk |
| 70220 | 1" Reg Ec Cold Chisel | 0 45256 70220 9 | 8 | 7/8 | Hex | 1 | N/A | 1.25 | Bulk |
| 70221 | 1" X 12" Reg Ec Cold Chisel | 0 45256 70221 6 | 12 | 3/4 | Hex | 1 | Extra Long | 1.53 | Bulk |



35102 – 3-1/2" X 7-1/4" Mason Chisel (p.11.0)



35602 – 1-3/4" X 7-1/2" Mason Chisel (p.11.0)



10402 – 1/2" X 6" Cold Chisel (above)



12402 – 1" X 12" Cold Chisel (above)



41602 – 3/8" Center Punch, 3/16" Pt (p.12.0)



43902 – 1/8" X 8" Line-Up Punch, Carded (p.12.1)

Chisels

Punches

Pry Bars

Handguarded

Specialty

Inspection

Sets and Kits



Center Punches

- Used for piercing, or marking for starting drills in metal and other materials
- Point sizes vary for larger or smaller holes
- If you want to scribe lines in metal, consider a prick punch
- Available in a shot-blasted finish
- Made in the USA

| Item | Description | UPC Code | OAL | Body Size | Body Type | Blade Width | Blade Style | Weight (Lbs) | Pkg. Type |
|-------|------------------------------|-----------------|-------|-----------|-----------|-------------|-------------|--------------|-----------|
| 41202 | 5/16" Center Punch, 5/32" Pt | 0 81243 41202 7 | 4-1/2 | 5/16 | Hex | 5/16 | N/A | 0.09 | Carded |
| 41602 | 3/8" Center Punch, 3/16" Pt | 0 81243 41602 5 | 5 | 3/8 | Hex | 3/8 | N/A | 0.15 | Carded |
| 74000 | 1/4" Reg Ec Center Punch | 0 45256 74000 3 | 4 | 1/4 | Hex | 3/32 | N/A | 0.04 | Bulk |
| 74001 | 5/16" Reg Ec Center Punch | 0 45256 74001 0 | 4-1/2 | 5/16 | Hex | 5/32 | N/A | 0.09 | Bulk |
| 74002 | 3/8" Reg Ec Center Punch | 0 45256 74002 7 | 5 | 3/8 | Hex | 3/8 | N/A | 0.15 | Bulk |
| 74003 | 1/2" Reg Ec Center Punch | 0 45256 74003 4 | 6 | 1/2 | Hex | 5/16 | N/A | 0.34 | Bulk |
| 74004 | 5/8" Reg Ec Center Punch | 0 45256 74004 1 | 6-1/4 | 5/8 | Hex | 3/8 | N/A | 0.50 | Bulk |
| 41702 | 1/2" Center Punch, 5/16 Pt | 0 81243 41702 2 | 6 | 1/2 | Hex | 5/16 | N/A | 0.34 | Carded |



Solid Punches

- For loosening frozen or tight pins and keys, or knocking out rivets
- Variable point sizes for different sized pins and keys
- Once loosened, follow up with a pin punch to drive the pin or key out
- Available in a shot-blasted finish
- Made in the USA

| Item | Description | UPC Code | OAL | Body Size | Body Type | Blade Width | Blade Style | Weight (Lbs) | Pkg. Type |
|-------|-------------------------------|-----------------|-----|-----------|-----------|-------------|-------------|--------------|-----------|
| 70001 | 1/8" Reg Ec Solid Punch | 0 45256 70001 4 | 5 | 3/8 | Hex | 1/8 | N/A | 0.15 | Bulk |
| 70002 | 3/16" Reg Ec Solid Punch | 0 45256 70002 1 | 5 | 3/8 | Hex | 3/16 | N/A | 0.15 | Bulk |
| 20500 | 1/16" Reg Knurled Solid Punch | 0 45256 20500 7 | 4 | 5/16 | Round | 1/16 | N/A | 0.07 | Bulk |
| 20501 | 3/32" Reg Knurled Solid Punch | 0 45256 20501 4 | 4 | 5/16 | Round | 3/32 | N/A | 0.07 | Bulk |
| 20502 | 1/8" Reg Knurled Solid Punch | 0 45256 20502 1 | 4 | 5/16 | Round | 1/8 | N/A | 0.08 | Bulk |
| 20503 | 5/32" Reg Knurled Solid Punch | 0 45256 20503 8 | 4 | 5/16 | Round | 5/32 | N/A | 0.08 | Bulk |



Nail Set

- Used to drive finish nails into wood without damage, leaving a smooth finish
- Varying point sizes available for different sized nails
- Specialized application; not for use on any other metal besides nail heads
- Made in the USA

| Item | Description | UPC Code | OAL | Body Size | Body Type | Blade Width | Blade Style | Weight (Lbs) | Pkg. Type |
|-------|----------------|-----------------|-----|-----------|-----------|-------------|-------------|--------------|-----------|
| 26000 | 1/32" Nail Set | 0 45256 26000 6 | 4 | 1/4 | Hex | 1/32 | N/A | 0.07 | Bulk |
| 26001 | 2/32" Nail Set | 0 45256 26001 3 | 4 | 1/4 | Hex | 1/16 | N/A | 0.07 | Bulk |
| 26002 | 3/32" Nail Set | 0 45256 26002 0 | 4 | 1/4 | Hex | 3/32 | N/A | 0.08 | Bulk |



Prick Punch

- Used to scribe lines in metal before cutting or riveting
- Variable point sizes for different width marks
- Sharper angle specifically designed to scribe lines in metal
- Available in a shot-blasted finish
- Made in the USA

| Item | Description | UPC Code | OAL | Body Size | Body Type | Blade Width | Blade Style | Weight (Lbs) | Pkg. Type |
|-------|-------------------------------|-----------------|-----|-----------|-----------|-------------|-------------|--------------|-----------|
| 43502 | 7/32" X 5" Prick Punch | 0 81243 43502 6 | 5 | 5/16 | Hex | 7/32 | N/A | 0.11 | Carded |
| 73002 | 3/8" Reg Ec Prick Punch | 0 45256 73002 8 | 5 | 3/8 | Hex | 5/32 | N/A | 0.15 | Bulk |
| 23200 | 5/16" Reg Knurled Prick Punch | 0 45256 23200 3 | 4 | 5/16 | Round | 1/8 | N/A | 0.08 | Bulk |



Mayhew Steel Products, Inc.
199 Industrial Blvd.
Turners Falls, MA 01376

U.S. Toll-Free Customer Service: 800-872-0037
Visit us online at www.Mayhew.com
Always wear safety goggles when using hand tools.

Version 2.2016
For the latest version, visit us
online at www.Mayhew.com

The Pros Know

Chisels

Punches

Pry Bars

Handguarded

Specialty

Inspection

Sets and Kits



Pin Punches

- Used to drive out and remove already loosened pins and keys after initial movement by a solid punch
- Variable point sizes and lengths for different applications
- Not for use on seized pins/keys; loosen with a solid punch first
- Available in fractional and metric sizes
- Available in a shot-blasted finish
- Made in the USA

| Item | Description | UPC Code | OAL | Body Size | Body Type | Blade Width | Blade Style | Weight (Lbs) | Pkg. Type |
|-------|-----------------------------|-----------------|-------|-----------|-----------|-------------|-------------|--------------|-----------|
| 42102 | 1/8" X 4-1/2" Pin Punch | 0 81243 42102 9 | 4-1/2 | 1/4 | Hex | 1/8 | N/A | 0.09 | Carded |
| 42202 | 1/8" X 6" Long Pin Punch | 0 81243 42202 6 | 6 | 5/16 | Hex | 1/8 | N/A | 0.14 | Carded |
| 42302 | 5/32" X 6" Pin Punch | 0 81243 42302 3 | 6 | 5/16 | Hex | 5/32 | N/A | 0.10 | Carded |
| 42402 | 3/16" X 6" Long Pin Punch | 0 81243 42402 0 | 6 | 5/16 | Hex | 3/16 | N/A | 0.16 | Carded |
| 42702 | 1/4" X 6" Long Pin Punch | 0 81243 42702 1 | 6 | 7/16 | Hex | 1/4 | N/A | 0.17 | Carded |
| 71000 | 1/16" Reg Ec Pin Punch | 0 45256 71000 6 | 4 | 1/4 | Hex | 1/16 | N/A | 0.05 | Bulk |
| 71001 | 3/32" Reg Ec Pin Punch | 0 45256 71001 3 | 4-1/2 | 5/16 | Hex | 3/32 | N/A | 0.09 | Bulk |
| 71002 | 1/8" Reg Ec Pin Punch | 0 45256 71002 0 | 4-3/4 | 5/16 | Hex | 1/8 | N/A | 0.09 | Bulk |
| 71003 | 5/32" Reg Ec Pin Punch | 0 45256 71003 7 | 5 | 5/16 | Hex | 5/32 | N/A | 0.10 | Bulk |
| 71004 | 3/16" Reg Ec Pin Punch | 0 45256 71004 4 | 5-1/4 | 3/8 | Hex | 3/16 | N/A | 0.16 | Bulk |
| 71005 | 1/4" Reg Ec Pin Punch | 0 45256 71005 1 | 5-3/4 | 3/8 | Hex | 1/4 | N/A | 0.17 | Bulk |
| 71019 | 5/16" Reg Ec Pin Punch | 0 45256 71019 8 | 6 | 7/16 | Hex | 5/16 | N/A | 0.24 | Bulk |
| 71500 | 1/8" Reg Ec Pin Punch | 0 45256 71500 1 | 8 | 5/16 | Hex | 1/8 | Extra Long | 0.12 | Bulk |
| 71501 | 3/16" Reg Ec Pin Punch | 0 45256 71501 8 | 8 | 3/8 | Hex | 3/16 | Extra Long | 0.16 | Bulk |
| 71502 | 1/4" Reg Ec Pin Punch | 0 45256 71502 5 | 8 | 3/8 | Hex | 1/4 | Extra Long | 0.19 | Bulk |
| 71503 | 5/16" Reg Ec Pin Punch | 0 45256 71503 2 | 8 | 7/16 | Hex | 5/16 | Extra Long | 0.28 | Bulk |
| 71504 | 3/8" Reg Ec Pin Punch | 0 45256 71504 9 | 8 | 1/2 | Hex | 3/8 | Extra Long | 0.38 | Bulk |
| 42002 | 3/32" X 4-1/2" Pin Punch | 0 81243 42002 2 | 4-1/2 | 1/4 | Hex | 3/32 | Extra Long | 0.09 | Carded |
| 21600 | 1/16" Min Knurled Pin Punch | 0 45256 21600 3 | 2-3/4 | 3/16 | Round | 1/16 | N/A | 0.02 | Bulk |
| 21601 | 5/64" Min Knurled Pin Punch | 0 45256 21601 0 | 2-3/4 | 3/16 | Round | 5/64 | N/A | 0.02 | Bulk |
| 21602 | 3/32" Min Knurled Pin Punch | 0 45256 21602 7 | 2-3/4 | 3/16 | Round | 3/32 | N/A | 0.02 | Bulk |
| 21701 | 1/16" Reg Knurled Pin Punch | 0 45256 21701 7 | 4 | 1/4 | Round | 1/16 | N/A | 0.04 | Bulk |
| 21702 | 3/32" Reg Knurled Pin Punch | 0 45256 21702 4 | 4 | 1/4 | Round | 3/32 | N/A | 0.04 | Bulk |
| 21703 | 1/8" Reg Knurled Pin Punch | 0 45256 21703 1 | 4 | 5/16 | Round | 1/8 | N/A | 0.06 | Bulk |
| 21704 | 5/32" Reg Knurled Pin Punch | 0 45256 21704 8 | 4 | 5/16 | Round | 5/32 | N/A | 0.07 | Bulk |
| 21705 | 3/16" Reg Knurled Pin Punch | 0 45256 21705 5 | 4 | 5/16 | Round | 3/16 | N/A | 0.07 | Bulk |
| 21706 | 7/32" Reg Knurled Pin Punch | 0 45256 21706 2 | 4 | 3/8 | Round | 7/32 | N/A | 0.10 | Bulk |
| 21707 | 1/4" Reg Knurled Pin Punch | 0 45256 21707 9 | 4 | 3/8 | Round | 1/4 | N/A | 0.10 | Bulk |
| 21708 | 5/16" Reg Knurled Pin Punch | 0 45256 21708 6 | 4 | 1/2 | Round | 5/16 | N/A | 0.19 | Bulk |



Line-Up Punches

- Used to align holes through which rivets, pins, or bolts will be inserted
- Not for use when driving pins, rivets, or bolts
- Variable point size, shank size, and taper length for the perfect alignment
- Available in a shot-blasted finish
- Made in the USA

| Item | Description | UPC Code | OAL | Body Size | Body Type | Blade Width | Blade Style | Weight (Lbs) | Pkg. Type |
|-------|-----------------------------------|-----------------|-----|-----------|-----------|-------------|-------------|--------------|-----------|
| 43902 | 1/8" X 8" Line-Up Punch, Carded | 0 81243 43902 4 | 8 | 5/16 | Hex | 1/8 | N/A | 0.15 | Carded |
| 43952 | 5/32" X 9" Line-Up Punch, Carded | 0 81243 43952 9 | 9 | 3/8 | Hex | 5/32 | N/A | 0.35 | Carded |
| 44002 | 3/16" X 9" Line-Up Punch, Carded | 0 81243 44002 0 | 9 | 3/8 | Hex | 3/16 | N/A | 0.44 | Carded |
| 44102 | 1/4" X 12" Line-Up Punch, Carded | 0 81243 44102 7 | 12 | 5/8 | Hex | 1/4 | N/A | 0.82 | Carded |
| 44202 | 5/16" X 12" Line-Up Punch, Carded | 0 81243 44202 4 | 12 | 5/8 | Hex | 5/16 | N/A | 0.94 | Carded |
| 72003 | 1/4" Reg Ec Line-Up Punch | 0 45256 72003 6 | 12 | 5/8 | Hex | 1/4 | N/A | 0.82 | Bulk |
| 72010 | 1/8" Reg Ec Line-Up Punch | 0 45256 72010 4 | 8 | 5/16 | Hex | 1/8 | N/A | 0.15 | Bulk |
| 72011 | 5/32" Reg Ec Line-Up Punch | 0 45256 72011 1 | 9 | 3/8 | Hex | 5/32 | N/A | 0.23 | Bulk |
| 72012 | 3/16" Reg Ec Line-Up Punch | 0 45256 72012 8 | 10 | 1/2 | Hex | 3/16 | N/A | 0.44 | Bulk |

Chisels

Punches

Pry Bars

Handguarded

Specialty

Inspection

Sets and Kits



Line-Up Pry Bar

- Long, tapered end for aligning and adjusting metal or woods
- Angled chisel end for extra leverage when prying
- Available in a variety of lengths for work in hard-to-reach spots and more leverage
- Shot-blast finish
- Made in the USA

| Item | Description | UPC Code | OAL | Body Size | Body Type | Blade Width | Blade Style | Weight (Lbs) | Pkg. Type |
|-------|---------------------|-----------------|-----|-----------|-----------|-------------|-------------|--------------|-----------|
| 75000 | 14" Line-Up Pry Bar | 0 45256 75000 2 | 14 | 1/2 | Hex | 5/8 | N/A | 0.72 | Bulk |
| 75001 | 16" Line-Up Pry Bar | 0 45256 75001 9 | 16 | 5/8 | Hex | 3/4 | N/A | 1.21 | Bulk |
| 75002 | 20" Line-Up Pry Bar | 0 45256 75002 6 | 20 | 3/4 | Hex | 7/8 | N/A | 2.23 | Bulk |



Rolling Head Pry Bar

- Long tapered end for aligning and adjusting metal or wood
- 90 degree angled chisel end for extra leverage when prying
- Rolling head provides extra leverage and helps dislodge heavy items
- Shot-blast finish
- Made in the USA

| Item | Description | UPC Code | OAL | Body Size | Body Type | Blade Width | Blade Style | Weight (Lbs) | Pkg. Type |
|-------|--------------------------|-----------------|-----|-----------|-----------|-------------|-------------|--------------|-----------|
| 75101 | 16" Rolling Head Pry Bar | 0 45256 75101 6 | 16 | 1/2 | Hex | 5/8 | N/A | 0.93 | Bulk |



Select Pry Bar

- Used for lifting and prying
- Available in curved blade styles
- Heat treated along the entire length of the steel
- Chrome vanadium shaft with corrosion-resistant finish
- Made in Taiwan

| Item | Description | UPC Code | OAL | Body Size | Body Type | Blade Width | Blade Style | Weight (Lbs) | Pkg. Type |
|-------|---------------------------|-----------------|-----|-----------|-----------|-------------|-------------|--------------|-----------|
| 45006 | 8" MayhewSelect™ Pry Bar | 0 45256 45006 3 | 8 | N/A | Square | 7/16 | N/A | 0.32 | Bulk |
| 45007 | 12" MayhewSelect™ Pry Bar | 0 45256 45007 0 | 12 | N/A | Square | 5/8 | N/A | 0.65 | Bulk |
| 45008 | 18" MayhewSelect™ Pry Bar | 0 45256 45008 7 | 18 | N/A | Square | 3/4 | N/A | 1.29 | Bulk |
| 45009 | 24" MayhewSelect™ Pry Bar | 0 45256 45009 4 | 24 | N/A | Square | 3/4 | N/A | 0.44 | Bulk |



Straight Pinch Bar

- Used to align, adjust, move, and pry metal or woods
- Available in multiple sizes and lengths for the right amount of strength for the job
- Shot-blast finish
- Made in the USA

| Item | Description | UPC Code | OAL | Body Size | Body Type | Blade Width | Blade Style | Weight (Lbs) | Pkg. Type |
|-------|------------------------|-----------------|-----|-----------|-----------|-------------|-------------|--------------|-----------|
| 75125 | 14" Straight Pinch Bar | 0 45256 75125 2 | 14 | 1/2 | Hex | N/A | Straight | 0.72 | Bulk |
| 75126 | 16" Straight Pinch Bar | 0 45256 75126 9 | 16 | 5/8 | Hex | N/A | Straight | 1.21 | Bulk |
| 75127 | 20" Straight Pinch Bar | 0 45256 75127 6 | 20 | 3/4 | Hex | N/A | Straight | 2.23 | Bulk |

Chisels

Punches

Pry Bars

Handguarded

Specialty

Inspection

Sets and Kits



Gooseneck Wrecking Bars

- Used in demolition for pulling, prying, and for removing nails from hard wood with minimal damage to the wood
- Available in a multitude of lengths and body sizes for the perfect tool to fit the job
- Powder-coated finish
- Made in the USA

| Item | Description | UPC Code | OAL | Body Size | Body Type | Blade Width | Blade Style | Weight (Lbs) | Pkg. Type |
|-------|----------------------------|-----------------|-----|-----------|-----------|-------------|-------------|--------------|-----------|
| 41001 | 18" Gooseneck Wrecking Bar | 0 45256 41001 2 | 18 | 5/8 | Hex | N/A | N/A | 1.9 | Bulk |
| 41002 | 24" Gooseneck Wrecking Bar | 0 45256 41002 9 | 24 | 3/4 | Hex | N/A | N/A | 3.35 | Bulk |
| 41003 | 30" Gooseneck Wrecking Bar | 0 45256 41003 6 | 30 | 3/4 | Hex | N/A | N/A | 3.9 | Bulk |
| 41004 | 36" Gooseneck Wrecking Bar | 0 45256 41004 3 | 36 | 3/4 | Hex | N/A | N/A | 4.6 | Bulk |



Molding Bar

- Used for prying, lifting, and pulling baseboard and door molding
- One size fits all applications
- Powder-coated finish
- Made in the USA

| Item | Description | UPC Code | OAL | Body Size | Body Type | Blade Width | Blade Style | Weight (Lbs) | Pkg. Type |
|-------|------------------------|-----------------|-----|-----------|-----------|-------------|-------------|--------------|-----------|
| 41275 | 10" Molding Lifter Bar | 0 45256 41275 7 | 10 | 1/2 | Hex | N/A | N/A | 0.65 | Bulk |



Nail Pullers

- Used to remove nails from the hardest of woods
- Specially designed head for removing the toughest nails
- Available in single, double ended, or combo (one end nail puller, one end pry bar)
- Made in the USA

| Item | Description | UPC Code | OAL | Body Size | Body Type | Blade Width | Blade Style | Weight (Lbs) | Pkg. Type |
|-------|------------------------|-----------------|-------|-----------|-----------|-------------|-------------|--------------|-----------|
| 41100 | Single Nail Puller | 0 45256 41100 2 | 10 | 5/8 | Hex | N/A | N/A | 1.05 | Bulk |
| 41101 | Double Nail Puller | 0 45256 41101 9 | 10 | 5/8 | Hex | N/A | N/A | 1.05 | Bulk |
| 41300 | 14" Double Utility Bar | 0 45256 41300 6 | 14 | 1-3/8 | Flat | N/A | N/A | 1.53 | Bulk |
| 41102 | 15" Nail Puller/Combo | 0 45256 41102 6 | 15 | 5/8 | Hex | N/A | N/A | 1.4 | Bulk |
| 98602 | Mini Utility Bar | 0 81243 98602 3 | 7-1/2 | N/A | Flat | 1 | N/A | 0.25 | Carded |



Ripping Chisel

- Used to rip apart building materials and for pulling apart studs
- Has handy nail slots to help remove stubborn nails when separating wood
- Available single or double ended
- Powder-coated finish
- Made in the USA

| Item | Description | UPC Code | OAL | Body Size | Body Type | Blade Width | Blade Style | Weight (Lbs) | Pkg. Type |
|-------|---------------------------|-----------------|-----|-----------|-----------|-------------|-------------|--------------|-----------|
| 41200 | 18" Ripping Chisel Single | 0 45256 41200 9 | 18 | 3/4 | Square | N/A | N/A | 2.35 | Bulk |
| 41201 | 18" Ripping Chisel Double | 0 45256 41201 6 | 18 | 3/4 | Square | N/A | N/A | 2.355 | Bulk |



Tweaker™

- Used to tweak or adjust bent or warped lumber; adjust studs, joints, or rafters
- Demolition uses include pulling nails, wedging, stripping, and wrecking
- Only for use on lumber
- Powder-coated finish with a cushion-grip handle
- Made in Taiwan

| Item | Description | UPC Code | OAL | Body Size | Body Type | Blade Width | Blade Style | Weight (Lbs) | Pkg. Type |
|-------|-------------|-----------------|--------|-----------|-----------|-------------|-------------|--------------|-----------|
| 41500 | Tweaker | 0 45256 41500 0 | 14-1/2 | 3/4 | Hex | N/A | N/A | 2.1 | Clamshell |

Chisels

Punches

Pry Bars

Handguarded

Specialty

Inspection

Sets and Kits



Handguarded Cold Chisels

- Used to cut and shape metals softer than the cutting edge of the chisel
- Cutting edge angle designed to provide greater strength
- Cold chisel is not intended to be used on masonry materials
- Available in a variety of lengths and sizes to fit any application
- Available in a shot-blasted finish
- Made in the USA

| Item | Description | UPC Code | OAL | Body Size | Body Type | Blade Width | Blade Style | Weight (Lbs) | Pkg. Type |
|-------|-----------------------------------|-----------------|-----|-----------|-----------|-------------|-------------|--------------|-------------|
| 10605 | 3/4" X 7" Handguarded Cold Chisel | 0 81243 10605 6 | 7 | 5/8 | Hex | 3/4 | N/A | 0.88 | Plastic Bag |
| 10805 | 1" X 8" Handguarded Cold Chisel | 0 81243 10805 0 | 8 | 3/4 | Hex | 1 | N/A | 1.58 | Plastic Bag |
| 12205 | 3/4" X 12" Handguarded Chisel | 0 81243 12205 6 | 12 | 5/8 | Hex | 3/4 | N/A | 1.38 | Plastic Bag |
| 12405 | 1" X 12" Handguarded Cold Chisel | 0 81243 12405 0 | 12 | 3/4 | Hex | 1 | N/A | 1.82 | Plastic Bag |



Handguarded Mason Chisels

- Used in a multitude of masonry applications, from brick to stone to concrete
- Allows for specific cuts, sizes, and scores. Different cutting edge lengths provide the perfect sized tool for the perfect finished look
- Shot-blasted finish
- Made in the USA

| Item | Description | UPC Code | OAL | Body Size | Body Type | Blade Width | Blade Style | Weight (Lbs) | Pkg. Type |
|-------|------------------------------------------|-----------------|-------|-----------|-----------|-------------|-------------|--------------|-------------|
| 35005 | 3" Handguarded Mason Chisel | 0 81243 35005 3 | 7-3/4 | 7/8 | Hex | 3 | N/A | 1.93 | Plastic Bag |
| 35105 | 3-1/2" Handguarded Mason Chisel | 0 81243 35105 0 | 7 | 7/8 | Hex | 3-1/2 | N/A | 1.93 | Plastic Bag |
| 35205 | 4" Handguarded Mason Chisel | 0 81243 35205 7 | 7-1/2 | 1 | Hex | 4 | N/A | 1.97 | Plastic Bag |
| 35705 | 2-1/4" X 7-3/4" Handguarded Mason Chisel | 0 81243 35705 2 | 7-3/4 | 5/8 | Hex | 2-1/4 | N/A | 1.24 | Plastic Bag |



Handguarded Bullpoint Chisel

- Used to break up and demolish concrete
- Used where an air chisel is impractical
- Shot-blasted finish
- Made in the USA

| Item | Description | UPC Code | OAL | Body Size | Body Type | Blade Width | Blade Style | Weight (Lbs) | Pkg. Type |
|-------|----------------------------------|-----------------|-----|-----------|-----------|-------------|-------------|--------------|-------------|
| 80205 | 3/4" X 12" Handguarded Bullpoint | 0 81243 80205 7 | 12 | 3/4 | Hex | 3/4 | N/A | 2.04 | Plastic Bag |



Handguarded Floor Chisel

- Used to cut and trim wood and to pull tongue and groove materials together
- Thin blade allows for access to tight spaces
- Shot-blasted finish
- Made in the USA

| Item | Description | UPC Code | OAL | Body Size | Body Type | Blade Width | Blade Style | Weight (Lbs) | Pkg. Type |
|-------|---------------------------------|-----------------|--------|-----------|-----------|-------------|-------------|--------------|-------------|
| 94105 | 2-1/2" Handguarded Floor Chisel | 0 81243 94105 3 | 10-1/2 | 5/8 | Hex | 2-1/2 | N/A | 1.57 | Plastic Bag |



Handguarded Electrician's Chisel

- Used for cutting out plaster, drywall, and other renovation work
- Shot-blasted finish
- Made in the USA

| Item | Description | UPC Code | OAL | Body Size | Body Type | Blade Width | Blade Style | Weight (Lbs) | Pkg. Type |
|-------|----------------------------------------------|-----------------|-----|-----------|-----------|-------------|-------------|--------------|-------------|
| 94505 | 2-3/4" X 9" Handguarded Electrician's Chisel | 0 81243 94505 1 | 9 | 3/4 | Hex | 2-3/4 | N/A | 1.27 | Plastic Bag |



45680 - Hose Clamp Pliers

Replaces 45650

- Used to loosen and remove a wide variety of automotive hose clamps
- Long, flexible cable allows for use in hard-to-reach areas
- Spring loaded
- Made in France

Hose Clamp Pliers

| Item | Description | UPC Code | OAL | Body Size | Body Type | Blade Width | Blade Style | Weight (Lbs) | Pkg. Type |
|-------|---------------------------------|-----------------|--------|-----------|-----------|-------------|-------------|--------------|-----------|
| 45680 | MayhewSelect™ Hose Clamp Pliers | 0 45256 45680 5 | 14-3/4 | N/A | N/A | N/A | N/A | 1.03 | Clamshell |



Belt/Molding Remover

| Item | Description | UPC Code | OAL | Body Size | Body Type | Blade Width | Blade Style | Weight (Lbs) | Pkg. Type |
|-------|------------------------------------|-----------------|--------|-----------|-----------|-------------|-------------|--------------|-----------|
| 45049 | MayhewSelect™ Belt/Molding Removal | 0 45256 45049 0 | 12-1/2 | N/A | N/A | N/A | N/A | 0.47 | Bulk |



Stud Extractor

- Used to remove seized or broken studs and bolts
- Designed to fit into small areas, where studs may be hard to reach
- Made out of high-grade, heat-treated alloy steel
- Chrome finish for additional rust protection and aesthetic appeal
- Use with a 3/8" impact wrench, on low
- Made in Taiwan to Mayhew's specifications

| Item | Description | UPC Code | OAL | Body Size | Body Type | Blade Width | Blade Style | Weight (Lbs) | Pkg. Type |
|-------|----------------|-----------------|-------|-----------|-----------|-------------|-------------|--------------|-----------|
| 29895 | Stud Extractor | 0 45256 29895 5 | 7-5/8 | N/A | N/A | N/A | N/A | 0.86 | Bulk |

Flexible Bit/Socket Drivers



| Item | Description | UPC Code | OAL | Body Size | Body Type | Blade Width | Blade Style | Weight (Lbs) | Pkg. Type |
|-------|-------------------------------------------|-----------------|-------|-----------|-----------|-------------|-------------|--------------|-----------|
| 45016 | 1/4" MayhewSelect™ Flexible Bit Driver | 0 45256 45016 2 | 9-1/2 | N/A | Round | 1/4 | N/A | 0.74 | Bulk |
| 45017 | 1/4" MayhewSelect™ Flexible Socket Driver | 0 45256 45017 9 | 9-1/2 | N/A | Round | 1/4 | N/A | 0.74 | Bulk |



45053 - 9 PC Metric Twisted Hex Key



45052 - 9 PC SAE Twisted Hex Key

Twisted Hex Keys

- Superior Quality S2 Tool Steel
- Twisted prior the heat treat to increase torque capacity
- Longer shaft for added leverage
- Exceeds ANSI standards
- Color coated to resist corrosion, manganese-phosphate contact areas to resist wear
- Available in fractional or metric sizes

| Item | Description | UPC Code | OAL | Body Size | Body Type | Blade Width | Blade Style | Weight (Lbs) | Pkg. Type |
|-------|-----------------------------------------------|-----------------|-----|-----------|-----------|-------------|-------------|--------------|-------------|
| 45052 | MayhewSelect™ 9 Pc SAE Twisted Hex Key Set | 0 45256 45052 0 | 10 | N/A | N/A | N/A | N/A | 0.79 | Display Box |
| 45053 | MayhewSelect™ 9 Pc Metric Twisted Hex Key Set | 0 45256 45053 7 | 10 | N/A | N/A | N/A | N/A | 0.82 | Display Box |

Chisels

Punches

Pry Bars

Handguarded

Specialty

Inspection

Sets and Kits



Screwdrivers – Phillips

- Used to fasten and unfasten screws in almost any setting with a Phillips bit
- Designed with an extended blade forged with a capped end
- Hex bolster for use with a wrench for increased torque
- Black oxide tips for a better grip on the screw
- Made in Taiwan

| Item | Description | UPC Code | OAL | Body Size | Body Type | Blade Width | Blade Style | Weight (Lbs) | Pkg. Type |
|-------|---------------------------|-----------------|--------|-----------|-----------|-------------|-------------|--------------|-----------|
| 45000 | #1" X 3" Phillips Sd | 0 45256 45000 1 | 3 | N/A | Hex | 1 | N/A | 0.29 | Bulk |
| 45001 | #2" X 4" Phillips Sd | 0 45256 45001 8 | 4 | N/A | Hex | 2 | N/A | 0.32 | Bulk |
| 45002 | #3" X 6" Phillips Sd | 0 45256 45002 5 | 6 | N/A | Hex | 3 | N/A | 0.51 | Bulk |
| 45010 | #2" X 7-3/4" Phillips Sd | 0 45256 45010 0 | 7-3/4 | N/A | Hex | 2 | N/A | 0.40 | Bulk |
| 45011 | #2" X 12" Phillips Sd | 0 45256 45011 7 | 12 | N/A | Hex | 2 | N/A | 0.44 | Bulk |
| 45012 | #2" X 17-3/4" Phillips Sd | 0 45256 45012 4 | 17-3/4 | N/A | Hex | 2 | N/A | 0.51 | Bulk |
| 45018 | #2" X 6" Phillips Sd | 0 45256 45018 6 | 6 | N/A | Hex | 2 | N/A | 0.36 | Bulk |
| 45019 | #2" X 1-1/2" Phillips Sd | 0 45256 45019 3 | 1-1/2 | N/A | Hex | 2 | N/A | 0.12 | Bulk |



Screwdrivers – Slotted

- Used to fasten and unfasten screws in almost any setting with a slotted bit
- Designed with an extended blade forged with a capped end
- Hex bolster for use with a wrench for increased torque
- Black oxide tips for a better grip on the screw
- Made in Taiwan

| Item | Description | UPC Code | OAL | Body Size | Body Type | Blade Width | Blade Style | Weight (Lbs) | Pkg. Type |
|-------|----------------------------|-----------------|--------|-----------|-----------|-------------|-------------|--------------|-----------|
| 45003 | 7/32" X 4" Slotted Sd | 0 45256 45003 2 | 4 | N/A | Hex | 7/32 | N/A | 0.29 | Bulk |
| 45004 | 1/4" X 6" Slotted Sd | 0 45256 45004 9 | 6 | N/A | Hex | 1/4 | N/A | 0.34 | Bulk |
| 45005 | 5/16" X 7" Slotted Sd | 0 45256 45005 6 | 7 | N/A | Hex | 5/16 | N/A | 0.53 | Bulk |
| 45013 | 5/16" X 17-3/4" Slotted Sd | 0 45256 45013 1 | 17-3/4 | N/A | Hex | 5/16 | N/A | 0.55 | Bulk |
| 45014 | 5/16" X 12" Slotted Sd | 0 45256 45014 8 | 12 | N/A | Hex | 5/16 | N/A | 0.36 | Bulk |
| 45020 | 3/8" X 8" Slotted Sd | 0 45256 45020 9 | 8 | N/A | Hex | 3/8 | N/A | 0.12 | Bulk |
| 45021 | 1/4" X 1-1/2" Slotted Sd | 0 45256 45021 6 | 1-1/2 | N/A | Hex | 1/4 | N/A | 0.56 | Bulk |



Scratch Awl

- Used for a wide variety of applications, such as automotive and electrical work in confined spaces, scribing lines, o-ring and cotter pin removal, and to break radiator connections
- Made of larger shank steel for heavy-duty applications
- Made in the USA

| Item | Description | UPC Code | OAL | Body Size | Body Type | Blade Width | Blade Style | Weight (Lbs) | Pkg. Type |
|-------|--------------------------------|-----------------|--------|-----------|-----------|-------------|-------------|--------------|--------------|
| 46502 | 1/4" Scratch Awl, 5-1/2" Blade | 0 81243 46502 3 | 10-1/2 | 1/4 | Round | 1/4 | N/A | 0.15 | Blister Pack |

Air Nozzles



17055 – ABGPV1 Pivot Air Blow Gun



17065 – ABGTTEL1 Telescoping Air Nozzle

| Item | Description | UPC Code | OAL | Body Size | Body Type | Blade Width | Blade Style | Weight (Lbs) | Pkg. Type |
|-------|---------------------------------|-----------------|--------|-----------|-----------|-------------|-------------|--------------|-----------|
| 17055 | ABGPV1 Pivot Air Blow Gun | 0 45256 17055 8 | 12-1/2 | N/A | N/A | N/A | N/A | 0.27 | Carded |
| 17065 | ABGTTEL1 Telescoping Air Nozzle | 0 45256 17065 7 | 13-1/2 | N/A | N/A | N/A | N/A | 0.29 | Carded |



Mayhew Steel Products, Inc.
199 Industrial Blvd.
Turners Falls, MA 01376

U.S. Toll-Free Customer Service: 800-872-0037
Visit us online at www.Mayhew.com
Always wear safety goggles when using hand tools.

Version 2.016
For the latest version, visit us
online at www.Mayhew.com

The Pros Know

Chisels

Punches

Pry Bars

Handguarded

Specialty

Inspection

Sets and Kits



17150 – SSMR01 Stainless Steel Mirror

- Used to view or magnify hard-to-see places
- Original patented design with a 180° swivel, designed to hold its position
- Available in a straight extendable or flexible shaft
- Specialty stethoscope tool also available for identifying sounds
- Made in the USA

Mirror & Magnifying

| Item | Description | UPC Code | OAL | Body Size | Body Type | Blade Width | Blade Style | Weight (Lbs) | Pkg. Type |
|-------|------------------------------------|-----------------|--------|-----------|-----------|-------------|-------------|--------------|-------------|
| 17020 | TKFIER Magnifier W/Coupler | 0 45256 17020 6 | 3-1/4 | N/A | N/A | N/A | N/A | 0.04 | Bulk |
| 17030 | TKSSANT SS Antenna W/Coupler | 0 45256 17030 5 | 7 | N/A | N/A | N/A | N/A | 0.15 | Carded |
| 17035 | TKTORCH Flashlight W/SS Antenna | 0 45256 17035 0 | 7-1/2 | N/A | N/A | N/A | N/A | 0.33 | Bulk |
| 17150 | SSMR01 Stainless Steel Mirror | 0 45256 17150 0 | 6-3/4 | N/A | N/A | N/A | Curved | 0.20 | Carded |
| 17300 | TK02MIR Mirror W/Coupler | 0 45256 17300 9 | 3 | N/A | N/A | N/A | N/A | 0.04 | Bulk |
| 17305 | TF01 Telescoping Magnifier | 0 45256 17305 4 | 7 | N/A | N/A | N/A | N/A | 0.14 | Carded |
| 17320 | TK01MIR Mirror W/Coupler | 0 45256 17320 7 | 4 | N/A | N/A | N/A | N/A | 0.05 | Bulk |
| 17330 | TK03MIR Mirror W/Coupler | 0 45256 17330 6 | 3 | N/A | N/A | N/A | N/A | 0.02 | Bulk |
| 17600 | FF01 Flex Shaft W/Magnifier | 0 45256 17600 0 | 22-1/4 | N/A | N/A | N/A | N/A | 0.25 | Carded |
| 17615 | FMR01 Flex Shaft W/Mirror | 0 45256 17615 4 | 22-1/4 | N/A | N/A | N/A | N/A | 0.25 | Carded |
| 17750 | MR01 Inspection Telescoping Mirror | 0 45256 17750 2 | 7-3/4 | N/A | N/A | N/A | N/A | 0.15 | Carded |
| 17755 | MR02 Inspection Telescoping Mirror | 0 45256 17755 7 | 7 | N/A | N/A | N/A | N/A | 0.10 | Carded |
| 17760 | MR03 Inspection Telescoping Mirror | 0 45256 17760 1 | 6-3/4 | N/A | N/A | N/A | N/A | 0.10 | Carded |
| 17765 | MR04 Inspection Telescoping Mirror | 0 45256 17765 6 | 8-3/4 | N/A | N/A | N/A | N/A | 0.25 | Plastic Bag |
| 17770 | MGMR01 3X Magnified Glass Mirror | 0 45256 17770 0 | 7 | N/A | N/A | N/A | N/A | 0.20 | Carded |
| 17805 | PM01B-M Pen Magnet W/Mirror | 0 45256 17805 9 | 6-1/4 | N/A | N/A | N/A | N/A | 0.50 | Carded |



- Used to pick up hard-to-reach items through magnetic or mechanical means
- Available in a straight extendable shaft, flexible shaft, or both

Pick-Up Tools

| Item | Description | UPC Code | OAL | Body Size | Body Type | Blade Width | Blade Style | Weight (Lbs) | Pkg. Type |
|-------|-----------------------------------|-----------------|--------|-----------|-----------|-------------|-------------|--------------|-------------|
| 17025 | TKFLEX Quick Change Flex | 0 45256 17025 1 | 21-3/4 | N/A | N/A | N/A | N/A | 0.20 | Bulk |
| 17315 | TK01MAG 14 lb Magnet W/Coupler | 0 45256 17315 3 | 4-1/2 | N/A | N/A | N/A | N/A | 0.07 | Bulk |
| 17325 | TK03MAG 3 lb Magnet W/Coupler | 0 45256 17325 2 | 4 | N/A | N/A | N/A | N/A | 0.03 | Bulk |
| 17605 | PFM01 Flex Shaft W/3 lb Magnet | 0 45256 17605 5 | 22 | N/A | N/A | N/A | N/A | 0.20 | Carded |
| 17610 | FM02 Flex Shaft W/14 lb Magnet | 0 45256 17610 9 | 22 | N/A | N/A | N/A | N/A | 0.25 | Carded |
| 17800 | PM01 Pen Magnet | 0 45256 17800 4 | 5-3/4 | N/A | N/A | N/A | N/A | 0.50 | Carded |
| 17810 | PMG01 14 lb Magnet W/SS Telescope | 0 45256 17810 3 | 7-1/2 | N/A | N/A | N/A | N/A | 0.15 | Carded |
| 17830 | PMG02 14 lb Swiv Head Mag W/SS | 0 45256 17830 1 | 8 | N/A | N/A | N/A | N/A | 0.20 | Carded |
| 45046 | Lighted Flex Claw Tool | 0 45256 45046 9 | 14-1/2 | N/A | N/A | N/A | N/A | 0.47 | Display Box |
| 45048 | Flexible Lighted Pick-Up Tool | 0 45256 45048 3 | 10 | N/A | N/A | N/A | N/A | 0.43 | Display Box |
| 45056 | Lighted Magnetic Claw Tool | 0 45256 45056 8 | 14-1/5 | N/A | N/A | N/A | N/A | 0.54 | Display Box |
| 17845 | PMG03 3 lb Magnet W/SS Telescope | 0 45256 17845 5 | 7 | N/A | N/A | N/A | N/A | 0.10 | Carded |

Replacement Parts

| Item | Description | UPC Code | OAL | Body Size | Body Type | Blade Width | Blade Style | Weight (Lbs) | Pkg. Type |
|-------|-------------------------------------|-----------------|-------|-----------|-----------|-------------|-------------|--------------|-------------|
| 17006 | TK02 Bulb 0.75A Krypton | 0 45256 17006 0 | 3-1/2 | N/A | N/A | N/A | N/A | 0.02 | Bulk |
| 17101 | RPMIRO1 Replacement Mirror | 0 45256 17101 2 | N/A | N/A | N/A | N/A | N/A | 0.04 | Plastic Bag |
| 17102 | RPMIRO2 Replacement Mirror | 0 45256 17102 9 | N/A | N/A | N/A | N/A | N/A | 0.03 | Plastic Bag |
| 17103 | RPMIRO3 Replacement Mirror | 0 45256 17103 6 | N/A | N/A | N/A | N/A | N/A | 0.01 | Plastic Bag |
| 17110 | RPPIV1 Replacement Nozzle for 17055 | 0 45256 17110 4 | N/A | N/A | N/A | N/A | N/A | 0.08 | Plastic Bag |
| 17121 | RPTL1 Replacement Nozzle for 17065 | 0 45256 17121 0 | N/A | N/A | N/A | N/A | N/A | 0.08 | Plastic Bag |

Inspection Kits

| Item | Description | UPC Code | OAL | Body Size | Body Type | Blade Width | Blade Style | Weight (Lbs) | Pkg. Type |
|-------|----------------------------------------------------------------------------------------------------------------------------------------------------------------------------------------------------------------------------------------------------------------------------------------------------------------|-----------------|-----|-----------|-----------|-------------|-------------|--------------|-----------|
| 17705 | TK3000 Magnet/Mirror Kit 17755 – MR02 Inspection Tel Mirror 17830 – PMG02 14 lb Swiv Head Mag W/SS | 0 45256 17705 2 | N/A | N/A | N/A | N/A | N/A | 0.57 | Bulk |
| 17715 | Tk5000 Torch Kit W/5 Cmpts 17020 – TKFIER Magnifier W/Coupler 17035 – TKTORCH Flashlight W/SS Antenna 17300v – TK02MIR Mirror W/Coupler 17315 – TK01MAG 14 lb Magnet W/Coupler 17325 – TK03MAG 3 lb Magnet W/Coupler 17330 – TK03MIR Mirror W/Coupler | 0 45256 17715 1 | N/A | N/A | N/A | N/A | N/A | 0.98 | Bulk |
| 17720 | TK6000 5 Pc Telemulti Kit 17020 – TKFIER Magnifier W/Coupler 17030 – TKSSANT SS Antenna W/Coupler 17300 – TK02MIR Mirror W/Coupler 17315 – TK01MAG 14 lb Magnet W/Coupler 17325 – TK03MAG 3 lb Magnet W/Coupler | 0 45256 17720 5 | N/A | N/A | N/A | N/A | N/A | 0.57 | Bulk |
| 17730 | TK8000 Teleflex W/6 Cmpts 17020 – TKFIER Magnifier W/Coupler 17025 – TKFLEX Quick Change Flex 17030 – TKSSANT SS Antenna W/Coupler 17300 – TK02MIR Mirror W/Coupler 17315 – TK01MAG 14 lb Magnet W/Coupler 17325 – TK03MAG 3 lb Magnet W/Coupler 17330 – TK03MIR Mirror W/Coupler | 0 45256 17730 4 | N/A | N/A | N/A | N/A | N/A | 1.45 | Bulk |
| 17680 | TK1000 Telmag Tool Kit 17755 – MR02 Inspection Tel Mirror 17810 – PMG01 14 lb Magnet W/SS Telescope | 0 45256 17680 2 | N/A | N/A | N/A | N/A | N/A | 0.55 | Bulk |
| 17690 | TK20/20SE Teluminatr Torch Kit 17020 – TKFIER Magnifier W/Coupler 17035 – TKTORCH Flashlight W/SS Antenna 17300 – TK02MIR Mirror W/Coupler 17315 – TK01MAG 14 lb Magnet W/Coupler 17320 – TK01MIR Mirror W/Coupler 17325 – TK03MAG 3 lb Magnet W/Coupler 17330 – TK03MIR Mirror W/Coupler | 0 45256 17690 1 | N/A | N/A | N/A | N/A | N/A | 1.9 | Bulk |



17705 – Magnet/Mirror Kit



17715 – Torch Kit W/5 Cmpts



17720 – 5 Pc Telemulti Kit



17730 – Teleflex W/6 Cmpts



17680 – Telmag Tool Kit



17690 – Teluminatr Torch Kit



Mayhew Steel Products, Inc.
199 Industrial Blvd.
Turners Falls, MA 01376

U.S. Toll-Free Customer Service: 800-872-0037
Visit us online at www.Mayhew.com
Always wear safety goggles when using hand tools.

Version 2.2016
For the latest version, visit us
online at www.Mayhew.com

The Pros Know

Chisels

Punches

Pry Bars

Handguarded

Specialty

Inspection

Sets and Kits



89062 – 3 Pc Cold Chisel Set



90002 – 5 Pc Cold Chisel Set

Cold Chisel Sets

| Item | Description | UPC Code | OAL | Body Size | Body Type | Blade Width | Blade Style | Weight (Lbs) | Pkg. Type |
|-------|-----------------------------------------------------------------------------------------------------------------------------|-----------------|-----|-----------|-----------|-------------|-------------|--------------|-----------|
| 89062 | 3 Pc Cold Chisel Set 10302 – 3/8" X 5" Cold Chisel 10402 – 1/2" X 6" Cold Chisel 10502 – 5/8" X 6-1/2" Cold Chisel | 0 81243 89062 7 | N/A | N/A | Hex | N/A | N/A | 0.64 | Carded |
| 90002 | 5 Pc Cold Chisel Set 70212 – 3/4" Reg Ec Cold Chisel | 0 81243 90002 9 | N/A | N/A | Hex | N/A | N/A | 1.56 | Carded |

Punch & Chisel Sets

| Item | Description | UPC Code | OAL | Body Size | Body Type | Blade Width | Blade Style | Weight (Lbs) | Pkg. Type |
|-------|-----------------------------------------------------------------------------------------------------------------------------------------------------------------------------------------------------------------------------------------------------------------------------------------------------------------------------------------------------------------------------------------------------------------------------------------------------------|-----------------|-----|-----------|-----------|-------------|-------------|--------------|-----------|
| 85002 | 4 Pc Handguard Set 12205 – 3/4" x 12" Handguarded Chisel 35005 – 3" Handguarded Brick Set 35705 – 2-1/4" X 7-3/4" Handguarded Mason Chisel 94105 – 2-1/2" Handguarded Floor Chisel | 0 45256 85002 3 | N/A | N/A | Hex | N/A | N/A | 6.5 | Bulk |
| 61025 | 8 Pc Ec Punch & Chisel Kit 70002 – 3/16" Reg Ec Solid Punch 70202 – 3/8" Reg Ec Cold Chisel 70205 – 1/2" Reg Ec Cold Chisel 70209 – 5/8" Reg Ec Cold Chisel 71002 – 1/8" Reg Ec Pin Punch 71004 – 3/16" Reg Ec Pin Punch 71005 – 1/4" Reg Ec Pin Punch 74002 – 3/8" Reg Ec Center Punch | 0 45256 61025 2 | N/A | N/A | Hex | N/A | N/A | 1.53 | Pouch |
| 76005 | 6 Pc Punch & Chisel Kit 70002 – 3/16" Reg Ec Solid Punch 70205 – 1/2" Reg Ec Cold Chisel 70209 – 5/8" Reg Ec Cold Chisel 71002 – 1/8" Reg Ec Pin Punch 71004 – 3/16" Reg Ec Pin Punch 74002 – 3/8" Reg Ec Center Punch | 0 45256 76005 6 | N/A | N/A | Hex | N/A | N/A | 1.25 | Pouch |
| 90402 | 5 Pc Punch & Chisel Set, Carded 10402 – 1/2" X 6" Cold Chisel 40101B – 1/8" Reg Ec Solid Punch 42202 – 1/8" X 6" Long Pin Punch 70212 – 3/4" Reg Ec Cold Chisel 74001 – 5/16" Reg Ec Center Punch | 0 81243 90402 7 | N/A | N/A | Hex | N/A | N/A | 1.25 | Clamshell |
| 61040 | 12 Pc Punch & Chisel Set 70001 – 1/8" Reg Ec Solid Punch 70200 – 1/4" Reg Ec Cold Chisel 70202 – 3/8" Reg Ec Cold Chisel 70209 – 5/8" Reg Ec Cold Chisel 71001 – 3/32" Reg Ec Pin Punch 71002 – 1/8" Reg Ec Pin Punch 71003 – 5/32" Reg Ec Pin Punch 71004 – 3/16" Reg Ec Pin Punch 71005 – 1/4" Reg Ec Pin Punch 72011 – 5/32" Reg Ec Line-Up Punch 73002 – 3/8" Reg Ec Prick Punch 74002 – 3/8" Reg Ec Center Punch | 0 45256 61040 5 | N/A | N/A | Hex | N/A | N/A | 1.95 | Clamshell |

Chisels

Punches

Pry Bars

Handguarded

Specialty

Inspection

Sets and Kits

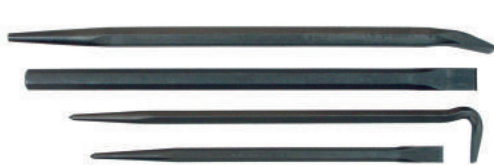

76284 – 4 Pc Ec Pry Bar Set



66302 – 4 Pc Pry Bar Set

Pry Bar Sets

| Item | Description | UPC Code | OAL | Body Size | Body Type | Blade Width | Blade Style | Weight (Lbs) | Pkg. Type |
|-------|-------------------------------------------------------------------------------------------------------------------------------------------------------------------------------|-----------------|-----|-----------|-----------|-------------|-------------|--------------|-----------|
| 76284 | 4 Pc Ec Pry Bar Set 70219 – 7/8" X 18" Ec Cold Chisel 75000 – Reg Ec 14" Line-Up Pry Bar 75002 – Reg Ec 20" Line-Up Pry Bar 75101 – Reg Ec 16" Rolling HD Pry Bar | 0 45256 76284 5 | N/A | N/A | Hex | N/A | N/A | 6.5 | Tray |
| 66302 | 4 Pc Pry Bar Set 45006 – 8" MayhewSelect™ Pry Bar 45007 – 12" MayhewSelect™ Pry Bar 45008 – 18" MayhewSelect™ Pry Bar 45009 – 24" MayhewSelect™ Pry Bar | 0 45256 66302 9 | N/A | N/A | Hex | N/A | N/A | 4.61 | N/A |



66300 – 6 Pc Capped End Screwdriver Set

Screwdriver Sets

| Item | Description | UPC Code | OAL | Body Size | Body Type | Blade Width | Blade Style | Weight (Lbs) | Pkg. Type |
|-------|-----------------------------------------------------------------------------------------------------------------------------------------------------------------------------------------------------------------------------------------------------------------------------------------------------------------------------------------------------------------------------------------------------------------------------------------------------------------------------------------|-----------------|-----|-----------|-----------|-------------|-------------|--------------|-----------|
| 66300 | 6 Pc Capped End Screwdriver Set 45000 – #1 X 3 MayhewSelect™ Phillips Sd 45001 – #2 X 4 MayhewSelect™ Phillips Sd 45002 – #3 X 6 MayhewSelect™ Phillips Sd 45003 – 7/32 X 4 MayhewSelect™ Slotted Sd 45004 – 1/4 X 6 MayhewSelect™ Slotted Sd 45005 – 5/16 X 7 MayhewSelect™ Slotted Sd | 0 45256 66300 5 | N/A | N/A | Hex | N/A | N/A | 3.62 | N/A |
| 66306 | 10 Pc Screwdriver Set 45000 – #1 X 3 MayhewSelect™ Phillips Sd 45001 – #2 X 4 MayhewSelect™ Phillips Sd 45002 – #3 X 6 MayhewSelect™ Phillips Sd 45003 – 7/32 X 4 MayhewSelect™ Slotted Sd 45004 – 1/4 X 6 MayhewSelect™ Slotted Sd 45005 – 5/16 X 7 MayhewSelect™ Slotted Sd 45018 – #2 X 6 MayhewSelect™ Phillips Sd 45019 – #2 X 1-1/2 MayhewSelect™ Phillips Sd 45020 – 3/8 X 8 MayhewSelect™ Slotted Sd 45021 – 1/4 X 1-1/2 MayhewSelect™ Slotted Sd | 0 45256 66306 7 | N/A | N/A | Hex | N/A | N/A | 3.96 | N/A |

Flexible Bit & Socket Driver Set

| Item | Description | UPC Code | OAL | Body Size | Body Type | Blade Width | Blade Style | Weight (Lbs) | Pkg. Type |
|-------|-----------------------------------------------------------------------------------------------------------------------------------------------|-----------------|-----|-----------|-----------|-------------|-------------|--------------|-----------|
| 66305 | 2 Pc Flexible Bit & Socket Driver Set 45016 – 1/4" MayhewSelect™ Flexible Bit Driver 45017 – 1/4" Mayhew Select™ Flexible Socket Driver | 0 45256 66305 0 | N/A | N/A | Round | N/A | N/A | 1.71 | N/A |



Mayhew Steel Products, Inc.
199 Industrial Blvd.
Turners Falls, MA 01376

U.S. Toll-Free Customer Service: 800-872-0037
Visit us online at www.Mayhew.com
Always wear safety goggles when using hand tools.

Version 2.2016
For the latest version, visit us
online at www.Mayhew.com

The Pros Know

Chisels

Punches

Pry Bars

Handguarded

Specialty

Inspection

Sets and Kits



89032 – 3 Pc. Short Pin Punch Set, Carded



47502 – 3 Pc Nail Set, 1-2-3/32, Carded

Punch Sets

| Item | Description | UPC Code | OAL | Body Size | Body Type | Blade Width | Blade Style | Weight (Lbs) | Pkg. Type |
|-------|-----------------------------------------------------------------------------------------------------------------------------------------------------------------------------------------------------------------------------------------------------------------------------------------------------------------------------------------------------------------------------------------------------------------------------------|-----------------|-----|-----------|-----------|-------------|-------------|--------------|-----------|
| 89082 | 3 Pc Punch Set, Carded 24008 – 7/16" Center Punch 1/4" Pt 43502 – 7/32" X 5" Prick Punch 74001 – 5/16" Reg Ec Center Punch | 0 81243 89082 5 | N/A | N/A | Hex | N/A | N/A | 0.48 | Carded |
| 62213 | 4 Pc Knurled Center Punch Kit 24200 – 1/4" Reg Knurled Center Punch 24300 – 5/16" Knurled Center Punch 24301 – 3/8" Knurled Center Punch 24302 – 1/2" Knurled Center Punch | 0 45256 62213 2 | N/A | N/A | N/A | N/A | N/A | 0.44 | Pouch |
| 62010 | 10 Pc Knurled Punch Kit 20501 – 3/32" Reg Knurled Solid Punch 21600 – 1/16" Min Knurled Pin Punch 21601 – 5/64" Min Knurled Pin Punch 21602 – 3/32" Min Knurled Pin Punch 21702 – 3/32" Reg Knurled Pin Punch 21703 – 1/8" Reg Knurled Pin Punch 21704 – 5/32" Reg Knurled Pin Punch 23200 – 5/16" Reg Knurled Prick Punch 24200 – 1/4" Reg Knurled Center Punch 24300 – 5/16" Knurled Center Punch | 0 45256 62010 7 | N/A | N/A | Round | N/A | N/A | 0.55 | Pouch |
| 76235 | 4 Pc Ec Line-Up Punch Kit 72003 – 1/4" Reg Ec Line-Up Punch 72010 – 1/8" Reg Ec Line-Up Punch 72011 – 5/32" Reg Ec Line-Up Punch 72012 – 3/16" Reg Ec Line-Up Punch | 0 45256 76235 7 | N/A | N/A | Hex | N/A | N/A | 1.78 | Pouch |
| 47502 | 3 Pc Nail Set, 1-2-3/32, Carded 26000 – 1/32" Nail Set 26001 – 2/32" Nail Set 26002 – 3/32" Nail Set | 0 81243 47502 2 | N/A | 3/8 | Hex | N/A | N/A | 0.288 | Carded |
| 76065 | Ec 5 Pc Long Pin Punch Kit 71500 – 1/8" Reg Ec Pin Punch 71501 – 3/16" Reg Ec Pin Punch 71502 – 1/4" Reg Ec Pin Punch 71503 – 5/16" Reg Ec Pin Punch 71504 – 3/8" Reg Ec Pin Punch | 0 45256 76065 0 | N/A | N/A | Hex | N/A | Extra Long | 1.23 | Pouch |
| 76075 | Ec 6 Pc Punch Kit 71001 – 3/32" Reg Ec Pin Punch 71002 – 1/8" Reg Ec Pin Punch 71003 – 5/32" Reg Ec Pin Punch 71004 – 3/16" Reg Ec Pin Punch 71005 – 1/4" Reg Ec Pin Punch 71019 – 5/16" Reg Ec Pin Punch | 0 45256 76075 9 | N/A | N/A | Hex | N/A | N/A | 0.88 | Pouch |
| 89032 | 3 Pc Short Pin Punch Set, Carded 42002 – 3/32" X 4-1/2" Pin Punch, Carded 42102 – 1/8" X 4-1/2" Pin Punch, Carded 71000 – 1/16" Reg Ec Pin Punch | 0 81243 89032 0 | N/A | N/A | Hex | N/A | N/A | 0.18 | Carded |
| 89052 | 3 Pc Long Pin Punch Set, Carded 42202 – 1/8" X 6" Long Pin Punch 42402 – 3/16" X 6" Long Pin Punch 42702 – 1/4" X 6" Long Pin Punch | 0 81243 89052 8 | N/A | N/A | Hex | N/A | N/A | 0.47 | Carded |
| 62060 | 8 Pc Knurled Pin Punch Kit 21701 – 1/16" Reg Knurled Pin Punch 21702 – 3/32" Reg Knurled Pin Punch 21703 – 1/8" Reg Knurled Pin Punch 21704 – 5/32" Reg Knurled Pin Punch 21705 – 3/16" Reg Knurled Pin Punch 21706 – 7/32" Reg Knurled Pin Punch 21707 – 1/4" Reg Knurled Pin Punch 21708 – 5/16" Reg Knurled Pin Punch | 0 45256 62060 2 | N/A | N/A | Round | N/A | N/A | 0.75 | Pouch |

Hook & Pick Sets

| Item | Description | UPC Code | OAL | Body Size | Body Type | Blade Width | Blade Style | Weight (Lbs) | Pkg. Type |
|-------|------------------------------|-----------------|-----|-----------|-----------|-------------|-------------|--------------|-----------|
| 60003 | 4 Pc Mini Hook & Pick Set | 0 45256 60003 1 | N/A | N/A | Round | N/A | N/A | 0.32 | N/A |
| 60028 | 4 Pc O-Ring Removal Tool Set | 0 45256 60028 4 | N/A | N/A | Round | N/A | N/A | 0.32 | N/A |



60003 – 4 Pc Mini Hook & Pick Set



60028 – 4 Pc O-Ring Removal Tool Set

Chisels

Punches

Pry Bars

Handguarded

Specialty

Inspection

Sets and Kits



Mayhew Steel Products, Inc.
199 Industrial Blvd.
Turners Falls, MA 01376

U.S. Toll-Free Customer Service: 800-872-0037
Visit us online at www.Mayhew.com
Always wear safety goggles when using hand tools.

Version 2.2016
For the latest version, visit us
online at www.Mayhew.com

The Pros Know



18 PC Masonry Display

80244 – 18 Pc Brick & Masonry Display

| Item | Description | UPC Code | OAL | Body Size | Body Type | Blade Width | Blade Style | Weight (Lbs) | Pkg. Type |
|-------|--------------------------------------------------------------------------------------------------------------------------------------------------------------------------------------------------------------------------------------------------------------------------------------------------------------------------|-----------------|-----|-----------|-----------|-------------|-------------|--------------|-----------|
| 80244 | 18 PC Masonry Display (2 ea) 12300 – 3" Brick Set (2) 12301 – 3.5" Brick Set (2) 12302 – 4" Brick Set (2) 12310 – 2.5" Floor Chisel (2) 12311 – 3" Floor Chisel (2) 30100 – 3/4" x 12" Bullpoint (2) 30200 – 1-3/4" Mason Chisel (2) 30202 – 2-1/4" Mason Chisel (2) 71300 – Rivet Buster (2) | 0 45256 80244 2 | N/A | N/A | Round | N/A | N/A | 22.08 | Base |

80241 88 PC Punch & Chisel Display

| Item | Description | UPC Code | OAL | Body Size | Body Type | Blade Width | Blade Style | Weight (Lbs) | Pkg. Type | |
|-------|------------------------------------------------------------------------------------------------------------------------------------------------------------------------------------------------------------------------------------------------------------------------------------------------------------------------------------------------------------------------------------------------------------------------------------------------------------------------------------------------------------------------------------------------------------------------------------------------------------------------------------------------------------------------------------------------------------------------------------------------------------------------------------------------------------------------------------------------------------------------------------------------------------------------------------------------------------------------------------------------------------------------------------------------------------------------------------------------------------------------------------------------------------------------------------------------------------------------------------------------------------------------------------------------------------------------------------------------------------------------------------------------------------------------|-----------------|-----|-----------|-----------|-------------|-------------|--------------|-----------|--------------|
| 80241 | 88 Pc Punch & Chisel Display (SAE) (2 each) 70219 – 7/8" x 18" Cold Chisel 70221 – 1" x 12" Cold Chisel 70217 – 7/8" x 12" Cold Chisel 70213 – 3/4" x 12" Cold Chisel 70210 – 5/8" x 12" Cold Chisel 70206 – 1/2" x 9" Cold Chisel 70220 – 1" Cold Chisel 70216 – 7/8" Cold Chisel 70212 – 3/4" Cold Chisel 70209 – 5/8" Cold Chisel 70205 – 1/2" Cold Chisel 70204 – 7/16" Cold Chisel 70202 – 3/8" Cold Chisel 70201 – 5/16" Cold Chisel 70200 – 1/4" Cold Chisel 72003 – 1/4" Line-Up Punch 72012 – 3/16" Line-Up Punch 72011 – 5/32" Line-Up Punch 72010 – 1/8" Line-Up Punch 72021 – 3/32" x 8" Line-Up Punch 70301 – 3/8" x 6-1/2" Solid Punch 70105 – 5/16" x 6" Solid Punch 70003 – 1/4" Solid Punch 70002 – 3/16" Solid Punch 70005 – 5/32" x 5" Solid Punch 70001 – 1/8" Solid Punch 70000 – 3/32" x 5" Solid Punch 70004 – 1/16" x 5" Solid Punch 71105 – 3/8" x 6" Pin Punch 71019 – 5/16" Pin Punch 71005 – 1/4" Pin Punch 71004 – 3/16" Pin Punch 71003 – 5/32" Pin Punch 71002 – 1/8" Pin Punch 71001 – 3/32" Pin Punch 70000 – 1/16" Pin Punch 74004 – 5/8" Center Punch 74003 – 1/2" Center Punch 74002 – 3/8" Center Punch 74001 – 5/16" Center Punch 74000 – 1/4" Center Punch 73002 – 3/8" Prick Punch 73001 – 5/16" x 4-1/2" Prick Punch 73000 – Rivet Buster | 0 45256 80241 1 | N/A | N/A | N/A | N/A | N/A | N/A | 41.1 | Plastic Case |

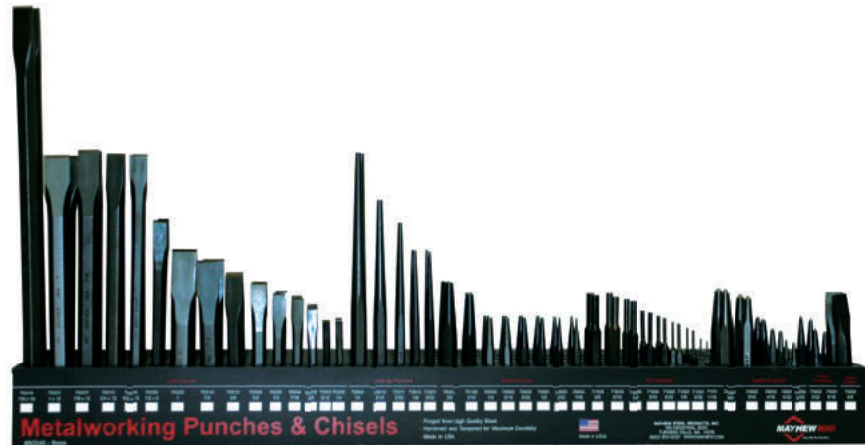

Chisels

Punches

Pry Bars

Handguarded

Specialty

Inspection

Sets and Kits

THE PROS KNOW



Quality. Dependability. Confidence. When the caliber of the tools is just as important as the skills of the professionals employed, businesses trust Mayhew to get the job done. Since 1856, our punches, chisels, and pry bars have been the go-to tools for OEMs and professional mechanics throughout the country. And while our company has grown to meet the needs of the professional market, as well as those of the do-it-yourself automotive enthusiast, our focus has never changed—leveraging our strength to build your business.

Since 1856





Since 1856



MayhewPro:

If this Mayhew hand tool ever fails to provide complete satisfaction, it will be replaced free of charge. Return product to original retailer for replacement.



MayhewSelect:

FOR TWO YEARS from the date of purchase, if this MayhewSelect hand tool ever fails to provide complete satisfaction, it will be replaced free of charge. Return product to original retailer with proof of purchase for replacement.

Exclusions

Warranties do not cover cables and cable assemblies, brass, hollow punches, lights, or batteries, which are expendable parts that can wear out from normal use within the warranty period.

MAYHEW STEEL PRODUCTS, INC.

199 Industrial Blvd.
Turners Falls, MA 01376 U.S.A.

U.S. Toll-Free: 1 800 872-0037
Phone: 1 (413) 863-4860
Fax: 1 (413) 863-8464

www.mayhew.com

ISO 9001:2008 certified

