

.4 hp Extension Die Grinder

Rear Exhaust, Governor-Controlled

Safety, Operation and Maintenance – Save This Document and Educate All Personnel

Model	Extension	RPM	Collets
43506	3" (76 mm)	25,000	1/4", 6 mm
43516	6" (152 mm)		

DIE GRINDER









43506

LIFETIME WARRANTY

Find The Most Current Offering of Support Documents and Accessories at www.Dynabrade.com

⚠ WARNING

Read and understand this tool manual before operating your air tool. Follow all safety rules for the protection of operating personnel as well as adjacent areas. Always operate, inspect and maintain this tool in accordance with the American National Standards Institute (ANSI). Safety Requirements for the Use, Care and Protection of Abrasive Wheels – ANSI B7.1, Compressed Air and Gas Institute (CAGI) Safety Code for Portable Air Tools – B186.1, Code of Federal Regulation – CFR 29 Part 1910, International Organization for Standardization (ISO) Hand Held Non-Electric Power Tools – Safety Requirements and applicable State and Local Regulations.

-  Read and understand tool manual before work starts to reduce risk of injury to operator, visitors, and tool.
-  Eye protection must be worn at all times, eye protection to conform to ANSI Z87.1.
-  Ear protection to be worn when exposure to sound, exceeds the limits of applicable Federal, State or local statutes, ordinances and/or regulations.
-  Respiratory protection to be used when exposed to contaminants that exceed the applicable threshold limit values required by law.
-  Practice safety requirements. Work alert, have proper attire, and do not operate tools under the influence of alcohol or drugs.
-  Air line hazard, pressurized supply lines and flexible hoses can cause serious injury. Do not use damaged, frayed or deteriorated air hoses and fittings.

Some dust created by sanding, grinding, drilling, and other construction activities contain chemicals known to cause cancer, birth defects or other reproductive harm. Some examples of these chemicals are:

- Lead from lead-based paints
- Crystalline silica from bricks and cement and other masonry products
- Arsenic and chromium from chemically treated lumber

Your risk from these exposures varies, depending on how often you do this type of work. To reduce your exposure to these chemicals: work in a well ventilated area, and work with approved safety equipment, such as those dust masks that are specially designed to filter out microscopic particles.

SAFETY and OPERATING INSTRUCTIONS

-  Carefully Read and Understand the General and Die Grinder sections found in Tool Safety and Operating Guidelines (PN00001676) Before Handling or Using Tool.
- Carefully Read all instructions before operating or servicing any Dynabrade® Abrasive Power Tool. Products offered by Dynabrade are not to be modified, converted or otherwise altered from the original design.

Tool Intent: Extension Die Grinders are ideal for applications with limited access when deburring, deflashing, surface preparation, cleaning and finishing using the proper abrasive stones, abrasive mounted wheels, molded abrasives, and carbide burrs (less than 2").

DO NOT USE Tool for Anything Other Than Its Intended Applications.

Training: Proper care, maintenance, and storage of your air tool will maximize tools performance and reduce chance for accident.

Employer's Responsibility: Provide operators with safety instructions and training for safe use of tools and accessories.

Report to Your Supervisor any Condition of the Tool, Accessories or Operation you Consider Unsafe.

MAINTENANCE INSTRUCTIONS

Important: To keep tool safe, a Preventative Maintenance Program is recommended. The program should include inspection of the tool and all related accessories and consumables, including air lines, pressure regulators, filters, oilers, etc. (refer to CAGI B186.1 for additional maintenance information). If accessory or tool breakage occurs, investigate failure to determine the cause and correct before issuing tool for work. Use the following schedule as a starting point in developing a Preventative Maintenance Program. If tool does not operate properly (RPM, vibration, start/stop) after these scheduled checks or at any time, the tool must be repaired and corrected before returning tool to use.

INSTALLATION

- To ensure long life and dependable service, use a Closed Loop Air System and Filter-Regulator-Lubricator (FRL) as diagramed below.
- Each tool should have its own dedicated hose connected to an air supply FRL. Quick disconnects should be installed at the FRL in an effort to reduce contamination into the tool. Securely affix all fittings and hose assemblies.
- It is strongly recommended that all Dynabrade rotary vane air tools be used with a Filter-Regulator-Lubricator to minimize the possibility of misuse due to unclean air, wet air or insufficient lubrication. Dynabrade recommends the following: **10681** Air Line Filter-Regulator-Lubricator — Provides accurate air pressure regulation, two-stage filtration of water contaminants and micro-mist lubrication of pneumatic components.
- Dynabrade recommends 1 drop of air lube per minute for each 20 SCFM (example: if the tool specification states 40 SCFM, set the drip rate on the filter-lubricator to 2 drops per minute). **95842** Dynabrade Air Lube is recommended.

MAINTENANCE SCHEDULE

Maintenance schedules depend on the type and style of tool. Refer to page 3 to reference symbols associated with specific maintenance items/areas. Match maintenance schedules accordingly. See page 4 for any additional maintenance information.

Note: Turbine style air motors do not require oil.

Daily (every 8 hours):

- Inspect tool and accessories for damage or broken parts. Replace items as necessary to ensure proper operation and safety.
- O** Lubricate motor as recommended. Use **95842** Dynabrade Air Lube (10W/NR). Apply 1 drop/minute of air lube per 20 SCFM.
- Check air line pressure with a gage. (MAX. 90 PSIG or 6.2 Bar operating pressure at the air inlet of the tool.)
- W** Lubricate wick system and right angle gears through gear case fitting. Apply 3 plunges of **95848** Gear Oil. Use **95541** Lubricant Gun (Prime lubricant gun before use).
- Check tool for proper operation: If operating improperly or demonstrates unusual vibration, the tool must be serviced and problem corrected before further use.

Every 20 Hours/Once a Week (which ever comes first):

- G** For tools without "wick system", lubricate right angle gears through lubricant fitting. Apply 1 plunge of **95542** Grease. Use **95541** Lubricant Gun. (Prime lubricant gun before use).
- Measure RPM (speed) by setting air pressure to 90 PSIG (6.2 Bar) at tool inlet, without accessory mounted, while the tool is running. Using

tachometer, check spindle speed of the tool. Unless otherwise stated the no-load speed may not exceed the rated speed. If tool speed exceeds maximum rated RPM, service as required and correct before use.

- If tool is running too fast: look for worn, damaged or missing governor, air control rings and silencer(s). Service as required.
- If tool is running too slow: look for malfunctioning governor, clogged inlet screen, silencer(s) or air stream. Service as required.

Note: Special care must be taken when servicing governors. Refer to specific tool manual for governor instructions and/or speed control devices. Governor assemblies made from molded plastic components are non-serviceable and must be replaced.

Every 50 Hours:

- G** Lubricate planetary gears through gear case fitting with 3 plunges of **95544** Grease. Use **95541** Lubricant Gun. (Prime lubricant gun before use).

REPAIR

- Use only genuine Dynabrade replacement parts to ensure quality. To order replacement parts, specify Model#, Serial# and RPM of your air tool.
- Mineral spirits are recommended when cleaning the tool and parts. Do not clean tool or parts with any solvents or oils containing acids, esters, ketones, chlorinated hydrocarbons or nitro carbons.
- A Motor Tune-Up Kit is available which includes high wear and medium wear motor parts.
- Air tool markings must be kept legible at all times, if not, reorder housing and replace. User is responsible for maintaining specification information.

- O** After maintenance is performed on tool, add a few drops of **95842** Dynabrade Air Lube to the tool inlet and start the tool a few times to lubricate air motor. Verify RPM (per 20 hr maintenance schedule), vibration and operation.

HANDLING & STORAGE

- Use of tool rests, hangers and/or balancers is recommended.
- Protect tool inlet from debris (see Notice below).
- Do Not** carry tool by air hose or near the tool throttle lever.
- Store accessories in protective racks or compartments to prevent damage.
- Follow the handling instructions outlined in the operating instructions when carrying the tool and when changing accessories.
- Protect accessories from exposure to water, solvents, high humidity, freezing temperature and extreme temperature changes.

END OF USE/DISPOSAL

When tool has reached its end of useful service, disassemble tool into its primary components (i.e. steel, aluminum and plastic) and recycle or discard per local, state and/or federal regulations as to not harm the environment.

NOTICE

All Dynabrade air motors use the highest quality parts available and are manufactured to exacting tolerances. Air motor failures are often traced to lack of lubrication or unclean air supply. Compressed air can force dirt and other contaminants into motor bearings causing early failure. Contaminants can score cylinder wall and vanes resulting in reduced efficiency and power. Our warranty obligation is contingent upon proper use of our tools. Air motors which have been subjected to misuse, contaminated air or lack of lubrication will void warranty.

CLOSED LOOP AIR SYSTEM

Sloped in Direction of Air Flow

- Dynabrade Air Power Tools are designed to operate at 90 PSIG (6.2 Bar) maximum air pressure at the tool inlet, when the tool is running. Use recommended regulator to control air pressure.
- Ideally the air supply should be free from moisture. To facilitate removing moisture from air supply, the installation of a refrigerated air dryer after the compressor and the use of drain valves at each tool station is recommended.

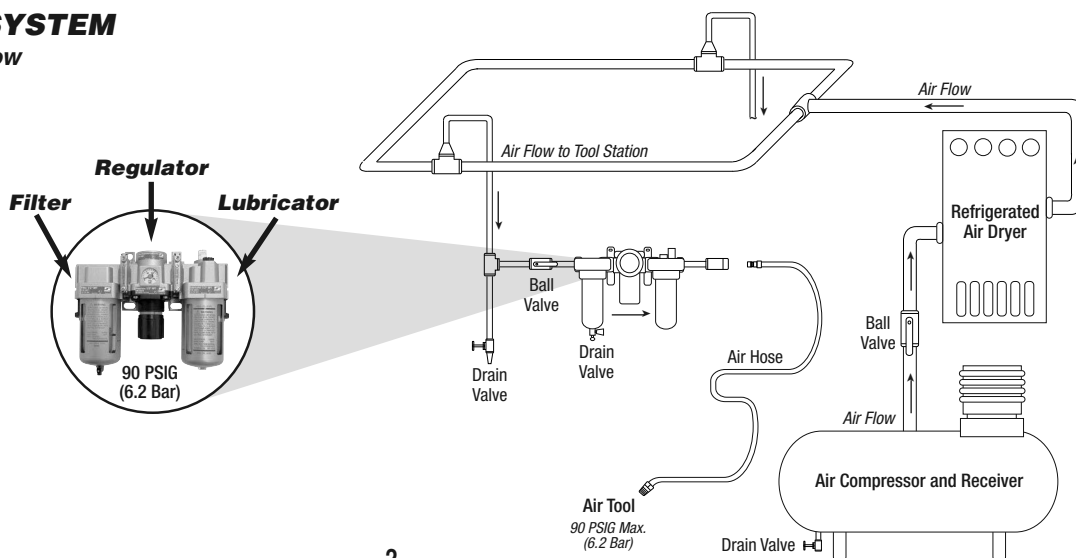

Lubricator Setting

1 Drop/Minute per 20 SCFM

Model
43506 3" Extension
43516 6" Extension

.4 hp Extension Die Grinder Complete Assembly

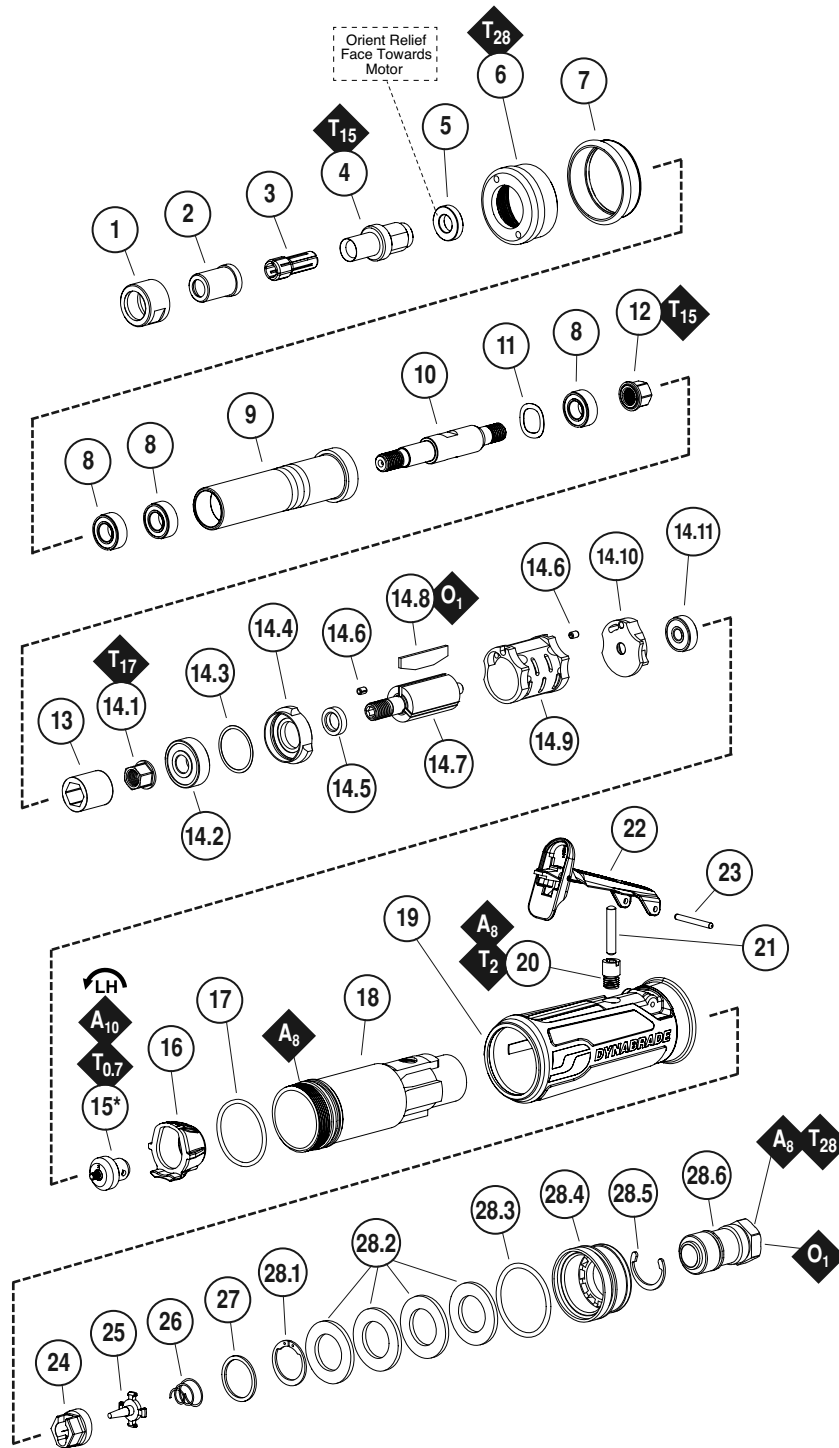

KEY	
O	Oil: O ₁ = Air Lube
A	Adhesive: A ₈ = Loctite #567 A ₁₀ = Loctite #243
T	Torque: N•m x 8.85 = lb•in.
T_x	X = Torque Value (N•m)
Always follow adhesive manufacturers cleaning and priming recommendations.	

ITEM	P/N	DESCRIPTION	QTY.
1	51098	COLLET NUT	1
2	51107	COLLET CAP	1
3	01485 01497	1/4" COLLET INSERT 6 MM COLLET INSERT	1
4	51105	COLLET BODY	1
5	43496	WASHER	1
6	43493	EXHAUST COVER	1
7	01547	COLLAR	1
8	51078	BEARING	3
9	43489 43499	3" EXTENSION HOUSING 6" EXTENSION HOUSING	1
10	43488 43498	3" EXTENSION SHAFT 6" EXTENSION SHAFT	1
11	98243	WAVE WASHER	1
12	43497	DRIVE NUT	1
13	43490	COUPLER	1
14	43491	MOTOR ASSEMBLY	1
14.1	43497	DRIVE NUT	1
14.2	02649	BEARING	1
14.3	54529	SHIM PACK (3/PKG)	AR
14.4	01478	FRONT BEARING PLATE	1
14.5	01479	SPACER	1
14.6	50767	PIN	2
14.7	45290	ROTOR	1
14.8	01480	VANE SET (4/PKG)	AR
14.9	01476	CYLINDER	1
14.10	02676	REAR BEARING PLATE	1
14.11	02696	BEARING	1
15*	45271	GOVERNOR ASSEMBLY	1
16	45320	GOVERNOR CHAMBER	1
17	96077	O-RING	1
18	45305	MOTOR HOUSING	1
19	09601 09603	3" HOUSING SLEEVE 6" HOUSING SLEEVE	1
20	45315	BUSHING	1
21	97045	PIN	1
22	45263	THROTTLE LEVER	1
23	97060	PIN	1
24	45310	SEAL	1
25	58365	TIP VALVE	1
26	01468	SPRING	1
27	01564	AIR CONTROL RING	1
28	94535	MUFFLER ASSEMBLY	1
28.1	01446	AIR DEFLECTOR	1
28.2	95620	RETAINING RING	1
28.3	95711	SNAP RING	1
28.4	96065	O-RING	1
28.5	01486	FELT SILENCER	4
28.6	01578	INLET ADAPTER	1
—	96031	7/16" WRENCH	1
—	96032	11/16" WRENCH	1

*Governors are non-serviceable.
 AR - "As Required"

LIFETIME WARRANTY

To validate Dynabrade Lifetime Warranty, you must register each tool at: www.dynabrade.com. Registration of each tool at website is required. Dynabrade will not honor Lifetime Warranty on unregistered tools. Please view the entire Lifetime Warranty Policy at : www.dynabrade.com.

**LIFETIME
WARRANTY**

MACHINE SPECIFICATIONS

Model	Speed	Power	Air Consumption	Collets	Weight	Length	Height
43506	25,000 RPM	.4 hp (298 W)	20 SCFM (566 LPM)	1/4", 6 mm	1.3 lb. (0.6 kg)	9.5" (242 mm)	1.5" (39 mm)
43516	25,000 RPM	.4 hp (298 W)	20 SCFM (566 LPM)	1/4", 6 mm	1.7 lb. (0.75 kg)	12.5" (318 mm)	1.5" (39 mm)

Additional Specifications: Air Inlet Thread 1/4" NPT • Hose I.D. 1/4" (6 mm)

Visit dynabrade.com for your model's current vibration and sound data.

OPTIONAL ACCESSORIES



Motor Tune-Up Kit

- Includes assorted parts to help maintain and repair motor.

Part No. 96541



Overhose Assembly

- Redirects exhaust away from operator.

Part No. 53599



Dynabrade Air Lube

- Formulated for pneumatic equipment.
- Absorbs up to 10% of its weight in water.
- Prevents rust and formation of sludge.
- Keeps pneumatic tools operating longer with greater power and less down time.

Part No. 95842: 1 pt. (473 ml)

Part No. 95843: 1 gal. (3.8 L)



Dynaswivel®

- Swivels 360° at two locations which allows an air hose to drop straight to the floor, no matter how the tool is held.

Part No. 94300: 1/4" NPT

SPECIAL REPAIR TOOLS

Special repair tools are required for disassembly and assembly of this tool. Visit dynabrade.com for your model specific complete information.

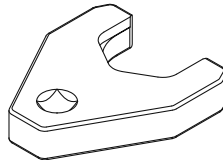

REFERENCE CONTACT INFORMATION

American National Standards Institute (ANSI)

25 West 43 Rd St., 14th Floor • New York, NY 10036 • Tel: 1 (202) 293-8020

Compressed Air & Gas Institute

1300 Sumner Ave. • Cleveland, OH 44115-2851

Tel: 1 (216) 241-7333 • Fax: (216) 241-0105

European Committee for Standardization

Rue de Stassart 36 • B - 1050 Brussels, Belgium

International Organization of Standards

Case postale 56 • CH-1211 Geneva 20

Tel: + 41 22 749 01 11 • Fax: + 41 22 749 09 47

Government Printing Office

Superintendent of Documents • Attn: New Orders

P.O. Box 371954 • Pittsburgh, PA 15250-7954

Tel: 1 (202) 512-1803

DYNABRADE, INC.

8989 Sheridan Drive • Clarence, NY 14031-1419 • Phone: 716-631-0100 • Fax: 716-631-2073 • International Fax: 716-631-2524

©DYNABRADE, INC., 2016

www.dynabrade.com

