

Leveling Jacks

For Precision Machine Leveling and Support



Ensure Consistent Stability and Optimal Machine Performance

Quality Features:

- Increase Machine Efficiency
- Reduce Vibration and Noise
- Extend Machine Life
- Automatically Compensate for Uneven Floors
- Easily Adjustable to Suit Any Workplace

Ideal for use with:

- Boring machines
- CNC Machines
- Cut-Off Saws
- Electrical Discharge Machines
- Gantry Machines
- Generators
- Grinders
- Injection Molders
- Lathes
- Machining Centers
- NC Drilling Machines
- Planer Mills
- Robots
- Roll Grinders
- Transfer Mills
- Much More!

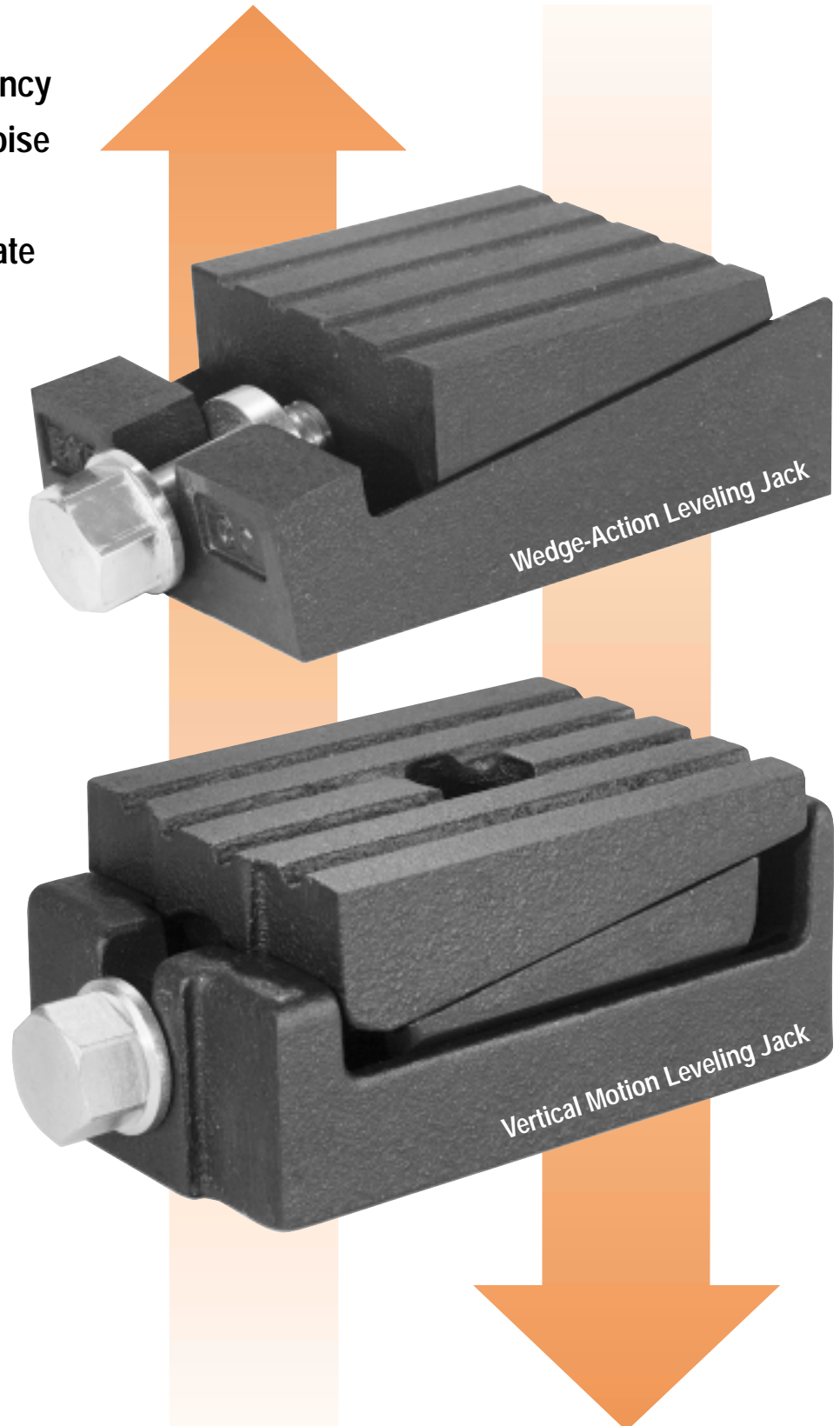

DYNABRADE Leveling Jacks

For Precision Machine Leveling and Support

Protect your most important investment – your company machinery – with Dynabrade Leveling Jacks

Solid, easily adjustable, simple and efficient, **Dynabrade Leveling Jacks** are utilized throughout the world for leveling and supporting weights of up to 30,000 pounds (13,620kg). Offered in two styles, **Wedge-Action** and **Vertical Motion**, **Dynabrade Leveling Jacks** provide consistent stability while ensuring optimal machine performance!

Features:

- Compact, lightweight design
- Self-aligning base automatically compensates for uneven floor
- Grooved top allows oils and liquids to run out; also helps dissipate vibration
- Black oxide finish resistant to corrosion and rust
- Easy adjustment with hand-held wrench
- Virtually indestructible, **Dynabrade Leveling Jacks** will dramatically increase the efficiency and life of your machinery!

Optional Features:

- Vibration and noise are both reduced as your machinery is leveled and supported by **Dynabrade Leveling Jacks**, when used in conjunction with **Vibration-Absorbing Mounting Pads** (see page 4).

All Leveling Jacks

Lower surface of wedge is specially contoured to float laterally within concave base unit, automatically compensating for uneven floor conditions up to 5 degrees of slope.

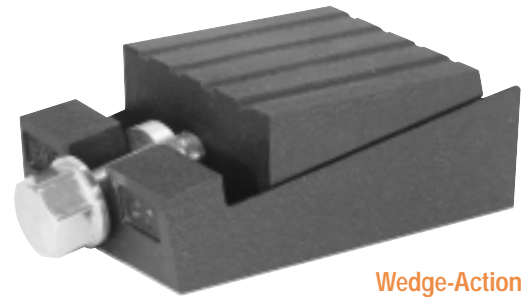
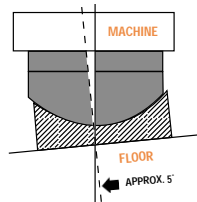

Wedge-Action Leveling Jack

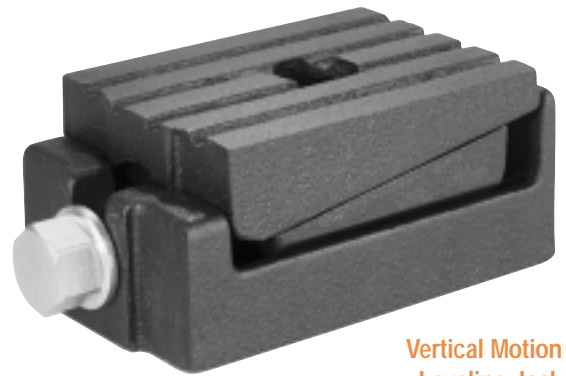

Vertical Motion Leveling Jack

WEDGE-ACTION Leveling Jacks

A significant improvement over conventional wedge-action devices, the **Dynabrade Wedge-Action Leveling Jack** is a two-piece design that provides solid support from 3,000 to 9,000 pounds (1,362 kg to 4,086 kg).

- This is a low profile leveling jack that is ideal for applications constricted by reduced height. All models have a **self-aligning base** that automatically compensates for uneven floor levels, correcting inconsistencies of up to 5 degrees. Wedge action allows easy adjustment of height (1/4" - 3/8" / 6 mm - 10 mm) with the turn of a wrench.

Dynabrade Wedge-Action Leveling Jacks are available separately, and with **Vi-Sorb** Mounting Pad included. See chart on page 4 for details.

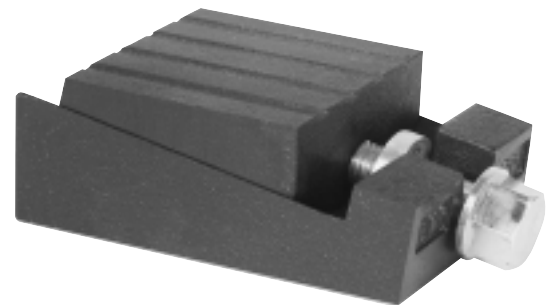

Wedge-Action Leveling Jack

Wedge-Action Leveling Jack Models

Leveling Jack Model No.	Recommended Max. Lifting Weight	Rise Inch (mm)	Dimension Height x Width x length	Weight Pounds (kg)
60200	3,000 lbs. (1,362 kg)	1/4 (6)	1-1/8" x 3-1/2" x 6" (29 mm x 89 mm x 152 mm)	5 (2.3)
60201	9,000 lbs. (4,032 kg)	3/8 (10)	2-1/4" x 3-1/2" x 6" (57 mm x 89 mm x 152 mm)	11 (5)

Note: See page 4 for complete Assemblies including: a Leveling Jack w/ ViSorb Pad in 3 different sizes (1/4", 1/2" or 3/4").

VERTICAL MOTION Leveling Jacks

Dynabrade Vertical Motion Leveling Jacks combine the advantages of a wedge-action jack with vertical lift capabilities, in one unique and practical unit. Easily supporting up to 30,000 pounds (13,620 kg), this is the mightiest leveling jack in the industry!

- **Vertical Motion leveling Jacks** may be used with or without anchor bolts, depending upon installation. When anchor bolts are used, they pass through the entire assembly without interfering with the leveling action. Once again, easy alignment is achieved with only a hand wrench!

Dynabrade Vertical Motion leveling Jacks are available separately, and with Vi-Sorb or Vi-Damp II Mounting Pad included. See chart on page 4 for details.



Vertical Motion Leveling Jack

Vertical Motion Leveling Jacks

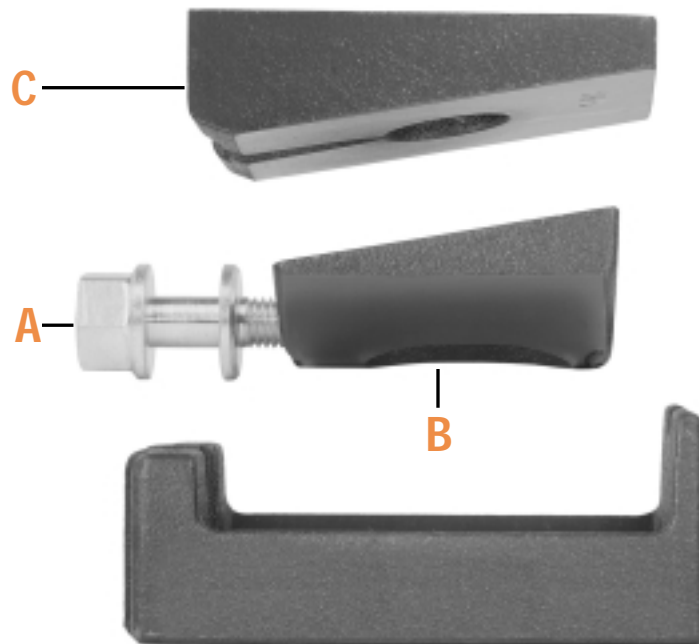

There is no lateral stress or shifting with the **Vertical Motion Jack**. It converts horizontal movement into vertical lift by means of two interfacing planes. As hex head lift screw (A) is turned, the lower wedge (B) slides forward against the included plane of the top plate (C), causing it to rise vertically in a smooth positive manner!

Vertical Motion Leveling Jack Models

Leveling Jack Model No.	Recommended Max. Lifting Weight	Rise Inch (mm)	Dimension Height x Width x length	Weight Pounds (kg)	Anchor Bolt Hole
60202	15,000 lbs. (6,804 kg)	3/16 (2)	2-3/8" x 3-1/2" x 6" (63 mm x 89 mm x 152 mm)	11 (5)	1" Dia. (13 mm)
60203	20,000 lbs. (9,072 kg)	1/4 (6)	2-3/4" x 3-1/2" x 6" (70 mm x 89 mm x 152 mm)	14 (5)	1-1/8" Dia. (14 mm)
60204	30,000 lbs. (13,608 kg)	1/4 (6)	2-3/4" x 3-1/2" x 6" (70 mm x 89 mm x 152 mm)	14 (5)	1-1/8" Dia. (14 mm)

Note: See page 4 for complete Assemblies including: a Leveling Jack w/ ViSorb Pad or ViDamp II Pad in 3 different sizes (1/4", 1/2" or 3/4").

VIBRATION-ABSORBING Mounting Pads

The use of **Vibration-Absorbing Mounting Pads** in conjunction with **Dynabrade Leveling Jacks** is recommended, to reduce the damaging effects of vibration. Utilizing a unique design, these pads offer vibration-absorbing capacity of up to **90%**!

Features:

- **Vibration-Absorbing Mounting Pads** are offered in three thicknesses: 1/4", 1/2" and 3/4" (6 mm, 13 mm and 19 mm). Each successive thickness provides increased vibration protection (see chart). All pads are sized to perfectly fit **Dynabrade Leveling Jacks**.
- In addition, **Mounting Pads** reduce the transmission of internal machine noise to the building structure, and dissipate transmitted vibrations from one machine to another. In many cases they also eliminate the need for anchor bolts by stopping machine creepage. Pads are resistant to oil, grease and acids. They resist breakdown under load and over time.

Vi-Sorb Pad

Pad Thickness	Percentage Vibration Reduction
1/4" (6 mm)	43%
1/2" (13 mm)	74%
3/4" (19 mm)	80%

Vi-Damp II Pad

Pad Thickness	Percentage Vibration Reduction
1/4" (6 mm)	48%
1/2" (13 mm)	79%
3/4" (19 mm)	90%

Vi-Sorb Pads

- Provide basic vibration reduction. Available with all models of **Dynabrade Leveling Jacks**, and also sold separately (see chart).



Vi-Sorb Pad

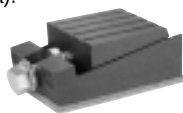

Wedge-Action Leveling Jack w/ Vi-Sorb Pad

Vi-Sorb Pads (only)

For Leveling Jack Model No.	1/4" Pad (6 mm)	1/2" Pad (13 mm)	3/4" Pad (19 mm)
60200/60201	91969	91978	91885
60202	91966	91965	91886
60203/60204	91968	91967	91984

Vi-Damp II Pads

- With innovative polymer construction that affords increased vibration reduction at heavier weights. Available with **Dynabrade Leveling Jacks** of 15,000-30,000 pound capacity (6,810-13,620 kg). Highly recommended! Also sold separately (see chart).



Vi-Damp II Pad



Vertical Motion Leveling Jack w/ Vi-Damp II Pad

Vi-Damp II Pads (only)

For Leveling Jack Model No.	1/4" Pad (6 mm)	1/2" Pad (13 mm)	3/4" Pad (19 mm)
60200/60201	N/A	N/A	N/A
60202	91962	91961	91887
60203/60204	91964	91963	91988

Leveling Jack and Pad Assemblies

Leveling Jack (only) Model No.	Leveling Jack (w/ Vi-Sorb Pad Included)			Leveling Jack (w/ Vi-Damp II Pad Included)		
	1/4" (6 mm) Pad	1/2" (13 mm) Pad	3/4" (19 mm) Pad	1/4" (6 mm) Pad	1/2" (13 mm) Pad	3/4" (19 mm) Pad
60200	60205	60206	60207	N/A	N/A	N/A
60201	60208	60209	60210	N/A	N/A	N/A
60202	60211	60212	60213	60217	60218	60229
60203	60214	60215	60216	60219	60220	60231
60204	60230	60221	60232	60233	60234	60235



DYNABRADE, INC.

8989 Sheridan Drive • Clarence, New York 14031-1490 • Phone: (716) 631-0100
Fax: 716-631-2073 • US Consumers Call Toll Free: 1-800-828-7333

DYNABRADE INTERNATIONAL

8989 Sheridan Drive • Clarence, New York 14031-1490 • Phone: (716) 631-0100
Fax: 716-631-2524 • Canadian Consumers Call Toll Free: 1-800-344-1488

DYNABRADE EUROPE S.à r.l.

Zone Artisanale • L-5485 Wormeldange—Haut, Luxembourg
Telephone: 352 76 84 94 1 • Fax: 352 76 84 95 1

DISTRIBUTED BY:

Try Our U.S. Consumer Toll Free Number: 1-888 DYNABRADE (or 1-800-828-7333)