



GEARWRENCH®

GET IT DONESM



PRODUCT CATALOGUE APRIL 2015

MASTER SETS | TOOL STORAGE | RATCHETS, SOCKETS & DRIVE TOOLS | IMPACT SOCKETS |
WRENCHES | TORQUE WRENCHES | SCREWDRIVERS | PLIERS | CUTTING & FILING |
STRIKING & STRUCK | PRY BARS | AUTOMOTIVE SPECIALTY | TRADE TOOLS



GEARWRENCH BOOSTS MECHANICS PRODUCTIVITY

GearWrench sets the new standard for productivity in the work place with tools that excel in Speed, Strength and Access. The GearWrench program includes a full line of mechanical hand tools and is trusted by professional mechanics all around the globe. Guaranteed with a life time warranty, GearWrench brings you high quality tools that allow you to get the job done faster!

GearWrench has received numerous industry awards for producing productivity enhancing tools such as Ratcheting Wrenches, Pass-Thru™ Sockets, Indexing Pry Bars and Magnetic Oil Drain Plug Sockets to name a few. GearWrench continues to develop tools which maximise productivity.

Lifetime Warranty: GearWrench has a long tradition in the development of reliable product solutions for the automotive industry, where top quality standards and optimum value are the ultimate priorities. All GearWrench products come complete with a lifetime warranty.



SPEED

GearWrench understands the need for speed. It's not about showing off; it's about getting more done. It's about shaving valuable seconds off tasks that get repeated hundreds of times each day. For the pro, those seconds add up.

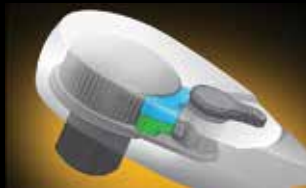

STRENGTH















Professional hand tools need to be strong in order to provide years of reliable service. GearWrench tools are tough and reliable, meeting or exceeding recognized industry standards.



ACCESS

Every job is different, but you can always count on obstructions and tight spaces. GearWrench offers a wide selection of wrenches and other tools designed to get the job done, even in cramped, hard-to-reach areas.

TABLE OF CONTENTS

TOOL SETS	9	
CABINETS & STORAGE	20	
MODULAR STORAGE SYSTEM	28	
RATCHETS, SOCKETS AND DRIVE TOOLS	36	
BIT SOCKETS AND FLEX HEX™ KEYS	75	
IMPACT SOCKETS	79	
WRENCHES	86	
TORQUE WRENCHES	126	
SCREWDRIVERS AND NUTDRIVERS	130	
PLIERS	136	
PRY BARS	142	
STRIKING AND STRUCK TOOLS	146	
RATCHETING TAPS AND DIES	149	
AUTO SPECIALTY AND MISCELLANEOUS TOOLS	153	
INDEX	170	
TERMS AND CONDITIONS	179	
CUSTOMER SUPPORT	180	

GEARWRENCH®

THE EVOLUTION OF INNOVATION

GearWrench started in 1996, when we developed a ratcheting wrench that stood up to professional environments – the “Original” combination ratcheting wrench.

Noticing the need for more ratcheting options, we quickly expanded to stubby and double box as these were traditional non-ratcheting wrench configurations.

The Reversible and Flex style wrenches were born from user feedback, with an eye for how to work in tight spaces.

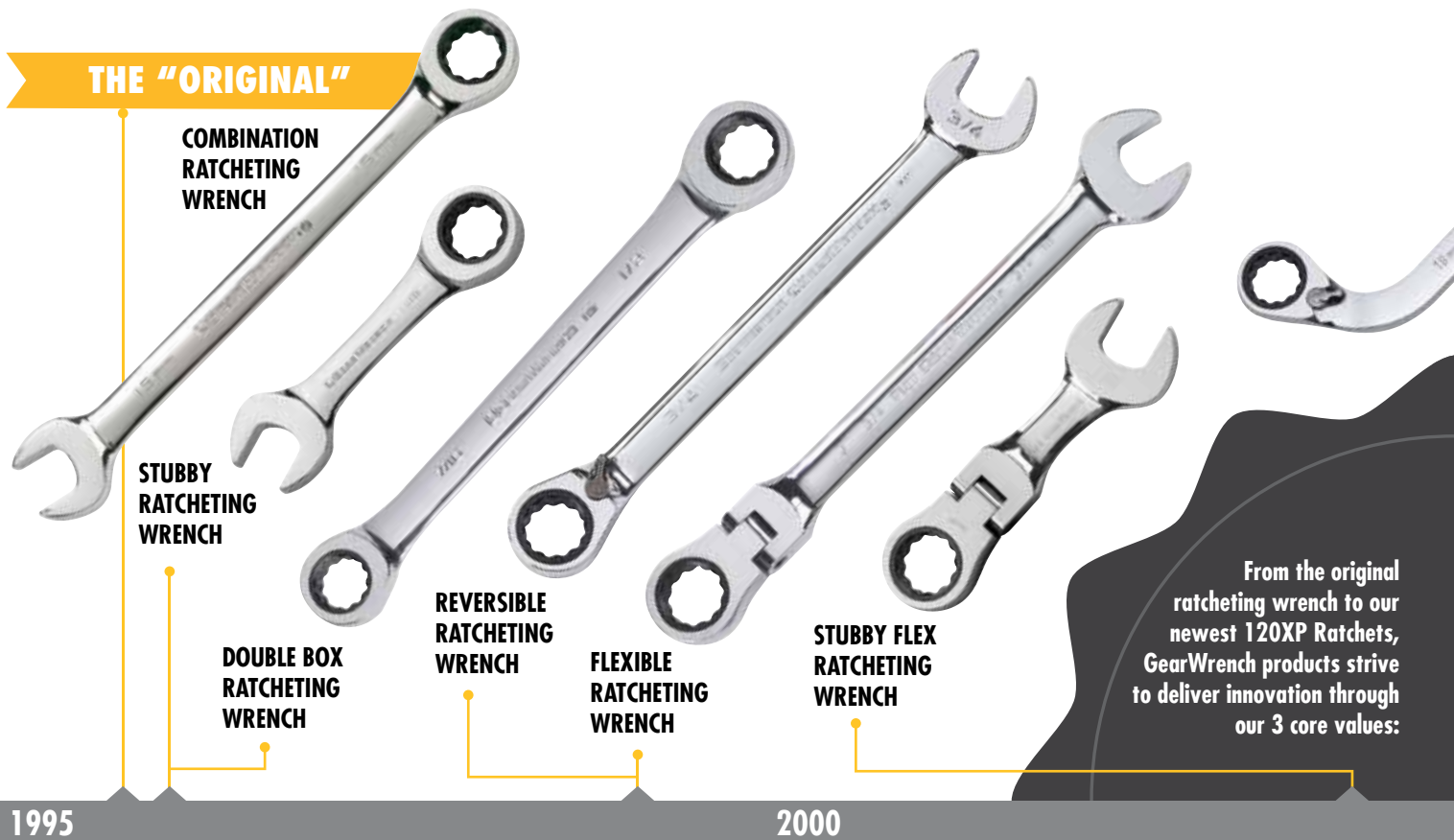

THE “ORIGINAL”

COMBINATION RATCHETING WRENCH

STUBBY RATCHETING WRENCH

DOUBLE BOX RATCHETING WRENCH

REVERSIBLE RATCHETING WRENCH

FLEXIBLE RATCHETING WRENCH

STUBBY FLEX RATCHETING WRENCH

From the original ratcheting wrench to our newest 120XP Ratchets, GearWrench products strive to deliver innovation through our 3 core values:

1995

2000



GEARRATCHET VORTEX SOCKET SYSTEM



GEARDRIVER INTERCHANGABLE SHAFT SYSTEM

As more professionals began to use ratcheting wrenches, we spent time solving more access problems and introducing other wrench styles.

Having success in wrenches, we began to integrate ratcheting mechanisms into screwdrivers and other traditionally non-ratcheting tools.

GearWrench has continued to innovate products by adding productivity features to products like pry bars, hemostats, tool boxes, and ratchets.

SPEED STRENGTH ACCESS

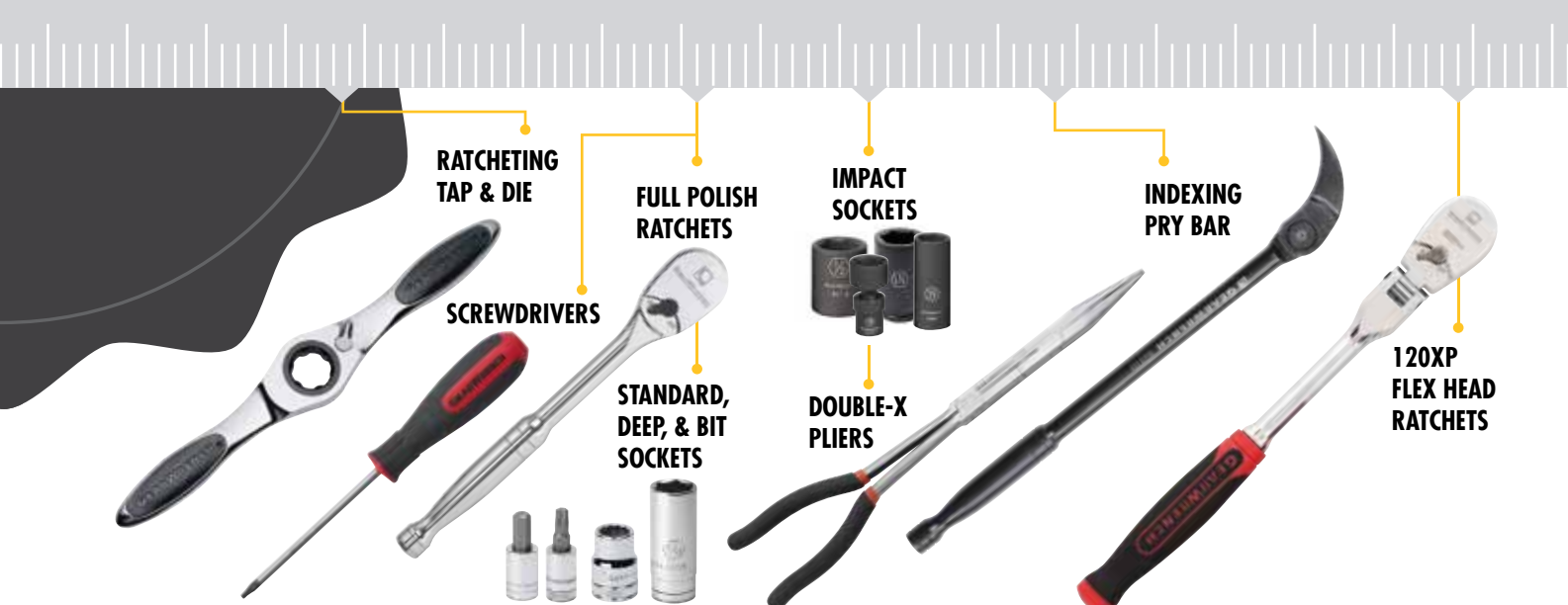
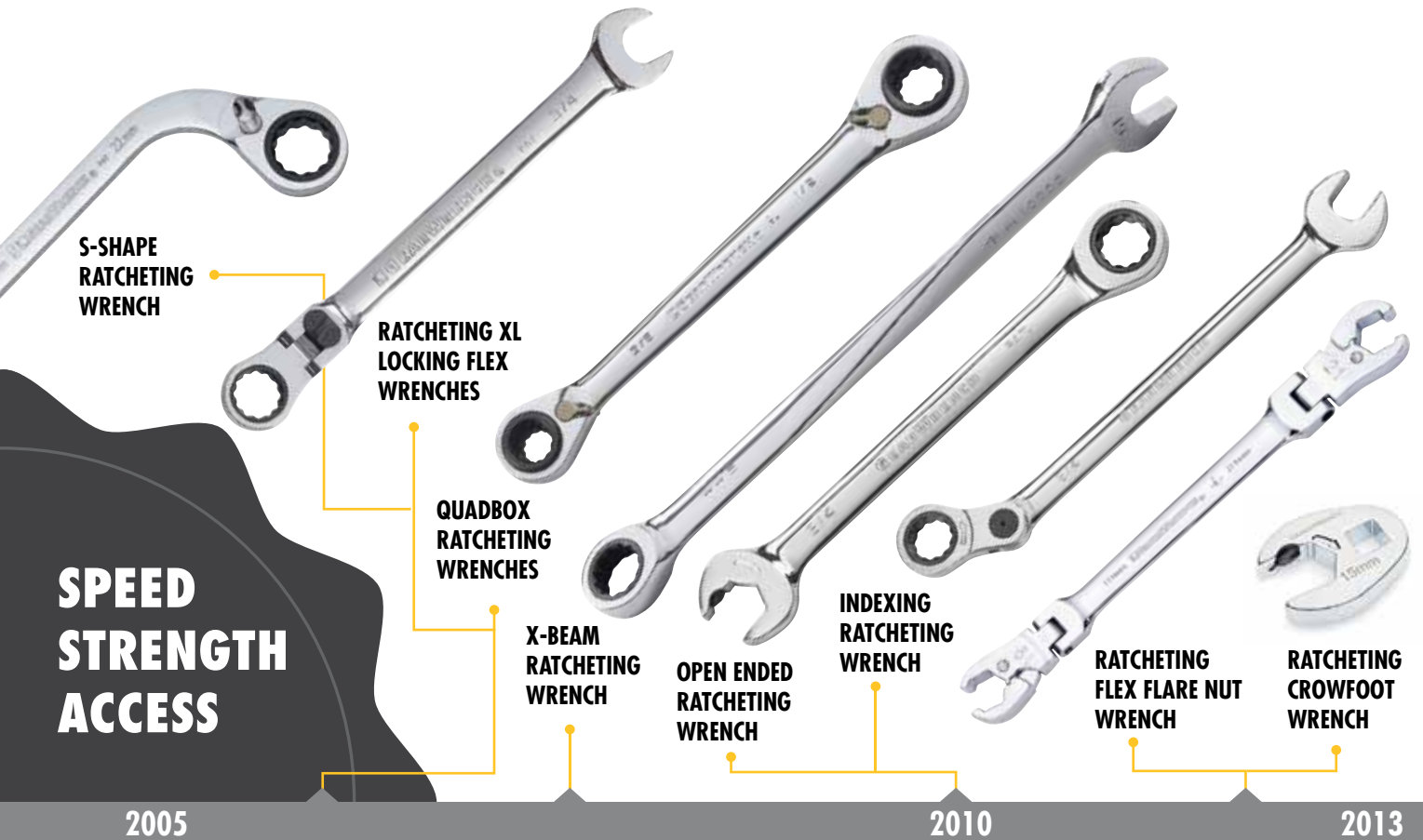



GIMBAL RATCHETS PIVOTING RATCHETING MECHANISM



THE PIVOTING RATCHET MECHANISM ALLOWS YOU TO DETERMINE YOUR OWN ANGLE

■ **SPEED**

72-tooth ratcheting mechanism gives a 5° ratcheting arc allowing you to quickly tighten or loosen fasteners.

■ **STRENGTH**

The ratchet head design exceeds industry standards for torque performance.

■ **ACCESS**

Gimbal design allows the ratchet to rotate on two planes for easier access.



WATCH THE VIDEO



120XP RATCHETS FIXED AND FLEX HEADS



ACCESS TO THE NEXT LEVEL WITH THE 120XP 3° ARC RATCHETS

■ **SPEED**

The Gear is alternately engaged by the double-stacked pawl which gives a 3° swing arc for faster work.

■ **STRENGTH**

Double-stacked pawls engage a 60-tooth gear providing exceptional strength, exceeding industry standards for torque performance.

■ **ACCESS**

Low profile head and flush mounted on/off switch and longer handle allowing better access. 6 Positions flex head for adjustable access angle.





WATCH THE VIDEO

PIVOT FORCE COMPOUND ACTION PLIERS

PIVOTFORCE

REQUIRES 40% LESS EFFORT TO CUT THAN STANDARD PLIERS

■ **SPEED**

Unique Compound Action Design requires 40% less effort to cut, so it is easier and quicker.

■ **STRENGTH**

PivotForce pliers exceed industry standards for cut testing requirements and maintain sharp cutting edges.

■ **ACCESS**

Long nose design allows access in confined spaces.



RATCHETING FLEX FLARE NUT WRENCHES

UNPARALLELED ACCESS TO THE MOST HARD-TO-REACH FLARE NUTS

■ **SPEED**

Quickly ratchet and bolts without removing the wrench from the fastener.

■ **STRENGTH**

The ratcheting flex flare nut design exceeds industry standards for strength requirements.

■ **ACCESS**

Flex head can be positioned through 180° to access hard to reach nuts, and the open end flare nut head slips easily over lines.



WATCH THE VIDEO

GEARWRENCH MOTORSPORTS AUSTRALASIA

GearWrench products in the Australasian market are backed and supported by an exciting motorsport program including the V8 Supercars and V8 Ute Series. The V8 Supercars involves a partnership with leading V8 Supercars Team, Triple8 Racing and Red Bull Racing Australia. Not only do the race teams put the Gearwrench tools to the test in the most arduous of environments, but they bring the excitement and energy of the GearWrench brand to the market through innovative promotions and events.



Official Tool Supplier To
Red Bull Racing Australia



Red Bull
RACING
AUSTRALIA



THE Evolution OF Innovation

WEBSITE & FACEBOOK

Visit www.gearwrench.com.au website for the latest product reviews, how to videos, product dimensions, specifications and images, which can be downloaded in high resolution. Consumers can also find their nearest GearWrench stockist via our store finder. For the entire GearWrench range visit the USA website www.gearwrench.com. To keep up to date with the latest Gearwrench new products and events, like us on Facebook - Gearwrench AU.

- Product videos
- Australian Customer Service Line
- Get product dimensions and specifications
- Nearest store
- Get images and other product details
- Get catalogues
- Participate in Competitions



TOOL SETS

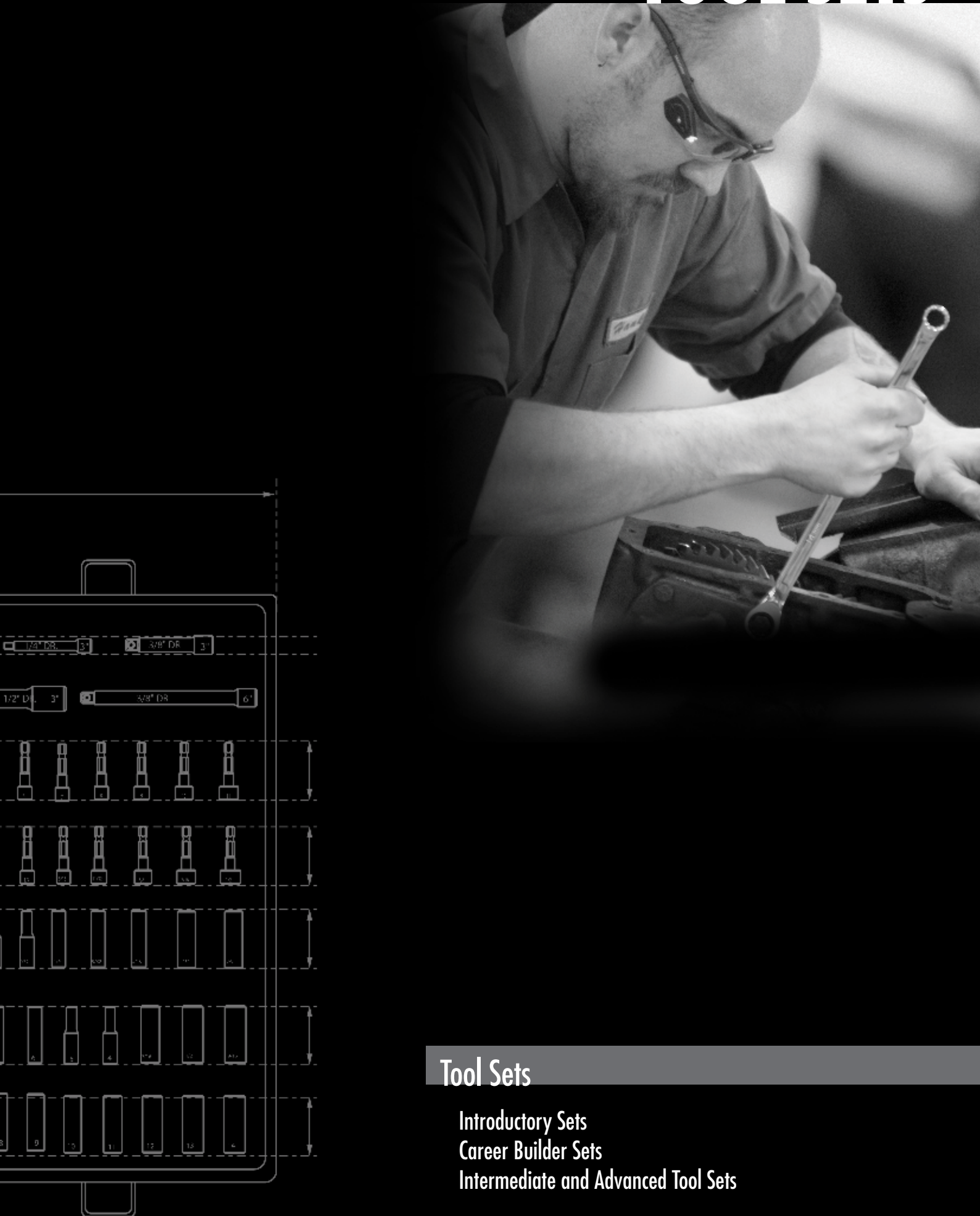

Tool Sets

Introductory Sets
Career Builder Sets
Intermediate and Advanced Tool Sets

GearWrench® Tool Sets feature carefully designed sets to fully equip the Student Technician with the tools necessary to conquer the service and repair challenges in today's Automotive, Heavy Duty/Diesel, Machinery, and Aviation fields.

Each tool set features innovations in speed, access, and design; hallmarks that have established the GearWrench® brand as a leader in quality, professional hand tools.

Each Tool Set also includes storage for sockets, wrenches, screwdrivers, and other tools to help promote efficient tool organization.



GearWrench® understands the environment you work in because we work side-by-side with technicians to learn about frustrations firsthand, and develop innovative, new hand tools to solve day-to-day problems. We know you will make a living with your tools and you need just the right tools to help you work smarter and faster. Across various tool categories, we deliver superior products that do just that. Our commitment to delivering the most durable and reliable products while adding time-saving features makes this possible.



83090T - Auto Introductory Set
SAE/METRIC RRP \$749.00

81658	5/8"	81670	13mm
81659	11/16"	81671	14mm
81660	3/4"	81672	15mm
81661	13/16"	81673	16mm
81662	7/8"	81674	17mm
81663	15/16"	81675	18mm
81664	1"	81676	19mm
81665	8mm	81677	20mm
81666	9mm	81678	21mm
81667	10mm	81679	22mm

Screwdrivers and Pliers

80050	6 Pc. Combination Screwdriver Set
80015	1/8" x 3" Slotted w/Cabinet Tip
80013	1/4" x 4" Slotted w/Hex Bolster
80023	5/16" x 6" Slotted w/Hex Bolster
80022	3/8" x 8" Slotted w/Hex Bolster
80001	#1 x 3" Phillips
80007	#2 x 4" Phillips w/Hex Bolster

82104 3 Pc. Mixed Pliers Set

82011	9.5" Tongue and Groove
82012	7" Diagonal Cutting
82013	8" Long Nose

Hex Keys

56603G 13 Pc. SAE ALLEN® Hex Key Set
 Sizes: 0.050", 1/16", 5/64", 3/32", 7/64", 1/8", 9/64", 5/32", 3/16", 7/32", 1/4", 5/16", 3/8"

Punches and Chisels

82304	5 Pc. Punch and Chisel Set
82270	3/8" x 5" Center Punch
82273	1/8" x 5" x 5/16" Pin Punch
82274	5/32" x 5-1/4" x 5/16" Pin Punch
82275	3/16" x 5-1/2" x 5/16" Pin Punch
82264	1/2" x 6" x 3/8" Cold Chisel

General Purpose Tools

82251	16 oz. Ball Pein Hammer - Fiberglass
82260	12 oz. Softface Hammer Removable Caps
WKF1	Folding Utility Knife
83132	Aluminum Flashlight
82041	10" Curved Jaw Locking Pliers
69-990	Safety Glasses

KD® Specialty Tools

KDS129	Low Voltage Circuit Tester
KDS162	16 Blade Feeler Gauge
KDS485	Gasket Scraper

Tool Storage

83130	Tote Box
-------	----------

Not all tools GearWrench® Branded

1/4" Drive Sockets

80302	13 Pc. 6 Pt. Metric Socket Set		
80125	4mm	80132	10mm
80126	5mm	80133	11mm
80127	5.5mm	80134	12mm
80128	6mm	80135	13mm
80129	7mm	80136	14mm
80130	8mm	80137	15mm
80131	9mm		
80303	10 Pc. 6 Pt. SAE Socket Set		
80105	3/16"	80110	11/32"
80106	7/32"	80111	3/8"
80107	1/4"	80112	7/16"
80108	9/32"	80113	1/2"
80109	5/16"	80114	9/16"

1/4" Drive Tools

81011	Full Polish Ratchet
81113	3" Extension
81116	6" Extension
81128	Spinner Handle

3/8" Drive Sockets

80552	14 Pc. 6 Pt. Metric Socket Set		
80374	6mm	80381	13mm
80375	7mm	80382	14mm
80376	8mm	80383	15mm
80377	9mm	80384	16mm
80378	10mm	80385	17mm
80379	11mm	80386	18mm
80380	12mm	80387	19mm
80553	13 Pc. 6 Pt. SAE Socket Set		
80350	1/4"	80357	11/16"
80351	5/16"	80358	3/4"

80352	3/8"	80359	13/16"
80353	7/16"	80360	7/8"
80354	1/2"	80361	15/16"
80355	9/16"	80362	1"
80356	5/8"		

3/8" Drive Tools

81211	Full Polish Teardrop Ratchet
81241	3" Extension
81242	6" Extension
80549	Universal Joint
80402	5/8" Spark Plug Socket
80403	13/16" Spark Plug Socket

Combination Wrenches

81900	24 Pc. SAE/Metric Long Pattern Combination Non-Ratcheting Wrench Set		
81656	1/2"	81668	11mm
81657	9/16"	81669	12mm

Note: Individual materials may not be available for separate purchase.
 *As part of our continuous improvement process, items shown may be substituted for items of equal or greater value.

For full range of tool sets and storage solutions go to www.gearwrench.com.au



83091T - Career Builder Starter Set

RRP \$1259.00

Combination Wrenches

81901 15 Pc. SAE Long Pattern Non-Ratcheting Wrench Set

1/4", 9/32", 5/16", 11/32", 3/8", 7/16", 1/2", 9/16", 5/8", 11/16", 3/4", 13/16", 7/8", 15/16", 1"

81902 15 Pc. Metric Long Pattern Non-Ratcheting Wrench Set

8, 9, 10, 11, 12, 13, 14, 15, 16, 17, 18, 19, 20, 21, 22mm

Screwdrivers and Pliers

80051 12 Pc. Combination Screwdriver Set

80012 1/4" x 1-1/2" Slotted

80018 3/16" x 6" Slotted w/ Cabinet Tip

80013 1/4" x 4" Slotted w/Hex Bolster

80014 1/4" x 6" Slotted w/Hex Bolster

80023 5/16" x 6" Slotted w/Hex Bolster

80022 3/8" x 8" Slotted w/Hex Bolster

80000 #0 x 2-1/2" Phillips

80001 #1 x 3" Phillips

80004 #1 x 6" Phillips

80005 #2 x 1-1/2" Phillips

80007 #2 x 4" Phillips w/Hex Bolster

80011 #3 x 6" Phillips w/Hex Bolster

82103 4 Pc. Mixed Pliers Set

82011 9.5" Tongue and Groove

82012 7" Diagonal Cutting

82013 8" Long Nose

82014 8" Slip Joint

Hex Keys

56612G 13Pc. SAE ALLEN® Ball End Hex Key Set

Sizes: 0.050", 1/16", 5/64", 3/32", 7/64", 1/8", 9/64", 5/32", 3/16", 7/32", 1/4", 5/16", 3/8"

56615G 9Pc. Metric ALLEN® Ball End Hex Key Set

Sizes: 1.5, 2, 2.5, 3, 4, 5, 6, 8, 10mm

Files, Punches & Chisels

82820 4 Pc. STD File Set

82822 8" Flat

82823 8" Round

82824 8" Half Round

82825 8" Triangle

82305 12 Pc. Punch and Chisel Set

82261 1/4" x 4-3/4" x 1/4" Cold Chisel

82262 3/8" x 5" x 5/16" Cold Chisel

82264 1/2" x 6" x 3/8" Cold Chisel

82265 5/8" x 6-1/2" x 3/8" Cold Chisel

82270 3/8" x 5" Center Punch

82272 3/32" x 4-3/4" x 5/16" Pin Punch

82273 1/8" x 5" x 5/16" Pin Punch

82274 5/32" x 5-1/4" x 5/16" Pin Punch

82275 3/16" x 5-1/2" x 5/16" Pin Punch

82278 1/8" x 8" x 3/8" Long Taper Punch

82283 3/16" x 5" x 3/8" Starter Punch

82285 1/8" x 4-1/2" x 5/16" Starter

General Purpose Tools

82216 16" Indexing Pry Bar

82880 High Tension Hack Saw

82251 16 oz. Ball Pein Hammer - Fiberglass

82260 12 oz. Softface Hammer Removable Caps

82255 3 lb. Drilling Hammer

82259 16 oz. Rubber Mallet-Wood Hickory Handle

WK1 Folding Utility Knife

83131 16' Tape Measure SAE/Metric

83132 Aluminum Flashlight

82041 10" Curved Jaw Locking Pliers

82043 6" Long Nose Locking Pliers

69-990 Safety Glasses

KD® Specialty Tools

KDS129 Low Voltage Circuit Tester

KDS162 16 Blade Feeler Gauge

KDS485 Gasket Scraper

KDS2109 Telescoping Mirror

KDS2281 Telescoping Magnetic Retrieving Tool

Not all tools GearWrench® Branded

1/4" Drive Sockets

80302 13 Pc. 6 Pt. Metric Socket Set
4, 5, 5.5, 6, 7, 8, 9, 10, 11, 12, 13, 14, 15mm

80303 10 Pc. 6 Pt. SAE Socket Set
3/16", 7/32", 1/4", 9/32", 5/16", 11/32", 3/8", 7/16", 1/2", 9/16"

80304 13 Pc. 6 Pt. Deep Metric Socket Set
4, 5, 5.5, 6, 7, 8, 9, 10, 11, 12, 13, 14, 15mm

80305 10 Pc. 6 Pt. Deep SAE Socket Set
3/16", 7/32", 1/4", 9/32", 5/16", 11/32", 3/8", 7/16", 1/2", 9/16"

3/8" Drive Sockets

80552 14 Pc. 6 Pt. Metric Socket Set
6, 7, 8, 9, 10, 11, 12, 13, 14, 15, 16, 17, 18, 19mm

80553 13 Pc. 6 Pt. SAE Socket Set
1/4", 5/16", 3/8", 7/16", 1/2", 9/16", 5/8", 11/16", 3/4", 13/16", 7/8", 15/16", 1"

80554 14 Pc. 6 Pt. Deep Metric Socket Set
6, 7, 8, 9, 10, 13, 14, 15, 16, 17, 18, 19mm

80555 11 Pc. 6 Pt. Deep SAE Socket Set
1/4", 5/16", 3/8", 7/16", 1/2", 9/16", 5/8", 11/16", 3/4", 13/16", 7/8"

1/2" Drive Sockets

80702 13 Pc. 6 Pt. Metric Socket Set
12, 13, 14, 15, 16, 17, 18, 19, 20, 21, 22, 23, 24mm

80703 11 Pc. 6 Pt. SAE Socket Set
1/2", 9/16", 5/8", 11/16", 3/4", 13/16", 7/8", 15/16", 1", 1-1/16", 1-1/8"

1/4", 3/8", 1/2" Drive Tools

81206 3 Pc. Full Polish Ratchet Set
1/4", 3/8", & 1/2" Drive

81113 3" Extension 1/4" Drive

81116 6" Extension 1/4" Drive

80100 Universal Joint 1/4" Drive

81128 Spinner Handle 1/4" Drive

81241 3" Extension 3/8" Drive

81242 6" Extension 3/8" Drive

80549 Universal Joint 3/8" Drive

80402 5/8" Spark Plug Socket 3/8" Drive

80403 13/16" Spark Plug Socket 3/8" Drive

80600 Universal Joint 1/2" Drive

81341 5" Extension 1/2" Drive

81342 10" Extension 1/2" Drive

Note: Individual materials may not be available for separate purchase.

*As part of our continuous improvement process, items shown may be substituted for items of equal or greater value.

For full range of tool sets and storage solutions go to www.gearwrench.com.au

83092T - Career Builder Diesel Add-on Tool Set

RRP \$526.75

1/2" Drive Sockets

80704	10 Pc. 6 Pt. Deep Metric Socket
80637	10mm
80638	11mm
80629	17mm
80640	13mm
80641	14mm
80705	8 Pc. 6 Pt. Deep SAE Socket Set
80614	1/2"
80615	9/16"
80616	5/8"
80617	11/16"

81742	24mm	81745	32mm
81743	27mm		

Flare Nut Wrenches

81906	6 Pc. Metric Flare Nut Wrench Set
81644	9 x 11mm
81645	10 x 12mm
81646	13 x 14mm
81647	15 x 17mm
81648	16 x 18mm
81649	19 x 21mm
81907	6 Pc. SAE Flare Nut Wrench Set
81680	1/4" x 5/16"
81681	3/8" x 7/16"
81682	1/2" x 9/16"
81683	5/8" x 11/16"
81684	5/8" x 3/4"
81685	3/4" x 7/8"

1/2" Drive Tools

81307	Full Polish Flex Handle
-------	-------------------------

Combination Wrenches

SAE Combination Wrenches	
81733	1-1/6"
81734	1-1/8"
81735	1-1/4"
Metric Combination Wrenches	
81741	23mm
81744	30mm

General Purpose Tools

82220	18" to 29" Extendable Pry Bar
82020	12" Groove Joint Pliers-Straight Jaw
81893	12" Adjustable Cushion Grip Wrench



KD® Specialty Tools

KDS2320	Heavy Duty Oil Filter Wrench (4-1/8" to 4-21/32")
KDS2321	Heavy Duty Oil Filter Wrench (4-21/32" to 5-5/32")

KDS2322 Heavy Duty Oil Filter Wrench (5-5/32" to 5-21/32")

Not all tools GearWrench® Branded

83093T - Career Builder Auto Body Add-on Tool Set

RRP \$526.75

General Body Tools

84050	4 Pc. Door Pad and Panel Removal Kit
84051	4" V-Notch Puller
84052	4" Square Notch Puller
84053	4" Scraper
84054	4" Curved Blade V-Notch Puller
84000	7 Pc. Hook And Pick Set
84001	5" Cotter Pin Puller
84002	4" Hose Pick Puller
84003	4-1/2" Awl
84004	3-1/8 Mini Full Hook
84005	3-1/8 90° Mini Hook
84006	3-1/8 Straight Mini Hook
84007	3-1/8 Mini Offset Hook
82302	7 Pc. Body Hammer Set

80173	T-15, 1/4" Drive
80174	T-20, 1/4" Drive
80175	T-25, 1/4" Drive
80176	T-27, 1/4" Drive
80177	T-30, 1/4" Drive
80451	T-40, 3/8" Drive
80452	T-45, 3/8" Drive
80453	T-47, 3/8" Drive
80454	T-50, 3/8" Drive
80455	T-55, 3/8" Drive
80667	T-60, 1/2" Drive

KD® Specialty Tools

KDS038	Window Molding Removal Tool
KDS431	Door Handle Window Lift Remover
KDS2822	Trim Pad Removal Tool
KDS3729	Push Pin Puller
KDS2106	All Purpose Sticker Scraper Tool
KDS2311	Shoe Handle Wire Scratch Brush
KDS2426	3" Putty Knife/Scraper
KDS2425	1-1/4" Putty Knife/Scraper

Torx® Bit Sockets

80723	13 Pc. Torx® Press Fit Bit Socket Set
80171	1 T-8, 1/4" Drive
80172	T-10, 1/4" Drive



Note: Individual materials may not be available for separate purchase.

*As part of our continuous improvement process, items shown may be substituted for items of equal or greater value.

For full range of tool sets and storage solutions go to www.gearwrench.com.au



83094T - Career Builder HVAC Add-on Tool Set

RRP \$948.10

Wrenches

- 81910 5 Pc. SAE Flex Flare Nut Wrench Set
- 81693 1/4" x 5/16"
- 81694 3/8 x 7/16"
- 81695 1/2" x 9/16"
- 81696 5/8" x 11/16"
- 81697 3/4" x 7/8"
- 81911 6 Pc. Metric Flex Flare Nut Wrench Set
- 81686 9 x 11mm
- 81687 10 x 12mm
- 81688 13 x 14mm
- 81689 15 x 17mm
- 81690 16 x 18mm
- 81692 19 x 21mm
- 81990 3 Pc. Adjustable Wrench Set
- 81890 6"
- 81891 8"
- 81892 10"
- 85220 QuadBox™ HVAC Ratcheting Wrench
Sizes: 1/4" x 3/16" square, 3/8" x 5/16" square
- 85221 QuadBox™ HVAC Ratcheting Wrench
Sizes: 1/4" x 3/16" square, 9/16" x 1/2" hex

Cutting Tools

- 82841 Right Cutting Aviation Snips
- 82842 Left Cutting Aviation Snips
- 82843 3 Pc. Aviation Snip Set

General HVAC Tools

- 9-39829 Torpedo Level
- 69-350 10oz. Claw Hammer
- 73-014 14" Pipe Wrench
- MC33661 Manifold Set
- 66-843 7 Pc. SAE Nut Driver Set
(1/4" x 9/32", 5/16", 11/32", 3/8", 7/16", 1/2")

KD® Specialty Tools

- 41590 Tubing Service Set
- 2107 Mini Tubing Cutter
- 2189 Tubing Bender
- 3905 Deburring Tool
- 41594 Flaring Adapter Kit
- 41595 Holding Bar
- 41596 Yoke
- 3457 Large Tubing Cutter

Note: Individual materials may not be available for separate purchase.

*As part of our continuous improvement process, items shown may be substituted for items of equal or greater value.

For full range of tool sets and storage solutions go to www.gearwrench.com.au

83095T - Intermediate Auto Tool Set

RRP \$1499.00

1/4" Drive Sockets

80302 13 Pc. Metric 6 Pt. Socket Set
4, 5, 5.5, 6, 7, 8, 9, 10, 11, 12, 13, 14, 15mm

80303 10 Pc. 6 Pt. SAE Socket Set
3/16", 7/32", 1/4", 9/32", 5/16", 11/32",
3/8", 7/16", 1/2", 9/16"

80304 13 Pc. 6 Pt. Deep Metric Socket Set
4, 5, 5.5, 6, 7, 8, 9, 10, 11, 12, 13, 14, 15mm

80305 10 Pc. 6 Pt. Deep SAE Socket Set
3/16", 7/32", 1/4", 9/32", 5/16", 11/32",
3/8", 7/16", 1/2", 9/16"

3/8" Drive Sockets

80552 14 Pc. 6 Pt. Metric Socket Set
6, 7, 8, 9, 10, 11, 12, 13, 14, 15, 16, 17,
18, 19mm

80553 13 Pc. 6 Pt. SAE Socket Set
1/4", 5/16", 3/8", 7/16", 1/2", 9/16",
5/8", 11/16", 3/4", 13/16", 7/8", 15/16",
1"

80554 14 Pc. 6 Pt. Deep Metric Socket Set
6, 7, 8, 9, 10, 13, 14, 15, 16, 17, 18, 19mm

80555 11 Pc. 6 Pt. Deep SAE Socket Set
1/4", 5/16", 3/8", 7/16", 1/2", 9/16",
5/8", 11/16", 3/4", 13/16", 7/8"

1/2" Drive Sockets

80702 13 Pc. 6 Pt. Metric Socket Set
12, 13, 14, 15, 16, 17, 18, 19, 20, 21, 22,
23, 24mm

80703 11 Pc. 6 Pt. SAE Socket Set
1/2", 9/16", 5/8", 11/16", 3/4", 13/16",
7/8", 15/16", 1", 1-1/16", 1-1/8"

1/4", 3/8", 1/2" Drive Sockets

81206 3 Pc. Full Polish Ratchet Set
(1/4", 3/8", 1/2" Drive)

81113 3" Extension 1/4" Drive

80100 Universal Joint 1/4" Drive

81128 Spinner Handle 1/4" Drive

81241 3" Extension 3/8" Drive

81242 6" Extension 3/8" Drive

80549 Universal Joint 3/8" Drive

80402 5/16" Spark Plug Socket 3/8" Drive

80403 13/16" Spark Plug Socket 3/8" Drive

80600 Universal Joint 1/2" Drive

81341 5" Extension 1/2" Drive

81307 Full Polish Flex Handle 1/2" Drive

Combination Wrenches

81901 15 Pc. SAE Long Pattern Combination
Non-Ratcheting Wrench Set

1/4", 9/32", 5/16", 11/32", 3/8", 7/16",
1/2", 9/16", 5/8", 11/16", 3/4", 13/16",
7/8", 15/16", 1"

81902 15 Pc. Metric Long Pattern Combina-
tion Non-Ratcheting Wrench Set

8, 9, 10, 11, 12, 13, 14, 15, 16, 17, 18, 19,
20, 21, 22mm

Screwdrivers and Pliers

80051 12 Pc. Combination Screwdriver Set

80012 1/4" x 1-1/2" Slotted

80018 3/16" x 6" Slotted w/Cabinet Tip

80013 1/4" x 4" Slotted w/Hex Bolster

80014 1/4" x 6" Slotted w/Hex Bolster

80023 5/16" x 6" Slotted w/Hex Bolster

80022 3/8" x 8" Slotted w/Hex Bolster

80000 #0 x 2-1/2" Phillips

80001 #1 x 3" Phillips

80004 #1 x 6" Phillips

80005 #2 x 1-1/2" Phillips

80007 #2 x 4" Phillips w/Hex Bolster

80011 #3 x 6" Phillips w/Hex Bolster

82108 8 Pc. Mixed Pliers Set

82011 Tongue and Groove

82012 Diagonal Cutting

82013 Long Nose

82014 Slip Joint

82020 12" Groove Joint with Straight Jaw

82025 8" Linesman

82028 8" End Nipper

82005 Straight Double-X™ Pliers

Hex Keys

56603G 13 Pc. SAE ALLEN® Hex Key Set

Sizes: 0.050", 1/16", 5/64", 3/32", 7/64",
1/8", 9/64", 5/32", 3/16", 7/32", 1/4",
5/16", 3/8"

56615G 9 Pc. Metric ALLEN®
Ball End Hex Key Set

Sizes: 1.5, 2, 2.5, 3, 4, 5, 6, 8, 10mm

Punch & Chisels

82305 12 Pc. Punch and Chisel Set

82261 1/4" x 4-3/4" x 1/4" Cold Chisel

82262 3/8" x 5" x 5/16" Cold Chisel

82264 1/2" x 6" x 3/8" Cold Chisel

82265 5/8" x 6-1/2" x 3/8" Cold Chisel

82270 3/8" x 5" Center Punch

82272 3/32" x 4-3/4" x 5/16" Pin Punch

82273 1/8" x 5" x 5/16" Pin Punch



82274 5/32" x 5-1/4" x 5/16" Pin Punch
82275 3/16" x 5-1/2" x 5/16" Pin Punch
82278 1/8" x 8" x 3/8" Long Taper Punch
82283 3/16" x 5" x 3/8" Starter Punch
82285 1/8" x 4-1/2" x 5/16" Starter

82255 3 lb Drilling Hammer
82259 16 oz Rubber Mallet - Wood Hickory
WKF1 Folding Utility Knife
83131 Intermediate Aviation Set
83132 Flashlight Aluminium

Torx® Bit Sockets

80723 13 Pc. Torx® Press Fit Bit Socket Set
1/4", 3/8", 1/2" Drive

80171 T-8, 1/4" Drive

80172 T-10, 1/4" Drive

80173 T-15, 1/4" Drive

80174 T-20, 1/4" Drive

80175 T-25, 1/4" Drive

80176 T-27, 1/4" Drive

80177 T-30, 1/4" Drive

80451 T-40, 3/8" Drive

80452 T-45, 3/8" Drive

80453 T-47, 3/8" Drive

80454 T-50, 3/8" Drive

80455 T-55, 3/8" Drive

80667 T-60, 1/2" Drive

General Purpose Tools

82880 High Tension Hacksaw

82251 16 oz Ball Pein Hammer - Fiberglass

82260 12 oz Soffface Hammer Removable Caps

82102 3 Pc. Locking Pliers Set
82043 Long Nose Locking Pliers 6"
990 Curved Jaw Locking Pliers 5"
990 Curved Jaw Locking Pliers 10"
69-990 Safety Glasses

KD® Specialty Tools

KDS129 Low Voltage Circuit Tester
KDS162 16 Blade Feeler Gauge
KDS485 Gasket Scraper
KDS2282 Slotted Screw Starter
KDS2283 Phillips Screw Starter
KDS2774 Brake Retaining Spring Tool
KDS298 Brake Spring Pliers
KDS295 Brake Shoe Adjusting Tool
KDS3163 Rear Brake Piston Tool
KDS2840 Telescoping Mirror
KDS2593 Telescoping Magnetic Pick-Up Tool
KDS3151 Interchangeable Snap Ring Pliers
KDS2162 Wire Stripper Crimper

Not all tools GearWrench® Branded

Note: Individual materials may not be available for separate purchase.

*As part of our continuous improvement process, items shown may be substituted for items of equal or greater value.

For full range of tool sets and storage solutions go to www.gearwrench.com.au



83096T - Intermediate Diesel Tool Set

RRP \$1529.00

1/4" Drive Sockets

- 80302 13 Pc. 6 Pt. Metric Socket Set
4, 5, 5.5, 6, 7, 8, 9, 10, 11, 12, 13, 14, 15mm
- 80303 10 Pc. 6 Pt. SAE Socket Set
3/16", 7/32", 1/4", 9/32", 5/16", 11/32", 3/8", 7/16", 1/2", 9/16"

3/8" Drive Sockets

- 80552 14 Pc. 6 Pt. Metric Socket Set
6, 7, 8, 9, 10, 11, 12, 13, 14, 15, 16, 17, 18, 19mm
- 80553 13 Pc. 6 Pt. SAE Socket Set
1/4", 5/16", 3/8", 7/16", 1/2", 9/16", 5/8", 11/16", 3/4", 13/16", 7/8", 15/16", 1"

- 80554 14 Pc. 6 Pt. Deep Metric Socket Set
6, 7, 8, 9, 10, 13, 14, 15, 16, 17, 18, 19mm

- 80555 11 Pc. 6 Pt. Deep SAE Socket Set
1/4", 5/16", 3/8", 7/16", 1/2", 9/16", 5/8", 11/16", 3/4", 13/16", 7/8"

1/2" Drive Sockets

- 80702 13 Pc. 6 Pt. Metric Socket Set
12, 13, 14, 15, 16, 17, 18, 19, 20, 21, 22, 23, 24mm

- 80703 11 Pc. 6 Pt. SAE Socket Set
1/2", 9/16", 5/8", 11/16", 3/4", 13/16", 7/8", 15/16", 1", 1-1/16", 1-1/8"

- 80704 10 Pc. 6 Pt. Deep Metric Socket Set
10, 11, 12, 13, 14, 15, 16, 17, 18, 19mm

- 80705 8 Pc. 6 Pt. Deep SAE Socket Set
1/2", 9/16", 5/8", 11/16", 3/4", 13/16", 7/8", 15/16"

1/4", 3/8", 1/2" Drive Sockets

- 81206 3 Pc. Full Polish Ratcheting Set
- 81011 Full Polish Teardrop Ratchet 1/4" Drive
- 81211 Full Polish Teardrop Ratchet 3/8" Drive
- 81304 Full Polish Teardrop Ratchet 1/2" Drive
- 81113 3" Extension 1/4" Drive
- 80100 Universal Joint 1/4" Drive
- 81128 Spinner Handle 1/4" Drive
- 81241 3" Extension 3/8" Drive
- 81242 6" Extension 3/8" Drive
- 80549 Universal Joint 3/8" Drive
- 80402 Intermediate Diesel Set
- 80403 13/16" Spark Plug Socket 3/8" Dr.
- 80600 Universal Joint 1/2" Drive
- 81341 5" Extension 1/2" Drive

- 81307 Full Polish Flex Handle 1/2" Drive

Combinations Wrenches

- 81917 18 Pc. Long Pattern Combination Non-Ratcheting Wrench Set SAE
1/4", 9/32", 5/16", 11/32", 3/8", 7/16", 1/2", 9/16", 5/8", 11/16", 3/4", 13/16", 7/8", 15/16", 1", 1-1/8", 1-1/4", 1-1/2"
- 81916 22 Pc. Long Pattern Combination Non-Ratcheting Wrench Metric
6, 7, 8, 9, 10, 11, 12, 13, 14, 15, 16, 17, 18, 19, 20, 21, 22, 23, 24, 27, 30, 32mm

Screwdrivers and Pliers

- 80051 12 Pc. Combination Screwdriver Set
- 80012 1/4" x 1-1/2" Slotted
- 80018 3/16" x 6" Slotted w/ Cabinet Tip
- 80013 1/4" x 4" Slotted w/Hex Bolster
- 80014 1/4" x 6" Slotted w/Hex Bolster
- 80023 5/16" x 6" Slotted w/Hex Bolster
- 80022 3/8" x 8" Slotted w/Hex Bolster
- 80000 #0 x 2-1/2" Phillips
- 80001 #1 x 3" Phillips
- 80004 #1 x 6" Phillips
- 80005 #2 x 1-1/2" Phillips
- 80007 #2 x 4" Phillips w/ Hex Bolster
- 80011 #3 x 6" Phillip w/Hex Bolster

82103 4 Pc. Mixed Pliers Set

- 82011 9.5" Tongue and Groove
- 82012 7" Diagonal Cutting
- 82013 8" Long Nose
- 82005 Straight Double-X™

Hex Keys

- 566036 13 Pc. SAE ALLEN® Hex Key Set
Sizes: 0.050", 1/16", 5/64", 3/32", 7/64", 1/8", 9/64", 5/32", 3/16", 7/32", 1/4", 5/16", 3/8"

- 566156 9 Pc. SAE ALLEN® Ball End Hex Key Set

- Sizes: 1.5, 2, 2.5, 3, 4, 5, 6, 8, 10mm

Punch & Chisel

- 82305 12 Pc. Punch and Chisel Set
- 82261 1/4" x 4-3/4" x 1/4" Cold Chisel
- 82262 3/8" x 5" x 5/16" Cold Chisel
- 82264 1/2" x 6" x 3/8" Cold Chisel
- 82265 5/8" x 6-1/2" x 3/8" Cold Chisel
- 82270 3/8" x 5" Center Punch
- 82272 3/32" x 4-3/4" x 5/16" Pin Punch
- 82273 1/8" x 5" x 5/16" Pin Punch
- 82274 5/32" x 5-1/4" x 5/16" Pin Punch
- 82275 3/16" x 5-1/2" x 5/16" Pin Punch

- 82278 1/8" x 8" x 3/8" Long Taper Punch
- 82283 3/16" x 5" x 3/8" Starter Punch
- 82285 1/8" x 4-1/2" x 5/16" Long Taper Punch

Torx® Bit Sockets

- 80723 13 Pc. Torx® Press Fit Bit Socket Set
- 80171 T-8, 1/4" Drive
- 80172 T-10, 1/4" Drive
- 80173 T-15, 1/4" Drive
- 80174 T-20, 1/4" Drive
- 80175 T-25, 1/4" Drive
- 80176 T-27, 1/4" Drive
- 80177 T-30, 1/4" Drive
- 80451 T-40, 3/8" Drive
- 80452 T-45, 3/8" Drive
- 80453 T-47, 3/8" Drive
- 80454 T-50, 3/8" Drive
- 80455 T-55, 3/8" Drive
- 80667 T-60, 1/2" Drive

General Purpose Tools

- 82220 18" to 29" Extendable Pry Bar
- 82880 High Tension Hacksaw
- 82251 16 oz Ball Pein Hammer - Fiberglass
- 82260 12 oz Softface Hammer Removable Caps
- 82255 3 lb Drilling Hammer
- 82259 16 oz Rubber Mallet - Wood Hickory Handle
- WK1 Folding Utility Knife
- 83131 16' Tape Measure SAE/Metric
- 83132 Aluminum Flashlight

82102 3 Pc. Locking Pliers Set

- 82043 Long Nose Locking Pliers 6"
- 82040 Curved Jaw Locking Pliers 5"
- 82041 Curved Jaw Locking Pliers 10"
- 69-990 Safety Glasses

KD® Specialty Tools

- KDS129 Low Voltage Circuit Tester
- KDS162 16 Blade Feeler Gauge
- KDS485 Gasket Scraper
- KDS2282 Slotted Screw Starter
- KDS2283 Phillips Screw Starter
- KDS2840 Telescoping Mirror
- KDS2593 Telescoping Magnetic Pick-Up Tool
- KDS2162 Wire Stripper Crimper

Not all tools GearWrench® Branded

Note: Individual materials may not be available for separate purchase.

*As part of our continuous improvement process, items shown may be substituted for items of equal or greater value.

For full range of tool sets and storage solutions go to www.gearwrench.com.au

83097T - Intermediate Auto Body Tool Set

RRP \$1949.00

1/4" Drive Sockets

80302 13 Pc. 6 Pt. Metric Socket Set
4mm to 15mm

80303 10 Pc. 6 Pt. SAE Socket Set
3/16" to 9/16"

80304 13 Pc. 6 Pt. Deep Metric Socket Set
4mm to 15mm

80305 10 Pc. 6 Pt. Deep SAE Socket Set
3/16" to 9/16"

3/8" Drive Sockets

80552 14 Pc. 6 Pt. Metric Socket Set
6mm to 19mm

80553 13 Pc. 6 Pt. SAE Socket Set
1/4" to 1"

80554 14 Pc. 6 Pt. Deep Metric Socket Set
6mm to 19mm

80555 11 Pc. 6 Pt. Deep SAE Socket Set
1/4" to 7/8"

1/2" Drive Sockets

80702 13 Pc. 6 Pt. Metric Socket Set
12mm to 24mm

80703 11 Pc. 6 Pt. SAE Socket Set
1/2" to 1-1/8"

1/4", 3/8", 1/2" Drive Sockets

81206 3 Pc. Full Polish Ratchet Set
(1/4", 3/8", 1/2" Drive)

81113 3" Extension 1/4" Drive

80100 Universal Joint 1/4" Drive

81128 Spinner Handle 1/4" Drive

81241 3" Extension 3/8" Drive

81242 6" Extension 3/8" Drive

80549 Universal Joint 3/8" Drive

80402 Intermediate Auto Body Set

80403 13/16" Spark Plug Socket 3/8" Dr.

80600 Universal Joint 1/2" Drive

81341 5" Extension 1/2" Drive

81307 Full Polish Flex Handle 1/2" Drive

81901 15 Pc. SAE Long Pattern Combination
Non-Ratcheting Wrench Set

1/4" to 1"

81902 15 Pc. Metric Long Pattern Combina-
tion Non-Ratcheting Wrench Set

8mm to 22mm

Screwdrivers and Pliers

80051 12 Pc. Combination Screwdriver Set

80012 1/4" x 1-1/2" Slotted

80018 3/16" x 6" Slotted w/Cabinet Tip

80013 1/4" x 4" Slotted w/Hex Bolster

80014 1/4" x 6" Slotted w/Hex Bolster

80023 5/16" x 6" Slotted w/Hex Bolster

80022 3/8" x 8" Slotted w/Hex Bolster

80000 #0 x 2-1/2" Phillips

80001 #1 x 3" Phillips

80004 #1 x 6" Phillips

80005 #2 x 1-1/2" Phillips

80007 #2 x 4" Phillips w/Hex Bolster

80011 #3 x 6" Phillips w/Hex Bolster

82103 4 Pc. Mixed Pliers Set

82011 9.5" Tongue and Groove

82012 7" Diagonal Cutting

82013 8" Long Nose

Hex Keys

56603G 13 Pc. SAE ALLEN® Hex Key Set

Sizes: 0.050", 1/16", 5/64", 3/32", 7/64",
1/8", 9/64", 5/32", 3/16", 7/32", 1/4",
5/16", 3/8"

Punch & Chisels

82305 12 Pc. Punch and Chisel Set

82261 1/4" x 4-3/4" x 1/4" Cold Chisel

82262 3/8" x 5" x 5/16" Cold Chisel

82264 1/2" x 6" x 3/8" Cold Chisel

82265 5/8" x 6-1/2" x 3/8" Cold Chisel

82270 3/8" x 5" Center Punch

82272 3/32" x 4-3/4" x 5/16" Pin Punch

82273 1/8" x 5" x 5/16" Pin Punch

82274 5/32" x 5-1/4" x 5/16" Pin Punch

82275 3/16" x 5-1/2" x 5/16" Pin Punch

82278 1/8" x 8" x 3/8" Long Taper Punch

82283 3/16" x 5" x 3/8" Starter Punch

82285 1/8" x 4-1/2" x 5/16" Long Taper Punch

Hex and Torx® Bit Sockets

80726 36 Pc. Master Torx® Set with Hex
Bit Sockets

80172 T-10, 1/4" Drive

80173 T-15, 1/4" Drive

80174 T-20, 1/4" Drive

80175 T-25, 1/4" Drive

80176 T-27, 1/4" Drive

80177 T-30, 1/4" Drive

80187 E-5, 1/4" Drive

80188 E-6, 1/4" Drive

80189 E-7, 1/4" Drive

80190 E-8, 1/4" Drive

80451 T-40, 3/8" Drive

80452 T-45, 3/8" Drive

80453 T-47, 3/8" Drive

80454 T-50, 3/8" Drive

80455 T-55, 3/8" Drive

80416 5/32", 3/8" Drive

80417 3/16", 3/8" Drive

80418 7/32", 3/8" Drive

80419 1/4", 3/8" Drive

80420 5/16", 3/8" Drive

80421 3/8", 3/8" Drive

80422 2mm, 3/8" Drive

80423 2.5mm, 3/8" Drive

80424 3mm, 3/8" Drive

80425 4mm, 3/8" Drive

80426 5mm, 3/8" Drive

80427 6mm, 3/8" Drive



80428 7mm, 3/8" Drive

80429 8mm, 3/8" Drive

80430 9mm, 3/8" Drive

80431 10mm, 3/8" Drive

80460 E-10, 3/8" Drive

80461 E-12, 3/8" Drive

80462 E-14, 3/8" Drive

80463 E-16, 3/8" Drive

80669 E-18, 1/2" Drive

General Body Tools

84050 4 Pc. Door Pad and Panel Removal Kit

84051 4" V-Notch Puller

84052 4" Square Notch Puller

84053 4" Scraper

84054 4" Curved Blade V-Notch Puller

84000 7 Pc. Hook And Pick Set

84001 5" Cotter Pin Puller

84002 4" Hose Pick Puller

84003 4-1/2" Awl

84004 3-1/8 Mini Full Hook

84005 3-1/8 90° Mini Hook

84006 3-1/8 Straight Mini Hook

84007 3-1/8 Mini Offset Hook

82820 4 Pc. STD Files Set

82822 8" Flat

82823 8" Round

82824 8" Half Round

82825 8" Triangle

82302 7 Pc. Body Hammer Set

General Body Tools

82880 High Tension Hacksaw

82840 Straight Cutting Aviation Snips

82251 16 oz Ball Pein Hammer - Fiberglass

82260 12 oz Softface Hammer Removable Caps

82255 3 lb Drilling Hammer

82259 16 oz Rubber Mallet-Wood Hickory
Handle

WKF1 Folding Utility Knife

83131 Intermediate Aviation Set

83132 Intermediate Aviation Set

82041 10" Curved Jaw Locking Pliers

82043 6" Long Nose Locking Pliers

82050 11" Swivel Pad C-Clamp Locking Pliers

69-990 Safety Glasses

KD® Specialty Tools

KDS129 Low Voltage Circuit Tester

KDS485 Gasket Scraper

KDS2840 Telescoping Mirrors

KDS2593 Telescoping Magnetic Pick-Up Tool

KDS3151 Interchangeable Snap Ring Pliers

KDS2162 Wire Stripper Crimper

KDS2038 Window Molding Remover

KDS431 Door Handle Window Lift Remover

KDS2822 Trim Pad Removal Tool

KDS3729 Push Pin Pliers

KDS2979 Scribe

KDS2106 All Purpose Sticker Scraper Tool

KDS2311 Shoe Handle Wire Scratch Brush

KDS2426 3" Putty/Knife Scraper

KDS2425 1-1/4" Putty/Knife Scraper

Not all tools GearWrench® Branded

Note: Individual materials may not be available for separate purchase.

*As part of our continuous improvement process, items shown may be substituted for items of equal or greater value.

For full range of tool sets and storage solutions go to www.gearwrench.com.au



83098T - Intermediate Aviation Tool Set
RRP \$1185.00

- 82827 4" Half Round Mini
- 82828 4" Round Mini
- 82829 4" Triangle Mini
- 82830 4" Square Mini
- 82831 4" Knife Mini
- 82305 12 Pc. Punch and Chisel Set**
- 82261 1/4" x 4-3/4" x 1/4" Cold Chisel
- 82262 3/8" x 5" x 5/16" Cold Chisel
- 82264 1/2" x 6" x 3/8" Cold Chisel
- 82265 5/8" x 6-1/2" x 3/8" Cold Chisel
- 82270 3/8" x 5" Center Punch
- 82272 3/32" x 4-3/4" x 5/16" Pin Punch
- 82273 1/8" x 5" x 5/16" Pin Punch
- 82274 5/32" x 5-1/4" x 5/16" Pin Punch
- 82275 3/16" x 5-1/2" x 5/16" Pin Punch
- 82278 1/8" x 8" x 3/8" Long Taper Punch
- 82283 3/16" x 5" x 3/8" Starter Punch
- 82285 1/8" x 4-1/2" x 5/16" Long Taper Punch

General Purpose Tools

- 81891 8" Adjustable Cushion Grip Wrench
- 81893 12" Adjustable Cushion Grip Wrench
- 82880 High Tension Hacksaw
- 82251 16 oz Ball Pein Hammer - Fiberglass
- 82260 12 oz Softface Hammer Removable Caps
- WKF1 Folding Utility Knife
- 82131 16" Tape Measure SAE/Metric
- 83132 Aluminum Flashlight
- 82040 5" Curved Jaw Locking Pliers
- 69-990 Safety Glasses
- 9-HLQM24 Hearing Protection

KD® Specialty Tools

- KDS2391 23" Flexible Pick-Up Tool
- KDS2109 Telescoping Mirror
- KDS2593 Telescoping Magnetic Pick-Up Tools
- KDS2282 Slotted Screw Starter
- KDS2283 Phillips Screw Starter
- KDS2425 1-1/4" Putty Knife/Scrapper
- KDS2979 Scribe
- KDS2309 Stainless Steel Brush
- KDS3151 Interchangeable Snap Ring Pliers
- KDS2162 Wire Stripper Crimper
- KDS162 16 Blade Feeler Gauge

Not all tools GearWrench® Branded

1/4" Drive Sockets

- 80307 10 Pc. 12 Pt. SAE Socket Set
- 80210 3/16" 80215 11/32"
- 80211 7/32" 80216 3/8"
- 80212 1/4" 80217 7/16"
- 80213 9/32" 80218 1/2"
- 80214 5/16" 80219 9/16"

- 80305 10 Pc. 6 Pt. Deep SAE Socket Set
- 80115 3/16" 80120 11/32"
- 80116 7/32" 80121 3/8"
- 80117 1/4" 80122 7/16"
- 80118 9/32" 80123 1/2"
- 80119 5/16" 80124 9/16"

- 80310 7 Pc. 6 Pt. SAE Flex Socket Set
- 80262 3/16" 80266 7/16"
- 80263 1/4" 80267 1/2"
- 80264 5/16" 80268 9/16"
- 80265 3/8"

1/4" Drive Tools

- 81011 Full Polish Teardrop Ratchet
- 81113 3" Extension
- 81116 6" Extension
- 81128 Spinner Handle
- 80100 Universal Joint

3/8" Drive Sockets

- 80561 13 Pc. 12 Pt. SAE Socket Set

- 80496 1/4" 80503 11/16"
- 80497 5/16" 80504 3/4"
- 80498 3/8" 80505 13/16"
- 80499 7/16" 80506 7/8"
- 80500 1/2" 80507 15/16"
- 80501 9/16" 80508 1"
- 80502 5/8"

- 80563 11 Pc. 12 Pt. Deep SAE Socket Set
- 80509 1/4" 80515 9/16"
- 80510 5/16" 80516 5/8"
- 80511 3/8" 80517 11/16"
- 80512 1/4" 80518 3/4"
- 80513 7/16" 80519 7/8"
- 80514 1/2"

3/8" Drive Tools

- 81211 Full Polish Teardrop Ratchet
- 81241 3" Extension
- 81242 6" Extension
- 80549 Universal Joint
- 80402 5/8" Spark Plug Socket
- 80403 13/16" Spark Plug Socket
- 11-935 Speeder Handle

Hex Keys

- 56612G 13 Pc. SAE ALLEN® Ball End Hex Key Set
- Sizes: 0.050", 1/16", 5/64", 3/32", 7/64", 1/8", 9/64", 5/32", 3/16", 7/32", 1/4", 5/16", 3/8"

Screwdrivers and Pliers

- 80050 6 Pc. Combination Screwdriver Set
- 80015 1/8" x 3" Slotted w/Cabinet Tip
- 80013 1/4" x 4" Slotted w/Hex Bolster
- 80023 5/16" x 6" Slotted w/Hex Bolster
- 80022 3/8" x 8" Slotted w/Hex Bolster
- 80001 #1 x 3" Phillips
- 80007 #2 x 4" Phillips w/Hex Bolster

82103 4 Pc. Mixed Pliers Set

- 82011 9.5" Tongue and Groove
- 82012 7" Diagonal Cutting
- 82013 8" Long Nose
- 82014 8" Slip Joint

Cutting Tools

- 82841 Right Cutting Aviation Snips
- 82842 Left Cutting Aviation Snips
- 82843 3 Pc. Aviation Snip Set

Files, Punches & Chisels

- 82820 4 Pc. STD File Set
- 82822 8" Flat
- 82823 8" Round
- 82824 8" Half Round
- 82825 8" Triangle File
- 82821 6 Pc. Mini File Set
- 82826 4" Flat Mini

Note: Individual materials may not be available for separate purchase. *As part of our continuous improvement process, items shown may be substituted for items of equal or greater value.

For full range of tool sets and storage solutions go to www.gearwrench.com.au

**YOU'RE GONNA NEED
A BIGGER BOX**



CABINETS & STORAGE



Cabinets & Storage

XL Series
Ball Bearing Series
Tool Storage Accessories
Modular Storage System

**GEARWRENCH XL SERIES
TOOL STORAGE**



Trigger Lock drawer system keeps drawers in place and opens with a natural pull operation (excluding 83159)

All drawers feature Auto Return, which snaps the drawers closed in the final inches of operation



Formed with rolled over drawer walls add strength and rigidity



Double Ball-Bearing construction offers exceptional load capacity and easy slide action

GearWrench now offers the industrial strength XL Tool Storage series. Professionals have come to expect innovation and increased productivity when using GearWrench products; with the XL series you can continue to expect the same superior design and construction to make you more productive on the job. Choose XL when you need a tool storage system that stands up to your growing demands. Formed with rolled over drawer walls, heavy gauge steel bodies, and stamped drawer bottoms; the XL series provides the required strength, durability and rigidity to withstand your professional demands.



All drawers come with drawer liners

AVAILABLE IN:

- XL Tool Chests
- XL Tool Roller Cabinets

CABINETS & STORAGE

Dual gas shocks on lids offer support and easily controlled closure



A 9 mm top mat provides protection and support on all cabinets



High strength side lift handles are integrated into the box wall for added durability and lift capacity



Barrel style lock and key are unique combination for security and durability

Durable powder-coated full-polished lacquer coating protects against scratches and marring



One set of locking casters on all cabinets and carts

26 SERIES

83154 - 26"/660mm 4 Drawer Chest POA

Width (mm)	Depth (mm)	Height (mm)	Weight (kg)	Volume (m³)		
660	406	483	33	0.13		
Drawer Dimensions			Width (mm)	Depth (mm)	Height (mm)	Load Wt. (kg)
4 Drawers			569	366	70	40
1 Tray			655	400	45	35



83159 - 26"/660mm 8 Drawer Chest POA

Width (mm)	Depth (mm)	Height (mm)	Weight (kg)	Load Wt. (kg)	Volume (m³)	
660	406	437	28	315	0.12	
Drawer Dimensions			Width (mm)	Depth (mm)	Height (mm)	Load Wt. (kg)
1 Tray			655	400	59	35
1 Drawer			168	366	124	35
4 Drawers			168	366	53	35
2 Drawers			569	366	55	35
1 Drawer			569	366	81	35



83155 - 26"/660mm 7 Drawer Roller Cabinet POA

Width (mm)	Depth (mm)	Height (mm)	Weight (kg)	Load Wt. (kg)	Volume (m³)	Casters
680	457	991	70	400	0.31	5" x 2" PP
Drawer Dimensions			Width (mm)	Depth (mm)	Height (mm)	Load Wt. (kg)
5 Drawers			565	394	57	40
2 Drawers			565	394	140	40

- Caster Type: PP (Polypropylene)



CABINETS & STORAGE

27 SERIES



NEW PRODUCT

83164 - 27" 4 Drawer Top Chest

POA

Width (mm)	Depth (mm)	Height (mm)	Weight (kg)
678	459	483	36

Drawer Dimensions	Width (mm)	Depth (mm)	Height (mm)	Load Wt. (kg)
4 Drawers	568	398	75	30

- Durable powder-coated coating protects against scratches and marring
- Gas struts
- Double wall and beveled side edges
- 45mm ball bearing slides (loading capacity: 30kg per drawer)
- Auto-return function and quick lock function on all drawers
- Perforated square hole accessory system on both side flat panels for additional storage
- 2.5mm EVA drawer linings
- Barrel lock with key
- Integrated bumpers with protection



NEW PRODUCT

83165 - 27" 7 Drawer Roller Cabinet

POA

Width (mm)	Depth (mm)	Height (mm)	Weight (kg)
678	459	859	68

Drawer Dimensions	Width (mm)	Depth (mm)	Height (mm)	Load Wt. (kg)
5 Drawers	568	398	75	30
2 Drawers	568	398	154	30

- Double wall and beveled side edges
- 45mm ball bearing slides (loading capacity: 30kg per drawer)
- Auto-return function and quick lock function on all drawers
- Perforated square hole accessory system on both side flat panels for additional storage
- 5mm EVA top mat and 2.5mm EVA drawer linings
- 5" x 2" casters - 2 fixed and 2 swivel with brakes
- Barrel lock with key
- Integrated bumpers with protection

42 SERIES



83156 - 42"/1066mm 8 Drawer Chest

POA

Width (mm)	Depth (mm)	Height (mm)	Weight (kg)	Volume (m³)
1053	464	521	72	0.25

Drawer Dimensions	Width (mm)	Depth (mm)	Height (mm)	Load Wt. (kg)
4 Drawers	572	394	57	40
4 Drawers	305	394	57	40
Tray	1048	459	39	80



83157 - 42"/1066mm 11 Drawer Roller Cabinet

POA

Width (mm)	Depth (mm)	Height (mm)	Weight (kg)	Load Wt. (kg)	Volume (m³)	Casters
1069	483	991	130	549	0.511	5" x 2" TPR

Drawer Dimensions	Width (mm)	Depth (mm)	Height (mm)	Load Wt. (kg)
5 Drawers	578	394	57	40
3 Drawers	311	394	57	40
1 Drawer	311	394	298	60
1 Drawer	578	394	140	40
1 Drawer	934	394	95	60

- Caster Type: TPR (Thermoplastic Rubber)

53 SERIES

83160 - 53"/1346mm 8 Drawer Tool Chest POA

Width (mm)	Depth (mm)	Height (mm)	Weight (kg)	Load Wt. (kg)	Volume (m ³)	
1340	471	523	134	450	0.330	
Drawer Inside Dimensions			Width (mm)	Depth (mm)	Height (mm)	Load Wt. (kg)
4 Drawers			753	397	60	45
4 Drawers			409	397	60	45
Tray			1336	466	39	90



83158 - 53"/1346mm 9 Drawer Roller Cabinet POA

Width (mm)	Depth (mm)	Height (mm)	Weight (kg)	Load Wt. (kg)	Volume (m ³)	Casters
1346	483	1003	148	800	0.652	5"x 2" PU
Drawer Inside Dimensions			Width (mm)	Depth (mm)	Height (mm)	Load Wt. (kg)
3 Drawers			409	397	60	40
2 Drawers			753	397	60	45
1 Drawer			753	397	139	45
1 Drawer			753	397	218	45
1 Drawer			409	397	297	90
1 Drawer			1223	397	96	90



- Caster Type: PU (Polyurethane)

TOTES & SMALL BOXES

83151 - 20"/508mm 3 Drawer Tool Box RRP \$208.65

Width (mm)	Depth (mm)	Height (mm)	Weight (kg)
508	216	305	8.09

- Portable tool box with ball bearing drawer slides
- Keyed center lock for security
- Includes cantilever tray



83130 - 19"/482mm Tote Box RRP \$90.60

Width (mm)	Depth (mm)	Height (mm)	Weight (kg)
483	152	165	4.5

- Dual latch with lock clasps
- Includes tote tray



9248 - 18 Pocket Empty Wrench Roll RRP \$26.20

- Ideal for wrenches 6mm to 25mm (1/4" to 1")



NEW PRODUCT

TOOL CARRY BAGS



NEW PRODUCT

83145 - Utility Tool Bag

RRP \$26.15

Width (mm)	Depth (mm)	Height (mm)	Weight (kg)
470	290	290	0.450

- 600 denier fabric, 26 pockets



83147 - 16"/406mm Tool Bag

RRP \$40.05

Width (mm)	Depth (mm)	Height (mm)	Weight (kg)
407	324	203	1.71

- All weather durable heavy-duty construction

* Tools pictured not included



NEW PRODUCT

83142 - Wide Mouth Tool Bag Medium

RRP \$94.30

Width (mm)	Depth (mm)	Height (mm)	Weight (kg)
480	310	250	1

- 1200 denier fabric, 23 pockets



NEW PRODUCT

83143 - Open Tote Bag

RRP \$94.30

Width (mm)	Depth (mm)	Height (mm)	Weight (kg)
500	240	220	1.3

- 1680 denier fabric, 9 pockets and 19 tool holders with tape holder, level holder and saw pouch



NEW PRODUCT

83144 - Bucket Style Tool Bag

RRP \$94.30

Width (mm)	Depth (mm)	Height (mm)	Weight (kg)
290	290	290	0.800

- 1680 denier fabric, 12 outside pockets



83140 - Technicians Tool Bag

RRP \$99.05

Width (mm)	Depth (mm)	Height (mm)	Weight (kg)
410	150	360	2.4

- 32 Pockets - 26 Hand tool pockets, 3 large flap pockets with hook & loop seal, 2 side pockets with zips
- Pull out stand to keep bag upright
- Padded shoulder strap for quick and comfortable transportation
- Soft rubber carry handle



NEW PRODUCT

83141 - Wide Mouth Tool Bag Large

RRP \$104.80

Width (mm)	Depth (mm)	Height (mm)	Weight (kg)
550	350	250	1.250

- 1200 denier fabric, 23 pockets

TOTES & SMALL BOXES

83148 - 16½"/419mm Plastic Tool Box RRP \$25.30

Width (mm)	Depth (mm)	Height (mm)	Weight (kg)
419	196	216	1.6

- Plastic hand box with comfort grip handle
- Includes tote tray and two compartments in lid



CABINETS & STORAGE

MODULAR STORAGE SYSTEM



Refer to the following pages for EVA Tray Sets, Metal Case Sets & Blow Moulded Case Sets which suit the drawer types A and B, as illustrated



The GearWrench Modular Storage System comprises a range of tools contained in EVA Trays, Metal Cases and Blow Moulded Cases, all designed to conveniently fit into most tool chests and trolleys/cabinets. The range also includes Combination Sets comprising Tool Chest and/or Trolley complete with Tools in EVA Trays



Modular Storage System

EVA Trays with Tools
Metal Case Sets
Blow Moulded Case Sets

For further information refer to the following pages or the GearWrench Modular Storage System brochure

For full range of tool sets and storage solutions go to www.gearwrench.com.au

COMBINATION STORAGE & TOOL SETS

83170 - Combination Tool Set - Chest + 90 Pc Socket Set METRIC/SAE POA

Item No.	Description
83159	Deep Tool Chest (660 x 406 x 437mm)
83071	90 Pc. Socket Set METRIC/SAE 1/4", 3/8", & 1/2" Drives

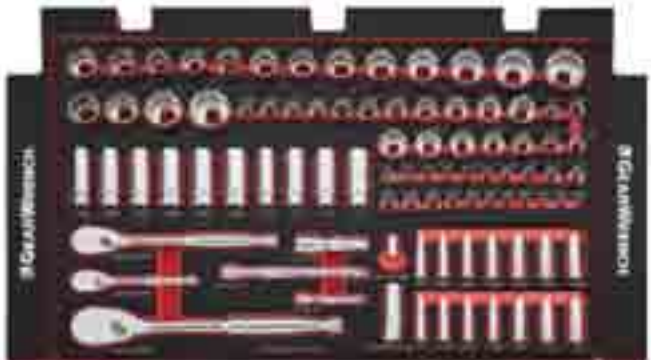

Refer Page 33 for list of contents in the above set.

6 POINT
SOCKETS

12 POINT
SOCKETS

1/4" DRIVE
3/8" DRIVE
1/2" DRIVE

83171 - Combination Tool Set - Chest + 189 Pc Tools POA

Item No.	Description
83159	Deep Tool Chest (660 x 406 x 437mm)
83071	90 Pc. Socket Set METRIC/SAE 1/4", 3/8", & 1/2" Drives
83072	12 Pc. Plier Set
83073	52 Pc. Screwdriver Set
83075	24 Pc. Ratcheting Wrench Set
83076	3 Pc. Adjustable Wrench Set
83077	3 Pc. Snip Set
82820	4 Pc. File Set

Refer Pages 32, 33 & 35 for list of contents in the above sets.

6 POINT
SOCKETS

12 POINT
SOCKETS

1/4" DRIVE
3/8" DRIVE
1/2" DRIVE

83071 90 pc. METRIC/SAE 6 & 12 Pt. Socket Set



83072 12 pc. plier Set



83073 52 pc. screwdriver Set



83075 24 pc. METRIC/SAE ratcheting wrench Set



83076 3 pc. adjustable wrench Set



83077 3 pc. Aviation Snip Set



82820 4 pc. File Set



Note: Individual materials may not be available for separate purchase.
*As part of our continuous improvement process, items shown may be substituted for items of equal or greater value.

For full range of tool sets and storage solutions go to www.gearwrench.com.au

COMBINATION STORAGE & TOOL SETS

MODULAR STORAGE



83172 - Combination Tool Set - Chest + Trolley + 188 Pc Tools

POA

Item No.	Description
83155	Trolley - Rolling, 7 Drawer 26"
83159	Deep Tool Chest (660 x 406 x 437mm)
83071	90 Pc. Socket Set METRIC/SAE 1/4", 3/8", & 1/2" Drives
83072	12 Pc. Plier Set
83073	52 Pc. Screwdriver Set
83075	24 Pc. Ratcheting Wrench Set
83076	3 Pc. Adjustable Wrench Set
83077	3 Pc. Snip Set
82820	4 Pc. File Set

Refer Pages 32, 33 & 35 for list of contents in the above sets.

83071 90 pc. METRIC/SAE 6 & 12 Pt. Socket Set

83072 12 pc. plier Set

83073 52 pc. screwdriver Set

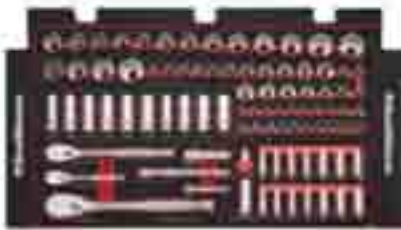

83075 24 pc. METRIC/SAE ratcheting wrench Set

83076 3 pc. adjustable wrench Set



83077 3 pc. Aviation Snip Set

82820 4 pc. File Set



Note: Individual materials may not be available for separate purchase.

*As part of our continuous improvement process, items shown may be substituted for items of equal or greater value.

For full range of tool sets and storage solutions go to www.gearwrench.com.au

COMBINATION STORAGE & TOOL SETS

83173 - Combination Tool Kit + 179 Pc Tools + 83159 Chest:A POA

Item No.	Description
83159	Deep Tool Chest (600 x 406 x 437mm)
83071	90 Pc. Socket Set METRIC/SAE 1/4", 3/8" & 1/2" Drives
83072	12 Pc. Plier Set
83073	52 Pc. Screwdriver Set
83075	24 Pc. Ratcheting Wrench Set

Refer Pages 32 & 33 for list of contents in the above sets.

6 POINT
SOCKETS

12 POINT
SOCKETS

1/4" DRIVE
3/8" DRIVE
1/2" DRIVE

MODULAR STORAGE

83174 - Combination Tool Kit + 180 Pc Tools + Chest & Trolley:A POA

Item No.	Description
83155	Trolley - Rolling, 7 Drawer 26"
83159	Deep Tool Chest (600 x 406 x 437mm)
83071	90 Pc. Socket Set METRIC/SAE 1/4", 3/8" & 1/2" Drives
83072	12 Pc. Plier Set
83073	52 Pc. Screwdriver Set
83075	24 Pc. Ratcheting Wrench Set

Refer Pages 32 & 33 for list of contents in the above sets.

6 POINT
SOCKETS

12 POINT
SOCKETS

1/4" DRIVE
3/8" DRIVE
1/2" DRIVE

83071 90 pc. METRIC/SAE 6 & 12 Pt. Socket Set



83072 12 pc. plier Set



83073 52 pc. screwdriver Set



83075 24 pc. METRIC/SAE ratcheting wrench Set



Note: Individual materials may not be available for separate purchase.
*As part of our continuous improvement process, items shown may be substituted for items of equal or greater value.

For full range of tool sets and storage solutions go to www.gearwrench.com.au

MODULAR STORAGE

EVA TRAYS WITH TOOLS



EVA tray can be reduced in size for convenient storage into most tool chests/trolley drawers



83056 - 10 Pc. Wrench Set Open End Ratcheting Combination METRIC

RRP \$175.90

Description

Open Ended Ratcheting Combination Wrench: 8mm, 10mm, 11mm, 12mm, 13mm, 14mm, 15mm, 16mm, 17mm, 19mm

EVA Tray Included: 168mm x 360mm

Fits drawer type **B** as shown on page 28.



83052 - 10 Pc. Wrench Set Ratcheting Combination METRIC

RRP \$165.95

Description

Combination Ratcheting Wrench: 8mm, 10mm, 11mm, 12mm, 13mm, 14mm, 15mm, 16mm, 17mm, 19mm

EVA Tray Included: 168mm x 360mm

Fits drawer type **B** as shown on page 28.



83053 - 10 Pc. Wrench Set Ratcheting Combination SAE

RRP \$165.95

Description

Combination Ratcheting Wrench: 1/4", 5/16", 3/8", 7/16", 1/2", 9/16", 5/8", 11/16", 3/4", 13/16"

EVA Tray Included: 168mm x 360mm

Fits drawer type **B** as shown on page 28.

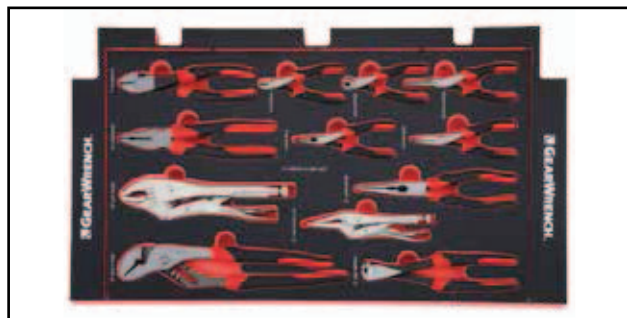

83072 - 12 Pc. Plier Set

RRP \$308.65

Description

Diagonal Cutting Plier: 178mm/7", Long Nose Plier: 203mm/8", Groove Joint with Straight Jaw: 305mm/12", Universal Plier: 203mm/8", End Nipper: 203mm/8", Mini Diagonal Plier, Mini Long Nose Plier, Mini Needle Nose Plier, Mini End Nipper, Mini Duck Bill Plier, Long Nose Locking Plier with Wire Cutter: 152mm/6", Curved Jaw Locking Plier with Wire Cutter: 254mm/10"

EVA Tray Included: uncut 655mm x 395mm, cut = 557mm x 360mm

Fits drawer type **A** as shown on page 28.

Note: Individual materials may not be available for separate purchase.

EVA TRAYS WITH TOOLS

83071 - 90 Pc. Socket Set METRIC/SAE
1/4", 3/8" & 1/2" DRIVE RRP \$330.75

Description

- 1/4" Drive 6pt. Sockets: 5/32", 3/16", 7/32", 1/4", 9/32", 5/16", 11/32", 3/8", 7/16", 1/2" 1/4"
- 1/4" Drive 6pt. Sockets: 4mm, 5mm, 5.5mm, 6mm, 7mm, 8mm, 9mm, 10mm, 11mm, 12mm, 13mm
- 1/4" Drive 6pt. Deep Sockets: 1/4", 9/32", 5/16", 11/32", 3/8", 7/16", 1/2"
- 1/4" Drive 6pt. Deep Sockets: 7mm - 13mm
- 1/4" Drive Teardrop Quick Release Ratchet; 3" Extension Bar; 1/4" Drive Bit Holder Socket
- 3/8" Drive 6pt. Deep Sockets: 9/16", 5/8", 11/16", 3/4"
- 3/8" Drive 6pt. Deep Sockets: 14mm - 19mm
- 3/8" Drive 12pt. Sockets: 3/8", 7/16", 1/2", 9/16", 5/8", 11/16", 3/4", 13/16", 7/8"
- 3/8" Drive 12pt. Sockets: 10mm - 19mm, 21mm
- 3/8" Drive Teardrop Quick Release Ratchet; 6" Extension Bar; 3/8" Drive Spark Plug Socket 5/8"
- 1/2" Drive 12pt. Sockets: 11/16", 3/4", 13/16", 7/8", 15/16", 1", 1-1/8", 1-1/4"
- 1/2" Drive 12pt. Sockets: 19mm, 20mm, 21mm, 22mm, 24mm, 25mm, 27mm, 30mm, 32mm
- 1/2" Drive Quick Release Tear Drop Ratchet; 3" Extension Bar
- EVA Tray Included: uncut 655mm x 395mm, cut = 557mm x 360mm

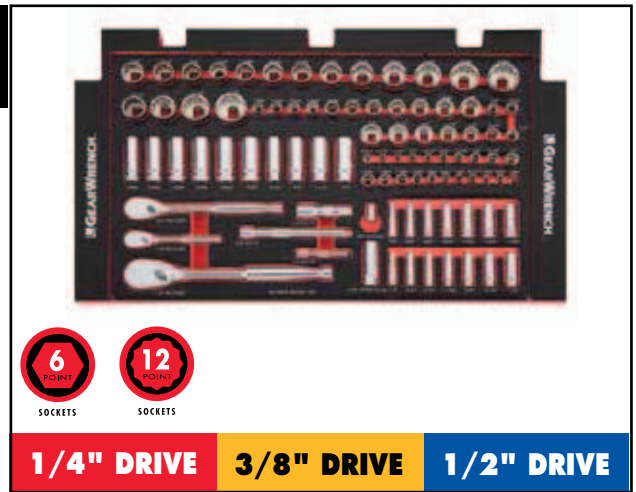

Fits drawer type **A** as shown on page 28.

83075 - 24 Pc. Ratcheting Wrench Set
METRIC/SAE RRP \$275.45

Description

- Combination Ratcheting Wrench METRIC: 7mm, 8mm, 9mm, 10mm, 11mm, 12mm, 13mm, 14mm, 15mm, 16mm, 17mm, 19mm, 20mm, 21mm, 22mm
- Combination Ratcheting Wrench SAE: 5/16", 3/8", 7/16", 1/2", 9/16", 3/8", 11/16", 3/4", 3/16"
- EVA Tray Included: uncut 655mm x 395mm, cut = 557mm x 360mm

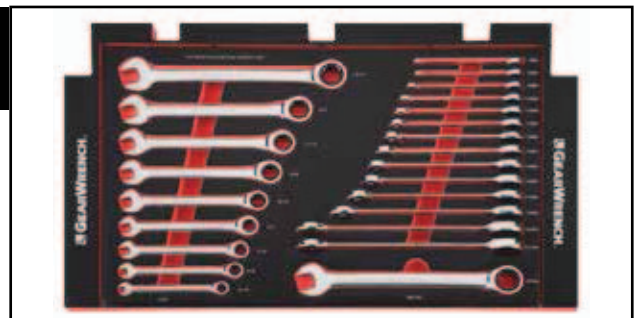

Fits drawer type **A** as shown on page 28.

83073 - 52 Pc. Screwdriver Set RRP \$209.05

Description

- Slotted Screwdrivers: 6mm x 38mm, 5mm x 150mm, 6mm x 100mm, 6mm x 150mm, 8mm x 150mm, 10mm x 200mm
- Phillips Screwdrivers: PH#0 x 65mm, PH#1 x 75mm, PH#1 x 150mm, PH#2 x 38mm, PH#2 x 100mm, PH#3 x 150mm
- Mini Slotted Screwdrivers: 1.5mm, 2.0mm, 2.5mm
- Mini Phillips Screwdrivers: PH#00, PH#0, PH#1
- Long Torx® Screwdrivers: T-15, T-20
- Hex Bits: 1/8", 5/32", 3/16", 7/32", 1/4", 5/16"
- Hex Bits: 3mm, 4mm, 5mm, 6mm, 7mm, 8mm
- Slotted Bits: 5/32", 7/32", 1/4"
- Slotted Bits: 4mm, 5.5mm, 6.5mm
- Torx® Bits: T-8, T-10, T-15, T-20, T-25, T-27, T-30, T-40
- Phillips Bits: PH#0, PH#1, PH#2, PH#3
- Ratcheting Screwdriver Handle
- 6mm Shank Magnetic Bit Shaft 150mm
- EVA Tray Included: uncut 655mm x 395mm, cut = 557mm x 360mm

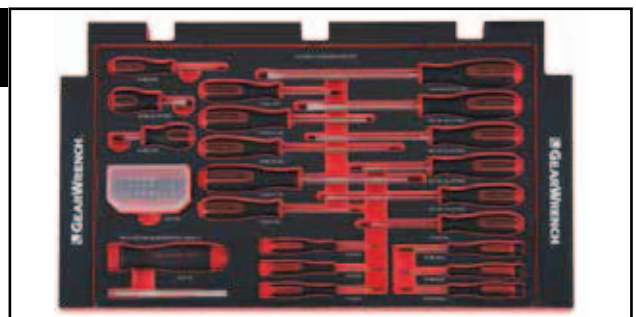

Fits drawer type **A** as shown on page 28.

Note: Individual materials may not be available for separate purchase.

MODULAR STORAGE

METAL CASE SETS



EVA tray can be easily removed for convenient storage into a tool chest/ trolley drawer

MODULAR STORAGE



**83050 - 42 Pc. Socket Set METRIC/SAE
1/4" & 3/8" DRIVE**

RRP \$153.75

Description

1/4" Drive 6pt. Sockets: 3/16", 7/32", 1/4", 9/32", 5/16", 11/32", 3/8", 7/16", 1/2", 4mm, 5mm, 6mm, 7mm, 8mm, 9mm, 10mm, 11mm, 12mm

1/4" Drive Full Polish Teardrop Ratchet; 1/4" F x 3/8" M Adapter

3/8" Drive 12pt. Sockets: 3/8", 7/16", 1/2", 9/16", 5/8", 11/16", 3/4", 8mm, 10mm, 11mm, 12mm, 13mm, 14mm, 15mm, 17mm, 19mm

3/8" Drive Full Polish Teardrop Ratchet; 3" Extension Bar; Universal Joint; 3/8" F x 1/4" M Adapter; Spark Plug Socket 5/8"; Spark Plug Socket 13/16"

EVA Tray Included: 168mm x 360mm



1/4" DRIVE 3/8" DRIVE

Fits drawer type **B** as shown on page 28.



**83058 - 23 Pc. Socket Set METRIC
1/2" DRIVE**

RRP \$186.95

Description

1/2" Drive 12pt. Standard Sockets: 8mm, 10mm, 11mm, 12mm, 13mm, 14mm, 15mm, 16mm, 17mm, 18mm, 19mm, 21mm, 22mm, 23mm, 24mm, 27mm, 30mm, 32mm;

1/2" Drive Full Polish Teardrop Ratchet 11"; 1/2" Drive Full Polish Flex Handle 15"; 1/2" Drive Universal Joint; 1/2" Drive Standard Extension 3", 1/2" Drive Standard Extension 10"

EVA tray included 250mm x 424mm



1/2" DRIVE

Fits drawer type **A** (loose fit) as shown on page 28.



**83057 - 42 Pc. Socket Set METRIC/SAE
3/8" DRIVE**

RRP \$186.95

Description

3/8" Drive 6pt. Deep Sockets: 8mm, 10mm, 11mm, 12mm, 13mm, 15mm

3/8" Drive 12pt. Sockets: 1/4", 5/16", 3/8", 7/16", 1/2", 9/16", 5/8", 11/16", 3/4", 13/16", 7/8", 15/16", 1"

3/8" Drive 12pt Sockets: 8mm, 9mm, 10mm, 11mm, 12mm, 13mm, 14mm, 15mm, 16mm, 17mm, 18mm, 19mm, 20mm, 21mm, 22mm

3/8" Drive Full Polish Teardrop Ratchet; 12" Full Polish Flex Handle; Universal Joint; 3" Extension Bar; 6" Extension Bar; 10" Extension Bar; Spark Plug Socket 5/8", Spark Plug Socket 13/16"

EVA tray included 250mm x 424mm



3/8" DRIVE

Fits drawer type **A** (loose fit) as shown in page 28.

Note: Individual materials may not be available for separate purchase.

BLOW MOULDED CASE SETS



Clasps can be easily removed and the case separated into two halves for convenient storage into a tool chest/trolley drawer

**83060 - 31 Pc. Socket Set + Wrench Set
METRIC/SAE 1/4" DRIVE** RRP \$142.70

- Description**
- 1/4" Drive 6pt. Standard Sockets: 4mm, 5mm, 6mm, 7mm, 8mm, 9mm, 10mm, 11mm, 12mm, 13mm
 - 1/4" Drive 6pt. Standard Sockets: 3/16", 7/32", 1/4", 9/32", 5/16", 11/32", 3/8", 7/16", 1/2"
 - 1/4" Drive Full Polish Teardrop Ratchet; 1/4" Drive Flex Handle 5-1/2"; 1/4" Drive Universal Joint; 1/4" Drive Standard Extension 3"
 - Long Pattern Combination Non-Ratcheting Wrenches: 8mm, 9mm, 10mm, 11mm, 12mm, 13mm, 14mm, 15mm
 - Blow moulded case - 168mm x 360mm



6
POINT
SOCKETS

1/4" DRIVE

Fits drawer type **B** as shown on page 28.

MODULAR STORAGE

**83062 - 34 Pc. Socket + Wrench Set
METRIC 1/2" DRIVE** RRP \$275.45

- Description**
- 1/2" Drive 12pt. Sockets: 8mm, 10mm, 11mm, 12mm, 13mm, 14mm, 15mm, 16mm, 17mm, 18mm, 19mm, 21mm, 22mm, 23mm, 24mm, 27mm, 30mm, 32mm;
 - 1/2" Drive Full Polish Teardrop Ratchet; 15" Full Polish Flex Handle; 3" Extension Bar; 10" Extension Bar; Universal Joint
 - Reversible Combination Ratcheting Wrench: 10mm, 11mm, 12mm, 13mm, 14mm, 15mm, 16mm, 17mm, 19mm
 - Blow moulded case - 565mm x 360mm x 90mm



12
POINT
SOCKETS

1/2" DRIVE

Fits drawer type **A** as shown on page 28.

STANDARD SET

82820 - 4 Pc. 8" Standard File Set RRP \$72.85

Material No.	Description	Material No.	Description
82824	Half Round	82825	Triangle Bastard
82823	Round Bastard	82822D	Flat Bastard

- Ergonomic Dual Material Handle



Note: Individual materials may not be available for separate purchase.

RATCHETS, SOCKETS & DRIVE TOOLS



Drive Tools

Multidrive Sets
1/4" Drive Sets
1/4" Drive Open Stock
3/8" Drive Sets
3/8" Drive Open Stock

1/2" Drive Sets
1/2" Drive Open Stock
3/4" Drive Sets
3/4" Drive Open Stock

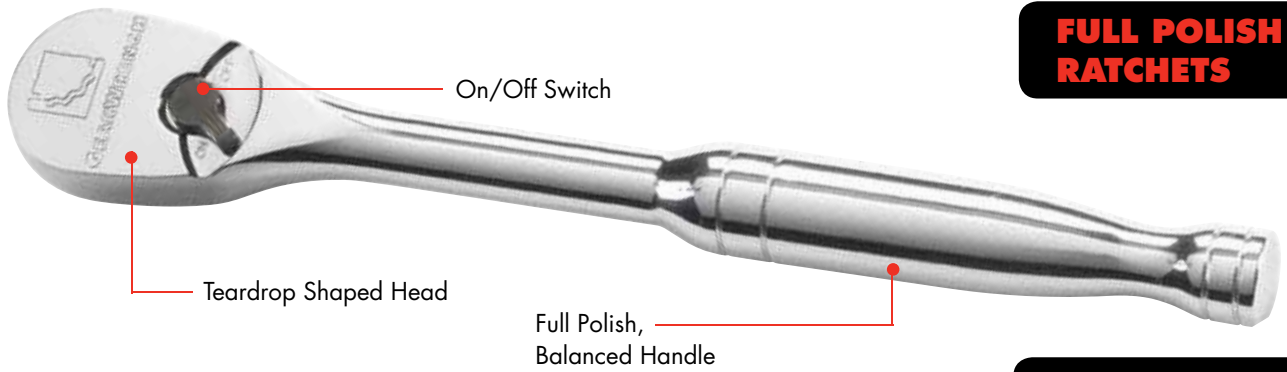

FULL POLISH RATCHETS



Lower profile head provides better access

- AVAILABLE IN:**
- Flex Head Ratchets
 - Teardrop Head Ratchets
 - Stubby Ratchets
 - Offset Ratchets

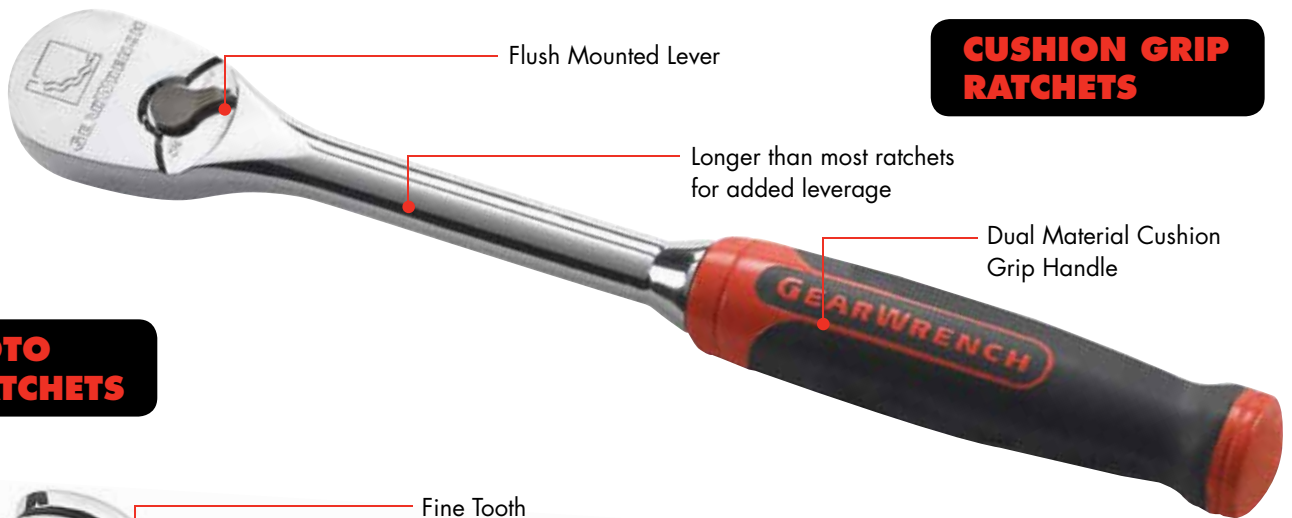

CUSHION GRIP RATCHETS

ROTO RATCHETS



Head Rotates 180 Degrees

Less Than 5 Degree Swing Arc for Greater Access



- APPLICATIONS**
- Head bolts with variable obstructions
 - Spark plug service
 - In vertical position can speed down like a screwdriver
 - In horizontal position, provides increased torque

SOCKETS

AVAILABLE IN:

- Standard
- Deep
- Spark Plug
- Flex



Entry angle guides fastener
Serration depth as deep as the fastener



Large hard-stamped identification

Double Line (SAE) & Knurled Line (MM) to easily identify Standard vs. Metric Sockets

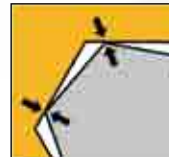

Ordinary socket

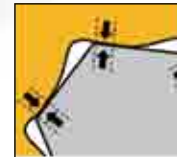

Surface Drive® Technology

DRIVE TOOLS

6 Pt. Flex Socket Set



3/8" Drive Standard Extension



Adapter



Universal Joint

MULTI-DRIVE SETS

80934 - 239 Pc. SAE/METRIC 6 & 12 Pt. Mechanics Tool Set MULTI DRIVE RRP \$737.45



Material No.	Description	Material No.	Description
	1/4" DR. 6 PT. SAE SOCKET	80216	3/8"
80104	5/32"	80217	7/16"
80105	3/16"	80218	1/2"
80106	7/32"	80219	9/16"
80107	1/4"	81014	1/4" Dr. Quick-Release Teardrop Ratchet
80108	9/32"	81101	1/4" Dr. 2" Extension
80109	5/16"	81113	1/4" Dr. 3" Extension
80110	11/32"	81116	1/4" Dr. 6" Extension
80111	3/8"		3/8" DR. 6 PT. SAE SOCKET
80112	7/16"	80350	1/4"
80113D	1/2"	80351	5/16"
80114D	9/16"	80352	3/8"
	1/4" DR. 6 PT. METRIC SOCKET	80353	7/16"
80125	4 mm	80354	1/2"
80126	5 mm	80355	9/16"
80127	5.5 mm	80356	5/8"
80128	6 mm	80357	11/16"
80129	7 mm	80358	3/4"
80130	8 mm	80359	13/16"
80131	9 mm	80360	7/8"
80132	10 mm		3/8" DR. 6 PT. METRIC SOCKET
80133	11 mm		6 mm - 22 mm
80134	12 mm		3/8" DR. 6 PT. DEEP SAE SOCKET
80135	13 mm	80365	3/8"
80136	14 mm	80366	1/4"
80137	15 mm	80367	7/16"
	1/4" DR. 6 PT. DEEP SAE SOCKET	80368	1/2"
80115	3/16"	80369	9/16"
80116D	7/32"	80370	5/8"
80117	1/4"	80371	11/16"
80118	9/32"		3/8" DR. 6 PT. DEEP METRIC SOCKET
80119	5/16"		9 mm - 19 mm
80120D	11/32"		3/8" DR. 12 PT. SAE SOCKET
80121	3/8"	80496	1/4"
80122D	7/16"	80498	5/16"
80123	1/2"	80498	3/8"
80124	9/16"	80499	7/16"
	1/4" DR. 6 PT. DEEP METRIC SOCKET	80500	1/2"
4 mm - 14 mm		80501	9/16"
	1/4" DR. 12 PT. SAE SOCKET	80502	5/8"
80210	3/16"	80503	11/16"
80211	7/32"	80504	3/4"
80212	1/4"	80505	13/16"
80213	9/32"	80506	7/8"
80214	5/16"		3/8" DR. 12 PT. METRIC SOCKET
80215	11/32"		15 mm - 27 mm

Material No.	Description	Material No.	Description
	6 mm - 22 mm	81309	1/2" Dr. Quick-Release Teardrop Ratchet
81218	3/8" Dr. Quick-Release Teardrop Ratchet	81340	1/2" Dr. 3" Extension
82783	1/4" Magnetic Bit Holding Screwdriver	81341	1/2" Dr. 5" Extension
81241	3/8" Dr. 3" Extension		12 PT. NON-RATCHETING COMBINATION WRENCH
81242	3/8" Dr. 6" Extension	81650	1/4"
80402	5/8" Spark Plug Socket 3/8" Dr.	81652	5/16"
80403	13/16" Spark Plug Socket 3/8" Dr.	81653	11/32"
	1/2" DR. 12 PT. SAE SOCKET	81654	3/8"
80760	7/16"	81655	7/16"
80761	1/2"	81656	1/2"
80762	9/16"	81657	9/16"
80763	5/8"	81658	5/8"
80764	11/16"	81659	11/16"
80765	3/4"	81660	3/4"
80766	13/16"		6 mm - 19 mm
80767	7/8"	56603G	13 Pc. Hex Key
80768	15/16"	56606G	9 Pc. Metric Hex Key
80769	1"		#1 - #3 Bit Phillips
80770	1-1/16"		4mm - 6mm Bit Slotted
80771	1-1/8"		T40, T45, T50 Bit Torx®
80793	1-3/16"		3/16", 1/4", 5/16", 11/32", 3/8", 7/16", 1/2" Nut Driver Bit
80794	1-1/4"		5 mm - 11 mm Nut Driver Bit
80680	1-1/2"		
	1/2" DR. 12 PT. METRIC SOCKET		
	15 mm - 27 mm		

Note: Individual materials may not be available for separate purchase.

MULTI-DRIVE SETS
RATCHETS, SOCKETS & DRIVE TOOLS

MULTI-DRIVE SETS



80933 - 216 Pc. SAE/METRIC 6 & 12 Pt. Mechanics Tool Set MULTI DRIVE RRP \$589.95

RATCHETS, SOCKETS & DRIVE TOOLS

1/4" DRIVE 3/8" DRIVE 1/2" DRIVE

Material No.	Description	Material No.	Description
	1/4" DR. 6 PT. SAE SOCKET	80117	1/4"
80104	5/32"	80118	9/32"
80105	3/16"	80119	5/16"
80106	7/32"	80120	11/32"
80107	1/4"	80121	3/8"
80108	9/32"	80122	7/16"
80109	5/16"	80123	1/2"
80110	11/32"	80124	9/16"
80111	3/8"		1/4" DR. 6 PT. DEEP METRIC SOCKET
80112	7/16"		4 mm - 14 mm
80113	1/2"	81014	1/4" Dr. Quick-Release Teardrop Ratchet
80114	9/16"	81113	1/4" Dr. 3" Extension
	1/4" DR. 6 PT. METRIC SOCKET	81128	1/4" Dr. Spinner Handle
80125	4 mm	80480	1/4" Dr. 1/4" Bit Holder Socket
80126	5 mm		3/8" DR. 6 PT. SAE SOCKET
80127	5.5 mm	80350	1/4"
80128	6 mm	80351	5/16"
80129	7 mm	80352	3/8"
80130	8 mm	80353	7/16"
80131	9 mm	80354	1/2"
80132	10 mm	80355	9/16"
80133	11 mm	80356	5/8"
80134	12 mm	80357	11/16"
80135	13 mm	80358	3/4"
80136	14 mm	80359	13/16"
80137	15 mm	80360	7/8"
	1/4" DR. 6 PT. DEEP SAE SOCKET		
80115	3/16"		
80116	7/32"		

Material No.	Description	Material No.	Description
	3/8" DR. 6 PT. METRIC SOCKET	80770	1-1/16"
	9 mm - 22 mm	80771	1-1/8"
	3/8" DR. 6 PT. DEEP SAE SOCKET	80793	1-3/16"
80365	3/8"	80794	1-1/4"
80366	1/4"	80680	1-1/2"
80367	7/16"		1/2" DR. 12 PT. METRIC SOCKET
80368	1/2"	80750	15 mm
80369	9/16"	80751	16 mm
80370	5/8"	80752	17 mm
80371	11/16"	80753	18 mm
	3/8" DR. 6 PT. DEEP METRIC SOCKET	80754	19 mm
	9 mm - 19 mm	80756	21 mm
	3/8" DR. 12 PT. SAE SOCKET	80757	22 mm
80496	1/4"	80759	24 mm
80497	5/16"	80811	25 mm
80498	3/8"	80812	27 mm
80499	7/16"	80682	28 mm
80500	1/2"	80813	30 mm
80501	9/16"	80814	32 mm
80502	5/8"		
80503	11/16"	81309	1/2" Dr. Quick-Release Teardrop Ratchet
80504	3/4"	81340	3" Extension
80505	13/16"		12 PT. NON-RATCHETING COMBINATION WRENCH
80506	7/8"		
	3/8" DR. 12 PT. METRIC SOCKET	81650	1/4"
	9 mm - 22 mm	81652	5/16"
81218	3/8" Dr. Quick-Release Teardrop Ratchet	81653	11/32"
81241	3/8" Dr. 3" Extension	81654	3/8"
81242	3/8" Dr. 6" Extension	81655	7/16"
	3/8" DR. SPARK PLUG SOCKET	81656	1/2"
80402	5/8"	81657	9/16"
80403	13/16"	81658	5/8"
	1/2" DR. 12PT. SAE SOCKET	81659	11/16"
80402	5/8"	81660	3/4"
80403	13/16"		7 mm - 15 mm
80760	7/16"	56603G	13 Pc. Hex Key
80761	1/2"	56606G	9 Pc. Metric Hex Key
80762	9/16"		#1 - #3 Bit Phillips
80763	5/8"		4mm - 6mm Bit Slotted
80764	11/16"		T40, T45, T50 Bit Torx®
80765	3/4"		3/16", 1/4", 5/16", 11/32", 3/8", 7/16", 1/2" Nut Driver Bit
80766	13/16"		
80767	7/8"		
80768	15/16"		5mm - 11mm Nut Driver Bit
80769	1"		

Note: Individual materials may not be available for separate purchase.

MULTI-DRIVE SETS

80932 - 165 Pc. SAE/METRIC 6 & 12 Pt. Mechanics Tool Set MULTI DRIVE RRP \$463.50

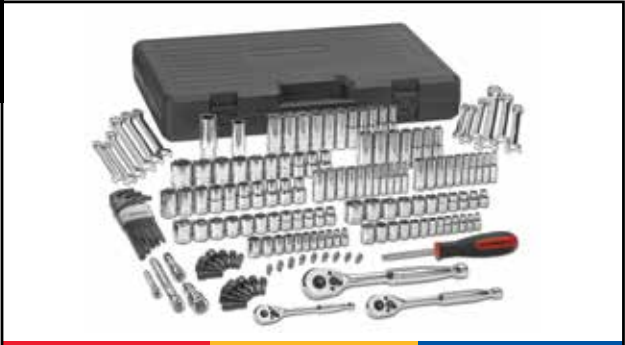

1/4" DRIVE **3/8" DRIVE** **1/2" DRIVE**

Material No.	Description	Material No.	Description
	1/4" DR. 6 PT. SAE SOCKET	80148	13 mm
80104	5/32"	80149	14 mm
80105	3/16"		
80106	7/32"	81014	1/4" Dr. Quick-Release Teardrop Ratchet
80107	1/4"	81113	1/4" Dr. 3" Extension
80108	9/32"		
80109	5/16"	81128	1/4" Dr. Spinner Handle
80110	11/32"		
80111	3/8"	80480	1/4" Dr. 1/4" Bit Holder Socket
80112	7/16"		
80113	1/2"	3/8" DR. 6 PT. SAE SOCKET	
80114	9/16"	80350	1/4"
		80351	5/16"
	1/4" DR. 6 PT. METRIC SOCKET	80352	3/8"
80125	4 mm	80353	7/16"
80126	5 mm	80354	1/2"
80127	5.5 mm	80355	9/16"
80128	6 mm	80356	5/8"
80129	7 mm	80357	11/16"
80130	8 mm	80358	3/4"
80131	9 mm	80359	13/16"
80132	10 mm	80360	7/8"
80133	11 mm	3/8" DR. 6 PT. METRIC SOCKET	
80134	12 mm	80377	9 mm
80135	13 mm	80378	10 mm
80136	14 mm	80379	11 mm
80137	15 mm	80380	12 mm
	1/4" DR. 6 PT. DEEP SAE SOCKET	80381	13 mm
80115	3/16"	80382	14 mm
80116	7/32"	80383	15 mm
80117	1/4"	80384	16 mm
80118	9/32"	80385	17 mm
80119	5/16"	80386	18 mm
80120	11/32"	80387	19 mm
80121	3/8"	80330	20 mm
80122	7/16"	3/8" DR. 6 PT. DEEP SAE SOCKET	
80123	1/2"	80365	3/8"
80124	9/16"	80366	1/4"
	1/4" DR. 6 PT. DEEP METRIC SOCKET	80367	7/16"
80138	4 mm	80368	1/2"
80139	5 mm	80369	9/16"
80141	6 mm	80370	5/8"
80142	7 mm	80371	11/16"
80143	8 mm	3/8" DR. 6 PT. DEEP METRIC SOCKET	
80144	9 mm	80391	9 mm
80145	10 mm	80392	10 mm
80146	11 mm	80393	11 mm
80147	12 mm	80394	12 mm

Material No.	Description	Material No.	Description
80395	13 mm	81340	1/2" Dr. 3" Extension
80396	14 mm		
80397	15 mm	12 PT. NON-RATCHETING COMBINATION WRENCH	
80398	16 mm	81652	5/16"
80399	17 mm	81654	3/8"
80400	18 mm	81655	7/16"
80401	19 mm	81656	1/2"
		81657	9/16"
81218	3/8" Dr. Quick-Release Teardrop Ratchet	81660	3/4"
81241	3/8" Dr. 3" Extension	81666	9 mm
81242	3/8" Dr. 6" Extension	81667	10 mm
	3/8" DR. SPARK PLUG SOCKET	81669	12 mm
80402	5/8"	81670	13 mm
80403	13/16"	81671	14 mm
	1/2" DR. 6PT. SAE SOCKET	81672	15 mm
80602	7/16"	56603G	13 Pc. Hex Key
80603	1/2"	#1	Bit Phillips
80604	9/16"	#2	Bit Phillips
80605	5/8"	#3	Bit Phillips
80606	11/16"	4mm	Bit Slotted
80607	3/4"	5mm	Bit Slotted
80608	13/16"	6mm	Bit Slotted
80609	7/8"	T40	Bit Torx®
80610	15/16"	T45	Bit Torx®
80611	1"	T50	Bit Torx®
	1/2" DR. 6PT. METRIC SOCKET	3/16"	Nut Driver Bit
80622	10 mm	1/4"	Nut Driver Bit
80623	11 mm	5/16"	Nut Driver Bit
80624	12 mm	11/32"	Nut Driver Bit
80625	13 mm	3/8"	Nut Driver Bit
80626	14 mm	7/16"	Nut Driver Bit
80627	15 mm	1/2"	Nut Driver Bit
80628	16 mm	5 mm	Nut Driver Bit
80629	17 mm	6 mm	Nut Driver Bit
80630	18 mm	7 mm	Nut Driver Bit
80631	19 mm	8 mm	Nut Driver Bit
		9 mm	Nut Driver Bit
81309	1/2" Dr. Quick-Release Teardrop Ratchet	10 mm	Nut Driver Bit
		11 mm	Nut Driver Bit

Note: Individual materials may not be available for separate purchase.

MULTI-DRIVE SETS

RATCHETS, SOCKETS & DRIVE TOOLS

MULTI-DRIVE SETS

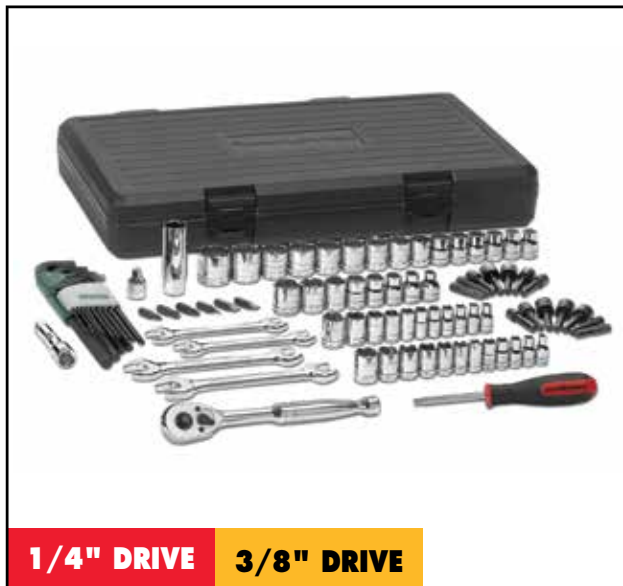

80930 - 88 Pc. SAE/METRIC 6 & 12 Pt. Mechanics Tool Set MULTI DRIVE

RRP \$221.25

Material No.	Description	Material No.	Description
1/4" DR. 6 PT. SAE SOCKET		3/8" DR. 12 PT. METRIC SOCKET	
80104	5/32"	80485	9 mm
80105	3/16"	80486	10 mm
80106	7/32"	80487	11 mm
80107	1/4"	80488	12 mm
80108	9/32"	80489	13 mm
80109	5/16"	80490	14 mm
80110	11/32"	80491	15 mm
80111	3/8"	80492	16 mm
80112	7/16"	80493	17 mm
80113	1/2"	80494	18 mm
80114	9/16"	80495	19 mm
1/4" DR. 6 PT. METRIC SOCKET		81218	3/8" Dr. Quick-Release Teardrop Ratchet
80125	4 mm	81128	1/4" Dr. Spinner Handle
80126	5 mm	81241	3/8" Dr. 3" Extension
80127	5.5 mm	80402	3/8" Dr. 5/8" Spark Plug Socket
80128	6 mm	81277	3/8" Dr. 3/8" F x 1/4" M Adapter
80129	7 mm	DOUBLE OPEN END WRENCH	
80130	8 mm	81794	10 x 12 mm
80131	9 mm	81796	12 x 14 mm
80132	10 mm	81799	3/8" x 7/16"
80133	11 mm	81801	1/2" x 9/16"
80134	12 mm	56603G	13 Pc. SAE Hex Key
80135	13 mm	#1	Bit Phillips
80136	14 mm	#2	Bit Phillips
80480	1/4" Dr. 1/4" Bit Holder Socket	#3	Bit Phillips
3/8" DR. 6 PT. SAE SOCKET		4mm	Bit Slotted
80496	1/4"	5mm	Bit Slotted
80497	5/16"	6mm	Bit Slotted
80498	3/8"		
80499	7/16"		
80500	1/2"		
80501	9/16"		
80502	5/8"		
80503	11/16"		
80504	3/4"		
80505	13/16"		
80506	7/8"		

Note: Individual materials may not be available for separate purchase.

MULTI-DRIVE SETS

80931 - 141 Pc. SAE/METRIC 6 & 12 Pt. Mechanics Tool Set MULTI DRIVE RRP \$389.85



Material No.	Description	Material No.	Description
	1/4" DR. 6 PT. SAE SOCKET	80354	1/2"
80104	5/32"	80355	9/16"
80105	3/16"	80356	5/8"
80106	7/32"	80357	11/16"
80107	1/4"	80358	3/4"
80108	9/32"		3/8" DR. 6 PT. METRIC SOCKET
80109	5/16"	80378	10 mm
80110	11/32"	80379	11 mm
80111	3/8"	80380	12 mm
80112	7/16"	80381	13 mm
80113	1/2"	80382	14 mm
	1/4" DR. 6 PT. METRIC SOCKET	80383	15 mm
80125	4 mm	80384	16 mm
80126	5 mm	80385	17 mm
80127	5.5 mm	80386	18 mm
80128	6 mm	80387	19 mm
80129	7 mm		3/8" DR. 6 PT. DEEP SAE SOCKET
80130	8 mm	80365	3/8"
80131	9 mm	80366	1/4"
80132	10 mm	80367	7/16"
80133	11 mm	80368	1/2"
80134	12 mm	80369	9/16"
80135	13 mm	80370	5/8"
	1/4" DR. 6 PT. DEEP SAE SOCKET	80371	11/16"
80117	1/4"		3/8" DR. 6 PT. DEEP METRIC SOCKET
80118	9/32"	80392	10 mm
80119	5/16"	80393	11 mm
80120	11/32"	80394	12 mm
80121	3/8"	80395	13 mm
80122	7/16"	80396	14 mm
80123	1/2"	80397	15 mm
	1/4" DR. 6 PT. DEEP METRIC SOCKET	80398	16 mm
80142	7 mm	80399	17 mm
80143	8 mm	80400	18 mm
80144	9 mm	80401	19 mm
80145	10 mm		3/8" DR. 12 PT. SAE SOCKET
80146	11 mm	80498	3/8"
80147	12 mm	80499	7/16"
80148	13 mm	80500	1/2"
81014	1/4" Dr. Quick-Release Teardrop Ratchet	80501	9/16"
81113	1/4" Dr. 3" Extension	80502	5/8"
80480	1/4" Dr. 1/4" Bit Holder Socket	80503	11/16"
	3/8" DR. 6 PT. SAE SOCKET	80504	3/4"
80352	3/8"		3/8" DR. 12 PT. METRIC SOCKET
80353	7/16"	80489	12 mm
		80490	14 mm
		80491	15 mm

Material No.	Description	Material No.	Description
80492	16 mm	56603G	13 Pc. Hex Key
80493	17 mm	#1	Bit Phillips
80494	18 mm	#2	Bit Phillips
80495	19 mm	#3	Bit Phillips
81218	3/8" Dr. Quick-Release Teardrop Ratchet	4mm	Bit Slotted
81242	3/8" Dr. 6" Extension	5mm	Bit Slotted
80402	3/8" Dr. 5/8" Spark Plug Socket	6mm	Bit Slotted
	1/2" DR. 6PT. SAE SOCKET	T40	Bit Torx®
80764	11/16"	T45	Bit Torx®
80765	3/4"	T50	Bit Torx®
80766	13/16"	3/16"	Nut Driver Bit
80767	7/8"	1/4"	Nut Driver Bit
80768	15/16"	5/16"	Nut Driver Bit
80769	1"	11/32"	Nut Driver Bit
	1/2" DR. 6PT. METRIC SOCKET	3/8"	Nut Driver Bit
80750	15 mm	7/16"	Nut Driver Bit
80751	16 mm	1/2"	Nut Driver Bit
80752	17 mm	5 mm	Nut Driver Bit
80753	18 mm	6 mm	Nut Driver Bit
80754	19 mm	7 mm	Nut Driver Bit
80756	21 mm	8 mm	Nut Driver Bit
81309	1/2" Dr. Quick-Release Teardrop Ratchet	9 mm	Nut Driver Bit
81340	1/2" Dr. 3" Extension	10 mm	Nut Driver Bit
	DOUBLE OPEN END WRENCH	11 mm	Nut Driver Bit
81794	10 x 12 mm		
81796	12 x 14 mm		
81799	3/8"x 7/16"		
81801	1/2"x 9/16"		

Note: Individual materials may not be available for separate purchase.

MULTI-DRIVE SETS

RATCHETS, SOCKETS & DRIVE TOOLS

MULTI-DRIVE SETS

RATCHETS, SOCKETS & DRIVE TOOLS
MULTI DRIVE SETS



1/4" DRIVE **3/8" DRIVE**

83001D - 118 Pc. SAE/METRIC 6 & 12 Pt. Standard Socket Set MULTI DRIVE RRP \$368.70

Material No.	Description	Material No.	Description
	TAMPER PROOF TORX® BIT		1/4" DR. 12 PT. STANDARD SAE SOCKET
80472	Insert Bit T-15	80210	3/16"
80473	Insert Bit T-20	80211	7/32"
80474	Insert Bit T-25	80212	1/4"
80475	Insert Bit T-27	80213	9/32"
80471	Insert Bit T-10	80214	5/16"
80476	Insert Bit T-30	80215D	11/32"
	1/4" DRIVE TORX® TAMPER-PROOF BIT SOCKET	80216	3/8"
80178	T-7	80217	7/16"
80179	T-8	80218	1/2"
			1/4" DR. 6PT. STANDARD METRIC SOCKET
80180	T-10	80125	4 mm
80182	T-20	80126	5 mm
80181	T-15	80128	6 mm
80480	1/4" Dr. Bit Holder Socket	80129	7 mm
		80130	8 mm
80402	3/8" Dr. Spark Plug Socket 5/8"	80131D	9 mm
		80132	10 mm
	1/4" DR. 6 PT. STANDARD SAE SOCKET	80133	11 mm
80105	3/16"	80134	12 mm
80106	7/32"	80135D	13 mm
80107	1/4"		1/4" DR. 6PT. DEEP SOCKET
80108	9/32"	80117	1/4"
80109	5/16"	80118	9/32"
80110	11/32"	80119	5/16"
80111	3/8"	81020D	11/32"
80112	7/16"	80121	3/8"
80113D	1/2"	80122D	7/16"
80114D	9/16"	80123	1/2"

Material No.	Description	Material No.	Description
80142	7 mm	80516	11/16"
80143	8 mm		3/8" DR. 6PT. DEEP METRIC SOCKET
80144	9 mm	80392	10 mm
80145	10 mm	80394D	12 mm
80146D	11 mm	80395	13 mm
80147	12 mm	80396	14 mm
80148	13 mm	80397	15 mm
	3/8" DR. 12PT. STANDARD SAE SOCKET	80398	16 mm
80498	3/8"	80399	17 mm
8090	7/16"		1/2" DR. 12PT. DEEP SAE SOCKET
80500D	1/2"	80772	7/16"
80501	9/16"	80773	1/2"
80502	5/8"	80774	9/16"
80503	11/16"	80775	5/8"
80504	3/4"	80776	11/16"
80505	13/16"	80777D	3/4"
	3/8" DR. 6PT. STANDARD METRIC SOCKET	80778	13/16"
80377	9 mm		LONG PATTERN COMBINATION WRENCH
80378	10 mm	81675	18 mm
80379	11 mm	81676	19 mm
80380	12 mm	81655	7/16"
80381	13 mm	81656	1/2"
80382	14 mm	81657	9/16"
80383	15 mm		3/8" Drive Standard Extension 3"
80385	17 mm		3/8" Drive Standard Extension 6"
80387	19 mm		1/2" Drive Wobble Extension 5"
	3/8" DR. 12PT. STANDARD METRIC SOCKET	81119	1/4" Drive Wobble Extension 2"
80485	9 mm	81128	1/4" Socket Driver
80486	10 mm		1/4" Drive Full Polish Teardrop 84 Tooth Ratchet
80487	11 mm		3/8" Drive Full Polish Teardrop 84 Tooth Ratchet
80488	12 mm		1/2" Drive Full Polish Teardrop 84 Tooth Ratchet
80489	13 mm		
80490	14 mm		
80491	15 mm		
80492	16 mm		
80493	17 mm		
80494	18 mm		
80495	19 mm		
	3/8" DR. 12PT. DEEP SAE SOCKET		
80510D	5/16"		
80511	3/8"		
80512	7/16"		
80513	1/2"		
80514	9/16"		
80515D	5/8"		

Note: Individual materials may not be available for separate purchase.

MULTI-DRIVE SETS

83000 - 68 Pc. SAE/METRIC 6 & 12 Pt. Standard Socket Set MULTI DRIVE RRP \$200.20

Material No.	Description	Material No.	Description
1/4" DR. 6 PT. DEEP SOCKETS		3/8" DR. 12 PT. SAE SOCKET	
80115	3/16"	80498	3/8"
80116D	7/32"	80499	7/16"
80117	1/4"	80500D	1/2"
80118	9/32"	80501	9/16"
80119	5/16"	80502	5/8"
80120D	11/32"	80503	11/16"
80121	3/8"	80504	3/4"
80122	7/16"	80505	13/16"
80123	1/2"	80506D	7/8"
1/4" DR. 6 PT. METRIC SOCKETS		1/4" DR. 12 PT. METRIC SOCKETS	
80141	6 mm	80197	4 mm
80142	7 mm	80198	5 mm
80143	8 mm	80200	6 mm
80144	9 mm	80201	7 mm
80145	10 mm	80202	8 mm
80146D	11 mm	80203	9 mm
80147	12 mm	80204	10 mm
80148	13 mm	80205	11 mm
80149	14 mm	80206	12 mm
3/8" DR. 6 PT. DEEP SAE SOCKETS		1/4" DR. 12 PT. SAE SOCKETS	
80365	3/8"	80210	3/16"
80366	1/4"	80211	7/32"
80367	7/16"	80212	1/4"
80368	1/2"	80213	9/32"
80369	9/16"	80214	5/16"
80370D	5/8"	80215	11/32"
80371	11/16"	80216	3/8"
80372	3/4"	80217	7/16"
3/8" DR. 12 PT. METRIC SOCKET		80218 1/2"	
80485	9 mm	81101	1/4" Dr. 2" Extension
80486	10 mm	81116	1/4" Dr. 6" Extension
80487	11 mm	81241	3/8" Dr. 3" Extension
80488	12 mm	81242	3/8" Dr. 6" Extension
80489	13 mm	81011F	1/4" Dr. Full Polish Teardrop Ratchet
80490	14 mm	81211F	3/8" Dr. Full Polish Teardrop Ratchet
80491	15 mm	83000BM	Replacement Blow Mold Case
80492	16 mm		
80493	17 mm		



MULTI-DRIVE SETS
RATCHETS, SOCKETS & DRIVE TOOLS

Note: Individual materials may not be available for separate purchase.

MICRODRIVER SET



85035 - 35 Pc. Microdriver Set RRP \$52.65

Description

1/4" x 5/16" Double Box MicroDriver™
1/4" Drive Socket Adapter
5/16", 3/8", 7/16", 1/2", 9/16" S.A.E. Sockets (6pt)
8mm, 10mm, 12mm, 14mm Metric Sockets (6pt)
5/32", 7/32", 9/32" 1/4" Bit, Slotted
#1, #2, #3 Bit, Phillips
3/32", 1/8", 5/32", 3/16", 1/4", 5/16" Bit, Hex
T20, T25, T30, T40 Bit, Torx®
#2, #3 Bit, Square
5/16", 3/8" 5/16" Bit, Slotted
3/8" 5/16" Bit, Hex
T45, T50 5/16" Bit, Torx®

RATCHETS/ADAPTERS



81205 - 10 Pc. Universal Adapter Set
MULTI DRIVE RRP \$73.75

Material No.	Description		
80100	Universal Joint		1/4" Dr.
80549	Universal Joint		3/8" Dr.
80101	Impact Universal Joint		1/4" Dr.
80548	Universal Joint		3/8" Dr.
80671	Universal Joint		1/2" Dr.
Material No.	Description	Material No.	Description
81127	1/4" F x 3/8" M	81354	1/2" F x 3/8" M
81277	3/8" F x 1/4" M	81355	1/2" F x 3/4" M
81278	3/8" F x 1/2" M		



81217 - 4 Pc. Clip Rail Adapter Set
MULTI DRIVE RRP \$25.30

Material No.	Description	Material No.	Description
81127	1/4" F x 3/8" M	81278	3/8" F x 1/2" M
81277	3/8" F x 1/4" M	81354	1/2" F x 3/8" M



81206P - 3 Pc. 120XP Full Polish Teardrop Ratchet Set
MULTI DRIVE RRP \$121.70

Material No.	Description	Material No.	Des	Material No.	Desc
81011P	1/4" Dr.	81211P	3/8" Dr.	81304P	1/2" Dr.

- 120 positions
- 3 degree ratcheting arc

Note: Individual materials may not be available for separate purchase.

1/4" DRIVE SETS

80300 - 51 Pc. SAE/METRIC 6 Pt. Standard & Deep Socket Set 1/4" DRIVE RRP \$158.05

Material No.	Description	Material No.	Description
1/4" DR. 6 PT. SAE SOCKET			
80105	3/16"	80115	3/16"
80106	7/32"	80116	7/32"
80107	1/4"	80117	1/4"
80108	9/32"	80118	9/32"
80109	5/16"	80119	5/16"
80110	11/32"	80120	11/32"
80111	3/8"	80121	3/8"
80112	7/16"	80122	7/16"
80113	1/2"	80123	1/2"
80114	9/16"	80124	9/16"
1/4" DR. 6 PT. METRIC SOCKET			
80125	4 mm	80138	4 mm
80126	5 mm	80139	5 mm
80127	5.5 mm	80140	5.5 mm
80128	6 mm	80141	6 mm
80129	7 mm	80142	7 mm
80130	8 mm	80143	8 mm
80131	9 mm	80144	9 mm
80132	10 mm	80145	10 mm
80133	11 mm	80146	11 mm
80134	12 mm	80147	12 mm
80135	13 mm	80148	13 mm
80136	14 mm	80149	14 mm
80137	15 mm	80150	15 mm



Material No.	Description
81101	1/4" Dr. 2" Extension
81116	1/4" Dr. 6" Extension
80100	1/4" Dr. Universal Joint
81008	1/4" Dr. Thumbwheel Ratchet
81011	1/4" Dr. Full Polish Teardrop Ratchet
83000BM	Replacement Blow Mold Case

80300P - 51 Pc. SAE/METRIC 6 Pt. Standard & Deep Socket Set 1/4" DRIVE RRP \$150.75

Material No.	Description	Material No.	Description
1/4" DR. 6 PT. SAE SOCKET			
80105	3/16"	80115	3/16"
80106	7/32"	80116D	7/32"
80107	1/4"	80117	1/4"
80108	9/32"	80118	9/32"
80109	5/16"	80119	5/16"
80110	11/32"	80120D	11/32"
80111	3/8"	80121	3/8"
80112	7/16"	80122D	7/16"
80113D	1/2"	80123	1/2"
80114D	9/16"	80124	9/16"
1/4" DR. 6 PT. METRIC SOCKET			
80125	4 mm	80138	4 mm
80126	5 mm	80139	5 mm
80127	5.5 mm	80140	5.5 mm
80128	6 mm	80141	6 mm
80129	7 mm	80142	7 mm
80130	8 mm	80143	8 mm
80131D	9 mm	80144	9 mm
80132	10 mm	80145	10 mm
80133	11 mm	80146D	11 mm
80134	12 mm	80147	12 mm
80135D	13 mm	80148	13 mm
80136	14 mm	80149	14 mm
80137	15 mm	80150	15 mm



Material No.	Description
81101	1/4" Dr. 2" Extension
81116	1/4" Dr. 6" Extension
80100	1/4" Dr. Universal Joint
81008	1/4" Dr. Thumbwheel Ratchet
81011P	1/4" Dr. Full Polish Teardrop Ratchet 120XP™

Note: Individual materials may not be available for separate purchase.

1/4" DRIVESETS
RATCHETS, SOCKETS & DRIVE TOOLS

1/4" DRIVE SETS

RATCHETS, SOCKETS & DRIVE TOOLS



80327 - 22 Pc. METRIC 6 & 12 Pt. Standard & Deep Socket Set 1/4" DRIVE

RRP \$73.75

Material No.	Description	Material No.	Description
	1/4" DR. 12 PT. METRIC SOCKET		1/4" DR. 6 PT. DEEP METRIC SOCKET
81097	4 mm	80141	6 mm
80198	5 mm	80142	7 mm
80200	6 mm	80143	8 mm
80201	7 mm	80144	9 mm
80202	8 mm	80145	10 mm
80203	9 mm	80146D	11 mm
80204	10 mm	80147	12 mm
80205	11 mm	80148	13 mm
80206	12 mm	80149	14 mm
81101	1/4" Drive Standard Extension 2"		
81116	1/4" Drive Standard Extension 6"		
81128	1/4" Socket Driver		
81011F	1/4" Drive Full Polish Teardrop 84 Tooth Ratchet		



83060 - 31 Pc. Socket Set + Wrench Set METRIC/SAE 1/4" DRIVE

RRP \$142.70

Description
1/4" Drive 6pt. Standard Sockets: 4mm, 5mm, 6mm, 7mm, 8mm, 9mm, 10mm, 11mm, 12mm, 13mm
1/4" Drive 6pt. Standard Sockets: 3/16", 7/32", 1/4", 9/32", 5/16", 11/32", 3/8", 7/16", 1/2"
1/4" Drive Full Polish Teardrop Ratchet; 1/4" Drive Flex Handle 5-1/2"; 1/4" Drive Universal Joint; 1/4" Drive Standard Extension 3"
Long Pattern Combination Non-Ratcheting Wrenches: 8mm, 9mm, 10mm, 11mm, 12mm, 13mm, 14mm, 15mm
Blow moulded case - 168mm x 360mm

Fits drawer type **B** as shown on page 34.

Note: Individual materials may not be available for separate purchase.

1/4" DRIVE OPEN STOCK

Full Polish Teardrop Ratchet 1/4" DRIVE

Material No.	Description	Overall Length (mm)	Weight (g)	RRP
81011F	Full Polish Teardrop Ratchet	130	100	\$25.30

- 84 tooth low profile ratchet



81206P - 3 Pc. 120XP Full Polish Teardrop Ratchet Set MULTI DRIVE RRP \$121.70

Material No.	Description	Material No.	Des	Material No.	Desc
81011P	1/4" Dr.	81211P	3/8" Dr.	81304P	1/2" Dr.

- 120 positions
- 3 degree ratcheting arc



81230P - Set Rat Flx Td 120XP 4Pc FP RRP \$177.20

Material No.	Description	Material No.	Des	Material No.	Desc
81012P	1/4" Dr.	81212P	3/8" Dr. Stubby	81215P	3/8" Dr.
81306P	1/2" Dr.				

- 120 positions
- 3 degree ratcheting arc



120XP Full Polish Flex Teardrop Ratchet 1/4" DRIVE

Material No.	Description	Overall Length (mm)	Weight (g)	RRP
81012P	Full Polish Flex Teardrop Ratchet	177	150	\$38.70

- 120 positions
- 3 degree ratcheting arc



120XP Full Polish Teardrop Ratchet 1/4" DRIVE

Material No.	Description	Overall Length (mm)	Weight (g)	RRP
81011P	Full Polish Teardrop Ratchet	130	100	\$27.65

- 120 positions
- 3 degree ratcheting arc



Quick-Release Teardrop Ratchet 1/4" DRIVE

Material No.	Description	Overall Length (mm)	Weight (g)	RRP
81014	Quick-Release Teardrop Ratchet	143	90	\$28.40

- 45 tooth standard ratchet

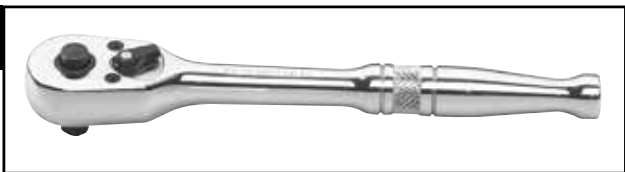

Cushion Grip Teardrop Ratchet 1/4" DRIVE

Material No.	Description	Overall Length (mm)	Weight (g)	RRP
81007F	Cushion Grip Teardrop Ratchet	163	132	\$27.90

- 84 tooth low profile ratchet



Cushion Grip Flex Teardrop Ratchet 1/4" DRIVE

Material No.	Description	Overall Length (mm)	Weight (g)	RRP
81009F	Cushion Grip Flex Teardrop Ratchet	197	181	\$37.95

- 84 tooth low profile ratchet



1/4" OPEN STOCK
RATCHETS, SOCKETS & DRIVE TOOLS

1/4" DRIVE OPEN STOCK

RATCHETS, SOCKETS & DRIVE TOOLS



Cushion Grip Roto Ratchet 1/4" DRIVE

Material No.	Description	Weight (g)	RRP
81224	Cushion Grip Roto Ratchet	132	\$40.95

- 72 tooth roto ratchet



NEW PRODUCT

Gimbal Ratchet 1/4" DRIVE

Material No.	Description	Ratchet Angle	Tooth Count	RRP
81027	Gimbal Ratchet	5 Degree	72	\$30.95

- Anodized aluminium finish



Spinner Handle 1/4" DRIVE

Material No.	Description	Weight (g)	RRP
81128	Spinner Handle	120	\$14.75



Flex handle 1/4" DRIVE

Material No.	Description	Overall Length (inch)	Weight (g)	RRP
81013	Flex Handle	5.43"	133	\$16.45



Universal Joint 1/4" DRIVE

Material No.	Description	Weight (g)	RRP
80100	Universal Joint	20	\$10.55



Adapter 1/4" DRIVE

Material No.	Description	Weight (g)	RRP
81127	Adapter 1/4" F x 3/8" M	20	\$6.20



Standard Extension 1/4" DRIVE

Material No.	Description	Weight (g)	RRP
81101	2" Standard Extension	30	\$5.40
81116	6" Standard Extension	80	\$7.40
81117D	10" Standard Extension	110	\$21.15
81118	14" Standard Extension	150	\$28.00



Wobble Extensions 1/4" DRIVE

Material No.	Description	Weight (g)	RRP
81119	2" Wobble Extension	30	\$5.85
81121	6" Wobble Extension	80	\$7.95



Locking Extension 1/4" DRIVE

Material No.	Description	Weight (g)	RRP
81126	6" Locking Extension	80	\$16.85

1/4" DRIVE SETS

80304 - 13 Pc. METRIC 6 Pt. Deep Socket Set
1/4" DRIVE RRP \$31.65

Material No.	Description	Material No.	Description
80138	4 mm	80145	10 mm
80139	5 mm	80146	11 mm
80140	5.5 mm	80147	12 mm
80141	6 mm	80148	13 mm
80142	7 mm	80149	14 mm
80143	8 mm	80150	15 mm
80144	9 mm		



80305 - 10 Pc. SAE 6 Pt. Deep Socket Set
1/4" DRIVE RRP \$25.30

Material No.	Description	Material No.	Description
80115	3/16"	80120	11/32"
80116	7/32"	80121	3/8"
80117	1/4"	80122	7/16"
80118	9/32"	80123	1/2"
80119	5/16"	80124	9/16"



80306 - 13 Pc. METRIC 12 Pt. Standard Socket Set
1/4" DRIVE RRP \$27.40

Material No.	Description	Material No.	Description
80197	4 mm	80204	10 mm
80198	5 mm	80205	11 mm
80199	5.5 mm	80206	12 mm
80200	6 mm	80207	13 mm
80201	7 mm	80208	14 mm
80202	8 mm	80209	15 mm
80203	9 mm		



80307D - 10 Pc. SAE 12 Pt. Standard Socket Set
1/4" DRIVE RRP \$27.40

Material No.	Description	Material No.	Description
80210	3/16"	80215	11/32"
80211	7/32"	80216	3/8"
80212	1/4"	80217	7/16"
80213	9/32"	80218	1/2"
80214	5/16"	80219	9/16"



80311 - 12 Pc. METRIC 6 Pt. Flex Socket Set
1/4" DRIVE RRP \$80.20

Material No.	Description	Material No.	Description
80250	5 mm	80256	10 mm
80251	5.5 mm	80257	11 mm
80252	6 mm	80258	12 mm
80253	7 mm	80259	13 mm
80254	8 mm	80260	14 mm
80255	9 mm	80261	15 mm



80310D - 7 Pc. SAE 6 Pt. Flex Socket Set
1/4" DRIVE RRP \$49.25

Material No.	Description	Material No.	Description
80262	3/16"	80266	7/16"
80263	1/4"	80267	1/2"
80264	5/16"	80268	9/16"
80265	3/8"		

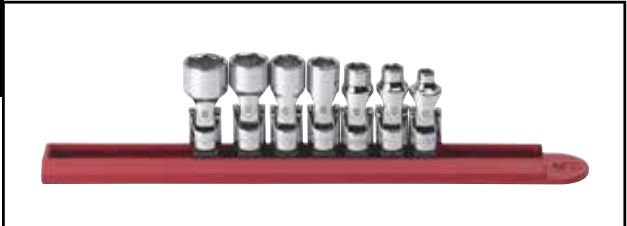

Note: Individual materials may not be available for separate purchase.

1/4" DRIVESETS
RATCHETS, SOCKETS & DRIVE TOOLS

1/4" OPEN STOCK

1/4" OPEN STOCK

RATCHETS, SOCKETS & DRIVE TOOLS



6 Pt. Standard Socket METRIC/SAE 1/4" DRIVE



Material No.	Size	Description	Drive End	Wrench	Overall	Bolt	Wrench	Length to	Weight	RRP
			(mm) A	End (mm) B	Length (mm) C	Clearance D	Depth (mm) E	Shoulder F	(g)	
80125	4 mm	6 Pt. Std. Metric	11.8	6.7	24.5	3.4	8.0	11.5	10	\$4.40
80126	5 mm	6 Pt. Std. Metric	11.8	8.0	24.5	4.0	8.0	11.5	10	\$4.40
80127	5.5 mm	6 Pt. Std. Metric	11.8	8.6	24.5	4.0	8.0	11.5	10	\$4.40
80128	6 mm	6 Pt. Std. Metric	11.8	9.2	24.5	4.0	9.0	11.5	10	\$4.40
80129	7 mm	6 Pt. Std. Metric	11.8	10.7	24.5	5.6	9.5	11.5	10	\$4.40
80130	8 mm	6 Pt. Std. Metric	11.8	11.5	24.5	5.6	10.0	11.5	12	\$4.65
80131D	9 mm	6 Pt. Std. Metric	13.1	13.1	24.5	5.6	10.5	11.5	15	\$4.65
80132	10 mm	6 Pt. Std. Metric	14.3	14.3	24.5	5.6	12.5	11.5	18	\$4.75
80133	11 mm	6 Pt. Std. Metric	15.8	15.8	24.5	5.6	12.5	11.5	20	\$4.75
80134	12 mm	6 Pt. Std. Metric	10.2	10.2	24.5	5.6	12.5	11.5	22	\$4.75
80135D	13 mm	6 Pt. Std. Metric	17.9	17.9	24.5	5.6	12.5	11.5	27	\$4.75
80136	14 mm	6 Pt. Std. Metric	19.5	19.5	24.5	5.6	14.5	11.5	27	\$4.75
80137	15 mm	6 Pt. Std. Metric	20.8	20.8	24.5	5.6	14.5	11.5	30	\$4.75
80104D	5/32"	6 Pt. Std. SAE	11.8	6.9	24.5	3.4	7.5	11.5	10	\$4.75
80105	3/16"	6 Pt. Std. SAE	11.8	7.8	24.5	4.0	8.0	11.5	10	\$4.40
80106	7/32"	6 Pt. Std. SAE	11.8	8.5	24.5	4.0	8.0	11.5	10	\$4.40
80107	1/4"	6 Pt. Std. SAE	11.8	9.5	24.5	4.0	9.0	11.5	10	\$4.65
80108	9/32"	6 Pt. Std. SAE	11.8	10.7	24.5	5.6	9.0	11.5	10	\$4.65
80109	5/16"	6 Pt. Std. SAE	11.8	11.5	24.5	5.6	10.5	11.5	12	\$4.65
80110	11/32"	6 Pt. Std. SAE	12.5	12.5	24.5	5.6	10.5	11.5	15	\$4.75
80111	3/8"	6 Pt. Std. SAE	13.8	13.8	24.5	5.6	12.5	11.5	20	\$4.75
80112	7/16"	6 Pt. Std. SAE	15.7	15.7	24.5	5.6	12.5	11.5	20	\$4.75
80113D	1/2"	6 Pt. Std. SAE	17.3	17.3	24.5	5.6	12.5	11.5	25	\$4.75
80114D	9/16"	6 Pt. Std. SAE	19.5	19.5	24.5	5.6	14.5	11.5	27	\$4.75

1/4" OPEN STOCK

6 Pt. Deep Socket METRIC/SAE 1/4" DRIVE

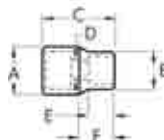

1/4" OPEN STOCK
RATCHETS, SOCKETS & DRIVE TOOLS

Material No.	Size	Description	Drive End	Wrench	Overall	Bolt	Wrench	Length to	Weight (g)	RRP
			(mm)	End (mm)	Length (mm)	Clearance	Depth (mm)	Shoulder		
			A	B	C	D	E	F		
80138	4 mm	6 Pt. Deep Metric	11.9	6.7	49.0	3.5	3.0	22.0	18	\$6.20
80139	5 mm	6 Pt. Deep Metric	11.9	8.0	49.0	4.5	3.5	22.0	18	\$6.20
80140	5.5 mm	6 Pt. Deep Metric	11.9	8.6	49.0	5.0	3.5	22.0	18	\$6.20
80141	6 mm	6 Pt. Deep Metric	11.9	9.2	49.0	5.5	4.0	22.0	21	\$6.20
80142	7 mm	6 Pt. Deep Metric	11.9	10.8	49.0	5.5	5.0	22.0	25	\$6.20
80143	8 mm	6 Pt. Deep Metric	11.9	11.5	49.0	5.5	5.0	22.0	25	\$6.30
80144	9 mm	6 Pt. Deep Metric	13.1	13.1	49.0	5.5	5.0	22.0	32	\$6.30
80145	10 mm	6 Pt. Deep Metric	14.6	14.6	49.0	5.5	5.5	22.0	38	\$6.30
80146D	11 mm	6 Pt. Deep Metric	15.9	15.9	49.0	5.5	6.5	22.0	48	\$6.30
80147	12 mm	6 Pt. Deep Metric	16.9	16.9	49.0	5.5	6.5	22.0	50	\$6.30
80148	13 mm	6 Pt. Deep Metric	17.9	17.9	49.0	5.5	7.7	22.0	55	\$6.30
80149	14 mm	6 Pt. Deep Metric	19.6	19.6	49.0	5.5	8.9	22.0	60	\$7.40
80150	15 mm	6 Pt. Deep Metric	20.8	20.8	49.0	5.5	8.9	22.0	70	\$7.40
80115	3/16"	6 Pt. Deep SAE	11.9	7.8	49.0	4.5	3.5	22.0	18	\$6.20
80116D	7/32"	6 Pt. Deep SAE	11.9	8.8	49.0	5.0	3.5	22.0	20	\$6.20
80117	1/4"	6 Pt. Deep SAE	11.9	9.9	49.0	5.5	4.0	22.0	21	\$6.20
80118	9/32"	6 Pt. Deep SAE	11.9	11.0	49.0	5.5	5.0	22.0	21	\$6.20
80119	5/16"	6 Pt. Deep SAE	11.9	11.5	49.0	5.5	5.0	22.0	21	\$6.20
80120D	11/32"	6 Pt. Deep SAE	13.1	13.1	49.0	5.5	5.0	22.0	29	\$6.30
80121	3/8"	6 Pt. Deep SAE	14.6	14.6	49.0	5.5	5.1	22.0	40	\$6.30
80122D	7/16"	6 Pt. Deep SAE	15.9	15.9	49.0	5.5	6.0	22.0	46	\$6.30
80123	1/2"	6 Pt. Deep SAE	17.9	17.9	49.0	5.5	7.3	22.0	58	\$6.30
80124	9/16"	6 Pt. Deep SAE	19.6	19.6	49.0	5.5	8.9	22.0	60	\$8.40

3/8" DRIVE SETS

RATCHETS, SOCKETS & DRIVE TOOLS
3/8" DRIVE SETS



NEW PRODUCT

80550P - 56 Pc. SAE/METRIC 120XP™ 6 Pt. Standard & Deep Socket Set 3/8" DRIVE RRP \$251.20

Material No.	Description	Material No.	Description
3/8" DR. 6 PT. SAE SOCKET			
80350	1/4"	80359	13/16"
80351	5/16"	80360	7/8"
80352	3/8"	80361	15/16"
80353	7/16"	80362	1"
3/8" DR. 6 PT. DEEP SAE SOCKET			
80354	1/2"	80363	1/4"
80355	9/16"	80364	5/16"
80356	5/8"	80365	3/8"
80357	11/16"	80366	1/4"
80358	3/4"	80367	7/16"

Material No.	Description	Material No.	Description
80368	1/2"	80392	10 mm
80369	9/16"	80393	11 mm
80370	5/8"	80394	12 mm
80371	11/16"	80395	13 mm
80372	3/4"	80396	14 mm
80373	7/8"	80397	15 mm
3/8" DR. 6 PT. METRIC SOCKET			
80374	6 mm	80398	16 mm
80375	7 mm	80399	17 mm
80376	8 mm	80400	18 mm
80377	9 mm	80401	19 mm
80378	10 mm	81241	3" Extension
80379	11 mm	81242	6" Extension
80380	12 mm	80549	Universal Joint
80381	13 mm	81209	Full Polish Stubby Tear-drop Ratchet
80382	14 mm		Full Polish Teardrop Ratchet
80383	15 mm	81211	Replacement Blow Mold Case
80384	16 mm		80550BM
80385	17 mm		
80386	18 mm		
80387	19 mm		
3/8" DR. 6 PT. DEEP METRIC SOCKET			
80388	6 mm		
80389	7 mm		
80390	8 mm		
80391	9 mm		



80551 - 57 Pc. SAE/METRIC 12 Pt. Standard & Deep Socket Set 3/8" DRIVE RRP \$263.40

Material No.	Description	Material No.	Description
3/8" DR. 12 PT. SAE SOCKET			
80496	1/4"	80505	13/16"
80497D	5/16"	80506	7/8"
80498	3/8"	80507	15/16"
80499	7/16"	80508	1"
3/8" DR. 12 PT. DEEP SAE SOCKET			
80500	1/2"	80509	1/4"
80501	9/16"	80510	5/16"
80502	5/8"	80511	3/8"
80503	11/16"	80512	1/4"
80504	3/4"	80513	7/16"

Material No.	Description	Material No.	Description
80514	1/2"	80524	10 mm
80515	9/16"	80525	11 mm
80516	5/8"	80526	12 mm
80517	11/16"	80527	13 mm
80518	3/4"	80528	14 mm
80519	7/8"	80529	15 mm
3/8" DR. 12 PT. METRIC SOCKET			
80482	6 mm	80530	16 mm
80483	7 mm	80531	17 mm
80484	8 mm	80532	18 mm
80485	9 mm	80533	19 mm
80486	10 mm	81241	3" Extension
80487	11 mm	81242	6" Extension
80488	12 mm	80549	Universal Joint
80489	13 mm	81209	Full Polish Stubby Tear-drop Ratchet
80490	14 mm		Full Polish Teardrop Ratchet
80491	15 mm	81211	Replacement Blow Mold Case
80492	16 mm		80550BM
80493	17 mm		
80494	18 mm		
80495	19 mm		
3/8" DR. 12 PT. DEEP METRIC SOCKET			
80520	6 mm		
80521	7 mm		
80522	8 mm		
80523	9 mm		

Note: Individual materials may not be available for separate purchase.

3/8" DRIVE SETS

80559 - 24 Pc. METRIC 6 Pt. & 12 Pt. Standard & Deep Socket Set 3/8" DRIVE RRP \$115.90

Material No.	Description	Material No.	Description
3/8" DR. 6 PT. DEEP METRIC SOCKET		80487	11 mm
80392	10 mm	80488	12 mm
80393	11 mm	80489	13 mm
80394	12 mm	80490	14 mm
80395	13 mm	80491	15 mm
80396	14 mm	80492	16 mm
80397	15 mm	80493	17 mm
80398	16 mm	80494	18 mm
80399	17 mm	80495	19 mm
80400	18 mm	81241	3" Extension
3/8" DR. 12 PT. METRIC SOCKET		81242	6" Extension
80484	8 mm	81211	Full Polish Teardrop Ratchet
80485	9 mm		
80486	10 mm		



80557 - 21 Pc. SAE 6 Pt. & 12 Pt. Standard & Deep Socket Set 3/8" DRIVE RRP \$115.90

Material No.	Description	Material No.	Description
3/8" DR. 6 PT. DEEP SAE SOCKET		3/8" DR. 12 PT. SAE SOCKET	
80365	3/8"	80496	1/4"
80366	1/4"	80497	5/16"
80367	7/16"	80498	3/8"
80368	1/2"	80499	7/16"
80369	9/16"	80500	1/2"
80370	5/8"	80501	9/16"
80371	11/16"	80502	5/8"
80372	3/4"	80503	11/16"
80373	7/8"	80504	3/4"
81241	3" Extension		3/8" Dr.
81242	6" Extension		3/8" Dr.
81211	Full Polish Teardrop Ratchet		3/8" Dr.



80565 - 10 Pc. METRIC 6 Pt. Flex Socket Set 3/8" DRIVE RRP \$68.55

Material No.	Description	Material No.	Description
80333	10 mm	80338	15 mm
80334	11 mm	80339	16 mm
80335	12 mm	80340	17 mm
80336	13 mm	80341	18 mm
80337	14 mm	80342	19 mm



80564 - 7 Pc. SAE 6 Pt. Flex Socket Set 3/8" DRIVE RRP \$64.15

Material No.	Description
80343	3/8"
80344	7/16"
80345	1/2"
80346	9/16"
80347	5/8"
80348	11/16"
80349	3/4"



Note: Individual materials may not be available for separate purchase.

3/8" DRIVESETS
RATCHETS, SOCKETS & DRIVE TOOLS

3/8" DRIVE OPEN STOCK

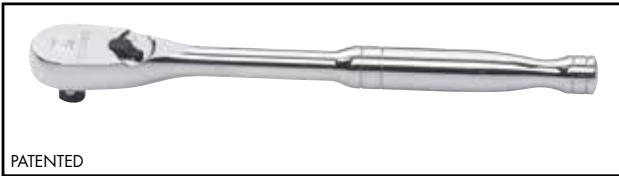

PATENTED

Full Polish Teardrop Ratchet 3/8" DRIVE

Material No.	Description	Overall Length (mm)	Wt (g)	RRP
81211F	Full Polish Teardrop Ratchet	213	308	\$37.95

- 84 tooth low profile ratchet



81206P - 3 Pc. 120XP Full Polish Teardrop Ratchet Set MULTI DRIVE

RRP \$121.70

Material No.	Description	Material No.	Des	Material No.	Desc
81011P	1/4" Dr.	81211P	3/8" Dr.	81304P	1/2" Dr.

- 120 positions
- 3 degree ratcheting arc



81230P - 4 Pc. 120XP Flex Head Full Polish Teardrop Ratchet Set MULTI DRIVE

RRP \$177.20

Material No.	Description	Material No.	Des	Material No.	Desc
81012P	1/4" Dr.	81212P	3/8" Dr. Stubby	81215P	3/8" Dr.
81306P	1/2" Dr.				

- 120 positions
- 3 degree ratcheting arc



120XP Full Polish Teardrop Ratchet 3/8" DRIVE

Material No.	Description	Overall Length (mm)	Wt (g)	RRP
81211P	Full Polish Teardrop Ratchet	276	358	\$43.70

- 120 positions
- 3 degree ratcheting arc



120XP Flex Head Full Polish Teardrop Ratchet 3/8" DRIVE

Material No.	Description	Overall Length (mm)	Wt (g)	RRP
81215P	Full Polish Flex Teardrop Ratchet	290	450	\$47.55

- 120 positions
- 3 degree ratcheting arc



Quick-Release Teardrop Ratchet 3/8" DRIVE

Material No.	Description	Overall Length (mm)	Wt (g)	RRP
81218	Quick-Release Teardrop Ratchet	199.9	250	\$42.15

- 45 tooth standard ratchet



Full Polish Stubby Teardrop Ratchet 3/8" DRIVE

Material No.	Description	Overall Length (mm)	Wt (g)	RRP
81209F	Full Polish Stubby Teardrop Ratchet	120	186	\$29.50

- 84 tooth low profile ratchet



Gimbal Ratchet 3/8" DRIVE

Material No.	Description	Ratchet Angle	Tooth Count	RRP
81270	Gimbal Ratchet	5 Degree	72	\$30.95

- Anodized aluminium finish

3/8" OPEN STOCK RATCHETS, SOCKETS & DRIVE TOOLS

3/8" DRIVE OPEN STOCK

**Full Polish Stubby Flex Teardrop Ratchet
3/8" DRIVE**

Material No.	Description	Overall Length (mm)	Wt (g)	RRP
81212F	Full Polish Stubby Flex Teardrop Ratchet	127.5	236	\$52.65

- 84 tooth low profile ratchet



Cushion Grip Teardrop Ratchet 3/8" DRIVE

Material No.	Description	Overall Length (mm)	Wt (g)	RRP
81208F	Cushion Grip Teardrop Ratchet	229	290	\$42.15

- 84 tooth low profile ratchet



**Cushion Grip Offset Flex Teardrop Ratchet
3/8" DRIVE**

Material No.	Description	Overall Length (mm)	Weight (g)	RRP
81213F	Cushion Grip Offset Flex Teardrop Ratchet	311	450	\$56.90

- 84 tooth low profile ratchet



Cushion Grip Roto Ratchet 3/8" DRIVE

Material No.	Description	Overall Length (mm)	Weight (g)	RRP
81225	Cushion Grip Roto Ratchet	250	345	\$61.10

- 72 tooth ratchet



Cushion Grip Flex Teardrop Ratchet 3/8" DRIVE

Material No.	Description	Overall Length (mm)	Wt (g)	RRP
81210F	Cushion Grip Flex Teardrop Ratchet	13.13"	426	\$75.90

- 84 tooth low profile ratchet



Full Polish Flex Handle 3/8" DRIVE

Material No.	Description	Overall Length (mm)	Weight (g)	RRP
81221	Full Polish Flex Handle	305	181	\$27.70



Universal Joint 3/8" DRIVE

Material No.	Description	Weight (g)	RRP
80549	Universal Joint	60	\$15.85



3/8" OPEN STOCK
RATCHETS, SOCKETS & DRIVE TOOLS

3/8" DRIVE OPEN STOCK

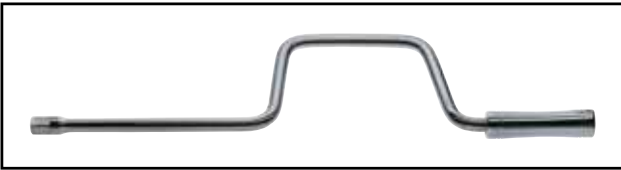

Speeder Handle 3/8" DRIVE			
Material No.	Description	Weight (g)	RRP
81239	Speeder Handle	499	\$20.90



Standard Extension 3/8" DRIVE			
Material No.	Description mm/in	Weight (g)	RRP
81240	38mm/1-1/2" Standard Extension	40	\$8.20
81241	76mm/3" Standard Extension	70	\$8.40
81242	152mm/6" Standard Extension	150	\$12.65
81243	254mm/10" Standard Extension	240	\$16.85
81244	305mm/12" Standard Extension	280	\$23.20



Wobble Extensions 3/8" DRIVE			
Material No.	Description mm/in	Weight (g)	RRP
81246	76mm/3" Extension	70	\$8.40
81247	152mm/6" Extension	150	\$12.65
81248	254mm/10" Extension	240	\$16.85
81249	305mm/12" Extension	280	\$23.20



81202 - Locking Extension Set 3/8" DRIVE			\$59.00
Material No.	Description mm/in	Weight (g)	
81250	76mm/ 3" Locking Extension	70	
81251	152mm/ 6" Locking Extension	150	
81272	254mm/10" Locking Extension	240	



Adapter 3/8" DRIVE			
Material No.	Description	Weight (g)	RRP
81277	Adapter 3/8"F X 1/4"M	7	\$6.30
81278	Adapter 3/8"F X 1/2"M	21	\$6.30



Spark Plug Socket SAE 3/8" DRIVE			
Material No.	Description	Weight (g)	RRP
80402	5/8" Spark Plug	43	\$11.65
80403	13/16" Spark Plug	75	\$13.85

3/8" DRIVE SETS

80554 - 14 Pc. METRIC 6 Pt. Deep Socket Set
3/8" DRIVE RRP \$52.65

Material No.	Description	Material No.	Description
80388	6 mm	80395	13 mm
80389	7 mm	80396	14 mm
80390	8 mm	80397	15 mm
80391	9 mm	80398	16 mm
80392	10 mm	80399	17 mm
80393	11 mm	80400	18 mm
80394	12 mm	80401	19 mm



80561 - 13 Pc. SAE 12 Pt. Standard Socket Set
3/8" DRIVE RRP \$40.05

Material No.	Description	Material No.	Description
80496	1/4"	80503	11/16"
80497D	5/16"	80504	3/4"
80498	3/8"	80505	13/16"
80499	7/16"	80506	7/8"
80500	1/2"	80507	15/16"
80501	9/16"	80508	1"
80502	5/8"		



80560 - 14 Pc. METRIC 12 Pt. Standard Socket Set
3/8" DRIVE RRP \$40.05

Material No.	Description	Material No.	Description
80482	6 mm	80489	13 mm
80483	7 mm	80490	14 mm
80484	8 mm	80491	15 mm
80485	9 mm	80492	16 mm
80486	10 mm	80493	17 mm
80487	11 mm	80494	18 mm
80488	12 mm	80495	19 mm



80555 - 11 Pc. SAE 6 Pt. Deep Socket Set
3/8" DRIVE RRP \$40.05

Material No.	Description	Material No.	Description
80363	1/4"	80369	9/16"
80364	5/16"	80370	5/8"
80365	3/8"	80371	11/16"
80366	1/4"	80372	3/4"
80367	7/16"	80373	7/8"
80368	1/2"		



3/8" DRIVESETS
RATCHETS, SOCKETS & DRIVE TOOLS

Note: Individual materials may not be available for separate purchase.

3/8" OPEN STOCK



12 Pt. Standard Socket METRIC/SAE 3/8" DRIVE



RATCHETS, SOCKETS & DRIVE TOOLS 3/8" OPEN STOCK

Material No.	Size	Description	Drive End (mm) A	Wrench End (mm) B	Overall Length (mm) C	Bolt Clearance D	Wrench Depth (mm) E	Length to Shoulder F	Weight (g)	RRP
80482	6 mm	12 Pt. Std. Metric	17.0	9.3	25.0	5.0	7.5	11.5	18	\$6.20
80483	7 mm	12 Pt. Std. Metric	17.0	10.8	25.0	5.0	7.5	11.5	18	\$6.20
80484	8 mm	12 Pt. Std. Metric	17.0	12.0	25.0	7.2	7.5	11.5	20	\$6.20
80485	9 mm	12 Pt. Std. Metric	17.0	12.9	25.0	7.2	7.5	11.5	20	\$6.20
80486	10 mm	12 Pt. Std. Metric	17.0	14.5	25.0	7.2	7.5	11.5	20	\$6.20
80487	11 mm	12 Pt. Std. Metric	17.0	15.8	25.0	9.0	7.5	11.5	20	\$6.20
80488	12 mm	12 Pt. Std. Metric	17.0	16.7	25.0	9.0	8.0	11.5	21	\$6.55
80489	13 mm	12 Pt. Std. Metric	18.9	17.7	25.0	9.0	8.0	11.5	27	\$6.55
80490	14 mm	12 Pt. Std. Metric	19.5	19.6	25.0	9.0	12.5	11.5	27	\$6.55
80491	15 mm	12 Pt. Std. Metric	20.8	20.8	25.0	9.0	12.5	11.5	32	\$6.55
80492	16 mm	12 Pt. Std. Metric	22.0	22.0	25.0	9.0	12.5	11.5	38	\$6.95
80493	17 mm	12 Pt. Std. Metric	23.3	23.3	25.0	9.0	12.5	11.5	43	\$6.95
80494	18 mm	12 Pt. Std. Metric	23.8	23.8	25.0	9.0	12.5	11.5	43	\$6.95
80495	19 mm	12 Pt. Std. Metric	24.3	25.5	25.0	9.0	12.5	11.5	55	\$7.20
80596	20 mm	12 Pt. Std. Metric	25.8	27.0	28.0	9.0	15.0	11.5	59	\$7.65
80597	21 mm	12 Pt. Std. Metric	26.7	27.9	28.0	9.0	15.0	11.5	64	\$7.65
80598	22 mm	12 Pt. Std. Metric	28.3	29.5	28.0	9.0	15.0	11.5	68	\$7.65
80496	1/4"	12 Pt. Std. SAE	17.2	10.0	25.0	5.0	7.5	11.5	20	\$8.05
80497D	5/16"	12 Pt. Std. SAE	17.0	11.8	25.0	7.2	7.5	11.5	20	\$7.65
80498	3/8"	12 Pt. Std. SAE	17.0	13.8	25.0	7.2	7.5	11.5	21	\$8.20
80499	7/16"	12 Pt. Std. SAE	17.0	16.0	25.0	9.0	7.5	11.5	21	\$6.20
80500D	1/2"	12 Pt. Std. SAE	17.9	17.4	25.0	9.0	7.5	11.5	25	\$6.20
80501	9/16"	12 Pt. Std. SAE	19.7	19.7	25.0	9.0	12.5	11.5	30	\$6.55
80502	5/8"	12 Pt. Std. SAE	22.2	22.2	25.0	9.0	12.5	11.5	40	\$6.65
80503	11/16"	12 Pt. Std. SAE	23.9	23.9	25.0	9.0	12.5	11.5	48	\$6.95
80504	3/4"	12 Pt. Std. SAE	25.9	25.9	25.0	9.0	12.5	11.5	55	\$7.20
80505	13/16"	12 Pt. Std. SAE	27.9	27.9	28.0	9.0	15.0	11.5	72	\$7.20
80506D	7/8"	12 Pt. Std. SAE	29.7	29.7	28.0	9.0	15.0	11.5	72	\$8.05
80507	15/16"	12 Pt. Std. SAE	32.0	32.0	29.5	9.0	15.0	11.5	72	\$8.30
80508	1"	12 Pt. Std. SAE	33.9	33.9	33.5	9.0	18.0	11.5	73	\$8.95

3/8" OPEN STOCK

6 Pt. Deep Socket METRIC/SAE 3/8" DRIVE



Material No.	Size	Description	Drive End	Wrench End	Overall Length	Bolt Clearance	Wrench Depth (mm)	Length to Shoulder	Weight (g)	RRP
			(mm) A	(mm) B	(mm) C					
80388	6 mm	6 Pt. Deep Metric	16.8	13.0	63.5	8.0	5.0	29.0	24	\$9.55
80389	7 mm	6 Pt. Deep Metric	16.8	13.0	63.5	8.0	5.0	29.0	24	\$9.55
80390	8 mm	6 Pt. Deep Metric	16.8	13.0	63.5	8.0	5.0	29.0	24	\$9.55
80391	9 mm	6 Pt. Deep Metric	16.8	13.0	63.5	8.0	5.0	29.0	24	\$9.55
80392	10 mm	6 Pt. Deep Metric	16.8	14.5	63.5	8.6	5.1	29.0	26	\$9.95
80393D	11 mm	6 Pt. Deep Metric	16.8	15.8	63.5	8.6	6.0	29.0	27	\$9.95
80394D	12 mm	6 Pt. Deep Metric	16.8	16.7	63.5	8.6	6.6	29.0	30	\$9.95
80395	13 mm	6 Pt. Deep Metric	18.8	17.7	63.5	8.6	7.3	29.0	34	\$9.95
80396	14 mm	6 Pt. Deep Metric	19.5	19.5	63.5	8.6	8.9	29.0	37	\$9.95
80397	15 mm	6 Pt. Deep Metric	20.8	20.8	63.5	8.6	8.9	29.0	42	\$9.95
80398	16 mm	6 Pt. Deep Metric	22.0	22.0	63.5	8.6	10.1	29.0	46	\$9.95
80399	17 mm	6 Pt. Deep Metric	23.8	23.8	63.5	8.6	10.1	29.0	54	\$9.95
80400	18 mm	6 Pt. Deep Metric	23.8	23.8	63.5	8.6	10.7	29.0	57	\$9.95
80401	19 mm	6 Pt. Deep Metric	25.5	25.5	63.5	8.6	11.6	29.0	64	\$10.55
80406	20 mm	6 Pt. Deep Metric	25.8	27.0	63.5	8.6	12.2	29.0	68	\$12.65
80407	21 mm	6 Pt. Deep Metric	26.6	27.8	63.5	8.6	12.2	29.0	73	\$12.65
80408	22 mm	6 Pt. Deep Metric	28.3	29.5	63.5	8.6	13.2	29.0	77	\$12.65
80409	24 mm	6 Pt. Deep Metric	30.6	31.8	63.5	8.6	14.4	29.0	82	\$18.95
80363	1/4"	6 Pt. Deep SAE	16.8	10.0	63.5	5.6	2.4	29.0	24	\$9.55
80364	5/16"	6 Pt. Deep SAE	16.8	11.7	63.5	7.1	5.0	29.0	25	\$9.55
80365	3/8"	6 Pt. Deep SAE	16.8	13.8	63.5	8.6	5.1	29.0	27	\$9.55
80366	7/16"	6 Pt. Deep SAE	16.8	16.0	63.5	8.6	6.0	29.0	27	\$9.55
80367	1/2"	6 Pt. Deep SAE	18.3	17.4	63.5	8.6	7.3	29.0	29	\$9.95
80368	9/16"	6 Pt. Deep SAE	19.9	19.9	63.5	8.6	8.9	29.0	39	\$9.95
80369	5/8"	6 Pt. Deep SAE	22.0	22.0	63.5	8.6	10.1	29.0	49	\$9.95
80370D	11/16"	6 Pt. Deep SAE	23.8	23.8	63.5	8.6	10.1	29.0	58	\$9.95
80371	3/4"	6 Pt. Deep SAE	25.8	25.8	63.5	8.6	11.6	29.0	67	\$10.55
80372	13/16"	6 Pt. Deep SAE	27.8	27.8	63.5	8.6	12.2	29.0	75	\$12.65
80373	7/8"	6 Pt. Deep SAE	29.8	29.8	63.5	8.6	13.2	29.0	89	\$12.65
80592	15/16"	6 Pt. Deep SAE	30.6	31.8	63.5	8.6	14.4	29.0	72	\$18.95
80593	1"	6 Pt. Deep SAE	32.3	33.5	63.5	8.6	14.4	29.0	72	\$20.05

3/8" OPEN STOCK RATCHETS, SOCKETS & DRIVE TOOLS

1/2" DRIVE SETS

RATCHETS, SOCKETS & DRIVE TOOLS
1/2" DRIVE SETS



80700P - 49 Pc. SAE/METRIC 6 Pt. 120XP™ Standard & Deep Mechanics Tool Set 1/2" DRIVE

RRP \$241.20

Material No.	Description	Material No.	Description
	1/2" DR. 6 PT. DEEP METRIC SOCKET		1/2" DR. 6 PT. DEEP SAE SOCKET
80637	10 mm	80614	1/2"
80638	11 mm	80615	9/16"
80639	12 mm	80616	5/8"
80640	13 mm	80617	11/16"
80641	14 mm	80618	3/4"
80642	15 mm	80619	13/16"
80643	16 mm	80620	7/8"
80644	17 mm	80621	15/16"
80645	18 mm		
80646D	19 mm		

Material No.	Description	Material No.	Description
	1/2" DR. 6 PT. METRIC SOCKET		1/2" DR. 6 PT. SAE SOCKET
80622	10 mm	80602	7/16"
80623	11 mm	80603	1/2"
80624	12 mm	80604	9/16"
80625	13 mm	80605	5/8"
80626D	14 mm	80606	11/16"
80627	15 mm	80607D	3/4"
80628	16 mm	80608	13/16"
80629	17 mm	80609	7/8"
80630	18 mm	80610D	15/16"
80631	19 mm	80611	1"
80632	20 mm	80612	1-1/16"
80633	21 mm	80613	1-1/8"
80634	22 mm		
80635	23 mm		
80636D	24 mm		
80600D	1/2" Drive Universal Joint		
81340	1/2" Drive Standard Extension 3"		
81341	1/2" Drive Standard Extension 5"		
81304P	1/2" Drive 120XP™ Full Polish Teardrop Ratchet		



80709 - 28 Pc. METRIC Standard & Deep Socket Set 1/2" DRIVE

RRP \$142.70

Material No.	Description	
81341	127mm Extension	1/2" Dr.
81343	381mm Extension	1/2" Dr.
81304	Full Polish Teardrop Ratchet	1/2" Dr.

Material No.	Description	Material No.	Description
	1/2" DR. 6 PT. DEEP METRIC SOCKET		1/2" DR. 12 PT. METRIC SOCKET
80637	10 mm	80745	10 mm
80638	11 mm	80746	11 mm
80639	12 mm	80747	12 mm
80640	13 mm	80748	13 mm
80641	14 mm	80749	14 mm
80642	15 mm	80750	15 mm
80643	16 mm	80751	16 mm
80644	17 mm	80752	17 mm
80645	18 mm	80753	18 mm
80646	19 mm	80754	19 mm
		80755	20 mm
		80756	21 mm
		80757	22 mm
		80758	23 mm
		80759	24 mm



83058 - 23 Pc. Socket Set METRIC 1/2" DRIVE

RRP \$186.95

Description

1/2" Drive 12pt. Standard Sockets: 8mm, 10mm, 11mm, 12mm, 13mm, 14mm, 15mm, 16mm, 17mm, 18mm, 19mm, 21mm, 22mm, 23mm, 24mm, 27mm, 30mm, 32mm;

1/2" Drive Full Polish Teardrop Ratchet 11"; 1/2" Drive Full Polish Flex Handle 15"; 1/2" Drive Universal Joint; 1/2" Drive Standard Extension 3", 1/2" Drive Standard Extension 10"

Metal Case with EVA Tray Insert: 250mm x 424mm

Note: Individual materials may not be available for separate purchase.

1/2" DRIVE OPEN STOCK

Full Polish Teardrop Ratchet 1/2" DRIVE

Material No.	Description	Overall Length (mm)	Weight (g)	RRP
81304F	Full Polish Teardrop Ratchet	280	740	\$50.55

- 84 tooth low profile ratchet

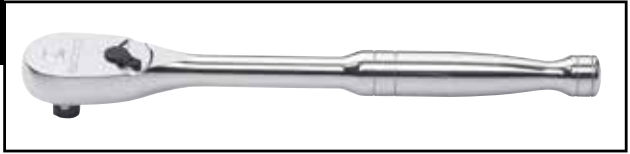

Patented

81206P - 3 Pc. 120XP Full Polish Teardrop Ratchet Set MULTI DRIVE RRP \$121.70

Material No.	Description	Material No.	Des	Material No.	Desc
81011P	1/4" Dr.	81211P	3/8" Dr.	81304P	1/2" Dr.

- 120 positions
- 3 degree ratcheting arc



120XP

81230P - Set Rat Flx Td 120XP 4Pc FP RRP \$177.20

Material No.	Description	Material No.	Des	Material No.	Desc
81012P	1/4" Dr.	81212P	3/8" Dr. Stubby	81215P	3/8" Dr.
81306P	1/2" Dr.				

- 120 positions
- 3 degree ratcheting arc



NEW PRODUCT

120XP

Full Polish Flex Teardrop Ratchet 1/2" DRIVE

Material No.	Description	Overall Length (mm)	Weight (g)	RRP
81306F	Full Polish Flex Teardrop Ratchet	431	740	\$70.15

- 84 tooth low profile ratchet



Patented

Quick Release Tear Drop Ratchet 1/2" DRIVE

Material No.	Description	Weight (g)	RRP
81309	Quick Release Tear Drop Ratchet	740	\$57.30

- 45 tooth standard ratchet



120XP Full Polish Teardrop Ratchet 1/2" DRIVE

Material No.	Description	Overall Length (mm)	Weight (g)	RRP
81304P	Full Polish Teardrop Ratchet	280	848	\$54.80

- 120 positions
- 3 degree ratcheting arc



120XP

120XP Full Polish Flex Head Ratchet 1/2" DRIVE

Material No.	Description	Overall Length (mm)	Weight (g)	RRP
81306P	Full Polish Teardrop Ratchet	430	1107	\$70.75

- 120 positions
- 3 degree ratcheting arc



120XP

Cushion Grip Teardrop Ratchet 1/2" DRIVE

Material No.	Description	Overall Length (mm)	Weight (g)	RRP
81303F	Cushion Grip Teardrop Ratchet	295	1360	\$57.30

- 84 tooth low profile ratchet



Patented

1/2" OPEN STOCK
RATCHETS, SOCKETS & DRIVE TOOLS

1/2" DRIVE OPEN STOCK



Sliding T handle 1/2" DRIVE

Material No.	Description	Size	Weight (g)	RRP
81311	Sliding T handle	15"	599	\$18.05



Speeder Handle 1/2" DRIVE

Material No.	Description	Weight (g)	RRP
81312	Speeder Handle	816	\$24.10

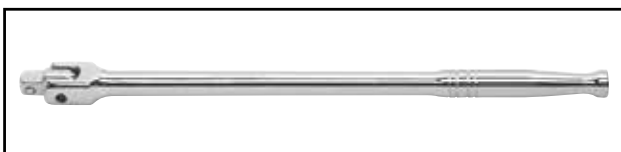

Full Polish Flex Handle SAE 1/2" DRIVE

Material No.	Description	Overall Length (mm)	Weight (g)	RRP
81307	Full Polish Flex Handle	381	363	\$35.85
81308D	Full Polish Flex Handle	610	454	\$65.25



Universal Joint SAE 1/2" DRIVE

Material No.	Description	Weight (g)	RRP
80600D	Universal Joint	145	\$22.70



Standard Adapter SAE 1/2" DRIVE

Material No.	Description	Weight (g)	RRP
81354	Standard Adapter 1/2" F x 3/8" M	50	\$9.55
81355	Standard Adapter 1/2" F x 3/4" M	200	\$13.75



Standard Extension SAE 1/2" DRIVE

Material No.	Description	Weight (g)	RRP
81340	75mm Standard Extension 3"	127	\$13.15
81341	125mm Standard Extension 5"	200	\$14.65
81342	250mm Standard Extension 10"	390	\$20.70
81343	375mm Standard Extension 15"	617	\$30.30



Wobble Extension SAE 1/2" DRIVE

Material No.	Description	Weight (g)	RRP
81345	125mm Wobble Extension 5"	200	\$14.75
81346	250mm Wobble Extension 10"	390	\$20.05

RATCHETS, SOCKETS & DRIVE TOOLS
1/2" OPEN STOCK

1/2" DRIVE SETS

80710D - 13 Pc. METRIC 12 Pt. Standard Socket Set 1/2" DRIVE RRP \$61.10

Material No.	Description			
80747	12 mm	12 Pt.	Std. Metric Socket	1/2" Dr.
80748	13 mm	12 Pt.	Std. Metric Socket	1/2" Dr.
80749	14 mm	12 Pt.	Std. Metric Socket	1/2" Dr.
80750	15 mm	12 Pt.	Std. Metric Socket	1/2" Dr.
80751	16 mm	12 Pt.	Std. Metric Socket	1/2" Dr.
80752	17 mm	12 Pt.	Std. Metric Socket	1/2" Dr.
80753	18 mm	12 Pt.	Std. Metric Socket	1/2" Dr.
80754	19 mm	12 Pt.	Std. Metric Socket	1/2" Dr.



80755	20 mm	12 Pt.	Std. Metric Socket	1/2" Dr.
80756	21 mm	12 Pt.	Std. Metric Socket	1/2" Dr.
80757	22 mm	12 Pt.	Std. Metric Socket	1/2" Dr.
80758	23 mm	12 Pt.	Std. Metric Socket	1/2" Dr.
80759	24 mm	12 Pt.	Std. Metric Socket	1/2" Dr.

80711 - 11 Pc. SAE 12 Pt. Standard Socket Set 1/2" DRIVE RRP \$61.10

Material No.	Description			
80761	1/2"	12 Pt.	Std. SAE Socket	1/2" Dr.
80762	9/16"	12 Pt.	Std. SAE Socket	1/2" Dr.
80763	5/8"	12 Pt.	Std. SAE Socket	1/2" Dr.
80764	11/16"	12 Pt.	Std. SAE Socket	1/2" Dr.
80765	3/4"	12 Pt.	Std. SAE Socket	1/2" Dr.
80766	13/16"	12 Pt.	Std. SAE Socket	1/2" Dr.



80767	7/8"	12 Pt.	Std. SAE Socket	1/2" Dr.
80768	15/16"	12 Pt.	Std. SAE Socket	1/2" Dr.
80769	1"	12 Pt.	Std. SAE Socket	1/2" Dr.
80770	1-1/16"	12 Pt.	Std. SAE Socket	1/2" Dr.
80771	1-1/8"	12 Pt.	Std. SAE Socket	1/2" Dr.

80704 - 10 Pc. METRIC 6 Pt. Deep Socket Set 1/2" DRIVE RRP \$73.75

Material No.	Description			
80637	10 mm	6 Pt.	Deep Metric Socket	1/2" Dr.
80638	11 mm	6 Pt.	Deep Metric Socket	1/2" Dr.
80639	12 mm	6 Pt.	Deep Metric Socket	1/2" Dr.
80640	13 mm	6 Pt.	Deep Metric Socket	1/2" Dr.
80641	14 mm	6 Pt.	Deep Metric Socket	1/2" Dr.
80642	15 mm	6 Pt.	Deep Metric Socket	1/2" Dr.



80643	16 mm	6 Pt.	Deep Metric Socket	1/2" Dr.
80644	17 mm	6 Pt.	Deep Metric Socket	1/2" Dr.
80645	18 mm	6 Pt.	Deep Metric Socket	1/2" Dr.
80646	19 mm	6 Pt.	Deep Metric Socket	1/2" Dr.

80705 - 8 Pc. SAE 6 Pt. Deep Socket Set 1/2" DRIVE RRP \$73.75

Material No.	Description			
80614	1/2"	6 Pt.	Deep SAE Socket	1/2" Dr.
80615	9/16"	6 Pt.	Deep SAE Socket	1/2" Dr.
80616	5/8"	6 Pt.	Deep SAE Socket	1/2" Dr.
80617	11/16"	6 Pt.	Deep SAE Socket	1/2" Dr.
80618	3/4"	6 Pt.	Deep SAE Socket	1/2" Dr.
80619	13/16"	6 Pt.	Deep SAE Socket	1/2" Dr.



80620	7/8"	6 Pt.	Deep SAE Socket	1/2" Dr.
80621	15/16"	6 Pt.	Deep SAE Socket	1/2" Dr.

80712 - 10 Pc. METRIC 12 Pt. Deep Socket Set 1/2" DRIVE RRP \$63.15

Material No.	Description			
80781	10 mm	12 Pt.	Deep Metric Socket	1/2" Dr.
80782	11 mm	12 Pt.	Deep Metric Socket	1/2" Dr.
80783	12 mm	12 Pt.	Deep Metric Socket	1/2" Dr.
80784	13 mm	12 Pt.	Deep Metric Socket	1/2" Dr.
80785	14 mm	12 Pt.	Deep Metric Socket	1/2" Dr.
80786	15 mm	12 Pt.	Deep Metric Socket	1/2" Dr.



80787	16 mm	12 Pt.	Deep Metric Socket	1/2" Dr.
80788	17 mm	12 Pt.	Deep Metric Socket	1/2" Dr.
80789	18 mm	12 Pt.	Deep Metric Socket	1/2" Dr.
80790	19 mm	12 Pt.	Deep Metric Socket	1/2" Dr.

Note: Individual materials may not be available for separate purchase.

1/2" DRIVESETS

RATCHETS, SOCKETS & DRIVE TOOLS

1/2" OPEN STOCK



12 Pt. Standard Socket METRIC 1/2" DRIVE

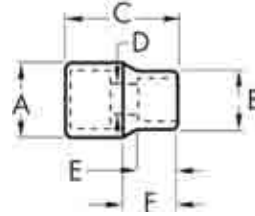

RATCHETS, SOCKETS & DRIVE TOOLS

Material No.	Size	Description	Drive End (mm) A	Wrench End (mm) B	Overall Length (mm) C	Bolt Clearance D	Wrench Depth (mm) E	Length to Shoulder F	Weight (g)	RRP
80805	8mm	12 Pt. Std. Metric	22.0	13.4	37.8	7.2	14.0	19.0	150	\$7.10
80806	9mm	12 Pt. Std. Metric	22.0	14.3	37.8	7.2	14.0	19.0	59	\$7.10
80745	10mm	12 Pt. Std. Metric	22.0	15.3	37.8	7.2	14.0	19.0	49	\$7.10
80746	11mm	12 Pt. Std. Metric	22.0	16.5	37.8	9.0	14.0	19.0	52	\$7.20
80747	12mm	12 Pt. Std. Metric	22.0	17.8	37.8	9.0	14.0	19.0	52	\$7.20
80748D	13mm	12 Pt. Std. Metric	22.0	19.0	37.8	10.7	14.0	19.0	55	\$7.40
80749	14mm	12 Pt. Std. Metric	22.0	20.3	37.8	10.7	14.5	19.0	57	\$7.40
80750	15mm	12 Pt. Std. Metric	22.0	21.4	37.8	10.7	14.5	19.0	57	\$7.40
80751	16mm	12 Pt. Std. Metric	22.0	21.6	37.8	12.0	14.5	19.0	60	\$7.40
80752	17mm	12 Pt. Std. Metric	23.9	23.9	37.8	12.0	15.0	19.0	72	\$7.95
80753	18mm	12 Pt. Std. Metric	24.9	24.9	37.8	12.0	15.0	19.0	78	\$7.95
80754	19mm	12 Pt. Std. Metric	26.0	26.0	37.8	12.0	19.5	19.0	80	\$7.95
80755D	20mm	12 Pt. Std. Metric	27.8	27.8	37.8	12.0	19.5	19.0	90	\$7.95
80756	21mm	12 Pt. Std. Metric	27.9	27.9	37.8	12.0	19.5	19.0	85	\$9.05
80757	22mm	12 Pt. Std. Metric	29.9	29.9	37.8	12.0	19.5	19.0	100	\$9.65
80758	23mm	12 Pt. Std. Metric	31.9	31.9	37.8	12.0	20.5	19.0	120	\$9.65
80759	24mm	12 Pt. Std. Metric	31.9	31.9	37.8	12.0	20.5	19.0	125	\$9.65
80811	25mm	12 Pt. Std. Metric	32.1	33.3	37.8	0.000	20.5	19.0	56	\$9.95
80681	26 mm	12 Pt. Std. Metric	32.7	33.9	40.0	11.5	22.5	38.0	127	\$10.30
80812	27mm	12 Pt. Std. Metric	34.7	35.9	40.0	0.000	22.5	19.0	125	\$10.55
80682	28 mm	12 Pt. Std. Metric	36.4	37.6	40.0	11.5	22.5	38.0	136	\$11.15
80683	29 mm	12 Pt. Std. Metric	36.7	37.9	40.0	11.5	22.5	38.0	150	\$11.40
80813	30mm	12 Pt. Std. Metric	38.7	40.0	42.0	0.000	24.5	19.0	125	\$12.35
80814D	32mm	12 Pt. Std. Metric	40.7	42.0	42.0	0.000	24.5	19.0	125	\$13.25
80815D	36mm	12 Pt. Std. Metric	48.8	50.0	50.0	0.000	28.0	19.0	136	\$14.65

1/2" OPEN STOCK

12 Pt. Standard Socket SAE 1/2" DRIVE

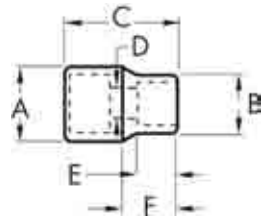

Material No.	Size	Description	Drive End	Wrench	Overall	Bolt	Wrench	Length to	Weight (g)	RRP
			(mm)	End (mm)	Length (mm)	Clearance	Depth (mm)	Shoulder		
			A	B	C	D	E	F		
80760	7/16"	12 Pt. Std. SAE	22.2	17.0	37.8	7.2	14.0	19.0	54	\$7.10
80761	1/2"	12 Pt. Std. SAE	22.2	18.6	37.8	9.0	14.0	19.0	54	\$7.20
80762	9/16"	12 Pt. Std. SAE	22.2	18.6	37.8	9.0	14.0	19.0	54	\$7.40
80763	5/8"	12 Pt. Std. SAE	22.2	18.6	37.8	9.0	14.0	19.0	54	\$7.30
80764	11/16"	12 Pt. Std. SAE	23.8	23.8	37.8	12.0	15.0	19.0	75	\$7.65
80765	3/4"	12 Pt. Std. SAE	25.9	25.9	37.8	12.0	19.5	19.0	75	\$7.95
80766	13/16"	12 Pt. Std. SAE	27.9	27.9	37.8	12.0	19.5	19.0	87	\$8.75
80767	7/8"	12 Pt. Std. SAE	29.9	29.9	37.8	12.0	19.5	19.0	102	\$9.55
80768	15/16"	12 Pt. Std. SAE	31.9	31.9	37.8	12.0	20.5	19.0	115	\$9.65
80769	1"	12 Pt. Std. SAE	33.9	33.9	40.0	12.0	22.5	19.0	145	\$9.95
80770	1-1/16"	12 Pt. Std. SAE	35.9	35.9	40.0	12.0	22.5	19.0	155	\$10.55
80771	1-1/8"	12 Pt. Std. SAE	37.9	37.9	42.0	12.0	24.5	38.0	159	\$11.15
80793	1-3/16"	12 Pt. Std. SAE	38.7	39.9	42.0	12.0	24.5	38.0	227	\$12.35
80794	1-1/4"	12 Pt. Std. SAE	40.7	41.9	42.0	12.0	24.5	38.0	227	\$13.25
80680	1-1/2"	12 Pt. Std. SAE	48.6	49.8	50.0	12.0	31.0	38.0	227	\$25.30

1/2" OPEN STOCK
RATCHETS, SOCKETS & DRIVE TOOLS

1/2" OPEN STOCK

RATCHETS, SOCKETS & DRIVE TOOLS



12 Pt. Deep Socket METRIC/SAE 1/2" DRIVE

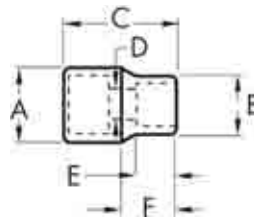

Material No.	Size	Description	Drive End	Wrench	Overall	Bolt	Wrench	Length to	Weight	RRP
			(mm)	End (mm)	Length (mm)	Clearance	Depth (mm)	Shoulder	(g)	
			A	B	C	D	E	F		
80781	10mm	12 Pt. Deep Metric	22.0	15.3	77.0	9.5	5.1	38.0	105	\$10.55
80782	11mm	12 Pt. Deep Metric	22.0	16.5	77.0	10.0	6.0	38.0	105	\$10.55
80783	12mm	12 Pt. Deep Metric	22.0	17.8	77.0	11.0	6.6	38.0	108	\$10.95
80784	13mm	12 Pt. Deep Metric	22.0	19.0	77.0	11.5	7.3	38.0	112	\$11.65
80785	14mm	12 Pt. Deep Metric	22.0	20.3	77.0	11.5	8.9	38.0	112	\$11.65
80786	15mm	12 Pt. Deep Metric	22.0	21.4	77.0	11.5	8.9	38.0	112	\$12.15
80787	16mm	12 Pt. Deep Metric	22.0	21.6	77.0	11.5	10.1	38.0	130	\$12.15
80788	17mm	12 Pt. Deep Metric	23.8	23.8	77.0	11.5	10.1	38.0	138	\$12.15
80789	18mm	12 Pt. Deep Metric	24.8	24.8	77.0	11.5	10.7	38.0	150	\$12.15
80790	19mm	12 Pt. Deep Metric	25.8	25.8	77.0	11.5	11.6	38.0	155	\$12.15
80817D	20mm	12 Pt. Deep Metric	26.6	27.8	77.0	11.5	12.2	19.0	181	\$13.75
80818	21mm	12 Pt. Deep Metric	26.6	27.8	77.0	11.5	12.2	19.0	195	\$13.75
80820	22mm	12 Pt. Deep Metric	28.6	29.8	77.0	11.5	13.2	19.0	204	\$14.35
80822	24mm	12 Pt. Deep Metric	30.6	39.8	77.0	11.5	14.4	19.0	209	\$14.75
80824	27mm	12 Pt. Deep Metric	34.6	35.8	77.0	11.5	16.3	19.0	218	\$14.75
80826	30mm	12 Pt. Deep Metric	38.6	39.8	77.0	11.5	17.2	19.0	227	\$29.50
80827	32mm	12 Pt. Deep Metric	40.6	41.8	77.0	11.5	19.6	19.0	249	\$33.75
80772	7/16"	12 Pt. Deep SAE	22.1	42.4	77.0	9.9	6.1	38.1	105	\$10.55
80773	1/2"	12 Pt. Deep SAE	22.0	18.6	77.0	11.5	7.3	38.0	110	\$10.95
80774	9/16"	12 Pt. Deep SAE	22.0	20.6	77.0	11.5	8.9	38.0	115	\$10.95
80775	5/8"	12 Pt. Deep SAE	22.0	21.6	77.0	11.5	10.1	38.0	130	\$10.95
80776	11/16"	12 Pt. Deep SAE	23.8	23.8	77.0	11.5	10.1	38.0	155	\$10.95
80777D	3/4"	12 Pt. Deep SAE	25.8	31.7	77.0	11.5	11.6	38.0	170	\$11.65
80778	13/16"	12 Pt. Deep SAE	27.8	27.8	77.0	11.5	12.2	38.0	190	\$12.65
80779	7/8"	12 Pt. Deep SAE	29.8	29.8	77.0	11.5	13.2	38.0	225	\$14.35
80780	15/16"	12 Pt. Deep SAE	39.8	39.8	77.0	11.5	14.4	38.0	249	\$14.75
80795	1"	12 Pt. Deep SAE	32.6	33.8	77.0	11.5	16.3	38.0	249	\$16.85
80796	1-1/16"	12 Pt. Deep SAE	34.6	35.8	77.0	11.5	17.2	38.0	249	\$17.95
80797	1-1/8"	12 Pt. Deep SAE	36.6	37.8	77.0	11.5	19.6	38.0	127	\$29.50
80798	1-1/4"	12 Pt. Deep SAE	40.6	41.8	77.0	11.5	22.1	38.0	136	\$33.75
80687	1-1/2"	12 Pt. Deep SAE	40.6	41.8	77.0	11.5	22.1	38.0	136	\$61.10

3/4" DRIVE SETS

80879 - 13 Pc. SAE Standard Socket Set
3/4" DRIVE RRP \$419.25

Material No.	Description			
80830	7/8"	12 Pt.	Std. SAE Socket	3/4" Dr.
80831	15/16"	12 Pt.	Std. SAE Socket	3/4" Dr.
80833	1"	12 Pt.	Std. SAE Socket	3/4" Dr.
80834	1-1/16"	12 Pt.	Std. SAE Socket	3/4" Dr.
80835	1-1/8"	12 Pt.	Std. SAE Socket	3/4" Dr.
80838	1-3/16"	12 Pt.	Std. SAE Socket	3/4" Dr.
80839	1-1/4"	12 Pt.	Std. SAE Socket	3/4" Dr.
80840	1-5/16"	12 Pt.	Std. SAE Socket	3/4" Dr.
80841	1-7/16"	12 Pt.	Std. SAE Socket	3/4" Dr.
80852	1-1/2"	12 Pt.	Std. SAE Socket	3/4" Dr.
80854	1-1/2"	12 Pt.	Std. SAE Socket	3/4" Dr.
81412	8" Extension			3/4" Dr.
81400	Quick-Release Teardrop Ratchet			3/4" Dr.



80880 - 27 Pc. SAE Standard Socket Set
3/4" DRIVE RRP \$779.60

Material No.	Description			
80830	7/8"	12 Pt.	Std. SAE Socket	3/4" Dr.
80831	15/16"	12 Pt.	Std. SAE Socket	3/4" Dr.
80833	1"	12 Pt.	Std. SAE Socket	3/4" Dr.
80834	1-1/16"	12 Pt.	Std. SAE Socket	3/4" Dr.
80835	1-1/8"	12 Pt.	Std. SAE Socket	3/4" Dr.
80838	1-3/16"	12 Pt.	Std. SAE Socket	3/4" Dr.
80839	1-1/4"	12 Pt.	Std. SAE Socket	3/4" Dr.
80840	1-5/16"	12 Pt.	Std. SAE Socket	3/4" Dr.
80841	1-3/8"	12 Pt.	Std. SAE Socket	3/4" Dr.
80852	1-7/16"	12 Pt.	Std. SAE Socket	3/4" Dr.
80854	1-1/2"	12 Pt.	Std. SAE Socket	3/4" Dr.
80855	1-5/8"	12 Pt.	Std. SAE Socket	3/4" Dr.
80856	1-11/16"	12 Pt.	Std. SAE Socket	3/4" Dr.
80857	1-3/4"	12 Pt.	Std. SAE Socket	3/4" Dr.
80859	1-13/16"	12 Pt.	Std. SAE Socket	3/4" Dr.
80860	1-7/8"	12 Pt.	Std. SAE Socket	3/4" Dr.
80861	2"	12 Pt.	Std. SAE Socket	3/4" Dr.
80862	2-1/8"	12 Pt.	Std. SAE Socket	3/4" Dr.
80863	2-3/16"	12 Pt.	Std. SAE Socket	3/4" Dr.



80864	2-1/4"	12 Pt.	Std. SAE Socket	3/4" Dr.
80865	2-3/8"	12 Pt.	Std. SAE Socket	3/4" Dr.
81411	5" Extension			3/4" Dr.
81412	8" Extension			3/4" Dr.
81413	16" Extension			3/4" Dr.
81400	Quick-Release Teardrop Ratchet			3/4" Dr.
81401	18"		Sliding T Handle	3/4" Dr.
81404	19"		Flex Handle	3/4" Dr.

3/4" DRIVESETS
RATCHETS, SOCKETS & DRIVE TOOLS

Note: Individual materials may not be available for separate purchase.

3/4" DRIVE OPEN STOCK

RATCHETS, SOCKETS & DRIVE TOOLS
3/4" OPEN STOCK



Quick Release Ratchet 3/4" DRIVE

Material No.	Description	Overall Length (mm)	Weight (g)	RRP
81400	Quick-Release Ratchet	502	2395	\$124.35

- 24 tooth standard ratchet



Sliding T Handle 3/4" DRIVE

Material No.	Description	Overall Length (mm)	Weight (g)	RRP
81401	Sliding T	483	1377	\$46.35

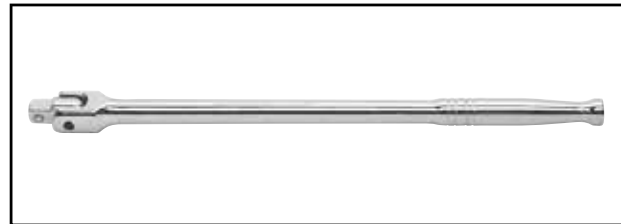

Flex Handle 3/4" DRIVE

Material No.	Description	Overall Length (mm)	Weight (g)	RRP
81404	Flex Handle	483	1846	\$82.20



Standard Extension 3/4" DRIVE

Material No.	Description	Weight (g)	RRP
81412	8" Standard Extension	907	\$37.95
81413	16" Standard Extension	1387	\$54.80

3/4" OPEN STOCK

12 Pt. Standard Socket SAE 3/4" DRIVE

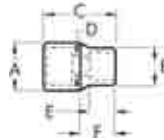

Material No.	Size	Description	Drive End	Wrench	Overall	Bolt	Wrench	Length to	Weight	RRP
			(mm)	End (mm)	Length (mm)	Clearance	Depth (mm)	Shoulder	(g)	
			A	B	C	D	E	F		
80830	7/8"	12 Pt. Std. SAE	36.0	32.2	50.0	N/A	14.0	22.0	210	\$13.75
80831	15/16"	12 Pt. Std. SAE	36.0	34.2	51.0	N/A	16.0	22.0	220	\$13.75
80833	1"	12 Pt. Std. SAE	36.0	37.0	52.0	N/A	16.0	30.0	220	\$13.75
80834	1-1/16"	12 Pt. Std. SAE	36.0	38.0	52.0	N/A	22.0	30.0	220	\$14.50
80835D	1-1/8"	12 Pt. Std. SAE	38.0	40.0	52.0	N/A	22.0	30.0	250	\$14.95
80838	1-3/16"	12 Pt. Std. SAE	38.0	42.0	54.0	N/A	24.0	32.0	270	\$16.45
80839	1-1/4"	12 Pt. Std. SAE	38.0	44.0	56.0	N/A	24.0	33.0	290	\$16.45
80840	1-5/16"	12 Pt. Std. SAE	38.0	46.0	56.0	N/A	26.0	33.0	309	\$16.85
80841	1-3/8"	12 Pt. Std. SAE	42.0	48.0	58.0	N/A	26.0	35.0	369	\$17.95
80852	1-7/16"	12 Pt. Std. SAE	42.0	50.0	58.0	N/A	28.0	35.0	389	\$18.80
80854	1-1/2"	12 Pt. Std. SAE	45.0	52.0	60.0	N/A	28.0	36.0	449	\$20.05
80855D	1-5/8"	12 Pt. Std. SAE	45.0	56.0	64.0	N/A	30.0	40.0	529	\$22.80
80856	1-11/16"	12 Pt. Std. SAE	45.0	58.0	65.0	N/A	32.0	39.0	549	\$24.90
80857	1-3/4"	12 Pt. Std. SAE	48.0	60.0	66.0	N/A	32.0	40.0	599	\$25.70
80859	1-13/16"	12 Pt. Std. SAE	47.0	62.0	68.0	N/A	34.0	40.0	649	\$27.00
80860	1-7/8"	12 Pt. Std. SAE	48.0	64.0	70.0	N/A	34.0	42.0	699	\$29.10
80861	2"	12 Pt. Std. SAE	48.0	68.0	72.0	N/A	36.0	42.0	738	\$29.90
80862	2-1/8"	12 Pt. Std. SAE	48.0	72.0	74.0	N/A	38.0	44.0	818	\$33.75
80863	2-3/16"	12 Pt. Std. SAE	48.0	74.0	76.0	N/A	38.0	45.0	868	\$37.95
80864	2-1/4"	12 Pt. Std. SAE	48.0	76.0	76.0	N/A	40.0	45.0	918	\$42.15
80865	2-3/8"	12 Pt. Std. SAE	48.0	80.0	78.0	N/A	40.0	46.0	998	\$52.65

3/4" OPEN STOCK
RATCHETS, SOCKETS & DRIVE TOOLS

XL PASS-THROUGH

**LOCKING FLEX GEARWRENCH
PASS-THRU™ RATCHET**



**VORTEX™
BIT SOCKETS**

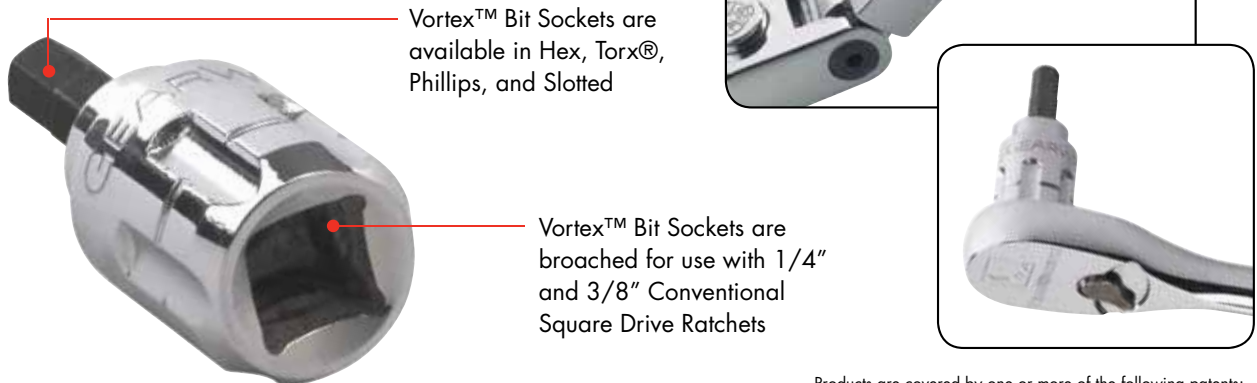

Products are covered by one or more of the following patents:
• US 7,1168,346 US 6,868,709 US 7,231,851

XL PASS-THROUGH

XL PASS-THROUGH SETS

8921 - 21 Pc. METRIC Pass Thru® Ratchet Set
3/8" DRIVE RRP \$98.45

Material No.	Description	Material No.	Description
VORTEX SAE SOCKET		VORTEX METRIC SOCKET	
132120	3/8"	532100	10 mm
132140	7/16"	532110	11 mm
132160	1/2"	532120	12 mm
132180	9/16"	532130	13 mm
132200	5/8"	532140	14 mm
132220	11/16"	532150	15 mm
132240	3/4"	532160	16 mm
		532170	17 mm
		532180	18 mm
		532190	19 mm



Material No.	Description	
231060	3" Pass-Thru® Extension	3/8" Dr.
231061	0.89 Pass-Thru® Adapter	3/8" Dr.
231062	1.17 Pass-Thru® Adapter	3/8" Dr.

Featuring • Locking Flex • Gear Ratchet™ Handle

891226 - 25 Pc. SAE/METRIC Pass-Thru® Ratchet Set Featuring Locking Flex GearRatchet™ Handle
1/2" DRIVE RRP \$208.65

Material No.	Description	Material No.	Description
VORTEX SAE SOCKET		VORTEX METRIC SOCKET	
142200	5/8"	542150	15 mm
142220	1/16"	542160	16 mm
142240	3/4"	542170	17 mm
142260	3/16"	542180	18 mm
142280	7/8"	542190	19 mm
142300	5/16"	542200	20 mm
142320	1"	542210	21 mm
142340	1-1/16"	542220	22 mm
142360	1-1/8"	542240	24 mm
142380	1-1/4"	542270	27 mm
		542300	30 mm
		542320	32 mm



Material No.	Description	
241080	6" Vortex Extension	1/2" Dr.
241062	1/2" Sq. Dr. Quick-Release Adapter	1/2" Dr.
891200	Locking Flex GearRatchet™ Handle	1/2" Dr.

8946 - 46 Pc. SAE GearRatchet Set
1/4" DRIVE, 3/8" DRIVE RRP \$137.35

1/4" DRIVE PASS THROUGH SOCKETS	3/8" DRIVE PASS THROUGH SOCKETS
3.5mm, 4mm, 5mm, 5.5mm, 6mm, 7mm, 8mm, 9mm, 10mm, 11mm, 12mm, 13mm	10mm, 11mm, 12mm, 13mm, 14mm, 15mm, 16mm, 18mm, 19mm
5/32", 3/16", 7/32", 1/4", 9/32", 5/16", 3/8", 7/16", 1/2"	3/8", 7/16", 1/2", 9/16", 5/8", 11/16", 3/4"
1/4"M adaptor	1/4"M adaptor
3" Pass Through Extension	3/8"M adaptor
5.5" Pass Through Ratchet Handle	3" Pass Through Extension
	8" Pass Through Ratchet Handle



Note: Individual materials may not be available for separate purchase.

SETS
XL PASS-THROUGH

XL PASS-THROUGH SETS



NEW PRODUCT

231060GR - Extension 3" Vortex 3/8" DRIVE

RRP \$6.30

Material No.	Length (in)	Weight (g)
231060GR	3"	113



NEW PRODUCT

231080GR - Extension 6" Vortex 3/8" DRIVE

RRP \$21.00

Material No.	Length (in)	Weight (g)
231080GR	6"	163



Locking Flex GearRatchet™ Handle

RRP \$103.20

Material No.	Description	Length (mm)	Weight (g)
893800	3/8" Dr.	305	390

VORTEX ADAPTERS/SOCKETS



Vortex Sockets 3/8" DRIVE

Material No.	Description	Length (mm)	Weight (g)	RRP
132240GR	3/4"	33	35	\$7.20
132260GR	13/16"	35	40	\$7.20
132280GR	7/8"	35	40	\$8.05
532100GR	10 mm	32	25	\$6.20
532110GR	11 mm	32	25	\$6.20
532120GR	12 mm	32	25	\$6.55
532130GR	13 mm	32	25	\$6.55
532140GR	14 mm	32	27	\$6.55
532150GR	15 mm	32	27	\$6.55
532160GR	16 mm	32	30	\$6.95
532170GR	17 mm	32	30	\$6.95
532180GR	18 mm	32	32	\$6.95
532190GR	19 mm	33	35	\$7.20

Material No.	Description	Length (mm)	Weight (g)	RRP
132120GR	3/8"	32	25	\$8.20
132140GR	7/16"	32	25	\$6.20
132160GR	1/2"	32	25	\$6.20
132180GR	9/16"	32	30	\$6.55
132200GR	5/8"	32	30	\$6.65
132220GR	11/16"	32	30	\$6.95



Pass-Thru® Quick-Release Adapters

Material No.	Description	Length (mm)	Weight (g)	RRP
231062GR	3/8" Sq. Dr.	29	20	\$12.65

Note: Individual materials may not be available for separate purchase.

OPEN STOCK

XL PASS-THROUGH

BIT SOCKETS & FLEX HEX KEYS



Bit Sockets

- 1/4" Drive Sets
- 3/8" Drive Sets
- 1/2" Drive Sets

Flex Hex™ Keys

- Long Ball Hex Sets



BIT SOCKETS

Ball and Standard Hex in All Sizes

AVAILABLE IN:



TORX® PRESS FIT



INTERNAL TORX®



EXTERNAL TORX®



BALL HEX



HEXAGON

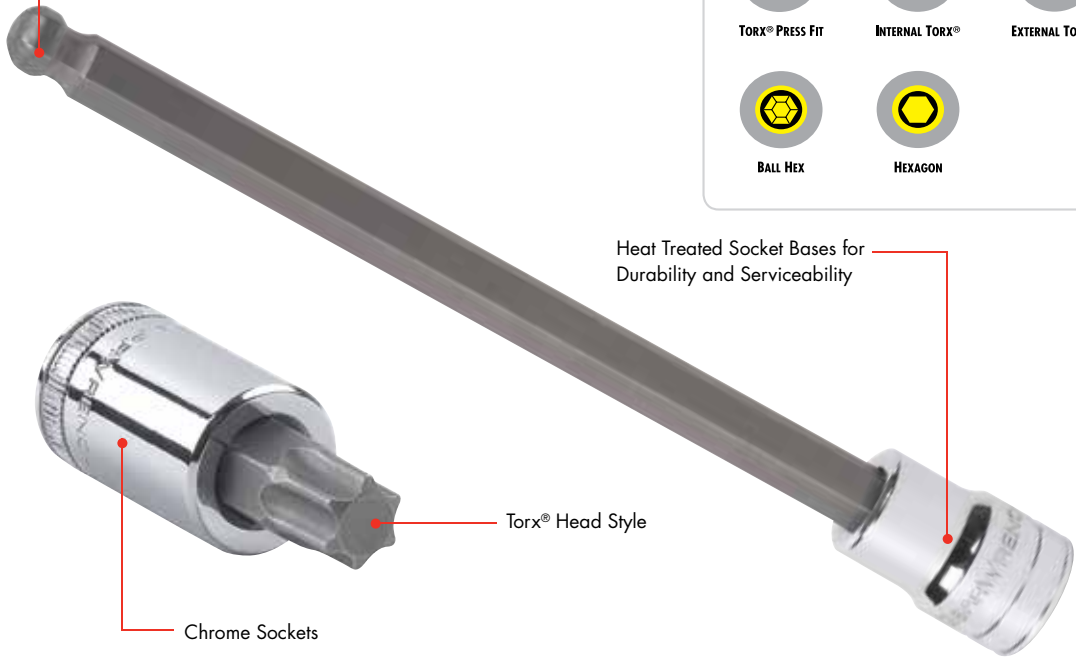

Heat Treated Socket Bases for Durability and Serviceability

Torx® Head Style

Chrome Sockets

Hex Head Style

Packed on Clip Rail Sets



Phillips Head Style

Internal Torx® Style

Triple Square Head Style

Slotted Head Style

Pozidrive® Head Style

Tamper-Proof Torx® Head Style

Insert Bits and Bit Holders

Torx® is a registered trademark of Acument Intellectual Properties, LLC.

MULTI DRIVE SETS

80723 - 13 Pc. TORX® Press Fit Bit Socket Set
1/4", 3/8" & 1/2" DRIVE RRP \$48.45

Material No.	Description	Material No.	Description
80171	T-8	80451	T-40
80172	T-10	80452	T-45
80173	T-15	80453	T-47
80174	T-20	80454	T-50
80175	T-25	80455	T-55
80176	T-27	80667	T-60
80177	T-30		



80588 - 10 Pc. Long TORX® Bit Socket Set
1/4" & 3/8" DRIVE RRP \$73.40

Material No.	Description	Material No.	Description
82510	T-8	82515	T-27
82511	T-10	82516	T-30
82512	T-15	82517	T-40
82513	T-20	82518	T-45
82514	T-25	82519	T-50



80064 - 3 Pc. Long Torx® Dual Material Screwdriver Set RRP \$39.85

Material No.	Description
80088	T-25 x 18"
80087	T-20 x 18"
80086	T-15 x 18"

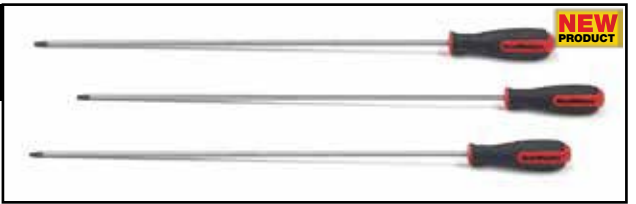

80578 - 10 Pc. METRIC HEX Bit Socket Set
3/8" & 1/2" DRIVE RRP \$50.55

Material No.	Description	Material No.	Description
80425	4mm	80430	9mm
80426	5mm	80431	10mm
80427	6mm	80661	12mm
80428	7mm	80662	14mm
80429	8mm	80663	17mm



80580 - 12 Pc. METRIC HEX Bit Socket Set
3/8" DRIVE RRP \$50.55

Material No.	Description	Material No.	Description
80422	2mm	80428	7mm
80423	2.5mm	80429	8mm
80424	3mm	80430	9mm
80425	4mm	80431	10mm
80426	5mm	80432	11mm
80427	6mm	80433	12mm



80581 - 12 Pc. SAE HEX Bit Socket Set
3/8" DRIVE RRP \$50.55

Material No.	Description	Material No.	Description
80410	1/16"	80416	5/32"
80411	5/64"	80417	3/16"
80412	3/32"	80418	7/32"
80413	7/64"	80419	1/4"
80414	1/8"	80420	5/16"
80415	9/64"	80421	3/8"



Note: Individual materials may not be available for separate purchase.

MULTI DRIVE SETS

BIT SOCKETS

3/8" DRIVE SETS



80573 - 8 Pc. METRIC LONG BALL HEX Bit Socket Set 3/8" DRIVE

RRP \$50.55

Material No.	Description	
80441	3mm Long Ball Hex Bit Socket	3/8" Drive
80442	4mm Long Ball Hex Bit Socket	3/8" Drive
80443	5mm Long Ball Hex Bit Socket	3/8" Drive
80444	6mm Long Ball Hex Bit Socket	3/8" Drive
80445	7mm Long Ball Hex Bit Socket	3/8" Drive
80446	8mm Long Ball Hex Bit Socket	3/8" Drive
80447	9mm Long Ball Hex Bit Socket	3/8" Drive
80448	10mm Long Ball Hex Bit Socket	3/8" Drive

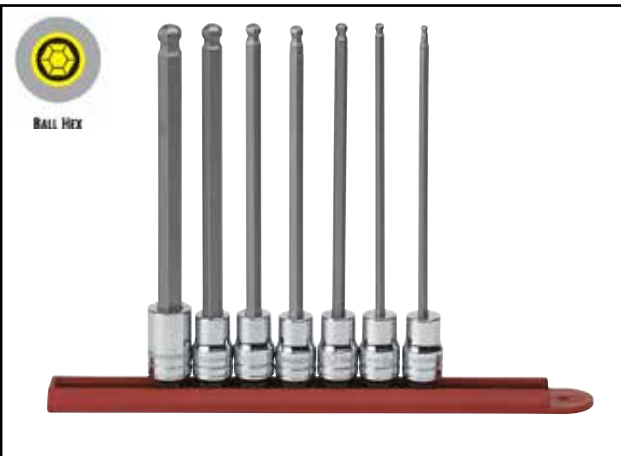

80574 - 7 Pc. SAE LONG BALL HEX Bit Socket Set 3/8" DRIVE

RRP \$50.55

Material No.	Description	
80434	1/8" Long Ball Hex Bit Socket	3/8" Drive
80435	5/32" Long Ball Hex Bit Socket	3/8" Drive
80436	3/16" Long Ball Hex Bit Socket	3/8" Drive
80437	7/32" Long Ball Hex Bit Socket	3/8" Drive
80438	1/4" Long Ball Hex Bit Socket	3/8" Drive
80439	5/16" Long Ball Hex Bit Socket	3/8" Drive
80440	3/8" Long Ball Hex Bit Socket	3/8" Drive

Note: Individual materials may not be available for separate purchase.

IMPACT SOCKETS



Impact Sockets

1/2" Drive Sets

1/2" Drive Open Stock

IMPACT SOCKETS



AVAILABLE IN:

- 1/2" Drive
- Universal Sockets
- Hex Sockets
- Adapters and Drive Tools



IMPACT SOCKETS



1/2" DRIVE SETS

84930 - 12 Pc. 6 Pt. Impact METRIC Standard Socket Set 1/2" DRIVE RRP \$94.80

Material No.	Description	Material No.	Description
84520	8 mm	84526	14 mm
84521	9 mm	84527	15 mm
84522	10 mm	84528	16 mm
84523	11 mm	84529	17 mm
84524	12 mm	84530	18 mm
84525	13 mm	84531	19 mm



84931 - 12 Pc. 6 Pt. Impact SAE Standard Socket Set 1/2" DRIVE RRP \$94.80

Material No.	Description	Material No.	Description
84500	3/8"	84506	3/4"
84501	7/16"	84507	13/16"
84502	1/2"	84508	7/8"
84503	9/16"	84509	15/16"
84504	5/8"	84510	1"
84505	11/16"	84511	1-1/16"



84944 - 12 Pc. 6 Pt. Impact METRIC Deep Socket Set 1/2" DRIVE RRP \$124.35

Material No.	Description	Material No.	Description
84566	8 mm	84572	14 mm
84567	9 mm	84573	15 mm
84568	10 mm	84574	16 mm
84569	11 mm	84575	17 mm
84570	12 mm	84576	18 mm
84571	13 mm	84577	19 mm



84942 - 12 Pc. 6 Pt. Impact SAE Deep Socket Set 1/2" DRIVE RRP \$124.35

Material No.	Description	Material No.	Description
84546	3/8"	84552	3/4"
84547	7/16"	84553	13/16"
84548	1/2"	84554	7/8"
84549	9/16"	84555	15/16"
84550	5/8"	84556	1"
84551	11/16"	84557	1-1/16"



84946 - 3 Pc. Protector Impact Socket Set 1/2" DRIVE RRP \$59.00

Material No.	Description
	17mm, 19mm & 21mm

- Protective outer sheath
- Insert protects lug nuts and bolts



Note: Individual materials may not be available for separate purchase.

1/2" DRIVESETS
IMPACT SOCKETS



41650 - Axle Nut Set

RRP \$135.00

Material No.	Description
3907D	29mm Deep 1/2" Dr. Deep Axle Nut Socket
3161D	30mm Deep 1/2" Dr. Deep Axle Nut Socket
3270D	32mm Deep 1/2" Dr. Deep Axle Nut Socket
3449D	34mm Deep 1/2" Dr. Deep Axle Nut Socket
3908D	35mm Deep 1/2" Dr. Deep Axle Nut Socket
3162D	36mm Deep 1/2" Dr. Deep Axle Nut Socket
3909D	38mm Deep 1/2" Dr. Deep Axle Nut Socket

- 7 Extra Long 1/2" Drive 6 Point Metric Sockets

1/2" OPEN STOCK



Impact Extension Bars SAE 1/2" DRIVE

Material No.	Description	Weight (g)	RRP
84646	5" Extension Bar	226	\$16.85
84644	10" Extension Bar	223	\$25.30



Standard Impact Adapters SAE 1/2" DRIVE

Material No.	Description	Weight (g)	RRP
84643	1/2" F x 3/8" M	70	\$12.65



Universal Impact Joints SAE 1/2" DRIVE

Material No.	Description	Weight (g)	RRP
80671	1/2" Universal Joint	170	\$18.95

1/2" OPEN STOCK
IMPACT SOCKETS

1/2" OPEN STOCK

6 Pt. Standard Impact Sockets METRIC/SAE 1/2" DRIVE

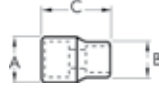

Material No.	Size	Description	Drive End (mm) A	Wrench End (mm) B	Overall Length (mm) C	Weight (g)	RRP
84520	8 mm	6 Pt. Std. Metric	22.0	14.5	38.0	50	\$7.95
84521D	9 mm	6 Pt. Std. Metric	22.0	15.59	38.0	50	\$7.95
84522D	10 mm	6 Pt. Std. Metric	22.0	16.7	38.0	65	\$8.40
84523D	11 mm	6 Pt. Std. Metric	22.0	18.0	38.0	65	\$8.40
84524D	12 mm	6 Pt. Std. Metric	22.0	19.0	38.0	65	\$8.40
84525D	13 mm	6 Pt. Std. Metric	24.0	20.2	38.0	80	\$8.40
84526D	14 mm	6 Pt. Std. Metric	24.0	21.5	38.0	80	\$8.40
84527D	15 mm	6 Pt. Std. Metric	25.0	23.0	38.0	88	\$8.40
84528D	16 mm	6 Pt. Std. Metric	25.0	25.0	38.0	88	\$8.85
84529D	17 mm	6 Pt. Std. Metric	26.0	26.0	38.0	95	\$8.85
84530D	18 mm	6 Pt. Std. Metric	27.0	27.0	38.0	102	\$8.85
84531	19 mm	6 Pt. Std. Metric	28.0	28.0	38.0	106	\$10.05
84532	20 mm	6 Pt. Std. Metric	30.0	30.0	38.0	125	\$10.05
84533	21 mm	6 Pt. Std. Metric	30.0	30.0	38.0	125	\$10.05
84534	22 mm	6 Pt. Std. Metric	32.0	32.0	38.0	145	\$10.95
84535	23 mm	6 Pt. Std. Metric	33.0	33.0	38.0	154	\$12.65
84536	24 mm	6 Pt. Std. Metric	34.0	34.0	38.0	162	\$12.65
84537	25 mm	6 Pt. Std. Metric	36.0	36.0	42.0	201	\$14.35
84538	26 mm	6 Pt. Std. Metric	36.0	36.0	42.0	195	\$14.35
84539	28 mm	6 Pt. Std. Metric	38.0	38.0	42.0	224	\$15.85
84540	29 mm	6 Pt. Std. Metric	41.0	41.0	42.0	260	\$16.85
84541	30 mm	6 Pt. Std. Metric	38.0	42.0	42.0	250	\$17.95
84542	31 mm	6 Pt. Std. Metric	38.0	42.0	42.0	250	\$17.95
84543	32 mm	6 Pt. Std. Metric	38.0	44.0	42.0	260	\$17.95
84544	36 mm	6 Pt. Std. Metric	38.0	50.0	50.0	260	\$25.30
84500D	3/8"	6 Pt. Std. SAE	22.0	16.0	38.0	65	\$8.40
84501	7/16"	6 Pt. Std. SAE	22.0	18.0	38.0	65	\$8.40
84502	1/2"	6 Pt. Std. SAE	22.0	18.0	38.0	65	\$8.40
84503	9/16"	6 Pt. Std. SAE	24.0	22.0	38.0	80	\$8.40
84504D	5/8"	6 Pt. Std. SAE	25.0	25.0	38.0	88	\$8.85
84505D	11/16"	6 Pt. Std. SAE	26.0	26.0	38.0	95	\$8.85
84506D	3/4"	6 Pt. Std. SAE	28.0	28.0	38.0	106	\$10.05
84507D	13/16"	6 Pt. Std. SAE	30.0	30.0	38.0	120	\$10.05
84508D	7/8"	6 Pt. Std. SAE	32.0	32.0	38.0	145	\$10.95
84509D	15/16"	6 Pt. Std. SAE	34.0	34.0	38.0	162	\$12.65
84510D	1"	6 Pt. Std. SAE	36.0	36.0	38.0	190	\$12.65
84511D	1-1/16"	6 Pt. Std. SAE	38.0	38.0	40.0	212	\$14.35
84512D	1-1/8"	6 Pt. Std. SAE	38.0	40.0	40.0	224	\$15.85
84513D	1-3/16"	6 Pt. Std. SAE	38.0	42.0	40.0	235	\$16.85
84514D	1-1/4"	6 Pt. Std. SAE	38.0	44.0	40.0	250	\$17.95
84515D	1-5/16"	6 Pt. Std. SAE	38.0	45.0	43.0	294	\$21.00
84516D	1-3/8"	6 Pt. Std. SAE	38.0	47.0	43.0	306	\$23.20
84517D	1-7/16"	6 Pt. Std. SAE	38.0	48.0	43.0	306	\$25.30
84518D	1-1/2"	6 Pt. Std. SAE	38.0	50.0	43.0	347	\$27.40

1/2" OPEN STOCK
IMPACT SOCKETS

1/2" OPEN STOCK



6 Pt. Deep Impact Sockets METRIC 1/2" DRIVE

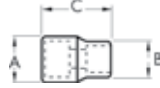

Material No.	Size	Description	Drive End (mm) A	Wrench End (mm) B	Overall Length (mm) C	Weight (g)	RRP
84571	13 mm	6 Pt. Deep Metric	24.0	20.2	78.0	175	\$8.05
84572	14 mm	6 Pt. Deep Metric	24.0	21.5	78.0	168	\$10.95
84573	15 mm	6 Pt. Deep Metric	24.0	24.0	78.0	168	\$10.95
84574	16 mm	6 Pt. Deep Metric	25.0	25.0	78.0	194	\$10.95
84575D	17 mm	6 Pt. Deep Metric	26.0	26.0	78.0	190	\$10.95
84576	18 mm	6 Pt. Deep Metric	26.0	26.0	78.0	180	\$10.95
84577	19 mm	6 Pt. Deep Metric	28.0	28.0	78.0	220	\$12.55
84578	20 mm	6 Pt. Deep Metric	30.0	30.0	78.0	260	\$13.75
84579	21 mm	6 Pt. Deep Metric	30.0	30.0	78.0	245	\$15.15
84580	22 mm	6 Pt. Deep Metric	32.0	32.0	78.0	286	\$15.15
84581	23 mm	6 Pt. Deep Metric	32.0	32.0	78.0	277	\$15.15
84582	24 mm	6 Pt. Deep Metric	34.0	34.0	78.0	314	\$16.45
84583	25 mm	6 Pt. Deep Metric	36.0	36.0	78.0	360	\$17.45
84584	26 mm	6 Pt. Deep Metric	36.0	36.0	78.0	362	\$17.45
84585D	27 mm	6 Pt. Deep Metric	38.0	38.0	78.0	405	\$18.95
84586D	28 mm	6 Pt. Deep Metric	40.0	40.0	78.0	445	\$20.70
84587	29 mm	6 Pt. Deep Metric	40.0	40.0	78.0	435	\$20.70
84588	30 mm	6 Pt. Deep Metric	38.0	42.0	78.0	454	\$22.10
84589D	31 mm	6 Pt. Deep Metric	38.0	44.0	78.0	470	\$22.10
84590D	32 mm	6 Pt. Deep Metric	38.0	44.0	78.0	495	\$22.10

IMPACT SOCKETS 1/2" OPEN STOCK

1/2" OPEN STOCK

6 Pt. Deep Impact Sockets SAE 1/2" DRIVE

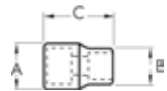

Material No.	Size	Description	Drive End (mm) A	Wrench End (mm) B	Overall Length (mm) C	Weight (g)	RRP
84546	3/8"	6 Pt. Deep SAE	22.0	16.0	78.0	150	\$10.40
84547	7/16"	6 Pt. Deep SAE	22.0	18.0	78.0	152	\$10.40
84548	1/2"	6 Pt. Deep SAE	22.0	18.0	78.0	152	\$10.40
84549	9/16"	6 Pt. Deep SAE	24.0	22.0	78.0	167	\$10.95
84550	5/8"	6 Pt. Deep SAE	25.0	25.0	78.0	182	\$10.95
84551	11/16"	6 Pt. Deep SAE	26.0	26.0	78.0	190	\$10.95
84552D	3/4"	6 Pt. Deep SAE	28.0	28.0	78.0	220	\$12.55
84553	13/16"	6 Pt. Deep SAE	30.0	30.0	78.0	245	\$13.75
84554D	7/8"	6 Pt. Deep SAE	32.0	32.0	78.0	283	\$15.15
84555D	15/16"	6 Pt. Deep SAE	34.0	34.0	78.0	320	\$16.45
84556	1"	6 Pt. Deep SAE	36.0	36.0	78.0	366	\$17.45
84557	1-1/16"	6 Pt. Deep SAE	38.0	38.0	78.0	415	\$18.95
84558	1-1/8"	6 Pt. Deep SAE	38.0	40.0	78.0	425	\$20.70
84560	1-1/4"	6 Pt. Deep SAE	38.0	44.0	78.0	489	\$22.10

1/2" OPEN STOCK
IMPACT SOCKETS

WRENCHES

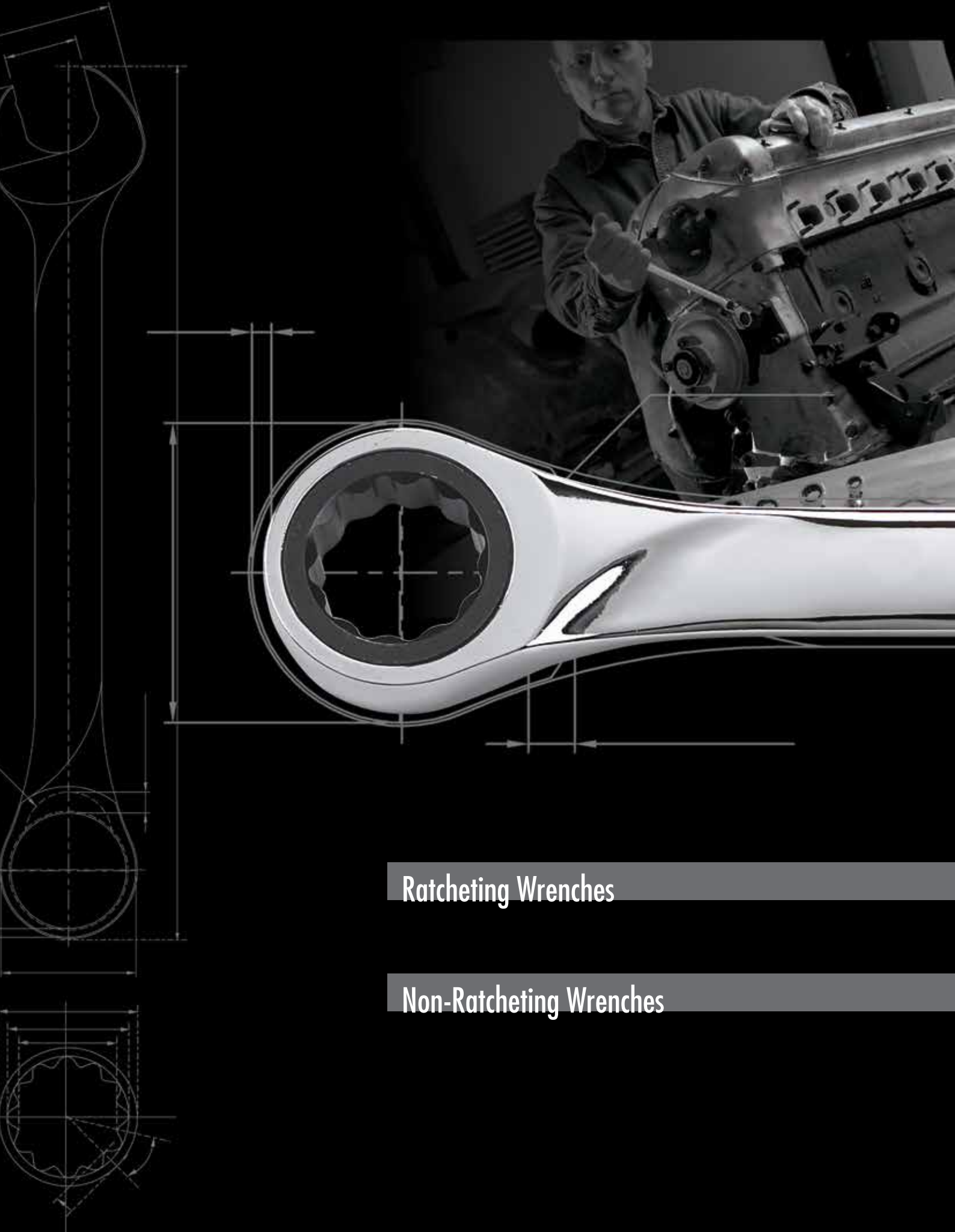

Ratcheting Wrenches

Non-Ratcheting Wrenches

120^{XP}

- Bright, full polish chrome



Strength

- Dual Direction Surface Drive® gives better grip and reduces fastener rounding
- Meets or Exceeds ASME B107.6 performance requirements

- Highly visible, recessed color size markings on each end, blue for metric and red for SAE

Speed

- Universal Spline Drive works on 6 common fasteners - 12-point, 6-point, rounded 6-point, Spline, E-Torx and Square

Access

- Reduced Open-End Diameter for increased access
- XL Beam Design is up to 25% longer for improved reach and leverage
- 120 Positions give a 3 degree swing arc for improved access
- Reduced Ratcheting Box-End Diameter for increased access

Also Available with Flex-Head



- Ratcheting Flex-Head Box-End gives adjustable access angle



AVAILABLE IN:



XL Combination



Indexing



XL Locking Flex



XL Spline



XL GearBox™



Reversible



Flex



Stubby Flex



Combination



Stubby



QuadBox™



Double Box



Half Moon

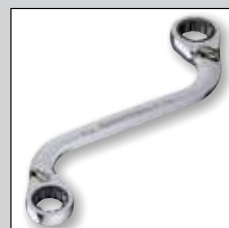

S-Shape



E-Torx®

WRENCHES

RATCHETING WRENCHES

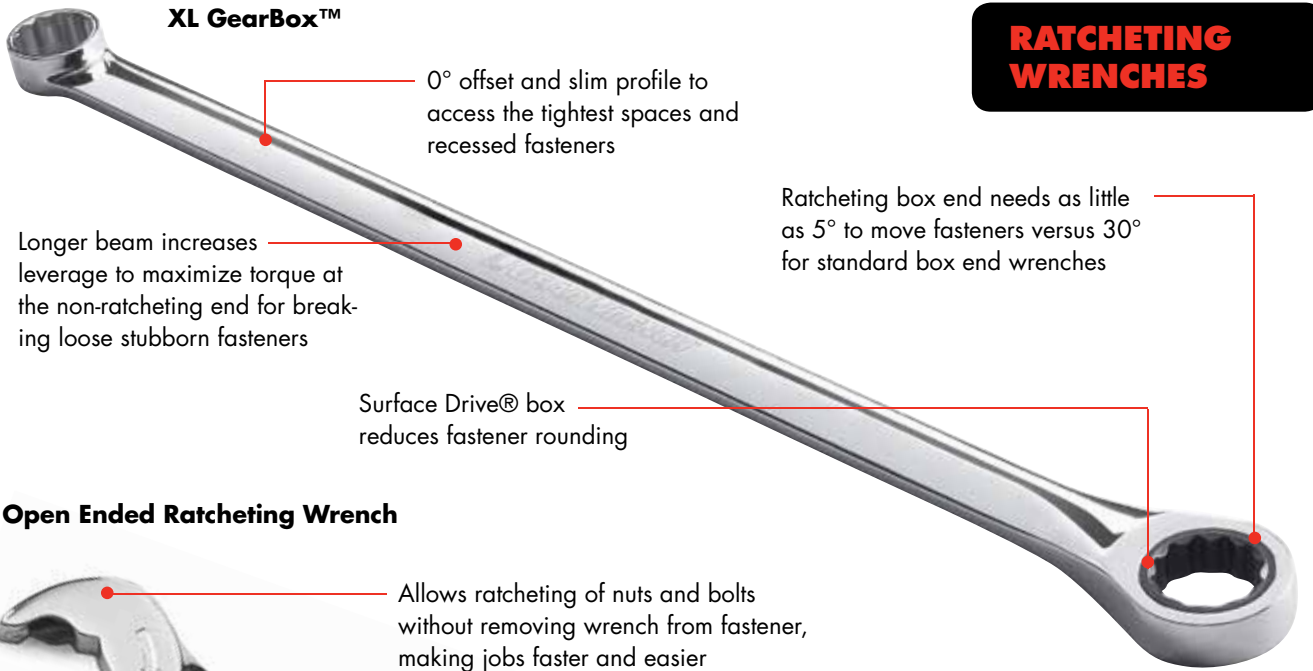

Open Ended Ratcheting Wrench

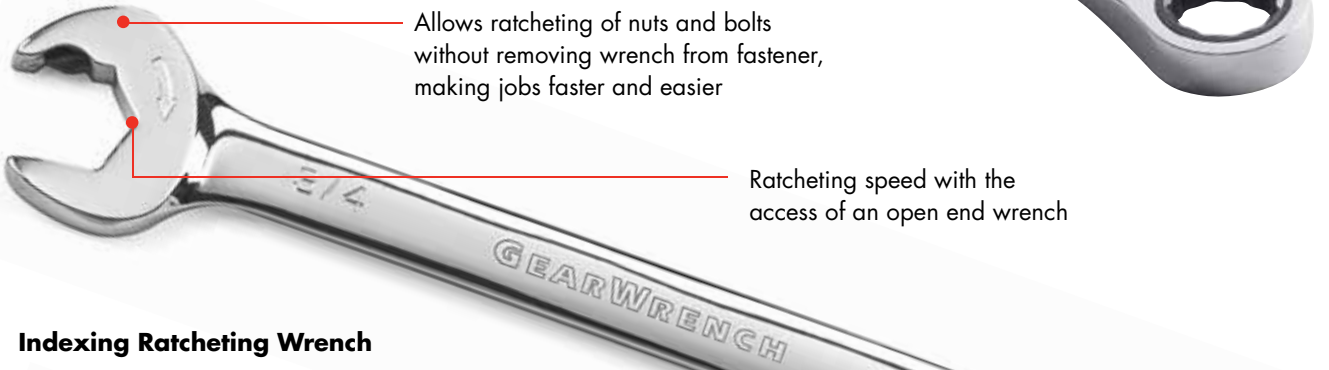

Indexing Ratcheting Wrench

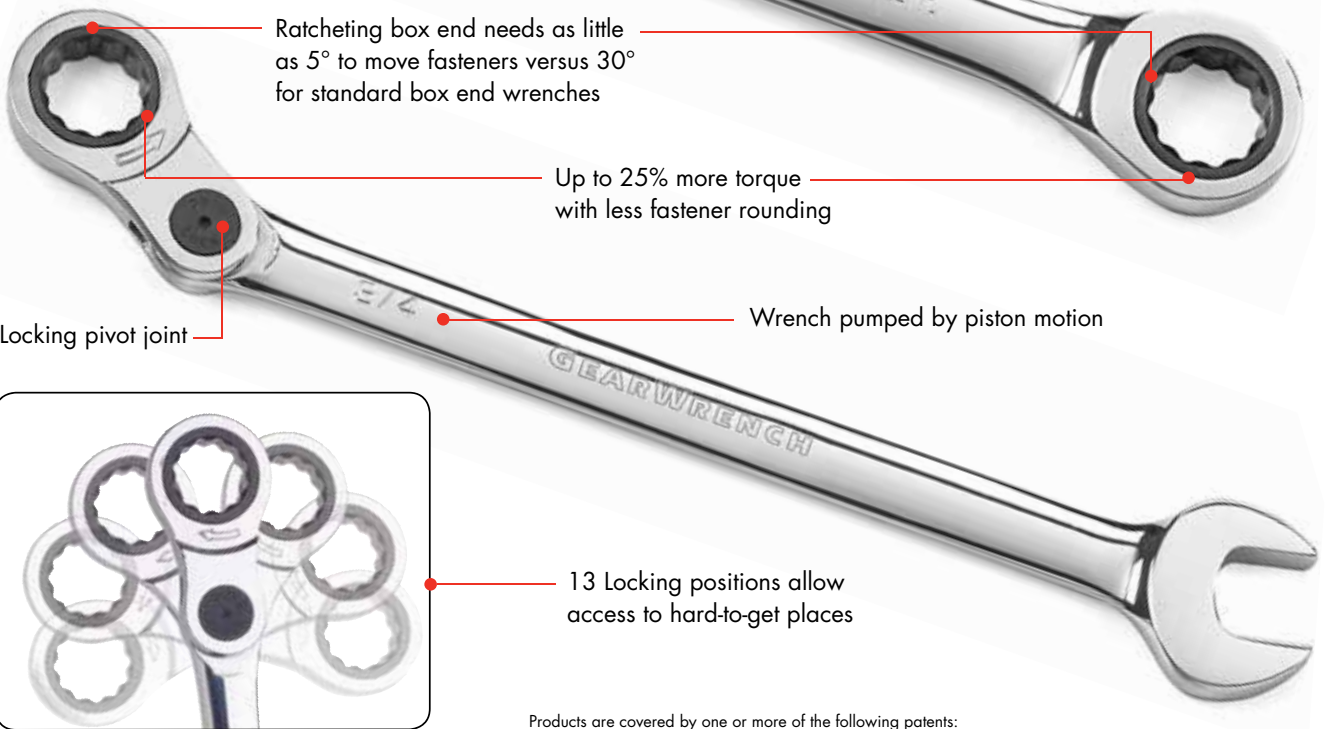

Products are covered by one or more of the following patents:
 • US 5,636,557 US 6,629,477 US 6,918,477 US 7,131,356 US 7,000,507
 US 7,165,480 US 6,868,709 US 7,231,851 US 6,840,141

**COMBINATION RATCHETING WRENCH
- OPEN STOCK**



Open Stock - Combination Ratcheting Wrench METRIC

Material No.	Opening Inches/Metric	Overall Length (mm) A	Width Open End (mm) B	Thickness Open End (mm) C	Width Box End (mm) D	Thickness Box End (mm) E	Weight (g)	RRP
9106	6 mm	125	15	4.6	15.5	6.5	32	\$12.15
9107	7 mm	133	16	4.8	15.8	6.5	40	\$14.35
9108D	8 mm	140	20	5.0	16.9	6.9	45	\$14.75
9109	9 mm	149	20	5.4	17.8	6.9	50	\$14.95
9110D	10 mm	159	22	5.7	19.8	7.7	68	\$16.15
9111	11 mm	165	24	6.4	21.7	8.2	68	\$16.95
9112	12 mm	171	27	7.4	23.0	8.6	91	\$17.35
9113D	13 mm	178	29	8.1	25.0	8.6	104	\$18.05
9114D	14 mm	190	31	8.3	26.2	9.4	123	\$18.45
9115D	15 mm	200	34	8.3	28.7	9.9	113	\$18.80
9116D	16 mm	208	35	8.8	30.5	10.3	150	\$19.45
9117D	17 mm	226	38	9.2	32.3	10.7	172	\$20.60
9118D	18 mm	237	40	9.4	33.2	11.2	207	\$22.35
9119	19 mm	248	42	9.5	34.0	11.2	213	\$25.45
9120	20 mm	292	46	9.9	39.0	13.0	353	\$28.30
9121	21 mm	292	46	9.9	39.0	13.0	367	\$29.40
9122	22 mm	292	46	9.9	39.0	13.0	363	\$30.20
9124	24 mm	333	53	10.9	45.5	14.5	522	\$35.20
9125D	25 mm	333	53	10.9	45.5	14.5	527	\$39.85
9127D	27 mm	359	57	14.5	49.0	15.5	599	\$48.25
9130D	30 mm	402	63	12.5	54.8	17.0	794	\$55.80
9132	32 mm	426	67	12.9	58.0	17.5	1002	\$60.30
9134D	34 mm	460	70	13.7	60.0	17.5	1184	\$64.25
9136	36 mm	500	79	16.4	65.0	20.5	2018	\$126.45
9141D	41 mm	575	87	18.0	68.0	22.0	2599	\$147.45
9146D	46 mm	645	98	21.0	76.0	25.0	3592	\$185.35
9150	50 mm	655	105	21.0	80.0	26.5	3982	\$208.65

PATENTED

OPEN STOCK
WRENCHES

**COMBINATION RATCHETING WRENCH
- OPEN STOCK**



Open Stock - Combination Ratcheting Wrench SAE

Material No.	Opening Inches/Metric	Overall Length (mm) A	Width Open End (mm) B	Thickness Open End (mm) C	Width Box End (mm) D	Thickness Box End (mm) E	Weight (g)	RRP
9008	1/4"	125	15	4.6	15.5	6.5	45	\$14.25
9010D	5/16"	140	20	5.0	16.9	6.9	54	\$14.65
9011D	11/32"	149	20	5.4	17.8	6.9	54	\$15.05
9012D	3/8"	159	22	5.7	19.8	7.7	64	\$15.35
9014	7/16"	165	24	6.4	21.7	8.2	77	\$15.75
9016D	1/2"	178	29	8.1	25.0	8.6	100	\$17.60
9018D	9/16"	190	31	8.3	26.2	9.4	104	\$18.05
9020	5/8"	208	35	8.8	30.5	10.3	150	\$19.60
9022	11/16"	226	38	9.2	32.3	10.7	172	\$21.60
9024	3/4"	248	42	9.5	34.0	11.2	213	\$25.45
9026D	13/16"	292	46	9.9	39.0	13.0	390	\$29.50
9028D	7/8"	292	46	9.9	39.0	13.0	363	\$30.75
9030	15/16"	333	53	10.9	45.5	14.5	531	\$35.75
9032	1"	333	53	10.9	45.5	14.5	522	\$37.05
9034	1-1/16"	359	57	14.5	49.0	15.5	599	\$48.25
9036	1-1/8"	402	63	12.5	54.8	17.0	894	\$53.00
9038D	1-1/4"	426	67	12.9	58.0	17.5	988	\$52.90
9060D	1-5/16"	460	70	13.7	60.0	17.5	1198	\$57.75
9062D	1-3/8"	460	70	13.7	60.0	17.5	1198	\$73.75
9040	1-7/16"	500	79	16.4	65.0	20.5	1751	\$122.25
9042	1-1/2"	500	79	16.4	65.0	20.5	1733	\$130.65
9044	1-9/16"	575	87	18.0	68.0	22.0	2351	\$143.30
9046D	1-5/8"	575	87	18.0	68.0	22.0	2332	\$151.65
9048	1-11/16"	615	92	20.0	72.0	23.5	2581	\$164.40
9050D	1-3/4"	615	92	20.0	72.0	23.5	2559	\$168.60
9052D	1-13/16"	645	98	21.0	76.0	25.0	3470	\$191.70
9054D	1-7/8"	645	98	21.0	76.0	25.0	3443	\$200.20
9056D	2"	655	105	21.0	80.0	26.5	3783	\$208.65

OPEN STOCK
WRENCHES

COMBINATION RATCHETING WRENCH SETS

9404 - 4 Pc. Combination Ratcheting Wrench Set METRIC RRP \$56.90

Material No.	Description
9110	10 mm Combination Ratcheting Wrench
9112	12 mm Combination Ratcheting Wrench
9113	13 mm Combination Ratcheting Wrench
9114	14 mm Combination Ratcheting Wrench



9304 - 4 Pc. Combination Ratcheting Wrench Set SAE RRP \$56.90

Material No.	Description
9012	3/8" Combination Ratcheting Wrench
9014	17/16" Combination Ratcheting Wrench
9016	1/2" Combination Ratcheting Wrench
9018	9/16" Combination Ratcheting Wrench



93004D - 5 Pc. Combination Ratcheting Wrench Set METRIC RRP \$73.75

Material No.	Description
9110	10 mm Combination Ratcheting Wrench
9112	12 mm Combination Ratcheting Wrench
9113	13 mm Combination Ratcheting Wrench
9114	14 mm Combination Ratcheting Wrench
9115	15 mm Combination Ratcheting Wrench



93005 - 5 Pc. Combination Ratcheting Wrench Set SAE RRP \$73.75

Material No.	Description
9012	3/8" Combination Ratcheting Wrench
9014	7/16" Combination Ratcheting Wrench
9016	1/2" Combination Ratcheting Wrench
9018	9/16" Combination Ratcheting Wrench
9020	5/8" Combination Ratcheting Wrench



9417 - 7 Pc. Combination Ratcheting Wrench Set METRIC RRP \$99.05

Material No.	Description
9108	8 mm Combination Ratcheting Wrench
9110	10 mm Combination Ratcheting Wrench
9112	12 mm Combination Ratcheting Wrench
9113	13 mm Combination Ratcheting Wrench
9114	14 mm Combination Ratcheting Wrench
9115	15 mm Combination Ratcheting Wrench
9118	18 mm Combination Ratcheting Wrench



PATENTED

Note: Individual materials may not be available for separate purchase.

SETS

WRENCHES

COMBINATION RATCHETING WRENCH SETS



9317 - 7 Pc. Combination Ratcheting Wrench Set SAE RRP \$99.05

Material No.	Description
9010	5/16" Combination Ratcheting Wrench
9012	3/8" Combination Ratcheting Wrench
9014	7/16" Combination Ratcheting Wrench
9016	1/2" Combination Ratcheting Wrench
9018	9/16" Combination Ratcheting Wrench
9020	5/8" Combination Ratcheting Wrench
9024	3/4" Combination Ratcheting Wrench



9418 - 10 Pc. Combination Ratcheting Wrench Set SAE/METRIC RRP \$109.50

Material No.	Description	Material No.	Description
9010	5/16"	9108	8 mm
9012	3/8"	9110	10 mm
9014	7/16"	9112	12 mm
9016	1/2"	9113	13 mm
9018	9/16"	9114	14 mm



9416 - 16 Pc. Combination Ratcheting Wrench Set METRIC RRP \$263.40

Material No.	Description	Material No.	Description
9108	8 mm	9116	16 mm
9109	9 mm	9117	17 mm
9110	10 mm	9118	18 mm
9111	11 mm	9119	19 mm
9112	12 mm	9120	20 mm
9113	13 mm	9121	21 mm
9114	14 mm	9122	22 mm
9115	15 mm	9124	24 mm



9312 - 13 Pc. Combination Ratcheting Wrench Set SAE RRP \$242.25

Material No.	Description	Material No.	Description
9008	1/4"	9022	11/16"
9010	5/16"	9024	3/4"
9012	3/8"	9026	13/16"
9014	7/16"	9028	7/8"
9016	1/2"	9030	15/16"
9018	9/16"	9032	1"
9020	5/8"		

PATENTED

Note: Individual materials may not be available for separate purchase.

SETS

WRENCHES

COMBINATION RATCHETING WRENCH SETS

9412 - 12 Pc. Combination Ratcheting Wrench Set METRIC RRP \$166.50

Material No.	Description	Material No.	Description
9108	8 mm	9114	14 mm
9109	9 mm	9115	15 mm
9110	10 mm	9116	16 mm
9111	11 mm	9117	17 mm
9112	12 mm	9118	18 mm
9113	13 mm	9119	19 mm



9308D - 8 Pc. Combination Ratcheting Wrench Set SAE RRP \$118.00

Material No.	Description	Material No.	Description
9010	5/16"	9018	9/16"
9012	3/8"	9020	5/8"
9014	7/16"	9022	11/16"
9016	1/2"	9024	3/4"



XL COMBINATION RATCHETING WRENCH SETS

20% Longer & 25% Stronger

85098 - 12 Pc. XL Combination Ratcheting Wrench Set METRIC RRP \$379.30

Material No.	Description	Material No.	Description
85008	8 mm	85014	14 mm
85009	9 mm	85015	15 mm
85010	10 mm	85016	16 mm
85011	11 mm	85017	17 mm
85012	12 mm	85018	18 mm
85013	13 mm	85019	19 mm



85198 - 8 Pc. XL Combination Ratcheting Wrench Set SAE RRP \$273.85

Material No.	Description	Material No.	Description
85110	5/16"	85118	9/16"
85112	3/8"	85120	5/8"
85114	7/16"	85122	11/16"
85116	1/2"	85124	3/4"



SETS
WRENCHES

Note: Individual materials may not be available for separate purchase.

PATENTED

XL COMBINATION RATCHETING WRENCH SETS

20% Longer & 25% Stronger



85099R - 16 Pc. XL Combination Ratcheting Wrench Set METRIC - Wrench Roll RRP \$526.75

Material No.	Description	Material No.	Description
85008	8 mm	85016	16 mm
85009	9 mm	85017	17 mm
85010	10 mm	85018	18 mm
85011	11 mm	85019	19 mm
85012	12 mm	85020	20 mm
85013	13 mm	85021	21 mm
85014	14 mm	85022	22 mm
85015	15 mm	85024	24 mm



85199R - 13 Pc. XL Combination Ratcheting Wrench Set SAE - Wrench Roll RRP \$484.60

Material No.	Description	Material No.	Description
85108	1/4"	85122	11/16"
85110	5/16"	85124	3/4"
85112	3/8"	85126	13/16"
85114	7/16"	85128	7/8"
85116	1/2"	85130	15/16"
85118	9/16"	85132	1"
85120	5/8"		



86426 - 14 Pc. 120XP™ Universal Spline XL Combination Ratcheting Wrench Set METRIC RRP \$386.90

Material No.	Description	Material No.	Description
86406	6 mm	86413	13 mm
86407	7 mm	86414	14 mm
86408	8 mm	86415	15 mm
86409	9 mm	86416	16 mm
86410	10 mm	86417	17 mm
86411	11 mm	86418	18 mm
86412	12 mm	86419	19 mm



86450 - 11 Pc. 120XP™ Universal Spline XL Combination Ratcheting Wrench Set SAE RRP \$313.50

Material No.	Description	Material No.	Description
86431	1/4"	86438	9/16"
86432	9/32"	86439	5/8"
86433	5/16"	86440	11/16"
86434	11/32"	86441	3/4"
86435	3/8"		
86436	7/16"		
86437	1/2"		

PATENTED

Note: Individual materials may not be available for separate purchase.

SETS
WRENCHES

XL COMBINATION RATCHETING WRENCH SETS

20% Longer & 25% Stronger

86229 - 12 Pc. 120XP™ Universal Spline XL Flex Combination Ratcheting Wrench Set METRIC RRP \$386.90

Material No.	Description	Material No.	Description
86208	8mm	86214	14 mm
86209	9 mm	86215	15 mm
86210	10 mm	86216	16 mm
86211	11 mm	86217	17 mm
86212	12 mm	86218	18 mm
86213	13 mm	86219	19 mm



86247 - 11 Pc. 120XP™ Universal Spline XL Flex Combination Ratcheting Wrench Set SAE RRP \$355.45

Material No.	Description	Material No.	Description
86232	1/4"	86238	1/2"
86233	9/32"	86239	9/16"
86234	5/16"	86240	5/8"
86235	11/32"	86241	11/16"
86236	3/8"	86242	3/4"
86237	7/16"		



86126 - 10 Pc. 120XP™ Universal Spline XL Flex GearBox Ratcheting Wrench Set METRIC RRP \$382.70

Material No.	Description	Material No.	Description
86110	10 mm	86115	15 mm
86111	11 mm	86116	16 mm
86112	12 mm	86117	17 mm
86113	13 mm	86118	18 mm
86114	14 mm	86119	19 mm



86142 - 10 Pc. 120XP™ Universal Spline XL Flex GearBox Ratcheting Wrench Set SAE RRP \$382.70

Material No.	Description	Material No.	Description
86128	1/4"	86134	9/16"
86129	5/16"	86135	5/8"
86130	11/32"	86136	11/16"
86131	3/8"	86137	3/4"
86132	7/16"		
86133	1/2"		



SETS
WRENCHES

Note: Individual materials may not be available for separate purchase.

PATENTED

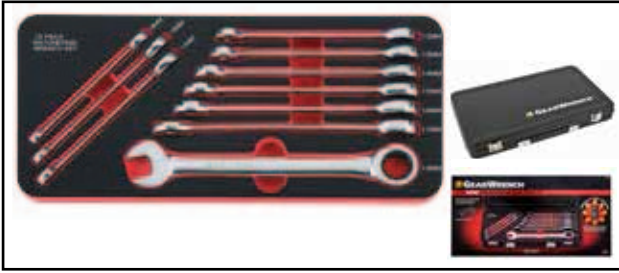

83052 - 10 Pc. Wrench Set Ratcheting Combination METRIC

RRP \$165.95

Description

Combination Ratcheting Wrench: 8mm, 10mm, 11mm, 12mm, 13mm, 14mm, 15mm, 16mm, 17mm, 19mm

Metal Case with EVA Tray Insert: 168mm x 360mm

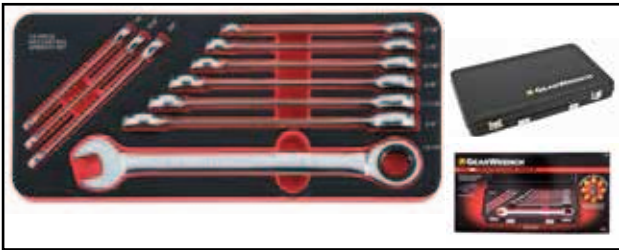

83053 - 10 Pc. Wrench Set Ratcheting Combination SAE

RRP \$165.95

Description

Combination Ratcheting Wrench: 1/4", 5/16", 3/8", 7/16", 1/2", 9/16", 5/8", 11/16", 3/4", 13/16"

Metal Case with EVA Tray Insert: 168mm x 360mm



83075 - 24 Pc. Ratcheting Wrench Set METRIC/SAE

RRP \$275.45

Description

Combination Ratcheting Wrench METRIC: 7mm, 8mm, 9mm, 10mm, 11mm, 12mm, 13mm, 14mm, 15mm, 16mm, 17mm, 19mm, 20mm, 21mm, 22mm

Combination Ratcheting Wrench SAE: 5/16", 3/8", 7/16", 1/2", 9/16", 3/8", 11/16", 3/4", 3/16"

EVA Tray Included: uncut 655mm x 395mm, cut = 557mm x 360mm

Fits drawer type **A** as shown on page 28.

SETS
WRENCHES

**REVERSIBLE COMBINATION
RATCHETING WRENCH - OPEN STOCK**



Open Stock - Reversible Combination Ratcheting Wrench METRIC/SAE

Material No.	Opening Inches/Metric	Overall Length (mm) A	Width Open End (mm) B	Thickness Open End (mm) C	Width Box End (mm) D	Thickness Box End (mm) E	Weight (g)	RRP
9608N	8 mm	138.0	20.0	5.0	16.9	6.9	33	\$18.80
9609N	9 mm	147.2	20.0	5.4	17.8	6.9	41	\$20.05
9610N	10 mm	156.7	22.0	5.7	19.8	7.7	52	\$19.10
9611N	11 mm	162.9	24.0	6.4	21.7	8.2	73	\$22.10
9612N	12 mm	169.1	26.6	7.4	23.0	8.6	76	\$23.20
9613N	13 mm	175.3	29.0	8.1	25.0	8.6	88	\$25.30
9614N	14 mm	187.9	31.0	8.3	26.2	9.4	110	\$27.40
9615N	15 mm	196.8	34.0	8.3	28.7	9.9	128	\$27.40
9616N	16 mm	205.4	35.0	8.8	30.5	10.3	158	\$27.40
9617N	17 mm	222.0	38.0	9.2	32.3	10.7	182	\$31.65
9618N	18 mm	232.9	41.0	9.4	33.2	11.2	209	\$33.75
9619N	19 mm	243.7	42.0	9.5	34.0	11.2	243	\$33.75
9621N	21 mm	291.5	46.0	9.9	39.0	13.0	356	\$44.25
9622N	22 mm	291.5	46.0	9.9	39.0	13.0	345	\$50.55
9624N	24 mm	355.6	53.0	10.9	45.5	14.5	532	\$50.55
9625N	25 mm	355.6	53.0	10.9	45.5	14.5	522	\$59.00
9525ND	5/16"	138.0	19.5	5.0	16.9	6.9	360	\$18.80
9521ND	11/32"	147.2	19.5	5.4	17.8	6.9	408	\$20.05
9526ND	3/8"	156.7	21.9	5.7	19.8	7.7	62	\$20.05
9527N	7/16"	162.9	24.2	6.4	21.7	8.2	70	\$22.10
9528N	1/2"	175.3	29.0	8.1	25.0	8.6	93	\$23.20
9529N	9/16"	187.9	31.0	8.3	26.2	9.4	110	\$25.30
9530ND	5/8"	205.4	35.0	8.8	30.5	10.3	156	\$27.40
9531ND	11/16"	222.0	38.0	9.2	32.3	10.7	181	\$31.65
9532N	3/4"	243.7	42.0	9.5	34.0	11.2	243	\$33.75
9534N	13/16"	291.5	46.0	9.9	39.0	13.0	356	\$42.15
9538N	7/8"	291.5	46.0	9.9	39.0	13.0	345	\$44.25
9539N	15/16"	355.6	53.0	10.9	45.5	14.5	532	\$50.55
9540N	1"	355.6	53.0	10.9	45.5	14.5	598	\$59.00

OPEN STOCK
WRENCHES

REVERSIBLE COMBINATION RATCHETING WRENCH SETS



9543 - 8 Pc. Reversible Combination Ratcheting Wrench Set METRIC RRP \$160.15

Material No.	Description	Material No.	Description
9608	8 mm	9614	14 mm
9610	10 mm	9615	15 mm
9612	12 mm	9617	17 mm
9613	13 mm	9619	19 mm



9533N - 8 Pc. Reversible Combination Ratcheting Wrench Set SAE RRP \$160.15

Material No.	Description	Material No.	Description
9525	5/16"	9529	9/16"
9526	3/8"	9530	5/8"
9527	7/16"	9531	11/16"
9528	1/2"	9532	3/4"



9620N - 12 Pc. Reversible Combination Ratcheting Wrench Set METRIC RRP \$231.75

Material No.	Description	Material No.	Description
9608	8 mm	9614	14 mm
9609	9 mm	9615	15 mm
9610	10 mm	9616	16 mm
9611	11 mm	9617	17 mm
9612	12 mm	9618	18 mm
9613	13 mm	9619	19 mm



9602N - 16 Pc. Reversible Combination Ratcheting Wrench Set METRIC RRP \$326.55

Material No.	Description	Material No.	Description
9608	8 mm	9616	16 mm
9609	9 mm	9617	17 mm
9610	10 mm	9618	18 mm
9611	11 mm	9619	19 mm
9612	12 mm	9621	21 mm
9613	13 mm	9622	22 mm
9614	14 mm	9624	24 mm
9615	15 mm	9625	25 mm

SETS
WRENCHES

PATENTED

Note: Individual materials may not be available for separate purchase.

REVERSIBLE COMBINATION RATCHETING WRENCH SETS

9509N - 13 Pc. Reversible Combination Ratcheting Wrench Set SAE RRP \$263.40

Material No.	Description	Material No.	Description
9525	5/16"	9531	11/16"
9521	11/32"	9532	3/4"
9526	3/8"	9534	13/16"
9527	7/16"	9538	7/8"
9528	1/2"	9539	15/16"
9529	9/16"	9540	1"
9530	5/8"		



9602RN - 16 Pc. Reversible Combination Ratcheting Wrench Set Roll METRIC RRP \$326.55

Material No.	Description	Material No.	Description
9608	8 mm	9616	16 mm
9609	9 mm	9617	17 mm
9610	10 mm	9618	18 mm
9611	11 mm	9619	19 mm
9612	12 mm	9621	21 mm
9613	13 mm	9622	22 mm
9614	14 mm	9624	24 mm
9615	15 mm	9625	25 mm



9509RN - 13 Pc. Reversible Combination Ratcheting Wrench Set Roll SAE RRP \$263.40

Material No.	Description	Material No.	Description
9525	5/16"	9531	11/16"
9521	11/32"	9532	3/4"
9526	3/8"	9534	13/16"
9527	7/16"	9538	7/8"
9528	1/2"	9539	15/16"
9529	9/16"	9540	1"
9530	5/8"		



SETS
WRENCHES

PATENTED

Note: Individual materials may not be available for separate purchase.

**OPEN END RATCHETING WRENCH
- OPEN STOCK**

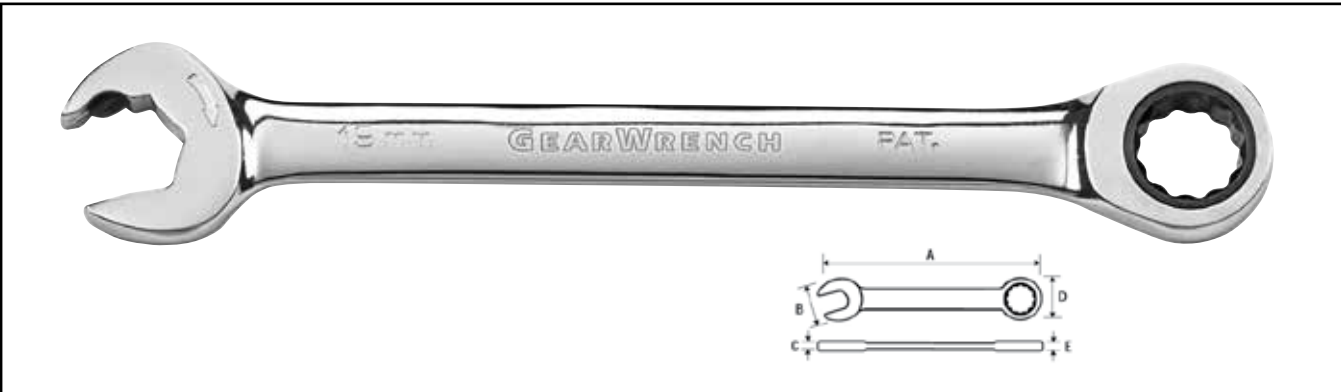

Open Stock - Open End Ratcheting Wrenches METRIC/SAE

Material No.	Opening Metric/Inches	Overall Length (mm) A	Width Open End (mm) B	Thickness Open End (mm) C	Width Box End (mm) D	Thickness Box End (mm) E	Weight (g)	RRP
85508	8 mm	139.9	16.71	5.004	15.87	6.502	29	\$16.70
85509	9 mm	149.4	18.82	5.309	17.50	6.908	41	\$16.70
85510	10 mm	158.9	20.88	5.588	19.05	7.289	56	\$17.05
85511	11 mm	165.3	22.99	6.096	20.60	7.696	64	\$17.95
85512D	12 mm	171.6	25.09	6.604	21.72	8.205	80	\$17.95
85513	13 mm	178.0	27.15	7.697	23.62	8.611	84	\$17.95
85514D	14 mm	190.6	29.26	7.798	25.91	8.992	107	\$18.95
85515	15 mm	199.5	31.32	8.001	27.18	9.398	130	\$18.95
85516	16 mm	208.3	33.43	8.789	28.70	9.906	154	\$21.00
85517	17 mm	225.5	35.54	9.398	30.51	10.313	188	\$22.10
85518	18 mm	236.6	37.59	9.398	31.48	10.694	194	\$23.20
85519	19 mm	248.0	39.70	9.804	32.46	11.201	321	\$25.30
85570	5/16"	139.9	16.72	5.00	15.88	6.502	21	\$16.70
85572	3/8"	158.9	20.88	5.588	19.05	7.289	28	\$17.05
85574	7/16"	165.3	22.99	6.096	20.59	7.696	32	\$17.95
85576	1/2"	178.0	27.15	7.696	23.62	8.611	42	\$17.95
85578	9/16"	190.6	29.26	7.798	25.90	8.992	55	\$18.95
85580	5/8"	208.3	33.43	8.789	28.70	9.906	65	\$21.00
85582	11/16"	225.5	35.54	9.398	30.51	10.313	89	\$23.20
85584	3/4"	248.0	39.70	9.804	32.46	11.201	124	\$25.30

OPEN STOCK
WRENCHES

OPEN END RATCHETING WRENCH SETS

85597 - 12 Pc. Open End Ratcheting Set METRIC RRP \$204.65

Material No.	Description
85508	8 mm Ratcheting Open End Wrench
85509	9 mm Ratcheting Open End Wrench
85510	10 mm Ratcheting Open End Wrench
85511	11 mm Ratcheting Open End Wrench
85512	12 mm Ratcheting Open End Wrench
85513	13 mm Ratcheting Open End Wrench
85514	14 mm Ratcheting Open End Wrench
85515	15 mm Ratcheting Open End Wrench
85516	16 mm Ratcheting Open End Wrench
85517	17 mm Ratcheting Open End Wrench
85518	18 mm Ratcheting Open End Wrench
85519	19 mm Ratcheting Open End Wrench



85599 - 8 Pc. Open End Ratcheting Set SAE RRP \$143.80

Material No.	Description
85570	5/16" Ratcheting Open End Wrench
85572	3/8" Ratcheting Open End Wrench
85574	7/16" Ratcheting Open End Wrench
85576	1/2" Ratcheting Open End Wrench
85578	9/16" Ratcheting Open End Wrench
85580	5/8" Ratcheting Open End Wrench
85582	11/16" Ratcheting Open End Wrench
85584	3/4" Ratcheting Open End Wrench



83056 - 10 Pc. Wrench Set Open End Ratcheting Combination METRIC RRP \$175.90

Description

Open Ended Ratcheting Combination Wrench: 8mm, 10mm, 11mm, 12mm, 13mm, 14mm, 15mm, 16mm, 17mm, 19mm

Metal Case with EVA Tray Insert: 168mm x 360mm



SETS
WRENCHES

Note: Individual materials may not be available for separate purchase.

PATENTED

FLEX COMBINATION RATCHETING WRENCH - OPEN STOCK



Open Stock - Flex Combination Ratcheting Wrench METRIC/SAE

Material No.	Opening Metric/Inches	Overall Length (mm) A	Width Open End (mm) B	Thickness Open End (mm) C	Width Box End (mm) D	Thickness Box End (mm) E	Weight (g)	RRP
9908D	8 mm	139.9	19.5	5.0	16.89	6.90	39.01	\$23.20
9909D	9 mm	149.4	19.5	5.41	17.81	6.90	46.72	\$23.60
9910D	10 mm	158.8	21.89	5.68	19.81	7.70	62.59	\$25.45
9911D	11 mm	165.2	24.21	6.40	21.69	7.70	73.48	\$26.70
9912D	12 mm	144.2	26.60	7.40	23.01	8.61	89.35	\$27.40
9913D	13 mm	177.9	29.10	8.10	25.00	8.61	107.9	\$28.50
9914D	14 mm	190.6	31.18	8.30	26.29	9.40	126.5	\$29.20
9915D	15 mm	199.5	33.71	8.30	28.70	9.90	151.5	\$29.80
9916D	16 mm	208.2	34.5	8.78	30.50	10.31	173.7	\$30.75
9917	17 mm	225.5	37.89	9.19	32.31	10.70	204.5	\$32.65
9918	18 mm	236.6	40.20	9.40	33.19	11.20	234.5	\$35.40
9919D	19 mm	248.0	41.30	9.49	34.01	11.20	267.6	\$40.15
9921D	21 mm	291.5	46.0	9.91	38.99	13.0	401.8	\$46.55
9922D	22 mm	291.5	46.0	9.91	38.99	13.0	393.7	\$47.80
9924D	24 mm	333.1	52.18	10.90	45.49	14.50	594.2	\$55.50
9925D	25 mm	355.6	52.19	10.90	45.49	14.50	521.6	\$60.10
9704D	11/32"	149.4	19.50	5.41	17.81	6.90	49.89	\$23.80
9705	5/16"	139.9	19.50	5.00	16.89	6.90	39.46	\$23.10
9706	3/8"	158.8	21.9	5.68	19.81	7.70	62.59	\$24.35
9707	7/16"	165.2	24.2	6.0	21.69	7.70	76.20	\$24.80
9708	1/2"	177.9	29.1	8.10	25.00	8.61	107.9	\$27.80
9709	9/16"	190.6	31.19	8.31	26.29	9.40	127.9	\$28.50
9710	5/8"	208.2	34	8.79	30.51	10.31	173.7	\$30.90
9711	11/16"	225.5	37.49	9.19	32.31	10.70	203.2	\$34.20
9712	3/4"	248.0	41.30	9.49	34.01	11.20	266.7	\$40.15
9713	13/16"	291.5	46.00	9.90	38.99	13.00	408.2	\$46.70
9714D	7/8"	291.5	46.00	9.90	38.99	13.00	391.9	\$48.65
9715D	15/16"	333.1	52.19	10.90	45.49	14.50	596.9	\$56.50
9716D	1"	333.1	52.19	10.90	45.49	14.50	586.0	\$58.60

PATENTED

OPEN STOCK

WRENCHES

FLEX COMBINATION RATCHETING WRENCH SETS

9900D - 7 Pc. Flex Combination Ratcheting Wrench Set METRIC RRP \$198.00

Material No.	Description	Material No.	Description
9910	10 mm	9915	15 mm
9912	12 mm	9917	17 mm
9913	13 mm	9919	19 mm
9914	14 mm		



9700 - 7 Pc. Flex Combination Ratcheting Wrench Set SAE RRP \$188.05

Material No.	Description	Material No.	Description
9706	3/8"	9710	5/8"
9707	7/16"	9711	11/16"
9708	1/2"	9712	3/4"
9709	9/16"		



9901D - 12 Pc. Flex Combination Ratcheting Wrench Set METRIC RRP \$252.90

Material No.	Description	Material No.	Description
9908	8 mm	9914	14 mm
9909	9 mm	9915	15 mm
9910	10 mm	9916	16 mm
9911	11 mm	9917	17 mm
9912	12 mm	9918	18 mm
9913	13 mm	9919	19 mm



9701 - 8 Pc. Flex Combination Ratcheting Wrench Set SAE RRP \$199.10

Material No.	Description	Material No.	Description
9705	5/16"	9709	9/16"
9706	3/8"	9710	5/8"
9707	7/16"	9711	11/16"
9708	1/2"	9712	3/4"



Note: Individual materials may not be available for separate purchase.

PATENTED

SETS
WRENCHES

FLEX COMBINATION RATCHETING WRENCH SETS



9902D - 16 Pc. Flex Combination Ratcheting Wrench Set METRIC RRP \$367.25

Material No.	Description	Material No.	Description
9908	8 mm	9916	16 mm
9909	9 mm	9917	17 mm
9910	10 mm	9918	18 mm
9911	11 mm	9919	19 mm
9912	12 mm	9921	21 mm
9913	13 mm	9922	22 mm
9914	14 mm	9924	24 mm
9915	15 mm	9925	25 mm



9702D - 13 Pc. Flex Combination Ratcheting Wrench Set SAE RRP \$264.40

Material No.	Description	Material No.	Description
9705	5/16"	9711	11/16"
9704	11/32"	9712	3/4"
9706	3/8"	9713	13/16"
9707	7/16"	9714	7/8"
9708	1/2"	9715	15/16"
9709	9/16"	9716	1"
9710	5/8"		



86247 - 11 Pc. 120XP™ Universal Spline XL Flex Combination Ratcheting Wrench Set SAE RRP \$355.45

Material No.	Description	Material No.	Description
86232	1/4"	86238	1/2"
86233	9/32"	86239	9/16"
86234	5/16"	86240	5/8"
86235	11/32"	86241	11/16"
86236	3/8"	86242	3/4"
86237	7/16"		



86229 - 12 Pc. 120XP™ Universal Spline XL Flex Combination Ratcheting Wrench Set METRIC RRP \$386.90

Material No.	Description	Material No.	Description
86208	8mm	86214	14 mm
86209	9 mm	86215	15 mm
86210	10 mm	86216	16 mm
86211	11 mm	86217	17 mm
86212	12 mm	86218	18 mm
86213	13 mm	86219	19 mm

PATENTED

Note: Individual materials may not be available for separate purchase.

SETS
WRENCHES

STUBBY COMBINATION RATCHETING WRENCH - OPEN STOCK



Open Stock - Stubby Combination Ratcheting Wrench METRIC

Item No.	Opening Metric	Overall Length (mm) A	Width Open End (mm) B	Thickness Open End (mm) C	Width Box End (mm) D	Thickness Box End (mm) E	Weight (g)	RRP
9510DD	10 mm	94.0	21.89	0.224	0.780	0.303	73	\$15.45
9511D	11 mm	102.0	24.20	0.252	0.854	0.323	99	\$16.60
9512D	12 mm	105.0	26.60	0.291	0.906	0.339	115	\$17.70
9513D	13 mm	107.0	29.10	0.319	0.984	0.339	128	\$18.80
9514D	14 mm	114.0	31.19	0.327	1.035	0.370	158	\$19.90
9516D	16 mm	122.0	34.49	0.346	1.201	0.406	207	\$22.10
9517D	17 mm	126.0	37.89	0.362	1.272	0.421	244	\$24.35
9518D	18 mm	130.0	1.583	0.370	1.307	0.441	282	\$25.45
9519D	19 mm	138.0	1.626	0.374	1.339	0.441	316	\$27.70

9520D - 10 Pc. Stubby Combination Ratcheting Wrench Set METRIC RRP 145.35

Material No.	Description
9510	10 mm Stubby Combination Ratcheting Wrench
9511	11 mm Stubby Combination Ratcheting Wrench
9512	12 mm Stubby Combination Ratcheting Wrench
9513	13 mm Stubby Combination Ratcheting Wrench
9514	14 mm Stubby Combination Ratcheting Wrench
9515	15 mm Stubby Combination Ratcheting Wrench
9516	16 mm Stubby Combination Ratcheting Wrench
9517	17 mm Stubby Combination Ratcheting Wrench
9518	18 mm Stubby Combination Ratcheting Wrench
9519	19 mm Stubby Combination Ratcheting Wrench



9507D - 7 Pc. Stubby Combination Ratcheting Wrench Set SAE RRP \$115.90

Material No.	Description
9500	3/8" Stubby Combination Ratcheting Wrench
9501	7/16" Stubby Combination Ratcheting Wrench
9502	1/2" Stubby Combination Ratcheting Wrench
9503	9/16" Stubby Combination Ratcheting Wrench
9504	5/8" Stubby Combination Ratcheting Wrench
9505	11/16" Stubby Combination Ratcheting Wrench
9506	3/4" Stubby Combination Ratcheting Wrench



Note: Individual materials may not be available for separate purchase.

PATENTED

SETS

WRENCHES

STUBBY FLEX COMBINATION RATCHETING WRENCH SETS



9550 - 10 Pc. Stubby Flex Combination Ratcheting Wrench Set METRIC RRP \$252.90

Material No.	Description	Material No.	Description
9551	10 mm	9556	15 mm
9552	11 mm	9557	16 mm
9553	12 mm	9558	17 mm
9554	13 mm	9559	18 mm
9555	14 mm	9560	19 mm



9570 - 7 Pc. Stubby Flex Combination Ratcheting Wrench Set SAE RRP \$208.65

Material No.	Description	Material No.	Description
9571	3/8"	9575	5/8"
9572	7/16"	9576	11/16"
9573	1/2"	9577	3/4"
9574	9/16"		

INDEXING COMBINATION RATCHETING WRENCH SETS



85488 - 12 Pc. Indexing Combination Wrench Set METRIC RRP \$526.75

Material No.	Description	Material No.	Description
85418	8 mm	85444	14 mm
85439	9 mm	85445	15 mm
85440	10 mm	85446	16 mm
85441	11 mm	85447	17 mm
85442	12 mm	85448	18 mm
85443	13 mm	85449	19 mm



85498 - 8 Pc. Indexing Combination Wrench Set SAE RRP \$400.30

Material No.	Description	Material No.	Description
85450	5/16"	85458	9/16"
85452	3/8"	85460	5/8"
85454	7/16"	85462	11/16"
85456	1/2"	85464	3/4"

PATENTED

Note: Individual materials may not be available for separate purchase.

SETS

WRENCHES

HALF MOON & S-SHAPE RATCHETING WRENCH SETS

9850 - 5 Pc. Half Moon Reversible Double Box Ratcheting Wrench Set METRIC RRP \$189.60

Material No.	Description
9851	10 x 12 mm Half Moon Ratcheting Wrench
9852	11 x 13 mm Half Moon Ratcheting Wrench
9853	14 x 16 mm Half Moon Ratcheting Wrench
9854	15 x 17 mm Half Moon Ratcheting Wrench
9855	19 x 22 mm Half Moon Ratcheting Wrench



9840D - 4 Pc. Half Moon Reversible Double Box Ratcheting Wrench Set SAE RRP \$189.60

Material No.	Description
9841	3/8" x 7/16" Half Moon Ratcheting Wrench
9842	1/2" x 9/16" Half Moon Ratcheting Wrench
9843	5/8" x 11/16" Half Moon Ratcheting Wrench
9844	3/4" x 7/8" Half Moon Ratcheting Wrench



85299 - 5 Pc. S-Shape Reversible Double Box Ratcheting Wrench Set METRIC RRP \$189.60

Material No.	Description
85222	10 x 12 mm S-Shape Ratcheting Wrench
85224	11 x 13 mm S-Shape Ratcheting Wrench
85230	14 x 16 mm S-Shape Ratcheting Wrench
85232	15 x 17 mm S-Shape Ratcheting Wrench
85241	19 x 22 mm S-Shape Ratcheting Wrench



85399 - 4 Pc. S-Shape Reversible Double Box Ratcheting Wrench Set SAE RRP \$189.60

Material No.	Description
85326	3/8" x 7/16" S-Shape Ratcheting Wrench
85334	1/2" x 9/16" S-Shape Ratcheting Wrench
85342	5/8" x 11/16" S-Shape Ratcheting Wrench
85352	3/4" x 7/8" S-Shape Ratcheting Wrench



SETS
WRENCHES

PATENTED

Note: Individual materials may not be available for separate purchase.

FLARE NUT RATCHETING WRENCH SETS



89101D - 6 Pc. Ratcheting Flex Flare Nut Wrench Set METRIC RRP \$142.70

Material No.	Description
89102	9 x 11 mm Ratcheting Flex Flare Nut Wrench
89103	10 x 12 mm Ratcheting Flex Flare Nut Wrench
89104	13 x 14 mm Ratcheting Flex Flare Nut Wrench
89105	15 x 17 mm Ratcheting Flex Flare Nut Wrench
89106	16 x 18 mm Ratcheting Flex Flare Nut Wrench
89107	19 x 21 mm Ratcheting Flex Flare Nut Wrench



89100 - 5 Pc. Ratcheting Flex Flare Nut Wrench Set SAE RRP \$131.65

Material No.	Description
89109	1/4" x 5/16" Ratcheting Flex Flare Nut Wrench
89110	3/8" x 7/16" Ratcheting Flex Flare Nut Wrench
89111	1/2" x 9/16" Ratcheting Flex Flare Nut Wrench
89112	5/8" x 11/16" Ratcheting Flex Flare Nut Wrench
89113	3/4" x 7/8" Ratcheting Flex Flare Nut Wrench

CROWFOOT RATCHETING WRENCH SETS



89119 - 10 Pc. Ratcheting Crowfoot Wrench Set METRIC 3/8" DRIVE RRP \$103.95

Material No.	Description	Material No.	Description
89140	10 mm	89145	15 mm
89141	11 mm	89146	16 mm
89142	12 mm	89147	17 mm
89143	13 mm	89148	18 mm
89144	14 mm	89149	19 mm



89118 - 11 Pc. Ratcheting Crowfoot Wrench Set SAE 3/8" DRIVE RRP \$103.95

Material No.	Description	Material No.	Description
89120	3/8"	89126	3/4"
89121	7/16"	89127	13/16"
89122	1/2"	89128	7/8"
89123	9/16"	89129	15/16"
89124	5/8"	89130	1"
89125	11/16"		

PATENTED

Note: Individual materials may not be available for separate purchase.

SETS
WRENCHES

**DOUBLE BOX RATCHETING WRENCH
- OPEN STOCK & SETS**



Open Stock - Double Box Ratcheting Wrench METRIC/SAE

Material No.	Opening Metric/Inches	Overall Length (mm) A	Width Open End (mm) B	Thickness Open End (mm) C	Width Box End (mm) D	Thickness Box End (mm) E	Weight (g)	RRP
9210D	8 x 9 mm	130	16.9	6.9	17.9	6.9	50	\$25.15
9211D	10 x 11 mm	150	19.8	7.7	21.7	8.2	64	\$26.90
9212D	12 x 13 mm	170	23.0	8.6	24.5	8.6	100	\$28.20
9215D	17 x 19 mm	230	32.3	10.7	34.0	11.2	209	\$35.40
9201D	5/16" x 3/8"	130	16.6	6.9	17.9	6.9	59	\$25.60
9202D	7/16" x 1/2"	160	21.7	8.2	24.5	8.6	73	\$27.70

9260 - 6 Pc. Double Box Ratcheting Wrench Set METRIC
RRP \$121.15

Material No.	Description
9210	8 X 9 mm Double Box Ratcheting Wrench
9211	10 X 11 mm Double Box Ratcheting Wrench
9212	12 X 13 mm Double Box Ratcheting Wrench
9213	14 X 15 mm Double Box Ratcheting Wrench
9214	16 X 18 mm Double Box Ratcheting Wrench
9215	17 X 19 mm Double Box Ratcheting Wrench



9240D - 4 Pc. Double Box Ratcheting Wrench Set SAE
RRP \$121.15

Material No.	Description
9201	5/16" x 3/8" Double Box Ratcheting Wrench
9202	7/16" x 1/2" Double Box Ratcheting Wrench
9203	9/16" x 5/8" Double Box Ratcheting Wrench
9204	11/16" x 3/4" Double Box Ratcheting Wrench



SETS
WRENCHES

PATENTED

Note: Individual materials may not be available for separate purchase.

E-TORX® RATCHETING WRENCH SET



9224D - 4 Pc. E-Torx® Double Box Ratcheting Wrench Set TORX® RRP \$105.30

Material No.	Description	
9220	E6 x E8	E-Torx Ratcheting Wrench
9221	E10 x E12	E-Torx Ratcheting Wrench
9222	E14 x E18	E-Torx Ratcheting Wrench
9223	E20 x E24	E-Torx Ratcheting Wrench

QUADBOX™ RATCHETING WRENCH - OPEN STOCK

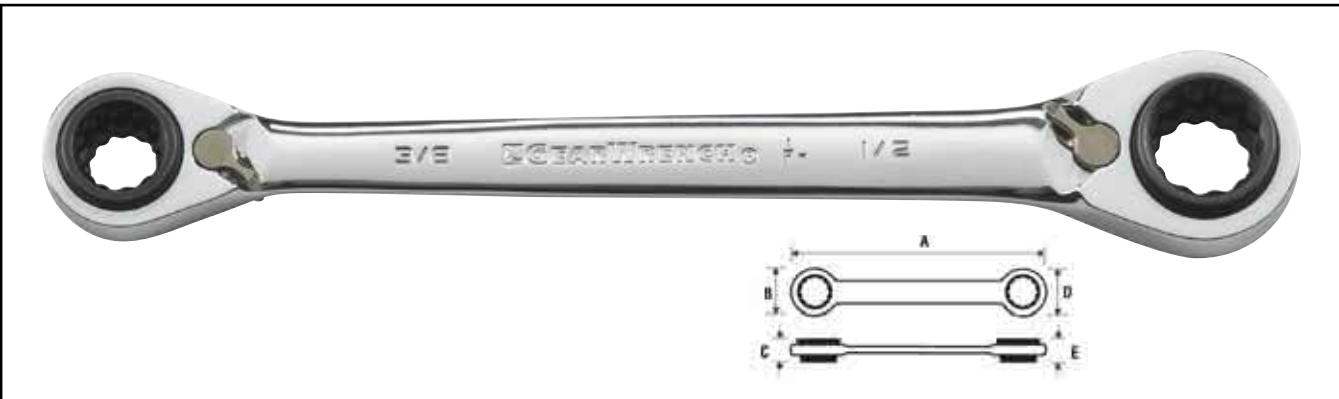

Open Stock - QuadBox™ Ratcheting Wrench METRIC/SAE

Material No.	Opening Metric/Inches	Overall Length (mm) A	Width Box End (mm) B	Thickness Box End (mm) C	Width Box End (mm) D	Thickness Box End (mm) E	Weight (g)	RRP
85211	8, 10, 12, 13 mm	160	19.8	11.9	24.9	15.0	85	\$55.30
85212	16, 17, 18, 19 mm	230	32.3	18.03	34.0	20.0	223	\$77.45
85213	9, 11, 14, 15 mm	180	21.7	12.9	28.7	16.0	114	\$66.35
85214	20, 21, 22, 24 mm	290	39.1	23.1	45.5	28.0	479	\$88.50
85201	5/16", 3/8", 7/16", 1/2"	160	19.8	11.9	24.9	15.0	84	\$55.30
85202D	9/16", 5/8", 11/16", 3/4"	210	30.5	17.0	34.0	19.1	204	\$77.45
85203	13/16", 7/8", 15/16", 1"	290	39.1	23.1	45.5	28.0	499	\$88.50



PATENTED

Note: Individual materials may not be available for separate purchase.

SETS
WRENCHES

QUADBOX™ RATCHETING WRENCH SETS

85215 - 4 Pc. QuadBox™ Double Box Ratcheting Wrench Set METRIC RRP \$260.00

Material No.	Description
85211	8, 10, 12, 13 mm QuadBox™ Ratcheting Wrench
85212	16, 17, 18, 19 mm QuadBox™ Ratcheting Wrench
85213	9, 11, 14, 15 mm QuadBox™ Ratcheting Wrench
85214	20, 21, 22, 24 mm QuadBox™ Ratcheting Wrench

Metal hinged case with EVA insert



85204 - 3 Pc. QuadBox™ Double Box Ratcheting Wrench Set SAE RRP \$199.10

Material No.	Description
85201	5/16", 3/8", 7/16", 1/2" QuadBox™ Ratcheting Wrench
85202	9/16", 5/8", 11/16", 3/4" QuadBox™ Ratcheting Wrench
85203	13/16", 7/8", 15/16", 1" QuadBox™ Ratcheting Wrench



85200 - 13 Pc. QuadBox™ Ratcheting Wrench Set SAE RRP \$69.00

Material No.	Description
85201	5/16", 3/8", 7/16", 1/2" QuadBox™ Ratcheting Wrench
85202D	9/16", 5/8", 11/16", 3/4" QuadBox™ Ratcheting Wrench

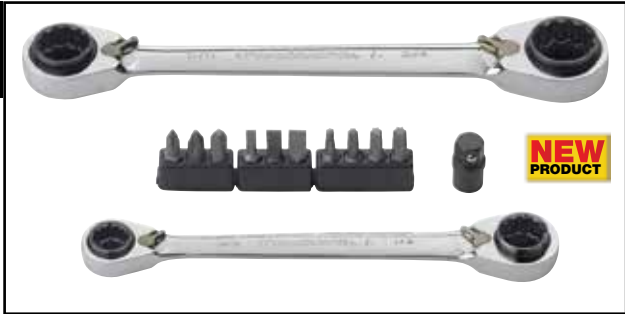

85210D - 13 Pc. QuadBox™ Double Box Ratcheting Wrench Set METRIC RRP \$69.00

Material No.	Description
85211	8, 10, 12, 13 mm QuadBox™ Ratcheting Wrench
85212	16, 17, 18, 19 mm QuadBox™ Ratcheting Wrench
1/4" Access Bit Adapter	Access Bit Adapter
#1	Phillips Bit 1/4"
#2	Phillips Bit 1/4"
#3	Phillips Bit 1/4"
5/32	Slotted Bit 1/4"
7/32	Slotted Bit 1/4"
1/4	Slotted Bit 1/4"
T-15	Torx® Bit 1/4"
T-20	Torx® Bit 1/4"
T-25	Torx® Bit 1/4"
T-27	Torx® Bit 1/4"



SETS
WRENCHES

Note: Individual materials may not be available for separate purchase.

PATENTED

XL LOCKING FLEX COMBINATION RATCHETING WRENCH - OPEN STOCK & SETS



Open Stock - XL Locking Flex Combination Ratcheting Wrench METRIC

Item No.	Opening Metric	Overall Length (mm) A	Width Open End (mm) B	Thickness Open End (mm) C	Width Box End (mm) D	Thickness Box End (mm) E	Weight (g)	RRP
85608	8 mm	146	19.6	5.08	17.02	6.86	40	\$26.80
85610	10 mm	171	21.85	5.58	19.81	7.62	68	\$26.70
85611	11 mm	183	24.13	6.35	21.59	8.13	82	\$29.20
85612	12 mm	195	26.67	7.37	23.11	8.64	100	\$28.90
85613	13 mm	207	29.21	8.13	24.89	8.64	118	\$29.60
85614	14 mm	219	31.24	8.38	26.42	9.40	145	\$31.80
85615	15 mm	231	33.78	8.38	28.70	9.91	163	\$33.40
85616	16 mm	242	34.54	8.89	30.48	10.41	200	\$35.05
85617	17 mm	254	37.85	9.14	32.26	10.67	227	\$39.85

SETS
WRENCHES



85698 - 12 Pc. XL Locking Flex Combination Ratcheting Wrench Set METRIC RRP \$379.30

Material No.	Description
85608	8 mm XL Locking Flex Combination Ratcheting Wrench
85609	9 mm XL Locking Flex Combination Ratcheting Wrench
85610	10 mm XL Locking Flex Combination Ratcheting Wrench
85611	11 mm XL Locking Flex Combination Ratcheting Wrench
85612	12 mm XL Locking Flex Combination Ratcheting Wrench
85613	13 mm XL Locking Flex Combination Ratcheting Wrench
85614	14 mm XL Locking Flex Combination Ratcheting Wrench
85615	15 mm XL Locking Flex Combination Ratcheting Wrench
85616	16 mm XL Locking Flex Combination Ratcheting Wrench
85617	17 mm XL Locking Flex Combination Ratcheting Wrench
85618	18 mm XL Locking Flex Combination Ratcheting Wrench
85619	19 mm XL Locking Flex Combination Ratcheting Wrench

PATENTED

Note: Individual materials may not be available for separate purchase.

XL LOCKING FLEX COMBINATION RATCHETING WRENCH SETS

85798 - 8 Pc. XL Locking Flex Combination Ratcheting Wrench Set SAE RRP \$295.00

Material No.	Description
85710	5/16" XL Locking Flex Combination Ratcheting Wrench
85712	3/8" XL Locking Flex Combination Ratcheting Wrench
85714	7/16" XL Locking Flex Combination Ratcheting Wrench
85716	1/2" XL Locking Flex Combination Ratcheting Wrench
85718	9/16" XL Locking Flex Combination Ratcheting Wrench
85720	5/8" XL Locking Flex Combination Ratcheting Wrench
85722	11/16" XL Locking Flex Combination Ratcheting Wrench
85724	3/4" XL Locking Flex Combination Ratcheting Wrench



85698R - 12 Pc. XL Locking Flex Combination Ratcheting Wrench Set Roll METRIC RRP \$379.30

Material No.	Description
85608	8 mm XL Locking Flex Combination Ratcheting Wrench
85609	9 mm XL Locking Flex Combination Ratcheting Wrench
85610	10 mm XL Locking Flex Combination Ratcheting Wrench
85611	11 mm XL Locking Flex Combination Ratcheting Wrench
85612	12 mm XL Locking Flex Combination Ratcheting Wrench
85613	13 mm XL Locking Flex Combination Ratcheting Wrench
85614	14 mm XL Locking Flex Combination Ratcheting Wrench
85615	15 mm XL Locking Flex Combination Ratcheting Wrench
85616	16 mm XL Locking Flex Combination Ratcheting Wrench
85617	17 mm XL Locking Flex Combination Ratcheting Wrench
85618	18 mm XL Locking Flex Combination Ratcheting Wrench
85619	19 mm XL Locking Flex Combination Ratcheting Wrench



85798R - 8 Pc. XL Locking Flex Combination Ratcheting Wrench Set Roll SAE RRP \$295.00

Material No.	Description
85710	5/16" XL Locking Flex Combination Ratcheting Wrench
85712	3/8" XL Locking Flex Combination Ratcheting Wrench
85714	7/16" XL Locking Flex Combination Ratcheting Wrench
85716	1/2" XL Locking Flex Combination Ratcheting Wrench
85718	9/16" XL Locking Flex Combination Ratcheting Wrench
85720	5/8" XL Locking Flex Combination Ratcheting Wrench
85722	11/16" XL Locking Flex Combination Ratcheting Wrench
85724	3/4" XL Locking Flex Combination Ratcheting Wrench



SETS
WRENCHES

PATENTED

Note: Individual materials may not be available for separate purchase.

**XL GEARBOX™ RATCHETING WRENCH
- OPEN STOCK**



Open Stock - XL GearBox™ Double Box Ratcheting Wrench METRIC

Item No.	Opening Metric	Overall Length (mm) A	Width Box End (mm) B	Thickness Box End (mm) C	Width Box End (mm) D	Thickness Box End (mm) E	Weight (g)	RRP
85908	8 mm	221	17.02	6.86	11.69	6.09	54.8	\$27.70
85910	10 mm	241	19.81	7.62	14.48	6.86	75.8	\$29.90
85911	11 mm	251	21.59	8.13	15.75	7.87	88.9	\$30.40
85912	12 mm	267	23.11	8.64	17.28	8.38	117.9	\$27.70
85913	13 mm	287	24.89	8.64	18.79	8.89	149.7	\$31.50
85914	14 mm	305	26.42	9.40	20.32	9.91	171.5	\$29.90
85915	15 mm	323	28.7	9.91	21.85	10.92	209.6	\$31.35
85916	16 mm	348	30.48	10.41	22.86	10.92	225.4	\$32.10
85917	17 mm	374	32.26	10.67	23.88	10.92	302.6	\$35.10
85918	18 mm	384	33.28	11.17	24.89	11.43	313.4	\$36.80
85919	19 mm	396	34.03	11.17	26.42	11.94	348.9	\$38.75
85922	22 mm	432	39.12	12.96	30.99	14.48	489.9	\$42.05

OPEN STOCK
WRENCHES

XL GEARBOX™ RATCHETING WRENCH SETS

85987 - 5 Pc. XL GearBox™ Double Box Ratcheting Wrench Add-On Set METRIC
RRP \$208.65

Material No.	Description
85920	20 mm XL GearBox™ Ratcheting Wrench
85921	21 mm XL GearBox™ Ratcheting Wrench
85922	22 mm XL GearBox™ Ratcheting Wrench
85924	24 mm XL GearBox™ Ratcheting Wrench
85925	25 mm XL GearBox™ Ratcheting Wrench



ADD-ON SET (Complement to 85988)

85988 - 12 Pc. XL GearBox™ Double Box Ratcheting Wrench Set METRIC
RRP \$379.30

Material No.	Description	Material No.	Description
85908	8 mm	85914	14 mm
85909	9 mm	85915	15 mm
85910	10 mm	85916	16 mm
85911	11 mm	85917	17 mm
85912	12 mm	85918	18 mm
85913	13 mm	85919	19 mm



85998 - 9 Pc. XL GearBox™ Double Box Ratcheting Wrench Set SAE
RRP \$273.85

Material No.	Description	Material No.	Description
85950	5/16"	85958	9/16"
85951	11/32"	85960	5/8"
85952	3/8"	85962	11/16"
85954	7/16	85964	3/4"
85956	1/2"		



86126 - 10 Pc. 120XP™ Universal Spline XL Flex GearBox Ratcheting Wrench Set METRIC
RRP \$382.70

Material No.	Description	Material No.	Description
86110	10 mm	86115	15 mm
86111	11 mm	86116	16 mm
86112	12 mm	86117	17 mm
86113	13 mm	86118	18 mm
86114	14 mm	86119	19 mm



**SETS
WRENCHES**

Note: Individual materials may not be available for separate purchase.

PATENTED



86142 - 10 Pc. 120XP™ Universal Spline XL Flex GearBox Ratcheting Wrench Set SAE RRP \$382.70

Material No.	Description	Material No.	Description
86128	1/4"	86134	9/16"
86129	5/16"	86135	5/8"
86130	11/32"	86136	11/16"
86131	3/8"	86137	3/4"
86132	7/16"		
86133	1/2"		

XL X-BEAM™ COMBINATION RATCHETING WRENCH SETS



85888 - 12 Pc. XL X-Beam™ Combination Ratcheting Wrench Set METRIC RRP \$208.65

Material No.	Description
85808	8 mm
85809	9 mm
85810	10 mm
85811	11 mm
85812	12 mm
85813	13 mm
85814	14 mm
85815	15 mm
85816	16 mm
85817	17 mm
85818	18 mm
85819	19 mm



85898 - 9 Pc. XL X-Beam™ Combination Ratcheting Wrench Set SAE RRP \$187.50

Material No.	Description
85850	5/16"
85851	11/32"
85852	3/8"
85854	7/16"
85856	1/2"
85858	9/16"
85860	5/8"
85862	11/16"
85864	3/4"

PATENTED

Note: Individual materials may not be available for separate purchase.

SETS
WRENCHES

**NON-RATCHETING
WRENCHES**

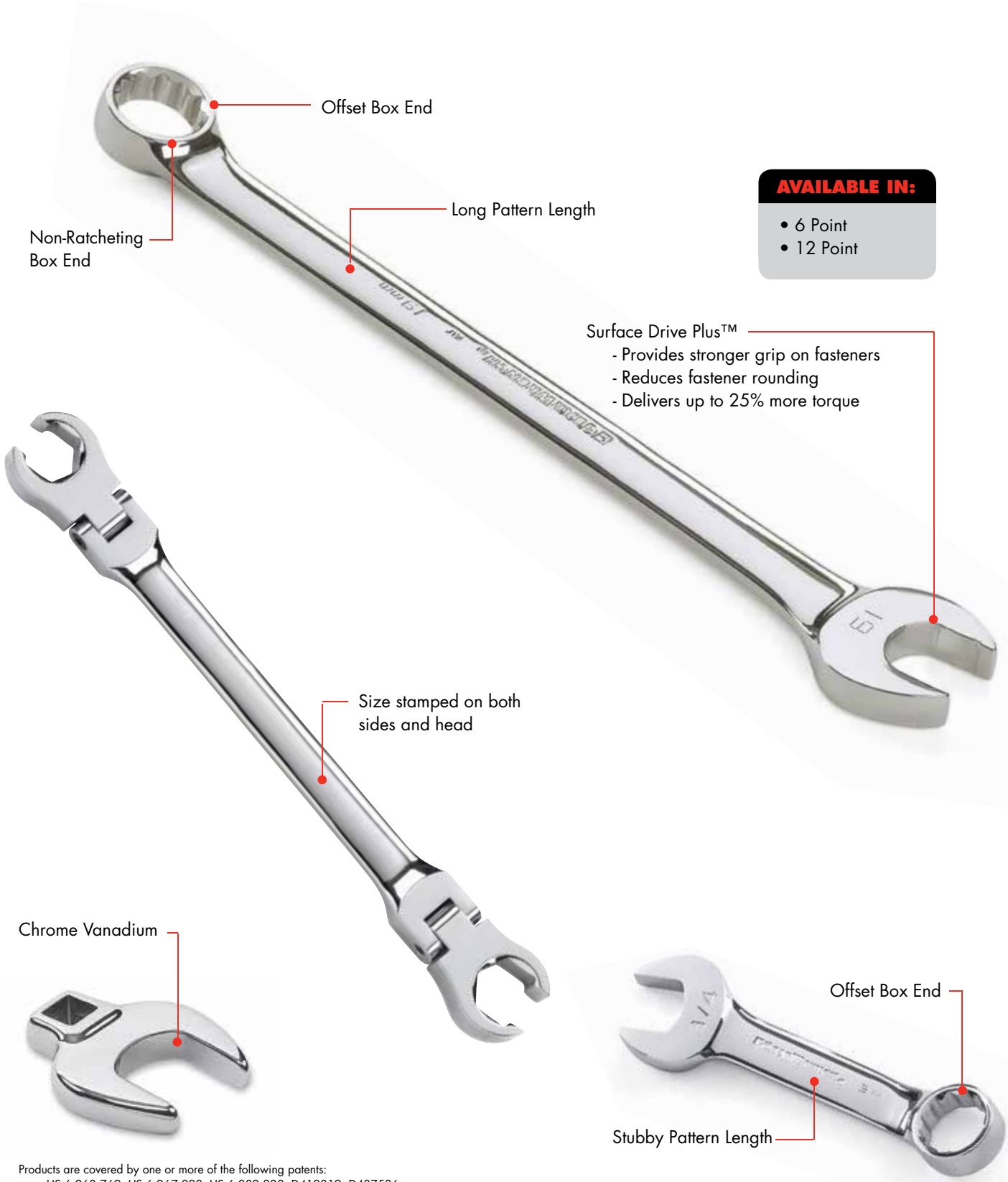

Offset Box End

Non-Ratcheting
Box End

Long Pattern Length

AVAILABLE IN:

- 6 Point
- 12 Point

Surface Drive Plus™

- Provides stronger grip on fasteners
- Reduces fastener rounding
- Delivers up to 25% more torque

Size stamped on both
sides and head

Chrome Vanadium

Offset Box End

Stubby Pattern Length

WRENCHES

Products are covered by one or more of the following patents:
 • US 6,263,769 US 6,267,028 US 6,082,228 D412819 D437536

LONG PATTERN COMBINATION NON-RATCHETING WRENCHES - OPEN STOCK



Open Stock - Long Pattern Combination Non-Ratcheting Wrenches METRIC

Material No.	Opening Metric/Inches	Overall Length (mm) A	Width Open End (mm) B	Thickness Open End (mm) C	Width Box End (mm) D	Thickness Box End (mm) E	Weight (g)	RRP
81736	6 mm	129	13.2	4.1	11.4	5.0	30	\$10.65
81737	7 mm	138	14.4	4.3	12.3	5.3	35	\$12.55
81665	8 mm	147	16.6	4.5	13.6	5.5	29	\$12.85
81666	9 mm	158	18.5	4.7	14.8	6.2	41	\$12.95
81667	10 mm	166	20.5	5.4	16.1	6.9	56	\$14.05
81668	11 mm	185	22.7	6.0	17.4	7.5	64	\$14.75
81669	12 mm	197	24.6	6.2	18.5	8.3	80	\$15.15
81670	13 mm	206	26.7	6.4	19.8	8.5	84	\$15.75
81671	14 mm	222	28.9	7.0	21.5	9.3	107	\$16.05
81672	15 mm	232	30.8	7.4	22.6	9.9	130	\$16.35
81673	16 mm	242	32.8	7.7	23.9	10.5	154	\$16.95
81674	17 mm	260	35.1	8.1	25.8	11.0	188	\$17.95
81675	18 mm	269	37.1	8.6	26.6	11.5	194	\$19.45
81676	19 mm	279	39.3	9.1	27.4	12.0	250	\$22.10
81677	20 mm	290	41.9	9.7	28.2	12.5	281	\$24.70
81678	21 mm	301	43.2	10.1	28.9	12.9	310	\$25.60
81679	22 mm	318	45.3	10.3	32.1	13.7	321	\$26.30
81741	23 mm	324	47.5	10.6	32.7	14.2	409	\$27.80
81742	24 mm	337	49.4	10.9	33.7	14.7	469	\$30.50
81751	25 mm	357	51.4	11.3	35.5	15.2	942	\$33.75
81752	26 mm	364	54.3	11.4	37.4	15.8	1311	\$35.85
81743	27 mm	375	56.0	11.9	38.9	16.5	1152	\$42.05
81753	28 mm	406	62.7	12.7	42.8	17.7	1329	\$46.35
81744	30 mm	432	64.9	13.3	42.8	18.3	1381	\$48.45
81745D	32 mm	441	66.9	13.3	46.0	18.3	1382	\$52.40

OPEN STOCK
WRENCHES

LONG PATTERN COMBINATION NON-RATCHETING WRENCHES - OPEN STOCK & SETS



Open Stock - Long Pattern Combination Non-Ratcheting Wrenches SAE

Item No.	Opening Inches	Overall Length (mm) A	Width Open End (mm) B	Thickness Open End (mm) C	Width Box End (mm) D	Thickness Box End (mm) E	Weight (g)	RRP
81650	1/4"	129	13.2	4.1	11.4	5.0	21	\$12.35
81651D	9/32"	138	14.4	4.3	12.3	5.3	28	\$12.55
81652D	5/16"	147	16.6	4.5	13.6	5.5	32	\$12.75
81653	11/32"	158	18.5	4.7	14.8	6.2	42	\$13.05
81654	3/8"	166	20.5	5.4	16.1	6.9	55	\$13.35
81655	7/16"	185	22.7	6.0	17.4	7.5	65	\$13.65
81656	1/2"	206	26.7	6.4	19.8	8.5	89	\$15.25
81657	9/16"	222	28.9	7.0	21.5	9.3	124	\$15.75
81658	5/8"	242	30.8	7.7	23.9	10.5	149	\$17.05
81659	11/16"	260	35	8.0	25.8	11.0	185	\$18.80
81660	3/4"	279	39	9.2	27.9	12.1	240	\$22.10
81661	13/16"	300	43	9.9	30.5	13.2	288	\$25.70
81662	7/8"	318	45	10.3	32.1	13.7	320	\$26.80
81663	15/16"	337	49	10.9	33.71	14.7	408	\$31.10
81664	1"	356	52	11.3	35.5	15.2	443	\$32.30
81733	1-1/16"	375	57	11.9	38.9	16.5	679	\$42.05
81734	1-1/8"	406	63	12.7	42.8	17.7	838	\$46.15
81735	1-1/4"	406	66	13.3	46.0	18.4	968	\$52.90
81749	1-5/16"	400	79	15.5	55.5	23.5	933	\$57.75
81750	1-1/2"	501	79	15.5	55.5	23.5	935	\$70.05

81902 - 15 Pc. Long Pattern Combination Non-Ratcheting Wrench Set METRIC RRP \$142.70

Material No.	Description
81665	8 mm Long Pattern Combination Wrench
81666	9 mm Long Pattern Combination Wrench
81667	10 mm Long Pattern Combination Wrench
81668	11 mm Long Pattern Combination Wrench
81669	12 mm Long Pattern Combination Wrench
81670	13 mm Long Pattern Combination Wrench
81671	14 mm Long Pattern Combination Wrench
81672	15 mm Long Pattern Combination Wrench
81673	16 mm Long Pattern Combination Wrench
81674	17 mm Long Pattern Combination Wrench
81675	18 mm Long Pattern Combination Wrench
81676	19 mm Long Pattern Combination Wrench
81677	20 mm Long Pattern Combination Wrench
81678	21 mm Long Pattern Combination Wrench
81679	22 mm Long Pattern Combination Wrench



Note: Individual materials may not be available for separate purchase.

OPEN STOCK
WRENCHES

LONG PATTERN COMBINATION NON-RATCHETING WRENCH SETS



81901 - 15 Pc. Long Pattern Combination Non-Ratcheting Wrench Set SAE RRP \$142.70

Material No.	Description
81652	5/16" Long Pattern Combination Wrench
81653	11/32" Long Pattern Combination Wrench
81654	3/8" Long Pattern Combination Wrench
81655	7/16" Long Pattern Combination Wrench
81656	1/2" Long Pattern Combination Wrench
81657	9/16" Long Pattern Combination Wrench
81658	5/8" Long Pattern Combination Wrench
81659	11/16" Long Pattern Combination Wrench
81660	3/4" Long Pattern Combination Wrench
81661	13/16" Long Pattern Combination Wrench
81662	7/8" Long Pattern Combination Wrench
81663	15/16" Long Pattern Combination Wrench
81664	1" Long Pattern Combination Wrench
81650	1/4" Long Pattern Combination Wrench
81651	9/32" Long Pattern Combination Wrench



81920 - 18 Pc. Long Pattern Combination Non-Ratcheting Wrench Set METRIC RRP \$186.95

Material No.	Description
81737	7 mm Long Pattern Combination Wrench
81665	8 mm Long Pattern Combination Wrench
81666	9 mm Long Pattern Combination Wrench
81667	10 mm Long Pattern Combination Wrench
81668	11 mm Long Pattern Combination Wrench
81669	12 mm Long Pattern Combination Wrench
81670	13 mm Long Pattern Combination Wrench
81671	14 mm Long Pattern Combination Wrench
81672	15 mm Long Pattern Combination Wrench
81673	16 mm Long Pattern Combination Wrench
81674	17 mm Long Pattern Combination Wrench
81675	18 mm Long Pattern Combination Wrench
81676	19 mm Long Pattern Combination Wrench
81677	20 mm Long Pattern Combination Wrench
81678	21 mm Long Pattern Combination Wrench
81679	22 mm Long Pattern Combination Wrench
81741	23 mm Long Pattern Combination Wrench
81742	24 mm Long Pattern Combination Wrench

Note: Individual materials may not be available for separate purchase.

SETS
WRENCHES

LONG PATTERN COMBINATION NON-RATCHETING WRENCH SETS

81917 - 18 Pc. Long Pattern Combination Non-Ratcheting Wrench Set SAE RRP \$186.95

Material No.	Description	
81650	1/4"	Long Pattern Combination Wrench
81651	9/32"	Long Pattern Combination Wrench
81652	5/16"	Long Pattern Combination Wrench
81653	11/32"	Long Pattern Combination Wrench
81654	3/8"	Long Pattern Combination Wrench
81655	7/16"	Long Pattern Combination Wrench
81656	1/2"	Long Pattern Combination Wrench
81657	9/16"	Long Pattern Combination Wrench
81658	5/8"	Long Pattern Combination Wrench
81659	11/16"	Long Pattern Combination Wrench
81660	3/4"	Long Pattern Combination Wrench
81661	13/16"	Long Pattern Combination Wrench
81662	7/8"	Long Pattern Combination Wrench
81663	15/16"	Long Pattern Combination Wrench
81664	1"	Long Pattern Combination Wrench
81733	1-1/6"	Long Pattern Combination Wrench
81734	1-1/8"	Long Pattern Combination Wrench
81735	1-1/4"	Long Pattern Combination Wrench



81900 - 24 Pc. Long Pattern Combination Non-Ratcheting Wrench Set SAE/METRIC RRP \$220.15

Material No.	Description	
81665	8 mm	Long Pattern Combination Wrench
81666	9 mm	Long Pattern Combination Wrench
81667	10 mm	Long Pattern Combination Wrench
81668	11 mm	Long Pattern Combination Wrench
81669	12 mm	Long Pattern Combination Wrench
81670	13 mm	Long Pattern Combination Wrench
81671	14 mm	Long Pattern Combination Wrench
81672	15 mm	Long Pattern Combination Wrench
81673	16 mm	Long Pattern Combination Wrench
81674	17 mm	Long Pattern Combination Wrench
81675	18 mm	Long Pattern Combination Wrench
81676	19 mm	Long Pattern Combination Wrench
81677	20 mm	Long Pattern Combination Wrench
81678	21 mm	Long Pattern Combination Wrench
81679	22 mm	Long Pattern Combination Wrench



Material No.	Description	
81656	1/2"	Long Pattern Combination Wrench
81657	9/16"	Long Pattern Combination Wrench
81658	5/8"	Long Pattern Combination Wrench
81659	11/16"	Long Pattern Combination Wrench
81660	3/4"	Long Pattern Combination Wrench
81661	13/16"	Long Pattern Combination Wrench
81662	7/8"	Long Pattern Combination Wrench
81663	15/16"	Long Pattern Combination Wrench
81664	1"	Long Pattern Combination Wrench

Note: Individual materials may not be available for separate purchase.

SETS
WRENCHES

FULL POLISH COMBINATION NON-RATCHETING WRENCH SETS



81925 - 14 Pc. Full Polish Combination Non-Ratcheting Wrench Set METRIC RRP \$109.50

Material No.	Description	Material No.	Description
81754	6 mm	81761	13 mm
81755	7 mm	81762	14 mm
81756	8 mm	81763	15 mm
81757	9 mm	81764	16 mm
81758	10 mm	81765	17 mm
81759	11 mm	81766	18 mm
81760	12 mm	81767	19 mm



81924 - 14 Pc. Full Polish Combination Non-Ratcheting Wrench Set SAE RRP \$109.50

Material No.	Description	Material No.	Description
81768	1/4"	81775	5/8"
81769	5/16"	81776	11/16"
81770	11/32"	81777	3/4"
81771	3/8"	81778	13/16"
81772	7/16"	81779	7/8"
81773	1/2"	81780	15/16"
81774	9/16"	81781	1"



81931 - 24 Pc. Full Polish Combination Wrench Set METRIC/SAE RRP \$209.00

Material No.	Description	Material No.	Description
81756	8 mm	81768	1/4"
81758	10 mm	81769	5/16"
81759	11 mm	81771	3/8"
81760	12 mm	81772	7/16"
81761	13 mm	81773	1/2"
81762	14 mm	81774	9/16"
81763	15 mm	81775	5/8"
81764	16 mm	81776	11/16"
81765	17 mm	81777	3/4"
81766	18 mm	81778	13/16"
81767	19 mm	81779	7/8"
81728	22 mm	81780	15/16"

Note: Individual materials may not be available for separate purchase.

SETS

WRENCHES

30 DEGREE DEEP OFFSET NON-RATCHETING WRENCH - OPEN STOCK & SETS



Open Stock - 30 Degree Deep Offset Box Non-Ratcheting Wrenches METRIC

Material No.	Opening Metric/Inches	Overall Length (mm) A	Width Open End (mm) B	Width Open End (mm) D	Weight (g)	RRP
81782	8 x 10 mm	185	14.2	16.3	84	\$16.85
81783	10 x 12 mm	195	16.3	18.4	204	\$18.95
81784	11 x 13 mm	205	18.4	20.8	499	\$18.95
81785	12 x 14 mm	220	19.7	21.8	857	\$23.20
81786	17 x 19 mm	250	26.6	27.8		\$29.50

81927 - 5 Pc. 30 Degree Deep Offset Box Non-Ratcheting Wrench Set METRIC RRP \$94.80

Material No.	Description
81782	8 x 10 mm 30 Degree Deep Offset Box Wrench
81783	10 x 12 mm 30 Degree Deep Offset Box Wrench
81784	11 X 13 mm 30 Degree Deep Offset Box Wrench
81785	12 x 14 mm 30 Degree Deep Offset Box Wrench
81786	17 x 19 mm 30 Degree Deep Offset Box Wrench



81928 - 6 Pc. Full Polish Open End Non-Ratcheting Wrench Set METRIC RRP \$94.80

Material No.	Description
81792	6 x 7 mm Full Polish Open End Wrench
81793	8 x 10 mm Full Polish Open End Wrench
81794	10 x 12 mm Full Polish Open End Wrench
81795	11 x 13 mm Full Polish Open End Wrench
81796	12 x 14 mm Full Polish Open End Wrench
81797	17 x 19 mm Full Polish Open End Wrench



81929 - 7 Pc. Full Polish Open End Non-Ratcheting Wrench Set SAE RRP \$105.30

Material No.	Description
81798	1/4 X 5/16" Full Polish Open End Wrench
81799	3/8" x 7/16" Full Polish Open End Wrench
81801	1/2 X 9/16" Full Polish Open End Wrench
81802	5/8 X 11/16" Full Polish Open End Wrench
81803	13/16 X 3/4" Full Polish Open End Wrench
81804	15/16" x 1" Full Polish Open End Wrench
81805	1-1/8 X 1-1/4" Full Polish Open End Wrench



SETS
WRENCHES

**STUBBY COMBINATION
NON-RATCHETING WRENCH SETS**



**81904 - 10 Pc. Stubby Combination
Non-Ratcheting Wrench Set METRIC** RRP \$94.80

Material No.	Description
81634	10 mm Stubby Combination Wrench
81635	11 mm Stubby Combination Wrench
81636	12 mm Stubby Combination Wrench
81637	13 mm Stubby Combination Wrench
81638	14 mm Stubby Combination Wrench
81639	15 mm Stubby Combination Wrench
81640	16 mm Stubby Combination Wrench
81641	17 mm Stubby Combination Wrench
81642	18 mm Stubby Combination Wrench
81643	19 mm Stubby Combination Wrench



**81905 - 10 Pc. Stubby Combination
Non-Ratcheting Wrench Set SAE** RRP \$94.80

Material No.	Description
81624	3/8" Stubby Combination Wrench
81625	7/16" Stubby Combination Wrench
81626	1/2" Stubby Combination Wrench
81627	9/16" Stubby Combination Wrench
81628	5/8" Stubby Combination Wrench
81629	11/16" Stubby Combination Wrench
81630	3/4" Stubby Combination Wrench
81631	13/16" Stubby Combination Wrench
81632	7/8" Stubby Combination Wrench
81633	15/16" Stubby Combination Wrench



**81911D - 6 Pc. Flex Flare Nut
Non-Ratcheting Wrench Set METRIC** RRP \$90.40

Material No.	Description
81686	9 x 11 mm Flex Flare Nut Wrench
81687	10 x 12 mm Flex Flare Nut Wrench
81688	13 x 14 mm Flex Flare Nut Wrench
81689	15 x 17 mm Flex Flare Nut Wrench
81690	16 x 18 mm Flex Flare Nut Wrench
81692	19 x 21 mm Flex Flare Nut Wrench



**81910 - 5 Pc. Flex Flare Nut
Non-Ratcheting Wrench Set SAE** RRP \$94.80

Material No.	Description
81693	1/4" x 5/16" Flex Flare Nut Wrench
81694	3/8 x 7/16" Flex Flare Nut Wrench
81695	1/2" x 9/16" Flex Flare Nut Wrench
81696	5/8" x 11/16" Flex Flare Nut Wrench
81697	3/4" x 7/8" Flex Flare Nut Wrench

Note: Individual materials may not be available for separate purchase.

SETS
WRENCHES

CROWFOOT DRIVE NON-RATCHETING WRENCH SETS

81909 - 10 Pc. 3/8" Drive Crowfoot Drive Non-Ratcheting Wrench Set METRIC RRP \$87.40

Material No.	Description
81614	10 mm Crowfoot Drive Wrench
81615	11 mm Crowfoot Drive Wrench
81616	12 mm Crowfoot Drive Wrench
81617	13 mm Crowfoot Drive Wrench
81618	14 mm Crowfoot Drive Wrench
81619	15 mm Crowfoot Drive Wrench
81620	16 mm Crowfoot Drive Wrench
81621	17 mm Crowfoot Drive Wrench
81622	18 mm Crowfoot Drive Wrench
81623	19 mm Crowfoot Drive Wrench



81908 - 11 Pc. 3/8" Drive Crowfoot Drive Non-Ratcheting Wrench Set SAE RRP \$94.05

Material No.	Description
81603	3/8" Crowfoot Drive Wrench
81604	7/16" Crowfoot Drive Wrench
81605	1/2" Crowfoot Drive Wrench
81606	9/16" Crowfoot Drive Wrench
81607	5/8" Crowfoot Drive Wrench
81608	11/16" Crowfoot Drive Wrench
81609	3/4" Crowfoot Drive Wrench
81610	13/16" Crowfoot Drive Wrench
81611	7/8" Crowfoot Drive Wrench
81612	15/16" Crowfoot Drive Wrench
81613	1" Crowfoot Drive Wrench



SETS
WRENCHES

Note: Individual materials may not be available for separate purchase.

TORQUE WRENCHES

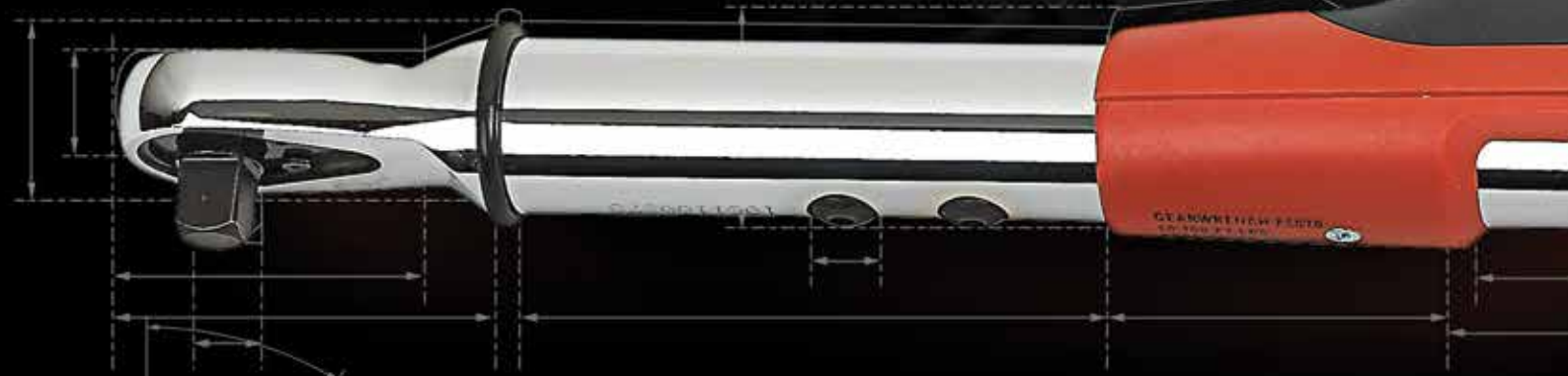

Torque Wrenches

Electronic Torque Wrenches
Micrometer Torque Wrenches

ELECTRONIC TORQUE WRENCHES WITH ANGLE



Sealed design guards against dirt infiltration

Backlit LCD Screen makes reading torque and angle values quick and easy



Digitally tracks torque and angle measurements. Buzzer with Red, Yellow and Green lights alerts you when targets are reached. (Models 85073, 85074)

Shock-resistant housing provides durability



Thin-profile, high-strength teardrop head flexes for easier access and features a 60-tooth gear with 6° ratcheting arc

Torque Accuracy: +/- 2% CW, +/- 3% CCW from 20% to 100% full scale.
Angle Accuracy: +/- 1% of reading

Knurled Aluminum Grip resists slipping

MICROMETER TORQUE WRENCHES



One-finger-operated reversible lever

Pliable, elastomer handle grip for superior comfort and oil resistance

Sealed tear-drop head provides access and strength and keeps out contaminants

Accurate in clockwise direction +/- 3% in upper 80% of the range

Micrometer twist lock ring provides secure locking mechanism

TORQUE WRENCHES

All torque wrenches have a dual scale American standard (ft/lbs) and metric (Newton meters).



Electronic Flex Head Torque Wrench with Angle

Material No.	Drive Size	Length	Torque Range	Weight (kg)	RRP
85073	3/8"	17.75in/ 450.85mm	13.6-135.6 Nm/ 10 - 100 ft/lbs	0.95	\$939.15
85074	1/2"	26.5in/ 67.1mm	33.9-339 Nm/ 25 - 250 ft/lbs	1.6	\$961.25

Calibration Certificate provided.



Electronic Torque Wrench - Not Angled

Material No.	Drive Size	Length	Torque Range	Weight (kg)	RRP
85070	3/8"	17.75in/ 450.85mm	13.6-135.6 Nm/ 10 - 100 ft/lbs	1.5	\$379.30
85071	1/2"	26.5in/ 67.1mm	33.9-339 Nm/ 25 - 250 ft/lbs	2.2	\$410.85

Calibration Certificate provided.



85050 - Micrometer Torque Wrench 1/4" Drive

RRP \$179.10

Length	Torque Range	Weight (kg)
9.5in/ 241.3mm	3.96-23.16 Nm/ 30 - 200 inch/lbs	0.61

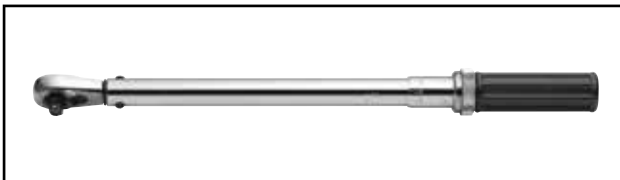

85051 - Micrometer Torque Wrench 3/8" Drive

RRP \$179.10

Length	Torque Range	Weight (kg)
9.5in/ 241.3mm	3.6-29 Nm/ 25 - 250 inch/lbs	1.1



85062 - Micrometer Torque Wrench 3/8" Drive

RRP \$170.80

Length	Torque Range	Weight (kg)
18in/ 457.2mm	20.3-142.4 Nm 10 - 100 ft/lbs	1.7

85053 - Micrometer Torque Wrench 1/2" Drive

RRP \$189.60

Length	Torque Range	Weight (kg)
20.5in/ 509.27mm	20.3-210.1 Nm/ 20 - 150 ft/lbs	1.9



85066 - Micrometer Torque Wrench 1/2" Drive

RRP \$190.95

Length	Torque Range	Weight (kg)
24.25in/ 615.95mm	54.2-352.6 Nm/ 30 - 250 ft/lbs	4.9



85055 - Micrometer Torque Wrench 3/4" Drive

RRP \$737.45

Length	Torque Range	Weight (kg)
40.5in/ 1028.10mm	153-830 Nm/ 100 - 600 ft/lbs	7.3

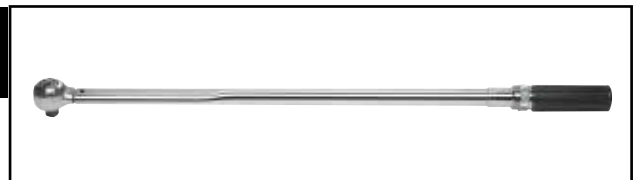

SCREWDRIVERS & NUTDRIVERS

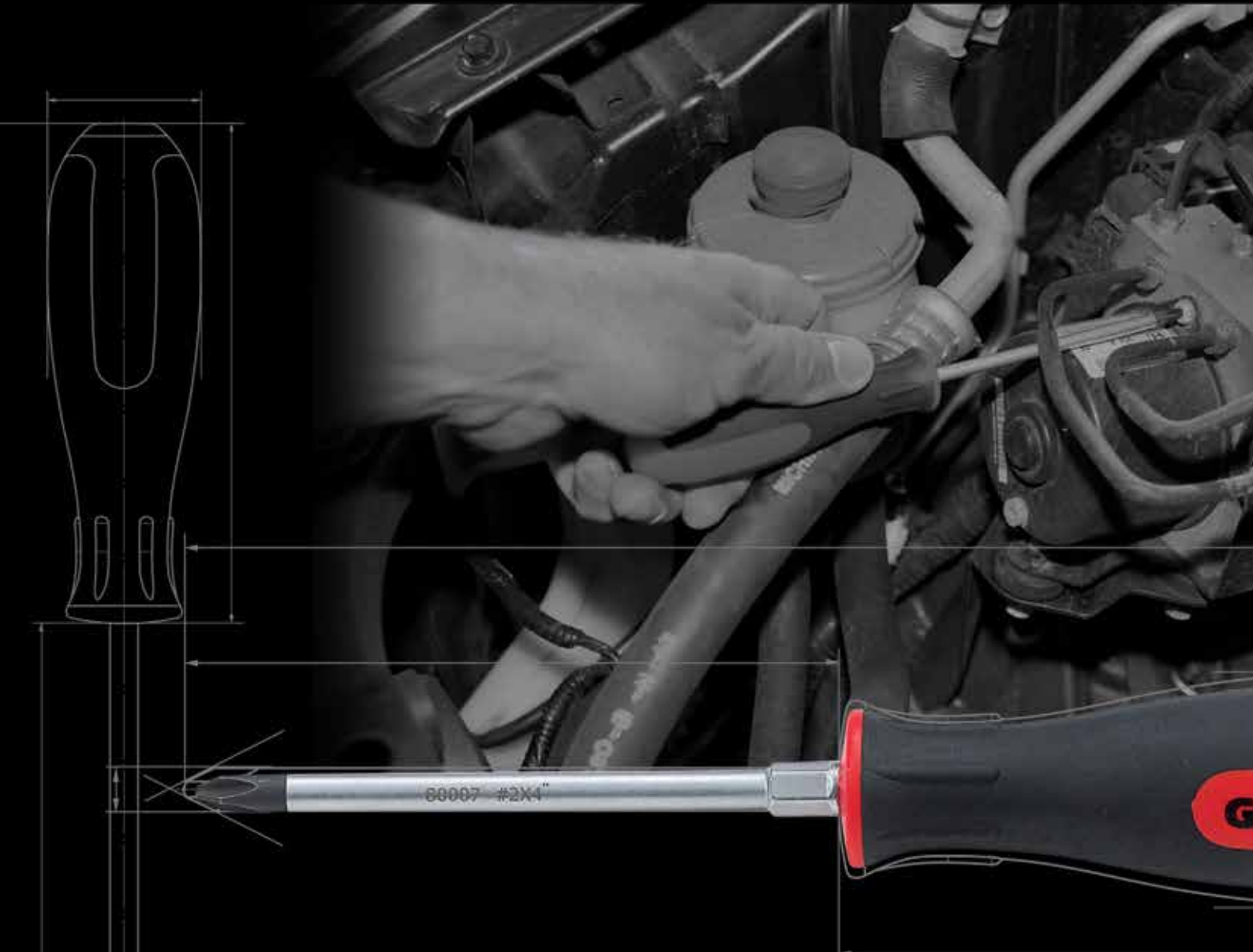

Screwdrivers & Nutdrivers

Dual Material Screwdrivers
Cushion Grip Screwdrivers
Nutdrivers
Ratcheting Nutdrivers

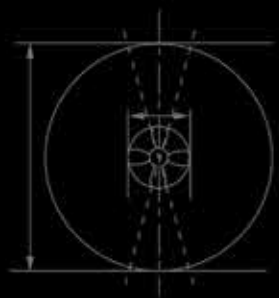

**DUAL MATERIAL
SCREWDRIVERS**



AVAILABLE IN:

- Phillips
- Slotted
- Torx®
- Pozidrive®

**MINI
SCREWDRIVERS**



AVAILABLE IN:

- Phillips
- Slotted
- Torx®



**RATCHETING
SCREWDRIVERS**

AVAILABLE IN:

- Standard
- T-Handle
- Stubby

Products are covered by one or more of the following patents:
 • US 7,137,320

SCREWDRIVER SETS



80050 - 6 Pc. Combination Dual Material Screwdriver Set

RRP \$37.95

Material No.	Description
80015	1/8" x 3" Slotted Screwdriver
80013	1/4" x 4" Slotted Screwdriver
80023	5/16" x 6" Slotted Screwdriver
80022	3/8" x 8" Slotted Screwdriver
80001	#1 x 3" Phillips Screwdriver
80007	#2 x 4" Phillips Screwdriver



80060 - 10 Pc. Combination and Pozidriv® Dual Material Screwdriver Set

RRP \$52.65

Material No.	Description
80043	#0 x 2-1/2" Pozidriv® Screwdriver
80044	#1 x 3" Pozidriv® Screwdriver
80045	#2 x 4" Pozidriv® Screwdriver
80046	#3 x 6" Pozidriv® Screwdriver
80015	1/8" x 3" Slotted Screwdriver
80017	3/16" x 4" Slotted Screwdriver
80013	1/4" x 4" Slotted Screwdriver
80023	5/16" x 6" Slotted Screwdriver
80001	#1 x 3" Phillips Screwdriver
80007	#2 x 4" Phillips Screwdriver



80064 - 3 Pc. Long Torx® Dual Material Screwdriver Set

RRP \$39.85

Material No.	Description
80088	T-25 x 18"
80087	T-20 x 18"
80086	T-15 x 18"

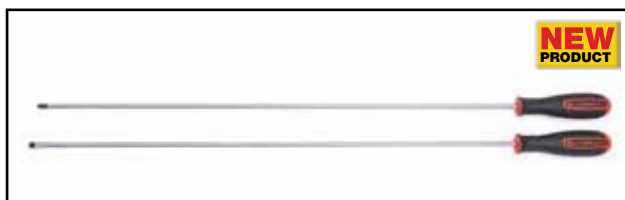

80068 - 2 Pc. Extra Long Combination Dual Material Screwdriver Set - 24" Blades

RRP \$33.00

Material No.	Description
80076	Dual Material Slotted Screwdriver 1/4" x 24"
80008	Dual Material Phillips® Screwdriver #2 x 24"

Note: Individual materials may not be available for separate purchase.

SCREWDRIVER SETS

80065 - 4 Pc. Square Dual Material Screwdriver Set RRP \$31.00

Material No.	Description
80092	#3 x 5"
80091	#2 x 4"
80090	#1 x 4"
80089	#0 x 4"



80066 - 20 Pc. Master Dual Material Screwdriver Set RRP \$94.80

Material No.	Description
80012	1/4" x 1-1/2" Slotted Screwdriver
80018	3/16" x 6" Slotted Screwdriver
80013	1/4" x 4" Slotted Screwdriver
80014	1/4" x 6" Slotted Screwdriver
80023	5/16" x 6" Slotted Screwdriver
80022	3/8" x 8" Slotted Screwdriver
80000	#0 x 2-1/2" Phillips Screwdriver
80001	#1 x 3" Phillips Screwdriver
80004	#1 x 6" Phillips Screwdriver
80005	#2 x 1-1/2" Phillips Screwdriver
80007	#2 x 4" Phillips Screwdriver
80011	#3 x 6" Phillips Screwdriver
80034	1.5mm Mini Slotted Screwdriver
80035	2.0mm Mini Slotted Screwdriver
80036	2.5mm Mini Slotted Screwdriver
80031	#00 Mini Phillips Screwdriver
80032	#0 Mini Phillips Screwdriver
80033	#1 Mini Phillips Screwdriver
80025	T-15 Torx® Screwdriver
80026	T-20 Torx® Screwdriver



83073 - 52 Pc. Screwdriver Set RRP \$209.05

Description

Slotted Screwdrivers: 6mm x 38mm, 5mm x 150mm, 6mm x 100mm, 6mm x 150mm, 8mm x 150mm, 10mm x 200mm
Phillips Screwdrivers: PH#0 x 65mm, PH#1 x 75mm, PH# 1 x 150mm, PH#2 x 38mm, PH#2 x 100mm, PH#3 x 150mm
Mini Slotted Screwdrivers: 1.5mm, 2.0mm, 2.5mm
Mini Phillips Screwdrivers: PH#00, PH#0, PH#1
Long Torx® Screwdrivers: T-15, T-20
Hex Bits: 1/8", 5/32", 3/16", 7/32", 1/4", 5/16"
Hex Bits: 3mm, 4mm, 5mm, 6mm, 7mm, 8mm
Slotted Bits: 5/32", 7/32", 1/4"
Slotted Bits: 4mm, 5.5mm, 6.5mm
Torx® Bits: T-8, T-10, T-15, T-20, T-25, T-27, T-30, T-40
Phillips Bits: PH#0, PH#1, PH#2, PH#3
Ratcheting Screwdriver Handle
6mm Shank Magnetic Bit Shaft 150mm
EVA Tray Included: uncut 655mm x 395mm, cut = 557mm x 360mm

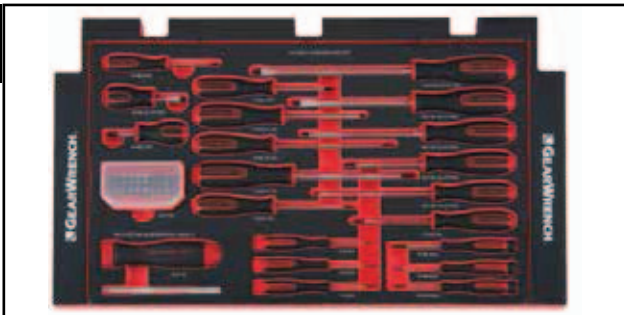

Fits drawer type **A** as shown on page 28.

Note: Individual materials may not be available for separate purchase.

SCREWDRIVER SETS



8939 - 39 Pc. Ratcheting Screwdriver Set RRP \$99.55

Material No.	Description
890001GD	Ratcheting Screwdriver Handle - Red
310901GR	3-1/2" 1/4" Shank Magnetic Bit Shaft
310902GR	6" 1/4" Shank Magnetic Bit Shaft
310903GR	10" 1/4" Shank Magnetic Bit Shaft
311901GR	3-1/2" 1/4" Shank Socket Shaft
311902GR	6" 1/4" Shank Socket Shaft
311904GR	10" 1/4" Shank Socket Shaft
311903GR	6" 1/4" Flexible Socket Shaft
890002GD	1/4" Hex Shank Bit Adapter
890003GD	30 Pc. Bit Set in Case
	3, 4, 5, 6, 7, 8 mm Hex Bits
	1/8", 5/32", 3/16", 7/32", 1/4", 5/16" Hex Bits
	#0, #1, #2, #3 Phillips Bits
	4, 5.5, 6.5, 5/32", 7/32", 1/4" Slotted Bits
	T-8, T-10, T-15, T-20, T-25, T-27, T-30, T-40 Torx® Bits



80055 - 6 Pc. Mini Dual Material Screwdriver Set RRP \$17.95

Material No.	Description
80034	1.5mm Mini Slotted Screwdriver
80035	2.0mm Mini Slotted Screwdriver
80036	2.5mm Mini Slotted Screwdriver
80031	#00 Mini Phillips Screwdriver
80032	#0 Mini Phillips Screwdriver
80033	#1 Mini Phillips Screwdriver



80072 - 2 Pc. Offset Screwdriver Set RRP \$8.40

Material No.	Description
	1/4" Slotted x #2 Phillips Offset Screwdriver
	3/16" Slotted x #1 Phillips Offset Screwdriver

Note: Individual materials may not be available for separate purchase.

NUT DRIVER SETS

82764 - 7 Pc. Full Hollow Shaft Cushion Grip Nut Driver Set METRIC

RRP \$61.10

Material No.	Description
82757D	6 mm Nut Driver, Hollow Shaft
82758	7 mm Nut Driver, Hollow Shaft
82759	8 mm Nut Driver, Hollow Shaft
82760	9 mm Nut Driver, Hollow Shaft
82761	10 mm Nut Driver, Hollow Shaft
82762	11 mm Nut Driver, Hollow Shaft
82763	12 mm Nut Driver, Hollow Shaft



82765 - 7 Pc. Full Hollow Shaft Cushion Grip Nut Driver Set SAE

RRP \$61.10

Material No.	Description	Color
82750	3/16" Nut Driver, Hollow Shaft	Black
82751	1/4" Nut Driver, Hollow Shaft	Red
82752	5/16" Nut Driver, Hollow Shaft	Yellow
82753	11/32" Nut Driver, Hollow Shaft	Green
82754	3/8" Nut Driver, Hollow Shaft	Blue
82755	7/16" Nut Driver, Hollow Shaft	Brown
82756	1/2" Nut Driver, Hollow Shaft	Red



8916D - 16 Pc. Ratcheting Nut Driver Set SAE/ METRIC

RRP \$50.55

Material No.	Description
890005GD	Ratcheting Screwdriver Stubby Handle - Red
890060GD	3/16" Nut Driver Shaft
890080GD	1/4" Nut Driver Shaft
890100GD	5/16" Nut Driver Shaft
890110GD	11/32" Nut Driver Shaft
890120GD	3/8" Nut Driver Shaft
890140GD	7/16" Nut Driver Shaft
890160GD	1/2" Nut Driver Shaft
891050GD	5mm Nut Driver Shaft
891060GD	6mm Nut Driver Shaft
891070GD	7mm Nut Driver Shaft
891080GD	8mm Nut Driver Shaft
891090GD	9mm Nut Driver Shaft
891100GD	10mm Nut Driver Shaft
891110GD	11mm Nut Driver Shaft
891120GD	12mm Nut Driver Shaft



Note: Individual materials may not be available for separate purchase.

PLIERS

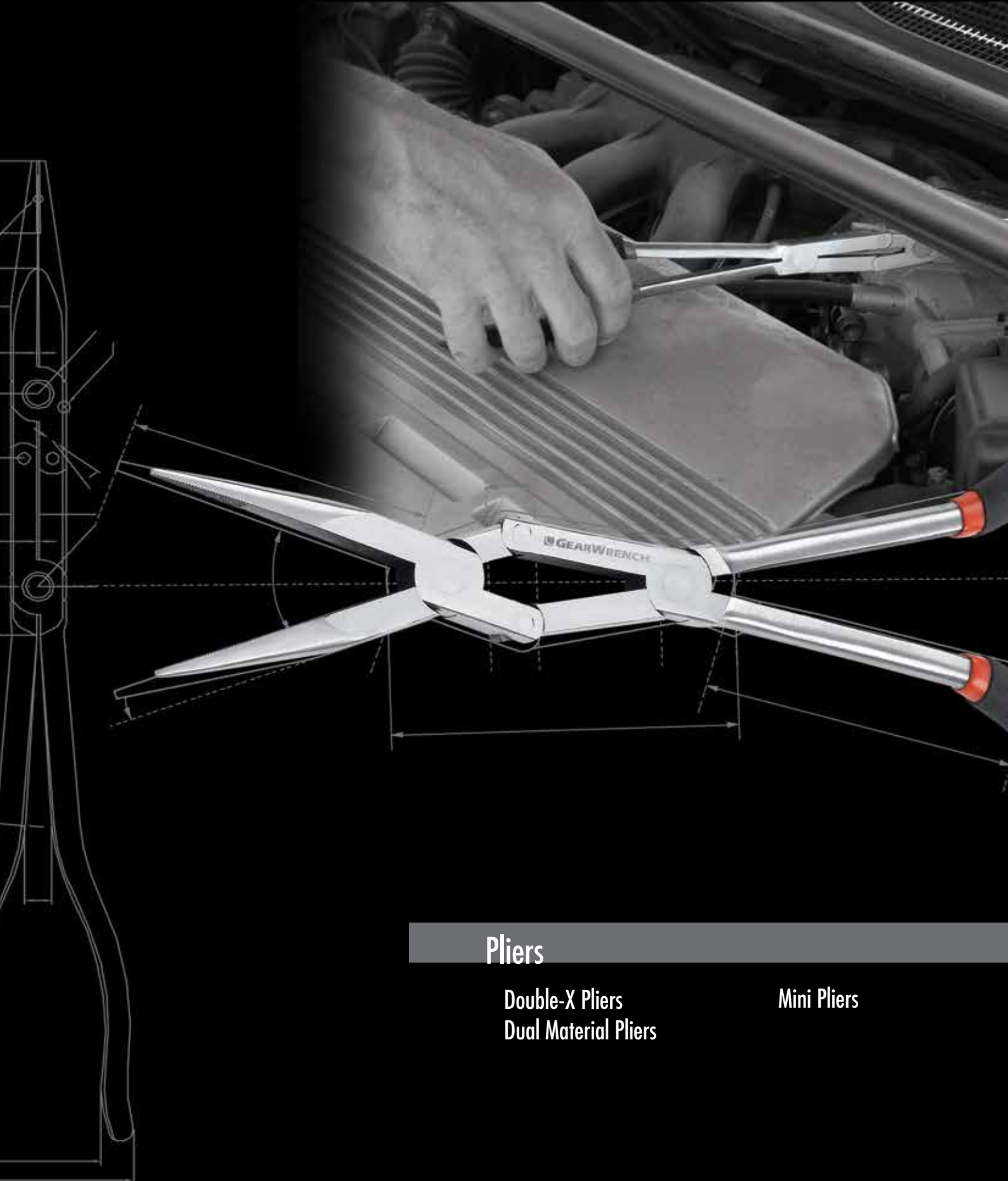

Pliers

Double-X Pliers
Dual Material Pliers

Mini Pliers

DUAL MATERIAL GRIP PLIERS

- AVAILABLE IN:**
- Slip Joint Pliers
 - Duck Bill Pliers
 - Diagonal Pliers
 - Linesmans Pliers
 - Bent Nose Pliers
 - Groove Joint Pliers
 - Long Nose Pliers
 - Fence Pliers



COMPOUND ACTION PLIERS

PIVOTFORCE™

PivotForce pliers exceed industry standard for cut testing requirements and maintain sharp cutting edges



Unique Compound Action design requires 40% less effort to cut, so it is easier and quicker



Watch the video

PLIERS - SETS



82103 - 4 Pc. Mixed Pliers Set RRP \$122.25

Material No.	Description
82011	Tongue and Groove Pliers
82012	Diagonal Cutting Pliers
82013	Long Nose Pliers
82014	Slip Joint Pliers

Weight 1.406 kg

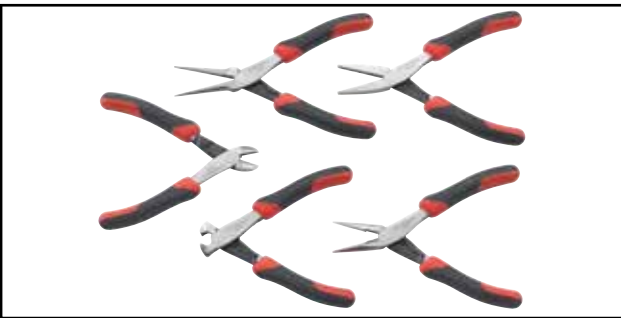

82100 - 5 Pc. Mixed Mini Pliers Set RRP \$73.75

Material No.	Description
82000	Diagonal Cutting Mini Pliers
82001	Long Nose Mini Pliers
82002	Needle Nose Mini Pliers
82003	End Cutting Nipper Mini Pliers
82004	Flat Nose Mini Pliers

Weight 0.450 kg



82108 - 7 Pc. Mixed Pliers Set RRP \$200.20

Material No.	Description
82011	Tongue and Groove Pliers
82012	Diagonal Cutting Pliers
82013	Long Nose Pliers
82014	Slip Joint Pliers
82020	12" Groove Joint Pliers with Straight Jaw
82025	8" Linesman Pliers
82028	8" End Nipper Pliers

Weight 2.495 kg

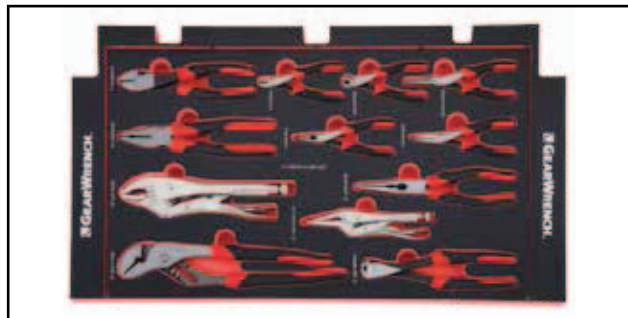

Fits drawer type **A** as shown on page 28.

83072 - 12 Pc. Plier Set RRP \$308.65

Description
Diagonal Cutting Plier: 178mm/7"
Long Nose Plier: 203mm/8"
Groove Joint with Straight Jaw: 305mm/12"
Universal Plier: 203mm/8"
End Nipper: 203mm/8"
Mini Diagonal Plier, Mini Long Nose Plier
Mini Needle Nose Plier, Mini End Nipper, Mini Duck Bill Plier
Long Nose Locking Plier with Wire Cutter: 152mm/6"
Curved Jaw Locking Plier with Wire Cutter: 254mm/10"
EVA Tray Included: uncut 655mm x 395mm, cut = 557mm x 360mm

Note: Individual materials may not be available for separate purchase.

PLIERS - SETS & OPEN STOCK

82106 - 2 Pc. Double-X™ Pliers Set RRP \$72.90

Material No.	Description
82005	Straight Double-X™ Pliers
82006	45 Degree Double-X™ Pliers

Weight 821gm



82005D - Straight Double-X™ Pliers RRP \$40.05

Jaw Length A (mm)	Jaw Width B (mm)	Jaw Thickness C (mm)	Overall Length D (mm)	Weight (g)
80	17	10	337	381

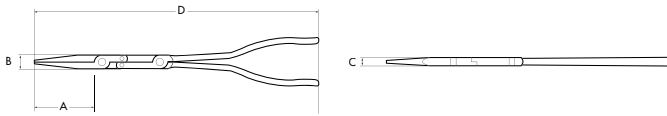

82006D - 45 Degree Double-X™ Pliers RRP \$40.05

Jaw Length A (mm)	Jaw Width B (mm)	Jaw Thickness C (mm)	Overall Length D (mm)	Weight (g)
75	17	10	337	390

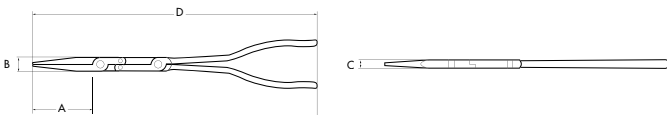
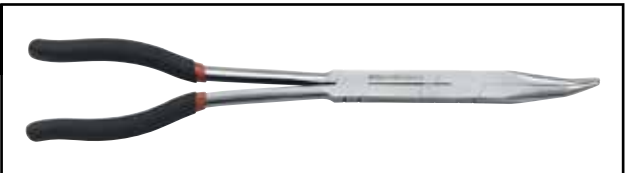

82007 - Duck Bill Double-X™ Pliers RRP \$40.05

Jaw Length A (mm)	Jaw Width B (mm)	Jaw Thickness C (mm)	Overall Length D (mm)	Weight (g)
42	17	10	304	358

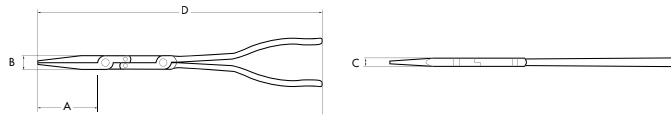

Open Stock - Hose Grip Double-X™ Pliers

Material No.	Size	Jaw Length A (mm)	Jaw Width B (mm)	Jaw Thickness C (mm)	Overall Length D (mm)	Weight (g)	RRP (\$)
82017	5/16"	73	17.3	10	335	376	\$42.15
82018	1/2"	71	17.3	10	333	376	\$42.15
82019	3/4"	69	17.3	10	330	376	\$42.15

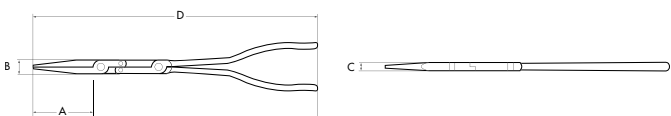
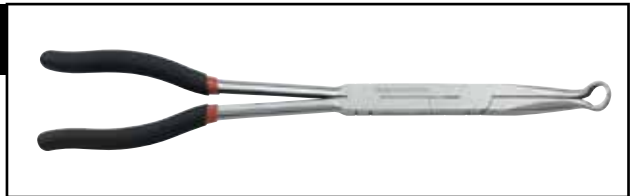

PLIERS - OPEN STOCK



82032 - Double-X™ Internal Snap Ring Pliers

RRP \$73.75

Jaw Length A (mm)	Jaw Width B (mm)	Jaw Thickness C (mm)	Overall Length D (mm)	Weight (g)
80	17	10	342	399

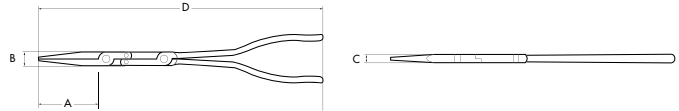

82033 - Double-X™ External Snap Ring Pliers

RRP \$73.75

Jaw Length A (mm)	Jaw Width B (mm)	Jaw Thickness C (mm)	Overall Length D (mm)	Weight (g)
80	17	10	342	399

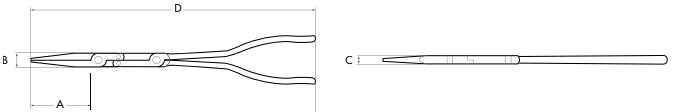

82034 - Double-X™ Straight Hemostat Pliers

RRP \$73.75

Jaw Length A (mm)	Jaw Width B (mm)	Jaw Thickness C (mm)	Overall Length D (mm)	Weight (g)
107	4	3.3	250	95

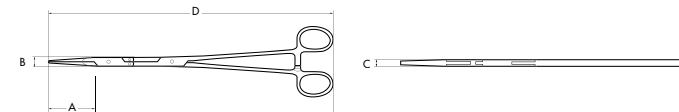

82035 - Double-X™ 45 Degree Hemostat Pliers

RRP \$73.75

Jaw Length A (mm)	Jaw Width B (mm)	Jaw Thickness C (mm)	Overall Length D (mm)	Weight (g)
104	4	3.3	247	95

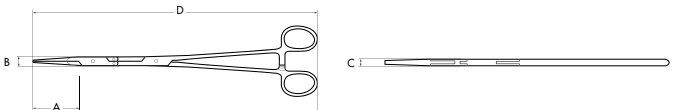

PLIERS - PIVOTFORCE™ COMPOUND ACTION

PivotForce™ Compound Action Pliers

Item No.	Description	RRP
82124	2 Pc. PivotForce™ Compound Action Plier Set	\$79.15
82120	8" PivotForce™ Diagonal Cutting	\$41.85
82121	8" PivotForce™ Long Nose Cutting	\$41.85

- Up to 40% less force needed



82136 - 7" Forged External Snap Ring Pliers - Straight RRP \$24.00

- Remove and Install External Snap Rings
- Fixed Tips for Everyday Professional Use
- Straight Jaws for Deeper Access



82137 - 7" Forged External Snap Ring Pliers - 90 Degree RRP \$24.00

- Remove and Install External Snap Rings
- Forged Design for Strength and Durability
- 90° Jaws for Excellent Line of Sight to the Snap Ring
- Professional Easy-Clean Dipped Grips



82139 - 7" Forged Internal Snap Ring Pliers - Straight RRP \$24.00

- Remove and Install Internal Snap Rings
- Fixed Tips for Everyday Professional Use
- Straight Jaws for Deeper Access
- Professional Easy-Clean Dipped Grips



82140 - 7" Forged Internal Snap Ring Pliers - 90 Degree RRP \$24.00

- Remove and Install Internal Snap Rings
- Fixed Tips for Everyday Professional Use
- 90° Jaws for Excellent Line of Sight to the Snap Ring
- Professional Easy-Clean Dipped Grips



82150 - 4 Pc. 7" Fixed Tip Internal & External Snap Ring Plier Set RRP \$90.00

Material No.	Description
82136	7" Forged External Snap Ring Pliers - Straight
82137	7" Forged External Snap Ring Pliers - 90°
82139	7" Forged Internal Snap Ring Pliers - Straight
82140	7" Forged Internal Snap Ring Pliers - 90°



PRY BARS



Pry Bars

- Indexing Pry Bar
- Extendable Pry-Bar

INDEXING PRY BARS

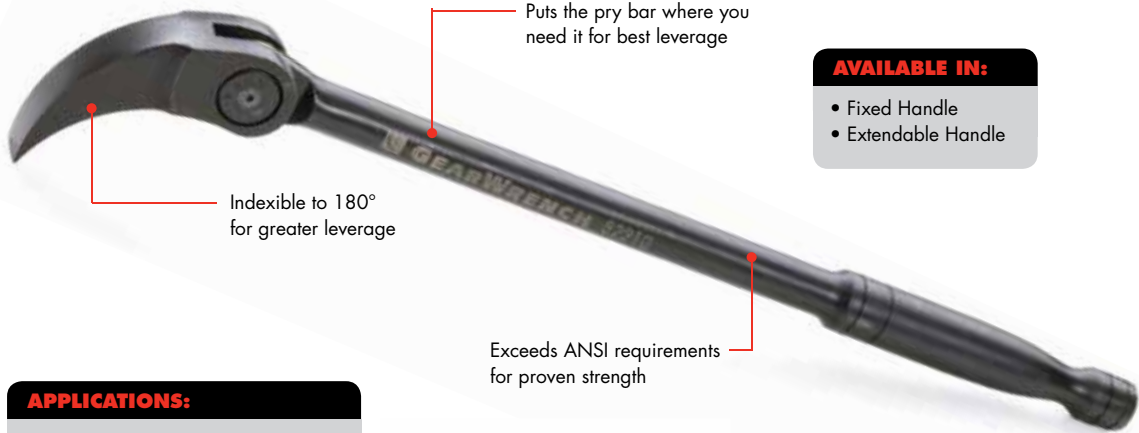

Indexible to 180° for greater leverage

Puts the pry bar where you need it for best leverage

Exceeds ANSI requirements for proven strength

- AVAILABLE IN:**
- Fixed Handle
 - Extendable Handle

- APPLICATIONS:**
- Demolition of roof rafters and floor joists
 - Removing broken concrete
 - Repositioning equipment
 - Aligning steel components and fabrications
 - Engine repositioning and placement



14 Locking positions for unmatched access

Grooved profile adds traction on 24", 33" and Extendable Models



Extends from 18" to 29"



Push button to extend reach

Products are covered by one or more of the following patents:
 • US 6,840,141

PRY BARS

PRY BARS

PRY BARS



82300 - 2 Pc. Pry Bar Set

RRP \$71.95

Material No.	Description
82216	406mm/16" Indexing Pry Bar
82208	203mm/8" Indexing Pry Bar



Open Stock - Indexing Pry Bar

Material No.	Description	RRP
82208	203mm/8" Indexing Pry Bar	\$38.75
82210	254mm/10" Indexing Pry Bar	\$49.80
82216	406mm/16" Indexing Pry Bar	\$57.50
82224	609mm/24" Indexing Pry Bar	\$63.15
82233	838mm/33" Indexing Pry Bar	\$98.45



Open Stock - Extendable Pry Bar

Material No.	Description	RRP
82220	457mm/18" to 736mm/29" Extendable Pry Bar	\$73.75
82248	736mm/29" to 1219mm/48" Extendable Pry Bar	\$165.95



Open Stock - Pry Bar with Angled Tip Set

Material No.	Description	RRP
82408	8" x 1/4" Pry Bar with Angled Tip	\$10.50
82412	12" x 3/8" Pry Bar with Angled Tip	\$19.00
82417	17" x 3/8" Pry Bar with Angled Tip	\$22.00
82425	25" x 1/2" Pry Bar with Angled Tip	\$39.00
82431	31" x 1/2" Pry Bar with Angled Tip	\$48.00
82436	36" x 1/2" Pry Bar with Angled Tip	\$56.00

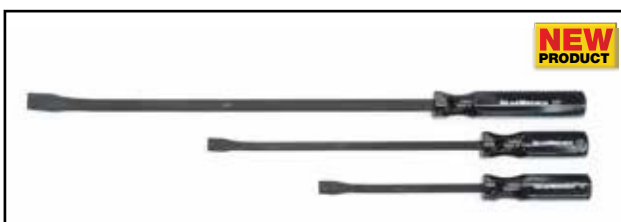

82403 - 3 Pc. Pry Bar with Angled Tip Set

RRP \$73.00

Material No.	Description
82412	12" x 3/8" Pry Bar with Angled Tip
82417	17" x 3/8" Pry Bar with Angled Tip
82425	25" x 1/2" Pry Bar with Angled Tip

STRIKING & STRUCK TOOLS

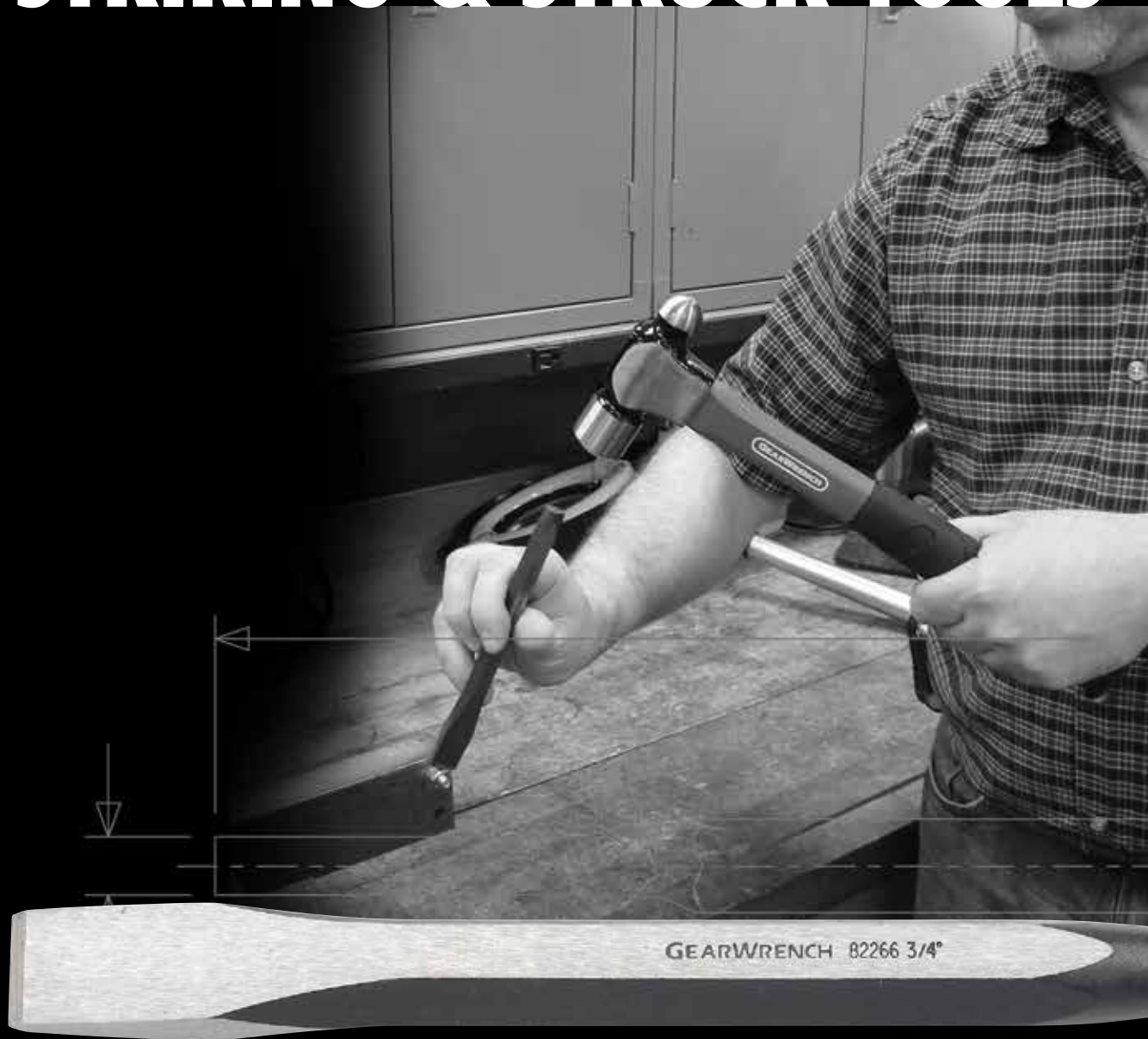

Striking & Struck Tools

Hammers
Chisels
Punches

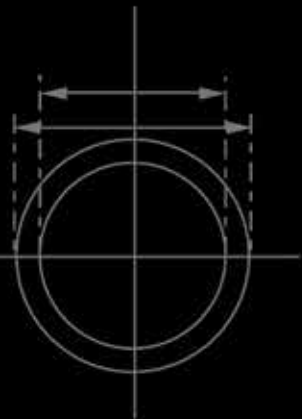

PUNCHES AND CHISELS

AVAILABLE IN:

- Cold Chisels
- Centre Punches
- Pin Punches
- Long Taper Punches

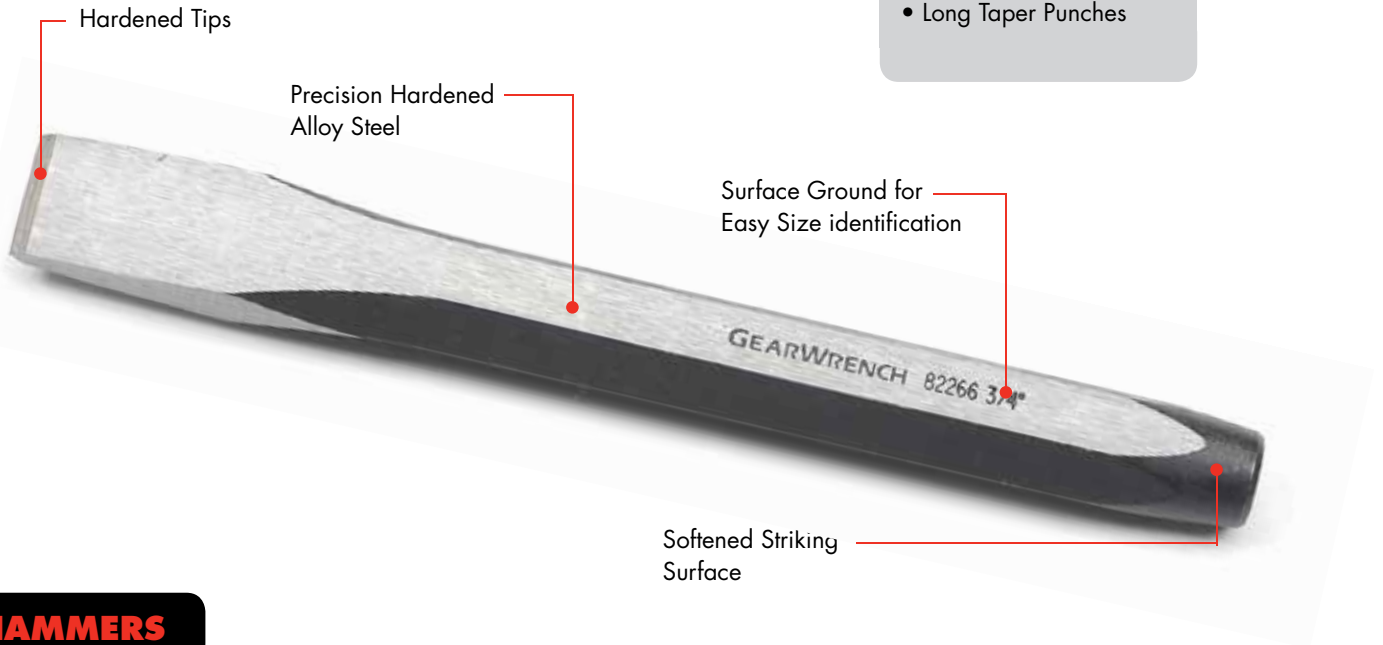

STRICKING AND STRUCK

HAMMERS



PUNCHES AND CHISELS

82304 - 5 Pc. Punch and Chisel Set RRP \$18.95

Material No.	Description
82270	3/8" x 5" Center Punch
82273	1/8" x 5" x 5/16" Pin Punch
82274	5/32" x 5-1/4" x 5/16" Pin Punch
82275	3/16" x 5-1/2" x 5/16" Pin Punch
82264	1/2" x 6" x 3/8" Cold Chisel



82308 - 4 Pc. Cold Chisel Set RRP \$23.20

Material No.	Description
82263	7/16" x 5-1/2" x 3/8" Cold Chisel
82264	1/2" x 6" x 3/8" Cold Chisel
82265	5/8" x 6-1/2" x 3/8" Cold Chisel
82266	3/4" x 7" x 5/8" Cold Chisel



82309 - 5 Pc. Pin Punch Set RRP \$23.20

Material No.	Description
82273	1/8" x 5" x 5/16" Pin Punch
82274	5/32" x 5-1/4" x 5/16" Pin Punch
82275	3/16" x 5-1/2" x 5/16" Pin Punch
82276	1/4" x 7" x 3/8" Pin Punch
82277	5/16" x 7" x 1/2" Pin Punch



82307 - 4 Pc. Long Taper Punch Set RRP \$31.65

Material No.	Description
82278	1/8" x 8" x 3/8" Long Taper Punch
82279	5/32" x 8-1/2" x 1/2" Long Taper
82280	3/16" x 9" x 1/2" Long Taper Punch
82281	1/4" x 11" x 5/8" Long Taper Punch



82305 - 12 Pc. Punch and Chisel Set RRP \$61.85

Cold Chisel			
82261	1/4" x 4-3/4" x 14"	82262	3/8" x 5" x 5/16"
82264	1/2" x 6" x 3/8"	82265	5/8" x 6-1/2" x 3/8"
Pin Punch			
82272	3/32" x 4-3/4" x 5/16"	82273	1/8" x 5" x 5/16"
82274	5/32" x 5-1/4" x 5/16"	82275	3/16" x 5-1/2" x 5/16"
82270	3/8" x 5" Centre Punch		
82278	1/8" x 8" x 3/8" Long Taper Punch		
82283	3/16" x 5" x 3/8" Starter Punch		
82285	1/8" x 4-1/2" x 5/16" Starter		



SESS STRIKING AND STRUCK

STRIKING & STRUCK TOOLS

STRICKING AND STRUCK



Dead Blow Hammers

Material No.	Description	Face Dia. (in)	RRP
82240	18oz/0.5kg	1.5	\$32.00
82242	33oz/0.9kg	1.9	\$43.00
82244	54oz/1.5kg	2.5	\$65.00

• Polyurethane Head and Rubber Handle



Dead Blow Hammer - Composite Handle

Material No.	Description	Face Dia. (in)	RRP
82256	16oz/0.45kg	1.6	\$37.00
82258	48oz/1.36kg	2.4	\$55.20



Ball Pein Hammers - Fibreglass

Material No.	Description	RRP
82250	8oz/0.2kg	\$22.00
82251	16oz/0.4kg	\$33.15
82252	24oz/0.6kg	\$37.75
82253	32oz/0.9kg	\$40.90

• Black Finish with Polished Heads and Pein



Drilling Hammer

Material No.	Description	Face Dia. (in)	RRP
82255	48oz/1.3kg	1.38	\$39.00

RATCHETING TAPS & DIES



Tap & Die Tools

Ratcheting Tap & Die Sets
T-Wrenches
Adapters

RATCHETING TAP AND DIE DRIVE TOOLS



Auto locking feature allows for safe removal of tap adapter

Spring-loaded cap allows for quick-release of large tap adapter

Extension adapters provide access in tight confined areas

Extend the length of tap and die system by combining adapters and any standard 3/8" drive extension.



Works on round and hex shaped dies

Die adapter works with Pass-Thru® Ratchet and Socket System as well as Vortex™ socket accessories.

5° Ratcheting arc with reversible lever eliminates hand over hand turning

Patented Twist Lock Guide System reduces "back walk" of die guard



Products are covered by one or more of the following patents:

- US 6,868,759
- US 7,231,851
- US 7,168,346

RATCHETING TAPS & DIES

RATCHETING TAPS AND DIE SETS

3886 - 40 Pc. Medium Ratcheting Tap and Die Drive Tool Set METRIC RRP \$94.80

Material No.	Description
3881	Medium Tap and Die Ratcheting "T" Wrench
3882	Small Tap Adapter
3883	Medium Tap Adapter
3884	Medium Hex Die Adapter, Sliding "T" for adapters Thread gauge, #5 screwdriver

Taps	Hex Dies
3 x .50 taper	3 x .60
3 x .60 taper	4 x .70
4 x .70 taper	4 x .75
4 x .75 taper	5 x .80
5 x .80 taper	5 x .90
5 x .90 taper	6 x 1.00
6 x 1.00 taper	7 x 1.00
7 x 1.00 taper	8 x 1.25
8 x 1.25 plug	9 x 1.00
9 x 1.00 plug	9 x 1.25
9 x 1.25 plug	10 x 1.25
10 x 1.25 plug	10 x 1.50
10 x 1.50 plug	11 x 1.50
11 x 1.50 plug	12 x 1.50
12 x 1.50 plug	12 x 1.75
12 x 1.75 plug	1/8 - 28BSP



PATENTED

3885 - 40 Pc. Medium Ratcheting Tap and Die Drive Tool Set SAE RRP \$94.80

Material No.	Description
3881	Medium Tap and Die Ratcheting "T" Wrench
3882	Small Tap Adapter
3883	Medium Tap Adapter
3884	Medium Hex Die Adapter, Sliding "T" for adapters Thread gauge, #5 screwdriver

Taps	Hex Dies
1/4 - 20 NC taper	1/4 - 20 NC
1/4 - 28 NF taper	1/4 - 28 NF
5/16 - 18 NC taper	5/16 - 18 NC
5/16 - 24 NF taper	5/16 - 24 NF
3/8 - 16 NC plug	3/8 - 16 NC
3/8 - 24 NF plug	3/8 - 24 NF
7/16 - 14 NC plug	7/16 - 14 NC
7/16 - 20 NF plug	7/16 - 20 NF
1/2 - 13 NC plug	1/2 - 13 NC
1/2 - 20 NF plug	1/2 - 20 NF
4 - 40 taper	4 - 40 taper
6 - 32 taper	6 - 32 taper
8 - 32 taper	8 - 32 taper
10 - 24 taper	10 - 24 taper
10 - 32 taper	10 - 32 taper
12 - 24 taper	12 - 24 taper
1/8 - 27 NPT	1/8 - 27 NPT



PATENTED

Note: Individual materials may not be available for separate purchase.

SETS
RATCHETING TAPS & DIES

RATCHETING TAPS AND DIE SETS

SETS
RATCHETING TAPS & DIES



PATENTED

Taps

1/4 - 20 NC taper	1/4 - 20 NC taper
1/4 - 28 NF taper	1/4 - 28 NF taper
5/16 - 18 NC taper	5/16 - 18 NC taper
5/16 24 NF taper	5/16 24 NF taper
3/8 - 16 NC plug	3/8 - 16 NC plug
3/8 - 24 NF plug	3/8 - 24 NF plug
7/16 -14 NC plug	7/16 -14 NC plug
7/16 - 20 NF plug	7/16 - 20 NF plug
1/2 - 13 NC plug	1/2 - 13 NC plug
1/2 - 20 NF plug	1/2 - 20 NF plug
4 - 40 taper	4 - 40 taper
6 - 32 taper	6 - 32 taper
8 - 32 taper	8 - 32 taper
10 - 24 taper	10 - 24 taper
10 - 32 taper	10 - 32 taper
12 - 24 taper	12 - 24 taper
1/8 - 27 NPT	1/8 - 27 NPT

3887 - 75 Pc. Medium Ratcheting Tap and Die Drive Tool Set SAE/METRIC

RRP \$189.60

Material No.	Description
3881	Medium Tap and Die Ratcheting "T" Wrench
3882	Small Tap Adapter
3883	Medium Tap Adapter
3884	Medium Hex Die Adapter
	Sliding "T" for adapters
	SAE screw pitch gauge
	METRIC screw pitch gauge
	#5 screwdriver

Hex Dies

1/4 - 20 NC	3 x .50 taper
1/4 - 28 NF	3 x .60 taper
5/16 - 18 NC	4 x .70 taper
5/16 - 24 NF	4 x .75 taper
3/8 - 16 NC	5 x .80 taper
3/8 - 24 NF	5 x .90 taper
7/16 -14 NC	6 x 1.00 taper
7/16 - 20 NF	7 x 1.00 taper
1/2 -13 NC	8 x 1.25 plug
1/2 - 20 NF	9 x 1.00 plug
4 - 40 taper	9 x 1.25 plug
6 - 32 taper	10 x 1.25 plug
8 - 32 taper	10 x 1.50 plug
10 - 24 taper	11 x 1.50 plug
10 - 32 taper	12 x 1.50 plug
12 - 24 taper	12 x 1.75 plug
1/8 - 27 NPT	1/8 - 28BSP



PATENTED

82805D - 2 Pc. Ratcheting Tap and Die 3/8" Drive Extension Adapter Set

RRP \$10.55

Material No.	Description
82803	Male Extension Adapter - 3/8" Drive
82804	Female Extension Adapter - 3/8" Drive

Note: Individual materials may not be available for separate purchase.

AUTO SPECIALTY & MISCELLANEOUS TOOLS

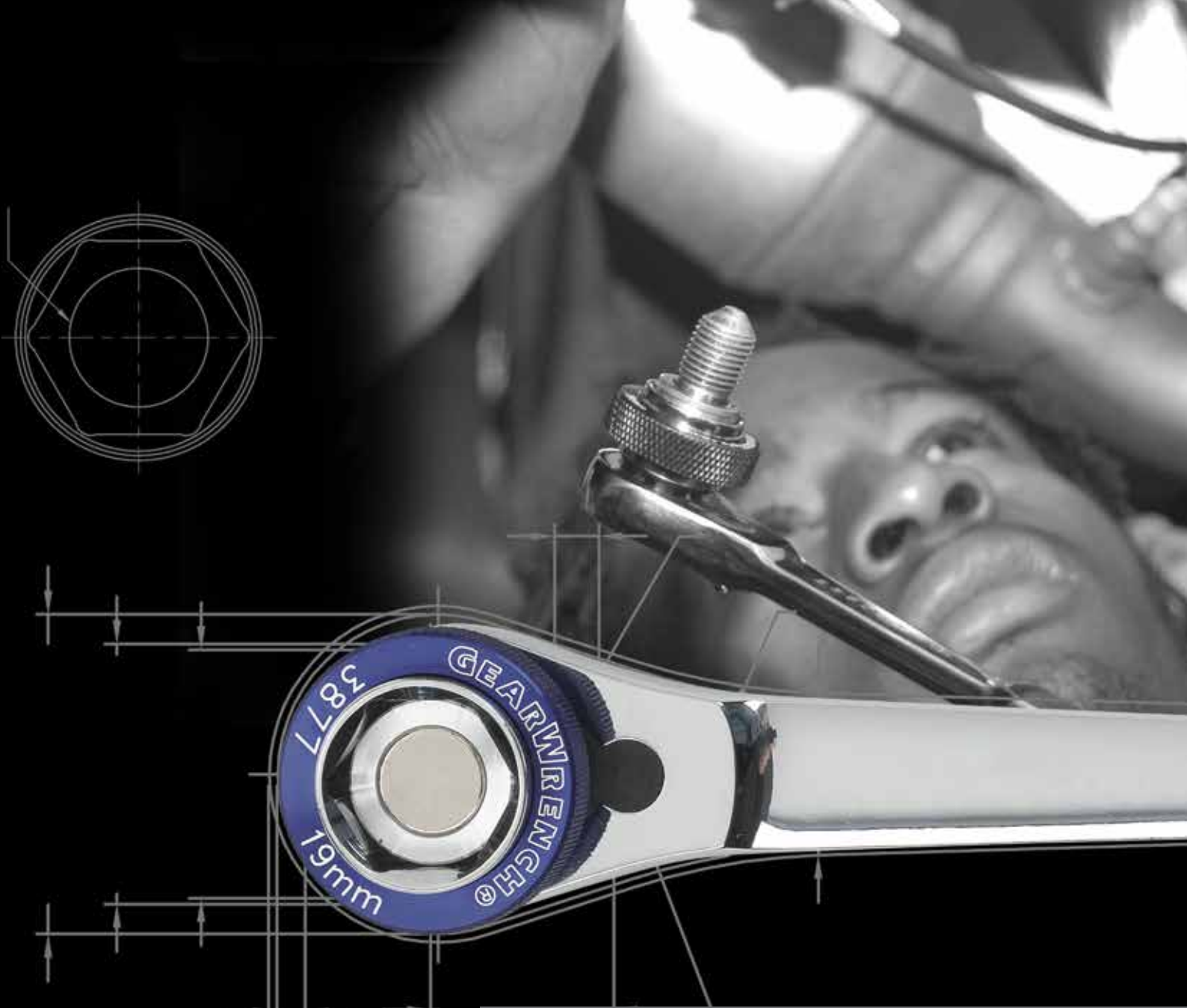

Automotive Specialty Tools

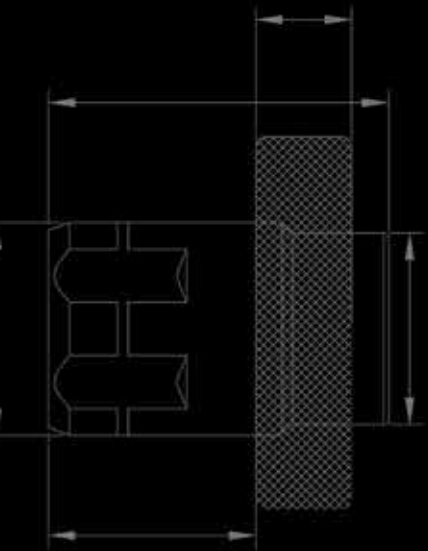

+

Miscellaneous Tools

**OIL DRAIN
PLUG SOCKETS**

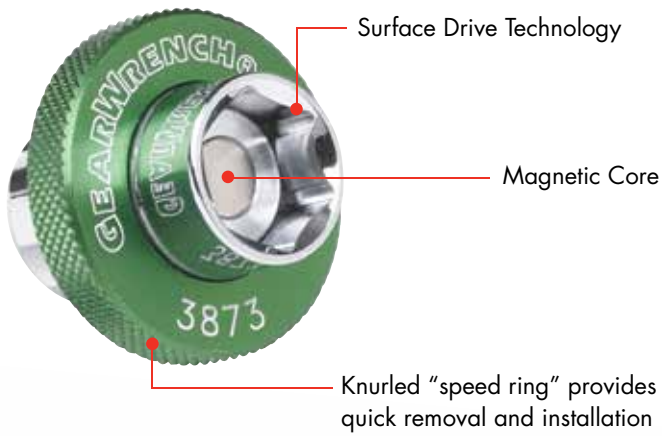

AUTOMOTIVE SPECIALTY

Can be used with Pass-Thru® Ratchets Featuring GearRatchet™ handles, or standard 3/8" Drive ratchets



Products are covered by one or more of the following patents:

- US 7,159,491
- US 7,658,132

AUTOMOTIVE SPECIALTY TOOLS

3870D - 7 Pc. Magnetic Oil Drain Plug Socket Set RRP \$94.80

Material No.	Description
235080GR	3/8" GearRatchet® Handle
3872	13 mm Magnetic Oil Drain Plug Socket
3873	14 mm Magnetic Oil Drain Plug Socket
3874	15 mm Magnetic Oil Drain Plug Socket
3875	16 mm Magnetic Oil Drain Plug Socket
3876	17 mm Magnetic Oil Drain Plug Socket
3877	19 mm Magnetic Oil Drain Plug Socket



NEW PRODUCT

83132 - Flashlight Aluminium RRP \$18.95

- Aluminium body with rubber grip.
- Five LED bulbs above 13000 mcd, white light.
- Weatherproof.
- Rubber ring around head of flashlight.
- Includes carry case.



NEW PRODUCT

83133 - Led Light RRP \$79.00

- 3 lighting options, spotlight, 50% brightness and 100% brightness
- Super bright 380 lumens
- Magnets on rear and also on base
- Light can be rotated 150 degrees
- 360 degree swivel hook
- Samsung 3.7V/2600mAh Li-ion battery
- Includes Charger



NEW PRODUCT

86991 - Fender Cover RRP \$22.00

- Magnetic
- Oil Resistant
- Measure 876mm/34½"W x 470mm/18½"L



NEW PRODUCT

41520 - 15 Pc. Brake Service Set RRP \$149.00

Material No.	Description
287D	Drum Brake Adjusting Tool
2774D	Universal Brake Shoe Retaining Spring Tool
3163D	Disc Brake Piston Tool
3355D	GM-Ford Disc Brake Piston Tool
3525D	Heavy Duty Brake Pad Separator
3962	Brake Lining Thickness Gauge
298D	Brake Spring Pliers
80421	3/8" Drive Hex Bit Socket, 3/8"
80428D	3/8" Drive Hex Bit Socket, 7mm
80429	3/8" Drive Hex Bit Socket, 8mm
80419	3/8" Drive Hex Bit Socket, 1/4"
80431	3/8" Drive Hex Bit Socket, 10mm
3/8" Drive Torx® Press-Fit Bit Sockets	
80452 T-45;	80451 T-40; 80454 T-50



NEW PRODUCT

AUTOMOTIVE SPECIALTY

AUTOMOTIVE SPECIALTY TOOLS



NEW PRODUCT

41540 - 11 Pc. Rear Brake Caliper Set

RRP \$99.00

Material No.	Description
41541	Applicator & Pad for Brake Tool
41542	Adapter O: 2-2/12", 1 Pin
41543	Adapter 2: 2", 3 Pin
41544	Adapter 3: 2-1/4", 3 Step
41545	Adapter 4: 1-1/4", 2 Pin
41546D	Adapter 5: 1-3/8", 2 Pin, 3/8" Drive
41547	Adapter 6: 1-5/8", 2 Pin (L)
41548D	Adapter 7: 1-5/8", 2 Pin (S)
41549D	Adapter 8: 1-7/8", 1 Pin
41550D	Adapter P: 2-1/4", 1 Pin



NEW PRODUCT

41650 - Axle Nut Set

RRP \$135.00

Material No.	Description
3907D	29mm Deep 1/2" Dr. Deep Axle Nut Socket
3161D	30mm Deep 1/2" Dr. Deep Axle Nut Socket
3270D	32mm Deep 1/2" Dr. Deep Axle Nut Socket
3449D	34mm Deep 1/2" Dr. Deep Axle Nut Socket
3908D	35mm Deep 1/2" Dr. Deep Axle Nut Socket
3162D	36mm Deep 1/2" Dr. Deep Axle Nut Socket
3909D	38mm Deep 1/2" Dr. Deep Axle Nut Socket

- 7 Extra Long 1/2" Drive 6 Point Metric Sockets



NEW PRODUCT

41700D - 10 Way Slide Hammer Puller Set

RRP \$220.00

Material No.	Description
3591D	5-1/2lb Slide Hammer Only
230071D	Slide Hammer Part - Shallow Flange
230075D	Slide Hammer Part - Deep Flange

- Jaws can be set up for 2 or 3 Jaw Internal or External Pulling Jobs



NEW PRODUCT

41720 - 8 Pc. Sensor & Sending Socket Set

RRP \$99.00

Material No.	Description
3920D	3/8" Drive 7/8" Slotted Socket for PVS, TVS and O2 Socket
3921D	1/2" Drive 1-1/16" Thermal Sensor Socket
3922D	3/8" Drive 7/8" (22mm) Oxygen Sensor Socket
3923D	3/8" Drive 1-1/16" Deep Oil Pressure Sending Socket
3924D	1/2" Drive 7/8" (22mm) Oxygen Sensor Socket
3925D	3/8" Drive 7/8" (22mm) Low Profile Offset Oxygen Sensor Socket Vacuum Switches

AUTOMOTIVE SPECIALTY SETS

AUTOMOTIVE SPECIALTY TOOLS

41780D - General Purpose Bushing Set RRP \$95.00

- Perfect for removing and inserting bushing in cars, trucks, buses, tractors, construction and off-road equipment
- Set includes small, medium and large drivers and bushing adapters from 3/8" to 1-3/8"



3791 - Small Hose Pinch-Off Pliers RRP \$21.00

- Capacity 3/4" Outside Diameter
- Length 9-1/4"
- Jaw Capacity 2-1/2"

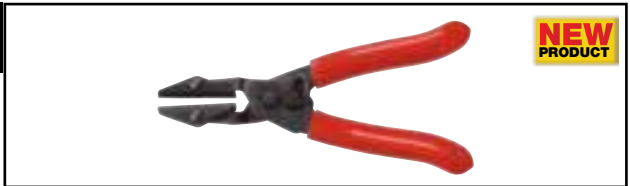

3792D - Medium Hose Pinch-Off Pliers RRP \$49.00

- Capacity 1-1/4" Outside Diameter
- Length 5-1/2"
- Jaw Capacity 3/4"



3793 - Large Hose Pinch-Off Pliers RRP \$57.00

- Capacity 2-1/2" Outside Diameter
- Length 14"
- Jaw Capacity 2-1/2"



3469 -8 Pc. Air Hold & Compression Check Kit RRP \$130.00

- Set includes:
- Compression Gauge - Checks from 0 to 300 PSI (0 to 21Kg/Cm2)
 - One Extension
 - Two Hand-Held Adapters
 - Flexible Line with 14mm and 18mm Threads
 - Three Brass Adapters 10mm, 12mm & 14mm
 - Includes Storage Case



3289 - Oil Pressure Check Kit RRP \$240.00

- Test Engine Oil Pressure at the Oil Filter on Most Passenger Cars and Light Trucks
- Five different Adapters are included for both Domestic and Imported Engines
- Gauge is Calibrated from 0 to 100 PSI



SETS
AUTOMOTIVE SPECIALTY

AUTOMOTIVE SPECIALTY TOOLS



41500 - 12 Pc. Fuel & Trans Line Disconnect Set
RRP \$89.00

Material No.	Description
3321	Fuel Line Quick Disconnect Tool
3408D	Ford Fuel Line Coupling Tool
3890D	Chrysler Quick Disconnect Tool
3891D	GM Transmission Oil Cooler Line Disconnect Tool
3892D	GM Hydraulic Clutch Line Disconnect Tool
3893D	Transmission Oil Cooler Line Disconnect Tool
3894	Ford Auto Transmission to Radiator Line Disconnect Tool
3895D	Disconnect for Fuel Lines Sizes 1/4" - Black
3896D	Disconnect for Fuel Lines Sizes 5/16" - Red
3897D	Disconnect for Fuel Lines Sizes 3/8" - Gold
3898D	Disconnect for Oil Cooler Line - Blue
3413D	Ford Clutch Coupling Tool



3680D - 15 Pc. Ratcheting Serpentine Belt Tool Set
RRP \$83.00

- 6 Point Sockets, 13mm, 14mm, 15mm, 16mm, 17mm, 18mm & 19mm
- Crowsfoot: 13mm, 14mm & 15mm
- Drive Tools: Long Bar, Special GearWrench® Ratcheting Wrench, and 3/8", 1/2" and 3/4" Adapters



3681D - Serpentine Belt Stretch Tool
RRP \$22.00

- Anodized Aluminium Body
- Hardened Steel Pulley Pivot for Long Life

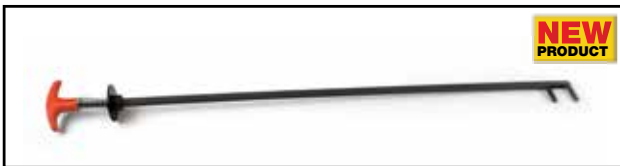

3684D - Serpentine Belt Grabber Tool
RRP \$39.00

- Ergonomic Spring-Loaded Handle Remotely Activates the Belt Grabber for Belt Routing



3245 - Seal Puller
RRP \$20.45

- Puller has 2 Tip Sizes for Most Applications



41600 - Master Bolt Grip Set
RRP \$130.00

Material No.	Description
41601	3 Way Yoke for Bolt Grip Set
41602	4 Pc. Puller Tip Set
41603	Bolt Sets (Black Metric)
41604D	Bolt Sets (Zinc SAE)
41605	Centre Screws for Puller

SETS
AUTOMOTIVE SPECIALTY

AUTOMOTIVE SPECIALTY TOOLS

84080 - 4 Pc. Scraper Set RRP \$48.00

Material No.	Description
84081	1/4" Wide Scraper
84082	1/2" Wide Scraper
84083	1" Wide Scraper - Long
84084	1" Wide Scraper - Short



84070 - 2 Pc. Scraper Set RRP \$35.00

Material No.	Description
84071	1" Wide Reverse Scraper
84072	1" Wide Offset Scraper



135D - Spark Plug Terminal Pliers RRP \$18.45

- Safely remove Spark Plug Cables and prevent Cable Damage



84000D - 7 Pc. Hook & Pick Set RRP \$54.80

Material No.	Description
84001D	5" Cotter Pin Puller
84002D	4" Hose Pick Puller
84003D	4-1/2" Awl
84004D	3-1/8" Mini Full Hook
84005	3-1/8" 90 Degrees Mini Hook
84006	3-1/8" Straight Mini Hook
84007	3-1/8" Mini Offset Hook



84040 - 4 Pc. Hook & Pick Mini Set RRP \$29.00

Material No.	Description
84004D	3-1/8" Mini Full Hook
84005	3-1/8" 90 Degree Mini Hook
84006	3-1/8" Straight Mini Hook
84007	3-1/8" Mini Offset Hook



84060 - 4 Pc. Door Panel Remover Set RRP \$49.00

Material No.	Description
84061	20" Door Panel Remover
84063	Door Panel Remover - Square
84064	Door Panel Remover - V
84065	Trim Pad Tool



41840D - 2 Pc. Push Pin Pliers Set RRP \$38.00

Material No.	Description
3729	Push Pin Removal Pliers - 30°
3888D	Push Pin Pliers - 80°



SETS
AUTOMOTIVE SPECIALTY

AUTOMOTIVE SPECIALTY TOOLS



NEW PRODUCT

2106 - All-Purpose Scraper and Sticker Remover

RRP \$13.65

- Cutting Edge Folds into the Handle for Safe Storage
- Locks into 3 Operating Positions

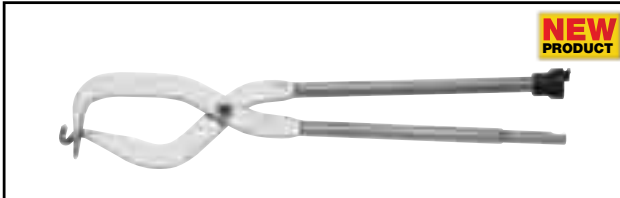

NEW PRODUCT

298D - Brake Spring Pliers

RRP \$24.00

- Chrome Plated
- Removes and Installs Shoe Return Springs on Brakes
- Socket End Removes Spring from Anchor Stud and Notched End Installs Spring on Anchor

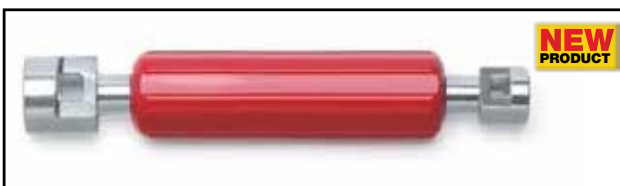

NEW PRODUCT

2774D - Universal Brake Shoe Retaining Spring Tool

RRP \$14.95

- Push and Turn to Remove or Install
- Double-Ended Tool Removes and Installs Small and Large Car Drum Brake Retaining Springs
- Tool Fits Sizes 5/8 to 11/16" and 11/16 to 7/8" Diameter Special Sockets Grip Retaining Washers



NEW PRODUCT

3163D - Disc Brake Piston Tool

RRP \$18.00

- Designed to Rotate the Parking-Brake-Activated Piston Back into the Caliper Cylinder



NEW PRODUCT

3376D - Disc Brake Pad Spreader

RRP \$13.40

- Pushes the Caliper Piston Back on Disc Brakes that do not have the Parking Brake Mechanism as part of the Disc Brake Caliper



NEW PRODUCT

3962 - Brake Lining Thickness Gauge

RRP \$29.00

- SAE - 0.3150 to 0.4720" (Green), 0.1575 to 0.2382" (Yellow), 0.0787 to 0.1181" (Red)
- Colour Coded Brake Gauge Identifies Thickness Levels for Brake Lining Inspection
- Metric - 8, 10 & 12mm (Green), 4, 5, 6mm (Yellow), 2 & 3mm (Red)

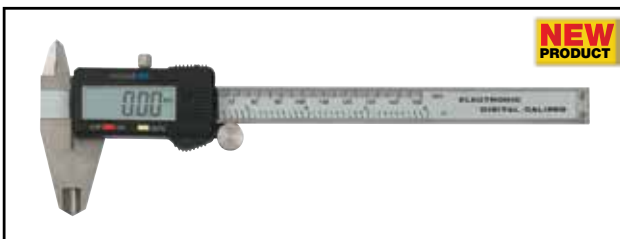

NEW PRODUCT

3756D - 6" Digital Caliper with Large LCD window

RRP \$79.20

- 4 Way Measurement, Inside, Outside, Depth & Step
- Resolution / Repeatability 0.001" x 0.01mm
- Colour Coded Off, On/Zero and Inch/mm
- Scale and Thumb Roll
- LCD Displays Up to 5 Digits
- Data Output Interface

SETS

AUTOMOTIVE SPECIALTY

AUTOMOTIVE SPECIALTY TOOLS

Pro Swivoil™ Filter Wrench

Material No.	Description	RRP
3941	SM (64-76MM)	\$18.00
3942	MD (73-83MM)	\$18.00
3943	LG (89-99MM)	\$19.50
3944	EX LG (96-111MM)	\$19.50



NEW PRODUCT

2029DD - Square Drive Oil Filter Wrench RRP \$15.20

- Remove Filters 3-7/16" to 3-3/4" (87 to 95mm) in Diameter



NEW PRODUCT

3865 - 5 Pc. Oil Filter End Cap Wrench Set in Case RRP \$64.00

Material No.	Description
3860D	Oil Filter End Cap Wrench, 14 Flute, 65/67mm Plastic
3863	Oil Filter End Cap Wrench, 15 Flute, 93mm Plastic
3861D	Oil Filter End Cap Wrench, 15 Flute, 74/76mm Plastic
3864D	Oil Filter End Cap Wrench, 36 Flute, 76/80/93mm Plastic
3862D	Oil Filter End Cap Wrench, 14 Flute, 76mm Plastic



NEW PRODUCT

3508D - Adjustable Oil Filter Wrench Pliers RRP \$55.35

- Ratcheting (2" to 5")
- Min Diameter 50mm
- Max Diameter 125mm



NEW PRODUCT

3288D - Universal 3-Jaw Oil Filter Wrench RRP \$24.65

- Use with 3/8" Square Drive Tool
- Sizes Range from 2-1/2" to 3-3/4"



NEW PRODUCT

3149 - Nylon Strap Oil Filter Wrench, 1/2" Drive RRP \$14.95

- Use with 1/2" Square Drive Tools
- Use Wrench on Oil Filters Up to a 6" (152mm) Diameter
- Strong Nylon Belt Will Not Slip



NEW PRODUCT

SETS
AUTOMOTIVE SPECIALTY

AUTOMOTIVE SPECIALTY TOOLS



NEW PRODUCT

2595D - Chain Wrench, 1/2" Drive

RRP \$35.00

- Chain Length - 16-1/4"
- From 5/8" to 5" (16 to 127mm) in Diameter
- Turnwith 1/2" Square Drive Tools



NEW PRODUCT

43990 - Indexing Ball Joint and Tie Rod Separator Set

RRP \$105.00

- Index to 90° to Strike Hammer Surface with Hand Safety Out of Way
- Dipped Grip on Manual Hammer Attachment to Absorb Shock and Eliminate Slip
- Blowmold Case for Storage
- Pneumatic and Manual Hammer Attachment
- Indexing Feature for Access and Leverage when Prying Suspension Components Apart

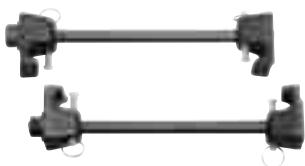

NEW PRODUCT

3387 - Macpherson Strut Spring Compressor

RRP \$109.50

- Maximum Capacity: 6" OD
- Wire Diameter: 5/8"



NEW PRODUCT

2420D - 10 Pc. Clutch Aligning Set

RRP \$42.00

Zinc Adapters for Import	Black Adapters for Domestic
0.472" & 0.500" (12mm & 12.7mm)	0.561" & 0.590" (14.2mm & 15mm)
0.622" & 0.641" (15.8mm & 16mm)	0.749" & 0.787" (19mm & 20mm)
0.688" & 0.710" (17.4mm & 18mm)	0.812" & 0.874" (20.6mm & 22.2mm)
0.826" & 0.875" (21mm & 22.2mm)	0.984" & 1.181" (25mm & 30mm)

- Tapered Cone Fits into Clutch Hole and Aligns Clutch Plate Properly
- Plate Angling Cone has 1-1/8" Maximum Diameter Taper, Pilot Bushing Cone Taper 0.734" to 1/17" (18.64mm to 29.72mm)
- Align Single Disc Clutches on American and Imported Cars, Light Trucks and Tractors
- Adapter Fits Through Clutch Plate and into Pilot Bushing or Bearing



NEW PRODUCT

84088 - Telescoping Magnetic Pickup Tool - 2-1/2 lb capacity

RRP \$14.00

- Pick Up Hard-to-Reach Ferrous Metal Parts or Tools
- Includes Pocket Clip

SETS

AUTOMOTIVE SPECIALTY

AUTOMOTIVE SPECIALTY TOOLS

84087 - Round Lighted Telescoping Inspection Mirror RRP \$24.00

- 2-3/8" Diameter
- Heavy Duty Dual Material Non-Slip Grip
- LED Light Illuminates Low Light Areas



NEW PRODUCT

84086 - 2-1/4" Round Telescoping Inspection Mirror RRP \$15.00

- 2-1/4" Diameter
- Mirror Swivels to Almost Any Position



NEW PRODUCT

84946 - 3 Pc. Protector Impact Socket Set 1/2" DRIVE RRP \$59.00

Material No. Description

17mm, 19mm & 21mm

- Protective outer sheath
- Insert protects lug nuts and bolts



NEW PRODUCT

83104 - Universal Magnetic Parts Tray - Circular RRP \$13.75



PATENT PENDING

82820 - 4 Pc. Standard Bastard File Set RRP \$72.85

Material No. Description

82822D 8" Flat Bastard File

82823 8" Round Bastard File

82824 8" Half Round Bastard File

82825 8" Triangle Bastard File



NEW PRODUCT

SETS

AUTOMOTIVE SPECIALTY

AUTOMOTIVE SPECIALTY TOOLS

SETS
AUTOMOTIVE SPECIALTY



NEW PRODUCT

82136 - 7" Forged External Snap Ring Pliers - Straight

RRP \$24.00

- Remove and Install External Snap Rings
- Fixed Tips for Everyday Professional Use
- Straight Jaws for Deeper Access



NEW PRODUCT

82137 - 7" Forged External Snap Ring Pliers - 90 Degree

RRP \$24.00

- Remove and Install External Snap Rings
- Forged Design for Strength and Durability
- 90° Jaws for Excellent Line of Sight to the Snap Ring
- Professional Easy-Clean Dipped Grips



NEW PRODUCT

82139 - 7" Forged Internal Snap Ring Pliers - Straight

RRP \$24.00

- Remove and Install Internal Snap Rings
- Fixed Tips for Everyday Professional Use
- Straight Jaws for Deeper Access
- Professional Easy-Clean Dipped Grips



NEW PRODUCT

82140 - 7" Forged Internal Snap Ring Pliers - 90 Degree

RRP \$24.00

- Remove and Install Internal Snap Rings
- Fixed Tips for Everyday Professional Use
- 90° Jaws for Excellent Line of Sight to the Snap Ring
- Professional Easy-Clean Dipped Grips



NEW PRODUCT

82150 - 4 Pc. 7" Fixed Tip Internal & External Snap Ring Plier Set

RRP \$90.00

Material No.	Description
82136	7" Forged External Snap Ring Pliers - Straight
82137	7" Forged External Snap Ring Pliers - 90°
82139	7" Forged Internal Snap Ring Pliers - Straight
82140	7" Forged Internal Snap Ring Pliers - 90°

AUTOMOTIVE SPECIALTY TOOLS

161D - Deluxe Feeler Gauge RRP \$12.40

Feeler Gauge Sizes SAE

0.0015,0.002,0.0025,0.003,0.004,0.005,0.006,0.007,0.008,0.009,0.01,0.01 (Brass)
 0.011,0.012,0.013,0.014,0.015,0.016,0.017,0.018,0.019,0.02,0.021,0.022,0.023,0.024,0.025,
 0.026,0.028,0.03,0.032,0.035

Feeler Gauge Sizes Metric

0.038,0.051,0.063,0.076,0.102,0.127,0.152,0.178,0.203,0.229,0.254,0.254 (Brass)
 0.279,0.305,0.33,0.356,0.381,0.406,0.432,0.457,0.483,0.508,0.533,0.559,0.584,0.61,0.635,
 0.66,0.711,0.762,0.813,0.889



3761 - Dial Indicator Set with On/Off Stand RRP \$119.00

- Universal Dovetail Clamp for Dial Test Indicators
- On / Off Switch
- Powerful 130lbs Pull
- Two Magnetic Mounting Surfaces: Bottom and Back
- Swivel Adapter to Mount All Agd Dial Indicators with Lug Backs
- English Dial Gauge Range: 0-1.3", Graduation: 0.001"
- Centered V-Magnet for Strongest Grip on Round or Flat Surfaces
- Centre Rod 1/2" Diameter x 7" High



126D - High Low Voltage Tester RRP \$25.00

- To Use as a Spark Tester, Screw the Probe to the Opposite End of the Handle
- Test for Voltage in 6 and 12V Systems for Voltage and Spark Plugs for Spark by Grounding the Clip and Touching the Probe to the Point being Tested
- Tester Bulb will Light if Power is Present



3468 - 4 Pc. Diesel Compression Test Kit RRP \$182.90

- Gauge Checks from 0 to 1000 PSI (0 to 70Kg/Cm2)
- Set includes
- Compression Gauge with Protective Boot and Special Air-Hold
- Brass Adapter: 24mm x 20; 10mm x 10; 10mm x 10



SETS
AUTOMOTIVE SPECIALTY

AUTOMOTIVE SPECIALTY TOOLS



2426D - 3" Scraper

RRP \$10.50

- Stiff Tempered-Steel Blade
- Blade is Ground to a Mirror Finish



Engineers Vices

Material No.	Description	Max Jaw Capacity	Throat Depth	Clamp Force	RRP
9080	100mm, Bench	75mm	57mm	1.5 tons	\$83.35
9081	100mm, Swivel	75mm	57mm	1.5 tons	\$93.85
9082	150mm, Bench	125mm	73mm	2.5 tons	\$183.50

SETS

AUTOMOTIVE SPECIALTY



9230D - 3 Pc. Drive Adapter Set METRIC

RRP \$33.10

Material No.	Description	Weight (g)
9207	1/4" Dr. x 10 mm	12
9208	3/8" Dr. x 13 mm	26
9209	1/2" Dr. x 19 mm	55



9231D - 3 Pc. Drive Adapter Set SAE

RRP \$33.10

Material No.	Description	Weight (g)
9217	1/4" Dr. x 3/8"	12
9218	3/8" Dr. x 1/2"	26
9219	1/2" Dr. x 3/4"	55

AUTOMOTIVE SPECIALTY TOOLS

83103 - 3 Pc. Slide Rail Socket System
1/4" 3/8" & 1/2" DRIVE RRP \$42.15

Item No.	Description
83105	Red Slide Socket Rail 1/4" Drive
83101D	Red Slide Socket Rail 3/8" Drive
83102	Red Slide Socket Rail 1/2" Drive

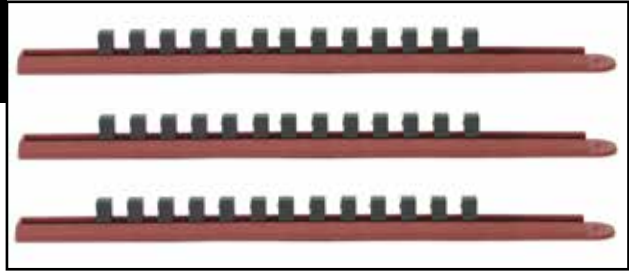

PATENTED

Open Stock - Socket Rails

Item No.	Description	RRP
83105	Red Slide Socket Rail 1/4" Drive	\$14.75
83101D	Red Slide Socket Rail 3/8" Drive	\$14.75
83102	Red Slide Socket Rail 1/2" Drive	\$14.75

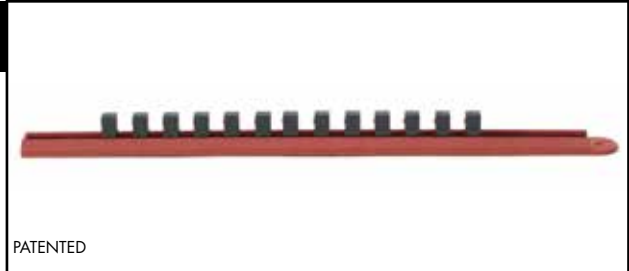

PATENTED

9248 - 18 Pocket Empty Wrench Roll RRP \$26.20

- Ideal for wrenches 6mm to 25mm (1/4" to 1")



SETS
AUTOMOTIVE SPECIALTY

MISCELLANEOUS



ML100 - Weller Magna-Lite Butane Micro Torch

RRP \$23.00

- Piezo ignition
- Blue LED light illuminates work
- Adjustable flame height



ML200 - Weller Magna-Lite Butane Table Top Torch

RRP \$67.90

- Waterproof piezo ignition
- Adjustable flame height and level of output (up to 1,300°C/2,400°F)
- Flame lock option



NPFS6 - Nicholson 6 Pc. Precision File Set

RRP \$17.05

- Contains: Flat Parallel, Flat Tapered, Round, Square, Half Round, Triangular



Crescent Cable Ties

Material No.	Description	Pack Qty	Shelf Pack	RRP
WB4100	Black 100mm x 2.5mm	100	10*	\$1.90
WB4500	Black 100mm x 2.5mm	500	1	\$7.10
WB8100	Black 200mm x 4.8mm	100	10*	\$6.30
WB8500	Black 200mm x 4.8mm	500	1	\$23.90
WB12100	Black 300mm x 4.8mm	100	10*	\$11.40
WB12500	Black 300mm x 4.8mm	500	1	\$41.95
WA350	Assorted	350	1	\$13.80

* Shelf Packs Cannot Be Broken



Crescent Hand Cleaner

Material No.	Description	RRP
CHC75	Crescent Hand Cleaner 750ml with grit	\$12.00
CHC500	Crescent Hand Cleaner 5lt grit and pump	\$56.95
CHC1500	Crescent Hand Cleaner 15lt with grit	\$124.75
CHCP1AU	Hand Cleaner Pump for 15lt Drum	\$18.35

SETS

AUTOMOTIVE SPECIALTY

MISCELLANEOUS

80975 - Nicholson Hacksaw 4-in1 Hi Tension RRP \$51.80

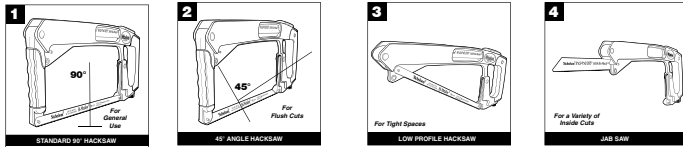

62832 - Nicholson 300mm Bi Metal Steel 24 Teeth Blade RRP \$5.70

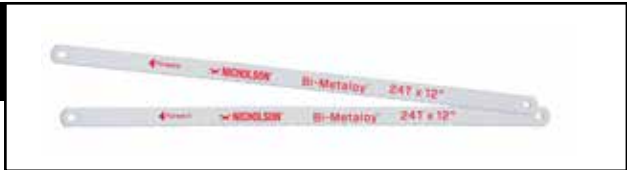

N80D - Crescent 80W Soldering Iron RRP \$27.95

- 80 Watt / 240 Volt Electrical
- Comfort grip handle



SETS
AUTOMOTIVE SPECIALTY

Material No.	Description	Page No.	Barcode Prefix	
			■ 082171	□ 037103
126D	High Low Voltage Tester NEW	165	■	001260
132120GR	3/8"Dr Vortex Socket 3/8"	74	■	991134
132140GR	3/8"Dr Vortex Socket 7/16"	74	■	991141
132160GR	3/8"Dr Vortex Socket 1/2"	74	■	991158
132180GR	3/8"Dr Vortex Socket 9/16"	74	■	991165
132200GR	3/8"Dr Vortex Socket 5/8"	74	■	322006
132220GR	3/8"Dr Vortex Socket 11/16"	74	■	322204
132240GR	3/8"Dr Vortex Socket 3/4"	74	■	322402
132260GR	3/8"Dr Vortex Socket 13/16"	74	■	132261
132280GR	3/8"Dr Vortex Socket 7/8"	74	■	132285
135D	Spark Plug Terminal Pliers NEW	159	■	001352
161D	Deluxe Feeler Gauge NEW	165	■	001611
2029DD	Square Drive Oil Filter Wrench NEW	161	■	020292
2106	All Purpose Scraper and Sticker Remover NEW	160	■	021060
231060GR	Extention 3" Vortex, 3/8"Dr NEW	74	■	310607
231062GR	3/8"Dr 3/8"Squ Pass-Thru QR Adapter	74	■	310621
231080GR	Extention 6" Vortex, 3/8" Dr	74	■	231087
2420D	10Pc Clutch Aligning Set NEW	162	■	024207
2426D	3" Scraper NEW	166	■	024269
2595D	Chain Wrench, 1/2" Drive NEW	162	■	025952
2774D	Universal Brake Shoe Retaining Spring Tool NEW	160	■	027741
298D	Brake Spring Pliers NEW	160	■	002984
3149	Nylon Strap Oil Filter Wrench, 1/2" Drive NEW	161	■	031496
3163D	Disc Brake Piston Tool NEW	160	■	031632
3245	Seal Puller NEW	158	■	032455
3289	Oil Pressure Test Kit NEW	157	■	032899
3288D	Universal 3-Jaw Oil Filter Wrench NEW	161	■	032882
3387	Macpherson Strut Spring Compressor NEW	162	■	033872
3376D	Disc Brake Pad Spreader NEW	160	■	033766
3468	4Pc Diesel Compression Test Kit NEW	165	■	034688
3469	8Pc Compression Check Kit NEW	157	■	034695
3761	Dial Indicator Set with ON/OFF Stand NEW	165	■	037610
3508D	Adjustable Oil Filter Wrench Pliers NEW	161	■	035081
3680D	15Pc Ratcheting Serpentine Belt Tool Set NEW	158	■	036804
3681D	Serpentine Belt Stretch Tool NEW	158	■	036811
3684D	Serpentine Belt Grabber Tool NEW	158	■	036842
3791	Small Hose Pinch-Off Pliers, 3/4" Capacity NEW	157	■	037917
3793	Large Hose Pinch-Off Pliers, 2-1/2" Capacity NEW	157	■	037931
3756D	6" Digital Caliper with large LCD Screen Window NEW	160	■	037566
3792D	Medium Hose Pinch-Off Pliers, 1-1/4" Capacity NEW	157	■	037924
3865	5Pc Oil Filter End Cap Wrench Set in Case NEW	161	■	038655
3885	40Pc SAE Ratcheting Tap and Die Drive Tool Set	151	■	388514
3886	40Pc Metric Ratcheting Tap and Die Drive Tool Set	151	■	388620
3887	75Pc Ratcheting Tap & Die Tool Set SAE/Metric	152	■	388736
3870D	7 Pc Magnetic Oil Drain Plug Socket Set	155	■	387050
3941	Pro Swivoil™ Filter Wrench SM(64-76mm) NEW	161	■	394102
3942	Pro Swivoil™ Filter Wrench MD(73-83mm) NEW	161	■	394201
3943	Pro Swivoil™ Filter Wrench LG(89-99mm) NEW	161	■	394300
3944	Pro Swivoil™ Filter Wrench EX LG(96-111mm) NEW	161	■	394409
3962	Brake Lining Thickness Gauge NEW	160	■	396205
41500	12Pc Fuel & Trans Line Disconnect Set NEW	158	■	415005
41520	15Pc Brake Service Set NEW	155	■	041525
41540	11 Pc Rear Brake Caliper Set NEW	156	■	041549
41600	Master Bolt Grip Set NEW	158	■	041600
41650	Axle Nut Set NEW	82, 156	■	416507
41720	8Pc Sensor & Sending Socket Set NEW	156	■	417207
41700D	10 Way Slide Hammer Puller Set NEW	156	■	041709
41780D	General Purpose Bushing Set NEW	157	■	417801
41840D	2Pc Push Pin Pliers Set NEW	159	■	418402
43990	Indexing Ball Joint and Tie Rod Separator Set NEW	162	■	439902
532100GR	3/8" Vortex Socket 10mm	74	■	321009
532110GR	3/8" Vortex Socket 11mm	74	■	321108
532120GR	3/8" Vortex Socket 12mm	74	■	321207

Material No.	Description	Page No.	Barcode Prefix	
			■ 082171	□ 037103
532130GR	3/8" Vortex Socket 13mm	74	■	321306
532140GR	3/8" Vortex Socket 14mm	74	■	321405
532150GR	3/8" Vortex Socket 15mm	74	■	321504
532160GR	3/8" Vortex Socket 16mm	74	■	321603
532170GR	3/8" Vortex Socket 17mm	74	■	321702
532180GR	3/8" Vortex Socket 18mm	74	■	321801
532190GR	3/8" Vortex Socket 19mm	74	■	321900
62832	300mm Bi-Metal 24 Teeth Steel Saw Blade NEW	169	□	628329
80050	6Pc Combination Screwdriver Set	132	●	800504
80055	6Pc Mini Screwdriver Set	134	●	800559
80060	10Pc Combination & Pozidrive Screwdriver Set	132	●	800603
80064	3Pc Screwdriver Set, Dual Material, Long Torx	77, 132	●	800641
80065	4Pc Square Dual material, Screwdriver Set	133	●	800658
80066	20Pc Master Screwdriver Set	133	●	800665
80068	2 Pc XLong Comb Dual Material Screwdriver Set NEW	132	●	800689
80072	2 Pc Offset Screwdriver Set	134	●	800726
80100	1/4"Dr Universal Joint	50	●	801006
80104D	1/4"Dr 6pt Standard Socket 5/32"	52	●	801044
80105	1/4"Dr 6pt Standard SAE Socket 3/16"	52	●	801051
80106	1/4"Dr 6pt Standard SAE Socket 7/32"	52	●	810060
80107	1/4"Dr 6pt Standard SAE Socket 1/4"	52	●	801075
80108	1/4"Dr 6pt Standard SAE Socket 9/32"	52	●	801082
80109	1/4"Dr 6pt Standard SAE Socket 5/16"	52	●	801099
80110	1/4"Dr 6pt Standard SAE Socket 11/32"	52	●	801105
80111	1/4"Dr 6pt Standard SAE Socket 3/8"	52	●	801112
80112	1/4"Dr 6pt Standard SAE Socket 7/16"	52	●	801129
80113D	1/4"Dr 6pt Standard SAE Socket 1/2"	52	●	801136
80114D	1/4"Dr 6pt Standard SAE Socket 9/16"	52	●	801143
80116D	1/4"Dr 6pt Deep SAE Socket 7/32"	53	●	801167
80115	1/4"Dr 6pt Deep SAE Socket 3/16"	53	●	801150
80117	1/4"Dr 6pt Deep SAE Socket 1/4"	53	●	801174
80118	1/4"Dr 6pt Deep SAE Socket 9/32"	53	●	801181
80119	1/4"Dr 6pt Deep SAE Socket 5/16"	53	●	801198
80120D	1/4"Dr 6pt Deep SAE Socket 11/32"	53	●	801204
80121	1/4"Dr 6pt Deep SAE Socket 3/8"	53	●	801211
80122D	1/4"Dr 6pt Deep SAE Socket 7/16"	53	●	801228
80123	1/4"Dr 6pt Deep SAE Socket 1/2"	53	●	801235
80124	1/4"Dr 6pt Deep SAE Socket 9/16"	53	●	801242
80125	1/4"Dr 6pt Standard Metric Socket 4mm	52	●	801259
80126	1/4"Dr 6pt Standard Metric Socket 5mm	52	●	801266
80127	1/4"Dr 6pt Standard Metric Socket 5.5mm	52	●	801273
80128	1/4"Dr 6pt Standard Metric Socket 6mm	52	●	801280
80129	1/4"Dr 6pt Standard Metric Socket 7mm	52	●	801297
80130	1/4"Dr 6pt Standard Metric Socket 8mm	52	●	801303
80131D	1/4"Dr 6pt Standard Metric Socket 9mm	52	●	801310
80132	1/4"Dr 6pt Standard Metric Socket 10mm	52	●	801327
80133	1/4"Dr 6pt Standard Metric Socket 11mm	52	●	801334
80134	1/4"Dr 6pt Standard Metric Socket 12mm	52	●	801341
80135D	1/4"Dr 6pt Standard Metric Socket 13mm	52	●	801358
80136	1/4"Dr 6pt Standard Metric Socket 14mm	52	●	801365
80137	1/4"Dr 6pt Standard Metric Socket 15mm	52	●	801372
80138	1/4"Dr 6pt Deep Metric Socket 4mm	53	●	801389
80139	1/4"Dr 6pt Deep Metric Socket 5mm	53	●	801396
80140	1/4"Dr 6pt Deep Metric Socket 5.5mm	53	●	801402
80141	1/4"Dr 6pt Deep Metric Socket 6mm	53	●	801419
80142	1/4"Dr 6pt Deep Metric Socket 7mm	53	●	801426
80143	1/4"Dr 6pt Deep Metric Socket 8mm	53	●	801433
80144	1/4"Dr 6pt Deep Metric Socket 9mm	53	●	801440
80145	1/4"Dr 6pt Deep Metric Socket 10mm	53	●	801457
80146D	1/4"Dr 6pt Deep Metric Socket 11mm	53	●	801464
80147	1/4"Dr 6pt Deep Metric Socket 12mm	53	●	811470
80148	1/4"Dr 6pt Deep Metric Socket 13mm	53	●	801488
80149	1/4"Dr 6pt Deep Metric Socket 14mm	53	●	801495
80150	1/4"Dr 6pt Deep Metric Socket 15mm	53	●	801501

Material No.	Description	Page No.	Barcode Prefix	
			■ 082171 □ 037103 ● 099575 ▲ 09337103	
80300	51Pc 1/4"Dr 6pt Std and Deep Socket Set SAE/Metric	47	●	803000
80300P	51Pc 1/4"Dr 120XP Standard & Deep Socket Set SAE/Metric NEW	47	●	830105
80304	13Pc 1/4"Dr 6pt Deep Metric Socket Set	51	●	803048
80305	10Pc 1/4"Dr 6pt Deep SAE Socket Set	51	●	803055
80306	13Pc 1/4"Dr 12pt Standard Metric Socket Set	51	●	803062
80307D	10Pc 1/4"Dr 12pt Standard SAE Socket Set	51	●	803079
80310D	7Pc Flex Socket Set, 1/4" DR, 6Pt, SAE	51	●	803109
80311	12Pc Flex Socket Set, 1/4" DR, 6Pt, Metric	51	●	803116
80327	22Pc 1/4"Dr Metric Socket Set	48	●	803277
80363	3/8"Dr 6pt Deep SAE Socket 1/4"	61	●	803635
80364	3/8"Dr 6pt Deep SAE Socket 5/16"	61	●	803642
80365	3/8"Dr 6pt Deep SAE Socket 3/8"	61	●	803659
80366	3/8"Dr 6pt Deep SAE Socket 7/16"	61	●	803666
80367	3/8"Dr 6pt Deep SAE Socket 1/2"	61	●	803673
80368	3/8"Dr 6pt Deep SAE Socket 9/16"	61	●	803680
80369	3/8"Dr 6pt Deep SAE Socket 5/8"	61	●	803697
80370D	3/8"Dr 6pt Deep SAE Socket 11/16"	61	●	803703
80371	3/8"Dr 6pt Deep SAE Socket 3/4"	61	●	803710
80372	3/8"Dr 6pt Deep SAE Socket 13/16"	61	●	803727
80373	3/8"Dr 6pt Deep SAE Socket 7/8"	61	●	803734
80388	3/8"Dr 6pt Deep Metric Socket 6mm	61	●	803888
80389	3/8"Dr 6pt Deep Metric Socket 7mm	61	●	803895
80390	3/8"Dr 6pt Deep Metric Socket 8mm	61	●	803901
80391	3/8"Dr 6pt Deep Metric Socket 9mm	61	●	803918
80392	3/8"Dr 6pt Deep Metric Socket 10mm	61	●	803925
80393D	3/8"Dr 6pt Deep Metric Socket 11mm	61	●	803932
80394D	3/8"Dr 6pt Deep Metric Socket 12mm	61	●	803949
80395	3/8"Dr 6pt Deep Metric Socket 13mm	61	●	803956
80396	3/8"Dr 6pt Deep Metric Socket 14mm	61	●	803963
80397	3/8"Dr 6pt Deep Metric Socket 15mm	61	●	803970
80398	3/8"Dr 6pt Deep Metric Socket 16mm	61	●	803987
80399	3/8"Dr 6pt Deep Metric Socket 17mm	61	●	803994
80400	3/8"Dr 6pt Deep Metric Socket 18mm	61	●	804007
80401	3/8"Dr 6pt Deep Metric Socket 19mm	61	●	804014
80402	3/8"Dr Spark Plug Socket 5/8"	58	●	804021
80403	3/8"Dr Spark Plug Socket 13/16"	58	●	804038
80406	3/8"Dr 6pt Deep Metric Socket 20mm	61	●	804069
80407	3/8"Dr 6pt Deep Metric Socket 21mm	61	●	804076
80408	3/8"Dr 6pt Deep Metric Socket 22mm	61	●	804083
80409	3/8"Dr 6pt Deep Metric Socket 24mm	61	●	804090
80482	3/8"Dr 12pt Standard Metric Socket 6mm	60	●	804823
80483	3/8"Dr 12pt Standard Metric Socket 7mm	60	●	804830
80484	3/8"Dr 12pt Standard Metric Socket 8mm	60	●	804847
80485	3/8"Dr 12pt Standard Metric Socket 9mm	60	●	804854
80486	3/8"Dr 12pt Standard Metric Socket 10mm	60	●	804861
80487	3/8"Dr 12pt Standard Metric Socket 11mm	60	●	804878
80488	3/8"Dr 12pt Standard Metric Socket 12mm	60	●	804885
80489	3/8"Dr 12pt Standard Metric Socket 13mm	60	●	804892
80490	3/8"Dr 12pt Standard Metric Socket 14mm	60	●	804908
80491	3/8"Dr 12pt Standard Metric Socket 15mm	60	●	804915
80492	3/8"Dr 12pt Standard Metric Socket 16mm	60	●	804922
80493	3/8"Dr 12pt Standard Metric Socket 17mm	60	●	804939
80494	3/8"Dr 12pt Standard Metric Socket 18mm	60	●	804946
80495	3/8"Dr 12pt Standard Metric Socket 19mm	60	●	804953
80496	3/8"Dr 12pt Standard SAE Socket 1/4"	60	●	804960
80497D	3/8"Dr 12pt Standard SAE Socket 5/16"	60	●	804977
80498	3/8"Dr 12pt Standard SAE Socket 3/8"	60	●	804984
80499	3/8"Dr 12pt Standard SAE Socket 7/16"	60	●	804991
80500D	3/8"Dr 12pt Standard SAE Socket 1/2"	60	●	805004
80501	3/8"Dr 12pt Standard SAE Socket 9/16"	60	●	805011
80502	3/8"Dr 12pt Standard SAE Socket 5/8"	60	●	805028
80503	3/8"Dr 12pt Standard SAE Socket 11/16"	60	●	805035

Material No.	Description	Page No.	Barcode Prefix	
			■ 082171 □ 037103 ● 099575 ▲ 09337103	
80504	3/8"Dr 12pt Standard SAE Socket 3/4"	60	●	805042
80505	3/8"Dr 12pt Standard SAE Socket 13/16"	60	●	805059
80506D	3/8"Dr 12pt Standard SAE Socket 7/8"	60	●	805066
80507	3/8"Dr 12pt Standard SAE Socket 15/16"	60	●	805073
80508	3/8"Dr 12pt Standard SAE Socket 1"	60	●	805080
80549	3/8"Dr Universal Joint	57	●	805493
80550P	56 Pc 3/8" Drive 120XP™ SAE/Metric 6 Pt Std & Deep Socket Set NEW	54	●	815508
80551	57Pc 3/8"Dr 12pt Socket Set	54	●	805516
80554	14Pc 3/8"Dr 6pt Deep Metric Socket Set	59	●	805547
80555	11Pc 3/8"Dr 6pt Deep SAE Socket Set	59	●	805554
80557	21Pc 3/8"Dr SAE Socket Set	55	●	805578
80559	24Pc 3/8"Dr Metric Socket Set	55	●	805592
80560	14Pc 3/8"Dr 12pt Standard Metric Socket Set	59	●	805608
80561	13Pc 3/8"Dr SAE 12pt Socket Set	59	●	805615
80564	7Pc SAE 6Pt Flex Socket Set 3/8" Drive	55	●	805646
80565	10Pc Metric 6Pt Flex Socket Set 3/8" Drive	55	●	805653
80573	8Pc 3/8Dr MET Ball Hex Bit Socket Set-Long	78	●	805738
80574	7Pc 3/8"Dr SAE Ball Hex Bit Socket Set-Long	78	●	805745
80578	10Pc 3/8"&1/2"Dr Metric Hex Bit Socket Set	77	●	805783
80580	12Pc 3/8"Dr Metric Hex Bit Socket Set	77	●	805806
80581	12Pc 3/8"Dr SAE Hex Bit Socket Set	77	●	805813
80588	10Pc Long Torx Set T8-T50	77	●	805882
80592	3/8"Dr 6pt Deep SAE Socket 15/16"	61	●	805929
80593	3/8"Dr 6pt Deep SAE Socket 1"	61	●	805936
80596	3/8"Dr 12pt Standard Metric Socket 20mm	60	●	805967
80597	3/8"Dr 12pt Standard Metric Socket 21mm	60	●	805974
80598	3/8"Dr 12pt Standard Metric Socket 22mm	60	●	805981
80600D	1/2"Dr Universal Joint	64	●	806001
80671	1/2"Dr Impact Universal Joint	82	●	806711
80680	1/2"Dr 12pt Standard SAE Socket 1-1/2"	67	●	806803
80681	1/2"Dr 12pt Standard Metric Socket 26mm	66	●	806810
80682	1/2"Dr 12pt Standard Metric Socket 28mm	66	●	806827
80683	1/2"Dr 12pt Standard Metric Socket 29mm	66	●	806834
80687	1/2"Dr 12pt Deep SAE Socket 1-1/2"	68	●	806872
80700P	49Pc SAE/Metric 120XP™ Std & Deep Tool Set 1/2" Dr NEW	62	●	810701
80704	10Pc 1/2"Dr 6pt Deep Metric Socket Set	65	●	807046
80705	8Pc 1/2"Dr 6pt Deep SAE Socket Set	65	●	807053
80709	28Pc 1/2"Dr Metric Socket Set	62	●	807091
80710D	13Pc 1/2"Dr 12pt Standard Metric Socket Set	65	●	807107
80711	11Pc 1/2"Dr 12pt Standard SAE Socket Set	65	●	807114
80712	10Pc 1/2"Dr 12pt Deep Metric Socket Set	65	●	807121
80723	13Pc Torx Press Fit (2pc) Bit Socket Set	77	●	807237
80745	1/2"Dr 12pt Standard Metric Socket 10mm	66	●	807459
80746	1/2"Dr 12pt Standard Metric Socket 11mm	66	●	807466
80747	1/2"Dr 12pt Standard Metric Socket 12mm	66	●	807473
80748D	1/2"Dr 12pt Standard Metric Socket 13mm	66	●	807480
80749	1/2"Dr 12pt Standard Metric Socket 14mm	66	●	807497
80750	1/2"Dr 12pt Standard Metric Socket 15mm	66	●	807503
80751	1/2"Dr 12pt Standard Metric Socket 16mm	66	●	807510
80752	1/2"Dr 12pt Standard Metric Socket 17mm	66	●	807527
80753	1/2"Dr 12pt Standard Metric Socket 18mm	66	●	807534
80754	1/2"Dr 12pt Standard Metric Socket 19mm	66	●	807541
80755D	1/2"Dr 12pt Standard Metric Socket 20mm	66	●	807558
80756	1/2"Dr 12pt Standard Metric Socket 21mm	66	●	807565
80757	1/2"Dr 12pt Standard Metric Socket 22mm	66	●	807572
80758	1/2"Dr 12pt Standard Metric Socket 23mm	66	●	807589
80759	1/2"Dr 12pt Standard Metric Socket 24mm	66	●	807596
80760	1/2"Dr 12pt Standard SAE Socket 7/16"	67	●	807602
80761	1/2"Dr 12pt Standard SAE Socket 1/2"	67	●	807619
80762	1/2"Dr 12pt Standard SAE Socket 9/16"	67	●	807626
80763	1/2"Dr 12pt Standard SAE Socket 5/8"	67	●	807633
80764	1/2"Dr 12pt Standard SAE Socket 11/16"	67	●	807640

Material No.	Description	Page No.	Barcode Prefix	
			■ 082171	□ 037103
80765	1/2"Dr 12pt Standard SAE Socket 3/4"	67	●	807657
80766	1/2"Dr 12pt Standard SAE Socket 13/16"	67	●	807664
80767	1/2"Dr 12pt Standard SAE Socket 7/8"	67	●	807671
80768	1/2"Dr 12pt Standard SAE Socket 15/16"	67	●	807688
80769	1/2"Dr 12pt Standard SAE Socket 1"	67	●	807695
80770	1/2"Dr 12pt Standard SAE Socket 1-1/16"	67	●	807701
80771	1/2"Dr 12pt Standard SAE Socket 1-1/8"	67	●	807718
80772	1/2"Dr 12pt Deep SAE Socket 7/16"	68	●	807725
80773	1/2"Dr 12pt Deep SAE Socket 1/2"	68	●	807732
80774	1/2"Dr 12pt Deep SAE Socket 9/16"	68	●	807749
80775	1/2"Dr 12pt Deep SAE Socket 5/8"	68	●	807756
80776	1/2"Dr 12pt Deep SAE Socket 11/16"	68	●	807763
80777D	1/2"Dr 12pt Deep SAE Socket 3/4"	68	●	807770
80778	1/2"Dr 12pt Deep SAE Socket 13/16"	68	●	807787
80779	1/2"Dr 12pt Deep SAE Socket 7/8"	68	●	807794
80780	1/2"Dr 12pt Deep SAE Socket 15/16"	68	●	807800
80781	1/2"Dr 12pt Deep Metric Socket 10mm	68	●	807817
80782	1/2"Dr 12pt Deep Metric Socket 11mm	68	●	807824
80783	1/2"Dr 12pt Deep Metric Socket 12mm	68	●	807831
80784	1/2"Dr 12pt Deep Metric Socket 13mm	68	●	807848
80785	1/2"Dr 12pt Deep Metric Socket 14mm	68	●	807855
80786	1/2"Dr 12pt Deep Metric Socket 15mm	68	●	807862
80787	1/2"Dr 12pt Deep Metric Socket 16mm	68	●	807879
80788	1/2"Dr 12pt Deep Metric Socket 17mm	68	●	807886
80789	1/2"Dr 12pt Deep Metric Socket 18mm	68	●	807893
80790	1/2"Dr 12pt Deep Metric Socket 19mm	68	●	807909
80793	1/2"Dr 12pt Standard Socket 1-3/16"	67	●	807930
80794	1/2"Dr 12pt Standard Socket 1-1/4"	67	●	807947
80795	1/2"Dr 12pt Deep Socket 1"	68	●	807954
80796	1/2"Dr 12pt Deep Socket 1-1/16"	68	●	807961
80797	1/2"Dr 12pt Deep Socket 1-1/8"	68	●	807978
80798	1/2"Dr 12pt Deep Socket 1-1/4"	68	●	807985
80805	1/2"Dr 12pt Standard Socket 8mm	66	●	808050
80806	1/2"Dr 12pt Standard Socket 9mm	66	●	808067
80811	1/2"Dr 12pt Standard Socket 25mm	66	●	808111
80812	1/2"Dr 12pt Standard Socket 27mm	66	●	808128
80813	1/2"Dr 12pt Standard Socket 30mm	66	●	808135
80814D	1/2"Dr 12pt Standard Socket 32mm	66	●	808142
80815D	1/2"Dr 12pt Standard Socket 36mm	66	●	808159
80817D	1/2"Dr 12pt Deep Metric Socket 20mm	68	●	808173
80818	1/2"Dr 12pt Deep Metric Socket 21mm	68	●	808180
80820	1/2"Dr 12pt Deep Metric Socket 22mm	68	●	808203
80822	1/2"Dr 12pt Deep Metric Socket 24mm	68	●	808227
80824	1/2"Dr 12pt Deep Metric Socket 27mm	68	●	808241
80826	1/2"Dr 12pt Deep Metric Socket 30mm	68	●	808265
80827	1/2"Dr 12pt Deep Metric Socket 32mm	68	●	808272
80830	3/4"Dr 12pt Standard Socket 7/8"	71	●	808302
80831	3/4"Dr 12pt Standard Socket 15/16"	71	●	808319
80833	3/4"Dr 12pt Standard Socket 1"	71	●	808333
80834	3/4"Dr 12pt Standard Socket 1-1/16"	71	●	808340
80835D	3/4"Dr 12pt Standard Socket 1-1/8"	71	●	808357
80838	3/4"Dr 12pt Standard Socket 1-3/16"	71	●	808388
80839	3/4"Dr 12pt Standard Socket 1-1/4"	71	●	808395
80840	3/4"Dr 12pt Standard Socket 1-5/16"	71	●	808401
80841	3/4"Dr 12pt Standard Socket 1-3/8"	71	●	808418
80852	3/4"Dr 12pt Standard Socket 1-7/16"	71	●	808524
80854	3/4"Dr 12pt Standard Socket 1-1/2"	71	●	808548
80855D	3/4"Dr 12pt Standard Socket 1-5/8"	71	●	808555
80856	3/4"Dr 12pt Standard Socket 1-11/16"	71	●	808562
80857	3/4"Dr 12pt Standard Socket 1-3/4"	71	●	808579
80859	3/4"Dr 12pt Standard Socket 1-13/16"	71	●	808593
80860	3/4"Dr 12pt Standard Socket 1-7/8"	71	●	808609
80861	3/4"Dr 12pt Standard Socket 2"	71	●	808616
80862	3/4"Dr 12pt Standard Socket 2-1/8"	71	●	808623

Material No.	Description	Page No.	Barcode Prefix	
			■ 082171	□ 037103
80863	3/4"Dr 12pt Standard Socket 2-3/16"	71	●	808630
80864	3/4"Dr 12pt Standard Socket 2-1/4"	71	●	808647
80865	3/4"Dr 12pt Standard Socket 2-3/8"	71	●	808654
80879	13Pc 3/4"Dr SAE 12pt Standard Socket Set	69	●	808791
80880	27Pc 3/4"Dr SAE 12pt Standard Socket Set	69	●	808807
80930	88Pc 1/4&3/8"Dr 6pt&12pt Socket SAE/Metric 42	42	●	809309
80931	141Pc 1/4&3/8&1/2"Dr 6pt&12pt Socket SAE/Metric 43	42	●	809316
80932	165Pc 1/4&3/8&1/2"Dr 6pt&12pt Socket SAE/Metric 41	42	●	809323
80933	216Pc 1/4&3/8&1/2"Dr 6pt&13pt Socket SAE/Metric 40	42	●	809330
80934	239Pc 1/4&3/8&1/2"Dr 6pt & 13pt Sockets SAE/Metric 39	42	●	809347
80975	Hi Tension Hacksaw 4in1 NEW	169	□	809759
81007F	1/4"Dr Ratcheting w/Cushion Grip	49	●	811074
81009F	1/4"Dr Flex Ratcheting w/Cushion Grip	49	●	811098
81011F	1/4"Dr Full Polish Teardrop Ratchet	49	●	811111
81011P	Ratcheting Teardrop 120XP , FP, 1/4" Dr	49	●	810176
81012P	Ratcheting Flex Teardrop 120XP , FP, 1/4" Dr	49	●	808128
81013	1/4"Dr Flex Handle 5-1/2"	50	●	810138
81014	1/4"Dr Quick-Release Ratcheting Handle-L5	49	●	810145
81027	1/4" Drive Gimbal Ratcheting NEW	50	●	810275
81101	1/4"Dr Extension 2"	50	●	811012
81116	1/4"Dr Extension 6"	50	●	811166
81117D	1/4"Dr Extension 10"	50	●	811173
81118	1/4"Dr Extension 14"	50	●	811180
81119	1/4"Dr Wobble Extension 2"	50	●	811197
81121	1/4"Dr Wobble Extension 6"	50	●	811210
81126	1/4"Dr Locking Extension 6"	50	●	811265
81127	1/4" f x 3/8" m Dr Adapter	50	●	811272
81128	1/4"Dr Spinner Handle	50	●	811289
81202	3Pc 3/8"Dr Locking Extension Set	58	●	812026
81205	10Pc Universal and Adapter Set	46	●	812057
81206P	3Pc 120XP Ratcheting Wrench Set, 1/4", 3/8", 1/2"	46, 49, 56, 63	●	816024
81208F	3/8"Dr Cushion Grip Teardrop Ratchet	57	●	811081
81209F	3/8"Dr Stubby Ratchet	56	●	821196
81210F	3/8" Dr Cushion Grip Flex Teardrop Ratchet	57	●	811104
81211F	3/8"Dr Full Polish Teardrop Ratchet	56	●	810008
81211P	3/8" Dr 120XP Teardrop Ratchet	56	●	822223
81212F	3/8" Dr Stubby Flex Teardrop Ratchet	57	●	811029
81213F	3/8"Dr Cushion Grip Offset Flex Ratchet	57	●	831119
81215P	3/8" Dr 120XP Flex Teardrop Ratchet	56	●	012150
81217	4Pc Adapter Set	46	●	812170
81218	3/8"Dr Quick-Release Ratcheting Handle-L5	56	●	812187
81221	3/8"DrFlex FP Handle 12"	57	●	812217
81224	1/4"Dr Roto Ratcheting Set	50	●	812248
81225	3/8"Dr Roto Ratchet Set	57	●	812255
81230P	4 Pc 1/4, 3/8, and 1/2 Drive 120XP™ Full Polish Flex Handle Ratcheting Set	49, 56, 63	●	012303
81239	3/8"Dr Speeder Handle 16"	58	●	812392
81240	3/8"Dr Extension 1-1/2"	58	●	812408
81241	3/8"Dr Extension 3"	58	●	812415
81242	3/8"Dr Extension 6"	58	●	812422
81243	3/8"Dr Extension 10"	58	●	812439
81244	3/8"Dr Extension 12"	58	●	812446
81246	3/8"Dr Wobble Extension 3"	58	●	812460
81247	3/8"Dr Wobble Extension 6"	58	●	812477
81248	3/8"Dr Wobble Extension 10"	58	●	812484
81249	3/8"Dr Wobble Extension 12"	58	●	812491
81270	3/8" Drive Gimbal Ratcheting NEW	56	●	817205
81277	3/8"Fx1/4"M Dr Adapter	58	●	812774
81278	3/8"Fx1/2"M Dr Adapter	58	●	812781
81303F	1/2"Dr Ratcheting w/Cushion Grip	63	●	830136
81304F	1/2"Dr Full Polish Teardrop Ratchet	63	●	813146
81304P	1/2" Dr Full Polish 120XP Teardrop Ratchet	63	●	830402
81306F	1/2"Dr Full Polish Flex Ratcheting Handle	63	●	813160

Material No.	Description	Page No.	Barcode Prefix	
			082171	037103
81306P	1/2" Dr 120XP Flex Head Teardrop Ratcheting	63	●	003066
81308D	1/2"Dr Flex Handle 24"	64	●	813085
81307	1/2"Dr Flex Handle 15"	64	●	813078
81309	1/2"Dr Quick-Release Ratcheting Handle 15	63	●	813092
81311	1/2"Dr Sliding T Handle 15"	64	●	813115
81312	1/2"Dr Speeder Handle 16"	64	●	813122
81340	1/2"Dr Extension 3"	64	●	813405
81341	1/2"Dr Extension 5"	64	●	813412
81342	1/2"Dr Extension 10"	64	●	813429
81343	1/2"Dr Extension 15"	64	●	813436
81345	1/2"Dr Wobble Extension 5"	64	●	813450
81346	1/2"Dr Wobble Extension 10"	64	●	813467
81354	1/2"fx3/8"m Dr Adapter	64	●	813542
81355	1/2"fx3/4"m Dr Adapter	64	●	813559
81400	3/4"Dr Teardrop Ratcheting 19-3/4"	70	●	814006
81401	3/4"Dr Sliding T Handle 18"	70	●	814013
81404	3/4"Dr Flex Handle 19"	70	●	814044
81412	3/4"Dr Extension 8"	70	●	814129
81413	3/4"Dr Extension 16"	70	●	814136
81650	XL Combination Non-Ratcheting Wrench 1/4"	119	●	816505
81651D	XL Combination Non-Ratcheting Wrench 9/32"	119	●	816512
81652D	XL Combination Non-Ratcheting Wrench 5/16"	119	●	816529
81653	XL Combination Non-Ratcheting Wrench 11/32"	119	●	816536
81654	XL Combination Non-Ratcheting Wrench 3/8"	119	●	816543
81655	XL Combination Non-Ratcheting Wrench 7/16"	119	●	816550
81656	XL Combination Non-Ratcheting Wrench 1/2"	119	●	816567
81657	XL Combination Non-Ratcheting Wrench 9/16"	119	●	816574
81658	XL Combination Non-Ratcheting Wrench 5/8"	119	●	816581
81659	XL Combination Non-Ratcheting Wrench 11/16"	119	●	816598
81660	XL Combination Non-Ratcheting Wrench 3/4"	119	●	816604
81661	XL Combination Non-Ratcheting Wrench 13/16"	119	●	816611
81662	XL Combination Non-Ratcheting Wrench 7/8"	119	●	816628
81663	XL Combination Non-Ratcheting Wrench 15/16"	119	●	816635
81664	XL Combination Non-Ratcheting Wrench 1"	119	●	816642
81665	XL Combination Non-Ratcheting Wrench 8mm	118	●	816659
81666	XL Combination Non-Ratcheting Wrench 9mm	118	●	816666
81667	XL Combination Non-Ratcheting Wrench 10mm	118	●	816673
81668	XL Combination Non-Ratcheting Wrench 11mm	118	●	816680
81669	XL Combination Non-Ratcheting Wrench 12mm	118	●	816697
81670	XL Combination Non-Ratcheting Wrench 13mm	118	●	816703
81671	XL Combination Non-Ratcheting Wrench 14mm	118	●	816710
81672	XL Combination Non-Ratcheting Wrench 15mm	118	●	816727
81673	XL Combination Non-Ratcheting Wrench 16mm	118	●	816734
81674	XL Combination Non-Ratcheting Wrench 17mm	118	●	816741
81675	XL Combination Non-Ratcheting Wrench 18mm	118	●	816758
81676	XL Combination Non-Ratcheting Wrench 19mm	118	●	816765
81677	XL Combination Non-Ratcheting Wrench 20mm	118	●	816772
81678	XL Combination Non-Ratcheting Wrench 21mm	118	●	816789
81679	XL Combination Non-Ratcheting Wrench 22mm	118	●	816796
81733	XL Combination Non-Ratcheting Wrench 1-1/16"	119	●	817335
81734	XL Combination Non-Ratcheting Wrench 1-1/8"	119	●	817342
81735	XL Combination Non-Ratcheting Wrench 1-1/4"	119	●	817359
81736	XL Combination Non-Ratcheting Wrench 6mm	118	●	817366
81737	XL Combination Non-Ratcheting Wrench 7mm	118	●	817373
81741	XL Combination Non-Ratcheting Wrench 23mm	118	●	817410
81742	XL Combination Non-Ratcheting Wrench 24mm	118	●	817427
81743	XL Combination Non-Ratcheting Wrench 27mm	118	●	817434
81744	XL Combination Non-Ratcheting Wrench 30mm	118	●	817441
81745D	XL Combination Non-Ratcheting Wrench 32mm	118	●	817458
81749	XL Combination Non-Ratcheting Wrench 1-5/16"	119	●	817496
81750	XL Combination Non-Ratcheting Wrench 1-1/2"	119	●	817502
81751	XL Combination Non-Ratcheting Wrench 25mm	118	●	817519
81752	XL Combination Non-Ratcheting Wrench 26mm	118	●	817526
81753	XL Combination Non-Ratcheting Wrench 28mm	118	●	817533

Material No.	Description	Page No.	Barcode Prefix	
			082171	037103
81782	Deep Offset Dble Box Non-Ratchet Wrench 8x10mm	123	●	817823
81783	Deep Offset Dble Box Non-Ratchet Wrench 10x12mm	123	●	817830
81784	Deep Offset Dble Box Non-Ratchet Wrench 11x13mm	123	●	817847
81785	Deep Offset Dble Box Non-Ratchet Wrench 12x14mm	123	●	817854
81786	Deep Offset Dble Box Non-Ratchet Wrenc 17x19mm	123	●	817861
81900	24Pc Comb Non-Ratcheting Wrench Set SAE/Metric	121	●	819001
81901	15Pc Long Pattern Comb Non-Ratch Wrench Set SAE	120	●	819018
81902	15Pc XL Comb Non-Ratcheting Wrench Set Metric	119	●	819025
81904	10Pc Stubby Comb Non-Ratch Wrench Set Metric	124	●	819049
81905	10Pc Stubby Comb Non-Ratcheting Wrench Set SAE	124	●	819056
81908	11Pc Crowfoot Non-Ratcheting Wrench Set SAE	125	●	819087
81909	10Pc Crowfoot Non-Ratcheting Wrench Set Metric	125	●	819094
81910	5Pc Flex Flare Nut Non-Ratcheting Wrench Set SAE	124	●	819100
81911D	6 Pc Metric Flex Flare Nut Non-Ratcheting Wrench Set	124	●	819117
81917	18Pc XL Comb Non-Ratcheting Wrench Set SAE (Roll)	121	●	819179
81920	18Pc XL Combo Non-Ratch Wrench Set Metric (Roll)	120	●	819209
81924	14Pc Combination Non-Ratcheting Wrench Set SAE	122	●	819247
81925	14Pc Combination Non-Ratcheting Wrench Set Metric	122	●	819254
81927	5Pc Deep Offset Box Non-Ratcheting Wrench Set Metric (Roll)	123	●	819278
81928	6Pc Open End Non-Ratchet Wrench Set Metric (Roll)	123	●	819285
81929	7Pc Open End Non-Ratcheting Wrench Set SAE (Roll)	123	●	819292
81931	4Pc Comb Non-Ratcheting Wrench Set METRIC/SAE	122	▲	011307
82005D	Double X Long Nose Pliers	139	●	820151
82006D	Double X Bent Nose Pliers	139	●	820168
82007	Double X Duck Bill Pliers	139	●	820175
82017	Double X Hose Grip Pliers 5/16" (8 mm)	139	●	821073
82018	Double X Hose Grip Pliers 1/2" (13 mm)	139	●	820182
82019	Double X Hose Grip Pliers 3/4" (19 mm)	139	●	820199
82032	Double X Internal Snap Ring Pliers	140	●	820328
82033	Double X External Snap Ring Pliers	140	●	820335
82034	Double X Straight Hemostat Pliers	140	●	820342
82035	Double X 45 Degree Hemostat Pliers	140	●	820359
82100	5Pc Mini Pliers Set	138	●	821004
82103	4Pc Standard Plier Set	138	●	821035
82106	2Pc Double X Plier Set	139	●	821165
82108	7Pc Mixed Pliers Set	138	●	821080
82120	8" Pivoforce™ Diag Cutting Compound Plier NEW	141	●	821202
82121	8" Pivoforce™ Long Nose Compound Plier NEW	141	●	821219
82124	2 Pc Pivoforce™ Compound Action Plier Set NEW	141	●	822421
82136	7" Forged External Snap Ring Pliers - Straight NEW	141, 164	●	821363
82137	7" Forged External Snap Ring Pliers - 90 Degree NEW	141, 164	●	821370
82139	7" Forged Internal Snap Ring Pliers - Straight NEW	141, 164	●	813290
82140	7" Forged Internal Snap Ring Pliers - 90 Degree NEW	141, 164	●	814204
82150	4 Pc 7" Fixed Tip Internal & External Snap Ring Plier Set NEW	141, 164	●	824500
82208	8" Indexing Pry Bar	144	●	822087
82210	10" Indexing Pry Bar	144	●	822100
82216	16" Indexing Pry Bar	144	●	822162
82220	Extensionable Indexing Pry Bar	144	●	822209
82224	24" Indexing Pry Bar w/Single Joint	144	●	822247
82233	33" Pry Bar Indexing NEW	144	●	822339
82240	18 Oz. Dead Blow Hammer - Polyurethane Head NEW	148	●	822407
82242	33 Oz. Dead Blow Hammer - Polyurethane Head NEW	148	●	842221
82244	54 Oz. Dead Blow Hammer - Polyurethane Head NEW	148	●	822445
82248	48" Extendable Indexing Pry Bar	144	●	822483
82250	8 oz Ball Pein Hammer - Fiberglass NEW	148	●	822506
82251	16 oz Ball Pein Hammer - Fiberglass NEW	148	●	822513
82252	24 oz Ball Pein Hammer - Fiberglass NEW	148	●	822520
82253	32 oz Ball Pein Hammer - Fiberglass NEW	148	●	822537
82255	3 lb Drilling Hammer NEW	148	●	822551

Material No.	Description	Page No.	Barcode Prefix	
			■ 082171 □ 037103 ● 099575 ▲ 09337103	
82256	16 oz Dead Blow Hammer - Composite Handle NEW	148	●	822568
82258	48 oz Dead Blow Hammer - Composite Handle NEW	148	●	822582
82300	2Pc Pry Bar Set	144	●	823008
82304	5Pc Punch and Chisel Set	147	●	823046
82305	12 Pc Punch and Chisel Set NEW	147	●	823053
82307	4Pc Long Taper Punch Set	147	●	823077
82308	4Pc Cold Chisel Set	147	●	823084
82309	5Pc Pin Punch Set	147	●	823091
82403	3 Pc Pry Bar Set 12", 17", 25" NEW	144	●	824036
82408	8" x 1/4" Pry Bar with Angled Tip NEW	144	●	824081
82412	12" x 3/8" Pry Bar with Angled Tip NEW	144	●	824128
82417	17" x 3/8" Pry Bar with Angled Tip NEW	144	●	824173
82425	25" x 1/2" Pry Bar with Angled Tip NEW	144	●	824258
82431	31" x 1/2" Pry Bar with Angled Tip NEW	144	●	824319
82436	36" x 1/2" Pry Bar with Angled Tip NEW	144	●	824364
82764	7Pc Metric Nut Teardrop Driver Set, Hollow Shaft	135	●	827648
82765	7Pc SAE Nut Driver Set, Hollow Shaft	135	●	827655
82805D	2Pc 3/8"Dr Ext Adapter Set	152	●	828058
82820	4Pc Standard File Set NEW	35, 163	●	828201
83000	68Pc 1/4"&3/8"Dr SAE/Metric Socket Set	45	●	830006
83001D	118Pc 1/4"&3/8"&1/2"Dr 6 & 12 Pt. Socket SAE/Metric	44	●	830013
83050	42Pc Socket Set, 1/4" + 3/8", Metric & SAE	34	▲	007287
83052	10Pc Wrench Set, Ratcheting, Metric	32, 96	▲	007300
83053	10Pc Wrench Set, Ratcheting, SAE	32, 96	▲	007317
83056	10Pc Wrench Set, Open End, Ratcheting, Metric	32, 101	▲	007348
83057	42Pc Socket Set, 3/8", Metric & SAE	34	▲	007355
83058	23Pc Socket Set, 1/2", Metric	34, 62	▲	007362
83060	31Pc, Socket Set, 1/4" + 8 Wrenches	35, 48	▲	007379
83062	34Pc Socket Set, 1/2" + 11 Rev Ratch Wrenches	35	▲	007393
83071	90Pc Socket Set, 1/4", 3/8", 1/2" Metric & SAE	33	▲	007232
83072	12Pc Plier Set	32, 138	▲	007249
83073	52Pc Screwdriver Set	33, 133	▲	007256
83075	24Pc Ratcheting Wrench Tray Set	33, 96	▲	007065
83090T	Auto Introductory Tool Set SAE/Metric	11	▲	011215
83091T	Career Builder Starter TEP Set	12	▲	011222
83092T	Career Builder Diesel Set	13	▲	011239
83093T	Career Builder Auto Body Set	13	▲	011246
83094T	Career Builder HVAC Add On	14	▲	011253
83095T	Intermediate Auto TEP Set	15	▲	011260
83096T	Intermediate Diesel TEP Set	16	▲	011277
83097T	Intermediate Auto Body TEP Set	17	▲	011284
83098T	Intermediate Aviation Tool Set	18	▲	011291
83101D	3/8"Dr Slide Socket Rail	167	●	831010
83102	1/2"Dr Slide Socket Rail	167	●	831027
83103	3Pc Socket Rack Sets	167	●	831034
83104	Universal Magnetic Parts Tray -Circular	163	●	831041
83105	1/4" Dr Slide Socket Rail	167	●	831058
83130	19" Tote Box	25	●	831300
83132	Flashlight Aluminum	155	●	831324
83133	LED Light NEW	155	▲	011406
83140	Technicians Tool Bag 32 Pocket, Shoulder Strap	26	▲	007997
83141	23 Pocket Wide Mouth Tool Bag Large NEW	26	▲	010508
83142	23 Pocket Wide Mouth Tool Bag Medium NEW	26	▲	010515
83143	Open Tote Bag NEW	26	▲	010522
83144	Bucket Style Tool Bag NEW	26	▲	010539
83145	Utility Tool Bag	26	▲	010546
83147	16" Tool Bag	26	●	831478
83148	Plastic Tool Box	27	●	831485
83151	3 Drawer Tool Box	25	●	831515
83154	26" 4 Drawer Top Chest	23	●	831546
83155	26" 7 Drawer Roller Cabinet	23	●	831553

Material No.	Description	Page No.	Barcode Prefix	
			■ 082171 □ 037103 ● 099575 ▲ 09337103	
83156	42" 8 Drawer Top Chest	24	●	831560
83157	42" 11 Drawer Roller Cabinet	24	●	831577
83158	53" 9 Drawer Roller Cabinet	25	●	831584
83159	Deep Tool Chest (660 x 450 x 437)	23	▲	007102
83160	53" 8 Drawer Tool Chest	25	▲	008185
83164	27" 4 Drawer Top Chest A Series NEW	24	▲	011130
83165	27" 7 Drawer Roller Cabinet A Series NEW	24	▲	011147
83170	91Pc Combination Tool Set + Chest	29	▲	007942
83171	189Pc Combination Tool Set + Chest	29	▲	007959
83172	239Pc Combination Tool Set, Chest + Trolley	30	▲	007966
83173	179 Pc Combination Tool Set + Chest NEW	31	▲	008147
83174	195 Pc Combination Tool Set withChest + Trolley NEW	31	▲	008154
84000D	7 Pc Hook & Pick Set NEW	159	●	840005
84040	4Pc Mini Hook & Pick Set NEW	159	●	840401
84060	4Pc Door Panel Kit NEW	159	●	840609
84070	2Pc Scraper Set NEW	159	●	840708
84080	4Pc Scraper Set NEW	159	●	840807
84086	Round Telescoping Mirror 2-1/4" DIA NEW	163	●	840869
84087	Round LED Lighted Mirror 2-3/8" DIA NEW	163	●	840876
84088	Telescoping Magnetic Pickup Tool NEW	162	●	840883
84500D	1/2"Dr Impact Socket 3/8"	83	●	845000
84501	1/2"Dr Impact Socket 7/16"	83	●	845017
84502	1/2"Dr Impact Socket 1/2"	83	●	845024
84503	1/2"Dr Impact Socket 9/16"	83	●	845031
84504D	1/2"Dr Impact Socket 5/8"	83	●	845048
84505D	1/2"Dr Impact Socket 11/16"	83	●	845055
84506D	1/2"Dr Impact Socket 3/4"	83	●	845062
84507D	1/2"Dr Impact Socket 13/16"	83	●	845079
84508D	1/2"Dr Impact Socket 7/8"	83	●	845086
84509D	1/2"Dr Impact Socket 15/16"	83	●	845093
84510D	1/2"Dr Impact Socket 1"	83	●	845109
84511D	1/2"Dr Impact Socket 1-1/16"	83	●	845116
84512D	1/2"Dr Impact Socket 1-1/8"	83	●	845123
84513D	1/2"Dr Impact Socket 1-3/16"	83	●	845130
84514D	1/2"Dr Impact Socket 1-1/4"	83	●	845147
84515D	1/2"Dr Impact Socket 1-5/16"	83	●	845154
84516D	1/2"Dr Impact Socket 1-3/8"	83	●	845161
84517D	1/2"Dr Impact Socket 1-7/16"	83	●	845178
84518D	1/2"Dr Impact Socket 1-1/2"	83	●	845185
84520	1/2"Dr Impact Socket 8mm	83	●	845208
84521D	1/2"Dr Impact Socket 9mm	83	●	845215
84522D	1/2"Dr Impact Socket 10mm	83	●	845222
84523D	1/2"Dr Impact Socket 11mm	83	●	845239
84524D	1/2"Dr Impact Socket 12mm	83	●	845246
84525D	1/2"Dr Impact Socket 13mm	83	●	845253
84526D	1/2"Dr Impact Socket 14mm	83	●	845260
84527D	1/2"Dr Impact Socket 15mm	83	●	845277
84528D	1/2"Dr Impact Socket 16mm	83	●	845284
84529D	1/2"Dr Impact Socket 17mm	83	●	845291
84530D	1/2"Dr Impact Socket 18mm	83	●	845307
84531	1/2"Dr Impact Socket 19mm	83	●	845314
84532	1/2"Dr Impact Socket 20mm	83	●	845321
84533	1/2"Dr Impact Socket 21mm	83	●	845338
84534	1/2"Dr Impact Socket 22mm	83	●	845345
84535	1/2"Dr Impact Socket 23mm	83	●	845352
84536	1/2"Dr Impact Socket 24mm	83	●	845369
84537	1/2"Dr Impact Socket 25mm	83	●	845376
84538	1/2"Dr Impact Socket 26mm	83	●	845383
84539	1/2"Dr Impact Socket 28mm	83	●	845390
84540	1/2"Dr Impact Socket 29mm	83	●	845406
84541	1/2"Dr Impact Socket 30mm	83	●	845413
84542	1/2"Dr Impact Socket 31mm	83	●	845420
84543	1/2"Dr Impact Socket 32mm	83	●	845437

Material No.	Description	Page No.	Barcode Prefix	
			082171	037103
84544	1/2"Dr Impact Socket 36mm	83	●	845444
84546	1/2"Dr Deep Impact Socket 3/8"	85	●	845468
84547	1/2"Dr Deep Impact Socket 7/16"	85	●	845475
84548	1/2"Dr Deep Impact Socket 1/2"	85	●	845482
84549	1/2"Dr Deep Impact Socket 9/16"	85	●	845499
84550	1/2"Dr Deep Impact Socket 5/8"	85	●	845505
84551	1/2"Dr Deep Impact Socket 11/16"	85	●	845512
84552D	1/2"Dr Deep Impact Socket 3/4"	85	●	845529
84553	1/2"Dr Deep Impact Socket 13/16"	85	●	845536
84554D	1/2"Dr Deep Impact Socket 7/8"	85	●	845543
84555D	1/2"Dr Deep Impact Socket 15/16"	85	●	845550
84556	1/2"Dr Deep Impact Socket 1"	85	●	845567
84557	1/2"Dr Deep Impact Socket 1-1/16"	85	●	845574
84558	1/2"Dr Deep Impact Socket 1-1/8"	85	●	845581
84560	1/2"Dr Deep Impact Socket 1-1/4"	85	●	845604
84571	1/2"Dr Deep Impact Socket 13mm	84	●	845710
84572	1/2"Dr Deep Impact Socket 14mm	84	●	845727
84573	1/2"Dr Deep Impact Socket 15mm	84	●	845734
84574	1/2"Dr Deep Impact Socket 16mm	84	●	845741
84575D	1/2"Dr Deep Impact Socket 17mm	84	●	845758
84576D	1/2"Dr Deep Impact Socket 18mm	84	●	845765
84577	1/2"Dr Deep Impact Socket 19mm	84	●	845772
84578	1/2"Dr Deep Impact Socket 20mm	84	●	845789
84579	1/2"Dr Deep Impact Socket 21mm	84	●	845796
84580	1/2"Dr Deep Impact Socket 22mm	84	●	845802
84581	1/2"Dr Deep Impact Socket 23mm	84	●	845819
84582	1/2"Dr Deep Impact Socket 24mm	84	●	845826
84583	1/2"Dr Deep Impact Socket 25mm	84	●	845833
84584	1/2"Dr Deep Impact Socket 26mm	84	●	845840
84585D	1/2"Dr Deep Impact Socket 27mm	84	●	845857
84586D	1/2"Dr Deep Impact Socket 28mm	84	●	845864
84587	1/2"Dr Deep Impact Socket 29mm	84	●	845871
84588	1/2"Dr Deep Impact Socket 30mm	84	●	845888
84589D	1/2"Dr Deep Impact Socket 31mm	84	●	845895
84590D	1/2"Dr Deep Impact Socket 32mm	84	●	845901
84643	1/2"Dr Impact Adapter 1/2fx3/8m	82	●	846434
84644	1/2"Dr Impact Extension Bar 10"	82	●	846441
84646	1/2"Dr Impact Extension Bar 5"	82	●	846465
84930	12Pc 1/2"Dr Impact Socket Set Metric	81	●	849305
84931	12Pc 1/2"Dr Impact Socket Set SAE	81	●	849312
84942	12pc1/2 Drive SAE Deep	81	●	849428
84944	12Pc 1/2 Drive Metric Deep	81	●	849442
84946	3 Pc Metric Impact Socket Set NEW	81, 163	●	849466
85035	35Pc GearWrench MicroDriver Set	46	■	850356
85050	1/4" Dr Micrometer Torque Wrench (30 - 200 in./lbs.)	128	■	850509
85051	3/8" Dr Micrometer Torque Wrench(25 - 250 in./lbs.)	128	■	850516
85053	1/2" Dr Micrometer Torque Wrench(20 - 150 ft./lbs.)	129	■	850530
85055	3/4" Dr Micrometer Torque Wrench (100-600ft./lbs.)	129	■	850554
85062	3/8" Micrometer Torque Wrench 10-100 ft./lbs NEW	128	●	850622
85066	1/2" Micrometer Torque Wrench 30-250 ft./lbs NEW	129	●	850660
85070	3/8" Electronic Torque Wrench(10 - 100 ft./lbs.)	128	■	850707
85071	1/2" Electronic Torque Wrench(25 - 250 ft./lbs.)	128	■	850714
85073	Electronic Flex Head Torq Wrench w/- Angle, 3/8"	128	■	850738
85074	Electronic Flex Head Torq Wrench w/- Angle, 1/2"	128	■	850745
85098	12Pc XL Combination Ratcheting Wrench Set Metric	93	■	850981
85099R	16Pc XL Comb Ratcheting Wrench Set Metric (Roll)	94	■	850929
85198	8Pc XL Combination Ratcheting Wrench Set SAE	93	■	851988
85199R	13Pc XL Comb Ratcheting Wrench Set SAE (Roll)	94	■	851919
85200	13Pc QuadBox Dble Box Ratcheting Wrench Set SAE	111	●	852008
85201	QuadBox 4in1 Wrench 5/16 x 3/8 + 7/16x1/2	110	●	852015
85202D	QuadBox 4in1 Wrench 9/16x5/8 + 11/16x3/4	110	●	852022
85203	QuadBox 4in1 Wrench 13/16x7/8+15/16x1"	110	●	852039
85204	3 Pc QuadBox™ Dble Box Ratcheting Wrench Set SAE	111	●	852046
85210D	13Pc Ratcheting Wrench Set, QuadBox, Metric	111	●	852107

Material No.	Description	Page No.	Barcode Prefix	
			082171	037103
85211	QuadBox 4in1 Wrench 8x10 + 12x13mm	110	●	852114
85212	QuadBox 4in1 Wrench 16x17 + 18x19mm	110	●	852121
85213	QuadBox 4in1 Wrench 9x11+14x15mm	110	●	852138
85214	QuadBox 4in1 Wrench 20x21+22x24mm	110	●	852145
85215	4 Pc QuadBox™ Dble Box Ratch Wrench Set Metric	111	●	852152
85299	5Pc S Type Rev Dble Box Ratch Wrench Set Metric	107	■	852992
85399	4Pc S Type Rev Dble Box Ratch Wrench Set SAE	107	■	853999
85488	12Pc Metric Indexing Combination Wrench Set	106	●	854880
85498	8Pc SAE Indexing Combination Wrench Set	106	●	854989
85508	Ratcheting Open End Wrench 8mm	100	●	855085
85509	Ratcheting Open End Wrench 9mm	100	●	855092
85510	Ratcheting Open End Wrench 10mm	100	●	855108
85511	Ratcheting Open End Wrench 11mm	100	●	855115
85512D	Ratcheting Open End Wrench 12mm	100	●	855122
85514D	Ratcheting Open End Wrench 14mm	100	●	855146
85513	Ratcheting Open End Wrench 13mm	100	●	855139
85515	Ratcheting Open End Wrench 15mm	100	●	855153
85516	Ratcheting Open End Wrench 16mm	100	●	855160
85517	Ratcheting Open End Wrench 17mm	100	●	855177
85518	Ratcheting Open End Wrench 18mm	100	●	855184
85519	Ratcheting Open End Wrench 19mm	100	●	855191
85570	Ratcheting Open End Wrench 5/16"	100	●	855702
85572	Ratcheting Open End Wrench 3/8"	100	●	855726
85574	Ratcheting Open End Wrench 7/16"	100	●	855740
85576	Ratcheting Open End Wrench 1/2"	100	●	855764
85578	Ratcheting Open End Wrench 9/16"	100	●	855788
85580	Ratcheting Open End Wrench 5/8"	100	●	855801
85582	Ratcheting Open End Wrench 11/16"	100	●	855825
85584	Ratcheting Open End Wrench 3/4"	100	●	855849
85597	12Pc Metric Ratcheting Open End Set	101	●	855979
85599	8Pc SAE Ratcheting Open End Set	101	●	855993
85608	8mm XL Locking Flex Comb Ratcheting Wrench	112	■	856082
85610	10mm XL Locking Flex Comb Ratcheting Wrench	112	■	856105
85611	11mm XL Locking Flex Comb Ratcheting Wrench	112	■	856112
85612	12mm XL Locking Flex Comb Ratcheting Wrench	112	■	856129
85613	13mm XL Locking Flex Comb Ratcheting Wrench	112	■	856136
85614	14mm XL Locking Flex Comb Ratcheting Wrench	112	■	856143
85615	15mm XL Locking Flex Comb Ratcheting Wrench	112	■	856150
85616	16mm XL Locking Flex Comb Ratcheting Wrench	112	■	856167
85617	17mm XL Locking Flex Comb Ratcheting Wrench	112	■	856174
85698R	12Pc XL Lock Flex Comb Ratch Wrench Set Metric (Roll)	113	■	856907
85798R	8Pc XL Locking Flex Comb Ratch Wrench Set SAE (Roll)	113	■	857997
85698	12Pc XL Locking Flex Comb Ratch Wrench Set Metric	112	■	856983
85798	8Pc XL Locking Flex Comb Ratcheting Wrenc Set SAE	113	■	857980
85888	12Pc XL X-Beam Comb Ratcheting Wrench Set Metric	116	■	858888
85898	9Pc XL X-Beam Comb Ratcheting Wrench Set SAE	116	■	858987
85908	Ratcheting Wrench XL GearBox Double Box 8mm	114	■	859083
85910	Ratcheting Wrench XL GearBox Double Box 10mm	114	■	859106
85911	Ratcheting Wrench XL GearBox Double Box 11mm	114	■	859113
85912	Ratcheting Wrench XL GearBox Double Box 12mm	114	■	859120
85913	Ratcheting Wrench XL GearBox Double Box 13mm	114	■	859137
85914	Ratcheting Wrench XL GearBox Double Box 14mm	114	■	859144
85915	Ratcheting Wrench XL GearBox Double Box 15mm	114	■	859151
85916	Ratcheting Wrench XL GearBox Double Box 16mm	114	■	859168
85917	Ratcheting Wrench XL GearBox Double Box 17mm	114	■	859175
85918	Ratcheting Wrench XL GearBox Double Box 18mm	114	■	859182
85919	Ratcheting Wrench XL GearBox Double Box 19mm	114	■	859199
85922	Ratcheting Wrench XL GearBox Double Box 22mm	114	■	859229
85987	5Pc XL GearBox Dble Box Ratch Wrench Set Metric	115	■	859878
85988	12Pc XL GearBox Dble Box Ratch Wrench Set Metric	115	■	859885
85998	9Pc XL GearBox Dble Box Ratchet Wrench Set SAE	115	■	859984
86126	10 Pc 120XP™ Universal Spline Metric XL Flex GearBox Ratcheting Wrench Set NEW	95, 115	●	861260
86142	10 Pc 120XP™ Universal Spline SAE XL Flex GearBox Ratcheting Wrench Set NEW	95, 116	●	861420

Material No.	Description	Page No.	Barcode Prefix	
			■ 082171	□ 037103
86229	12 Pc 120XP™ Universal Spline Metric XL Flex Combination Ratcheting Wrench Set NEW	95, 104	●	862298
86247	11Pc 120XP™ Universal Spline SAE XL Flex Combination Ratcheting Wrench Set NEW	95, 104	●	862472
86426	14 Pc 120XP™ Universal Spline Metric XL Combination Ratcheting Wrench Set NEW	94	●	864261
86450	11 Pc 120XP™ Universal Spline SAE XL Combination Ratcheting Wrench Set NEW	94	●	864506
86991	GearWrench Fender Cover	155	●	869914
89100	5Pc Ratcheting Flex Flare Nut Wrench Set SAE	108	●	891007
89101D	6Pc Ratcheting Flex Flare Nut Wrench Set Metric	108	●	891014
89118	11Pc Ratcheting Crowfoot Wrench Set SAE	108	●	891182
89119	10Pc Ratcheting Crowfoot Wrench Set Metric	108	●	891199
891226	25Pc 1/2"Dr Locking Flex GR Handle Set SAE/Metric	73	■	891229
8916D	16Pc GearDriver Nut Driver Set SAE/Metric	135	■	089169
8921	21Pc Pass-Thru, 3/8" Dr., Metric	73	■	089213
893800	3/8"Dr G/R XL Locking Flex w/L7 Handle	74	■	893803
8939	39Pc Ratcheting Screwdriver Set	134	■	089398
8946	46Pc SAE GearRatchet Set 1/4" & 3/8" Dr NEW	73	■	089466
9008	Original Ratcheting, Combination Wrench 1/4"	90	■	090080
9010D	Original Ratcheting, Combination Wrench 5/16"	90	■	090103
9011D	Original Ratcheting, Combination Wrench 11/32"	90	■	090110
9012D	Original Ratcheting, Combination Wrench 3/8"	90	■	090127
9014	Original Ratcheting, Combination Wrench 7/16"	90	■	090141
9016D	Original Ratcheting, Combination Wrench 1/2"	90	■	090165
9018D	Original Ratcheting, Combination Wrench 9/16"	90	■	090189
9020	Original Ratcheting, Combination Wrench 5/8"	90	■	090202
9022	Original Ratcheting, Combination Wrench 11/16"	90	■	090226
9024	Original Ratcheting, Combination Wrench 3/4"	90	■	090240
9026D	Original Ratcheting, Combination Wrench 13/16"	90	■	090264
9028D	Original Ratcheting, Combination Wrench 7/8"	90	■	090288
9030	Original Ratcheting, Combination Wrench 15/16"	90	■	090301
9032	Original Ratcheting, Combination Wrench 1"	90	■	090325
9034	Original Ratcheting, Combination Wrench 1-1/16"	90	■	090349
9036	Original Ratcheting, Combination Wrench 1-1/8"	90	■	090363
9038D	Original Ratcheting, Combination Wrench 1-1/4"	90	■	090387
9040	Original Ratcheting, Combination Wrench 1-7/16"	90	■	090400
9042	Original Ratcheting, Combination Wrench 1-1/2"	90	■	090424
9044	Original Ratcheting, Combination Wrench 1-9/16"	90	■	090448
9046D	Original Ratcheting, Combination Wrench 1-5/8"	90	■	090462
9048	Original Ratcheting, Combination Wrench 1-11/16"	90	■	090486
9050D	Original Ratcheting, Combination Wrench 1-3/4"	90	■	090509
9052D	Original Ratcheting, Combination Wrench 1-13/16"	90	■	090523
9054D	Original Ratcheting, Combination Wrench 1-7/8"	90	■	090547
9056D	Original Ratcheting, Combination Wrench 2"	90	■	090561
9060D	Original Ratcheting, Combination Wrench 1-5/16"	90	■	090608
9062D	Original Ratcheting, Combination Wrench 1-3/8"	90	■	090622
9080	Engineers Vice, 100mm NEW	166	▲	009830
9081	Engineers Vice, 100mm, Swivel Base NEW	166	▲	009847
9082	Engineers Vice, 150mm NEW	166	▲	009854
9106	Original Ratcheting, Combination Wrench 6mm	89	■	091063
9107	Original Ratcheting, Combination Wrench 7mm	89	■	091070
9108D	Original Ratcheting, Combination Wrench 8mm	89	■	091087
9109	Original Ratcheting, Combination Wrench 9mm	89	■	091094
9110D	Original Ratcheting, Combination Wrench 10mm	89	■	091100
9111	Original Ratcheting, Combination Wrench 11mm	89	■	091117
9112	Original Ratcheting, Combination Wrench 12mm	89	■	091124
9113D	Original Ratcheting, Combination Wrench 13mm	89	■	091131
9114D	Original Ratcheting, Combination Wrench 14mm	89	■	091148
9115D	Original Ratcheting, Combination Wrench 15mm	89	■	091155
9116D	Original Ratcheting, Combination Wrench 16mm	89	■	091162
9117D	Original Ratcheting, Combination Wrench 17mm	89	■	091179
9118D	Original Ratcheting, Combination Wrench 18mm	89	■	091186
9119	Original Ratcheting, Combination Wrench 19mm	89	■	091193

Material No.	Description	Page No.	Barcode Prefix	
			■ 082171	□ 037103
9120	Original Ratcheting, Combination Wrench 20mm	89	■	091209
9121	Original Ratcheting, Combination Wrench 21mm	89	■	091216
9122	Original Ratcheting, Combination Wrench 22mm	89	■	091223
9124	Original Ratcheting, Combination Wrench 24mm	89	■	091247
9125D	Original Ratcheting, Combination Wrench 25mm	89	■	091254
9127D	Original Ratcheting, Combination Wrench 27mm	89	■	091278
9130D	Original Ratcheting, Combination Wrench 30mm	89	■	091308
9132	Original Ratcheting, Combination Wrench 32mm	89	■	091322
9134D	Original Ratcheting, Combination Wrench 34mm	89	■	091346
9136	Original Ratcheting, Combination Wrench 36mm	89	■	091360
9141D	Original Ratcheting, Combination Wrench 41mm	89	■	091414
9146D	Original Ratcheting, Combination Wrench 46mm	89	■	091469
9150	Original Ratcheting, Combination Wrench 50mm	89	■	091506
9201D	Ratcheting Wrench Double Box 5/16" X 3/8"	109	■	092015
9202D	Ratcheting Wrench Double Box 7/16" X 1/2"	109	■	092022
9210D	Ratcheting Wrench Double Box 8mm X 9mm	109	■	092107
9211D	Ratcheting Wrench Double Box 10mm X 11mm	109	■	092114
9212D	Ratcheting Wrench Double Box 12mm X 13mm	109	■	092121
9215D	Ratcheting Wrench Double Box 17mm X 19mm	109	■	092152
9224D	4Pc E-Torx Double Box Ratcheting Wrench Set	110	■	092244
9230D	3Pc Drive Adapter Set, Metric	166	■	092305
9231D	3Pc Drive Adapter Set, SAE	166	■	092312
9240D	4Pc Double Box End GearWrench Set SAE	109	■	092404
9248	18 Pocket Wrench Roll Empty NEW	25, 167	▲	009649
9260	6Pc Double Box End GearWrench Set Metric	109	■	092602
93004D	5Pc Combination Ratcheting Wrench Set Metric	91	●	930041
93005	5Pc Original Combination Ratcheting Wrench Set SAE	91	●	930058
9304	4Pc Original Combination Ratcheting Wrench Set, SAE	91	■	093043
9308D	8Pc Combination Ratcheting Wrench Set SAE	93	■	093081
9312	13Pc Combination Ratcheting Wrench Set SAE	92	■	093128
9317	7Pc Combination Ratcheting Wrench Set SAE	92	■	093173
9404	4Pc Combination Ratcheting Wrench Set Metric	91	■	094040
9412	12Pc Combination Ratcheting Wrench Set Metric	93	■	094125
9416	16Pc Combination Ratcheting Wrench Set Metric	92	■	094163
9417	7Pc Combination Ratcheting Wrench Set Metric	91	■	094170
9418	10Pc Combination Ratcheting Wrench Set SAE/Metric	92	■	094187
9507D	7Pc Combination Ratcheting Stubby Wrench Set SAE	105	■	095078
9509N	13Pc Reversible Comb Ratcheting Wrench Set SAE	99	■	095092
9509RN	13Pc Rev Comb Ratcheting Wrench Set SAE(Roll)	99	■	950919
9510DD	10mm Combination Ratcheting Stubby Wrench	105	■	095108
9511D	11mm Combination Ratcheting Stubby Wrench	105	■	095115
9512D	12mm Combination Ratcheting Stubby Wrench	105	■	095122
9513D	13mm Combination Ratcheting Stubby Wrench	105	■	095139
9514D	14mm Combination Ratcheting Stubby Wrench	105	■	095146
9516D	16mm Combination Ratcheting Stubby Wrench	105	■	095160
9517D	17mm Combination Ratcheting Stubby Wrench	105	■	095177
9518D	18mm Combination Ratcheting Stubby Wrench	105	■	095184
9519D	19mm Combination Ratcheting Stubby Wrench	105	■	095191
9520D	10Pc Comb Ratcheting Stubby Wrench Set Metric	105	■	095207
9521ND	11/32" Reversible Comb Ratcheting Wrench	97	■	095214
9525ND	5/16" Reversible Comb Ratcheting Wrench	97	■	095252
9526ND	3/8" Reversible Comb Ratcheting Wrench	97	■	095269
9527N	7/16" Reversible Comb Ratcheting Wrench	97	■	095276
9528N	1/2" Reversible Comb Ratcheting Wrench	97	■	095283
9529N	9/16" Reversible Comb Ratcheting Wrench	97	■	095290
9530ND	5/8" Reversible Comb Ratcheting Wrench	97	■	095306
9531ND	11/16" Reversible Comb Ratcheting Wrench	97	■	095313
9532N	3/4" Reversible Comb Ratcheting Wrench	97	■	095320
9533N	8 Pc Rev Comb Ratcheting Wrench Set SAE	98	■	095337
9534N	13/16" Reversible Comb Ratcheting Wrench	97	■	095344
9538N	7/8" Reversible Comb Ratcheting Wrench	97	■	095382
9539N	15/16" Reversible Comb Ratcheting Wrench	97	■	095399
9540N	1" Reversible Comb Ratcheting Wrench	97	■	095405
9543	8Pc Reversible Comb Ratcheting Wrench Set Metric	98	●	095436

Material No.	Description	Page No.	Barcode Prefix	
			■ 082171	□ 037103
9550	10Pc Stubby Flex Comb Ratcheting Wrench Set Metric	106	■	095504
9570	7Pc Stubby Flex Comb Ratcheting Wrench Set SAE	106	■	095702
9602N	16 Pc Rev Comb Ratcheting Wrench Set Metric	98	■	096020
9602RN	16Pc Reversible GearWrench Set Metric (Roll)	99	■	960215
9608N	8mm Reversible Comb Ratcheting Wrench	97	■	096082
9609N	9mm Reversible Comb Ratcheting Wrench	97	■	096099
9610N	10mm Reversible Comb Ratcheting Wrench	97	■	096105
9611N	11mm Reversible Comb Ratcheting Wrench	97	■	096112
9612N	12mm Reversible Comb Ratcheting Wrench	97	■	096129
9613N	13mm Reversible Comb Ratcheting Wrench	97	■	096136
9614N	14mm Reversible Comb Ratcheting Wrench	97	■	096143
9615N	15mm Reversible Comb Ratcheting Wrench	97	■	096150
9616N	16mm Reversible Comb Ratcheting Wrench	97	■	096167
9617N	17mm Reversible Comb Ratcheting Wrench	97	■	096174
9618N	18mm Reversible Comb Ratcheting Wrench	97	■	096181
9619N	19mm Reversible Comb Ratcheting Wrench	97	■	096198
9620N	12 Pc Rev Comb Ratcheting Wrench Set Metric	98	■	096204
9621N	21mm Reversible Comb Ratcheting Wrench	97	■	096211
9622N	22mm Reversible Comb Ratcheting Wrench	97	■	096228
9624N	24mm Reversible Comb Ratcheting Wrench	97	■	096242
9625N	25mm Reversible Comb Ratcheting Wrench	97	■	096259
9700	7Pc Flex Combination Ratcheting Wrench Set SAE	103	■	097003
9701	8Pc Flex Combination Ratcheting Wrench Set SAE	103	■	097010
9702D	13 Pc Flex Combination Ratcheting Wrench Set SAE	104	■	097027
9704D	11/32" Flex-Head Combination Ratcheting Wrench	102	■	097041
9705	5/16" Flex-Head Combination Ratcheting Wrench	102	■	097058
9706	3/8" Flex-Head Combination Ratcheting Wrench	102	■	097065
9707	7/16" Flex-Head Combination Ratcheting Wrench	102	■	097072
9708	1/2" Flex-Head Combination Ratcheting Wrench	102	■	097089
9709	9/16" Flex-Head Combination Ratcheting Wrench	102	■	097096
9710	5/8" Flex-Head Combination Ratcheting Wrench	102	■	097102
9711	11/16" Flex-Head Combination Ratcheting Wrench	102	■	097119
9712	3/4" Flex-Head Combination Ratcheting Wrench	102	■	097126
9713	13/16" Flex-Head Combination Ratcheting Wrench	102	■	097133
9714D	7/8" Flex-Head Combination Ratcheting Wrench	102	■	097140
9715D	15/16" Flex-Head Combination Ratcheting Wrench	102	■	097157
9716D	1" Flex-Head Combination Ratcheting Wrench	102	■	097164
9840D	4Pc Half Moon Rev Dble Box Ratch Wrench Set SAE	107	■	098406
9850	5Pc Half Moon Rev Dble Box Ratch Wrench Set Metric	107	■	098505
9900D	7Pc Flex Combination Ratcheting Wrench Set Metric	103	■	099007
9901D	12Pc Flex Combination Ratcheting Wrench Set Metric	103	■	099014
9902D	16 Pc Flex Combination Ratcheting Wrench Set Metric	104	■	099021
9908D	8mm Flex-Head Combination Ratcheting Wrench	102	■	099083
9909D	9mm Flex-Head Combination Ratcheting Wrench	102	■	099090
9910D	10mm Flex-Head Combination Ratcheting Wrench	102	■	099106
9911D	11mm Flex-Head Combination Ratcheting Wrench	102	■	099113
9912D	12mm Flex-Head Combination Ratcheting Wrench	102	■	099120
9913D	13mm Flex-Head Combination Ratcheting Wrench	102	■	099137
9914D	14mm Flex-Head Combination Ratcheting Wrench	102	■	099144
9915D	15mm Flex-Head Combination Ratcheting Wrench	102	■	099151
9916D	16mm Flex-Head Combination Ratcheting Wrench	102	■	099168
9917	17mm Flex-Head Combination Ratcheting Wrench	102	■	099175
9918	18mm Flex-Head Combination Ratcheting Wrench	102	■	099182
9919D	19mm Flex-Head Combination Ratcheting Wrench	102	■	099199
9921D	21mm Flex-Head Combination Ratcheting Wrench	102	■	099212
9922D	22mm Flex-Head Combination Ratcheting Wrench	102	■	099229
9924D	24mm Flex-Head Combination Ratcheting Wrench	102	■	099243
9925D	25mm Flex-Head Combination Ratcheting Wrench	102	■	099250
CHC1500	Crescent Hand Cleaner 15LT With Grit	168	▲	009618
CHC500	Crescent Hand Cleaner 5LT Grit and Pump	168	▲	004217
CHC75	Crescent Hand Cleaner 750ML With Grit	168	▲	004200
CHCP1AU	Crescent Hand Cleaner Pump for 15LT Drum	168	▲	009861
ML100	Weller Magna-Lite Butane Micro Torch	168	□	212559
ML200	Weller Magna-Lite Butane Table Top Torch	168	□	212290

Material No.	Description	Page No.	Barcode Prefix	
			■ 082171	▲ 09337103
N80D	Crescent 80W Soldering Iron	169	▲	907020
NPFS6	Nicholson 6Pc Precision File Set	168	▲	921163
WA350	Crescent Cable Ties 350Pc	168	▲	485405
WB12100	Crescent 300mm Black Cable Ties 100PK	168	▲	485092
WB12500	Crescent Cable Ties 300 X 4.8 BLACK UV 500PK	168	▲	003975
WB4100	Crescent 100mm Black Cable Tie 100PK	168	▲	485061
WB4500	Crescent Cable Ties 100 X 2.5 BLACK UV 500PK	168	▲	003944
WB8100	Crescent 200mm Black Cable Ties 100PK	168	▲	485085
WB8500	Crescent Cable Ties 200 X 4.8 BLACK UV 500PK	168	▲	003968

The prices shown are recommended and exclusive of G.S.T. Net prices can be derived by applying your appropriate discount, unless otherwise authorised by Apex Tool Group Pty. Limited, Albury NSW and are subject to change without notice. All orders are subject to acceptance by the factory in Albury. Orders are accepted only on the basis of prices ruling on the date of shipment, unless otherwise agreed.

Credit Claim

Claims for shortages, breakages, etc., must be made within 14 days on receipt of goods.

All orders will be shipped CPT Carriage Paid to destination, or as negotiated.

Small Order Charge

For orders of less than \$150.00 excluding GST an order processing charge of \$10.00 + GST will apply. Back orders and spare parts are exempt from this condition.

Finish

We reserve the right to furnish, without notice, whatever finish is available regardless of catalogue descriptions.

Trading Terms

Payment received within 30 days of the last day of the month in which the invoice was raised. Cash Discounts 2% for Payment by cheque or E.F.T. (excluding credit card) received within 10 days of the last day of the month in which the invoice was raised.

Minimum Annual Spend

To maintain an account with Apex Tool Group Pty. Limited, a minimum annual spend of \$5,000 excluding GST, is required each year. Should sales fall below this amount in any one calendar year, you will be given the opportunity to discuss your situation with Apex Tool Group and to increase your sales over the following 6 month period. Should this not occur, your account will be closed at Apex's discretion.

Rebates

All rebates are dependent on the recipients account being conducted as per our Terms and Conditions.

Freight

Chargeable freight to the customer will be prepaid and charged on our invoice.

Product Returns

All returns of Apex Tool Group products should be to the factory, via our specified carrier.

Apex Tool Group Pty. Limited
519 Nurigong Street
Albury NSW 2640

Goods Returned Under Warranty

Postal or freight charges via our specified carrier both to the factory and on return will be for the account of Apex Tool Group.

Goods Returned for Repair

Postal or freight charges to the factory will be for customers account and return charges will be for account of Apex Tool Group.

Goods Returned for Credit

Any Apex Tool Group product may only be returned with written permission of Apex Tool Group Albury. All products must be new, of current design and in a resaleable condition. Credit will then be issued at the original purchase price, less a 15% handling service fee.

Apex Tool Group Pty. Limited
A.B.N. 50 002 965 826
PO Box 366, 519 Nurigong Street
Albury NSW 2640 Australia
(02) 6058 0300, 6021 5511, Fax 6021 7403
Sales (02) 6021 6666

Stock Adjustment Policy

All requests to return merchandise must be approved by Apex Tool Group. An offsetting order of equivalent value must accompany the request for stock adjustment. An offsetting order must be for standard price listed items at current prices and standard terms (no promotions, specials, dating orders, contract items or merchandisers). Proof of purchase must be established on all items.

Apex Tool Group will not accept the return of a product as part of a stock adjustment return which was not originally purchased from Apex Tool Group. The price shown on the Request for Return must coincide with the price list in effect at the time of original supply. The inclusion of a copy of the original Apex Tool Group invoice on which the item was shipped, will expedite the processing of the adjustment. Inventory adjustments will be credited at the actual cost paid by the distributor as determined by proof of purchase, going back one year. A 15% handling service fee will be assessed.

After authorisation is received, all returns must be shipped to the Albury factory, freight prepaid.

All returned products must have been purchased within the last 6 months prior to return and be of current design and finish, in current production, and must be in a re-saleable condition upon receipt at the

Albury factory. Any returned products which are not in a re-saleable condition will not be accepted and the distributor will be notified for disposition.

Returns will not be allowed for special made to order items.

Individually packed items must be in the original factory-sealed package when returned.

Limited Lifetime Guarantee

Apex Tool Group quality products are guaranteed against any defect in material or workmanship. Damage caused by abuse, improper use or excessive wear is not covered by this warranty.

This Warranty is provided in addition to other rights and remedies you have under law. Our goods come with guarantees that cannot be excluded under the Australian Consumer Law. You are entitled to a replacement or refund for a major failure and for compensation for any other reasonably foreseeable loss or damage.

You are also entitled to have the goods repaired or replaced if the goods fail to be of acceptable quality and the failure does not amount to a major failure.

Claims should be returned, with proof of purchase, to the place of purchase or returned prepaid to the address below. Repaired or replacement goods will be returned at our cost.

Apex Tool Group Pty Limited

519 Nurigong Street, Albury
NSW 2640, AUSTRALIA
PH: (02) 60580300
apextoolaus@apextoolgroup.com
www.apextoolgroup.com.au

Recommended Prices

The price set out or referred to herein is a recommended price only and there is no obligation to comply with the recommendation.

**PRICES HEREIN DO NOT
INCLUDE G.S.T.**

APEX TOOL GROUP - CUSTOMER SUPPORT

Sales Phone: 02 6021 6666

Sales Fax: 1800 021 940

Sales E-Mail: alburysales@apextoolgroup.com

HEAD OFFICE

Apex Tool Group Pty Ltd

519 Nurigong Street

ALBURY NSW 2640

Phone: 02 6058 0300

Email: apextoolaus@apextoolgroup.com

Web: www.apextoolgroup.com.au

PO Box 366

ALBURY NSW 2640

Fax: 02 6021 7403

REGIONAL SALES TEAM & AGENTS

NSW

DONN TRAYLEN

Regional Sales Manager

Mobile: 0457 750 475

donn.traylen@apextoolgroup.com

IAN BROWN

Sales Supervisor

Mobile: 0417 028 221

Fax: 02 9648 1990

ian.brown2@apextoolgroup.com

CLARK BUCKLEY

Sales Supervisor

Mobile: 0418 474 949

clark.buckley@apextoolgroup.com

PAUL GROSS

Sales Supervisor

Mobile: 0408 666 478

paul.gross@apextoolgroup.com

GEOFF NELSON

Sales Supervisor

Mobile: 0418 478 086

Fax: 02 4920 8936

geoff.nelson@apextoolgroup.com

QLD

PETER HANNAN

Regional Sales Manager

Mobile: 0419 282 426

Fax: 07 3324 8847

peter.hannan@apextoolgroup.com

GIL TROMBETTA

Sales Supervisor

Mobile: 0418 475 804

gil.trombetta@apextoolgroup.com

WARWICK STONE

Sales Supervisor

Mobile: 0417 028 088

Fax: 07 3264 5258

warwick.stone@apextoolgroup.com

RAYMOND CHRISTENSEN

TAMBAR PTY LTD

Phone: 07 4774 5124

Fax: 07 4774 5292

Mobile: 0418 771 098

sales@tambar.com.au

VIC

BRIAN KIDD

Regional Sales Manager

Mobile: 0419 289 557

brian.kidd@apextoolgroup.com

LISA COTTON

Sales Supervisor

Mobile: 0419 293 611

lisa.cotton@apextoolgroup.com

MICHAEL MANNING

Sales Supervisor

Mobile: 0448 063 489

michael.manning@apextoolgroup.com

GLENN MURRAYLEE

Sales Supervisor

Mobile: 0418 471 297

glenn.murraylee@apextoolgroup.com

WA

APEX TOOL GROUP

10 Bombardier Road

WANGARA WA 6053

Phone: 08 6400 3100

Fax: 08 6400 3111

BRETT RAPONI

Regional Manager

Mobile: 0419 293 909

Fax: 08 6400 3111

brett.raponi@apextoolgroup.com

GILLIAN BRAIN

Sales Supervisor

Mobile: 0438 681 704

Fax: 08 6400 3111

gillian.brain@apextoolgroup.com

GRAHAM DOOLAN

Sales Supervisor

Mobile: 0418 476 179

Fax: 08 6400 3111

graham.doolan@apextoolgroup.com

SA

CHRIS HERMAN

Regional Sales Manager

Mobile: 0419 295 033

chris.herman@apextoolgroup.com

LUKE TROLLOPE

Sales Supervisor

Mobile: 0419 291 763

luke.trollope@apextoolgroup.com

TAS

LEW PRETORIUS

L & J PRETORIUS PTY LTD

Phone: 03 6344 2686

Fax: 03 6344 7220

Mobile: 0438 131 669

lewp@precons.com

ivanp@precons.com

NT

TERRITORY HARDWARE AGENCIES

GREG MELVILLE

Phone: 0417 887 280

greg@tha-nt.com.au

NOLAN CALDWELL

Phone: 0418 892 371

nolan@tha-nt.com.au

NEW ZEALAND

AARON BELL

TOOLWARE SALES LIMITED

3 Stonedon Drive

EAST TAMAKI, AUCKLAND, 2013

NEW ZEALAND

Phone: (+649) 579 8080

Fax: (+649) 579 1166

info@toolware.co.nz

FIJI

ARSHAD DAUD

MIDLINK MARKETING

19 Ackland Street, Vatuwaqa,

SUVA, FIJI

Phone: (+679) 338 6300

Fax: (+679) 338 6290

Mobile: (+679) 992 9227

midlink@connect.com.fj

ELECTRONICS

MICHAEL NAISSSEN

Product Engineer /

Professional Tools

Phone: 02 6058 0300

Fax: 02 6021 7403

michael.naissen@apextoolgroup.com

BUSINESS DEVELOPMENT

PATRICK McINTOSH

Manager, Business Development

& Key Accounts

Mobile: 0418 673 361

patrick.mcintosh@apextoolgroup.com

STUART NAYLOR

Manager Corporate Accounts

Mobile: 0418 476 655

stuart.naylor@apextoolgroup.com



CERTIFICATE OF REGISTRATION

This is to certify that:

APEX Tool Group

ABN 50 002 965 826

519 Nurigong Street Albury NSW 2640 AUSTRALIA

operates a

QUALITY MANAGEMENT SYSTEM

which complies with the requirements of

ISO 9001:2008

for the following scope

The manufacture and distribution of premium hand and power tools for the hardware, electronic, industrial and assembly markets throughout Asia Pacific.

Certificate No: QEC0166

Issued: 17 October 2013
Expires: 8 March 2017

Originally Certified: 8 March 1996
Current Certification: 16 October 2013

Samer Chaouk
Head of Policy, Risk and Certification

Paul Butcher
Global Head – Assurance Services



Registered by:
SAI Global Certification Services Pty Ltd (ACN 108 716 604) 250 Sussex Street, Sydney NSW 2000 Australia with SAI Global Limited
250 Sussex Street Sydney NSW 2000 Australia ("SAI Global") and subject to the SAI Global Terms and Conditions for Certification.
While all due care and skill was exercised in carrying out this assessment, SAI Global accepts responsibility only for errors
negligence. This certificate remains the property of SAI Global and must be returned to SAI Global upon its request. To verify that this
certificate is current please refer to SAI Global On-Line Certification register at <http://www.sai-global.com>



QUALITY POLICY STATEMENT

Management at Apex Tool Group recognises quality is paramount to its continuing commitment to customer satisfaction. Apex Tool Group is proud of its reputation as a vertically integrated Manufacturer and Distributor of Quality Products, including tools and hardware. Apex Tool Group aligns its corporate goals of maximizing customer service through a commitment to providing quality products and technical backup, with an assurance to the end user that its products will perform to their designed application will continue to function for a reasonable period and will represent fair value.

It is Apex Tool Group's objective, that when the name Apex Tool Group is attached to one of its products, its customers can expect a high level of quality and after sales serviced which is recognized as the standard in the industry.

Apex Tool Group's strategy of continuous improvement will enable it to achieve this objective and provide its customers with the 'best value delivered' the same time every time.

Apex Tool Group will review and adhere to documented procedures and standards. We will ensure the integrity of its systems by maintaining accreditation to the International Quality Management Systems Standard ISO 9001:2008.

Apex Tool Group management and all its employees are committed to this policy.



Official Tool Supplier To

Apex Tool Group
519 Nurigong Street
Albury NSW 2640
Tel: Sales (02) 6021 6666
Fax: Sales 1800 021 940
Email: alburysales@apextoolgroup.com
www.gearwrench.com.au
Facebook: GearWrench.au

