



GEARWRENCH®

PRODUCT CATALOGUE

GET IT DONESM

APRIL 2011



THE Evolution OF Innovation



GearWrench® Hand Tools are warranted for Life to be free of defects in material and workmanship. Carrying cases, pouches, accessory bits and consumable products, if any, are not covered by this Warranty.

If use of any GearWrench® Hand Tool when used for its intended purpose, fails to give complete satisfaction, return it to your GearWrench® Distributor or contact Apex Tool Group and it will be repaired or replaced free of charge. *Except Torque Products

*GearWrench® Torque Products are warranted to (1) be free of defects in material and workmanship for one year and (2) meet out of the box calibration accuracy standards as stated in the product literature. Accuracy standards for calibration are warranted for 90 days from date of purchase. Products for which Warranty Repair is requested should be returned, at Buyer's cost, for evaluation to:

Warranty Service & Authorized Repair:
Apex Tool Group
519 Nurigong Street
Albury NSW 2640
Australia

GearWrench® Torque Products are precision instruments that contain moving parts. These components are subject to normal wear through use and replacement thereof is the responsibility of Buyer. Torque Products should be routinely checked for calibration at an Authorised Repair Centre using GearWrench® repair parts.

This Warranty shall not apply to Products which have been misused, abused, damaged by accident or otherwise, repaired by anyone other than an Authorised Repair Centre or modified by anyone other than Apex Tool Group and is in lieu of all other warranties, whether express, implied or statutory. THE IMPLIED WARRANTIES OF MERCHANT ABILITY AND FITNESS FOR A PARTICULAR PURPOSE ARE SPECIFICALLY EXCLUDED. Buyer's sole and exclusive remedy for breach of this Warranty is, at the option of Apex Tool Group, repair or replacement of the defective Product. IN NO EVENT WILL APEX TOOL GROUP BE LIABLE FOR ANY INDIRECT, SPECIAL, INCIDENTAL, CONSEQUENTIAL OR PUNITIVE DAMAGES ARISING FROM BREACH OF THIS WARRANTY, EVEN IF APEX TOOL GROUP HAS BEEN ADVISED OF THE POSSIBILITY OF SUCH DAMAGES.

The Apex Tool Group is not responsible for personal injury or damage resulting from improper tool usage, product modification, abuse or usage beyond expected product life.

For further information on GearWrench® Hand Tools, Torque Products or Authorised Repair Centres, please contact us at:

Apex Tool Group
519 Nurigong Street
Albury NSW 2640
Australia
Email: apextoolaus@apextoolgroup.com

Phone Number: 02 6058 0300

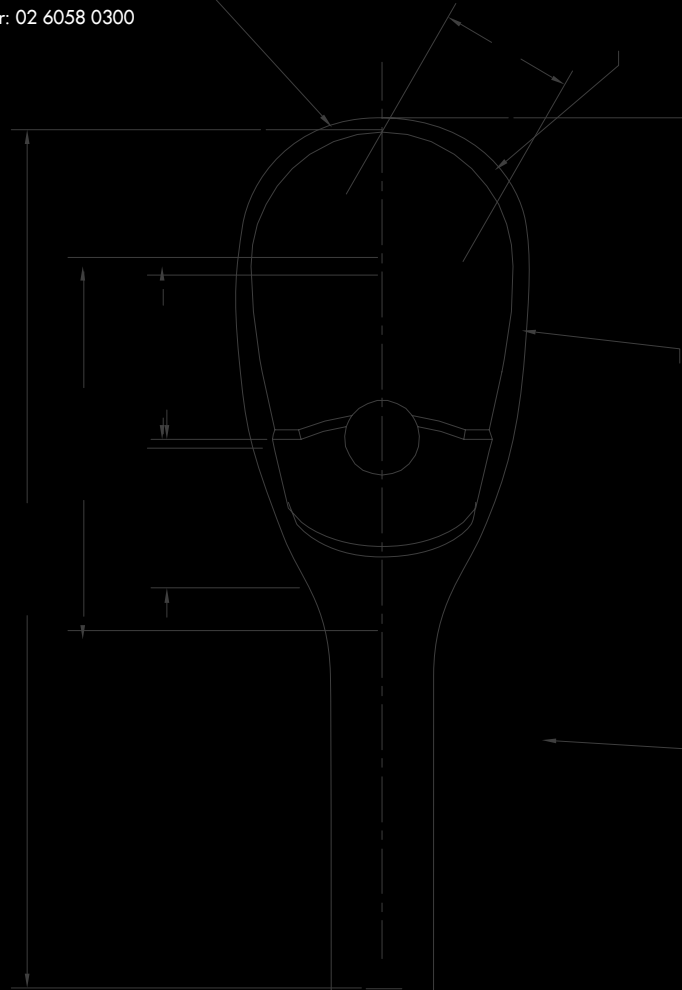
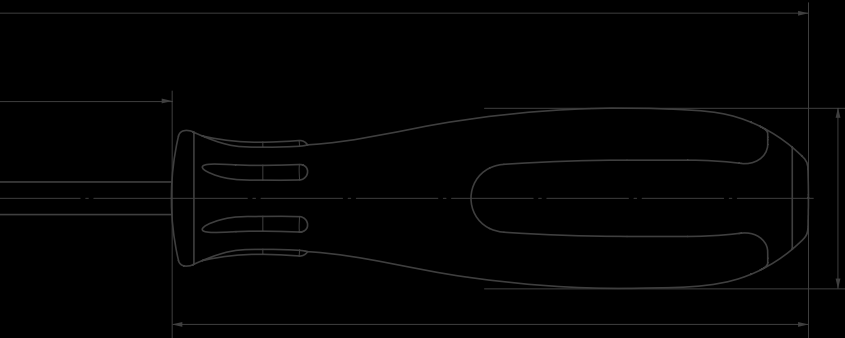

GEARWRENCH® is a registered trademark of EASCO Inc., an Apex Tool Group Company.















GearBox™, X-Beam™, Quadbox™, Vortex™, Pass-Thru®, GearPlier™, Double-X™, and GearDriver™ are trademarked registered brands of Apex Tool Group.



Apex Tool Group
519 Nurigong Street
Albury NSW 2640
Tel: sales (02) 6021 6666
Fax: sales 1800 021 940
Email: alburysales@apextoolgroup.com

www.apextoolgroup.com.au
www.gearwrench.com (USA website)

TABLE OF CONTENTS

TOOL SETS	11	
TOOL STORAGE	12	
RATCHETS, SOCKETS AND DRIVE TOOLS	32	
BIT SOCKETS AND FLEX HEX™ KEYS	86	
IMPACT SOCKETS	92	
WRENCHES	101	
TORQUE WRENCHES.....	145	
SCREWDRIVERS AND NUTDRIVERS	148	
PLIERS.....	155	
PRY BARS.....	161	
PUNCHES AND CHISELS	165	
RATCHETING TAPS AND DIES.....	168	
SPECIALTY AND GENERAL PURPOSE TOOLS	175	
INDEX.....	178	



THE EVOLUTION OF INNOVATION



GearWrench started when we developed a ratcheting wrench that stood up to professional environments

As more professionals began to use ratcheting wrenches, we spent time solving more access problems and introducing other wrench styles

Having success in wrenches, we began to integrate ratcheting mechanisms into screwdrivers and other traditionally non-ratcheting tools

1996

1997

1998

1999

2000

2001

2002

2003

COMBINATION RATCHETING WRENCH



DOUBLE BOX RATCHETING WRENCH



STUBBY RATCHETING WRENCH



REVERSIBLE RATCHETING WRENCH



FLEXIBLE RATCHETING WRENCH



GEARRATCHET VORTEX SOCKET SYSTEM



GEARDRIVER INTERCHANGABLE SHAFT SYSTEM



Starting with the "Original" combination ratcheting wrench, we quickly expanded to stubby and double box as these were traditional non-ratcheting wrench configurations

The Reversible and Flex style wrenches were born from user feedback, with an eye for how to work in tight spaces.

By 2002, we had sold over 100 million wrenches and earned a name for producing the highest quality tools at a great value



GearWrench has received numerous industry awards for producing productivity tools such as GearPlier®, Magnetic Oil Drain Plug sockets, X-Beam Ratcheting Wrenches, & Indexing Pliers.

In 2006, GearWrench introduced the broadest line expansion in its history with the addition of award-winning ratchets, sockets, screwdrivers, pliers, and torque wrenches

GearWrench has continued to innovate products by adding productivity features to products like pry bars, hemostats, and tool boxes

2004

2005

2006

2007

2008

2009

2010

STUBBY FLEX RATCHETING WRENCH



S-SHAPE RATCHETING WRENCH

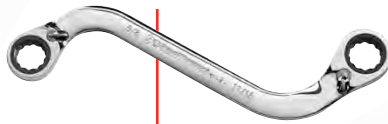

RATCHETING TAP & DIE



HALF MOON RATCHETING WRENCH



RATCHETING XL LOCKING FLEX WRENCHES



X-BEAM RATCHETING WRENCH



FULL POLISH RATCHETS

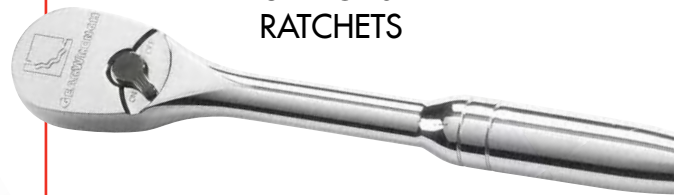

SCREWDRIVERS



STANDARD & DEEP SOCKETS



BIT & SPECIALTY SOCKETS



PLIERS



NEW PRODUCT HIGHLIGHTS

GearWrench has significantly expanded its product line of productivity solutions to help professional mechanics and technicians get their jobs done faster and easier. Look for these new items in this catalogue, online at www.gearwrench.com and from your GearWrench distributor.



IMPACT SOCKETS AND SOCKET SETS p. 92

- New impact socket sets
- New 1/4" Drive open stock sockets in SAE/METRIC, Standard/Deep/Universal
- New 3/8" Drive open stock sockets in SAE/METRIC, Standard/Deep/Universal
- New 1/2" Drive open stock sockets in SAE/METRIC, Standard/Deep/Universal
- New 3/4" Drive open stock sockets in SAE/METRIC, Standard/Deep/Universal

EXPANDED LINE OF CHROME TOOLS p. 51

- New Ratchet & Socket sets in 1/4", 3/8", and 1/2" Drive sizes
- New 3/4" Drive Ratchets, Drive Tools, and Sockets from 7/8" through 2-3/8"

- New Combination Wrenches in both 6 Pt. and 12 Pt.
- New Double-Box End Wrenches
- New Double Open-End Wrenches
- New Adjustable Wrenches from 1/4" through 1-1/4" and 10mm through 19mm

- New solid handle Screwdrivers
- New hollow shaft Nutdrivers



TOOL STORAGE SOLUTIONS p. 12

- New XL series roller cabinets, top chests, and tool carts
- New ball bearing series roller cabinets and top chests
- New tool bags and tool storage accessories



MOBILE ELITE



- Automotive Repair
- Fleet Maintenance
- Diesel & Heavy Duty



INDUSTRY SOLUTIONS: *AUTOMOTIVE*

Simply put "time is money," and when technicians can get the job done faster than the industry standard, that's more money in their pockets. We are passionate about producing tools that focus on productivity, and doing more with less. That's why our innovative tools have been trusted by more professional technicians to "GET IT DONE."

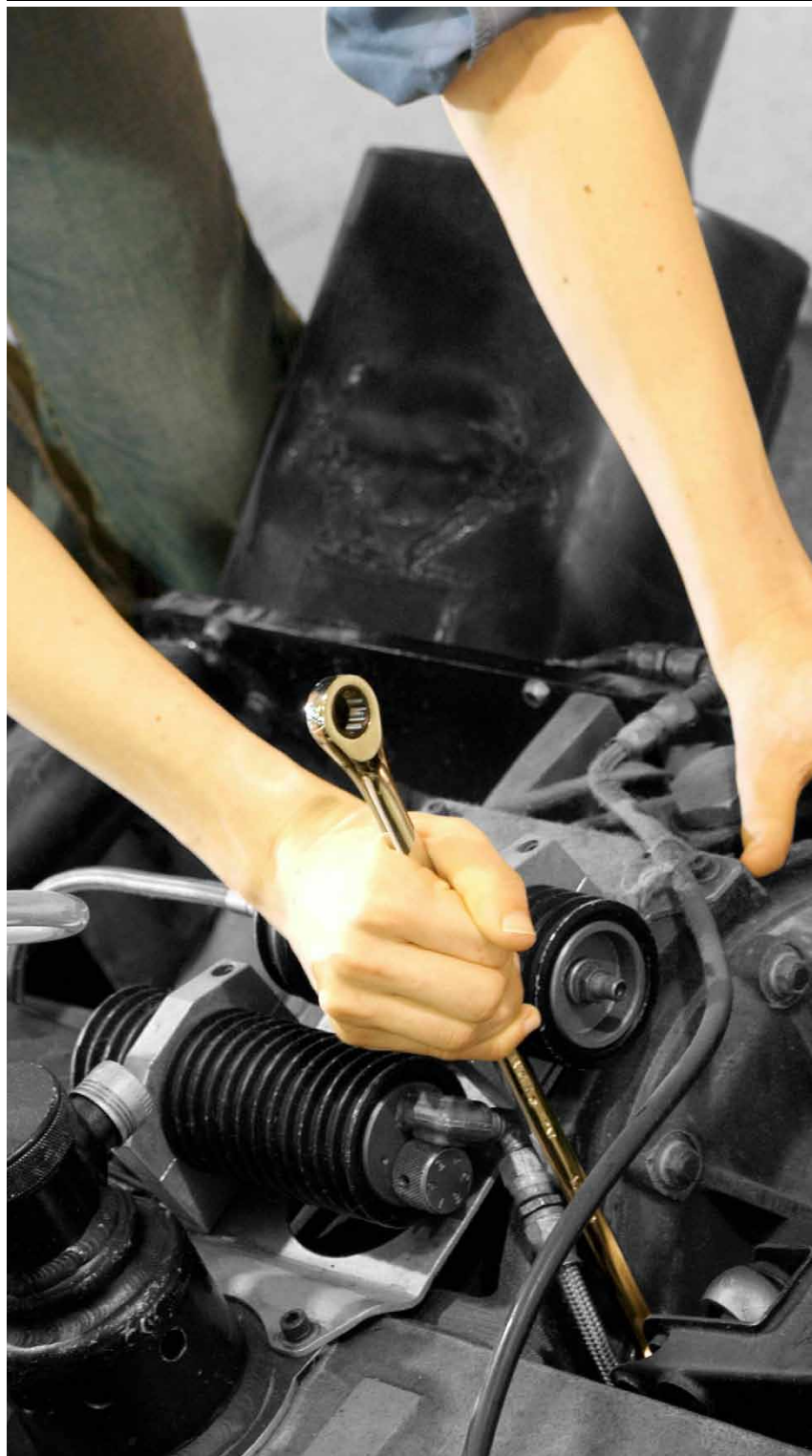

INDUSTRY SOLUTIONS: *INDUSTRIAL & COMMERCIAL*

In today's industrial environment, mechanics rely on their tools to keep critical equipment operating with as little down time as possible. With manufacturing plants in 3 countries including the United States, GearWrench understands how critical it is to have the highest quality standards for manufacturing and the importance of dependable tools for the industry.

With nearly three thousand individual SKU's, GearWrench has one of the broadest and most complete professional hand tool lines in the market. We offer tools ranging from the precise to the nearly indestructible. No matter the industry you find yourself in, GearWrench has the tools to fit your needs.

- Industrial Maintenance & Repair Organisations
- Aviation
- Alternative Energy
- Commercial Construction



INDUSTRY SOLUTIONS

- Fully Featured Innovative Products
- Tool Sets and Tool Storage
- Tools for Students and Schools

Starting a new career can be one of the most nerve racking experiences in a person's life. For a mechanic or a technician, starting out can be especially tough when making that initial investment in the tools necessary to make a living in the future. GearWrench® can help ease that anxiety. We work with the leading instructors, institutions, and OEM manufacturers to ensure that when a student purchases a GearWrench® kit from an authorized distributor, they have the right tools for the job from day one, all without putting the student into severe debt. The bottom line is GearWrench® provides students with fully featured products at a significant value.

- Auto Body
- Diesel
- HVAC
- Hybrids
- Electrical
- Wind Energy



GEARWRENCH MOTORSPORTS INTERNATIONAL

Put your money where your mouth is. That's quite a motto, but it symbolises exactly how GearWrench has approached professional motorsports. NASCAR®, Sports Car Clubs of America (SCCA), and amateur drag, drifting, and motorcross are all part of GearWrench's motorsports program.

We view professional motorsports as much more than a car going fast around a track with our logo on the side. We partner with the drivers and just as importantly, the pit crews who use our tools to keep their cars in top shape and at top speed. This partnership allows some of the industry's most discerning tool users to push GearWrench® tools to the limits and help us improve the tools for you. We get valuable tool ideas from racers daily and that's one of the many ways we come up with so many new innovative tool ideas.

 **GEARWRENCH®**



Check out the many motorsports and racing events we participate in by visiting www.gearwrench.com for event dates.



GEARWRENCH MOTORSPORTS AUSTRALASIA

GearWrench products in the Australasian market will be backed and supported by an exciting motorsport program including the V8 Supercars Fujitsu Series, V8 Ute Series, Free-Style Motocross and Pro Stock Drag Racing. This involves a partnership with leading V8 Supercars Team, Triple8 Racing and Monster Energy drink. Not only will the race teams be putting the Gearwrench tools to the test in the most arduous of environments, but they will be bringing the excitement and energy of the GearWrench brand to the market through innovative promotions and events.



GEARWRENCH®



THE Evolution OF Innovation

WWW.GEARWRENCH.COM (USA WEBSITE)

Visit our website www.gearwrench.com for the latest news, product reviews, and information on what we're up to. Please note that not all products shown on the www.gearwrench.com website are available in the Australasian Market. For Australasian product listing refer to www.apextoolgroup.com.au

- Get product dimensions and specifications
- Get images and other product details
- See product demonstration videos

The screenshot shows the GearWrench website homepage. At the top is the GearWrench logo and a navigation menu with links: ABOUT US, NEW PRODUCTS, NEWS & REVIEWS, NEWSLETTER, TESTIMONIALS, WHERE TO BUY, WARRANTY, MEDIA CENTER, CONTACT US. There is a Facebook link and a search bar. A large video player is the central focus, titled "CHECK OUT OUR INDEXING PRY BAR VIDEO" with a "CLICK HERE TO WATCH NOW" button. Below the video is a "Featured Products" section displaying four items: Electronic Torque Wrench, XL X-Beam™, Screwdriver, and GearBox™. A sidebar on the left lists various tool categories like RATCHETS & SOCKETS, BIT & SPECIALTY SOCKETS, etc.

The screenshot shows the GearWrench Facebook page. The header includes the Facebook logo, a search bar, and the GearWrench profile picture. The page name is "GearWrench" with a "Become a Fan" button. Navigation tabs for Wall, Info, Photos, Video, Notes, and Boxes are visible. The "Detailed Info" section lists the website as <http://www.gearwrench.com>, <http://www.gearwrenchmerchandise.com>, <http://www.gearwrench.com/wheretobuy/>, and <http://www.newtoolinventor.com>. The "Company Overview" section states: "GearWrench is a premier hand tool brand from Danaher Tool Group, one of the largest hand tool manufacturers in the world. Since the launch of the original patented 5-degree ratcheting wrench, the GearWrench brand has continuously led the industry with breakthroughs in pass-thru ratchets, sockets, screw/nut drivers, pliers and specialty tools. More than 100 million GearWrench products have been 'Professionally Tested' throughout the world." Customer Service (toll-free) is listed as 800-688-8949. A "Suggest to Friends" button and a quote "Get it done. GearWrench innovation for professional tool users." are also present.

TOOL SETS

A photograph of a mechanic wearing safety glasses and a dark shirt, focused on working on a car engine. He is using a wrench. The image is overlaid with a semi-transparent red filter. The background is blurred, showing other parts of the car and possibly another person.

Tool Sets

Introductory Sets
Career Builder Sets
Intermediate and Advanced Tool Sets

GearWrench® Tool Sets feature carefully designed sets to fully equip the Student Technician with the tools necessary to conquer the service and repair challenges in today's Automotive, Heavy Duty/Diesel, Machinery, and Aviation fields.

Each tool set features innovations in speed, access, and design; hallmarks that have established the GearWrench® brand as a leader in quality, professional hand tools.

Each Tool Set also includes storage for sockets, wrenches, screwdrivers, and other tools to help promote efficient tool organization.



GearWrench® understands the environment you work in because we work side-by-side with technicians to learn about frustrations firsthand, and develop innovative, new hand tools to solve day-to-day problems. We know you will make a living with your tools and you need just the right tools to help you work smarter and faster. Across various tool categories, we deliver superior products that do just that. Our commitment to delivering the most durable and reliable products while adding time-saving features makes this possible.

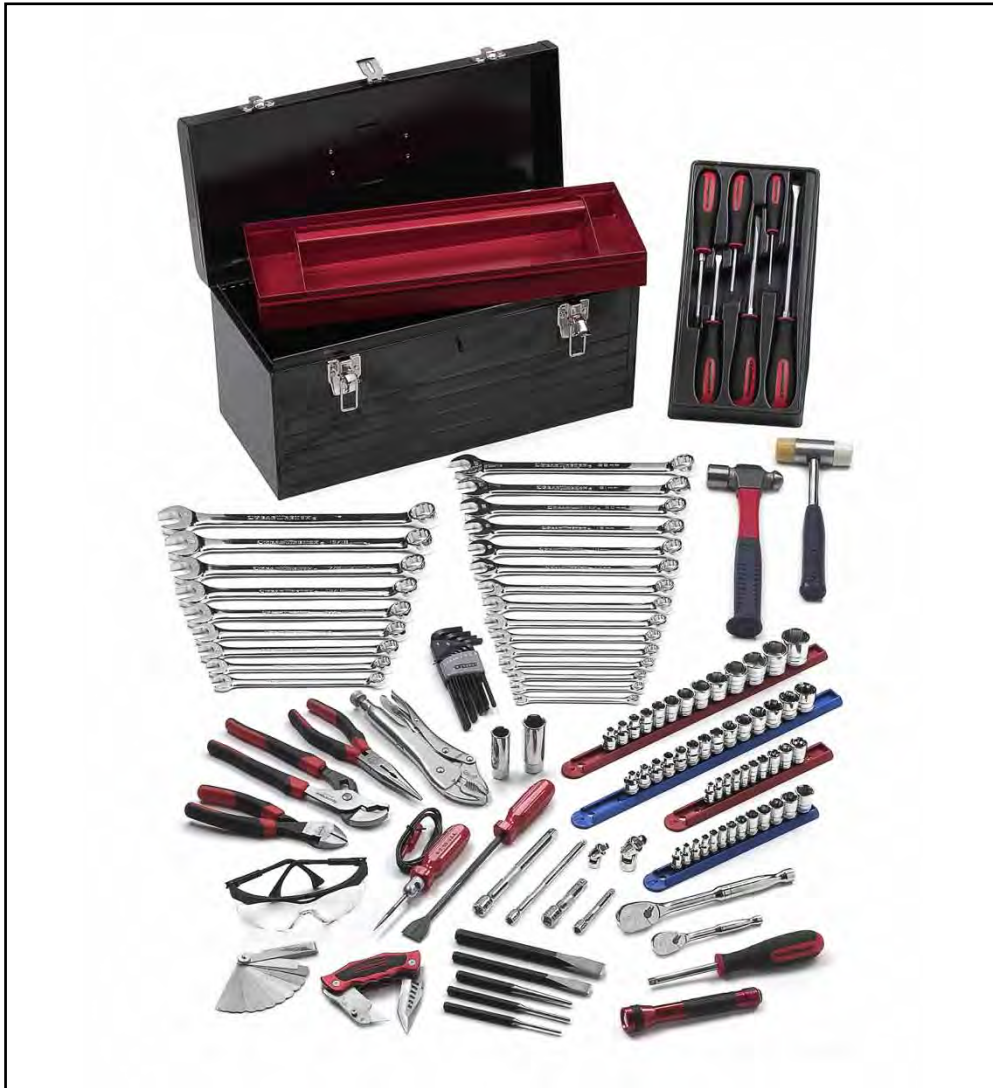

83090 - Auto Introductory Set SAE/METRIC

81658	5/8"	81670	13mm
81659	11/16"	81671	14mm
81660	3/4"	81672	15mm
81661	13/16"	81673	16mm
81662	7/8"	81674	17mm
81663	15/16"	81675	18mm
81664	1"	81676	19mm
81665	8mm	81677	20mm
81666	9mm	81678	21mm
81667	10mm	81679	22mm

Screwdrivers and Pliers

80050	6 Pc. Combination Screwdriver Set
80015	1/8" x 3" Slotted w/Cabinet Tip
80013	1/4" x 4" Slotted w/Hex Bolster
80023	5/16" x 6" Slotted w/Hex Bolster
80022	3/8" x 8" Slotted w/Hex Bolster
80001	#1 x 3" Phillips
80007	#2 x 4" Phillips w/Hex Bolster

82104 3 Pc. Mixed Pliers Set

82011	9.5" Tongue and Groove
82012	7" Diagonal Cutting
82013	8" Long Nose

Hex Keys

56603G 13 Pc. SAE ALLEN® Hex Key Set
 Sizes: 0.050", 1/16", 5/64", 3/32", 7/64", 1/8", 9/64", 5/32", 3/16", 7/32", 1/4", 5/16", 3/8"

Punches and Chisels

82304	5 Pc. Punch and Chisel Set
82270	3/8" x 5" Center Punch
82273	1/8" x 5" x 5/16" Pin Punch
82274	5/32" x 5-1/4" x 5/16" Pin Punch
82275	3/16" x 5-1/2" x 5/16" Pin Punch
82264	1/2" x 6" x 3/8" Cold Chisel

General Purpose Tools

82251	16 oz. Ball Pein Hammer - Fiberglass
82260	12 oz. Softface Hammer Removable Caps
82881	Folding Utility Knife
83132	Aluminum Flashlight
82041	10" Curved Jaw Locking Pliers
69-990	Safety Glasses

KD® Specialty Tools

KDS129	Low Voltage Circuit Tester
KDS162	16 Blade Feeler Gauge
KDS485	Gasket Scraper

Tool Storage

83130	Tote Box
-------	----------

Not all tools GearWrench® Branded

1/4" Drive Sockets

80302	13 Pc. 6 Pt. Metric Socket Set		
80125	4mm	80132	10mm
80126	5mm	80133	11mm
80127	5.5mm	80134	12mm
80128	6mm	80135	13mm
80129	7mm	80136	14mm
80130	8mm	80137	15mm
80131	9mm		
80303	10 Pc. 6 Pt. SAE Socket Set		
80105	3/16"	80110	11/32"
80106	7/32"	80111	3/8"
80107	1/4"	80112	7/16"
80108	9/32"	80113	1/2"
80109	5/16"	80114	9/16"

1/4" Drive Tools

81011	Full Polish Ratchet
81113	3" Extension
81116	6" Extension
81128	Spinner Handle

3/8" Drive Sockets

80552	14 Pc. 6 Pt. Metric Socket Set		
80374	6mm	80381	13mm
80375	7mm	80382	14mm
80376	8mm	80383	15mm
80377	9mm	80384	16mm
80378	10mm	80385	17mm
80379	11mm	80386	18mm
80380	12mm	80387	19mm

80553 13 Pc. 6 Pt. SAE Socket Set

80350	1/4"	80357	11/16"
80351	5/16"	80358	3/4"

80352	3/8"	80359	13/16"
-------	------	-------	--------

80353	7/16"	80360	7/8"
-------	-------	-------	------

80354	1/2"	80361	15/16"
-------	------	-------	--------

80355	9/16"	80362	1"
-------	-------	-------	----

80356	5/8"		
-------	------	--	--

3/8" Drive Tools

81211	Full Polish Teardrop Ratchet
81241	3" Extension
81242	6" Extension
80549	Universal Joint
80402	5/8" Spark Plug Socket
80403	13/16" Spark Plug Socket

Combination Wrenches

81900 24 Pc. SAE/Metric Long Pattern Combination Non-Ratcheting Wrench Set

81656	1/2"	81668	11mm
81657	9/16"	81669	12mm

83091 - Career Builder Starter Set

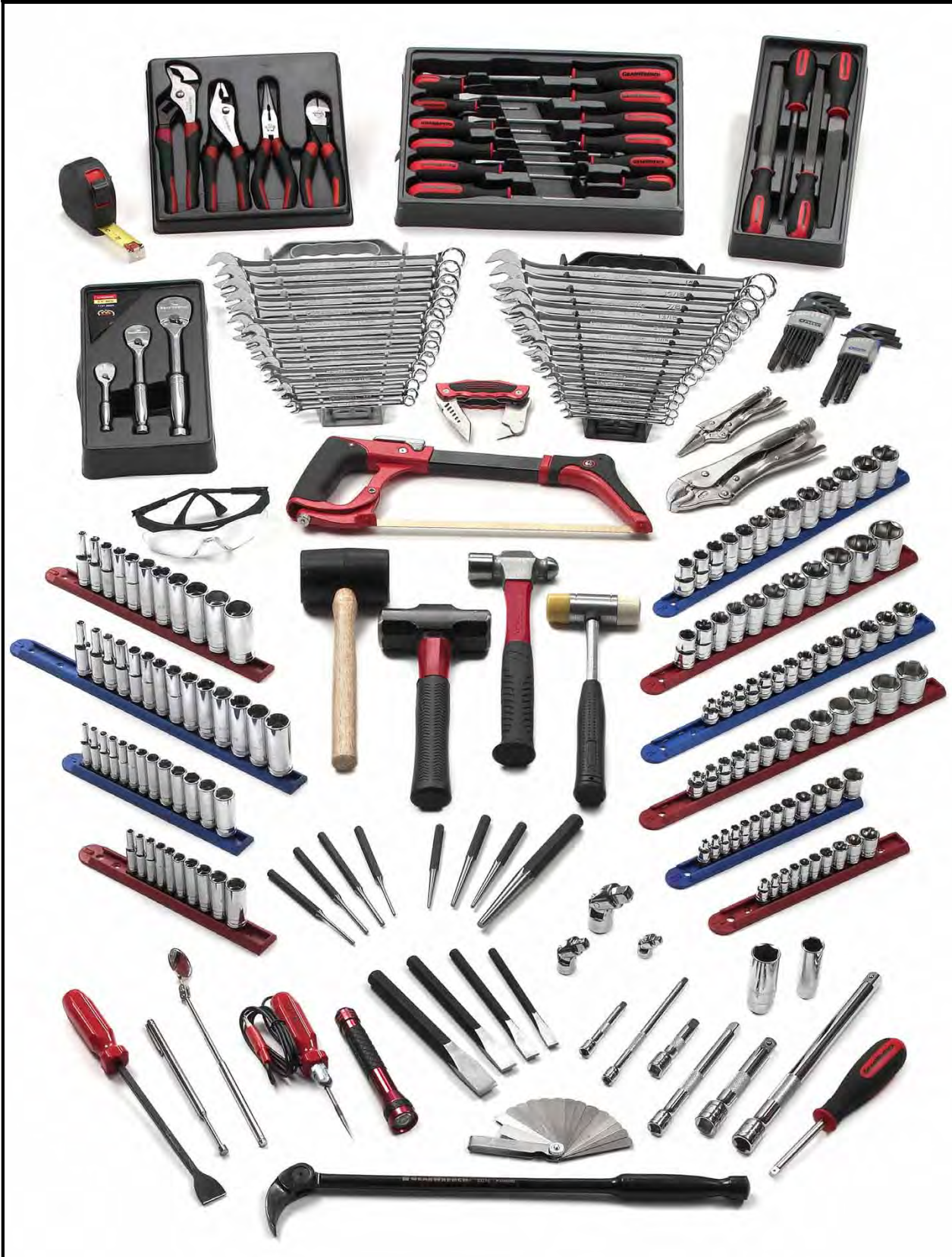

1/4" Drive Sockets

80302 13 Pc. 6 Pt. Metric Socket Set

80125	4mm	80132	10mm
80126	5mm	80133	11mm
80127	5.5mm	80134	12mm
80128	6mm	80135	13mm
80129	7mm	80136	14mm
80130	8mm	80137	15mm
80131	9mm		

80303 10 Pc. 6 Pt. SAE Socket Set

80105	3/16"	80110	11/32"
80106	7/32"	80111	3/8"
80107	1/4"	80112	7/16"
80108	9/32"	80113	1/2"
80109	5/16"	80114	9/16"

80304 13 Pc. 6 Pt. Deep Metric Socket Set

80138	4mm	80145	10mm
80139	5mm	80146	11mm
80140	5.5mm	80147	12mm
80141	6mm	80148	13mm
80142	7mm	80149	14mm
80143	8mm	80150	15mm
80144	9mm		

80305 10 Pc. 6 Pt. Deep SAE Socket Set

80115	3/16"	80120	11/32"
80116	7/32"	80121	3/8"
80117	1/4"	80122	7/16"
80118	9/32"	80123	1/2"
80119	5/16"	80124	9/16"

3/8" Drive Sockets

80552 14 Pc. 6 Pt. Metric Socket Set

80374	6mm	80381	13mm
80375	7mm	80382	14mm
80376	8mm	80383	15mm
80377	9mm	80384	16mm
80378	10mm	80385	17mm
80379	11mm	80386	18mm
80380	12mm	80387	19mm

80553 13 Pc. 6 Pt. SAE Socket Set

80350	1/4"	80357	11/16"
80351	5/16"	80358	3/4"
80352	3/8"	80359	13/16"
80353	7/16"	80360	7/8"
80354	1/2"	80361	15/16"
80355	9/16"	80362	1"
80356	5/8"		

80554 14 Pc. 6 Pt. Deep Metric Socket Set

80388	6mm	80395	13mm
80389	7mm	80396	14mm
80390	8mm	80397	15mm
80391	9mm	80398	16mm
80392	10mm	80399	17mm

80393	11mm	80400	18mm
80394	12mm	80401	19mm

80555 11 Pc. 6 Pt. Deep SAE Socket Set

80363	1/4"	80369	5/8"
80364	5/16"	80370	11/16"
80365	3/8"	80371	3/4"
80366	7/16"	80372	13/16"
80367	1/2"	80373	7/8"
80368	9/16"		

1/2" Drive Sockets

80702 13 Pc. 6 Pt. Metric Socket Set

81624	12mm	81631	19mm
81625	13mm	81632	20mm
81626	14mm	81633	21mm
81627	15mm	81634	22mm
81628	16mm	81635	23mm
81629	17mm	81636	24mm
81630	18mm		

80703 11 Pc. 6 Pt. SAE Socket Set

80603	1/2"	80609	7/8"
80604	9/16"	80610	15/16"
80605	5/8"	80611	1"
80606	11/16"	80612	1-1/16"
80607	3/4"	80613	1-1/8"
80608	13/16"		

1/4", 3/8", 1/2" Drive Tools

81206 3 Pc. Full Polish Ratchet Set 1/4", 3/8", & 1/2" Drive

81113	3" Extension 1/4" Drive
81116	6" Extension 1/4" Drive
80100	Universal Joint 1/4" Drive
81128	Spinner Handle 1/4" Drive
81241	3" Extension 3/8" Drive
81242	6" Extension 3/8" Drive
80549	Universal Joint 3/8" Drive
80402	5/8" Spark Plug Socket 3/8" Drive
80403	13/16" Spark Plug Socket 3/8" Drive
80600	Universal Joint 1/2" Drive
81341	5" Extension 1/2" Drive
81342	10" Extension 1/2" Drive

Combination Wrenches

81901 15 Pc. SAE Long Pattern Non-Ratcheting Wrench Set

81650	1/4"	81658	5/8"
81651	9/32"	81659	11/16"
81652	5/16"	81660	3/4"
81653	11/32"	81661	13/16"
81654	3/8"	81662	7/8"
81655	7/16"	81663	15/16"
81656	1/2"	81664	1"
81657	9/16"		

81902 15 Pc. Metric Long Pattern Non-Ratcheting Wrench Set

81665	8mm	81673	16mm
81666	9mm	81674	17mm
81667	10mm	81675	18mm
81668	11mm	81676	19mm
81669	12mm	81677	20mm
81670	13mm	81678	21mm
81671	14mm	81679	22mm
81672	15mm		

Screwdrivers and Pliers

80051 12 Pc. Combination Screwdriver Set

80012	1/4" x 1-1/2" Slotted
80018	3/16" x 6" Slotted w/ Cabinet Tip
80013	1/4" x 4" Slotted w/Hex Bolster
80014	1/4" x 6" Slotted w/Hex Bolster
80023	5/16" x 6" Slotted w/Hex Bolster
80022	3/8" x 8" Slotted w/Hex Bolster
80000	#0 x 2-1/2" Phillips
80001	#1 x 3" Phillips
80004	#1 x 6" Phillips
80005	#2 x 1-1/2" Phillips
80007	#2 x 4" Phillips w/Hex Bolster
80011	#3 x 6" Phillips w/Hex Bolster

82103 4 Pc. Mixed Pliers Set

82011	9.5" Tongue and Groove
82012	7" Diagonal Cutting
82013	8" Long Nose
82014	8" Slip Joint

Hex Keys

566126 13Pc. SAE ALLEN® Ball End Hex Key Set

Sizes: 0.050", 1/16", 5/64", 3/32", 7/64", 1/8", 9/64", 5/32", 3/16", 7/32", 1/4", 5/16", 3/8"

566156 9Pc. Metric ALLEN® Ball End Hex Key Set

Sizes: 1.5, 2, 2.5, 3, 4, 5, 6, 8, 10mm

Files, Punches & Chisels

82820 4 Pc. STD File Set

82822	8" Flat
82823	8" Round
82824	8" Half Round
82825	8" Triangle

82305 12 Pc. Punch and Chisel Set

82261	1/4" x 4-3/4" x 1/4" Cold Chisel
82262	3/8" x 5" x 5/16" Cold Chisel
82264	1/2" x 6" x 3/8" Cold Chisel
82265	5/8" x 6-1/2" x 3/8" Cold Chisel
82270	3/8" x 5" Center Punch
82272	3/32" x 4-3/4" x 5/16" Pin Punch
82273	1/8" x 5" x 5/16" Pin Punch

82274	5/32" x 5-1/4" x 5/16" Pin Punch
82275	3/16" x 5-1/2" x 5/16" Pin Punch
82278	1/8" x 8" x 3/8" Long Taper Punch
82283	3/16" x 5" x 3/8" Starter Punch
82285	1/8" x 4-1/2" x 5/16" Starter

General Purpose Tools

82216	16" Indexing Pry Bar
82880	High Tension Hacksaw
82251	16 oz. Ball Pain Hammer - Fiberglass
82260	12 oz. Sofface Hammer Removable Caps
82255	3 lb. Drilling Hammer
82259	16 oz. Rubber Mallet-Wood Hickory Handle
82881	Folding Utility Knife
83131	16" Tape Measure SAE/Metric
83132	Aluminum Flashlight
82041	10" Curved Jaw Locking Pliers
82043	6" Long Nose Locking Pliers
69-990	Safety Glasses

KD® Specialty Tools

KDS129	Low Voltage Circuit Tester
KDS162	16 Blade Feeler Gauge
KDS485	Gasket Scraper
KDS2109	Telescoping Mirror
KDS2281	Telescoping Magnetic Retrieving Tool

Not all tools GearWrench® Branded



1/2" Drive Sockets

80704	10 Pc. 6 Pt. Deep Metric Socket	80640	13mm	80645	18mm
80637	10mm	80642	15mm	80641	14mm
80638	11mm	80643	16mm	80705	8 Pc. 6 Pt. Deep SAE Socket Set
80629	17mm	80644	17mm	80614	1/2"
				80618	3/4"
				80615	9/16"
				80619	13/16"

83092 - Career Builder Diesel Add-on Tool Set

80616	5/8"	80620	7/8"	81907	6 Pc. SAE Flare Nut Wrench Set
80617	11/16"	80621	15/16"	81680	1/4" x 5/16"
1/2" Drive Tools					
81307	Full Polish Flex Handle				
Combination Wrenches					
SAE Combination Wrenches					
81733	1-1/6"				
81734	1-1/8"				
81735	1-1/4"				
Metric Combination Wrenches					
81741	23mm	81744	30mm		
81742	24mm	81745	32mm		
81743	27mm				
Flare Nut Wrenches					
81906	6 Pc. Metric Flare Nut Wrench Set				
81644	9 x 11mm				
81645	10 x 12mm				
81646	13 x 14mm				
81647	15 x 17mm				
81648	16 x 18mm				
81649	19 x 21mm				



83093 - Career Builder Auto Body Add-on Tool Set

General Body Tools					
84050	4 Pc. Door Pad and Panel Removal Kit				
84051	4" V-Notch Puller				
84052	4" Square Notch Puller				
84053	4" Scraper				
84054	4" Curved Blade V-Notch Puller				
84000	7 Pc. Hook And Pick Set				
84001	5" Cotter Pin Puller				
84002	4" Hose Pick Puller				
84003	4-1/2" Awl				
84004	3-1/8 Mini Full Hook				
84005	3-1/8 90° Mini Hook				
84006	3-1/8 Straight Mini Hook				
84007	3-1/8 Mini Offset Hook				
82302	7 Pc. Body Hammer Set				
Torx® Bit Sockets					
80723	13 Pc. Torx® Press Fit Bit Socket Set				
80171	1 T-8, 1/4" Drive				
80172	T-10, 1/4" Drive				
80173	T-15, 1/4" Drive				
80174	T-20, 1/4" Drive				
80175	T-25, 1/4" Drive				
80176	T-27, 1/4" Drive				
80177	T-30, 1/4" Drive				
80451	T-40, 3/8" Drive				
80452	T-45, 3/8" Drive				
80453	T-47, 3/8" Drive				
80454	T-50, 3/8" Drive				
80455	T-55, 3/8" Drive				
80667	T-60, 1/2" Drive				
KD® Specialty Tools					
KDS038	Window Molding Removal Tool				
KDS431	Door Handle Window Lift Remover				
KDS2822	Trim Pad Removal Tool				
KDS3729	Push Pin Puller				
KDS2106	All Purpose Sticker Scraper Tool				
KDS2311	Shoe Handle Wire Scratch Brush				
KDS2426	3" Putty Knife/Scraper				
KDS2425	1-1/4" Putty Knife/Scraper				

Not all tools GearWrench® Branded

83094 - Career Builder HVAC Add-on Tool Set

Wrenches

- 81910 5 Pc. SAE Flex Flare Nut Wrench Set
- 81693 1/4" x 5/16"
- 81694 3/8 x 7/16"
- 81695 1/2" x 9/16"
- 81696 5/8" x 11/16"
- 81697 3/4" x 7/8"
- 81911 6 Pc. Metric Flex Flare Nut Wrench Set
- 81686 9 x 11mm
- 81687 10 x 12mm
- 81688 13 x 14mm
- 81689 15 x 17mm
- 81690 16 x 18mm
- 81692 19 x 21mm
- 81990 3 Pc. Adjustable Wrench Set
- 81890 6"
- 81891 8"
- 81892 10"
- 85220 QuadBox™ HVAC Ratcheting Wrench
- Sizes: 1/4" x 3/16" square, 3/8" x 5/16" square
- 85221 QuadBox™ HVAC Ratcheting Wrench
- Sizes: 1/4" x 3/16" square, 9/16" x 1/2" hex

Cutting Tools

- 82841 Right Cutting Aviation Snips
- 82842 Left Cutting Aviation Snips
- 82843 3 Pc. Aviation Snip Set

General HVAC Tools

- 9-39829 Torpedo Level
- 69-350 10oz. Claw Hammer
- 73-014 14" Pipe Wrench
- MC33661 Manifold Set
- 66-843 7 Pc. SAE Nut Driver Set
- (1/4" x 9/32", 5/16", 11/32", 3/8", 7/16", 1/2")

KD® Specialty Tools

- 41590 Tubing Service Set
- 2107 Mini Tubing Cutter
- 2189 Tubing Bender
- 3905 Deburring Tool
- 41594 Flaring Adapter Kit
- 41595 Holding Bar
- 41596 Yoke
- 3457 Large Tubing Cutter



83095 - Intermediate Auto Tool Set



1/4" Drive Sockets

80302	13 Pc. Metric 6 Pt. Socket Set
80125	4mm 80132 10mm
80126	5mm 80133 11mm
80127	5.5mm 80134 12mm
80128	6mm 80135 13mm
80129	7mm 80136 14mm
80130	8mm 80137 15mm
80131	9mm

80302	13 Pc. 6 Pt. Metric Socket Set
80105	3/16" 80110 11/32"
80106	7/32" 80111 3/8"
80107	1/4" 80112 7/16"
80108	9/32" 80113 1/2"
80109	5/16" 80114 9/16"

80304	13 Pc. 6 Pt. Deep Metric Socket Set
80138	4mm 80145 10mm
80139	5mm 80146 11mm
80140	5.5mm 80147 12mm
80141	6mm 80148 13mm
80142	7mm 80149 14mm
80143	8mm 80150 15mm
80144	9mm

80305	10 Pc. 6 Pt. Deep SAE Socket Set
80115	3/16" 80120 11/32"
80116	7/32" 80121 3/8"
80117	1/4" 80122 7/16"
80118	9/32" 80123 1/2"
80119	5/16" 80124 9/16"

3/8" Drive Sockets

80552	14 Pc. 6 Pt. Metric Socket Set
80374	6mm 80381 13mm
80375	7mm 80382 14mm
80376	8mm 80383 15mm
80377	9mm 80384 16mm
80378	10mm 80385 17mm
80379	11mm 80386 18mm
80380	12mm 80387 19mm

80553	13 Pc. 6 Pt. SAE Socket Set
80350	1/4" 80357 11/16"
80351	5/16" 80358 3/4"
80352	3/8" 80359 13/16"
80353	7/16" 80360 7/8"
80354	1/2" 80361 15/16"
80355	9/16" 80362 1"
80356	5/8"

80554	14 Pc. 6 Pt. Deep Metric Socket Set
80388	6mm 80395 13mm
80389	7mm 80396 14mm
80390	8mm 80397 15mm
80391	9mm 80398 16mm

80392	10mm	80399	17mm
80393	11mm	80400	18mm
80394	12mm	80401	19mm
80555	11 Pc. 6 Pt. Deep SAE Socket Set		
80363	1/4" 80369 9/16"		
80364	5/16" 80370 5/8"		
80365	3/8" 80371 11/16"		
80366	1/4" 80372 3/4"		
80367	7/16" 80373 7/8"		
80368	1/2"		

1/2" Drive Sockets

80702	13 Pc. 6 Pt. Metric Socket Set
81624	12mm 81631 19mm
81625	13mm 81632 20mm
81626	14mm 81633 21mm
81627	15mm 81634 22mm
81628	16mm 81635 23mm
81629	17mm 81636 24mm
81630	18mm

80703	11 Pc. 6 Pt. SAE Socket Set
80603	1/2" 80609 7/8"
80604	9/16" 80610 15/16"
80605	5/8" 80611 1"
80606	11/16" 80612 1-1/16"
80607	3/4" 80613 1-1/8"
80608	13/16"

1/4", 3/8", 1/2" Drive Sockets

81206	3 Pc. Full Polish Ratchet Set (1/4", 3/8", 1/2" Drive)
81113	3" Extension 1/4" Drive
80100	Universal Joint 1/4" Drive
81128	Spinner Handle 1/4" Drive
81241	3" Extension 3/8" Drive
81242	6" Extension 3/8" Drive
80549	Universal Joint 3/8" Drive
80402	5/16" Spark Plug Socket 3/8" Drive
80403	13/16" Spark Plug Socket 3/8" Drive
80600	Universal Joint 1/2" Drive
81341	5" Extension 1/2" Drive
81307	Full Polish Flex Handle 1/2" Drive

Combination Wrenches

81901	15 Pc. SAE Long Pattern Combination Non-Ratcheting Wrench Set
81650	1/4" 81658 5/8"
81651	9/32" 81659 11/16"
81652	5/16" 81660 3/4"
81653	11/32" 81661 13/16"
81654	3/8" 81662 7/8"
81655	7/16" 81663 15/16"
81656	1/2" 81664 1"
81657	9/16"

81902	15 Pc. Metric Long Pattern Combination Non-Ratcheting Wrench Set
81665	8mm 81673 16mm
81666	9mm 81674 17mm
81667	10mm 81675 18mm
81668	11mm 81676 19mm
81669	12mm 81677 20mm
81670	13mm 81678 21mm
81671	14mm 81679 22mm
81672	15mm

Screwdrivers and Pliers

80051	12 Pc. Combination Screwdriver Set
80012	1/4" x 1-1/2" Slotted
80018	3/16" x 6" Slotted w/Cabinet Tip
80013	1/4" x 4" Slotted w/Hex Bolster
80014	1/4" x 6" Slotted w/Hex Bolster
80023	5/16" x 6" Slotted w/Hex Bolster
80022	3/8" x 8" Slotted w/Hex Bolster
80000	#0 x 2-1/2" Phillips
80001	#1 x 3" Phillips
80004	#1 x 6" Phillips
80005	#2 x 1-1/2" Phillips
80007	#2 x 4" Phillips w/Hex Bolster
80011	#3 x 6" Phillips w/Hex Bolster

82108	7 Pc. Mixed Pliers Set
82011	Tongue and Groove
82012	Diagonal Cutting
82013	Long Nose
82014	Slip Joint
82020	12" Groove Joint with Straight Jaw
82025	8" Linesman
82028	8" End Nipper
82005	Straight Double-X™ Pliers

Hex Keys

56603G	13 Pc. SAE ALLEN® Hex Key Set
Sizes: 0.050", 1/16", 5/64", 3/32", 7/64", 1/8", 9/64", 5/32", 3/16", 7/32", 1/4", 5/16", 3/8"	

56615G	9 Pc. Metric ALLEN® Ball End Hex Key Set
Sizes: 1.5, 2, 2.5, 3, 4, 5, 6, 8, 10mm	

Punch & Chisels

82305	12 Pc. Punch and Chisel Set
82261	1/4" x 4-3/4" x 1/4" Cold Chisel
82262	3/8" x 5" x 5/16" Cold Chisel
82264	1/2" x 6" x 3/8" Cold Chisel
82265	5/8" x 6-1/2" x 3/8" Cold Chisel
82270	3/8" x 5" Center Punch
82272	3/32" x 4-3/4" x 5/16" Pin Punch
82273	1/8" x 5" x 5/16" Pin Punch
82274	5/32" x 5-1/4" x 5/16" Pin Punch

82275	3/16" x 5-1/2" x 5/16" Pin Punch
82278	1/8" x 8" x 3/8" Long Taper Punch
82283	3/16" x 5" x 3/8" Starter Punch
82285	1/8" x 4-1/2" x 5/16" Starter

Torx® Bit Sockets

80723	13 Pc. Torx® Press Fit Bit Socket Set 1/4", 3/8", 1/2" Drive
80171	T-8, 1/4" Drive
80172	T-10, 1/4" Drive
80173	T-15, 1/4" Drive
80174	T-20, 1/4" Drive
80175	T-25, 1/4" Drive
80176	T-27, 1/4" Drive
80177	T-30, 1/4" Drive
80451	T-40, 3/8" Drive
80452	T-45, 3/8" Drive
80453	T-47, 3/8" Drive
80454	T-50, 3/8" Drive
80455	T-55, 3/8" Drive
80667	T-60, 1/2" Drive

General Purpose Tools

82880	High Tension Hacksaw
82251	16 oz Ball Pein Hammer - Fiberglass
82260	12 oz Soffface Hammer Removable Caps
82255	3 lb Drilling Hammer
82259	16 oz Rubber Mallet - Wood Hickory
82881	Folding Utility Knife
83131	Intermediate Aviation Set
83132	Intermediate Aviation Set
82102	3 Pc. Locking Pliers Set
82043	Long Nose Locking Pliers 6"
990	Curved Jaw Locking Pliers 5"
990	Curved Jaw Locking Pliers 10"
69-990	Safety Glasses

KD® Specialty Tools

KDS129	Low Voltage Circuit Tester
KDS162	16 Blade Feeler Gauge
KDS485	Gasket Scraper
KDS2282	Slotted Screw Starter
KDS2283	Phillips Screw Starter
KDS2774	Brake Retaining Spring Tool
KDS298	Brake Spring Pliers
KDS295	Brake Shoe Adjusting Tool
KDS3163	Rear Brake Piston Tool
KDS2840	Telescoping Mirror
KDS2593	Telescoping Magnetic Pick-Up Tool
KDS3151	Interchangeable Snap Ring Pliers
KDS2162	Wire Stripper Crimper

Not all tools GearWrench® Branded

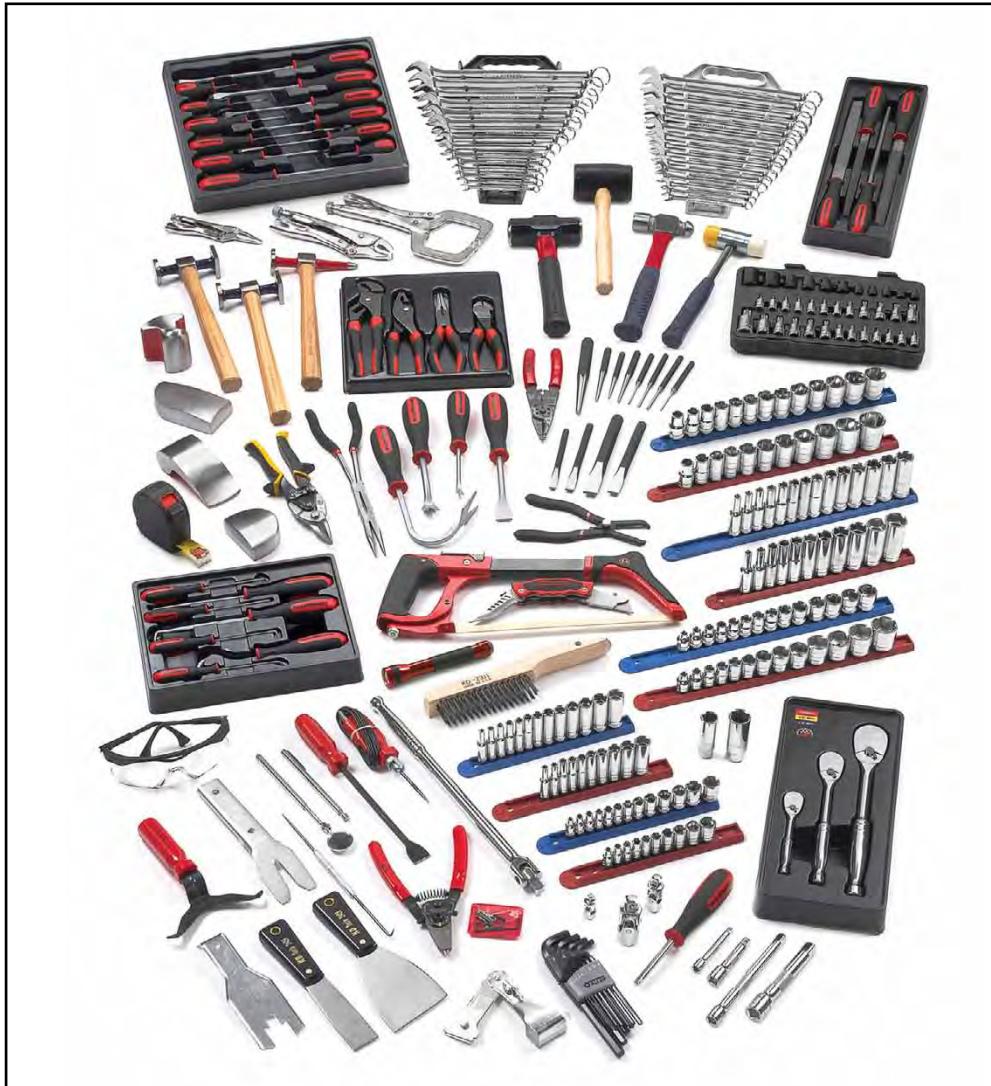

83097 - Intermediate Auto Body Tool Set

80392	10mm	80399	17mm
80393	11mm	80400	18mm
80394	12mm	80401	19mm

80555 11 Pc. 6 Pt. Deep SAE Socket Set

80363	1/4"	80369	9/16"
80364	5/16"	80370	5/8"
80365	3/8"	80371	11/16"
80366	1/4"	80372	3/4"
80367	7/16"	80373	7/8"
80368	1/2"		

1/2" Drive Sockets

80702 13 Pc. 6 Pt. Metric Socket Set

81624	12mm	81631	19mm
81625	13mm	81632	20mm
81626	14mm	81633	21mm
81627	15mm	81634	22mm
81628	16mm	81635	23mm
81629	17mm	81636	24mm
81630	18mm		

80703 11 Pc. 6 Pt. SAE Socket Set

80603	1/2"	80609	7/8"
80604	9/16"	80610	15/16"
80605	5/8"	80611	1"
80606	11/16"	80612	1-1/16"
80607	3/4"	80613	1-1/8"
80608	13/16"		

1/4", 3/8", 1/2" Drive Sockets

81206 3 Pc. Full Polish Ratchet Set (1/4", 3/8", 1/2" Drive)

81113	3" Extension 1/4" Drive
80100	Universal Joint 1/4" Drive
81128	Spinner Handle 1/4" Drive
81241	3" Extension 3/8" Drive
81242	6" Extension 3/8" Drive
80549	Universal Joint 3/8" Drive
80402	Intermediate Auto Body Set
80403	13/16" Spark Plug Socket 3/8" Dr.
80600	Universal Joint 1/2" Drive
81341	5" Extension 1/2" Drive
81307	Full Polish Flex Handle 1/2" Drive

81901 15 Pc. SAE Long Pattern Combination Non-Ratcheting Wrench Set

81650	1/4"	81658	5/8"
81651	9/32"	81659	11/16"
81652	5/16"	81660	3/4"
81653	11/32"	81661	13/16"
81654	3/8"	81662	7/8"
81655	7/16"	81663	15/16"

1/4" Drive Sockets

80302 13 Pc. 6 Pt. Metric Socket Set

80125	4mm	80132	10mm
80126	5mm	80133	11mm
80127	5.5mm	80134	12mm
80128	6mm	80135	13mm
80129	7mm	80136	14mm
80130	8mm	80137	15mm
80131	9mm		

80303 10 Pc. 6 Pt. SAE Socket Set

80105	3/16"	80110	11/32"
80106	7/32"	80111	3/8"
80107	1/4"	80112	7/16"
80108	9/32"	80113	1/2"
80109	5/16"	80114	9/16"

80304 13 Pc. 6 Pt. Deep Metric Socket Set

80138	4mm	80145	10mm
-------	-----	-------	------

80139	5mm	80146	11mm
80140	5.5mm	80147	12mm
80141	6mm	80148	13mm
80142	7mm	80149	14mm
80143	8mm	80150	15mm
80144	9mm		

80305 10 Pc. 6 Pt. Deep SAE Socket Set

80115	3/16"	80120	11/32"
80116	7/32"	80121	3/8"
80117	1/4"	80122	7/16"
80118	9/32"	80123	1/2"
80119	5/16"	80124	9/16"

3/8" Drive Sockets

80552 14 Pc. 6 Pt. Metric Socket Set

80374	6mm	80381	13mm
80375	7mm	80382	14mm
80376	8mm	80383	15mm

80377	9mm	80384	16mm
80378	10mm	80385	17mm
80379	11mm	80386	18mm
80380	12mm	80387	19mm

80553 13 Pc. 6 Pt. SAE Socket Set

80350	1/4"	80357	11/16"
80351	5/16"	80358	3/4"
80352	3/8"	80359	13/16"
80353	7/16"	80360	7/8"
80354	1/2"	80361	15/16"
80355	9/16"	80362	1"
80356	5/8"		

80554 14 Pc. 6 Pt. Deep Metric Socket Set

80388	6mm	80395	13mm
80389	7mm	80396	14mm
80390	8mm	80397	15mm
80391	9mm	80398	16mm

81656	1/2"	81664	1"
81657	9/16"		
81902	15 Pc. Metric Long Pattern Combination Non-Ratcheting Wrench Set		
81665	8mm	81673	16mm
81666	9mm	81674	17mm
81667	10mm	81675	18mm
81668	11mm	81676	19mm
81669	12mm	81677	20mm
81670	13mm	81678	21mm
81671	14mm	81679	22mm
81672	15mm		

Screwdrivers and Pliers

80051	12 Pc. Combination Screwdriver Set		
80012	1/4" x 1-1/2"	Slotted	
80018	3/16" x 6"	Slotted w/Cabinet Tip	
80013	1/4" x 4"	Slotted w/Hex Bolster	
80014	1/4" x 6"	Slotted w/Hex Bolster	
80023	5/16" x 6"	Slotted w/Hex Bolster	
80022	3/8" x 8"	Slotted w/Hex Bolster	
80000	#0 x 2-1/2"	Phillips	
80001	#1 x 3"	Phillips	
80004	#1 x 6"	Phillips	
80005	#2 x 1-1/2"	Phillips	
80007	#2 x 4"	Phillips w/Hex Bolster	
80011	#3 x 6"	Phillips w/Hex Bolster	
82103	4 Pc. Mixed Pliers Set		
82011	9.5"	Tongue and Groove	
82012	7"	Diagonal Cutting	
82013	8"	Long Nose	

Hex Keys

566036 13 Pc. SAE ALLEN® Hex Key Set
 Sizes: 0.050", 1/16", 5/64", 3/32", 7/64", 1/8", 9/64", 5/32", 3/16", 7/32", 1/4", 5/16", 3/8"

Punch & Chisels

82305	12 Pc. Punch and Chisel Set		
82261	1/4" x 4-3/4" x 1/4"	Cold Chisel	
82262	3/8" x 5" x 5/16"	Cold Chisel	
82264	1/2" x 6" x 3/8"	Cold Chisel	
82265	5/8" x 6-1/2" x 3/8"	Cold Chisel	
82270	3/8" x 5"	Center Punch	
82272	3/32" x 4-3/4" x 5/16"	Pin Punch	
82273	1/8" x 5" x 5/16"	Pin Punch	
82274	5/32" x 5-1/4" x 5/16"	Pin Punch	
82275	3/16" x 5-1/2" x 5/16"	Pin Punch	
82278	1/8" x 8" x 3/8"	Long Taper Punch	
82283	3/16" x 5" x 3/8"	Starter Punch	
82285	1/8" x 4-1/2" x 5/16"	Long Taper Punch	

Hex and Torx® Bit Sockets

80726	36 Pc. Master Torx® Set with Hex Bit Sockets		
80172	T-10, 1/4"	Drive	
80173	T-15, 1/4"	Drive	
80174	T-20, 1/4"	Drive	
80175	T-25, 1/4"	Drive	
80176	T-27, 1/4"	Drive	
80177	T-30, 1/4"	Drive	
80187	E-5, 1/4"	Drive	
80188	E-6, 1/4"	Drive	
80189	E-7, 1/4"	Drive	
80190	E-8, 1/4"	Drive	
80451	T-40, 3/8"	Drive	
80452	T-45, 3/8"	Drive	
80453	T-47, 3/8"	Drive	
80454	T-50, 3/8"	Drive	
80455	T-55, 3/8"	Drive	
80416	5/32", 3/8"	Drive	
80417	3/16", 3/8"	Drive	
80418	7/32", 3/8"	Drive	
80419	1/4", 3/8"	Drive	
80420	5/16", 3/8"	Drive	
80421	3/8", 3/8"	Drive	
80422	2mm, 3/8"	Drive	
80423	2.5mm, 3/8"	Drive	
80424	3mm, 3/8"	Drive	
80425	4mm, 3/8"	Drive	
80426	5mm, 3/8"	Drive	
80427	6mm, 3/8"	Drive	
80428	7mm, 3/8"	Drive	
80429	8mm, 3/8"	Drive	
80430	9mm, 3/8"	Drive	
80431	10mm, 3/8"	Drive	
80460	E-10, 3/8"	Drive	
80461	E-12, 3/8"	Drive	
80462	E-14, 3/8"	Drive	
80463	E-16, 3/8"	Drive	
80669	E-18, 1/2"	Drive	

General Body Tools

84050	4 Pc. Door Pad and Panel Removal Kit		
84051	4"	V-Notch Puller	
84052	4"	Square Notch Puller	
84053	4"	Scraper	
84054	4"	Curved Blade V-Notch Puller	
84000	7 Pc. Hook And Pick Set		
84001	5"	Cotter Pin Puller	
84002	4"	Hose Pick Puller	
84003	4-1/2"	Awl	
84004	3-1/8	Mini Full Hook	
84005	3-1/8	90° Mini Hook	
84006	3-1/8	Straight Mini Hook	

84007	3-1/8	Mini Offset Hook	
82820	4 Pc. STD FileS Set		
82822	8"	Flat	
82823	8"	Round	
82824	8"	Half Round	
82825	8"	Triangle	
82302	7 Pc. Body Hammer Set		

General Body Tools

82880	High Tension	Hacksaw	
82840	Straight Cutting	Aviation Snips	
82251	16 oz	Ball Pein Hammer - Fiberglass	
82260	12 oz	Softface Hammer Removable Caps	
82255	3 lb	Drilling Hammer	
82259	16 oz	Rubber Mallet-Wood Hickory Handle	
82881	Folding	Utility Knife	
83131	Intermediate	Aviation Set	
83132	Intermediate	Aviation Set	
82041	10"	Curved Jaw Locking Pliers	
82043	6"	Long Nose Locking Pliers	
82050	11"	Swivel Pad C-Clamp Locking Pliers	
69-990	Safety	Glasses	

KD® Specialty Tools

KDS129	Low Voltage	Circuit Tester	
KDS485	Gasket	Scraper	
KDS2840	Telescoping	Mirrors	
KDS2593	Telescoping	Magnetic Pick-Up Tool	
KDS3151	Interchangeable	Snap Ring Pliers	
KDS2162	Wire Stripper	Crimper	
KDS2038	Window Molding	Remover	
KDS431	Door Handle	Window Lift Remover	
KDS2822	Trim Pad	Removal Tool	
KDS3729	Push Pin	Pliers	
KDS2979	Scribe		
KDS2106	All Purpose	Sticker Scraper Tool	
KDS2311	Shoe Handle	Wire Scratch Brush	
KDS2426	3"	Putty/Knife Scraper	
KDS2425	1-1/4"	Putty/Knife Scraper	

Not all tools GearWrench® Branded

83096 - Intermediate Diesel Tool Set



1/4" Drive Sockets

80302 13 Pc. 6 Pt. Metric Socket Set

80125	4mm	80132	10mm
80126	5mm	80133	11mm
80127	5.5mm	80134	12mm
80128	6mm	80135	13mm
80129	7mm	80136	14mm
80130	8mm	80137	15mm
80131	9mm		

80303 10 Pc. 6 Pt. SAE Socket Set

80105	3/16"	80110	11/32"
80106	7/32"	80111	3/8"
80107	1/4"	80112	7/16"
80108	9/32"	80113	1/2"
80109	5/16"	80114	9/16"

3/8" Drive Sockets

80552 14 Pc. 6 Pt. Metric Socket Set

80374	6mm	80381	13mm
80375	7mm	80382	14mm
80376	8mm	80383	15mm
80377	9mm	80384	16mm
80378	10mm	80385	17mm
80379	11mm	80386	18mm
80380	12mm	80387	19mm

80553 13 Pc. 6 Pt. SAE Socket Set

80350	1/4"	80357	11/16"
80351	5/16"	80358	3/4"
80352	3/8"	80359	13/16"
80353	7/16"	80360	7/8"
80354	1/2"	80361	15/16"
80355	9/16"	80362	1"
80356	5/8"		

80554 14 Pc. 6 Pt. Deep Metric Socket Set

80388	6mm	80395	13mm
80389	7mm	80396	14mm
80390	8mm	80397	15mm
80391	9mm	80398	16mm
80392	10mm	80399	17mm
80393	11mm	80400	18mm
80394	12mm	80401	19mm

80555 11 Pc. 6 Pt. Deep SAE Socket Set

80363	1/4"	80369	9/16"
80364	5/16"	80370	5/8"
80365	3/8"	80371	3/4"
80366	1/4"	80372	13/16"
80367	7/16"	80373	7/8"
80368	1/2"		

1/2" Drive Sockets

80702 13 Pc. 6 Pt. Metric Socket Set

81624	12mm	81631	19mm
81625	13mm	81632	20mm

81626	14mm	81633	21mm
81627	15mm	81634	22mm
81628	16mm	81635	23mm
81629	17mm	81636	24mm
81630	18mm		

80703 11 Pc. 6 Pt. SAE Socket Set

80603	1/2"	80609	7/8"
80604	9/16"	80610	15/16"
80605	5/8"	80611	1"
80606	11/16"	80612	1-1/16"
80607	3/4"	80613	1-1/8"
80608	13/16"		

80704 10 Pc. 6 Pt. Deep Metric Socket Set

80637	10mm	80642	15mm
80638	11mm	80643	16mm
80629	17mm	80644	17mm
80640	13mm	80645	18mm
80641	14mm	80646	19mm

80705 8 Pc. 6 Pt. Deep SAE Socket Set

80614	1/2"	80618	3/4"
80615	9/16"	80619	13/16"
80616	5/8"	80620	7/8"
80617	11/16"	80621	15/16"

1/4", 3/8", 1/2" Drive Sockets

81206 3 Pc. Full Polish Ratchet Set
81011 Full Polish Teardrop Ratchet 1/4" Drive
81211 Full Polish Teardrop Ratchet 3/8" Drive
81304 Full Polish Teardrop Ratchet 1/2" Drive
81113 3" Extension 1/4" Drive
80100 Universal Joint 1/4" Drive
81128 Spinner Handle 1/4" Drive
81241 3" Extension 3/8" Drive
81242 6" Extension 3/8" Drive
80549 Universal Joint 3/8" Drive
80402 Intermediate Diesel Set
80403 13/16" Spark Plug Socket 3/8" Dr.
80600 Universal Joint 1/2" Drive
81341 5" Extension 1/2" Drive
81307 Full Polish Flex Handle 1/2" Drive

Combinations Wrenches

81917 18 Pc. Long Pattern Combination Non-Ratcheting Wrench Set SAE

81650	1/4"	81659	11/16"
81651	9/32"	81660	3/4"
81652	5/16"	81661	13/16"
81653	11/32"	81662	7/8"
81654	3/8"	81663	15/16"
81655	7/16"	81664	1"
81656	1/2"	81733	1-1/6"
81657	9/16"	81734	1-1/8"
81658	5/8"	81735	1-1/4"

81916 22 Pc. Long Pattern Combination Non-Ratcheting Wrench Metric

81736	6mm	81674	17mm
81737	7mm	81675	18mm
81665	8mm	81676	19mm
81666	9mm	81677	20mm
81667	10mm	81678	21mm
81668	11mm	81679	22mm
81669	12mm	81741	23mm
81670	13mm	81742	24mm
81671	14mm	81743	27mm
81672	15mm	81744	30mm
81673	16mm	81745	32mm

Screwdrivers and Pliers

80051 12 Pc. Combination Screwdriver Set

80012	1/4" x 1-1/2" Slotted
80018	3/16" x 6" Slotted w/ Cabinet Tip
80013	1/4" x 4" Slotted w/Hex Bolster
80014	1/4" x 6" Slotted w/Hex Bolster
80023	5/16" x 6" Slotted w/Hex Bolster
80022	3/8" x 8" Slotted w/Hex Bolster
80000	#0 x 2-1/2" Phillips
80001	#1 x 3" Phillips
80004	#1 x 6" Phillips
80005	#2 x 1-1/2" Phillips
80007	#2 x 4" Phillips w/ Hex Bolster
80011	#3 x 6" Phillip w/Hex Bolster

82103 4 Pc. Mixed Pliers Set

82011	9.5" Tongue and Groove
82012	7" Diagonal Cutting
82013	8" Long Nose
82005	Straight Double-XTM

Hex Keys

566036 13 Pc. SAE ALLEN® Hex Key Set

Sizes: 0.050", 1/16", 5/64", 3/32", 7/64", 1/8", 9/64", 5/32", 3/16", 7/32", 1/4", 5/16", 3/8"

566156 9 Pc. SAE ALLEN® Ball End Hex Key Set

Sizes: 1.5, 2, 2.5, 3, 4, 5, 6, 8, 10mm

Punch & Chisel

82305 12 Pc. Punch and Chisel Set

82261	1/4" x 4-3/4" x 1/4" Cold Chisel
82262	3/8" x 5" x 5/16" Cold Chisel
82264	1/2" x 6" x 3/8" Cold Chisel
82265	5/8" x 6-1/2" x 3/8" Cold Chisel
82270	3/8" x 5" Center Punch
82272	3/32" x 4-3/4" x 5/16" Pin Punch
82273	1/8" x 5" x 5/16" Pin Punch
82274	5/32" x 5-1/4" x 5/16" Pin Punch
82275	3/16" x 5-1/2" x 5/16" Pin Punch

82278	1/8" x 8" x 3/8" Long Taper Punch
82283	3/16" x 5" x 3/8" Starter Punch
82285	1/8" x 4-1/2" x 5/16" Long Taper Punch

Torx® Bit Sockets

80723 13 Pc. Torx® Press Fit Bit Socket Set

80171	T-8, 1/4" Drive
80172	T-10, 1/4" Drive
80173	T-15, 1/4" Drive
80174	T-20, 1/4" Drive
80175	T-25, 1/4" Drive
80176	T-27, 1/4" Drive
80177	T-30, 1/4" Drive
80451	T-40, 3/8" Drive
80452	T-45, 3/8" Drive
80453	T-47, 3/8" Drive
80454	T-50, 3/8" Drive
80455	T-55, 3/8" Drive
80667	T-60, 1/2" Drive

General Purpose Tools

82220	18" to 29" Extendable Pry Bar
82880	High Tension Hacksaw
82251	16 oz Ball Pein Hammer - Fiberglass
82260	12 oz Softface Hammer Removable Caps
82255	3 lb Drilling Hammer
82259	16 oz Rubber Mallet - Wood Hickory Handle
82881	Folding Utility Knife
83131	16' Tape Measure SAE/Metric
83132	Aluminum Flashlight
82102	3 Pc. Locking Pliers Set
82043	Long Nose Locking Pliers 6"
82040	Curved Jaw Locking Pliers 5"
82041	Curved Jaw Locking Pliers 10"
69-990	Safety Glasses

KD® Specialty Tools

KDS129	Low Voltage Circuit Tester
KDS162	16 Blade Feeler Gauge
KDS485	Gasket Scraper
KDS2282	Slotted Screw Starter
KDS2283	Phillips Screw Starter
KDS2840	Telescoping Mirror
KDS2593	Telescoping Magnetic Pick-Up Tool
KDS2162	Wire Stripper Crimper

Not all tools GearWrench® Branded



83098 - Intermediate Aviation Tool Set

82827	4" Half Round Mini
82828	4" Round Mini
82829	4" Triangle Mini
82830	4" Square Mini
82831	4" Knife Mini
82305	12 Pc. Punch and Chisel Set
82261	1/4" x 4-3/4" x 1/4" Cold Chisel
82262	3/8" x 5" x 5/16" Cold Chisel
82264	1/2" x 6" x 3/8" Cold Chisel
82265	5/8" x 6-1/2" x 3/8" Cold Chisel
82270	3/8" x 5" Center Punch
82272	3/32" x 4-3/4" x 5/16" Pin Punch
82273	1/8" x 5" x 5/16" Pin Punch
82274	5/32" x 5-1/4" x 5/16" Pin Punch
82275	3/16" x 5-1/2" x 5/16" Pin Punch
82278	1/8" x 8" x 3/8" Long Taper Punch
82283	3/16" x 5" x 3/8" Starter Punch
82285	1/8" x 4-1/2" x 5/16" Long Taper Punch

General Purpose Tools

81891	8" Adjustable Cushion Grip Wrench
81893	12" Adjustable Cushion Grip Wrench
82880	High Tension Hacksaw
82251	16 oz Ball Pein Hammer - Fiberglass
82260	12 oz Softface Hammer Removable Caps
82881	Folding Utility Knife
82131	16" Tape Measure SAE/Metric
83132	Aluminum Flashlight
82040	5" Curved Jaw Locking Pliers
69-990	Safety Glasses
9-HLQM24	Hearing Protection

KD® Specialty Tools

KDS2391	23" Flexible Pick-Up Tool
KDS2109	Telescoping Mirror
KDS2593	Telescoping Magnetic Pick-Up Tools
KDS2282	Slotted Screw Starter
KDS2283	Phillips Screw Starter
KDS2425	1-1/4" Putty Knife/Scrapper
KDS2979	Scribe
KDS2309	Stainless Steel Brush
KDS3151	Interchangeable Snap Ring Pliers
KDS2162	Wire Stripper Crimper
KDS162	16 Blade Feeler Gauge

Not all tools GearWrench® Branded

1/4" Drive Sockets

80307	10 Pc. 12 Pt. SAE Socket Set		
80210	3/16"	80215	11/32"
80211	7/32"	80216	3/8"
80212	1/4"	80217	7/16"
80213	9/32"	80218	1/2"
80214	5/16"	80219	9/16"

80305	10 Pc. 6 Pt. Deep SAE Socket Set		
80115	3/16"	80120	11/32"
80116	7/32"	80121	3/8"
80117	1/4"	80122	7/16"
80118	9/32"	80123	1/2"
80119	5/16"	80124	9/16"

80310	7 Pc. 6 Pt. SAE Flex Socket Set		
80262	3/16"	80266	7/16"
80263	1/4"	80267	1/2"
80264	5/16"	80268	9/16"
80265	3/8"		

1/4" Drive Tools

81011	Full Polish Teardrop Ratchet
81113	3" Extension
81116	6" Extension
81128	Spinner Handle
80100	Universal Joint

3/8" Drive Sockets

80561	13 Pc. 12 Pt. SAE Socket Set
--------------	-------------------------------------

80496	1/4"	80503	11/16"
80497	5/16"	80504	3/4"
80498	3/8"	80505	13/16"
80499	7/16"	80506	7/8"
80500	1/2"	80507	15/16"
80501	9/16"	80508	1"
80502	5/8"		

80563	11 Pc. 12 Pt. Deep SAE Socket Set		
80509	1/4"	80515	9/16"
80510	5/16"	80516	5/8"
80511	3/8"	80517	11/16"
80512	1/4"	80518	3/4"
80513	7/16"	80519	7/8"
80514	1/2"		

3/8" Drive Tools

81211	Full Polish Teardrop Ratchet
81241	3" Extension
81242	6" Extension
80549	Universal Joint
80402	5/8" Spark Plug Socket
80403	13/16" Spark Plug Socket
11-935	Speeder Handle

Hex Keys

566126	13 Pc. SAE ALLEN® Ball End Hex Key Set
Sizes: Sizes: 0.050", 1/16", 5/64", 3/32", 7/64", 1/8", 9/64", 5/32", 3/16", 7/32", 1/4", 5/16", 3/8"	

Screwdrivers and Pliers

80050	6 Pc. Combination Screwdriver Set
80015	1/8" x 3" Slotted w/Cabinet Tip
80013	1/4" x 4" Slotted w/Hex Bolster
80023	5/16" x 6" Slotted w/Hex Bolster
80022	3/8" x 8" Slotted w/Hex Bolster
80001	#1 x 3" Phillips
80007	#2 x 4" Phillips w/Hex Bolster

82103	4 Pc. Mixed Pliers Set
82011	9.5" Tongue and Groove
82012	7" Diagonal Cutting
82013	8" Long Nose
82014	8" Slip Joint

Cutting Tools

82841	Right Cutting Aviation Snips
82842	Left Cutting Aviation Snips
82843	3 Pc. Aviation Snip Set

Files, Punches & Chisels

82820	4 Pc. STD File Set
82822	8" Flat
82823	8" Round
82824	8" Half Round
82825	8" Triangle File
82821	6 Pc. Mini File Set
82826	4" Flat Mini

**YOU'RE GONNA NEED
A BIGGER BOX**



TOOLS STORAGE



Tool Storage

XL Series
Ball Bearing Series
Tool Storage Accessories

**GEARWRENCH XL SERIES
TOOL STORAGE**



Trigger Lock drawer system keeps drawers in place and opens with a natural pull operation

All drawers feature Auto Return, which snaps the drawers closed in the final inches of operation



Formed with rolled over drawer walls add strength and rigidity



Double Ball-Bearing construction offers exceptional load capacity and easy slide action

GearWrench now offers the industrial strength XL Tool Storage series. Professionals have come to expect innovation and increased productivity when using GearWrench products; with the XL series you can continue to expect the same superior design and construction to make you more productive on the job. Choose XL when you need a tool storage system that stands up to your growing demands. Formed with rolled over drawer walls, heavy gauge steel bodies, and stamped drawer bottoms; the XL series provides the required strength, durability and rigidity to withstand your professional demands.



All drawers come with drawer liners

TOOL STORAGE

AVAILABLE IN:

- XL Tool Chests
- XL Tool Roller Cabinets

TOOL STORAGE

Dual gas shocks on lids offer support and easily controlled closure



A 9 mm top mat provides protection and support on all cabinets



High strength side lift handles are integrated into the box wall for added durability and lift capacity



Barrel style lock and key are unique combination for security and durability

Durable powder-coated full-polished lacquer coating protects against scratches and marring



One set of locking casters on all cabinets and carts

83156 - 42"/1066mm 8 Drawer Chest

Width (inch)	Depth (inch)	Height (inch)	Weight (lbs)	Storage Cubic Inch		
41	18-1/4	20-1/2	160	7814		
Drawer Dimensions			Width (inch)	Depth (inch)	Height (inch)	Load Wt. (lbs)
4 Drawers			22-1/2	15-1/2	2-1/4	88
4 Drawers			12	15-1/2	2-1/4	88



83157 - 42"/1066mm 11 Drawer Roller Cabinet

Width (inch)	Depth (inch)	Height (inch)	Weight (lbs)	Load Wt. (lbs)	Storage Cubic Inch	Casters
42	19	39	286	1210	12,320	5"x 2" TPR
Drawer Dimensions			Width (inch)	Depth (inch)	Height (inch)	Load Wt. (lbs)
5 Drawers			22-3/4	15-1/2	2-1/4	88
3 Drawers			12-1/4	15-1/2	2-1/4	88
1 Drawer			12-1/4	15-1/2	11-3/4	132
1 Drawer			22-3/4	15-1/2	5-1/2	88
1 Drawer			36-3/4	15-1/2	3-3/4	132

- Caster Type: TPR (Thermoplastic Rubber)



83154 - 26"/660mm 4 Drawer Chest

Width (inch)	Depth (inch)	Height (inch)	Weight (lbs)	Storage Cubic Inch		
26	16	19	73	4547		
Drawer Dimensions			Width (inch)	Depth (inch)	Height (inch)	Load Wt. (lbs)
4 Drawers			25-3/4	17-1/2	2-3/4	88
1 Tray			17	6-3/4	1-3/4	20





83155 - 26"/660mm 7 Drawer Roller Cabinet

Width (inch)	Depth (inch)	Height (inch)	Weight (lbs)	Load Wt. (lbs)	Storage Cubic Inch	Casters
26-1/2	18	39	154	880	7673	5"x 2" PP
Drawer Dimensions			Width (inch)	Depth (inch)	Height (inch)	Load Wt. (lbs)
5 Drawers			22-1/4	15-1/2	2-1/4	88
2 Drawers			22-1/4	15-1/2	5-1/2	88

- Caster Type: PP (Polypropylene)



83148 - 16 1/2"/419mm Plastic Tool Box

Length (inch)	Width (inch)	Depth (inch)	Weight (lbs)
7-3/4	16-1/2	8-1/2	3.701

- Plastic hand box with comfort grip handle
- Includes tote tray and two compartments in lid



83130 - 19"/482mm Tote Box

Length (inch)	Width (inch)	Depth (inch)	Weight (lbs)
19	6	6-1/2	10

- Dual latch with lock clasps
- Includes tote tray

83147 - 16"/406mm Tool Bag

Length (inch)	Width (inch)	Depth (inch)	Weight (lbs)
16	12-3/4	8	3.79

- All weather durable heavy-duty construction

* Tools pictured not included



83151 - 20"/508mm 3 Drawer Tool Box

Length (inch)	Width (inch)	Depth (inch)	Weight (lbs)
12	20	8-1/2	17.84

- Portable tool box with ball bearing drawer slides
- Keyed center lock for security
- Includes cantilever tray



83103 - 3 Pc. Slide Rail Socket System
1/4" 3/8" & 1/2" DRIVE

Item No.	Description
83105	Red Slide Socket Rail 1/4" Drive
83101D	Red Slide Socket Rail 3/8" Drive
83102	Red Slide Socket Rail 1/2" Drive

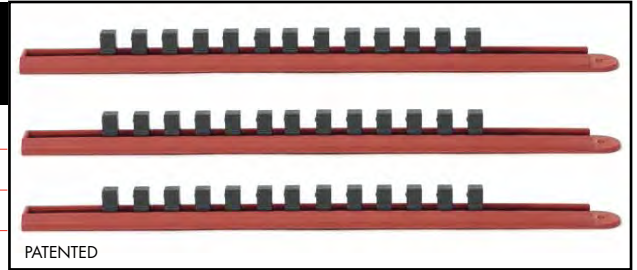

PATENTED

Open Stock - Socket Rails

Item No.	Description
83105	Red Slide Socket Rail 1/4" Drive
83101D	Red Slide Socket Rail 3/8" Drive
83102	Red Slide Socket Rail 1/2" Drive

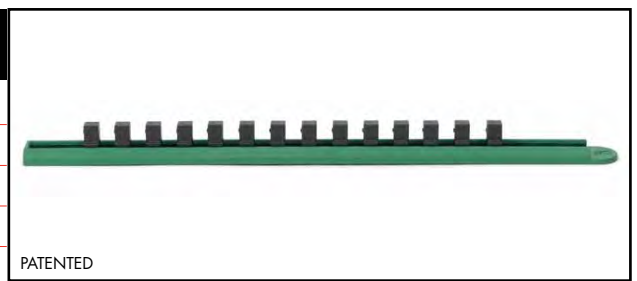

PATENTED

83104 - Universal Magnetic Parts Tray - Circular



PATENT PENDING

RATCHETS, SOCKETS & DRIVE TOOLS

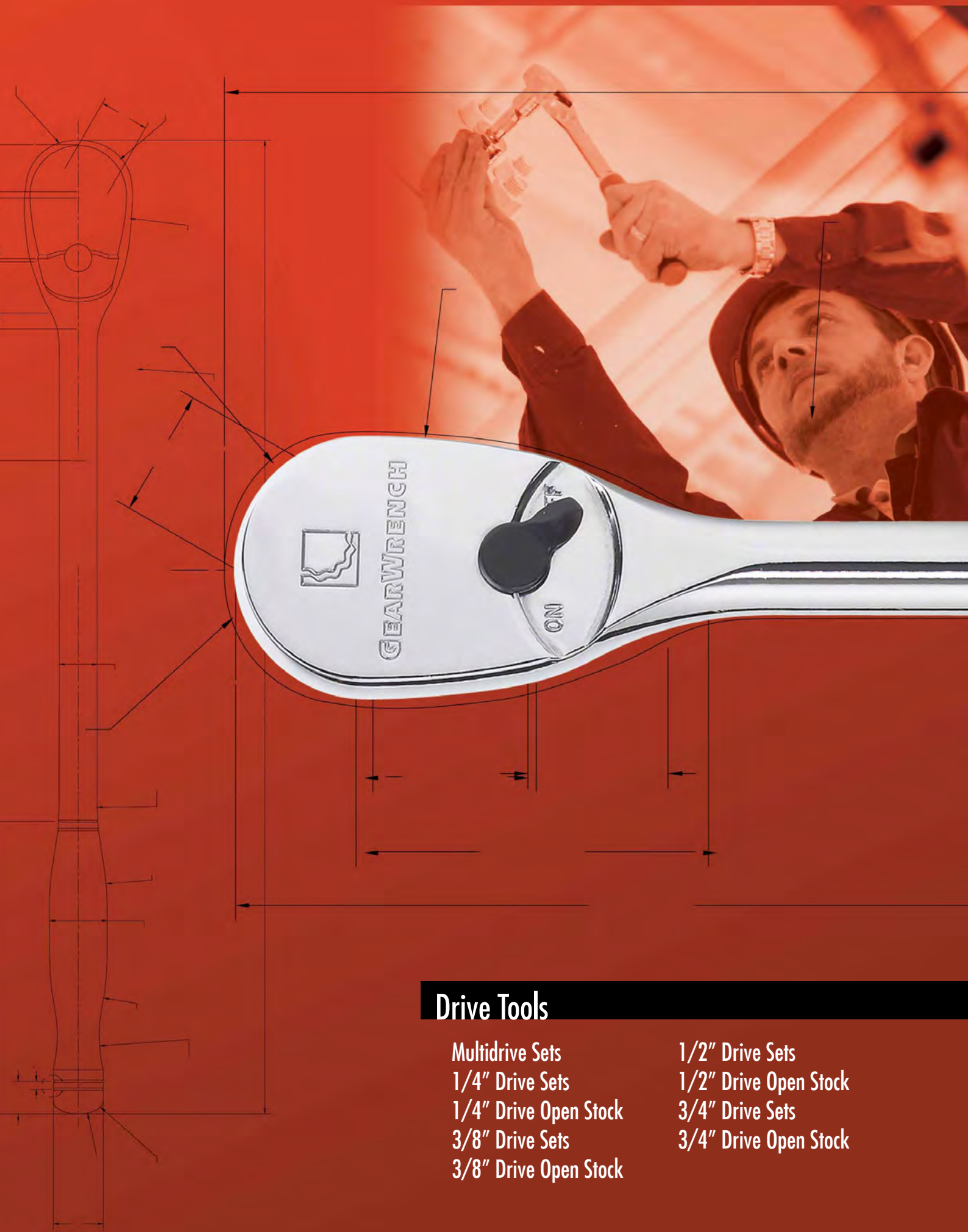

Drive Tools

Multidrive Sets
1/4" Drive Sets
1/4" Drive Open Stock
3/8" Drive Sets
3/8" Drive Open Stock

1/2" Drive Sets
1/2" Drive Open Stock
3/4" Drive Sets
3/4" Drive Open Stock

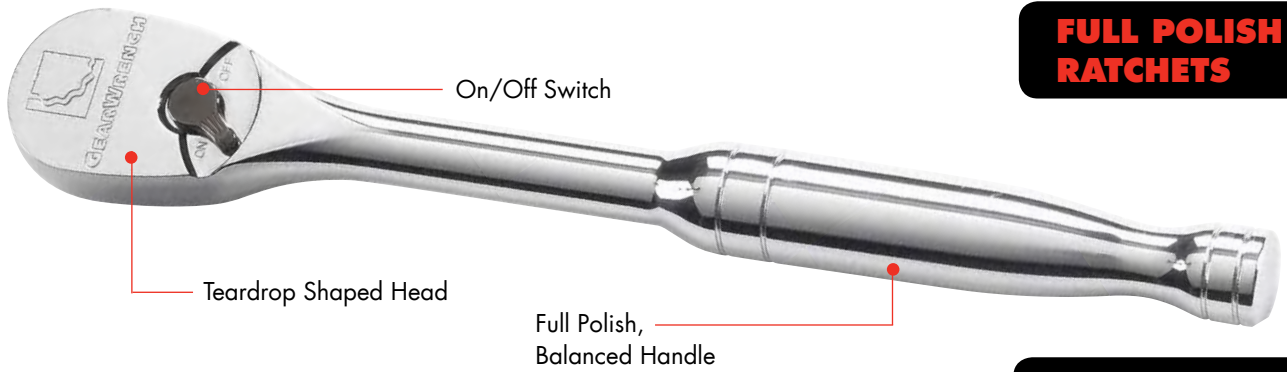

FULL POLISH RATCHETS



Lower profile head provides better access

- AVAILABLE IN:**
- Flex Head Ratchets
 - Teardrop Head Ratchets
 - Stubby Ratchets
 - Offset Ratchets



CUSHION GRIP RATCHETS

ROTO RATCHETS



Head Rotates 180 Degrees

Less Than 5 Degree Swing Arc for Greater Access



- APPLICATIONS**
- Head bolts with variable obstructions
 - Spark plug service
 - In vertical position can speed down like a screwdriver
 - In horizontal position, provides increased torque

SOCKETS

AVAILABLE IN:

- Standard
- Deep
- Spark Plug
- Flex



Entry angle guides fastener

Serration depth as deep as the fastener



Large hard-stamped identification

Double Line (SAE) & Knurled Line (MM) to easily identify Standard vs. Metric Sockets



Ordinary socket



Surface Drive® Technology

MAGNETIC DRIVE TOOLS



Knurled grip provides non-slip surface

Magnetic tip keeps the fastener in the sockets



APPLICATIONS

- Under dashboard
- Tight engine compartments
- Clean environments, where there is a need to contain fasteners from falling between gaps
- Tight access where two hands cannot fit

Strong magnetic tips allow for contact through the base of the socket to hold nuts and bolts in place during use



Products are covered by one or more of the following patents:
 • US 7,185,566

80934 - 239 Pc. SAE/METRIC 6 & 12 Pt. Mechanics Tool Set MULTI DRIVE



Material No.	Description	
80104	5/32"	6 Pt. Std. SAE Socket 1/4"Dr.
80105	3/16"	6 Pt. Std. SAE Socket 1/4"Dr.
80106	7/32"	6 Pt. Std. SAE Socket 1/4"Dr.
80107	1/4"	6 Pt. Std. SAE Socket 1/4"Dr.
80108	9/32"	6 Pt. Std. SAE Socket 1/4"Dr.
80109	5/16"	6 Pt. Std. SAE Socket 1/4"Dr.
80110	11/32"	6 Pt. Std. SAE Socket 1/4"Dr.
80111	3/8"	6 Pt. Std. SAE Socket 1/4"Dr.
80112	7/16"	6 Pt. Std. SAE Socket 1/4"Dr.
80113	1/2"	6 Pt. Std. SAE Socket 1/4"Dr.
80114	9/16"	6 Pt. Std. SAE Socket 1/4"Dr.
80125	4 mm	6 Pt. Std. Metric Socket 1/4"Dr.
80126	5 mm	6 Pt. Std. Metric Socket 1/4"Dr.
80127	5.5 mm	6 Pt. Std. Metric Socket 1/4"Dr.
80128	6 mm	6 Pt. Std. Metric Socket 1/4"Dr.
80129	7 mm	6 Pt. Std. Metric Socket 1/4"Dr.
80130	8 mm	6 Pt. Std. Metric Socket 1/4"Dr.
80131	9 mm	6 Pt. Std. Metric Socket 1/4"Dr.
80132	10 mm	6 Pt. Std. Metric Socket 1/4"Dr.
80133	11 mm	6 Pt. Std. Metric Socket 1/4"Dr.
80134	12 mm	6 Pt. Std. Metric Socket 1/4"Dr.
80135	13 mm	6 Pt. Std. Metric Socket 1/4"Dr.
80136	14 mm	6 Pt. Std. Metric Socket 1/4"Dr.
80137	15 mm	6 Pt. Std. Metric Socket 1/4"Dr.
80115	3/16"	6 Pt. Deep SAE Socket 1/4"Dr.
80116	7/32"	6 Pt. Deep SAE Socket 1/4"Dr.
80117	1/4"	6 Pt. Deep SAE Socket 1/4"Dr.
80118	9/32"	6 Pt. Deep SAE Socket 1/4"Dr.
80119	5/16"	6 Pt. Deep SAE Socket 1/4"Dr.
80120	11/32"	6 Pt. Deep SAE Socket 1/4"Dr.
80121	3/8"	6 Pt. Deep SAE Socket 1/4"Dr.
80122	7/16"	6 Pt. Deep SAE Socket 1/4"Dr.
80123	1/2"	6 Pt. Deep SAE Socket 1/4"Dr.
80124	9/16"	6 Pt. Deep SAE Socket 1/4"Dr.
80138	4 mm	6 Pt. Deep Metric Socket 1/4"Dr.
80139	5 mm	6 Pt. Deep Metric Socket 1/4"Dr.
80141	6 mm	6 Pt. Deep Metric Socket 1/4"Dr.
80142	7 mm	6 Pt. Deep Metric Socket 1/4"Dr.
80143	8 mm	6 Pt. Deep Metric Socket 1/4"Dr.
80144	9 mm	6 Pt. Deep Metric Socket 1/4"Dr.

Material No.	Description	
80145	10 mm	6 Pt. Deep Metric Socket 1/4"Dr.
80146	11 mm	6 Pt. Deep Metric Socket 1/4"Dr.
80147	12 mm	6 Pt. Deep Metric Socket 1/4"Dr.
80148	13 mm	6 Pt. Deep Metric Socket 1/4"Dr.
80149	14 mm	6 Pt. Deep Metric Socket 1/4"Dr.
80210	3/16"	12 Pt. Std. SAE Socket 1/4"Dr.
80211	7/32"	12 Pt. Std. SAE Socket 1/4"Dr.
80212	1/4"	12 Pt. Std. SAE Socket 1/4"Dr.
80213	9/32"	12 Pt. Std. SAE Socket 1/4"Dr.
80214	5/16"	12 Pt. Std. SAE Socket 1/4"Dr.
80215	11/32"	12 Pt. Std. SAE Socket 1/4"Dr.
80216	3/8"	12 Pt. Std. SAE Socket 1/4"Dr.
80217	7/16"	12 Pt. Std. SAE Socket 1/4"Dr.
80218	1/2"	12 Pt. Std. SAE Socket 1/4"Dr.
80219	9/16"	12 Pt. Std. SAE Socket 1/4"Dr.
81014	Quick-Release Teardrop Ratchet 1/4"Dr.	
81101	2" Extension 1/4"Dr.	
81113	3" Extension 1/4"Dr.	
81116	6" Extension 1/4"Dr.	
80350	1/4"	6 Pt. Std. SAE Socket 3/8" Dr.
80351	5/16"	6 Pt. Std. SAE Socket 3/8" Dr.
80352	3/8"	6 Pt. Std. SAE Socket 3/8" Dr.
80353	7/16"	6 Pt. Std. SAE Socket 3/8" Dr.
80354	1/2"	6 Pt. Std. SAE Socket 3/8" Dr.
80355	9/16"	6 Pt. Std. SAE Socket 3/8" Dr.
80356	5/8"	6 Pt. Std. SAE Socket 3/8" Dr.
80357	11/16"	6 Pt. Std. SAE Socket 3/8" Dr.

MULTI DRIVESSES RATCHETS, SOCKETS & DRIVE TOOLS

80934 - Continued

Material No.	Description			
80358	3/4"	6 Pt.	Std. SAE Socket	3/8" Dr.
80359	13/16"	6 Pt.	Std. SAE Socket	3/8" Dr.
80360	7/8"	6 Pt.	Std. SAE Socket	3/8" Dr.
80374	6 mm	6 Pt.	Std. Metric Socket	3/8" Dr.
80375	7 mm	6 Pt.	Std. Metric Socket	3/8" Dr.
80376	8 mm	6 Pt.	Std. Metric Socket	3/8" Dr.
80377	9 mm	6 Pt.	Std. Metric Socket	3/8" Dr.
80378	10 mm	6 Pt.	Std. Metric Socket	3/8" Dr.
80379	11 mm	6 Pt.	Std. Metric Socket	3/8" Dr.
80380	12 mm	6 Pt.	Std. Metric Socket	3/8" Dr.
80381	13 mm	6 Pt.	Std. Metric Socket	3/8" Dr.
80382	14 mm	6 Pt.	Std. Metric Socket	3/8" Dr.
80383	15 mm	6 Pt.	Std. Metric Socket	3/8" Dr.
80384	16 mm	6 Pt.	Std. Metric Socket	3/8" Dr.
80385	17 mm	6 Pt.	Std. Metric Socket	3/8" Dr.
80386	18 mm	6 Pt.	Std. Metric Socket	3/8" Dr.
80387	19 mm	6 Pt.	Std. Metric Socket	3/8" Dr.
80330	20 mm	6 Pt.	Std. Metric Socket	3/8" Dr.
80331	21 mm	6 Pt.	Std. Metric Socket	3/8" Dr.
80332	22 mm	6 Pt.	Std. Metric Socket	3/8" Dr.
80365	3/8"	6 Pt.	Deep SAE Socket	3/8" Dr.
80366	1/4"	6 Pt.	Deep SAE Socket	3/8" Dr.
80367	7/16"	6 Pt.	Deep SAE Socket	3/8" Dr.
80368	1/2"	6 Pt.	Deep SAE Socket	3/8" Dr.
80369	9/16"	6 Pt.	Deep SAE Socket	3/8" Dr.
80370	5/8"	6 Pt.	Deep SAE Socket	3/8" Dr.
80371	11/16"	6 Pt.	Deep SAE Socket	3/8" Dr.
80391	9 mm	6 Pt.	Deep Metric Socket	3/8" Dr.
80392	10 mm	6 Pt.	Deep Metric Socket	3/8" Dr.
80393	11 mm	6 Pt.	Deep Metric Socket	3/8" Dr.
80394	12 mm	6 Pt.	Deep Metric Socket	3/8" Dr.
80395	13 mm	6 Pt.	Deep Metric Socket	3/8" Dr.
80396	14 mm	6 Pt.	Deep Metric Socket	3/8" Dr.
80397	15 mm	6 Pt.	Deep Metric Socket	3/8" Dr.
80398	16 mm	6 Pt.	Deep Metric Socket	3/8" Dr.
80399	17 mm	6 Pt.	Deep Metric Socket	3/8" Dr.
80400	18 mm	6 Pt.	Deep Metric Socket	3/8" Dr.
80401	19 mm	6 Pt.	Deep Metric Socket	3/8" Dr.
80496	1/4"	12 Pt.	Std. SAE Socket	3/8" Dr.
80498	5/16"	12 Pt.	Std. SAE Socket	3/8" Dr.
80498	3/8"	12 Pt.	Std. SAE Socket	3/8" Dr.
80499	7/16"	12 Pt.	Std. SAE Socket	3/8" Dr.

Material No.	Description			
80500	1/2"	12 Pt.	Std. SAE Socket	3/8" Dr.
80501	9/16"	12 Pt.	Std. SAE Socket	3/8" Dr.
80502	5/8"	12 Pt.	Std. SAE Socket	3/8" Dr.
80503	11/16"	12 Pt.	Std. SAE Socket	3/8" Dr.
80504	3/4"	12 Pt.	Std. SAE Socket	3/8" Dr.
80505	13/16"	12 Pt.	Std. SAE Socket	3/8" Dr.
80506	7/8"	12 Pt.	Std. SAE Socket	3/8" Dr.
80482	6 mm	12 Pt.	Std. Metric Socket	3/8" Dr.
80483	7 mm	12 Pt.	Std. Metric Socket	3/8" Dr.
80484	8 mm	12 Pt.	Std. Metric Socket	3/8" Dr.
80485	9 mm	12 Pt.	Std. Metric Socket	3/8" Dr.
80486	10 mm	12 Pt.	Std. Metric Socket	3/8" Dr.
80487	11 mm	12 Pt.	Std. Metric Socket	3/8" Dr.
80488	12 mm	12 Pt.	Std. Metric Socket	3/8" Dr.
80489	13 mm	12 Pt.	Std. Metric Socket	3/8" Dr.
80490	14 mm	12 Pt.	Std. Metric Socket	3/8" Dr.
80491	15 mm	12 Pt.	Std. Metric Socket	3/8" Dr.
80492	16 mm	12 Pt.	Std. Metric Socket	3/8" Dr.
80493	17 mm	12 Pt.	Std. Metric Socket	3/8" Dr.
80494	18 mm	12 Pt.	Std. Metric Socket	3/8" Dr.
80495	19 mm	12 Pt.	Std. Metric Socket	3/8" Dr.
80596	20 mm	12 Pt.	Std. SAE Socket	3/8" Dr.
80597	21 mm	12 Pt.	Std. SAE Socket	3/8" Dr.
80598	22 mm	12 Pt.	Std. SAE Socket	3/8" Dr.
81218	Quick-Release Teardrop Ratchet			3/8" Dr.
82783	1/4" Magnetic Bit Holding Screwdriver			
81241	3" Extension			3/8" Dr.
81242	6" Extension			3/8" Dr.
80402	5/8"	Spark Plug Socket		3/8" Dr.
80403	13/16"	Spark Plug Socket		3/8" Dr.
80760	7/16"	12 Pt.	Std. SAE Socket	1/2" Dr.
80761	1/2"	12 Pt.	Std. SAE Socket	1/2" Dr.
80762	9/16"	12 Pt.	Std. SAE Socket	1/2" Dr.
80763	5/8"	12 Pt.	Std. SAE Socket	1/2" Dr.
80764	11/16"	12 Pt.	Std. SAE Socket	1/2" Dr.
80765	3/4"	12 Pt.	Std. SAE Socket	1/2" Dr.
80766	13/16"	12 Pt.	Std. SAE Socket	1/2" Dr.
80767	7/8"	12 Pt.	Std. SAE Socket	1/2" Dr.
80768	15/16"	12 Pt.	Std. SAE Socket	1/2" Dr.
80769	1"	12 Pt.	Std. SAE Socket	1/2" Dr.
80770	1-1/16"	12 Pt.	Std. SAE Socket	1/2" Dr.

RATCHETS, SOCKETS & DRIVE TOOLS

MULTI DRIVE SETS

80934 - Continued

Material No.	Description		
80771	1-1/8"	12 Pt.	Std. SAE Socket 1/2" Dr.
80793	1-3/16"	12 Pt.	Std. SAE Socket 1/2" Dr.
80794	1-1/4"	12 Pt.	Std. SAE Socket 1/2" Dr.
80680	1-1/2"	12 Pt.	Std. SAE Socket 1/2" Dr.
80750	15 mm	12 Pt.	Std. Metric Socket 1/2" Dr.
80751	16 mm	12 Pt.	Std. Metric Socket 1/2" Dr.
80752	17 mm	12 Pt.	Std. Metric Socket 1/2" Dr.
80753	18 mm	12 Pt.	Std. Metric Socket 1/2" Dr.
80754	19 mm	12 Pt.	Std. Metric Socket 1/2" Dr.
80755	20 mm	12 Pt.	Std. Metric Socket 1/2" Dr.
80756	21 mm	12 Pt.	Std. Metric Socket 1/2" Dr.
80757	22 mm	12 Pt.	Std. Metric Socket 1/2" Dr.
80758	23 mm	12 Pt.	Std. Metric Socket 1/2" Dr.
80759	24 mm	12 Pt.	Std. Metric Socket 1/2" Dr.
80811	25 mm	12 Pt.	Std. Metric Socket 1/2" Dr.
80681	26 mm	12 Pt.	Std. Metric Socket 1/2" Dr.
80812	27 mm	12 Pt.	Std. Metric Socket 1/2" Dr.
81309	Quick-Release Teardrop Ratchet		1/2" Dr.
81340	3" Extension		1/2" Dr.
81341	5" Extension		1/2" Dr.
81650	1/4"	12 Pt.	Non-Ratcheting Combination Wrench
81652	5/16"	12 Pt.	Non-Ratcheting Combination Wrench
81653	11/32"	12 Pt.	Non-Ratcheting Combination Wrench
81654	3/8"	12 Pt.	Non-Ratcheting Combination Wrench
81655	7/16"	12 Pt.	Non-Ratcheting Combination Wrench
81656	1/2"	12 Pt.	Non-Ratcheting Combination Wrench
81657	9/16"	12 Pt.	Non-Ratcheting Combination Wrench
81658	5/8"	12 Pt.	Non-Ratcheting Combination Wrench
81659	11/16"	12 Pt.	Non-Ratcheting Combination Wrench
81660	3/4"	12 Pt.	Non-Ratcheting Combination Wrench
81736	6 mm	12 Pt.	Non-Ratcheting Combination Wrench
81737	7 mm	12 Pt.	Non-Ratcheting Combination Wrench
81665	8 mm	12 Pt.	Non-Ratcheting Combination Wrench
81666	9 mm	12 Pt.	Non-Ratcheting Combination Wrench
81667	10 mm	12 Pt.	Non-Ratcheting Combination Wrench
81668	11 mm	12 Pt.	Non-Ratcheting Combination Wrench
81669	12 mm	12 Pt.	Non-Ratcheting Combination Wrench
81670	13 mm	12 Pt.	Non-Ratcheting Combination Wrench
81671	14 mm	12 Pt.	Non-Ratcheting Combination Wrench
81672	15 mm	12 Pt.	Non-Ratcheting Combination Wrench
81673	16 mm	12 Pt.	Non-Ratcheting Combination Wrench
81674	17 mm	12 Pt.	Non-Ratcheting Combination Wrench

Material No.	Description	
81675	18 mm	12 Pt. Non-Ratcheting Combination Wrench
81676	19 mm	12 Pt. Non-Ratcheting Combination Wrench
56603G	13 Pc. Hex Key	
56606G	9 Pc. Metric Hex Key	
	#1	Bit Phillips
	#2	Bit Phillips
	#3	Bit Phillips
	4mm	Bit Slotted
	5mm	Bit Slotted
	6mm	Bit Slotted
	T40	Bit Torx®
	T45	Bit Torx®
	T50	Bit Torx®
	3/16"	Nut Driver Bit
	1/4"	Nut Driver Bit
	5/16"	Nut Driver Bit
	11/32"	Nut Driver Bit
	3/8"	Nut Driver Bit
	7/16"	Nut Driver Bit
	1/2"	Nut Driver Bit
	5 mm	Nut Driver Bit
	6 mm	Nut Driver Bit
	7 mm	Nut Driver Bit
	8 mm	Nut Driver Bit
	9 mm	Nut Driver Bit
	10 mm	Nut Driver Bit
	11 mm	Nut Driver Bit

MULTI DRIVESSES
RATCHETS, SOCKETS & DRIVE TOOLS



80933 - 216 Pc. SAE/METRIC 6 & 12 Pt. Mechanics Tool Set MULTI DRIVE

Material No.	Description			
80104	5/32"	6 Pt.	Std. SAE Socket	1/4" Dr.
80105	3/16"	6 Pt.	Std. SAE Socket	1/4" Dr.
80106	7/32"	6 Pt.	Std. SAE Socket	1/4" Dr.
80107	1/4"	6 Pt.	Std. SAE Socket	1/4" Dr.
80108	9/32"	6 Pt.	Std. SAE Socket	1/4" Dr.
80109	5/16"	6 Pt.	Std. SAE Socket	1/4" Dr.
80110	11/32"	6 Pt.	Std. SAE Socket	1/4" Dr.
80111	3/8"	6 Pt.	Std. SAE Socket	1/4" Dr.
80112	7/16"	6 Pt.	Std. SAE Socket	1/4" Dr.
80113	1/2"	6 Pt.	Std. SAE Socket	1/4" Dr.
80114	9/16"	6 Pt.	Std. SAE Socket	1/4" Dr.
80125	4 mm	6 Pt.	Std. Metric Socket	1/4" Dr.
80126	5 mm	6 Pt.	Std. Metric Socket	1/4" Dr.
80127	5.5 mm	6 Pt.	Std. Metric Socket	1/4" Dr.
80128	6 mm	6 Pt.	Std. Metric Socket	1/4" Dr.
80129	7 mm	6 Pt.	Std. Metric Socket	1/4" Dr.
80130	8 mm	6 Pt.	Std. Metric Socket	1/4" Dr.
80131	9 mm	6 Pt.	Std. Metric Socket	1/4" Dr.
80132	10 mm	6 Pt.	Std. Metric Socket	1/4" Dr.
80133	11 mm	6 Pt.	Std. Metric Socket	1/4" Dr.
80134	12 mm	6 Pt.	Std. Metric Socket	1/4" Dr.
80135	13 mm	6 Pt.	Std. Metric Socket	1/4" Dr.
80136	14 mm	6 Pt.	Std. Metric Socket	1/4" Dr.
80137	15 mm	6 Pt.	Std. Metric Socket	1/4" Dr.

Material No.	Description			
80115	3/16"	6 Pt.	Deep SAE Socket	1/4" Dr.
80116	7/32"	6 Pt.	Deep SAE Socket	1/4" Dr.
80117	1/4"	6 Pt.	Deep SAE Socket	1/4" Dr.
80118	9/32"	6 Pt.	Deep SAE Socket	1/4" Dr.
80119	5/16"	6 Pt.	Deep SAE Socket	1/4" Dr.
80120	11/32"	6 Pt.	Deep SAE Socket	1/4" Dr.
80121	3/8"	6 Pt.	Deep SAE Socket	1/4" Dr.
80122	7/16"	6 Pt.	Deep SAE Socket	1/4" Dr.
80123	1/2"	6 Pt.	Deep SAE Socket	1/4" Dr.
80124	9/16"	6 Pt.	Deep SAE Socket	1/4" Dr.
80138	4 mm	6 Pt.	Deep Metric Socket	1/4" Dr.
80139	5 mm	6 Pt.	Deep Metric Socket	1/4" Dr.
80141	6 mm	6 Pt.	Deep Metric Socket	1/4" Dr.
80142	7 mm	6 Pt.	Deep Metric Socket	1/4" Dr.
80143	8 mm	6 Pt.	Deep Metric Socket	1/4" Dr.
80144	9 mm	6 Pt.	Deep Metric Socket	1/4" Dr.
80145	10 mm	6 Pt.	Deep Metric Socket	1/4" Dr.
80146	11 mm	6 Pt.	Deep Metric Socket	1/4" Dr.
80147	12 mm	6 Pt.	Deep Metric Socket	1/4" Dr.
80148	13 mm	6 Pt.	Deep Metric Socket	1/4" Dr.
80149	14 mm	6 Pt.	Deep Metric Socket	1/4" Dr.
81014	Quick-Release Teardrop Ratchet			1/4" Dr.
81113	3" Extension			1/4" Dr.
81128	Spinner Handle			1/4" Dr.
80480	1/4"	Bit Holder Socket		1/4" Dr.
80350	1/4"	6 Pt.	Std. SAE Socket	3/8" Dr.
80351	5/16"	6 Pt.	Std. SAE Socket	3/8" Dr.
80352	3/8"	6 Pt.	Std. SAE Socket	3/8" Dr.
80353	7/16"	6 Pt.	Std. SAE Socket	3/8" Dr.
80354	1/2"	6 Pt.	Std. SAE Socket	3/8" Dr.
80355	9/16"	6 Pt.	Std. SAE Socket	3/8" Dr.
80356	5/8"	6 Pt.	Std. SAE Socket	3/8" Dr.
80357	11/16"	6 Pt.	Std. SAE Socket	3/8" Dr.
80358	3/4"	6 Pt.	Std. SAE Socket	3/8" Dr.
80359	13/16"	6 Pt.	Std. SAE Socket	3/8" Dr.
80360	7/8"	6 Pt.	Std. SAE Socket	3/8" Dr.
80377	9 mm	6 Pt.	Std. Metric Socket	3/8" Dr.
80378	10 mm	6 Pt.	Std. Metric Socket	3/8" Dr.
80379	11 mm	6 Pt.	Std. Metric Socket	3/8" Dr.

80933 - Continued

Material No.	Description			
80380	12 mm	6 Pt.	Std. Metric Socket	3/8" Dr.
80381	13 mm	6 Pt.	Std. Metric Socket	3/8" Dr.
80382	14 mm	6 Pt.	Std. Metric Socket	3/8" Dr.
80383	15 mm	6 Pt.	Std. Metric Socket	3/8" Dr.
80384	16 mm	6 Pt.	Std. Metric Socket	3/8" Dr.
80385	17 mm	6 Pt.	Std. Metric Socket	3/8" Dr.
80386	18 mm	6 Pt.	Std. Metric Socket	3/8" Dr.
80387	19 mm	6 Pt.	Std. Metric Socket	3/8" Dr.
80330	20 mm	6 Pt.	Std. Metric Socket	3/8" Dr.
80331	21 mm	6 Pt.	Std. Metric Socket	3/8" Dr.
80332	22 mm	6 Pt.	Std. Metric Socket	3/8" Dr.
80365	3/8"	6 Pt.	Deep SAE Socket	3/8" Dr.
80366	1/4"	6 Pt.	Deep SAE Socket	3/8" Dr.
80367	7/16"	6 Pt.	Deep SAE Socket	3/8" Dr.
80368	1/2"	6 Pt.	Deep SAE Socket	3/8" Dr.
80369	9/16"	6 Pt.	Deep SAE Socket	3/8" Dr.
80370	5/8"	6 Pt.	Deep SAE Socket	3/8" Dr.
80371	11/16"	6 Pt.	Deep SAE Socket	3/8" Dr.
80391	9 mm	6 Pt.	Deep Metric Socket	3/8" Dr.
80392	10 mm	6 Pt.	Deep Metric Socket	3/8" Dr.
80393	11 mm	6 Pt.	Deep Metric Socket	3/8" Dr.
80394	12 mm	6 Pt.	Deep Metric Socket	3/8" Dr.
80395	13 mm	6 Pt.	Deep Metric Socket	3/8" Dr.
80396	14 mm	6 Pt.	Deep Metric Socket	3/8" Dr.
80397	15 mm	6 Pt.	Deep Metric Socket	3/8" Dr.
80398	16 mm	6 Pt.	Deep Metric Socket	3/8" Dr.
80399	17 mm	6 Pt.	Deep Metric Socket	3/8" Dr.
80400	18 mm	6 Pt.	Deep Metric Socket	3/8" Dr.
80401	19 mm	6 Pt.	Deep Metric Socket	3/8" Dr.
80496	1/4"	12 Pt.	Std. SAE Socket	3/8" Dr.
80497	5/16"	12 Pt.	Std. SAE Socket	3/8" Dr.
80498	3/8"	12 Pt.	Std. SAE Socket	3/8" Dr.
80499	7/16"	12 Pt.	Std. SAE Socket	3/8" Dr.
80500	1/2"	12 Pt.	Std. SAE Socket	3/8" Dr.
80501	9/16"	12 Pt.	Std. SAE Socket	3/8" Dr.
80502	5/8"	12 Pt.	Std. SAE Socket	3/8" Dr.
80503	11/16"	12 Pt.	Std. SAE Socket	3/8" Dr.
80504	3/4"	12 Pt.	Std. SAE Socket	3/8" Dr.
80505	13/16"	12 Pt.	Std. SAE Socket	3/8" Dr.
80506	7/8"	12 Pt.	Std. SAE Socket	3/8" Dr.

Material No.	Description			
80485	9 mm	12 Pt.	Std. Metric Socket	3/8" Dr.
80486	10 mm	12 Pt.	Std. Metric Socket	3/8" Dr.
80487	11 mm	12 Pt.	Std. Metric Socket	3/8" Dr.
80488	12 mm	12 Pt.	Std. Metric Socket	3/8" Dr.
80489	13 mm	12 Pt.	Std. Metric Socket	3/8" Dr.
80490	14 mm	12 Pt.	Std. Metric Socket	3/8" Dr.
80491	15 mm	12 Pt.	Std. Metric Socket	3/8" Dr.
80492	16 mm	12 Pt.	Std. Metric Socket	3/8" Dr.
80493	17 mm	12 Pt.	Std. Metric Socket	3/8" Dr.
80494	18 mm	12 Pt.	Std. Metric Socket	3/8" Dr.
80495	19 mm	12 Pt.	Std. Metric Socket	3/8" Dr.
80596	20 mm	12 Pt.	Std. SAE Socket	3/8" Dr.
80597	21 mm	12 Pt.	Std. SAE Socket	3/8" Dr.
80598	22 mm	12 Pt.	Std. SAE Socket	3/8" Dr.
81218	Quick-Release Teardrop Ratchet			3/8" Dr.
81241	3" Extension			3/8" Dr.
81242	6" Extension			3/8" Dr.
80402	5/8"	Spark Plug Socket		3/8" Dr.
80403	13/16"	Spark Plug Socket		3/8" Dr.
80760	7/16"	12 Pt.	Std. SAE Socket	1/2" Dr.
80761	1/2"	12 Pt.	Std. SAE Socket	1/2" Dr.
80762	9/16"	12 Pt.	Std. SAE Socket	1/2" Dr.
80763	5/8"	12 Pt.	Std. SAE Socket	1/2" Dr.
80764	11/16"	12 Pt.	Std. SAE Socket	1/2" Dr.
80765	3/4"	12 Pt.	Std. SAE Socket	1/2" Dr.
80766	13/16"	12 Pt.	Std. SAE Socket	1/2" Dr.
80767	7/8"	12 Pt.	Std. SAE Socket	1/2" Dr.
80768	15/16"	12 Pt.	Std. SAE Socket	1/2" Dr.
80769	1"	12 Pt.	Std. SAE Socket	1/2" Dr.
80770	1-1/16"	12 Pt.	Std. SAE Socket	1/2" Dr.
80771	1-1/8"	12 Pt.	Std. SAE Socket	1/2" Dr.
80793	1-3/16"	12 Pt.	Std. SAE Socket	1/2" Dr.
80794	1-1/4"	12 Pt.	Std. SAE Socket	1/2" Dr.
80680	1-1/2"	12 Pt.	Std. SAE Socket	1/2" Dr.
80750	15 mm	12 Pt.	Std. Metric Socket	1/2" Dr.
80751	16 mm	12 Pt.	Std. Metric Socket	1/2" Dr.
80752	17 mm	12 Pt.	Std. Metric Socket	1/2" Dr.
80753	18 mm	12 Pt.	Std. Metric Socket	1/2" Dr.
80754	19 mm	12 Pt.	Std. Metric Socket	1/2" Dr.
80756	21 mm	12 Pt.	Std. Metric Socket	1/2" Dr.

MULTI DRIVESSES
RATCHETS, SOCKETS & DRIVE TOOLS

80933 - Continued

Material No.	Description		
80757	22 mm	12 Pt.	Std. Metric Socket 1/2" Dr.
80759	24 mm	12 Pt.	Std. Metric Socket 1/2" Dr.
80811	25 mm	12 Pt.	Std. Metric Socket 1/2" Dr.
80812	27 mm	12 Pt.	Std. Metric Socket 1/2" Dr.
80682	28 mm	13 Pt.	Std. Metric Socket 1/2" Dr.
80813	30 mm	12 Pt.	Std. Metric Socket 1/2" Dr.
80814	32 mm	12 Pt.	Std. Metric Socket 1/2" Dr.
81309	Quick-Release Teardrop Ratchet		1/2" Dr.
81340	3" Extension		
81650	1/4"	12 Pt.	Non-Ratcheting Combination Wrench
81652	5/16"	12 Pt.	Non-Ratcheting Combination Wrench
81653	11/32"	12 Pt.	Non-Ratcheting Combination Wrench
81654	3/8"	12 Pt.	Non-Ratcheting Combination Wrench
81655	7/16"	12 Pt.	Non-Ratcheting Combination Wrench
81656	1/2"	12 Pt.	Non-Ratcheting Combination Wrench
81657	9/16"	12 Pt.	Non-Ratcheting Combination Wrench
81658	5/8"	12 Pt.	Non-Ratcheting Combination Wrench
81659	11/16"	12 Pt.	Non-Ratcheting Combination Wrench
81660	3/4"	12 Pt.	Non-Ratcheting Combination Wrench
81737	7 mm	12 Pt.	Non-Ratcheting Combination Wrench
81665	8 mm	12 Pt.	Non-Ratcheting Combination Wrench
81666	9 mm	12 Pt.	Non-Ratcheting Combination Wrench
81667	10 mm	12 Pt.	Non-Ratcheting Combination Wrench
81668	11 mm	12 Pt.	Non-Ratcheting Combination Wrench
81669	12 mm	12 Pt.	Non-Ratcheting Combination Wrench
81670	13 mm	12 Pt.	Non-Ratcheting Combination Wrench
81671	14 mm	12 Pt.	Non-Ratcheting Combination Wrench
81672	15 mm	12 Pt.	Non-Ratcheting Combination Wrench
56603G	13 Pc. SAE Hex Key		
56606G	9 Pc. Metric Hex Key		
	#1	Bit Phillips	
	#2	Bit Phillips	
	#3	Bit Phillips	
	4 mm	Bit Slotted	
	5 mm	Bit Slotted	
	6 mm	Bit Slotted	
	T40	Bit Torx®	
	T45	Bit Torx®	
	T50	Bit Torx®	
	3/16"	Nut Driver Bit	

Material No.	Description	
	1/4"	Nut Driver Bit
	5/16"	Nut Driver Bit
	11/32"	Nut Driver Bit
	3/8"	Nut Driver Bit
	7/16"	Nut Driver Bit
	1/2"	Nut Driver Bit
	5 mm	Nut Driver Bit
	6 mm	Nut Driver Bit
	7 mm	Nut Driver Bit
	8 mm	Nut Driver Bit
	9 mm	Nut Driver Bit
	10 mm	Nut Driver Bit
	11 mm	Nut Driver Bit

MULTI DRIVE SETS

RATCHETS, SOCKETS & DRIVE TOOLS

80932 - 165 Pc. SAE/METRIC 6 & 12 Pt. Mechanics Tool Set MULTI DRIVE

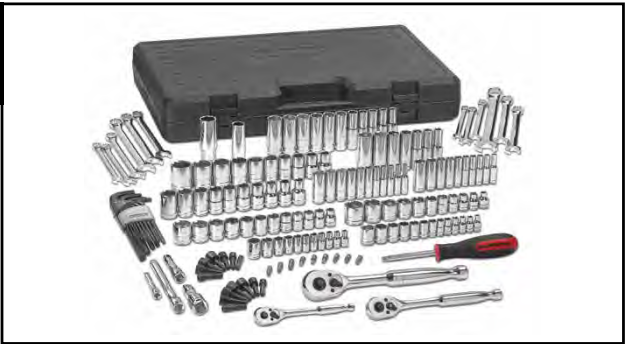

Material No.	Description	
80104	5/32"	6 Pt. Std. SAE Socket 1/4" Dr.
80105	3/16"	6 Pt. Std. SAE Socket 1/4" Dr.
80106	7/32"	6 Pt. Std. SAE Socket 1/4" Dr.
80107	1/4"	6 Pt. Std. SAE Socket 1/4" Dr.
80108	9/32"	6 Pt. Std. SAE Socket 1/4" Dr.
80109	5/16"	6 Pt. Std. SAE Socket 1/4" Dr.
80110	11/32"	6 Pt. Std. SAE Socket 1/4" Dr.
80111	3/8"	6 Pt. Std. SAE Socket 1/4" Dr.
80112	7/16"	6 Pt. Std. SAE Socket 1/4" Dr.
80113	1/2"	6 Pt. Std. SAE Socket 1/4" Dr.
80114	9/16"	6 Pt. Std. SAE Socket 1/4" Dr.
80125	4 mm	6 Pt. Std. Metric Socket 1/4" Dr.
80126	5 mm	6 Pt. Std. Metric Socket 1/4" Dr.
80127	5.5 mm	6 Pt. Std. Metric Socket 1/4" Dr.
80128	6 mm	6 Pt. Std. Metric Socket 1/4" Dr.
80129	7 mm	6 Pt. Std. Metric Socket 1/4" Dr.
80130	8 mm	6 Pt. Std. Metric Socket 1/4" Dr.
80131	9 mm	6 Pt. Std. Metric Socket 1/4" Dr.
80132	10 mm	6 Pt. Std. Metric Socket 1/4" Dr.
80133	11 mm	6 Pt. Std. Metric Socket 1/4" Dr.
80134	12 mm	6 Pt. Std. Metric Socket 1/4" Dr.
80135	13 mm	6 Pt. Std. Metric Socket 1/4" Dr.
80136	14 mm	6 Pt. Std. Metric Socket 1/4" Dr.
80137	15 mm	6 Pt. Std. Metric Socket 1/4" Dr.
80115	3/16"	6 Pt. Deep SAE Socket 1/4" Dr.
80116	7/32"	6 Pt. Deep SAE Socket 1/4" Dr.
80117	1/4"	6 Pt. Deep SAE Socket 1/4" Dr.
80118	9/32"	6 Pt. Deep SAE Socket 1/4" Dr.
80119	5/16"	6 Pt. Deep SAE Socket 1/4" Dr.
80120	11/32"	6 Pt. Deep SAE Socket 1/4" Dr.
80121	3/8"	6 Pt. Deep SAE Socket 1/4" Dr.
80122	7/16"	6 Pt. Deep SAE Socket 1/4" Dr.
80123	1/2"	6 Pt. Deep SAE Socket 1/4" Dr.
80124	9/16"	6 Pt. Deep SAE Socket 1/4" Dr.
80138	4 mm	6 Pt. Deep Metric Socket 1/4" Dr.
80139	5 mm	6 Pt. Deep Metric Socket 1/4" Dr.
80141	6 mm	6 Pt. Deep Metric Socket 1/4" Dr.
80142	7 mm	6 Pt. Deep Metric Socket 1/4" Dr.
80143	8 mm	6 Pt. Deep Metric Socket 1/4" Dr.

Material No.	Description	
80144	9 mm	6 Pt. Deep Metric Socket 1/4" Dr.
80145	10 mm	6 Pt. Deep Metric Socket 1/4" Dr.
80146	11 mm	6 Pt. Deep Metric Socket 1/4" Dr.
80147	12 mm	6 Pt. Deep Metric Socket 1/4" Dr.
80148	13 mm	6 Pt. Deep Metric Socket 1/4" Dr.
80149	14 mm	6 Pt. Deep Metric Socket 1/4" Dr.
81014	Quick-Release Teardrop Ratchet 1/4" Dr.	
81113	3" Extension 1/4" Dr.	
80480	1/4" Bit Holder Socket 1/4" Dr.	
81128	Spinner Handle 1/4" Dr.	
80350	1/4"	6 Pt. Std. SAE Socket 3/8" Dr.
80351	5/16"	6 Pt. Std. SAE Socket 3/8" Dr.
80352	3/8"	6 Pt. Std. SAE Socket 3/8" Dr.
80353	7/16"	6 Pt. Std. SAE Socket 3/8" Dr.
80354	1/2"	6 Pt. Std. SAE Socket 3/8" Dr.
80355	9/16"	6 Pt. Std. SAE Socket 3/8" Dr.
80356	5/8"	6 Pt. Std. SAE Socket 3/8" Dr.
80357	11/16"	6 Pt. Std. SAE Socket 3/8" Dr.
80358	3/4"	6 Pt. Std. SAE Socket 3/8" Dr.
80359	13/16"	6 Pt. Std. SAE Socket 3/8" Dr.
80360	7/8"	6 Pt. Std. SAE Socket 3/8" Dr.
80377	9 mm	6 Pt. Std. Metric Socket 3/8" Dr.
80378	10 mm	6 Pt. Std. Metric Socket 3/8" Dr.
80379	11 mm	6 Pt. Std. Metric Socket 3/8" Dr.
80380	12 mm	6 Pt. Std. Metric Socket 3/8" Dr.
80381	13 mm	6 Pt. Std. Metric Socket 3/8" Dr.
80382	14 mm	6 Pt. Std. Metric Socket 3/8" Dr.
80383	15 mm	6 Pt. Std. Metric Socket 3/8" Dr.
80384	16 mm	6 Pt. Std. Metric Socket 3/8" Dr.
80385	17 mm	6 Pt. Std. Metric Socket 3/8" Dr.
80386	18 mm	6 Pt. Std. Metric Socket 3/8" Dr.
80387	19 mm	6 Pt. Std. Metric Socket 3/8" Dr.
80330	20 mm	6 Pt. Std. Metric Socket 3/8" Dr.

MULTI DRIVESSES RATCHETS, SOCKETS & DRIVE TOOLS

80932 - Continued

Material No.	Description			
80365	3/8"	6 Pt.	Deep SAE Socket	3/8" Dr.
80366	1/4"	6 Pt.	Deep SAE Socket	3/8" Dr.
80367	7/16"	6 Pt.	Deep SAE Socket	3/8" Dr.
80368	1/2"	6 Pt.	Deep SAE Socket	3/8" Dr.
80369	9/16"	6 Pt.	Deep SAE Socket	3/8" Dr.
80370	5/8"	6 Pt.	Deep SAE Socket	3/8" Dr.
80371	11/16"	6 Pt.	Deep SAE Socket	3/8" Dr.
80391	9 mm	6 Pt.	Deep Metric Socket	3/8" Dr.
80392	10 mm	6 Pt.	Deep Metric Socket	3/8" Dr.
80393	11 mm	6 Pt.	Deep Metric Socket	3/8" Dr.
80394	12 mm	6 Pt.	Deep Metric Socket	3/8" Dr.
80395	13 mm	6 Pt.	Deep Metric Socket	3/8" Dr.
80396	14 mm	6 Pt.	Deep Metric Socket	3/8" Dr.
80397	15 mm	6 Pt.	Deep Metric Socket	3/8" Dr.
80398	16 mm	6 Pt.	Deep Metric Socket	3/8" Dr.
80399	17 mm	6 Pt.	Deep Metric Socket	3/8" Dr.
80400	18 mm	6 Pt.	Deep Metric Socket	3/8" Dr.
80401	19 mm	6 Pt.	Deep Metric Socket	3/8" Dr.
81218	Quick-Release Teardrop Ratchet			3/8" Dr.
81241	3" Extension			3/8" Dr.
81242	6" Extension			3/8" Dr.
80402	5/8"	Spark Plug Socket		3/8" Dr.
80403	13/16"	Spark Plug Socket		3/8" Dr.
80602	7/16"	6 Pt.	Std. SAE Socket	1/2" Dr.
80603	1/2"	6 Pt.	Std. SAE Socket	1/2" Dr.
80604	9/16"	6 Pt.	Std. SAE Socket	1/2" Dr.
80605	5/8"	6 Pt.	Std. SAE Socket	1/2" Dr.
80606	11/16"	6 Pt.	Std. SAE Socket	1/2" Dr.
80607	3/4"	6 Pt.	Std. SAE Socket	1/2" Dr.
80608	13/16"	6 Pt.	Std. SAE Socket	1/2" Dr.
80609	7/8"	6 Pt.	Std. SAE Socket	1/2" Dr.
80610	15/16"	6 Pt.	Std. SAE Socket	1/2" Dr.
80611	1"	6 Pt.	Std. SAE Socket	1/2" Dr.
80622	10 mm	6 Pt.	Std. Metric Socket	1/2" Dr.
80623	11 mm	6 Pt.	Std. Metric Socket	1/2" Dr.
80624	12 mm	6 Pt.	Std. Metric Socket	1/2" Dr.
80625	13 mm	6 Pt.	Std. Metric Socket	1/2" Dr.
80626	14 mm	6 Pt.	Std. Metric Socket	1/2" Dr.
80627	15 mm	6 Pt.	Std. Metric Socket	1/2" Dr.
80628	16 mm	6 Pt.	Std. Metric Socket	1/2" Dr.
80629	17 mm	6 Pt.	Std. Metric Socket	1/2" Dr.

Material No.	Description			
80630	18 mm	6 Pt.	Std. Metric Socket	1/2" Dr.
80631	19 mm	6 Pt.	Std. Metric Socket	1/2" Dr.
81309	Quick-Release Teardrop Ratchet			1/2" Dr.
81340	3" Extension			1/2" Dr.
81652	5/16"	12 Pt. Non-Ratcheting Combination Wrench		
81654	3/8"	12 Pt. Non-Ratcheting Combination Wrench		
81655	7/16"	12 Pt. Non-Ratcheting Combination Wrench		
81656	1/2"	12 Pt. Non-Ratcheting Combination Wrench		
81657	9/16"	12 Pt. Non-Ratcheting Combination Wrench		
81660	3/4"	12 Pt. Non-Ratcheting Combination Wrench		
81666	9 mm	12 Pt. Non-Ratcheting Combination Wrench		
81667	10 mm	12 Pt. Non-Ratcheting Combination Wrench		
81669	12 mm	12 Pt. Non-Ratcheting Combination Wrench		
81670	13 mm	12 Pt. Non-Ratcheting Combination Wrench		
81671	14 mm	12 Pt. Non-Ratcheting Combination Wrench		
81672	15 mm	12 Pt. Non-Ratcheting Combination Wrench		
56603G	13 Pc SAE Hex Key			
	#1	Bit Phillips		
	#2	Bit Phillips		
	#3	Bit Phillips		
	4mm	Bit Slotted		
	5mm	Bit Slotted		
	6mm	Bit Slotted		
	T40	Bit Torx®		
	T45	Bit Torx®		
	T50	Bit Torx®		
	3/16"	Nut Driver Bit		
	1/4"	Nut Driver Bit		
	5/16"	Nut Driver Bit		
	11/32"	Nut Driver Bit		
	3/8"	Nut Driver Bit		
	7/16"	Nut Driver Bit		
	1/2"	Nut Driver Bit		
	5 mm	Nut Driver Bit		
	6 mm	Nut Driver Bit		
	7 mm	Nut Driver Bit		
	8 mm	Nut Driver Bit		
	9 mm	Nut Driver Bit		
	10 mm	Nut Driver Bit		
	11 mm	Nut Driver Bit		

MULTI DRIVE SETS
RATCHETS, SOCKETS & DRIVE TOOLS

80931 - 141 Pc. SAE/METRIC 6 & 12 Pt. Mechanics Tool Set MULTI DRIVE



Material No.	Description			
80104	5/32"	6 Pt.	Std. SAE Socket	1/4" Dr.
80105	3/16"	6 Pt.	Std. SAE Socket	1/4" Dr.
80106	7/32"	6 Pt.	Std. SAE Socket	1/4" Dr.
80107	1/4"	6 Pt.	Std. SAE Socket	1/4" Dr.
80108	9/32"	6 Pt.	Std. SAE Socket	1/4" Dr.
80109	5/16"	6 Pt.	Std. SAE Socket	1/4" Dr.
80110	11/32"	6 Pt.	Std. SAE Socket	1/4" Dr.
80111	3/8"	6 Pt.	Std. SAE Socket	1/4" Dr.
80112	7/16"	6 Pt.	Std. SAE Socket	1/4" Dr.
80113	1/2"	6 Pt.	Std. SAE Socket	1/4" Dr.
80125	4 mm	6 Pt.	Std. Metric Socket	1/4" Dr.
80126	5 mm	6 Pt.	Std. Metric Socket	1/4" Dr.
80127	5.5 mm	6 Pt.	Std. Metric Socket	1/4" Dr.
80128	6 mm	6 Pt.	Std. Metric Socket	1/4" Dr.
80129	7 mm	6 Pt.	Std. Metric Socket	1/4" Dr.
80130	8 mm	6 Pt.	Std. Metric Socket	1/4" Dr.
80131	9 mm	6 Pt.	Std. Metric Socket	1/4" Dr.
80132	10 mm	6 Pt.	Std. Metric Socket	1/4" Dr.
80133	11 mm	6 Pt.	Std. Metric Socket	1/4" Dr.
80134	12 mm	6 Pt.	Std. Metric Socket	1/4" Dr.
80135	13 mm	6 Pt.	Std. Metric Socket	1/4" Dr.
80117	1/4"	6 Pt.	Deep SAE Socket	1/4" Dr.
80118	9/32"	6 Pt.	Deep SAE Socket	1/4" Dr.
80119	5/16"	6 Pt.	Deep SAE Socket	1/4" Dr.
80120	11/32"	6 Pt.	Deep SAE Socket	1/4" Dr.
80121	3/8"	6 Pt.	Deep SAE Socket	1/4" Dr.
80122	7/16"	6 Pt.	Deep SAE Socket	1/4" Dr.
80123	1/2"	6 Pt.	Deep SAE Socket	1/4" Dr.
80142	7 mm	6 Pt.	Deep Metric Socket	1/4" Dr.
80143	8 mm	6 Pt.	Deep Metric Socket	1/4" Dr.
80144	9 mm	6 Pt.	Deep Metric Socket	1/4" Dr.
80145	10 mm	6 Pt.	Deep Metric Socket	1/4" Dr.
80146	11 mm	6 Pt.	Deep Metric Socket	1/4" Dr.
80147	12 mm	6 Pt.	Deep Metric Socket	1/4" Dr.
80148	13 mm	6 Pt.	Deep Metric Socket	1/4" Dr.
81014	Quick-Release Teardrop Ratchet			1/4" Dr.
81113	3" Extension			1/4" Dr.

Material No.	Description			
80480	1/4"		Bit Holder Socket	1/4" Dr.
80352	3/8"	6 Pt.	Std. SAE Socket	3/8" Dr.
80353	7/16"	6 Pt.	Std. SAE Socket	3/8" Dr.
80354	1/2"	6 Pt.	Std. SAE Socket	3/8" Dr.
80355	9/16"	6 Pt.	Std. SAE Socket	3/8" Dr.
80356	5/8"	6 Pt.	Std. SAE Socket	3/8" Dr.
80357	11/16"	6 Pt.	Std. SAE Socket	3/8" Dr.
80358	3/4"	6 Pt.	Std. SAE Socket	3/8" Dr.
80378	10 mm	6 Pt.	Std. Metric Socket	3/8" Dr.
80379	11 mm	6 Pt.	Std. Metric Socket	3/8" Dr.
80380	12 mm	6 Pt.	Std. Metric Socket	3/8" Dr.
80381	13 mm	6 Pt.	Std. Metric Socket	3/8" Dr.
80382	14 mm	6 Pt.	Std. Metric Socket	3/8" Dr.
80383	15 mm	6 Pt.	Std. Metric Socket	3/8" Dr.
80384	16 mm	6 Pt.	Std. Metric Socket	3/8" Dr.
80385	17 mm	6 Pt.	Std. Metric Socket	3/8" Dr.
80386	18 mm	6 Pt.	Std. Metric Socket	3/8" Dr.
80387	19 mm	6 Pt.	Std. Metric Socket	3/8" Dr.
80365	3/8"	6 Pt.	Deep SAE Socket	3/8" Dr.
80366	1/4"	6 Pt.	Deep SAE Socket	3/8" Dr.
80367	7/16"	6 Pt.	Deep SAE Socket	3/8" Dr.
80368	1/2"	6 Pt.	Deep SAE Socket	3/8" Dr.
80369	9/16"	6 Pt.	Deep SAE Socket	3/8" Dr.
80370	5/8"	6 Pt.	Deep SAE Socket	3/8" Dr.
80371	11/16"	6 Pt.	Deep SAE Socket	3/8" Dr.

MULTI DRIVESSES
RATCHETS, SOCKETS & DRIVE TOOLS

80931 - Continued

Material No.	Description		
80392	10 mm	6 Pt.	Deep Metric Socket 3/8" Dr.
80393	11 mm	6 Pt.	Deep Metric Socket 3/8" Dr.
80394	12 mm	6 Pt.	Deep Metric Socket 3/8" Dr.
80395	13 mm	6 Pt.	Deep Metric Socket 3/8" Dr.
80396	14 mm	6 Pt.	Deep Metric Socket 3/8" Dr.
80397	15 mm	6 Pt.	Deep Metric Socket 3/8" Dr.
80398	16 mm	6 Pt.	Deep Metric Socket 3/8" Dr.
80399	17 mm	6 Pt.	Deep Metric Socket 3/8" Dr.
80400	18 mm	6 Pt.	Deep Metric Socket 3/8" Dr.
80401	19 mm	6 Pt.	Deep Metric Socket 3/8" Dr.
80498	3/8"	12 Pt.	Std. SAE Socket 3/8" Dr.
80499	7/16"	12 Pt.	Std. SAE Socket 3/8" Dr.
80500	1/2"	12 Pt.	Std. SAE Socket 3/8" Dr.
80501	9/16"	12 Pt.	Std. SAE Socket 3/8" Dr.
80502	5/8"	12 Pt.	Std. SAE Socket 3/8" Dr.
80503	11/16"	12 Pt.	Std. SAE Socket 3/8" Dr.
80504	3/4"	12 Pt.	Std. SAE Socket 3/8" Dr.
80489	13 mm	12 Pt.	Std. Metric Socket 3/8" Dr.
80490	14 mm	12 Pt.	Std. Metric Socket 3/8" Dr.
80491	15 mm	12 Pt.	Std. Metric Socket 3/8" Dr.
80492	16 mm	12 Pt.	Std. Metric Socket 3/8" Dr.
80493	17 mm	12 Pt.	Std. Metric Socket 3/8" Dr.
80494	18 mm	12 Pt.	Std. Metric Socket 3/8" Dr.
80495	19 mm	12 Pt.	Std. Metric Socket 3/8" Dr.
81218	Quick-Release Teardrop Ratchet		3/8" Dr.
81242	6" Extension		3/8" Dr.
80402	5/8"	Spark Plug Socket	3/8" Dr.
80764	11/16"	12 Pt. Std. SAE Socket	1/2" Dr.
80765	3/4"	12 Pt. Std. SAE Socket	1/2" Dr.
80766	13/16"	12 Pt. Std. SAE Socket	1/2" Dr.
80767	7/8"	12 Pt. Std. SAE Socket	1/2" Dr.
80768	15/16"	12 Pt. Std. SAE Socket	1/2" Dr.
80769	1"	12 Pt. Std. SAE Socket	1/2" Dr.
80750	15 mm	12 Pt. Std. Metric Socket	1/2" Dr.
80751	16 mm	12 Pt. Std. Metric Socket	1/2" Dr.
80752	17 mm	12 Pt. Std. Metric Socket	1/2" Dr.
80753	18 mm	12 Pt. Std. Metric Socket	1/2" Dr.
80754	19 mm	12 Pt. Std. Metric Socket	1/2" Dr.
80756	21 mm	12 Pt. Std. Metric Socket	1/2" Dr.
81309	1/2" Quick Release Teardrop Ratchet		

Material No.	Description	
81340	3" Extension	1/2" Dr.
81794	10x12mm	Double Open End Wrench
81796	12x14mm	Double Open End Wrench
81799	3/8"x7/16"	Double Open End Wrench
81801	1/2"x9/16"	Double Open End Wrench
56603G	13 Pc. SAE Hex Key Set	
	#1	Bit Phillips
	#2	Bit Phillips
	#3	Bit Phillips
	4mm	Bit Slotted
	5mm	Bit Slotted
	6mm	Bit Slotted
	T40	Bit Torx®
	T45	Bit Torx®
	T50	Bit Torx®
	3/16"	Nut Driver Bit
	1/4"	Nut Driver Bit
	5/16"	Nut Driver Bit
	11/32"	Nut Driver Bit
	3/8"	Nut Driver Bit
	7/16"	Nut Driver Bit
	1/2"	Nut Driver Bit
	5 mm	Nut Driver Bit
	6 mm	Nut Driver Bit
	7 mm	Nut Driver Bit
	8 mm	Nut Driver Bit
	9 mm	Nut Driver Bit
	10 mm	Nut Driver Bit
	11 mm	Nut Driver Bit

MULTI DRIVE SETS
RATCHETS, SOCKETS & DRIVE TOOLS

83001D - 118 Pc. SAE/METRIC 6 & 12 Pt. Standard Socket Set MULTI DRIVE

Material No. Description

80105	3/16"	6 Pt.	Std. SAE Socket	1/4" Dr.
80106	7/32"	6 Pt.	Std. SAE Socket	1/4" Dr.
80107	1/4"	6 Pt.	Std. SAE Socket	1/4" Dr.
80108	9/32"	6 Pt.	Std. SAE Socket	1/4" Dr.
80109	5/16"	6 Pt.	Std. SAE Socket	1/4" Dr.
80110	11/32"	6 Pt.	Std. SAE Socket	1/4" Dr.
80111	3/8"	6 Pt.	Std. SAE Socket	1/4" Dr.
80112	7/16"	6 Pt.	Std. SAE Socket	1/4" Dr.
80113	1/2"	6 Pt.	Std. SAE Socket	1/4" Dr.
80114	9/16"	6 Pt.	Std. SAE Socket	1/4" Dr.
80117	1/4"	6 Pt.	Deep SAE Socket	1/4" Dr.
80118	9/32"	6 Pt.	Deep SAE Socket	1/4" Dr.
80119	5/16"	6 Pt.	Deep SAE Socket	1/4" Dr.
80120	11/32"	6 Pt.	Deep SAE Socket	1/4" Dr.
80121	3/8"	6 Pt.	Deep SAE Socket	1/4" Dr.
80122	7/16"	6 Pt.	Deep SAE Socket	1/4" Dr.
80123	1/2"	6 Pt.	Deep SAE Socket	1/4" Dr.
80125	4 mm	6 Pt.	Torx® Tamper-Proof Bit Socket	1/4" Dr.
80126	5 mm	6 Pt.	Std. Metric Socket	1/4" Dr.
80128	6 mm	6 Pt.	Std. Metric Socket	1/4" Dr.
80129	7 mm	6 Pt.	Std. Metric Socket	1/4" Dr.
80130	8 mm	6 Pt.	Std. SAE Socket	1/4" Dr.
80131	9 mm	6 Pt.	Std. Metric Socket	1/4" Dr.
80132	10 mm	6 Pt.	Std. Metric Socket	1/4" Dr.
80133	11 mm	6 Pt.	Std. Metric Socket	1/4" Dr.
80134	12 mm	6 Pt.	Std. Metric Socket	1/4" Dr.
80135	13 mm	6 Pt.	Std. Metric Socket	1/4" Dr.
80142	7 mm	6 Pt.	Deep Metric Socket	1/4" Dr.
80143	8 mm	6 Pt.	Deep Metric Socket	1/4" Dr.
80144	9 mm	6 Pt.	Deep SAE Socket	1/4" Dr.
80145	10 mm	6 Pt.	Deep Metric Socket	1/4" Dr.
80146	11 mm	6 Pt.	Deep Metric Socket	1/4" Dr.
80147	12 mm	6 Pt.	Deep Metric Socket	1/4" Dr.
80148	13 mm	6 Pt.	Deep Metric Socket	1/4" Dr.
80377	9 mm	6 Pt.	Std. Metric Socket	3/8" Dr.
80378	10 mm	6 Pt.	Std. Metric Socket	3/8" Dr.
80379	11 mm	6 Pt.	Std. Metric Socket	3/8" Dr.



Material No. Description

80380	12 mm	6 Pt.	Std. Metric Socket	3/8" Dr.
80381	13 mm	6 Pt.	Std. Metric Socket	3/8" Dr.
80382	14 mm	6 Pt.	Std. Metric Socket	3/8" Dr.
80383	15 mm	6 Pt.	Std. Metric Socket	3/8" Dr.
80385	17 mm	6 Pt.	Std. Metric Socket	3/8" Dr.
80387	19 mm	6 Pt.	Std. Metric Socket	3/8" Dr.
80392	10 mm	6 Pt.	Deep Metric Socket	3/8" Dr.
80394	12 mm	6 Pt.	Deep Metric Socket	3/8" Dr.
80395	13 mm	6 Pt.	Deep Metric Socket	3/8" Dr.
80396	14 mm	6 Pt.	Deep Metric Socket	3/8" Dr.
80397	15 mm	6 Pt.	Deep SAE Socket	3/8" Dr.
80398	16 mm	6 Pt.	Deep Metric Socket	3/8" Dr.
80399	17 mm	6 Pt.	Deep Metric Socket	3/8" Dr.
80210	3/16"	12 Pt.	Std. SAE Socket	1/4" Dr.
80211	7/32"	12 Pt.	Std. SAE Socket	1/4" Dr.
80212	1/4"	12 Pt.	Std. SAE Socket	1/4" Dr.
80213	9/32"	12 Pt.	Std. SAE Socket	1/4" Dr.
80214	5/16"	12 Pt.	Std. SAE Socket	1/4" Dr.
80215	11/32"	12 Pt.	Std. SAE Socket	1/4" Dr.
80216	3/8"	12 Pt.	Std. SAE Socket	1/4" Dr.
80217	7/16"	12 Pt.	Std. SAE Socket	1/4" Dr.
80218	1/2"	12 Pt.	Std. SAE Socket	1/4" Dr.
80485	9 mm	12 Pt.	Std. Metric Socket	3/8" Dr.
80486	10 mm	12 Pt.	Std. Metric Socket	3/8" Dr.

MULTI DRIVESSES
RATCHETS, SOCKETS & DRIVE TOOLS

83001D - Continued

Material No.	Description			
80487	11 mm	12 Pt.	Std. Metric Socket	3/8" Dr.
80488	12 mm	12 Pt.	Std. Metric Socket	3/8" Dr.
80489	13 mm	12 Pt.	Std. Metric Socket	3/8" Dr.
80490	14 mm	12 Pt.	Std. Metric Socket	3/8" Dr.
80491	15 mm	12 Pt.	Std. Metric Socket	3/8" Dr.
80492	16 mm	12 Pt.	Std. Metric Socket	3/8" Dr.
80493	17 mm	12 Pt.	Std. Metric Socket	3/8" Dr.
80494	18 mm	12 Pt.	Std. Metric Socket	3/8" Dr.
80495	19 mm	12 Pt.	Std. Metric Socket	3/8" Dr.
80498	3/8"	12 Pt.	Std. SAE Socket	3/8" Dr.
80499	7/16"	12 Pt.	Std. SAE Socket	1/4" Dr.
80500	1/2"	12 Pt.	Std. SAE Socket	3/8" Dr.
80501	9/16"	12 Pt.	Std. SAE Socket	3/8" Dr.
80502	5/8"	12 Pt.	Std. SAE Socket	3/8" Dr.
80503	11/16"	12 Pt.	Std. SAE Socket	3/8" Dr.
80504	3/4"	12 Pt.	Std. SAE Socket	3/8" Dr.
80505	13/16"	12 Pt.	Std. SAE Socket	3/8" Dr.
80510	5/16"	12 Pt.	Deep SAE Socket	3/8" Dr.
80511	3/8"	12 Pt.	Deep SAE Socket	3/8" Dr.
80512	1/4"	12 Pt.	Deep SAE Socket	3/8" Dr.
80513	7/16"	12 Pt.	Std. SAE Socket	3/8" Dr.
80514	1/2"	12 Pt.	Deep SAE Socket	3/8" Dr.
80515	9/16"	12 Pt.	Deep SAE Socket	3/8" Dr.
80516	5/8"	12 Pt.	Deep SAE Socket	3/8" Dr.
80772	7/16"	12 Pt.	Deep SAE Socket	1/4" Dr.
80773	1/2"	12 Pt.	Deep SAE Socket	1/4" Dr.
80774	9/16"	12 Pt.	Deep SAE Socket	1/2" Dr.
80775	5/8"	12 Pt.	Deep SAE Socket	1/4" Dr.
80776	11/16"	12 Pt.	Deep SAE Socket	1/4" Dr.
80777	3/4"	6 Pt.	Deep SAE Socket	1/4" Dr.
80778	13/16"	12 Pt.	Deep SAE Socket	1/2" Dr.
80402	5/8" Spark Plug Socket			3/8" Dr.
80178	T-7		Torx® Tamper-Proof Bit Socket	1/4" Dr.
80179	T-8		Torx® Tamper-Proof Bit Socket	1/4" Dr.
80180	T-10		Torx® Tamper-Proof Bit Socket	1/4" Dr.
80181	T-15		Torx® Tamper-Proof Bit Socket	1/4" Dr.
80182	T-20		Torx® Tamper-Proof Bit Socket	1/4" Dr.
80471	T-10		Torx® Tamper-Proof Bit Socket	3/8" Dr.
80472	1/4"		Std. SAE Socket	1/4" Dr.
80473	1/4"		Bit Holder Socket	1/4" Dr.

Material No.	Description			
80474	1/4"		Bit Holder Socket	1/4" Dr.
80475	1/4"		Bit Holder Socket	1/4" Dr.
80476	1/4"		Bit Holder Socket	1/4" Dr.
80480	1/4"		Bit Holder Socket	1/4" Dr.
81655	7/16"		Non-Ratcheting Combination Wrench	
81656	1/2"		Non-Ratcheting Combination Wrench	
81657	9/16"		Non-Ratcheting Combination Wrench	
81675	18 mm		Non-Ratcheting Combination Wrench	
81676	19 mm		Non-Ratcheting Combination Wrench	
81119	2" Wobble Socket			1/4" Dr.
81345	5" Wobble Socket			1/2" Dr.
81241	3" Extension Socket			3/8" Dr.
81242	6" Extension			3/8" Dr.
81128	Spinner Handle			1/4" Dr.
81011	Full Polish Teardrop Ratchet			1/4" Dr.
81211	Full Polish Teardrop Ratchet			3/8" Dr.
81304	Full Polish Teardrop Ratchet			1/4" Dr.
83001BM	Replacement Blow Mold Case			

RATCHETS, SOCKETS & DRIVE TOOLS
MULTI DRIVE SETS

80930 - 88 Pc. SAE/METRIC 6 & 12 Pt. Mechanics Tool Set MULTI DRIVE



Material No.	Description			
80104	5/32"	6 Pt.	Std. SAE Socket	1/4" Dr.
80105	3/16"	6 Pt.	Std. SAE Socket	1/4" Dr.
80106	7/32"	6 Pt.	Std. SAE Socket	1/4" Dr.
80107	1/4"	6 Pt.	Std. SAE Socket	1/4" Dr.
80108	9/32"	6 Pt.	Std. SAE Socket	1/4" Dr.
80109	5/16"	6 Pt.	Std. SAE Socket	1/4" Dr.
80110	11/32"	6 Pt.	Std. SAE Socket	1/4" Dr.
80111	3/8"	6 Pt.	Std. SAE Socket	1/4" Dr.
80112	7/16"	6 Pt.	Std. SAE Socket	1/4" Dr.
80113	1/2"	6 Pt.	Std. SAE Socket	1/4" Dr.
80114	9/16"	6 Pt.	Std. SAE Socket	1/4" Dr.
80125	4 mm	6 Pt.	Std. Metric Socket	1/4" Dr.
80126	5 mm	6 Pt.	Std. Metric Socket	1/4" Dr.
80127	5.5 mm	6 Pt.	Std. Metric Socket	1/4" Dr.
80128	6 mm	6 Pt.	Std. Metric Socket	1/4" Dr.
80129	7 mm	6 Pt.	Std. Metric Socket	1/4" Dr.
80130	8 mm	6 Pt.	Std. Metric Socket	1/4" Dr.
80131	9 mm	6 Pt.	Std. Metric Socket	1/4" Dr.
80132	10 mm	6 Pt.	Std. Metric Socket	1/4" Dr.
80133	11 mm	6 Pt.	Std. Metric Socket	1/4" Dr.
80134	12 mm	6 Pt.	Std. Metric Socket	1/4" Dr.
80135	13 mm	6 Pt.	Std. Metric Socket	1/4" Dr.
80136	14 mm	6 Pt.	Std. Metric Socket	1/4" Dr.
80480	1/4"		Bit Holder Socket	1/4" Dr.
80496	1/4"	12 Pt.	Std. SAE Socket	3/8" Dr.
80497	5/16"	12 Pt.	Std. SAE Socket	3/8" Dr.
80498	3/8"	12 Pt.	Std. SAE Socket	3/8" Dr.
80499	7/16"	12 Pt.	Std. SAE Socket	3/8" Dr.
80500	1/2"	12 Pt.	Std. SAE Socket	3/8" Dr.
80501	9/16"	12 Pt.	Std. SAE Socket	3/8" Dr.
80502	5/8"	12 Pt.	Std. SAE Socket	3/8" Dr.
80503	11/16"	12 Pt.	Std. SAE Socket	3/8" Dr.
80504	3/4"	12 Pt.	Std. SAE Socket	3/8" Dr.
80505	13/16"	12 Pt.	Std. SAE Socket	3/8" Dr.
80506	7/8"	12 Pt.	Std. SAE Socket	3/8" Dr.
80485	9 mm	12 Pt.	Std. Metric Socket	3/8" Dr.
80486	10 mm	12 Pt.	Std. Metric Socket	3/8" Dr.
80487	11 mm	12 Pt.	Std. SAE Socket	3/8" Dr.

Material No.	Description			
80488	12 mm	12 Pt.	Std. Metric Socket	3/8" Dr.
80489	13 mm	12 Pt.	Std. Metric Socket	3/8" Dr.
80490	14 mm	12 Pt.	Std. Metric Socket	3/8" Dr.
80491	15 mm	12 Pt.	Std. Metric Socket	3/8" Dr.
80492	16 mm	12 Pt.	Std. Metric Socket	3/8" Dr.
80493	17 mm	12 Pt.	Std. Metric Socket	3/8" Dr.
80494	18 mm	12 Pt.	Std. Metric Socket	3/8" Dr.
80495	19 mm	12 Pt.	Std. Metric Socket	3/8" Dr.
81218			Quick-Release Teardrop Ratchet	3/8" Dr.
81128			Spinner Handle	1/4" Dr.
81241			3" Extension	3/8" Dr.
80402	5/8"		Spark Plug Socket	3/8" Dr.
81277	3/8" F x 1/4" M		Adapter	3/8" Dr.
81794	10 x 12 mm		Double Open End Wrench	
81796	12 x 14 mm		Double Open End Wrench	
81799	3/8" x 7/16"		Double Open End Wrench	
81801	1/2" x 9/16"		Double Open End Wrench	
56603G			13 Pc. SAE Hex Key Set	
	#1		Bit Phillips	
	#2		Bit Phillips	
	#3		Bit Phillips	
	4 mm		Bit Slotted	
	5 mm		Bit Slotted	
	6 mm		Bit Slotted	

MULTI DRIVESSES
RATCHETS, SOCKETS & DRIVE TOOLS



83000 - 68 Pc. SAE/METRIC 6 & 12 Pt. Standard Socket Set MULTI DRIVE

MULTI DRIVE SETS

RATCHETS, SOCKETS & DRIVE TOOLS

Material No.	Description			
80115	3/16"	6 Pt.	Deep SAE Socket	1/4" Dr.
80116	7/32"	6 Pt.	Deep SAE Socket	1/4" Dr.
80117	1/4"	6 Pt.	Deep SAE Socket	1/4" Dr.
80118	9/32"	6 Pt.	Deep SAE Socket	1/4" Dr.
80119	5/16"	6 Pt.	Deep SAE Socket	1/4" Dr.
80120	11/32"	6 Pt.	Deep SAE Socket	1/4" Dr.
80121	3/8"	6 Pt.	Deep SAE Socket	1/4" Dr.
80122	7/16"	6 Pt.	Deep SAE Socket	1/4" Dr.
80123	1/2"	6 Pt.	Deep SAE Socket	1/4" Dr.
80141	6 mm	6 Pt.	Deep Metric Socket	1/4" Dr.
80142	7 mm	6 Pt.	Deep SAE Socket	1/4" Dr.
80143	8 mm	6 Pt.	Deep Metric Socket	1/4" Dr.
80144	9 mm	6 Pt.	Deep Metric Socket	1/4" Dr.
80145	10 mm	6 Pt.	Deep Metric Socket	1/4" Dr.
80146	11 mm	6 Pt.	Deep Metric Socket	1/4" Dr.
80147	12 mm	6 Pt.	Deep Metric Socket	1/4" Dr.
80148	13 mm	6 Pt.	Deep Metric Socket	1/4" Dr.
80149	14 mm	6 Pt.	Deep Metric Socket	1/4" Dr.
80365	3/8"	6 Pt.	Deep SAE Socket	3/8" Dr.
80366	1/4"	6 Pt.	Deep SAE Socket	3/8" Dr.
80367	7/16"	6 Pt.	Deep SAE Socket	3/8" Dr.
80368	1/2"	6 Pt.	Deep SAE Socket	3/8" Dr.
80369	9/16"	12 Pt.	Deep SAE Socket	3/8" Dr.
80370	5/8"	6 Pt.	Deep SAE Socket	3/8" Dr.
80371	11/16"	6 Pt.	Deep SAE Socket	3/8" Dr.
80372	3/4"	6 Pt.	Deep SAE Socket	3/8" Dr.
80485	9 mm	12 Pt.	Std. Metric Socket	3/8" Dr.
80486	10 mm	12 Pt.	Std. Metric Socket	3/8" Dr.
80487	11 mm	12 Pt.	Std. Metric Socket	3/8" Dr.
80488	12 mm	12 Pt.	Std. Metric Socket	3/8" Dr.
80489	13 mm	12 Pt.	Std. Metric Socket	3/8" Dr.

Material No.	Description		
80490	14 mm	12 Pt.	Std. Metric Socket 3/8" Dr.
80491	15 mm	12 Pt.	Std. Metric Socket 3/8" Dr.
80492	16 mm	12 Pt.	Std. Metric Socket 3/8" Dr.
80493	17 mm	12 Pt.	Std. Metric Socket 3/8" Dr.
80498	3/8"	12 Pt.	Std. SAE Socket 3/8" Dr.
80499	7/16"	12 Pt.	Std. SAE Socket 3/8" Dr.
80500	1/2"	12 Pt.	Std. SAE Socket 3/8" Dr.
80501	9/16"	12 Pt.	Std. SAE Socket 3/8" Dr.
80502	5/8"	12 Pt.	Std. SAE Socket 3/8" Dr.
80503	11/16"	12 Pt.	Std. SAE Socket 3/8" Dr.
80504	3/4"	12 Pt.	Std. SAE Socket 3/8" Dr.
80505	13/16"	12 Pt.	Std. SAE Socket 3/8" Dr.
80506	7/8"	12 Pt.	Std. SAE Socket 3/8" Dr.
80197	4 mm	12 Pt.	Std. Metric Socket 1/4" Dr.
80198	5 mm	12 Pt.	Std. Metric Socket 1/4" Dr.
80200	6 mm	12 Pt.	Std. Metric Socket 1/4" Dr.
80201	7 mm	12 Pt.	Std. Metric Socket 1/4" Dr.
80202	8 mm	12 Pt.	Std. Metric Socket 1/4" Dr.
80203	9 mm	12 Pt.	Std. SAE Socket 1/4" Dr.
80204	10 mm	12 Pt.	Std. Metric Socket 1/4" Dr.
80205	11 mm	12 Pt.	Std. Metric Socket 1/4" Dr.
80206	12 mm	12 Pt.	Std. Metric Socket 1/4" Dr.
80210	3/16"	12 Pt.	Std. SAE Socket 1/4" Dr.
80211	7/32"	12 Pt.	Std. SAE Socket 1/4" Dr.
80212	1/4"	12 Pt.	Std. SAE Socket 1/4" Dr.
80213	9/32"	12 Pt.	Std. SAE Socket 1/4" Dr.
80214	5/16"	12 Pt.	Std. SAE Socket 1/4" Dr.
80215	11/32"	12 Pt.	Std. SAE Socket 1/4" Dr.
80216	3/8"	12 Pt.	Std. SAE Socket 1/4" Dr.
80217	7/16"	12 Pt.	Std. SAE Socket 1/4" Dr.
80218	1/2"	12 Pt.	Std. SAE Socket 1/4" Dr.
81101	2" Extension		1/4" Dr.
81116	6" Extension		1/4" Dr.
81241	3" Extension		3/8" Dr.
81242	6" Extension		3/8" Dr.
81011	Full Polish Teardrop Ratchet		1/4" Dr.
81211	Full Polish Teardrop Ratchet		3/8" Dr.
83000BM	Replacement Blow Mold Case		

85035 - 35 Pc. Microdriver Set
GEARWRENCH



Material No.	Description
1/4" x 5/16"	Double Box MicroDriver™
1/4"	Drive Socket Adapter
5/16"	S.A.E. Sockets (6pt)
3/8"	S.A.E. Sockets (6pt)
7/16"	S.A.E. Sockets (6pt)
1/2"	S.A.E. Sockets (6pt)
9/16"	S.A.E. Sockets (6pt)
8mm	Metric Sockets (6pt)
10mm	Metric Sockets (6pt)
12mm	Metric Sockets (6pt)
14mm	Metric Sockets (6pt)
5/32"	1/4" Bit, Slotted
7/32"	1/4" Bit, Slotted
9/32"	1/4" Bit, Slotted
#1	Bit, Phillips
#2	Bit, Phillips
#3	Bit, Phillips
3/32"	Bit, Hex
1/8"	Bit, Hex
5/32"	Bit, Hex
3/16"	Bit, Hex
1/4"	Bit, Hex
5/16"	Bit, Hex

Material No.	Description
T20	Bit, Torx®
T25	Bit, Torx®
T30	Bit, Torx®
T40	Bit, Torx®
#2	Bit, Square
#3	Bit, Square
5/16"	5/16" Bit, Slotted
3/8"	5/16" Bit, Slotted
3/8"	5/16" Bit, Hex
T45	5/16" Bit, Torx®
T50	5/16" Bit, Torx®

MICRODRIVER SET

RATCHETS, SOCKETS & DRIVE TOOLS



81222 - 2 Pc. Thumbwheel Ratchet Set
MULTI DRIVE

Material No.	Description	
81008	Thumbwheel Ratchet	1/4" Dr.
81226	Thumbwheel Ratchet	3/8" Dr.



81205 - 10 Pc. Universal Adapter Set
MULTI DRIVE

Material No.	Description	
80100	Universal Joint	1/4" Dr.
80549	Universal Joint	3/8" Dr.
80101	Impact Universal Joint	1/4" Dr.
80548	Universal Joint	3/8" Dr.
80671	Universal Joint	1/2" Dr.
81127	1/4" F x 3/8" M	Adapter 1/4" Dr.
81277	3/8" F x 1/4" M	Adapter 3/8" Dr.
81278	3/8" F x 1/2" M	Adapter 3/8" Dr.
81354	1/2" F x 3/8" M	Adapter 1/2" Dr.
81355	1/2" F x 3/4" M	Adapter 1/2" Dr.



81217 - 4 Pc. Clip Rail Adapter Set
MULTI DRIVE

Material No.	Description	
81127	1/4" F x 3/8" M	Adapter 1/4" Dr.
81277	3/8" F x 1/4" M	Adapter 3/8" Dr.
81278	3/8" F x 1/2" M	Adapter 3/8" Dr.
81354	1/2" F x 3/8" M	Adapter 1/2" Dr.

80300 - 51 Pc. SAE/METRIC 6 Pt. Standard & Deep Socket Set 1/4" DRIVE



Material No.	Description			
80105	3/16"	6 Pt.	Std. SAE Socket	1/4" Dr.
80106	7/32"	6 Pt.	Std. SAE Socket	1/4" Dr.
80107	1/4"	6 Pt.	Std. SAE Socket	1/4" Dr.
80108	9/32"	6 Pt.	Std. SAE Socket	1/4" Dr.
80109	5/16"	6 Pt.	Std. SAE Socket	1/4" Dr.
80110	11/32"	6 Pt.	Std. SAE Socket	1/4" Dr.
80111	3/8"	6 Pt.	Std. SAE Socket	1/4" Dr.
80112	7/16"	6 Pt.	Std. SAE Socket	1/4" Dr.
80113	1/2"	6 Pt.	Std. SAE Socket	1/4" Dr.
80114	9/16"	6 Pt.	Std. SAE Socket	1/4" Dr.
80125	4 mm	6 Pt.	Std. Metric Socket	1/4" Dr.
80126	5 mm	6 Pt.	Std. Metric Socket	1/4" Dr.
80127	5.5 mm	6 Pt.	Std. Metric Socket	1/4" Dr.
80128	6 mm	6 Pt.	Std. Metric Socket	1/4" Dr.
80129	7 mm	6 Pt.	Std. Metric Socket	1/4" Dr.
80130	8 mm	6 Pt.	Std. Metric Socket	1/4" Dr.
80131	9 mm	6 Pt.	Std. Metric Socket	1/4" Dr.
80132	10 mm	6 Pt.	Std. Metric Socket	1/4" Dr.
80133	11 mm	6 Pt.	Std. Metric Socket	1/4" Dr.
80134	12 mm	6 Pt.	Std. Metric Socket	1/4" Dr.
80135	13 mm	6 Pt.	Std. Metric Socket	1/4" Dr.
80136	14 mm	6 Pt.	Std. Metric Socket	1/4" Dr.
80137	15 mm	6 Pt.	Std. Metric Socket	1/4" Dr.
80115	3/16"	6 Pt.	Deep SAE Socket	1/4" Dr.
80116	7/32"	6 Pt.	Deep SAE Socket	1/4" Dr.
80117	1/4"	6 Pt.	Deep SAE Socket	1/4" Dr.
80118	9/32"	6 Pt.	Deep SAE Socket	1/4" Dr.
80119	5/16"	6 Pt.	Deep SAE Socket	1/4" Dr.
80120	11/32"	6 Pt.	Deep SAE Socket	1/4" Dr.
80121	3/8"	6 Pt.	Deep SAE Socket	1/4" Dr.
80122	7/16"	6 Pt.	Deep SAE Socket	1/4" Dr.
80123	1/2"	6 Pt.	Deep SAE Socket	1/4" Dr.

Material No.	Description			
80124	9/16"	6 Pt.	Deep SAE Socket	1/4" Dr.
80138	4 mm	6 Pt.	Deep Metric Socket	1/4" Dr.
80139	5 mm	6 Pt.	Deep Metric Socket	1/4" Dr.
80140	5.5 mm	6 Pt.	Deep Metric Socket	1/4" Dr.
80141	6 mm	6 Pt.	Deep Metric Socket	1/4" Dr.
80142	7 mm	6 Pt.	Deep Metric Socket	1/4" Dr.
80143	8 mm	6 Pt.	Deep Metric Socket	1/4" Dr.
80144	9 mm	6 Pt.	Deep Metric Socket	1/4" Dr.
80145	10 mm	6 Pt.	Deep Metric Socket	1/4" Dr.
80146	11 mm	6 Pt.	Deep Metric Socket	1/4" Dr.
80147	12 mm	6 Pt.	Deep Metric Socket	1/4" Dr.
80148	13 mm	6 Pt.	Deep Metric Socket	1/4" Dr.
80149	14 mm	6 Pt.	Deep Metric Socket	1/4" Dr.
80150	15 mm	6 Pt.	Deep Metric Socket	1/4" Dr.
81101	2" Extension			1/4" Dr.
81116	6" Extension			1/4" Dr.
80100	Universal Joint			1/4" Dr.
81008	Thumbwheel Ratchet			1/4" Dr.
81011	Full Polish Teardrop Ratchet			1/4" Dr.
80300BM	Replacement Blow Mold Case			1/4" Dr.

1/4" DRIVESETS
RATCHETS, SOCKETS & DRIVE TOOLS



80301 - 51 Pc. SAE/METRIC 12 Pt. Standard & Deep Socket Set 1/4" DRIVE

Material No.	Description			
80210	3/16"	12 Pt.	Std. SAE Socket	1/4" Dr.
80211	7/32"	12 Pt.	Std. SAE Socket	1/4" Dr.
80212	1/4"	12 Pt.	Std. SAE Socket	1/4" Dr.
80213	9/32"	12 Pt.	Std. SAE Socket	1/4" Dr.
80214	5/16"	12 Pt.	Std. SAE Socket	1/4" Dr.
80215	11/32"	12 Pt.	Std. SAE Socket	1/4" Dr.
80216	3/8"	12 Pt.	Std. SAE Socket	1/4" Dr.
80217	7/16"	12 Pt.	Std. SAE Socket	1/4" Dr.
80218	1/2"	12 Pt.	Std. SAE Socket	1/4" Dr.
80219	9/16"	12 Pt.	Std. SAE Socket	1/4" Dr.
80197	4 mm	12 Pt.	Std. Metric Socket	1/4" Dr.
80198	5 mm	12 Pt.	Std. Metric Socket	1/4" Dr.
80199	5.5 mm	12 Pt.	Std. Metric Socket	1/4" Dr.
80200	6 mm	12 Pt.	Std. Metric Socket	1/4" Dr.
80201	7 mm	12 Pt.	Std. Metric Socket	1/4" Dr.
80202	8 mm	12 Pt.	Std. Metric Socket	1/4" Dr.
80203	9 mm	12 Pt.	Std. Metric Socket	1/4" Dr.
80204	10 mm	12 Pt.	Std. Metric Socket	1/4" Dr.
80205	11 mm	12 Pt.	Std. Metric Socket	1/4" Dr.

Material No.	Description			
80206	12 mm	12 Pt.	Std. Metric Socket	1/4" Dr.
80207	13 mm	12 Pt.	Std. Metric Socket	1/4" Dr.
80208	14 mm	12 Pt.	Std. Metric Socket	1/4" Dr.
80209	15 mm	12 Pt.	Std. Metric Socket	1/4" Dr.
80220	3/16"	12 Pt.	Deep SAE Socket	1/4" Dr.
80221	7/32"	12 Pt.	Deep SAE Socket	1/4" Dr.
80222	1/4"	12 Pt.	Deep SAE Socket	1/4" Dr.
80223	9/32"	12 Pt.	Deep SAE Socket	1/4" Dr.
80224	5/16"	12 Pt.	Deep SAE Socket	1/4" Dr.
80225	11/32"	12 Pt.	Deep SAE Socket	1/4" Dr.
80226	3/8"	12 Pt.	Deep SAE Socket	1/4" Dr.
80227	7/16"	12 Pt.	Deep SAE Socket	1/4" Dr.
80228	1/2"	12 Pt.	Deep SAE Socket	1/4" Dr.
80229	9/16"	12 Pt.	Deep SAE Socket	1/4" Dr.
80230	4 mm	12 Pt.	Deep Metric Socket	1/4" Dr.
80231	5 mm	12 Pt.	Deep Metric Socket	1/4" Dr.
80232	5.5 mm	12 Pt.	Deep Metric Socket	1/4" Dr.
80233	6 mm	12 Pt.	Deep Metric Socket	1/4" Dr.
80234	7 mm	12 Pt.	Deep Metric Socket	1/4" Dr.
80235	8 mm	12 Pt.	Deep Metric Socket	1/4" Dr.
80236	9 mm	12 Pt.	Deep Metric Socket	1/4" Dr.
80237	10 mm	6 Pt.	Deep Metric Socket	1/4" Dr.
80238	11 mm	6 Pt.	Deep Metric Socket	1/4" Dr.
80239	12 mm	6 Pt.	Deep Metric Socket	1/4" Dr.
80240	13 mm	6 Pt.	Deep Metric Socket	1/4" Dr.
80241	14 mm	6 Pt.	Deep Metric Socket	1/4" Dr.
80242	15 mm	6 Pt.	Deep Metric Socket	1/4" Dr.
81101	2" Extension			1/4" Dr.
81116	6" Extension			1/4" Dr.
80100	Universal Joint			1/4" Dr.
81008	Thumbwheel Ratchet			1/4" Dr.
81011	Full Polish Teardrop Ratchet			1/4" Dr.

80325 - 22 Pc. SAE 6 & 12 Pt. Standard & Deep Socket Set 1/4" DRIVE

Material No.	Description			
80115	3/16"	6 Pt.	Deep SAE Socket	1/4" Dr.
80116	7/32"	6 Pt.	Deep SAE Socket	1/4" Dr.
80117	1/4"	6 Pt.	Deep SAE Socket	1/4" Dr.
80118	9/32"	6 Pt.	Deep SAE Socket	1/4" Dr.
80119	5/16"	6 Pt.	Deep SAE Socket	1/4" Dr.
80120	11/32"	6 Pt.	Deep SAE Socket	1/4" Dr.
80121	3/8"	6 Pt.	Deep SAE Socket	1/4" Dr.
80122	7/16"	6 Pt.	Deep SAE Socket	1/4" Dr.
80123	1/2"	6 Pt.	Deep SAE Socket	1/4" Dr.
80210	3/16"	12 Pt.	Std. SAE Socket	1/4" Dr.
80211	7/32"	12 Pt.	Std. SAE Socket	1/4" Dr.
80212	1/4"	12 Pt.	Std. SAE Socket	1/4" Dr.
80213	9/32"	12 Pt.	Std. SAE Socket	1/4" Dr.
80214	5/16"	12 Pt.	Std. SAE Socket	1/4" Dr.
80215	11/32"	12 Pt.	Std. SAE Socket	1/4" Dr.



Material No.	Description			
80216	3/8"	12 Pt.	Std. SAE Socket	1/4" Dr.
80217	7/16"	12 Pt.	Std. SAE Socket	1/4" Dr.
80218	1/2"	12 Pt.	Std. SAE Socket	1/4" Dr.
81101	2"		Extension	1/4" Dr.
81116	6"		Extension	1/4" Dr.
81128			Spinner Handle	1/4" Dr.
81011			Full Polish Teardrop Ratchet	1/4" Dr.

80327 - 22 Pc. METRIC 6 & 12 Pt. Standard & Deep Socket Set 1/4" DRIVE

Material No.	Description			
80141	6 mm	6 Pt.	Deep Metric Socket	1/4" Dr.
80142	7 mm	6 Pt.	Deep Metric Socket	1/4" Dr.
80143	8 mm	6 Pt.	Deep Metric Socket	1/4" Dr.
80144	9 mm	6 Pt.	Deep Metric Socket	1/4" Dr.
80145	10 mm	6 Pt.	Deep Metric Socket	1/4" Dr.
80146	11 mm	6 Pt.	Deep Metric Socket	1/4" Dr.
80147	12 mm	6 Pt.	Deep Metric Socket	1/4" Dr.
80148	13 mm	6 Pt.	Deep Metric Socket	1/4" Dr.
80149	14 mm	6 Pt.	Deep Metric Socket	1/4" Dr.
80197	4 mm	12 Pt.	Std. Metric Socket	1/4" Dr.
80198	5 mm	12 Pt.	Std. Metric Socket	1/4" Dr.
80200	6 mm	12 Pt.	Std. Metric Socket	1/4" Dr.
80201	7 mm	12 Pt.	Std. Metric Socket	1/4" Dr.
80202	8 mm	12 Pt.	Std. Metric Socket	1/4" Dr.
80203	9 mm	12 Pt.	Std. Metric Socket	1/4" Dr.
80204	10 mm	12 Pt.	Std. Metric Socket	1/4" Dr.
80205	11 mm	12 Pt.	Std. Metric Socket	1/4" Dr.



Material No.	Description			
80206	12 mm	12 Pt.	Std. Metric Socket	1/4" Dr.
81101	2"		Extension	1/4" Dr.
81116	6"		Extension	1/4" Dr.
81128			Spinner Handle	1/4" Dr.
81011			Full Polish Teardrop Ratchet	1/4" Dr.



**80303 - 10 Pc. SAE 6 Pt. Standard Socket Set
1/4" DRIVE**

Material No.	Description
80105	3/16" 6 Pt. Std. SAE Socket 1/4" Dr.
80106	7/32" 6 Pt. Std. SAE Socket 1/4" Dr.
80107	1/4" 6 Pt. Std. SAE Socket 1/4" Dr.
80108	9/32" 6 Pt. Std. SAE Socket 1/4" Dr.
80109	5/16" 6 Pt. Std. SAE Socket 1/4" Dr.

Material No.	Description
80110	11/32" 6 Pt. Std. SAE Socket 1/4" Dr.
80111	3/8" 6 Pt. Std. SAE Socket 1/4" Dr.
80112	7/16" 6 Pt. Std. SAE Socket 1/4" Dr.
80113	1/2" 6 Pt. Std. SAE Socket 1/4" Dr.
80114	9/16" 6 Pt. Std. SAE Socket 1/4" Dr.



**80307 - 10 Pc. SAE 12 Pt. Standard Socket Set
1/4" DRIVE**

Material No.	Description
80210	3/16" 12 Pt. Std. SAE Socket 1/4" Dr.
80211	7/32" 12 Pt. Std. SAE Socket 1/4" Dr.
80212	1/4" 12 Pt. Std. SAE Socket 1/4" Dr.
80213	9/32" 12 Pt. Std. SAE Socket 1/4" Dr.

Material No.	Description
80214	5/16" 12 Pt. Std. SAE Socket 1/4" Dr.
80215	11/32" 12 Pt. Std. SAE Socket 1/4" Dr.
80216	3/8" 12 Pt. Std. SAE Socket 1/4" Dr.
80217	7/16" 12 Pt. Std. SAE Socket 1/4" Dr.
80218	1/2" 12 Pt. Std. SAE Socket 1/4" Dr.
80219	9/16" 12 Pt. Std. SAE Socket 1/4" Dr.



**80305 - 10 Pc. SAE 6 Pt. Deep Socket Set
1/4" DRIVE**

Material No.	Description
80115	3/16" 6 Pt. Deep SAE Socket 1/4" Dr.
80116	7/32" 6 Pt. Deep SAE Socket 1/4" Dr.
80117	1/4" 6 Pt. Deep SAE Socket 1/4" Dr.

Material No.	Description
80118	9/32" 6 Pt. Deep SAE Socket 1/4" Dr.
80119	5/16" 6 Pt. Deep SAE Socket 1/4" Dr.
80120	11/32" 6 Pt. Deep SAE Socket 1/4" Dr.
80121	3/8" 6 Pt. Deep SAE Socket 1/4" Dr.
80122	7/16" 6 Pt. Deep SAE Socket 1/4" Dr.
80123	1/2" 6 Pt. Deep SAE Socket 1/4" Dr.
80124	9/16" 6 Pt. Deep SAE Socket 1/4" Dr.

**80302 - 13 Pc. METRIC 6 Pt. Standard Socket Set
1/4" DRIVE**



Material No.	Description			
80125	4 mm	6 Pt.	Std. Metric Socket	1/4" Dr.
80126	5 mm	6 Pt.	Std. Metric Socket	1/4" Dr.
80127	5.5 mm	6 Pt.	Std. Metric Socket	1/4" Dr.
80128	6 mm	6 Pt.	Std. Metric Socket	1/4" Dr.
80129	7 mm	6 Pt.	Std. Metric Socket	1/4" Dr.
80130	8 mm	6 Pt.	Std. Metric Socket	1/4" Dr.
80131	9 mm	6 Pt.	Std. Metric Socket	1/4" Dr.
80132	10 mm	6 Pt.	Std. Metric Socket	1/4" Dr.

Material No.	Description			
80133	11 mm	6 Pt.	Std. Metric Socket	1/4" Dr.
80134	12 mm	6 Pt.	Std. Metric Socket	1/4" Dr.
80135	13 mm	6 Pt.	Std. Metric Socket	1/4" Dr.
80136	14 mm	6 Pt.	Std. Metric Socket	1/4" Dr.
80137	15 mm	6 Pt.	Std. Metric Socket	1/4" Dr.

**80306 - 13 Pc. METRIC 12 Pt. Standard Socket Set
1/4" DRIVE**



Material No.	Description			
80197	4 mm	12 Pt.	Std. Metric Socket	1/4" Dr.
80198	5 mm	12 Pt.	Std. Metric Socket	1/4" Dr.
80199	5.5 mm	12 Pt.	Std. Metric Socket	1/4" Dr.
80200	6 mm	12 Pt.	Std. Metric Socket	1/4" Dr.
80201	7 mm	12 Pt.	Std. Metric Socket	1/4" Dr.
80202	8 mm	12 Pt.	Std. Metric Socket	1/4" Dr.
80203	9 mm	12 Pt.	Std. Metric Socket	1/4" Dr.
80204	10 mm	12 Pt.	Std. Metric Socket	1/4" Dr.

Material No.	Description			
80205	11 mm	12 Pt.	Std. Metric Socket	1/4" Dr.
80206	12 mm	12 Pt.	Std. Metric Socket	1/4" Dr.
80207	13 mm	12 Pt.	Std. Metric Socket	1/4" Dr.
80208	14 mm	12 Pt.	Std. Metric Socket	1/4" Dr.
80209	15 mm	12 Pt.	Std. Metric Socket	1/4" Dr.

**80304 - 13 Pc. METRIC 6 Pt. Deep Socket Set
1/4" DRIVE**



Material No.	Description			
80138	4 mm	6 Pt.	Deep Metric Socket	1/4" Dr.
80139	5 mm	6 Pt.	Deep Metric Socket	1/4" Dr.
80140	5.5 mm	6 Pt.	Deep Metric Socket	1/4" Dr.
80141	6 mm	6 Pt.	Deep Metric Socket	1/4" Dr.
80142	7 mm	6 Pt.	Deep Metric Socket	1/4" Dr.
80143	8 mm	6 Pt.	Deep Metric Socket	1/4" Dr.
80144	9 mm	6 Pt.	Deep Metric Socket	1/4" Dr.
80145	10 mm	6 Pt.	Deep Metric Socket	1/4" Dr.

Material No.	Description			
80146	11 mm	6 Pt.	Deep Metric Socket	1/4" Dr.
80147	12 mm	6 Pt.	Deep Metric Socket	1/4" Dr.
80148	13 mm	6 Pt.	Deep Metric Socket	1/4" Dr.
80149	14 mm	6 Pt.	Deep Metric Socket	1/4" Dr.
80150	15 mm	6 Pt.	Deep Metric Socket	1/4" Dr.



PATENTED

Full Polish Teardrop Ratchet 1/4" DRIVE

Material No.	Description	Overall Length (inch)	Weight (lbs)
81011D	Full Polish Teardrop Ratchet	5.13"	0.220

- 60 tooth low profile ratchet

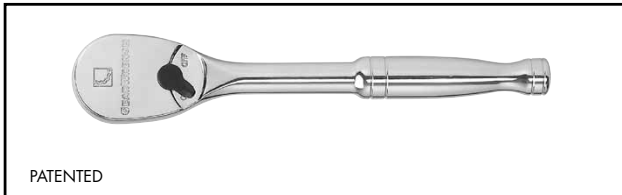

PATENTED

Full Polish Flex Teardrop Ratchet 1/4" DRIVE

Material No.	Description	Overall Length (inch)	Weight (lbs)
81012D	Full Polish Flex Teardrop Ratchet	6.97"	0.330

- 60 tooth low profile ratchet



Quick-Release Teardrop Ratchet 1/4" DRIVE

Material No.	Description	Overall Length (inch)	Weight (lbs)
81014	Quick-Release Teardrop Ratchet	5.63"	0.200

- 45 tooth standard ratchet



PATENTED

Cushion Grip Teardrop Ratchet 1/4" DRIVE

Material No.	Description	Overall Length (inch)	Weight (lbs)
81007	Cushion Grip Teardrop Ratchet	6.42"	0.290

- 60 tooth low profile ratchet



PATENTED

Cushion Grip Flex Teardrop Ratchet 1/4" DRIVE

Material No.	Description	Overall Length (inch)	Weight (lbs)
81009	Cushion Grip Flex Teardrop Ratchet	7.76"	0.400

- 60 tooth low profile ratchet



Cushion Grip Roto Ratchet 1/4" DRIVE

Material No.	Description	Weight (lbs)
81224	Cushion Grip Roto Ratchet	0.290

- 72 tooth roto ratchet

Ratchet Repair Kit 1/4" DRIVE

Material No.	Description
81099	Ratchet Repair Kit

- for non-quick release and non-roto ratchets

Spinner Handle 1/4" DRIVE

Material No.	Description	Weight (lbs)
81128	Spinner Handle	0.264



Thumbwheel Ratchet 1/4" DRIVE

Material No.	Description	Weight (lbs)
81008	Thumbwheel Ratchet	0.101



Flex handle 1/4" DRIVE

Material No.	Description	Overall Length (inch)	Weight (lbs)
81013	Flex Handle	5.43"	.0293

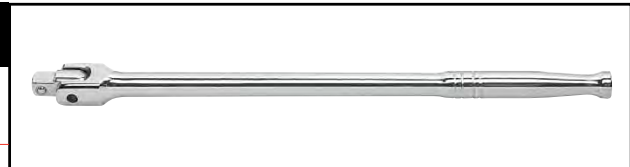

Universal Joint 1/4" DRIVE

Material No.	Description	Weight (lbs)
80100	Universal Joint	0.044



Spring Universal Joint 1/4" DRIVE

Material No.	Description	Weight (lbs)
81232	Spring Universal Joint	0.070



PATENTED

1/4" DRIVE
RATCHETS, SOCKETS & DRIVE TOOLS



Adapter 1/4" DRIVE

Material No.	Description	Weight (lbs)
81127	Adapter 1/4" F x 3/8" M	0.044



Standard Extension 1/4" DRIVE

Material No.	Description	Weight (lbs)
81101	2" Standard Extension	0.066
81116	6" Standard Extension	0.176
81117D	10" Standard Extension	0.242
81118	14" Standard Extension	0.330



81004 - 4 Pc. Wobble Extension Set 1/4" DRIVE

Material No.	Description	Weight (lbs)
81119	2" Wobble Extension	0.066
81121	6" Wobble Extension	0.176



Locking Extension 1/4" DRIVE

Material No.	Description	Weight (lbs)
81126	6" Locking Extension	0.176

6 & 12 Pt. Standard Socket SAE/METRIC 1/4" DRIVE

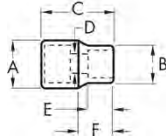

Material No.	Size	Description	Drive End	Wrench	Overall	Bolt	Wrench	Length to	Weight
			(inch) A	End (inch) B	Length (inch) C	Clearance D	Depth (inch) E	Shoulder F	(lbs)
80104D	5/32"	6 Pt. Std. SAE	0.465	0.272	0.965	0.134	0.295	0.453	0.022
80105	3/16"	6 Pt. Std. SAE	0.465	0.307	0.965	0.157	0.315	0.453	0.022
80106	7/32"	6 Pt. Std. SAE	0.465	0.335	0.965	0.157	0.315	0.453	0.022
80107	1/4"	6 Pt. Std. SAE	0.465	0.374	0.965	0.157	0.354	0.453	0.022
80108	9/32"	6 Pt. Std. SAE	0.465	0.421	0.965	0.220	0.394	0.453	0.022
80109	5/16"	6 Pt. Std. SAE	0.465	0.453	0.965	0.220	0.413	0.453	0.026
80110	11/32"	6 Pt. Std. SAE	0.492	0.492	0.965	0.220	0.413	0.453	0.033
80111	3/8"	6 Pt. Std. SAE	0.543	0.543	0.965	0.220	0.492	0.453	0.044
80112	7/16"	6 Pt. Std. SAE	0.618	0.618	0.965	0.220	0.492	0.453	0.044
80113D	1/2"	6 Pt. Std. SAE	0.681	0.681	0.965	0.220	0.492	0.453	0.055
80114D	9/16"	6 Pt. Std. SAE	0.768	0.768	0.965	0.220	0.571	0.453	0.059
80125	4 mm	6 Pt. Std. Metric	0.465	0.264	0.965	0.134	0.315	0.453	0.022
80126	5 mm	6 Pt. Std. Metric	0.465	0.315	0.965	0.157	0.315	0.453	0.022
80127	5.5 mm	6 Pt. Std. Metric	0.465	0.339	0.965	0.157	0.315	0.453	0.022
80128	6 mm	6 Pt. Std. Metric	0.465	0.362	0.965	0.157	0.354	0.453	0.022
80129	7 mm	6 Pt. Std. Metric	0.465	0.421	0.965	0.220	0.374	0.453	0.022
80130	8 mm	6 Pt. Std. Metric	0.465	0.453	0.965	0.220	0.394	0.453	0.026
80131D	9 mm	6 Pt. Std. Metric	0.516	0.516	0.965	0.220	0.413	0.453	0.033
80132	10 mm	6 Pt. Std. Metric	0.563	0.563	0.965	0.220	0.492	0.453	0.040
80133	11 mm	6 Pt. Std. Metric	0.622	0.622	0.965	0.220	0.492	0.453	0.044
80134	12 mm	6 Pt. Std. Metric	0.661	0.661	0.965	0.220	0.492	0.453	0.048
80135D	13 mm	6 Pt. Std. Metric	0.705	0.705	0.965	0.220	0.492	0.453	0.059
80136	14 mm	6 Pt. Std. Metric	0.768	0.768	0.965	0.220	0.571	0.453	0.059
80137	15 mm	6 Pt. Std. Metric	0.819	0.819	0.965	0.220	0.571	0.453	0.066

1/4" OPEN STOCK
RATCHETS, SOCKETS & DRIVE TOOLS



6 & 12 Pt. Deep Socket SAE/METRIC 1/4" DRIVE

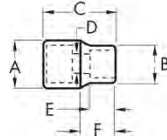

Material No.	Size	Description	Drive End	Wrench	Overall	Bolt	Wrench	Length to	Weight
			(inch) A	End (inch) B	Length (inch) C	Clearance D	Depth (inch) E	Shoulder F	(lbs)
80115	3/16"	6 Pt. Deep SAE	0.469	0.307	1.929	0.177	0.138	0.866	0.040
80116D	7/32"	6 Pt. Deep SAE	0.469	0.346	1.929	0.197	0.138	0.866	0.044
80117	1/4"	6 Pt. Deep SAE	0.469	0.390	1.929	0.217	0.157	0.866	0.046
80118	9/32"	6 Pt. Deep SAE	0.469	0.433	1.929	0.217	0.197	0.866	0.046
80119	5/16"	6 Pt. Deep SAE	0.469	0.453	1.929	0.217	0.197	0.866	0.046
80120D	11/32"	6 Pt. Deep SAE	0.516	0.516	1.929	0.217	0.197	0.866	0.064
80121	3/8"	6 Pt. Deep SAE	0.575	0.575	1.929	0.217	0.201	0.866	0.088
80122D	7/16"	6 Pt. Deep SAE	0.626	0.626	1.929	0.217	0.236	0.866	0.101
80123	1/2"	6 Pt. Deep SAE	0.705	0.705	1.929	0.217	0.287	0.866	0.128
80124	9/16"	6 Pt. Deep SAE	0.772	0.772	1.929	0.217	0.350	0.866	0.132
80138	4 mm	6 Pt. Deep Metric	0.469	0.264	1.929	0.138	0.118	0.866	0.040
80139	5 mm	6 Pt. Deep Metric	0.469	0.315	1.929	0.177	0.138	0.866	0.040
80140	5.5 mm	6 Pt. Deep Metric	0.469	0.339	1.929	0.197	0.138	0.866	0.040
80141	6 mm	6 Pt. Deep Metric	0.469	0.362	1.929	0.217	0.157	0.866	0.046
80142	7 mm	6 Pt. Deep Metric	0.469	0.425	1.929	0.217	0.197	0.866	0.055
80143	8 mm	6 Pt. Deep Metric	0.469	0.453	1.929	0.217	0.197	0.866	0.055
80144	9 mm	6 Pt. Deep Metric	0.516	0.516	1.929	0.217	0.197	0.866	0.070
80145	10 mm	6 Pt. Deep Metric	0.575	0.575	1.929	0.217	0.217	0.866	0.084
80146D	11 mm	6 Pt. Deep Metric	0.626	0.626	1.929	0.217	0.256	0.866	0.106
80147	12 mm	6 Pt. Deep Metric	0.665	0.665	1.929	0.217	0.276	0.866	0.110
80148	13 mm	6 Pt. Deep Metric	0.705	0.705	1.929	0.217	0.303	0.866	0.121
80149	14 mm	6 Pt. Deep Metric	0.772	0.772	1.929	0.217	0.350	0.866	0.132
80150	15 mm	6 Pt. Deep Metric	0.819	0.819	1.929	0.217	0.350	0.866	0.154

80550 - 57 Pc. SAE/METRIC 6 Pt. Standard & Deep Socket Set 3/8" DRIVE

Material No.	Description			
80350	1/4"	6 Pt.	Std. SAE Socket	3/8" Dr.
80351	5/16"	6 Pt.	Std. SAE Socket	3/8" Dr.
80352	3/8"	6 Pt.	Std. SAE Socket	3/8" Dr.
80353	7/16"	6 Pt.	Std. SAE Socket	3/8" Dr.
80354	1/2"	6 Pt.	Std. SAE Socket	3/8" Dr.
80355	9/16"	6 Pt.	Std. SAE Socket	3/8" Dr.
80356	5/8"	6 Pt.	Std. SAE Socket	3/8" Dr.
80357	11/16"	6 Pt.	Std. SAE Socket	3/8" Dr.
80358	3/4"	6 Pt.	Std. Metric Socket	3/8" Dr.
80359	13/16"	6 Pt.	Std. SAE Socket	3/8" Dr.
80360	7/8"	6 Pt.	Std. SAE Socket	3/8" Dr.
80361	15/16"	6 Pt.	Std. SAE Socket	3/8" Dr.
80362	1"	6 Pt.	Std. SAE Socket	3/8" Dr.
80363	1/4"	6 Pt.	Deep SAE Socket	3/8" Dr.
80364	5/16"	6 Pt.	Deep SAE Socket	3/8" Dr.
80365	3/8"	6 Pt.	Deep SAE Socket	3/8" Dr.
80366	1/4"	6 Pt.	Deep SAE Socket	3/8" Dr.
80367	7/16"	6 Pt.	Deep SAE Socket	3/8" Dr.
80368	1/2"	6 Pt.	Deep SAE Socket	3/8" Dr.
80369	9/16"	6 Pt.	Deep SAE Socket	3/8" Dr.
80370	5/8"	6 Pt.	Deep SAE Socket	3/8" Dr.
80371	11/16"	6 Pt.	Deep SAE Socket	3/8" Dr.
80372	3/4"	6 Pt.	Deep SAE Socket	3/8" Dr.
80373	7/8"	6 Pt.	Deep SAE Socket	3/8" Dr.
80374	6 mm	6 Pt.	Std. Metric Socket	3/8" Dr.
80375	7 mm	6 Pt.	Std. Metric Socket	3/8" Dr.
80376	8 mm	6 Pt.	Std. Metric Socket	3/8" Dr.
80377	9 mm	6 Pt.	Std. Metric Socket	3/8" Dr.
80378	10 mm	6 Pt.	Std. SAE Socket	3/8" Dr.
80379	11 mm	6 Pt.	Std. Metric Socket	3/8" Dr.
80380	12 mm	6 Pt.	Std. Metric Socket	3/8" Dr.
80381	13 mm	6 Pt.	Std. Metric Socket	3/8" Dr.
80382	14 mm	6 Pt.	Std. Metric Socket	3/8" Dr.
80383	15 mm	6 Pt.	Std. Metric Socket	3/8" Dr.
80384	16 mm	6 Pt.	Std. Metric Socket	3/8" Dr.



Material No.	Description			
80385	17 mm	6 Pt.	Std. Metric Socket	3/8" Dr.
80386	18 mm	6 Pt.	Std. Metric Socket	3/8" Dr.
80387	19 mm	6 Pt.	Std. Metric Socket	3/8" Dr.
80388	6 mm	6 Pt.	Deep Metric Socket	3/8" Dr.
80389	7 mm	6 Pt.	Deep Metric Socket	3/8" Dr.
80390	8 mm	6 Pt.	Deep Metric Socket	3/8" Dr.
80391	9 mm	6 Pt.	Deep Metric Socket	3/8" Dr.
80392	10 mm	6 Pt.	Deep Metric Socket	3/8" Dr.
80393	11 mm	6 Pt.	Deep Metric Socket	3/8" Dr.
80394	12 mm	6 Pt.	Deep Metric Socket	3/8" Dr.
80395	13 mm	6 Pt.	Deep Metric Socket	3/8" Dr.
80396	14 mm	6 Pt.	Deep Metric Socket	3/8" Dr.
80397	15 mm	6 Pt.	Deep Metric Socket	3/8" Dr.
80398	16 mm	6 Pt.	Deep Metric Socket	3/8" Dr.
80399	17 mm	6 Pt.	Deep Metric Socket	3/8" Dr.
80400	18 mm	6 Pt.	Deep Metric Socket	3/8" Dr.
80401	19 mm	6 Pt.	Deep Metric Socket	3/8" Dr.
81241	3" Extension			3/8" Dr.
81242	6" Extension			3/8" Dr.
80549	Universal Joint			3/8" Dr.
81209	Full Polish Stubby Teardrop Ratchet			3/8" Dr.
81211	Full Polish Teardrop Ratchet			3/8" Dr.
80550BM	Replacement Blow Mold Case			

3/8" DRIVESETS
RATCHETS, SOCKETS & DRIVE TOOLS



80551 - 57 Pc. SAE/METRIC 12 Pt. Standard & Deep Socket Set 3/8" DRIVE

Material No.	Description
80496	1/4" 12 Pt. Std. SAE Socket 3/8" Dr.
80497	5/16" 12 Pt. Std. SAE Socket 3/8" Dr.
80498	3/8" 12 Pt. Std. SAE Socket 3/8" Dr.
80499	7/16" 12 Pt. Std. SAE Socket 3/8" Dr.
80500	1/2" 12 Pt. Std. SAE Socket 3/8" Dr.
80501	9/16" 12 Pt. Std. SAE Socket 3/8" Dr.
80502	5/8" 12 Pt. Std. SAE Socket 3/8" Dr.
80503	11/16" 12 Pt. Std. SAE Socket 3/8" Dr.
80504	3/4" 12 Pt. Std. SAE Socket 3/8" Dr.
80505	13/16" 12 Pt. Std. SAE Socket 3/8" Dr.
80506	7/8" 12 Pt. Std. SAE Socket 3/8" Dr.
80507	15/16" 12 Pt. Std. SAE Socket 3/8" Dr.
80508	1" 12 Pt. Std. SAE Socket 3/8" Dr.
80509	1/4" 12 Pt. Deep SAE Socket 3/8" Dr.
80510	5/16" 12 Pt. Deep SAE Socket 3/8" Dr.
80511	3/8" 12 Pt. Deep SAE Socket 3/8" Dr.
80512	1/4" 12 Pt. Deep SAE Socket 3/8" Dr.
80513	7/16" 12 Pt. Deep SAE Socket 3/8" Dr.
80514	1/2" 12 Pt. Deep SAE Socket 3/8" Dr.
80515	9/16" 12 Pt. Deep SAE Socket 3/8" Dr.
80516	5/8" 12 Pt. Deep SAE Socket 3/8" Dr.
80517	11/16" 12 Pt. Deep SAE Socket 3/8" Dr.
80518	3/4" 12 Pt. Deep SAE Socket 3/8" Dr.

Material No.	Description
80519	7/8" 12 Pt. Deep SAE Socket 3/8" Dr.
80482	6 mm 12 Pt. Std. Metric Socket 3/8" Dr.
80483	7 mm 12 Pt. Std. Metric Socket 3/8" Dr.
80484	8 mm 12 Pt. Std. Metric Socket 3/8" Dr.
80485	9 mm 12 Pt. Std. Metric Socket 3/8" Dr.
80486	10 mm 12 Pt. Std. Metric Socket 3/8" Dr.
80487	11 mm 12 Pt. Std. Metric Socket 3/8" Dr.
80488	12 mm 12 Pt. Std. Metric Socket 3/8" Dr.
80489	13 mm 12 Pt. Std. Metric Socket 3/8" Dr.
80490	14 mm 12 Pt. Std. Metric Socket 3/8" Dr.
80491	15 mm 12 Pt. Std. Metric Socket 3/8" Dr.
80492	16 mm 12 Pt. Std. Metric Socket 3/8" Dr.
80493	17 mm 12 Pt. Std. Metric Socket 3/8" Dr.
80494	18 mm 12 Pt. Std. Metric Socket 3/8" Dr.
80495	19 mm 12 Pt. Std. Metric Socket 3/8" Dr.
80520	6 mm 12 Pt. Deep Metric Socket 3/8" Dr.
80521	7 mm 12 Pt. Deep Metric Socket 3/8" Dr.
80522	8 mm 12 Pt. Deep Metric Socket 3/8" Dr.
80523	9 mm 12 Pt. Deep Metric Socket 3/8" Dr.
80524	10 mm 12 Pt. Deep Metric Socket 3/8" Dr.
80525	11 mm 12 Pt. Deep Metric Socket 3/8" Dr.
80526	12 mm 12 Pt. Deep Metric Socket 3/8" Dr.
80527	13 mm 12 Pt. Deep Metric Socket 3/8" Dr.
80528	14 mm 12 Pt. Deep Metric Socket 3/8" Dr.
80529	15 mm 12 Pt. Deep Metric Socket 3/8" Dr.
80530	16 mm 12 Pt. Deep Metric Socket 3/8" Dr.
80531	17 mm 12 Pt. Deep Metric Socket 3/8" Dr.
80532	18 mm 12 Pt. Deep Metric Socket 3/8" Dr.
80533	19 mm 12 Pt. Deep Metric Socket 3/8" Dr.
81241	3" Extension 3/8" Dr.
81242	6" Extension 3/8" Dr.
80549	Universal Joint 3/8" Dr.
81209	Full Polish Stubby Teardrop Ratchet 3/8" Dr.
81211	Full Polish Teardrop Ratchet 3/8" Dr.
80550BM	Replacement Blow Mold Case

80557 - 21 Pc. SAE 6 Pt. & 12 Pt. Standard & Deep Socket Set 3/8" DRIVE

Material No.	Description			
80365	3/8"	6 Pt.	Deep SAE Socket	3/8" Dr.
80366	1/4"	6 Pt.	Deep SAE Socket	3/8" Dr.
80367	7/16"	6 Pt.	Std. SAE Socket	3/8" Dr.
80368	1/2"	6 Pt.	Deep SAE Socket	3/8" Dr.
80369	9/16"	6 Pt.	Deep SAE Socket	3/8" Dr.
80370	5/8"	6 Pt.	Deep SAE Socket	3/8" Dr.
80371	11/16"	6 Pt.	Deep SAE Socket	3/8" Dr.
80372	3/4"	6 Pt.	Deep SAE Socket	3/8" Dr.
80373	7/8"	6 Pt.	Deep SAE Socket	3/8" Dr.
80496	1/4"	12 Pt.	Std. SAE Socket	3/8" Dr.
80497	5/16"	12 Pt.	Std. SAE Socket	3/8" Dr.
80498	3/8"	12 Pt.	Std. SAE Socket	3/8" Dr.
80499	7/16"	12 Pt.	Std. SAE Socket	3/8" Dr.
80500	1/2"	12 Pt.	Std. SAE Socket	3/8" Dr.



Material No.	Description			
80501	9/16"	12 Pt.	Std. SAE Socket	3/8" Dr.
80502	5/8"	12 Pt.	Std. SAE Socket	3/8" Dr.
80503	11/16"	12 Pt.	Std. SAE Socket	3/8" Dr.
80504	3/4"	12 Pt.	Std. SAE Socket	3/8" Dr.
81241	3"		Extension	3/8" Dr.
81242	6"		Extension	3/8" Dr.
81211			Full Polish Teardrop Ratchet	3/8" Dr.

80559 - 24 Pc. METRIC 6 Pt. & 12 Pt. Standard & Deep Socket Set 3/8" DRIVE

Material No.	Description			
80392	10 mm	6 Pt.	Deep Metric Socket	3/8" Dr.
80393	11 mm	6 Pt.	Deep Metric Socket	3/8" Dr.
80394	12 mm	6 Pt.	Deep Metric Socket	3/8" Dr.
80395	13 mm	6 Pt.	Std. Metric Socket	3/8" Dr.
80396	14 mm	6 Pt.	Std. Metric Socket	3/8" Dr.
80397	15 mm	6 Pt.	Deep Metric Socket	3/8" Dr.
80398	16 mm	6 Pt.	Deep Metric Socket	3/8" Dr.
80399	17 mm	6 Pt.	Deep Metric Socket	3/8" Dr.
80400	18 mm	6 Pt.	Deep Metric Socket	3/8" Dr.
80484	8 mm	12 Pt.	Std. Metric Socket	3/8" Dr.
80485	9 mm	12 Pt.	Std. Metric Socket	3/8" Dr.
80486	10 mm	12 Pt.	Std. Metric Socket	3/8" Dr.
80487	11 mm	12 Pt.	Std. Metric Socket	3/8" Dr.
80488	12 mm	12 Pt.	Std. Metric Socket	3/8" Dr.
80489	13 mm	12 Pt.	Std. Metric Socket	3/8" Dr.
80490	14 mm	12 Pt.	Std. Metric Socket	3/8" Dr.



Material No.	Description			
80491	15 mm	12 Pt.	Deep Metric Socket	3/8" Dr.
80492	16 mm	12 Pt.	Std. Metric Socket	3/8" Dr.
80493	17 mm	12 Pt.	Std. Metric Socket	3/8" Dr.
80494	18 mm	12 Pt.	Std. Metric Socket	3/8" Dr.
80495	19 mm	12 Pt.	Std. Metric Socket	3/8" Dr.
81241	3"		Extension	3/8" Dr.
81242	6"		Extension	3/8" Dr.
81211			Full Polish Teardrop Ratchet	3/8" Dr.

**3/8" DRIVESETS
RATCHETS, SOCKETS & DRIVE TOOLS**



**80561 - 13 Pc. SAE 12 Pt. Standard Socket Set
3/8" DRIVE**

Material No.	Description			
80496	1/4"	12 Pt.	Std. SAE Socket	3/8" Dr.
80497	5/16"	12 Pt.	Std. SAE Socket	3/8" Dr.
80498	3/8"	12 Pt.	Std. SAE Socket	3/8" Dr.
80499	7/16"	12 Pt.	Std. SAE Socket	3/8" Dr.
80500	1/2"	12 Pt.	Std. SAE Socket	3/8" Dr.

80501	9/16"	12 Pt.	Std. SAE Socket	3/8" Dr.
80502	5/8"	12 Pt.	Std. SAE Socket	3/8" Dr.
80503	11/16"	12 Pt.	Std. SAE Socket	3/8" Dr.
80504	3/4"	12 Pt.	Std. SAE Socket	3/8" Dr.
80505	13/16"	12 Pt.	Std. SAE Socket	3/8" Dr.
80506	7/8"	12 Pt.	Std. SAE Socket	3/8" Dr.
80507	15/16"	12 Pt.	Std. SAE Socket	3/8" Dr.
80508	1"	12 Pt.	Std. SAE Socket	3/8" Dr.



**80555 - 11 Pc. SAE 6 Pt. Deep Socket Set
3/8" DRIVE**

Material No.	Description			
80363	1/4"	6 Pt.	Deep SAE Socket	3/8" Dr.
80364	5/16"	6 Pt.	Deep SAE Socket	3/8" Dr.
80365	3/8"	6 Pt.	Deep SAE Socket	3/8" Dr.
80366	1/4"	6 Pt.	Deep SAE Socket	3/8" Dr.

80367	7/16"	6 Pt.	Deep SAE Socket	3/8" Dr.
80368	1/2"	6 Pt.	Deep SAE Socket	3/8" Dr.
80369	9/16"	6 Pt.	Deep SAE Socket	3/8" Dr.
80370	5/8"	6 Pt.	Deep SAE Socket	3/8" Dr.
80371	11/16"	6 Pt.	Deep SAE Socket	3/8" Dr.
80372	3/4"	6 Pt.	Deep SAE Socket	3/8" Dr.
80373	7/8"	6 Pt.	Deep SAE Socket	3/8" Dr.



**80560 - 14 Pc. METRIC 12 Pt. Standard Socket Set
3/8" DRIVE**

Material No.	Description			
80482	6 mm	12 Pt.	Std. Metric Socket	3/8" Dr.
80483	7 mm	12 Pt.	Std. Metric Socket	3/8" Dr.
80484	8 mm	12 Pt.	Std. Metric Socket	3/8" Dr.
80485	9 mm	12 Pt.	Std. Metric Socket	3/8" Dr.
80486	10 mm	12 Pt.	Std. Metric Socket	3/8" Dr.
80487	11 mm	12 Pt.	Std. Metric Socket	3/8" Dr.
80488	12 mm	12 Pt.	Std. Metric Socket	3/8" Dr.

80489	13 mm	12 Pt.	Std. Metric Socket	3/8" Dr.
80490	14 mm	12 Pt.	Std. Metric Socket	3/8" Dr.
80491	15 mm	12 Pt.	Std. Metric Socket	3/8" Dr.
80492	16 mm	12 Pt.	Std. Metric Socket	3/8" Dr.
80493	17 mm	12 Pt.	Std. Metric Socket	3/8" Dr.
80494	18 mm	12 Pt.	Std. Metric Socket	3/8" Dr.
80495	19 mm	12 Pt.	Std. Metric Socket	3/8" Dr.

**80554 - 14 Pc. METRIC 6 Pt. Deep Socket Set
3/8" DRIVE**

Material No.	Description			
80388	6 mm 6 Pt. Deep Metric Socket			3/8" Dr.
80389	7 mm 6 Pt. Deep Metric Socket			3/8" Dr.
80390	8 mm 6 Pt. Deep Metric Socket			3/8" Dr.
80391	9 mm 6 Pt. Deep Metric Socket			3/8" Dr.
80392	10 mm 6 Pt. Deep Metric Socket			3/8" Dr.
80393	11 mm 6 Pt. Deep Metric Socket			3/8" Dr.
80394	12 mm 6 Pt. Deep Metric Socket			3/8" Dr.
80395	13 mm 6 Pt. Deep Metric Socket			3/8" Dr.



80396	14 mm 6 Pt. Deep Metric Socket			3/8" Dr.
80397	15 mm 6 Pt. Deep Metric Socket			3/8" Dr.
80398	16 mm 6 Pt. Deep Metric Socket			3/8" Dr.
80399	17 mm 6 Pt. Deep Metric Socket			3/8" Dr.
80400	18 mm 6 Pt. Deep Metric Socket			3/8" Dr.
80401	19 mm 6 Pt. Deep Metric Socket			3/8" Dr.

Full Polish Teardrop Ratchet 3/8" DRIVE

Material No.	Description	Overall Length (inch)	Weight (lbs)
81211	Full Polish Teardrop Ratchet	8.39"	0.680



- 60 tooth low profile ratchet

Full Polish Flex Teardrop Ratchet 3/8" DRIVE

Material No.	Description	Overall Length (inch)	Weight (lbs)
81215	Full Polish Flex Teardrop Ratchet	13.01"	0.850

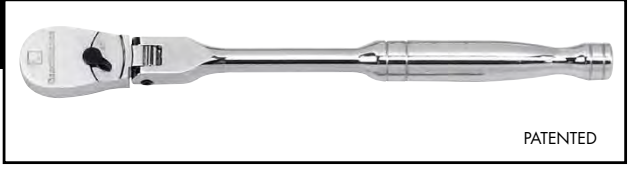

- 60 tooth low profile ratchet

Full Polish Stubby Teardrop Ratchet 3/8" DRIVE

Material No.	Description	Overall Length (inch)	Weight (lbs)
81209D	Full Polish Stubby Teardrop Ratchet	4.72"	0.410



- 60 tooth low profile ratchet

**Full Polish Stubby Flex Teardrop Ratchet
3/8" DRIVE**

Material No.	Description	Overall Length (inch)	Weight (lbs)
81212	Full Polish Stubby Flex Teardrop Ratchet	5.02"	0.520



- 60 tooth low profile ratchet



Quick-Release Teardrop Ratchet 3/8" DRIVE

Material No.	Description	Overall Length (inch)	Weight (lbs)
81218	Quick-Release Teardrop Ratchet	7.87"	0.550

- 45 tooth standard ratchet



Cushion Grip Teardrop Ratchet 3/8" DRIVE

Material No.	Description	Overall Length (inch)	Weight (lbs)
81208	Cushion Grip Teardrop Ratchet	9.02"	0.640

- 60 tooth low profile ratchet

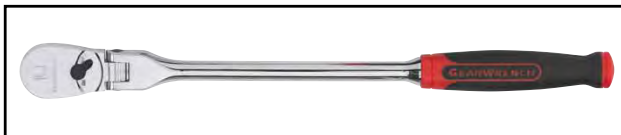

Cushion Grip Flex Teardrop Ratchet 3/8" DRIVE

Material No.	Description	Overall Length (inch)	Weight (lbs)
81210	Cushion Grip Flex Teardrop Ratchet	13.13"	0.940

- 60 tooth low profile ratchet

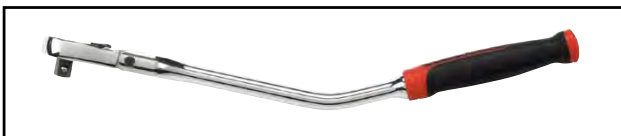

Cushion Grip Offset Flex Teardrop Ratchet 3/8" DRIVE

Material No.	Description	Overall Length (inch)	Weight (lbs)
81213	Cushion Grip Offset Flex Teardrop Ratchet	12.26"	0.990

- 60 tooth low profile ratchet



Cushion Grip Roto Ratchet 3/8" DRIVE

Material No.	Description	Overall Length (inch)	Weight (lbs)
81225	Cushion Grip Roto Ratchet	9.84"	0.760

- 72 tooth ratchet

Ratchet Repair Kit 3/8" DRIVE

Material No.	Description
81227	Ratchet Repair Kit

- for non-quick release and non-roto ratchets

Full Polish Flex Handle 3/8" DRIVE

Material No.	Description	Overall Length (inch)	Weight (lbs)
81221	Full Polish Flex Handle	12.00"	0.400

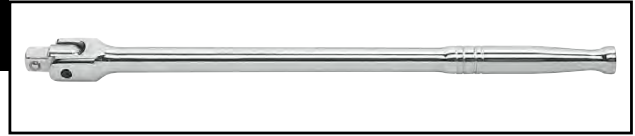

Thumbwheel Ratchet 3/8" DRIVE

Material No.	Description	Weight (lbs)
81226	Thumbwheel Ratchet	0.110



Universal Joint 3/8" DRIVE

Material No.	Description	Weight (lbs)
80549	Universal Joint	0.132



Spring Universal Joint 3/8" DRIVE

Material No.	Description	Weight (lbs)
81233	Spring Universal Joint	0.160



Speeder Handle 3/8" DRIVE

Material No.	Description	Weight (lbs)
81239	Speeder Handle	1.100



Standard Extension 3/8" DRIVE

Material No.	Description	Weight (lbs)
81240	1-1/2" Standard Extension	0.088
81241	3" Standard Extension	0.154
81242	6" Standard Extension	0.330
81243	10" Standard Extension	0.528
81244	12" Standard Extension	0.616





Wobble Extensions 3/8" DRIVE

Material No.	Description	Weight (lbs)
81246	3" Extension	3/8" Dr.
81247	6" Extension	3/8" Dr.
81248	10" Extension	3/8" Dr.
81249	12" Extension	3/8" Dr.



81202 - Locking Extension Set 3/8" DRIVE

Material No.	Description	Weight (lbs)
81250	3" Locking Extension	0.154
81251	6" Locking Extension	0.330
81272	10" Locking Extension	0.528



Adapter 3/8" DRIVE

Material No.	Description	Weight (lbs)
81277	Adapter 3/8"F X 1/4"M	0.015
81278	Adapter 3/8"F X 1/2"M	0.046



Spark Plug Socket SAE 3/8" DRIVE

Material No.	Description	Weight (lbs)
80402	5/8" Spark Plug	0.095
80403	13/16" Spark Plug	0.166

6 Pt. & 12 Pt. Standard Socket SAE/METRIC 3/8" DRIVE

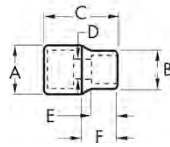

Material No.	Size	Description	Drive End (inch) A	Wrench End (inch) B	Overall Length (inch) C	Bolt Clearance D	Wrench Depth (Inch) E	Length to Shoulder F	Weight (lbs)
80496	1/4"	12 Pt. Std. SAE	0.677	0.394	0.984	0.197	0.295	0.453	0.044
80497D	5/16"	12 Pt. Std. SAE	0.677	0.461	0.984	0.283	0.295	0.453	0.044
80498	3/8"	12 Pt. Std. SAE	0.677	0.543	0.984	0.283	0.295	0.453	0.046
80499	7/16"	12 Pt. Std. SAE	0.677	0.630	0.984	0.354	0.295	0.453	0.046
80500D	1/2"	12 Pt. Std. SAE	0.705	0.685	0.984	0.354	0.295	0.453	0.055
80501	9/16"	12 Pt. Std. SAE	0.776	0.776	0.984	0.354	0.492	0.453	0.066
80502	5/8"	12 Pt. Std. SAE	0.874	0.874	0.984	0.354	0.492	0.453	0.088
80503	11/16"	12 Pt. Std. SAE	0.941	0.941	0.984	0.354	0.492	0.453	0.106
80504	3/4"	12 Pt. Std. SAE	1.020	1.020	0.984	0.354	0.492	0.453	0.121
80505	13/16"	12 Pt. Std. SAE	1.098	1.098	1.102	0.354	0.591	0.453	0.158
80506D	7/8"	12 Pt. Std. SAE	1.169	1.169	1.102	0.354	0.591	0.453	0.158
80507	15/16"	12 Pt. Std. SAE	1.256	1.256	1.161	0.354	0.591	0.453	0.158
80508	1"	12 Pt. Std. SAE	1.335	1.335	1.319	0.354	0.709	0.453	0.160
80482	6 mm	12 Pt. Std. Metric	0.669	0.366	0.984	0.197	0.295	0.453	0.040
80483	7 mm	12 Pt. Std. Metric	0.669	0.425	0.984	0.197	0.295	0.453	0.040
80484	8 mm	12 Pt. Std. Metric	0.669	0.472	0.984	0.283	0.295	0.453	0.044
80485	9 mm	12 Pt. Std. Metric	0.669	0.508	0.984	0.283	0.295	0.453	0.044
80486	10 mm	12 Pt. Std. Metric	0.669	0.571	0.984	0.283	0.295	0.453	0.044
80487	11 mm	12 Pt. Std. Metric	0.669	0.622	0.984	0.354	0.295	0.453	0.044
80488	12 mm	12 Pt. Std. Metric	0.669	0.654	0.984	0.354	0.315	0.453	0.046
80489	13 mm	12 Pt. Std. Metric	0.720	0.697	0.984	0.354	0.315	0.453	0.059
80490	14 mm	12 Pt. Std. Metric	0.768	0.768	0.984	0.354	0.492	0.453	0.059
80491	15 mm	12 Pt. Std. Metric	0.819	0.819	0.984	0.354	0.492	0.453	0.070
80492	16 mm	12 Pt. Std. Metric	0.866	0.866	0.984	0.354	0.492	0.453	0.084
80493	17 mm	12 Pt. Std. Metric	0.917	0.917	0.984	0.354	0.492	0.453	0.095
80494	18 mm	12 Pt. Std. Metric	0.937	0.937	0.984	0.354	0.492	0.453	0.095
80495	19 mm	12 Pt. Std. Metric	0.957	1.004	0.984	0.354	0.492	0.453	0.121
80596	20 mm	12 Pt. Std. Metric	1.016	1.063	1.102	0.354	0.591	0.453	0.130
80597	21 mm	12 Pt. Std. Metric	1.051	1.098	1.102	0.354	0.591	0.453	0.140
80598	22 mm	12 Pt. Std. Metric	1.114	1.161	1.102	0.354	0.591	0.453	0.150

3/8" OPEN STOCK

RATCHETS, SOCKETS & DRIVE TOOLS



6 Pt. & 12 Pt. Deep Socket SAE/METRIC 3/8" DRIVE

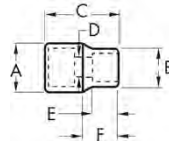

RATCHETS, SOCKETS & DRIVE TOOLS 3/8" OPEN STOCK

Material No.	Size	Description	Drive End (inch) A	Wrench End (inch) B	Overall Length (inch) C	Bolt Clearance D	Wrench Depth (Inch) E	Length to Shoulder F	Weight (lbs)
80363	1/4"	6 Pt. Deep SAE	0.661	0.394	2.500	0.217	0.157	1.142	0.054
80364	5/16"	6 Pt. Deep SAE	0.661	0.461	2.500	0.276	0.197	1.142	0.055
80365	3/8"	6 Pt. Deep SAE	0.661	0.543	2.500	0.335	0.201	1.142	0.059
80366	7/16"	6 Pt. Deep SAE	0.661	0.630	2.500	0.335	0.236	1.142	0.060
80367	1/2"	6 Pt. Deep SAE	0.720	0.685	2.500	0.335	0.287	1.142	0.065
80368	9/16"	6 Pt. Deep SAE	0.780	0.780	2.500	0.335	0.350	1.142	0.085
80369	5/8"	6 Pt. Deep SAE	0.866	0.866	2.500	0.335	0.398	1.142	0.107
80370D	11/16"	6 Pt. Deep SAE	0.937	0.937	2.500	0.335	0.398	1.142	0.128
80371	3/4"	6 Pt. Deep SAE	1.016	1.016	2.500	0.335	0.457	1.142	0.148
80372	13/16"	6 Pt. Deep SAE	1.094	1.094	2.500	0.335	0.480	1.142	0.165
80373	7/8"	6 Pt. Deep SAE	1.173	1.173	2.500	0.335	0.520	1.142	0.197
80592	15/16"	6 Pt. Deep SAE	1.205	1.252	2.500	0.335	0.567	1.142	0.158
80593	1"	6 Pt. Deep SAE	1.272	1.319	2.500	0.335	0.567	1.142	0.160
80388	6 mm	6 Pt. Deep Metric	0.661	0.508	2.500	0.315	0.197	1.142	0.052
80389	7 mm	6 Pt. Deep Metric	0.661	0.508	2.500	0.315	0.197	1.142	0.052
80390	8 mm	6 Pt. Deep Metric	0.661	0.508	2.500	0.315	0.197	1.142	0.052
80391	9 mm	6 Pt. Deep Metric	0.661	0.508	2.500	0.315	0.197	1.142	0.052
80392	10 mm	6 Pt. Deep Metric	0.661	0.571	2.500	0.335	0.201	1.142	0.058
80393	11 mm	6 Pt. Deep Metric	0.661	0.622	2.500	0.335	0.236	1.142	0.060
80394	12 mm	6 Pt. Deep Metric	0.661	0.654	2.500	0.335	0.260	1.142	0.067
80395	13 mm	6 Pt. Deep Metric	0.740	0.697	2.500	0.335	0.287	1.142	0.075
80396	14 mm	6 Pt. Deep Metric	0.768	0.768	2.500	0.335	0.350	1.142	0.082
80397	15 mm	6 Pt. Deep Metric	0.819	0.819	2.500	0.335	0.350	1.142	0.092
80398	16 mm	6 Pt. Deep Metric	0.866	0.866	2.500	0.335	0.398	1.142	0.102
80399	17 mm	6 Pt. Deep Metric	0.937	0.937	2.500	0.335	0.398	1.142	0.118
80400	18 mm	6 Pt. Deep Metric	0.937	0.937	2.500	0.335	0.421	1.142	0.125
80401	19 mm	6 Pt. Deep Metric	1.004	1.004	2.500	0.335	0.457	1.142	0.141
80406	20 mm	6 Pt. Deep Metric	1.016	1.063	2.500	0.335	0.480	1.142	0.150
80407	21 mm	6 Pt. Deep Metric	1.047	1.094	2.500	0.335	0.480	1.142	0.160
80408	22 mm	6 Pt. Deep Metric	1.114	1.161	2.500	0.335	0.520	1.142	0.170
80409	24 mm	6 Pt. Deep Metric	1.205	1.252	2.500	0.335	0.567	1.142	0.180

80701 - 49 Pc. SAE/METRIC 12 Pt. Standard & Deep Socket Set 1/2" DRIVE

Material No.	Description			
80760	7/16"	12 Pt.	Std. SAE Socket	1/2" Dr.
80761	1/2"	12 Pt.	Std. SAE Socket	1/2" Dr.
80762	9/16"	12 Pt.	Std. SAE Socket	1/2" Dr.
80763	5/8"	12 Pt.	Std. SAE Socket	1/2" Dr.
80764	11/16"	12 Pt.	Std. SAE Socket	1/2" Dr.
80765	3/4"	12 Pt.	Std. SAE Socket	1/2" Dr.
80766	13/16"	12 Pt.	Std. SAE Socket	1/2" Dr.
80767	7/8"	12 Pt.	Std. SAE Socket	1/2" Dr.
80768	15/16"	12 Pt.	Std. SAE Socket	1/2" Dr.
80769	1"	12 Pt.	Std. SAE Socket	1/2" Dr.
80770	1-1/16"	12 Pt.	Std. SAE Socket	1/2" Dr.
80771	1-1/8"	12 Pt.	Std. SAE Socket	1/2" Dr.
80773	1/2"	12 Pt.	Deep SAE Socket	1/2" Dr.
80774	9/16"	12 Pt.	Deep SAE Socket	1/2" Dr.
80775	5/8"	12 Pt.	Deep SAE Socket	1/2" Dr.
80776	11/16"	12 Pt.	Deep SAE Socket	1/2" Dr.
80777	3/4"	12 Pt.	Std. SAE Socket	1/2" Dr.
80778	13/16"	12 Pt.	Std. SAE Socket	1/2" Dr.
80779	7/8"	12 Pt.	Deep SAE Socket	1/2" Dr.
80780	15/16"	12 Pt.	Deep SAE Socket	1/2" Dr.
80745	10 mm	12 Pt.	Std. Metric Socket	1/2" Dr.
80746	11 mm	12 Pt.	Std. Metric Socket	1/2" Dr.
80747	12 mm	12 Pt.	Std. Metric Socket	1/2" Dr.
80748	13 mm	12 Pt.	Std. Metric Socket	1/2" Dr.
80749	14 mm	12 Pt.	Std. Metric Socket	1/2" Dr.
80750	15 mm	12 Pt.	Std. Metric Socket	1/2" Dr.
80751	16 mm	12 Pt.	Std. Metric Socket	1/2" Dr.
80752	17 mm	12 Pt.	Std. Metric Socket	1/2" Dr.
80753	18 mm	12 Pt.	Std. Metric Socket	1/2" Dr.
80754	19 mm	12 Pt.	Std. Metric Socket	1/2" Dr.
80755	20 mm	12 Pt.	Std. Metric Socket	1/2" Dr.
80756	21 mm	12 Pt.	Std. Metric Socket	1/2" Dr.
80757	22 mm	12 Pt.	Std. Metric Socket	1/2" Dr.
80758	23mm	12 Pt.	Std. Metric Socket	1/2" Dr.
80759	24 mm	12 Pt.	Std. Metric Socket	1/2" Dr.
80781	10 mm	12 Pt.	Deep Metric Socket	1/2" Dr.
80782	11 mm	12 Pt.	Deep Metric Socket	1/2" Dr.
80783	12 mm	12 Pt.	Deep Metric Socket	1/2" Dr.



Material No.	Description			
80784	13 mm	12 Pt.	Deep Metric Socket	1/2" Dr.
80785	14 mm	12 Pt.	Deep Metric Socket	1/2" Dr.
80786	15 mm	12 Pt.	Deep Metric Socket	1/2" Dr.
80787	16 mm	12 Pt.	Std. Metric Socket	1/2" Dr.
80788	17 mm	12 Pt.	Std. Metric Socket	1/2" Dr.
80789	18 mm	12 Pt.	Deep Metric Socket	1/2" Dr.
80790	19 mm	12 Pt.	Deep Metric Socket	1/2" Dr.
81340	3" Extension			1/2" Dr.
81341	5" Extension			1/2" Dr.
80600	Universal Joint			1/2" Dr.
81304	Full Polish Teardrop Ratchet			1/2" Dr.
80700BM	Replacement Blow Mold Case			

1/2" DRIVESETS
RATCHETS, SOCKETS & DRIVE TOOLS



**80707 - 23 Pc. SAE Standard & Deep Socket Set
1/2" DRIVE**

Material No.	Description		
80615	1/2"	6 Pt.	Deep SAE Socket 1/2" Dr.
80614	9/16"	6 Pt.	Deep SAE Socket 1/2" Dr.
80616	5/8"	6 Pt.	Deep SAE Socket 1/2" Dr.
80617	11/16"	6 Pt.	Deep SAE Socket 1/2" Dr.
80618	3/4"	6 Pt.	Deep SAE Socket 1/2" Dr.
80619	13/16"	6 Pt.	Deep SAE Socket 1/2" Dr.
80620	7/8"	6 Pt.	Deep SAE Socket 1/2" Dr.

Material No.	Description		
80621	15/16"	6 Pt.	Deep SAE Socket 1/2" Dr.
80602	7/16"	6 Pt.	Std. SAE Socket 1/2" Dr.
80603	1/2"	6 Pt.	Std. SAE Socket 1/2" Dr.
80604	9/16"	6 Pt.	Std. SAE Socket 1/2" Dr.
80605	5/8"	6 Pt.	Std. SAE Socket 1/2" Dr.
80606	11/16"	6 Pt.	Std. SAE Socket 1/2" Dr.
80607	3/4"	6 Pt.	Std. SAE Socket 1/2" Dr.
80608	13/16"	6 Pt.	Std. SAE Socket 1/2" Dr.
80609	7/8"	6 Pt.	Std. SAE Socket 1/2" Dr.
80610	15/16"	6 Pt.	Std. SAE Socket 1/2" Dr.
80611	1"	6 Pt.	Std. SAE Socket 1/2" Dr.
80612	1-1/16"	6 Pt.	Std. SAE Socket 1/2" Dr.
80613	1-1/8"	6 Pt.	Std. SAE Socket 1/2" Dr.
81341	5" Extension		1/2" Dr.
81343	15" Extension		1/2" Dr.
81304	Full Polish Teardrop Ratchet		1/2" Dr.



**80709 - 28 Pc. METRIC Standard & Deep Socket Set
1/2" DRIVE**

Material No.	Description		
80637	10 mm	6 Pt.	Deep Metric Socket 1/2" Dr.
80638	11 mm	6 Pt.	Deep Metric Socket 1/2" Dr.
80639	12 mm	6 Pt.	Deep Metric Socket 1/2" Dr.
80640	13 mm	6 Pt.	Deep Metric Socket 1/2" Dr.
80641	14 mm	6 Pt.	Deep Metric Socket 1/2" Dr.
80642	15 mm	6 Pt.	Deep Metric Socket 1/2" Dr.
80643	16 mm	6 Pt.	Deep Metric Socket 1/2" Dr.
80644	17 mm	6 Pt.	Deep Metric Socket 1/2" Dr.
80645	18 mm	6 Pt.	Deep Metric Socket 1/2" Dr.
80646	19 mm	6 Pt.	Deep Metric Socket 1/2" Dr.

Material No.	Description		
80745	10 mm	12 Pt.	Std. Metric Socket 1/2" Dr.
80746	11 mm	12 Pt.	Std. Metric Socket 1/2" Dr.
80747	12 mm	12 Pt.	Std. Metric Socket 1/2" Dr.
80748	13 mm	12 Pt.	Std. Metric Socket 1/2" Dr.
80749	14 mm	12 Pt.	Std. Metric Socket 1/2" Dr.
80750	15 mm	12 Pt.	Std. Metric Socket 1/2" Dr.
80751	16 mm	12 Pt.	Std. Metric Socket 1/2" Dr.
80752	17 mm	12 Pt.	Std. Metric Socket 1/2" Dr.
80753	18 mm	12 Pt.	Std. Metric Socket 1/2" Dr.
80754	19 mm	12 Pt.	Std. Metric Socket 1/2" Dr.
80755	20 mm	12 Pt.	Std. Metric Socket 1/2" Dr.
80756	21 mm	12 Pt.	Std. Metric Socket 1/2" Dr.
80757	22 mm	12 Pt.	Std. Metric Socket 1/2" Dr.
80758	23 mm	12 Pt.	Std. Metric Socket 1/2" Dr.
80759	24 mm	12 Pt.	Std. Metric Socket 1/2" Dr.
81341	5" Extension		1/2" Dr.
81343	15" Extension		1/2" Dr.
81304	Full Polish Teardrop Ratchet		1/2" Dr.

**80711 - 11 Pc. SAE 12 Pt. Standard Socket Set
1/2" DRIVE**

Material No.	Description			
80761	1/2"	12 Pt.	Std. SAE Socket	1/2" Dr.
80762	9/16"	12 Pt.	Std. SAE Socket	1/2" Dr.
80763	5/8"	12 Pt.	Std. SAE Socket	1/2" Dr.
80764	11/16"	12 Pt.	Std. SAE Socket	1/2" Dr.
80765	3/4"	12 Pt.	Std. SAE Socket	1/2" Dr.
80766	13/16"	12 Pt.	Std. SAE Socket	1/2" Dr.



80767	7/8"	12 Pt.	Std. SAE Socket	1/2" Dr.
80768	15/16"	12 Pt.	Std. SAE Socket	1/2" Dr.
80769	1"	12 Pt.	Std. SAE Socket	1/2" Dr.
80770	1-1/16"	12 Pt.	Std. SAE Socket	1/2" Dr.
80771	1-1/8"	12 Pt.	Std. SAE Socket	1/2" Dr.

**80705 - 8 Pc. SAE 6 Pt. Deep Socket Set
1/2" DRIVE**

Material No.	Description			
80614	1/2"	6 Pt.	Deep SAE Socket	1/2" Dr.
80615	9/16"	6 Pt.	Deep SAE Socket	1/2" Dr.
80616	5/8"	6 Pt.	Deep SAE Socket	1/2" Dr.
80617	11/16"	6 Pt.	Deep SAE Socket	1/2" Dr.
80618	3/4"	6 Pt.	Deep SAE Socket	1/2" Dr.
80619	13/16"	6 Pt.	Deep SAE Socket	1/2" Dr.



80620	7/8"	6 Pt.	Deep SAE Socket	1/2" Dr.
80621	15/16"	6 Pt.	Deep SAE Socket	1/2" Dr.

**80710D - 13 Pc. METRIC 12 Pt. Standard Socket Set
1/2" DRIVE**

Material No.	Description			
80747	12 mm	12 Pt.	Std. Metric Socket	1/2" Dr.
80748	13 mm	12 Pt.	Std. Metric Socket	1/2" Dr.
80749	14 mm	12 Pt.	Std. Metric Socket	1/2" Dr.
80750	15 mm	12 Pt.	Std. Metric Socket	1/2" Dr.
80751	16 mm	12 Pt.	Std. Metric Socket	1/2" Dr.
80752	17 mm	12 Pt.	Std. Metric Socket	1/2" Dr.
80753	18 mm	12 Pt.	Std. Metric Socket	1/2" Dr.
80754	19 mm	12 Pt.	Std. Metric Socket	1/2" Dr.



Material No.	Description			
80755	20 mm	12 Pt.	Std. Metric Socket	1/2" Dr.
80756	21 mm	12 Pt.	Std. Metric Socket	1/2" Dr.
80757	22 mm	12 Pt.	Std. Metric Socket	1/2" Dr.
80758	23mm	12 Pt.	Std. Metric Socket	1/2" Dr.
80759	24 mm	12 Pt.	Std. Metric Socket	1/2" Dr.

1/2" DRIVESETS

RATCHETS, SOCKETS & DRIVE TOOLS



80704 - 10 Pc. METRIC 6 Pt. Deep Socket Set 1/2" DRIVE

Material No.	Description		
80637	10 mm	6 Pt.	Deep Metric Socket 1/2" Dr.
80638	11 mm	6 Pt.	Deep Metric Socket 1/2" Dr.
80639	12 mm	6 Pt.	Deep Metric Socket 1/2" Dr.

Material No.	Description		
80640	13 mm	6 Pt.	Deep Metric Socket 1/2" Dr.
80641	14 mm	6 Pt.	Deep Metric Socket 1/2" Dr.
80642	15 mm	6 Pt.	Deep Metric Socket 1/2" Dr.
80643	16 mm	6 Pt.	Deep Metric Socket 1/2" Dr.
80644	17 mm	6 Pt.	Deep Metric Socket 1/2" Dr.
80645	18 mm	6 Pt.	Deep Metric Socket 1/2" Dr.
80646	19 mm	6 Pt.	Deep Metric Socket 1/2" Dr.



80712 - 10 Pc. METRIC 12 Pt. Deep Socket Set 1/2" DRIVE

Material No.	Description		
80781	10 mm	12 Pt.	Deep Metric Socket 1/2" Dr.
80782	11 mm	12 Pt.	Deep Metric Socket 1/2" Dr.
80783	12 mm	12 Pt.	Deep Metric Socket 1/2" Dr.

Material No.	Description		
80784	13 mm	12 Pt.	Deep Metric Socket 1/2" Dr.
80785	14 mm	12 Pt.	Deep Metric Socket 1/2" Dr.
80786	15 mm	12 Pt.	Deep Metric Socket 1/2" Dr.
80787	16 mm	12 Pt.	Deep Metric Socket 1/2" Dr.
80788	17 mm	12 Pt.	Deep Metric Socket 1/2" Dr.
80789	18 mm	12 Pt.	Deep Metric Socket 1/2" Dr.
80790	19 mm	12 Pt.	Deep Metric Socket 1/2" Dr.

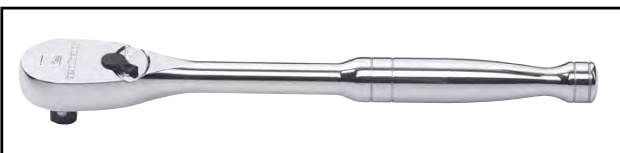

Patented

Full Polish Teardrop Ratchet 1/2" DRIVE

Material No.	Description	Overall Length (inch)	Weight (lbs)
81304	Full Polish Teardrop Ratchet	11"	1.630

- 60 tooth low profile ratchet



Patented

Full Polish Flex Teardrop Ratchet 1/2" DRIVE

Material No.	Description	Overall Length (inch)	Weight (lbs)
81306	Full Polish Flex Teardrop Ratchet	16.98"	1.630

- 60 tooth low profile ratchet



Patented

Cushion Grip Teardrop Ratchet 1/2" DRIVE

Material No.	Description	Overall Length (inch)	Weight (lbs)
81303	Cushion Grip Teardrop Ratchet	11.61"	1.360

- 60 tooth low profile ratchet

Quick Release Tear Drop Ratchet 1/2" DRIVE

Material No.	Description	Weight (lbs)
81309	Quick Release Tear Drop Ratchet	1.630

- 45 tooth standard ratchet



Sliding T handle 1/2" DRIVE

Material No.	Description	Weight (lbs)
81311	Sliding T handle	1.320



Speeder Handle 1/2" DRIVE

Material No.	Description	Weight (lbs)
81312	Speeder Handle	1.800



Full Polish Flex Handle SAE 1/2" DRIVE

Material No.	Description	Overall Length (inch)	Weight (lbs)
81307	Full Polish Flex Handle	15"	0.800
81308D	Full Polish Flex Handle	24"	1.000

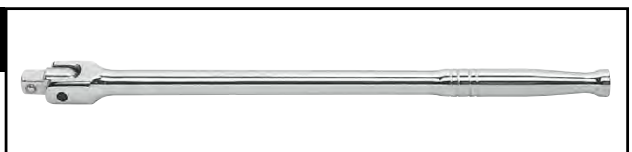

Ratchet Repair Kit 1/2" DRIVE

Material No.	Description
81339	Ratchet Repair Kit

- for non-quick release and non-ROTO ratchets

Universal Joint SAE 1/2" DRIVE

Material No.	Description	Weight (lbs)
80600D	Universal Joint	0.319





Patented

Spring Universal Joint SAE 1/2" DRIVE

Material No.	Description	Weight (lbs)
81234	Spring Universal Joint	0.330



Standard Adapter SAE 1/2" DRIVE

Material No.	Description	Weight (lbs)
81354	Standard Adapter 1/2" F x 3/8" M	0.110
81355	Standard Adapter 1/2" F x 3/4" M	0.440



Standard Extension SAE 1/2" DRIVE

Material No.	Description	Weight (lbs)
81340	3" Standard Extension	0.280
81341	5" Standard Extension	0.440
81342	10" Standard Extension	0.860
81343	15" Standard Extension	1.360



Wobble Extension SAE 1/2" DRIVE

Material No.	Description	Weight (lbs)
81344	3" Wobble Extension	0.280
81345	5" Wobble Extension	0.440
81346	10" Wobble Extension	0.860
81347	15" Wobble Extension	1.360



81302 - 3 Pc. Locking Extension Set 1/2" DRIVE

Material No.	Description	
81348	3" Locking Extension	1/2" Dr.
81349	10" Locking Extension	1/2" Dr.
81350	15" Locking Extension	1/2" Dr.

6 Pt. & 12 Pt. Standard Socket SAE 1/2" DRIVE

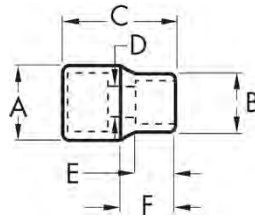

Material No.	Size	Description	Drive End (inch) A	Wrench End (inch) B	Overall Length (inch) C	Bolt Clearance D	Wrench Depth (Inch) E	Length to Shoulder F	Weight (lbs)
80760	7/16"	12 Pt. Std. SAE	0.874	0.669	1.488	0.283	0.551	0.748	0.121
80761	1/2"	12 Pt. Std. SAE	0.874	0.732	1.488	0.354	0.551	0.748	0.121
80763	5/8"	12 Pt. Std. SAE	0.874	0.732	1.488	0.354	0.551	0.748	0.121
80762	9/16"	12 Pt. Std. SAE	0.874	0.732	1.488	0.354	0.551	0.748	0.121
80764	11/16"	12 Pt. Std. SAE	0.937	0.937	1.488	0.472	0.591	0.748	0.165
80765	3/4"	12 Pt. Std. SAE	1.020	1.020	1.488	0.472	0.768	0.748	0.165
80766	13/16"	12 Pt. Std. SAE	1.098	1.098	1.488	0.472	0.768	0.748	0.191
80767	7/8"	12 Pt. Std. SAE	1.177	1.177	1.488	0.472	0.768	0.748	0.224
80768	15/16"	12 Pt. Std. SAE	1.256	1.256	1.488	0.472	0.807	0.748	0.253
80769	1"	12 Pt. Std. SAE	1.335	1.335	1.575	0.472	0.886	0.748	0.319
80770	1-1/16"	12 Pt. Std. SAE	1.413	1.413	1.575	0.472	0.886	0.748	0.341
80771	1-1/8"	12 Pt. Std. SAE	1.492	1.492	1.654	0.472	0.965	1.496	0.350
80793	1-3/16"	12 Pt. Std. SAE	1.524	1.571	1.654	0.472	0.965	1.496	0.500
80794	1-1/4"	12 Pt. Std. SAE	1.602	1.650	1.654	0.472	0.965	1.496	0.500
80680	1-1/2"	12 Pt. Std. SAE	1.913	1.961	1.969	0.472	1.220	1.496	0.550

1/2" OPEN STOCK
RATCHETS, SOCKETS & DRIVE TOOLS

RATCHETS, SOCKETS & DRIVE TOOLS

1/2" OPEN STOCK



6 Pt. & 12 Pt. Standard Socket METRIC 1/2" DRIVE

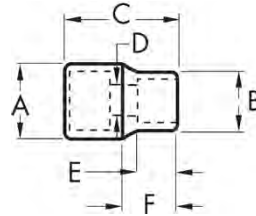

Material No.	Size	Description	Drive End (inch) A	Wrench End (inch) B	Overall Length (inch) C	Bolt Clearance D	Wrench Depth (Inch) E	Length to Shoulder F	Weight (lbs)
80805	8mm	12 Pt. Std. Metric	0.866	0.524	1.488	0.283	0.551	0.748	0.330
80806	9mm	12 Pt. Std. Metric	0.866	0.563	1.488	0.283	0.551	0.748	0.130
80745	10mm	12 Pt. Std. Metric	0.866	0.602	1.488	0.283	0.551	0.748	0.110
80746	11mm	12 Pt. Std. Metric	0.866	0.650	1.488	0.354	0.551	0.748	0.114
80747	12mm	12 Pt. Std. Metric	0.866	0.701	1.488	0.354	0.551	0.748	0.114
80748D	13mm	12 Pt. Std. Metric	0.866	0.748	1.488	0.421	0.551	0.748	0.121
80749	14mm	12 Pt. Std. Metric	0.866	0.799	1.488	0.421	0.571	0.748	0.125
80750	15mm	12 Pt. Std. Metric	0.866	0.843	1.488	0.421	0.571	0.748	0.125
80751	16mm	12 Pt. Std. Metric	0.866	0.850	1.488	0.472	0.571	0.748	0.132
80752	17mm	12 Pt. Std. Metric	0.941	0.941	1.488	0.472	0.591	0.748	0.158
80753	18mm	12 Pt. Std. Metric	0.980	0.980	1.488	0.472	0.591	0.748	0.172
80754	19mm	12 Pt. Std. Metric	1.020	1.020	1.488	0.472	0.768	0.748	0.176
80755D	20mm	12 Pt. Std. Metric	1.094	1.094	1.488	0.472	0.768	0.748	0.198
80756	21mm	12 Pt. Std. Metric	1.098	1.098	1.488	0.472	0.768	0.748	0.187
80757	22mm	12 Pt. Std. Metric	1.177	1.177	1.488	0.472	0.768	0.748	0.220
80758	23mm	12 Pt. Std. Metric	1.256	1.256	1.488	0.472	0.807	0.748	0.264
80759	24mm	12 Pt. Std. Metric	1.256	1.256	1.488	0.472	0.807	0.748	0.275
80811	25mm	12 Pt. Std. Metric	1.262	1.309	1.488	0.000	0.807	0.748	0.130
80681	26 mm	12 Pt. Std. Metric	1.287	1.335	1.575	0.453	0.886	1.496	0.280
80812	27mm	12 Pt. Std. Metric	1.366	1.413	1.575	0.000	0.886	0.748	0.275
80682	28 mm	12 Pt. Std. Metric	1.433	1.480	1.575	0.453	0.886	1.496	0.300
80683	29 mm	12 Pt. Std. Metric	1.445	1.492	1.575	0.453	0.886	1.496	0.330
80813	30mm	12 Pt. Std. Metric	1.524	1.571	1.654	0.000	0.965	0.748	0.275
80814D	32mm	12 Pt. Std. Metric	1.602	1.650	1.654	0.000	0.965	0.748	0.275
80815D	36mm	12 Pt. Std. Metric	1.921	1.969	1.969	0.000	1.102	0.748	0.300

6 Pt. & 12 Pt. Deep Socket SAE/METRIC 1/2" DRIVE

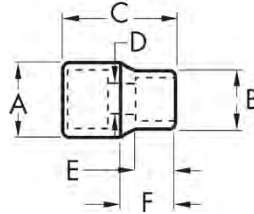

Material No.	Size	Description	Drive End	Wrench	Overall	Bolt	Wrench	Length to	Weight
			(inch) A	End (inch) B	Length (inch) C	Clearance D	Depth (Inch) E	Shoulder F	(lbs)
80772	7/16"	12 Pt. Deep SAE	0.870	0.670	3.030	0.390	0.240	1.500	0.231
80773	1/2"	12 Pt. Deep SAE	0.866	0.732	3.031	0.453	0.287	1.496	0.242
80774	9/16"	12 Pt. Deep SAE	0.866	0.811	3.031	0.453	0.350	1.496	0.253
80775	5/8"	12 Pt. Deep SAE	0.866	0.850	3.031	0.453	0.398	1.496	0.286
80776	11/16"	12 Pt. Deep SAE	0.937	0.937	3.031	0.453	0.398	1.496	0.341
80777D	3/4"	12 Pt. Deep SAE	1.016	1.016	3.031	0.453	0.457	1.496	0.374
80778	13/16"	12 Pt. Deep SAE	1.094	1.094	3.031	0.453	0.480	1.496	0.418
80779	7/8"	12 Pt. Deep SAE	1.173	1.173	3.031	0.453	0.520	1.496	0.495
80780	15/16"	12 Pt. Deep SAE	1.252	1.252	3.031	0.453	0.567	1.496	0.550
80795	1"	12 Pt. Deep SAE	1.283	1.331	3.031	0.453	0.642	1.496	0.550
80796	1-1/16"	12 Pt. Deep SAE	1.362	1.409	3.031	0.453	0.677	1.496	0.550
80797	1-1/8"	12 Pt. Deep SAE	1.441	1.488	3.031	0.453	0.772	1.496	0.280
80798	1-1/4"	12 Pt. Deep SAE	1.598	1.646	3.031	0.453	0.870	1.496	0.300
80687	1-1/2"	12 Pt. Deep SAE	1.598	1.646	3.031	0.453	0.870	1.496	0.300
80781	10mm	12 Pt. Deep Metric	0.866	0.602	3.031	0.374	0.201	1.496	0.231
80782	11mm	12 Pt. Deep Metric	0.866	0.650	3.031	0.394	0.236	1.496	0.231
80783	12mm	12 Pt. Deep Metric	0.866	0.701	3.031	0.433	0.260	1.496	0.238
80784	13mm	12 Pt. Deep Metric	0.866	0.748	3.031	0.453	0.287	1.496	0.246
80785	14mm	12 Pt. Deep Metric	0.866	0.799	3.031	0.453	0.350	1.496	0.246
80786	15mm	12 Pt. Deep Metric	0.866	0.843	3.031	0.453	0.350	1.496	0.246
80787	16mm	12 Pt. Deep Metric	0.866	0.850	3.031	0.453	0.398	1.496	0.286
80788	17mm	12 Pt. Deep Metric	0.937	0.937	3.031	0.453	0.398	1.496	0.304
80789	18mm	12 Pt. Deep Metric	0.976	0.976	3.031	0.453	0.421	1.496	0.330
80790	19mm	12 Pt. Deep Metric	1.016	1.016	3.031	0.453	0.457	1.496	0.341
80817D	20mm	12 Pt. Deep Metric	1.047	1.094	3.031	0.453	0.480	0.748	0.400
80818	21mm	12 Pt. Deep Metric	1.047	1.094	3.031	0.453	0.480	0.748	0.430
80820	22mm	12 Pt. Deep Metric	1.126	1.173	3.031	0.453	0.520	0.748	0.450
80822	24mm	12 Pt. Deep Metric	1.205	1.252	3.031	0.453	0.567	0.748	0.460
80824	27mm	12 Pt. Deep Metric	1.362	1.409	3.031	0.453	0.642	0.748	0.480
80826	30mm	12 Pt. Deep Metric	1.520	1.567	3.031	0.453	0.677	0.748	0.500
80827	32mm	12 Pt. Deep Metric	1.598	1.646	3.031	0.453	0.772	0.748	0.550

1/2" OPEN STOCK

RATCHETS, SOCKETS & DRIVE TOOLS



**80879 - 13 Pc. SAE Standard Socket Set
3/4" DRIVE**

Material No.	Description			
80830	7/8"	12 Pt.	Std. SAE Socket	3/4" Dr.
80831	15/16"	12 Pt.	Std. SAE Socket	3/4" Dr.
80833	1"	12 Pt.	Std. SAE Socket	3/4" Dr.
80834	1-1/16"	12 Pt.	Std. SAE Socket	3/4" Dr.
80835	1-1/8"	12 Pt.	Std. SAE Socket	3/4" Dr.
80838	1-3/16"	12 Pt.	Std. SAE Socket	3/4" Dr.
80839	1-1/4"	12 Pt.	Std. SAE Socket	3/4" Dr.
80840	1-5/16"	12 Pt.	Std. SAE Socket	3/4" Dr.
80841	1-7/16"	12 Pt.	Std. SAE Socket	3/4" Dr.
80852	1-1/2"	12 Pt.	Std. SAE Socket	3/4" Dr.
80854	1-1/2"	12 Pt.	Std. SAE Socket	3/4" Dr.
81412	8" Extension			3/4" Dr.
81400	Quick-Release Teardrop Ratchet			3/4" Dr.



**80880 - 27 Pc. SAE Standard Socket Set
3/4" DRIVE**

Material No.	Description			
80852	1-7/16"	12 Pt.	Std. SAE Socket	3/4" Dr.
80854	1-1/2"	12 Pt.	Std. SAE Socket	3/4" Dr.
80855	1-5/8"	12 Pt.	Std. SAE Socket	3/4" Dr.
80856	1-11/16"	12 Pt.	Std. SAE Socket	3/4" Dr.
80857	1-3/4"	12 Pt.	Std. SAE Socket	3/4" Dr.
80859	1-13/16"	12 Pt.	Std. SAE Socket	3/4" Dr.
80860	1-7/8"	12 Pt.	Std. SAE Socket	3/4" Dr.
80861	2"	12 Pt.	Std. SAE Socket	3/4" Dr.
80862	2-1/8"	12 Pt.	Std. SAE Socket	3/4" Dr.
80863	2-3/16"	12 Pt.	Std. SAE Socket	3/4" Dr.
80864	2-1/4"	12 Pt.	Std. SAE Socket	3/4" Dr.
80865	2-3/8"	12 Pt.	Std. SAE Socket	3/4" Dr.
81411	5" Extension			3/4" Dr.
81412	8" Extension			3/4" Dr.
81413	16" Extension			3/4" Dr.
81400	Quick-Release Teardrop Ratchet			3/4" Dr.
81401	18"	Sliding T Handle		3/4" Dr.
81404	19"	Flex Handle		3/4" Dr.

Material No.	Description			
80830	7/8"	12 Pt.	Std. SAE Socket	3/4" Dr.
80831	15/16"	12 Pt.	Std. SAE Socket	3/4" Dr.
80833	1"	12 Pt.	Std. SAE Socket	3/4" Dr.
80834	1-1/16"	12 Pt.	Std. SAE Socket	3/4" Dr.
80835	1-1/8"	12 Pt.	Std. SAE Socket	3/4" Dr.
80838	1-3/16"	12 Pt.	Std. SAE Socket	3/4" Dr.
80839	1-1/4"	12 Pt.	Std. SAE Socket	3/4" Dr.
80840	1-5/16"	12 Pt.	Std. SAE Socket	3/4" Dr.
80841	1-3/8"	12 Pt.	Std. SAE Socket	3/4" Dr.

Quick Release Ratchet 3/4" DRIVE

Material No.	Description	Overall Length (inch)	Weight (lbs)
81400	Quick-Release Ratchet	19.75"	5.280

- 24 tooth standard ratchet



Sliding T Handle 3/4" DRIVE

Material No.	Description	Overall Length (inch)	Weight (lbs)
81401	Sliding T	19.00"	3.036

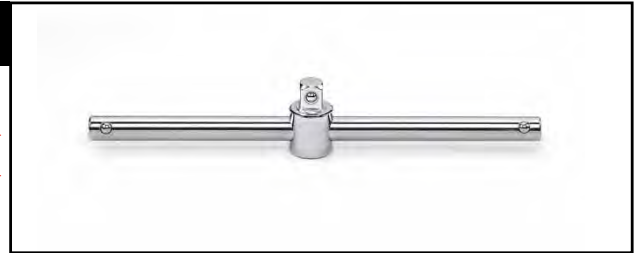

Flex Handle 3/4" DRIVE

Material No.	Description	Overall Length (inch)	Weight (lbs)
81404	Flex Handle	19.00"	4.070

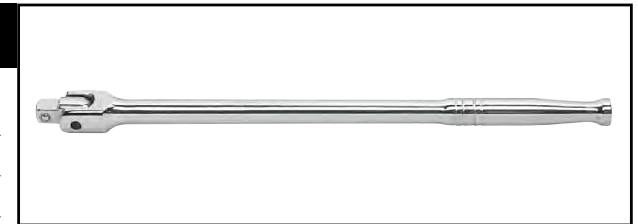

Standard Extension 3/4" DRIVE

Material No.	Description	Weight (lbs)
81411	5" Standard Extension	1.100
81412	8" Standard Extension	2.000
81413	16" Standard Extension	3.058



81499 - Ratchet Repair Kit 3/4" DRIVE



12 Pt. Standard Socket SAE 3/4" DRIVE

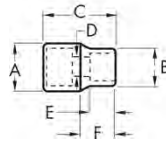

Material No.	Size	Description	Drive End	Wrench	Overall	Bolt	Wrench	Length to	Weight (lbs)	
			(inch)	End (inch)	Length (inch)	Clearance	Depth (Inch)	Shoulder		
			A	B	C	D	E	F		
80830	7/8"	12 Pt. Std. SAE	1.417	1.268	1.969	N/A	0.551	0.866	0.462	
80831	15/16"	12 Pt. Std. SAE	1.417	1.346	2.008	N/A	0.630	0.866	0.484	
80833	1"	12 Pt. Std. SAE	1.417	1.457	2.047	N/A	0.630	1.181	0.484	
80834	1-1/16"	12 Pt. Std. SAE	1.417	1.496	2.047	N/A	0.866	1.181	0.484	
80835D	1-1/8"	12 Pt. Std. SAE	1.496	1.575	2.047	N/A	0.866	1.181	0.550	
80838	1-3/16"	12 Pt. Std. SAE	1.496	1.654	2.126	N/A	0.945	1.260	0.594	
80839	1-1/4"	12 Pt. Std. SAE	1.496	1.732	2.205	N/A	0.945	1.299	0.638	
80840	1-5/16"	12 Pt. Std. SAE	1.496	1.811	2.205	N/A	1.024	1.299	0.682	
80841	1-3/8"	12 Pt. Std. SAE	1.654	1.890	2.283	N/A	1.024	1.378	0.814	
80852	1-7/16"	12 Pt. Std. SAE	1.654	1.969	2.283	N/A	1.102	1.378	0.858	
80854	1-1/2"	12 Pt. Std. SAE	1.772	2.047	2.362	N/A	1.102	1.417	0.990	
80855D	1-5/8"	12 Pt. Std. SAE	1.772	2.205	2.520	N/A	1.181	1.575	1.166	
80856	1-11/16"	12 Pt. Std. SAE	1.772	2.283	2.559	N/A	1.260	1.535	1.210	
80857	1-3/4"	12 Pt. Std. SAE	1.890	2.362	2.598	N/A	1.260	1.575	1.320	
80859	1-13/16"	12 Pt. Std. SAE	1.850	2.441	2.677	N/A	1.339	1.575	1.430	
80860	1-7/8"	12 Pt. Std. SAE	1.890	2.520	2.756	N/A	1.339	1.654	1.540	
80861	2"	12 Pt. Std. SAE	1.890	2.677	2.835	N/A	1.417	1.654	1.628	
80862	2-1/8"	12 Pt. Std. SAE	1.890	2.835	2.913	N/A	1.496	1.732	1.804	
80863	2-3/16"	12 Pt. Std. SAE	1.890	2.913	2.992	N/A	1.496	1.772	1.914	
80864	2-1/4"	12 Pt. Std. SAE	1.890	2.992	2.992	N/A	1.575	1.772	2.024	
80865	2-3/8"	12 Pt. Std. SAE	1.890	3.150	3.071	N/A	1.575	1.811	2.200	

**LOCKING FLEX GEARWRENCH
PASS-THRU™ RATCHET**

5° Ratcheting arc versus 12° on conventional ratchets

Pass-Thru® Ratchet & Socket System features the Vortex™ drive system that links drivetools and sockets

One touch release for 11 locking positions

Up to 50% thinner than conventional ratchet systems

Pass-Thru® Ratchet & Socket System eliminates the need for deep sockets

Dual material handle for improved ergonomics

Up to 40% stronger by eliminating drive tang

Reach fasteners in tight spaces with ease

XL PASS-THROUGH

**VORTEX™
BIT SOCKETS**

Vortex™ Bit Sockets are available in Hex, Torx®, Phillips, and Slotted

Vortex™ Bit Sockets are broached for use with 1/4" and 3/8" Conventional Square Drive Ratchets

Products are covered by one or more of the following patents:
• US 7,1168,346 US 6,868,709 US 7,231,851

SETS
XL PASS-THROUGH



891226 - 25 Pc. SAE/METRIC Pass-Thru® Ratchet Set Featuring Locking Flex GearRatchet™ Handle 3/8" DRIVE

Material No.	Description		
142200	5/8"	Vortex SAE Socket	3/8" Dr.
142220	1/16"	Vortex SAE Socket	1/2" Dr.
142240	3/4"	Vortex SAE Socket	1/2" Dr.
142260	3/16"	Vortex SAE Socket	1/2" Dr.
142280	7/8"	Vortex SAE Socket	1/2" Dr.
142300	5/16"	Vortex SAE Socket	1/2" Dr.
142320	1"	Vortex SAE Socket	1/2" Dr.
142340	1-1/16"	Vortex SAE Socket	1/2" Dr.

Material No.	Description		
142360	1-1/8"	Vortex SAE Socket	1/2" Dr.
142380	1-1/4"	Vortex SAE Socket	1/2" Dr.
542150	15 mm	Vortex SAE Socket	1/2" Dr.
542160	16 mm	Vortex Metric Socket	1/2" Dr.
542170	17 mm	Vortex Metric Socket	1/2" Dr.
542180	18 mm	Vortex Metric Socket	1/2" Dr.
542190	19 mm	Vortex Metric Socket	1/2" Dr.
542200	20 mm	Vortex Metric Socket	1/2" Dr.
542210	21 mm	Vortex Metric Socket	1/2" Dr.
542220	22 mm	Vortex Metric Socket	1/2" Dr.
542240	24 mm	Vortex Metric Socket	1/2" Dr.
542270	27 mm	Vortex Metric Socket	1/2" Dr.
542300	30 mm	Vortex Metric Socket	1/2" Dr.
542320	32 mm	Vortex Metric Socket	1/2" Dr.
241080	6"	Vortex Metric Socket	1/2" Dr.
241062	1/2" Sq. Dr.	Quick-Release Adapter	1/2" Dr.
891200		Locking Flex GearRatchet™ Adapter	1/2" Dr.



Locking Flex GearRatchet™ Handle

Material No.	Description	Length (inches)	Weight (lbs)
893800	3/8" Dr.	12.00	0.858

Vortex Sockets 3/8" DRIVE

Material No.	Description	Length (inches)	Weight (lbs)
132120GR	3/8"	1.26	0.055
132140GR	7/16"	1.26	0.055
132160GR	1/2"	1.26	0.055
132180GR	9/16"	1.26	0.066
132200GR	5/8"	1.26	0.066
132220GR	11/16"	1.26	0.066
132240GR	3/4"	1.30	0.077
132260GR	13/16"	1.38	0.088
132280GR	7/8"	1.38	0.088
532100GR	10 mm	1.26	0.055
532110GR	11 mm	1.26	0.055
532120GR	12 mm	1.26	0.055
532130GR	13 mm	1.26	0.055



Material No.	Description	Length (inches)	Weight (lbs)
532140GR	14 mm	1.26	0.059
532150GR	15 mm	1.26	0.059
532160GR	16 mm	1.26	0.066
532170GR	17 mm	1.26	0.066
532180GR	18 mm	1.26	0.07
532190GR	19 mm	1.30	0.077

Pass-Thru® Quick-Release Adapters

Material No.	Description	Length (inches)	Weight (lbs)
231062GR	3/8" Sq. Dr.	1.17	0.858



VORTEX ADAPTERS/
SOCKETS

XL PASS-THROUGH

BIT SOCKETS & FLEX HEX KEYS

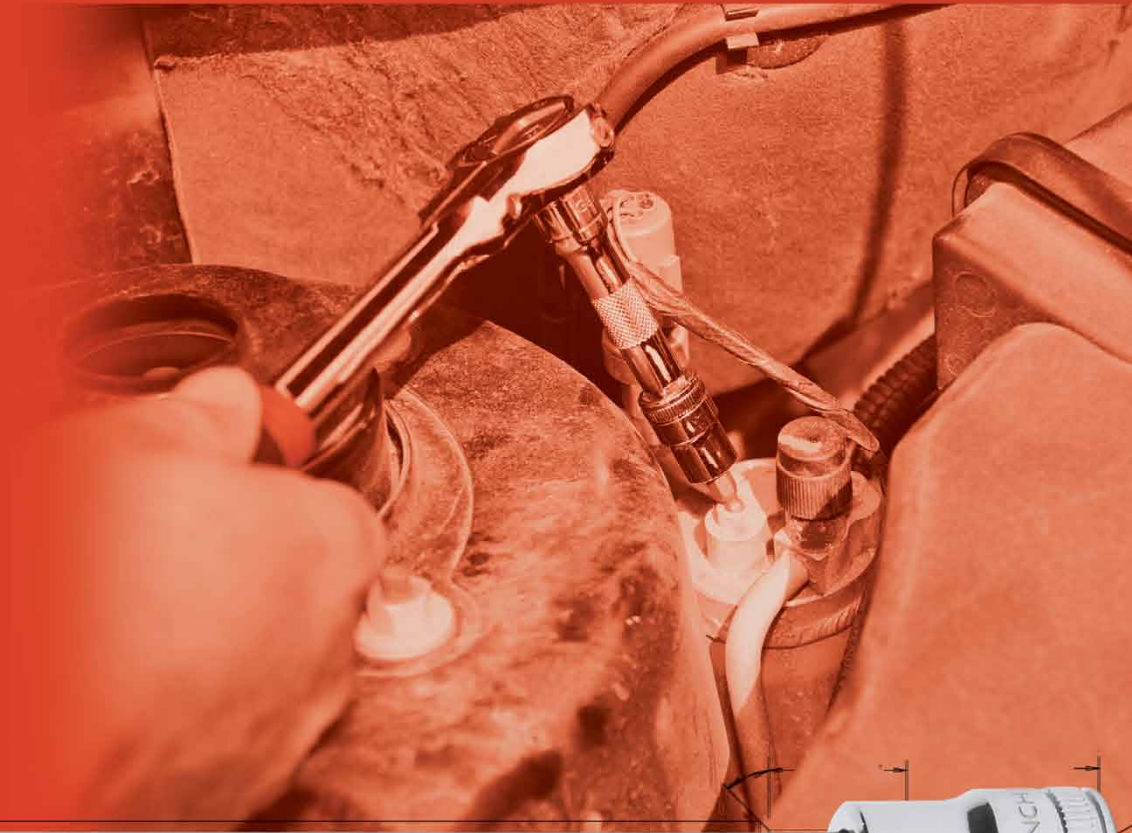

Bit Sockets

1/4" Drive Sets
3/8" Drive Sets
1/2" Drive Sets

Flex Hex™ Keys

Long Ball Hex Sets







**BIT
SOCKETS**

Ball and Standard
Hex in All Sizes



AVAILABLE IN:

 TORX® PRESS FIT	 INTERNAL TORX®	 EXTERNAL TORX®
 BALL HEX	 HEXAGON	

Heat Treated Socket Bases for
Durability and Serviceability



Torx® Head Style

Chrome Sockets



Hex Head Style

Packed on
Clip Rail Sets



BIT SOCKETS

Torx® is a registered trademark of Acument Intellectual Properties, LLC.

BIT SOCKETS

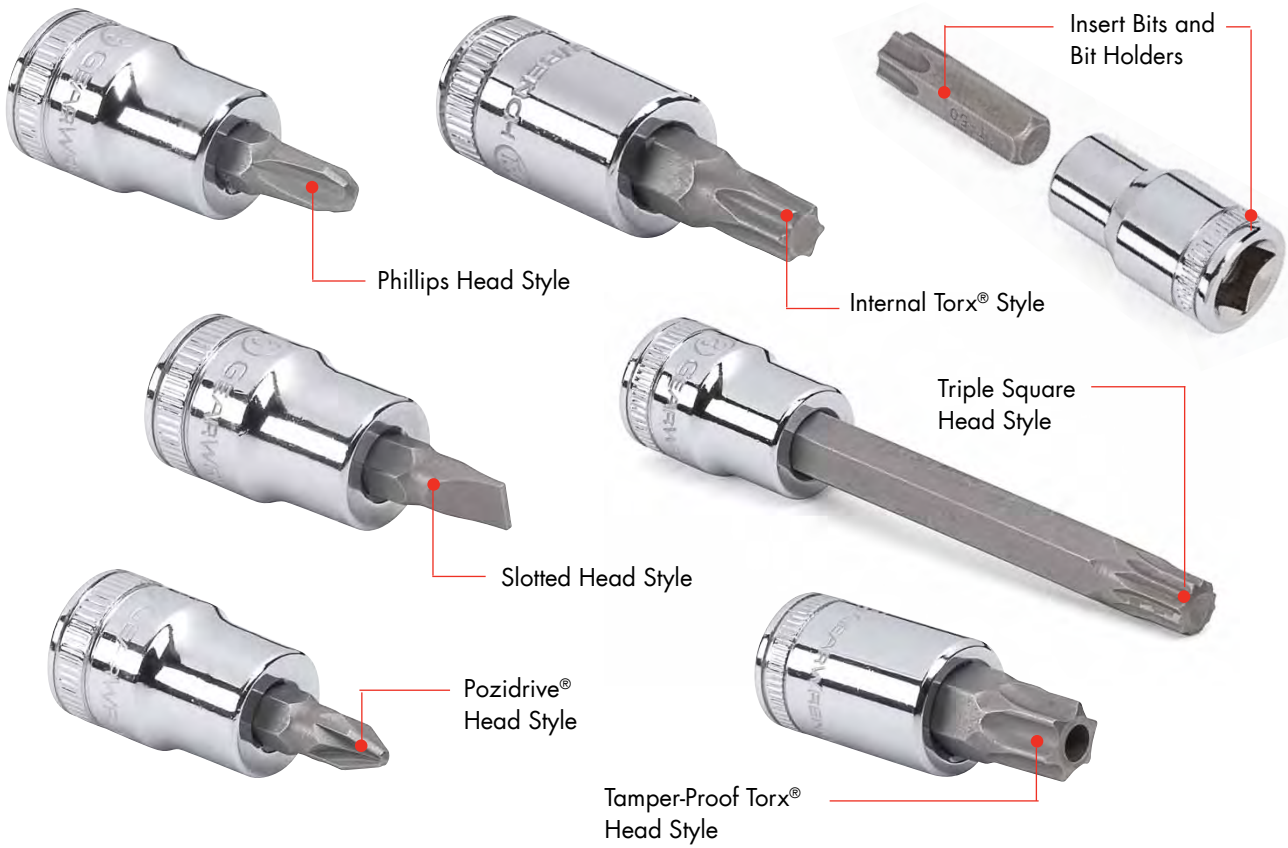

FLEX HEX™ KEYS

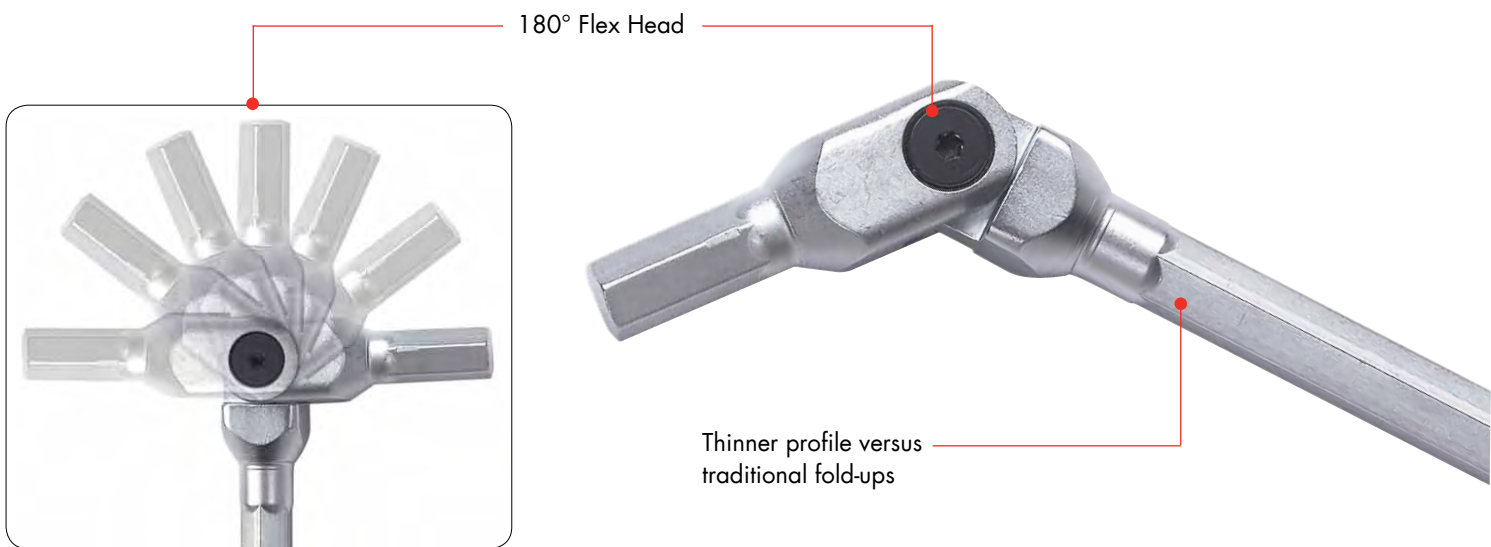

Torx® is a registered trademark of Acument Intellectual Properties, LLC.

80723 - 13 Pc. TORX® Press Fit Bit Socket Set

Material No.	Description	
80171	T-8 Torx® Press Fit Bit Socket	1/4" Drive
80172	T-10 Torx® Press Fit Bit Socket	1/4" Drive
80173	T-15 Torx® Press Fit Bit Socket	1/4" Drive
80174	T-20 Torx® Press Fit Bit Socket	1/4" Drive
80175	T-25 Torx® Press Fit Bit Socket	1/4" Drive
80176	T-27 Torx® Press Fit Bit Socket	1/4" Drive
80177	T-30 Torx® Press Fit Bit Socket	1/4" Drive
80451	T-40 Torx® Press Fit Bit Socket	3/8" Drive
80452	T-45 Torx® Press Fit Bit Socket	3/8" Drive
80453	T-47 Torx® Press Fit Bit Socket	3/8" Drive
80454	T-50 Torx® Press Fit Bit Socket	3/8" Drive
80455	T-55 Torx® Press Fit Bit Socket	3/8" Drive
80667	T-60 Torx® Press Fit Bit Socket	1/2" Drive



TORX® PRESS FIT

**80588 - 10 Pc. Long TORX® Bit Socket Set
1/4" & 3/8" DRIVE**

Material No.	Description	
82510	T-8 Long Torx® Bit Socket	1/4" Drive
82511	T-10 Long Torx® Bit Socket	1/4" Drive
82512	T-15 Long Torx® Bit Socket	1/4" Drive
82513	T-20 Long Torx® Bit Socket	1/4" Drive
82514	T-25 Long Torx® Bit Socket	1/4" Drive
82515	T-27 Long Torx® Bit Socket	1/4" Drive
82516	T-30 Long Torx® Bit Socket	1/4" Drive
82517	T-40 Long Torx® Bit Socket	3/8" Drive
82518	T-45 Long Torx® Bit Socket	3/8" Drive
82519	T-50 Long Torx® Bit Socket	3/8" Drive



INTERNAL TORX®

**80578 - 10 Pc. METRIC HEX Bit Socket Set
3/8" & 1/2" DRIVE**

Material No.	Description	
80425	4mm Hex Bit Socket	3/8" Drive
80426	5mm Hex Bit Socket	3/8" Drive
80427	6mm Hex Bit Socket	3/8" Drive
80428	7mm Hex Bit Socket	3/8" Drive
80429	8mm Hex Bit Socket	3/8" Drive
80430	9mm Hex Bit Socket	3/8" Drive
80431	10mm Hex Bit Socket	3/8" Drive
80661	12mm Hex Bit Socket	1/2" Drive
80662	14mm Hex Bit Socket	1/2" Drive
80663	17mm Hex Bit Socket	1/2" Drive



HEXAGON

MULTI DRIVE SETS
BIT SOCKETS



80322 - 6 Pc. DEEP External TORX® Socket Set
1/4" DRIVE

Item No.	Description	
80191	E-4 Deep External Torx® Socket	1/4" Drive
80192	E-5 Deep External Torx® Socket	1/4" Drive
80193	E-6 Deep External Torx® Socket	1/4" Drive
80194	E-7 Deep External Torx® Socket	1/4" Drive
80195	E-8 Deep External Torx® Socket	1/4" Drive
80196	E-10 Deep External Torx® Socket	1/4" Drive



EXTERNAL TORX®



80581 - 12 Pc. SAE HEX Bit Socket Set
3/8" DRIVE

Material No.	Description	
80410	1/16" Hex Bit Socket	3/8" Drive
80411	5/64" Hex Bit Socket	3/8" Drive
80412	3/32" Hex Bit Socket	3/8" Drive
80413	7/64" Hex Bit Socket	3/8" Drive
80414	1/8" Hex Bit Socket	3/8" Drive
80415	9/64" Hex Bit Socket	3/8" Drive
80416	5/32" Hex Bit Socket	3/8" Drive
80417	3/16" Hex Bit Socket	3/8" Drive
80418	7/32" Hex Bit Socket	3/8" Drive
80419	1/4" Hex Bit Socket	3/8" Drive
80420	5/16" Hex Bit Socket	3/8" Drive
80421	3/8" Hex Bit Socket	3/8" Drive



HEXAGON



80580 - 12 Pc. METRIC HEX Bit Socket Set
3/8" DRIVE

Material No.	Description	
80422	2mm Hex Bit Socket	3/8" Drive
80423	2.5mm Hex Bit Socket	3/8" Drive
80424	3mm Hex Bit Socket	3/8" Drive
80425	4mm Hex Bit Socket	3/8" Drive
80426	5mm Hex Bit Socket	3/8" Drive
80427	6mm Hex Bit Socket	3/8" Drive
80428	7mm Hex Bit Socket	3/8" Drive
80429	8mm Hex Bit Socket	3/8" Drive
80430	9mm Hex Bit Socket	3/8" Drive
80431	10mm Hex Bit Socket	3/8" Drive
80432	11mm Hex Bit Socket	3/8" Drive
80433	12mm Hex Bit Socket	3/8" Drive



HEXAGON

Torx® is a registered trademark of Acument Intellectual Properties, LLC.

**80573 - 8 Pc. METRIC LONG BALL HEX
Bit Socket Set 3/8" DRIVE**

Material No.	Description	
80441	3mm Long Ball Hex Bit Socket	3/8" Drive
80442	4mm Long Ball Hex Bit Socket	3/8" Drive
80443	5mm Long Ball Hex Bit Socket	3/8" Drive
80444	6mm Long Ball Hex Bit Socket	3/8" Drive
80445	7mm Long Ball Hex Bit Socket	3/8" Drive
80446	8mm Long Ball Hex Bit Socket	3/8" Drive
80447	9mm Long Ball Hex Bit Socket	3/8" Drive
80448	10mm Long Ball Hex Bit Socket	3/8" Drive



**80574 - 7 Pc. SAE LONG BALL HEX
Bit Socket Set 3/8" DRIVE**

Material No.	Description	
80434	1/8" Long Ball Hex Bit Socket	3/8" Drive
80435	5/32" Long Ball Hex Bit Socket	3/8" Drive
80436	3/16" Long Ball Hex Bit Socket	3/8" Drive
80437	7/32" Long Ball Hex Bit Socket	3/8" Drive
80438	1/4" Long Ball Hex Bit Socket	3/8" Drive
80439	5/16" Long Ball Hex Bit Socket	3/8" Drive
80440	3/8" Long Ball Hex Bit Socket	3/8" Drive



3/8" DRIVESETS
LONG BALL HEX

IMPACT SOCKETS



Impact Sockets

1/2" Drive Sets

1/2" Drive Open Stock

IMPACT SOCKETS

- AVAILABLE IN:**
- 1/2" Drive
 - Universal Sockets
 - Hex Sockets
 - Adapters and Drive Tools



Reinforced Moulded cases with sizes marked for quick identification and storage

Reinforced Steel hinges for added durability

Steel Buckles provide security and strength

Surface Drive™ Technology



Chrome Molybdenum Alloy Steel (CR-MO) for exceptional strength and long lasting durability

High Visibility Laser Etched Markings

Additional Hard Stamping (on opposite side)



Pin hole available for use with pin and o-ring for secure socket retention

IMPACT SOCKETS



**84931 - 12 Pc. Impact SAE Standard Socket Set
1/2" DRIVE**

Material No.	Description
84500	3/8" 6 Pt. Std. SAE Socket 1/2" Dr.
84501	7/16" 6 Pt. Std. SAE Socket 1/2" Dr.
84502	1/2" 6 Pt. Std. SAE Socket 1/2" Dr.

Material No.	Description
84503	9/16" 6 Pt. Std. SAE Socket 1/2" Dr.
84504	5/8" 6 Pt. Std. SAE Socket 1/2" Dr.
84505	11/16" 6 Pt. Std. SAE Socket 1/2" Dr.
84506	3/4" 6 Pt. Std. SAE Socket 1/2" Dr.
84507	13/16" 6 Pt. Std. SAE Socket 1/2" Dr.
84508	7/8" 6 Pt. Std. SAE Socket 1/2" Dr.
84509	15/16" 6 Pt. Std. SAE Socket 1/2" Dr.
84510	1" 6 Pt. Std. SAE Socket 1/2" Dr.
84511	1-1/16" 6 Pt. Std. SAE Socket 1/2" Dr.



**84930 - 12 Pc. Impact METRIC Standard Socket Set
1/2" DRIVE**

Material No.	Description
84520	8 mm 6 Pt. Std. Metric Socket 1/2" Dr.
84521	9 mm 6 Pt. Std. Metric Socket 1/2" Dr.
84522	10 mm 6 Pt. Std. Metric Socket 1/2" Dr.

Material No.	Description
84523	11 mm 6 Pt. Std. Metric Socket 1/2" Dr.
84524	12 mm 6 Pt. Std. Metric Socket 1/2" Dr.
84525	13 mm 6 Pt. Std. Metric Socket 1/2" Dr.
84526	14 mm 6 Pt. Std. Metric Socket 1/2" Dr.
84527	15 mm 6 Pt. Std. Metric Socket 1/2" Dr.
84528	16 mm 6 Pt. Std. Metric Socket 1/2" Dr.
84529	17 mm 6 Pt. Std. Metric Socket 1/2" Dr.
84530	18 mm 6 Pt. Std. Metric Socket 1/2" Dr.
84531	19 mm 6 Pt. Std. Metric Socket 1/2" Dr.



**84942 - 12 Pc. Impact SAE Deep Socket Set
1/2" DRIVE**

Material No.	Description
84546	3/8" 6 Pt. Deep SAE Socket 1/2" Dr.
84547	7/16" 6 Pt. Deep SAE Socket 1/2" Dr.
84548	1/2" 6 Pt. Deep SAE Socket 1/2" Dr.
84549	9/16" 6 Pt. Deep SAE Socket 1/2" Dr.
84550	5/8" 6 Pt. Deep SAE Socket 1/2" Dr.
84551	11/16" 6 Pt. Deep SAE Socket 1/2" Dr.
84552	3/4" 6 Pt. Deep SAE Socket 1/2" Dr.
84553	13/16" 6 Pt. Deep SAE Socket 1/2" Dr.
84554	7/8" 6 Pt. Deep SAE Socket 1/2" Dr.
84555	15/16" 6 Pt. Deep SAE Socket 1/2" Dr.
84556	1" 6 Pt. Deep SAE Socket 1/2" Dr.
84557	1-1/16" 6 Pt. Deep SAE Socket 1/2" Dr.

1/2" DRIVE SETS
IMPACT SOCKETS

**84944 - 12 Pc. Impact METRIC Deep Socket Set
1/2" DRIVE**

Material No.	Description		
84566	8 mm	6 Pt. Deep Metric Socket	1/2" Dr.
84567	9 mm	6 Pt. Deep Metric Socket	1/2" Dr.
84568	10 mm	6 Pt. Deep Metric Socket	1/2" Dr.
84569	11 mm	6 Pt. Deep Metric Socket	1/2" Dr.
84570	12 mm	6 Pt. Deep Metric Socket	1/2" Dr.
84571	13 mm	6 Pt. Deep Metric Socket	1/2" Dr.
84572	14 mm	6 Pt. Deep Metric Socket	1/2" Dr.
84573	15 mm	6 Pt. Deep Metric Socket	1/2" Dr.
84574	16 mm	6 Pt. Deep Metric Socket	1/2" Dr.
84575	17 mm	6 Pt. Deep Metric Socket	1/2" Dr.
84576	18 mm	6 Pt. Deep Metric Socket	1/2" Dr.
84577	19 mm	6 Pt. Deep Metric Socket	1/2" Dr.



**84940 - 7 Pc. Impact SAE HEX Socket Set
1/2" DRIVE**

Material No.	Description		
84634	3/8"	6 Pt. Hex Bit SAE Socket	1/2" Dr.
84635	7/16"	6 Pt. Hex Bit SAE Socket	1/2" Dr.
84636	1/2"	6 Pt. Hex Bit SAE Socket	1/2" Dr.
84637	9/16"	6 Pt. Hex Bit SAE Socket	1/2" Dr.
84638	5/8"	6 Pt. Hex Bit SAE Socket	1/2" Dr.
84639	11/16"	6 Pt. Hex Bit SAE Socket	1/2" Dr.
84640	3/4"	6 Pt. Hex Bit SAE Socket	1/2" Dr.



1/2" DRIVESETS
IMPACT SOCKETS



Impact Extension Bars SAE 1/2" DRIVE

Material No.	Description	Weight (lbs)
84646	5" Extension Bar	0.498
84644	10" Extension Bar	0.492



Standard Impact Adapters SAE 1/2" DRIVE

Material No.	Description	Weight (lbs)
84643	1/2" F x 3/8" M	0.154



Universal Impact Joints SAE 1/2" DRIVE

Material No.	Description	Weight (lbs)
80671	1/2" Universal Joint	0.374

1/2" OPEN STOCK
IMPACT SOCKETS

6 Pt. Standard Impact Sockets SAE/METRIC 1/2" DRIVE

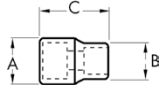

Material No.	Size	Description	Drive End (inch) A	Wrench End (inch) B	Overall Length (inch) C	Weight (lbs)
84500D	3/8"	6 Pt. Std. SAE	0.866	0.63	1.496	0.143
84501	7/16"	6 Pt. Std. SAE	0.866	0.709	1.496	0.143
84502	1/2"	6 Pt. Std. SAE	0.866	0.787	1.496	0.143
84503	9/16"	6 Pt. Std. SAE	0.945	0.866	1.496	0.176
84504D	5/8"	6 Pt. Std. SAE	0.984	0.984	1.496	0.194
84505D	11/16"	6 Pt. Std. SAE	1.024	1.024	1.496	0.209
84506D	3/4"	6 Pt. Std. SAE	1.102	1.102	1.496	0.234
84507D	13/16"	6 Pt. Std. SAE	1.181	1.181	1.496	0.265
84508D	7/8"	6 Pt. Std. SAE	1.26	1.26	1.496	0.32
84509D	15/16"	6 Pt. Std. SAE	1.339	1.339	1.496	0.357
84510D	1"	6 Pt. Std. SAE	1.417	1.417	1.496	0.419
84511D	1-1/16"	6 Pt. Std. SAE	1.496	1.496	1.575	0.467
84512D	1-1/8"	6 Pt. Std. SAE	1.496	1.575	1.575	0.492
84513D	1-3/16"	6 Pt. Std. SAE	1.496	1.654	1.575	0.518
84514D	1-1/4"	6 Pt. Std. SAE	1.496	1.732	1.575	0.551

1/2" OPEN STOCK

IMPACT SOCKETS



6 Pt. Standard Impact Sockets SAE/METRIC 1/2" DRIVE

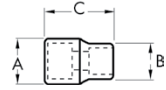

1/2" OPEN STOCK
IMPACT SOCKETS

Material No.	Size	Description	Drive End (inch) A	Wrench End (inch) B	Overall Length (inch) C	Weight (lbs)
84515D	1-5/16"	6 Pt. Std. SAE	1.496	1.772	1.693	0.646
84516D	1-3/8"	6 Pt. Std. SAE	1.496	1.85	1.693	0.675
84517D	1-7/16"	6 Pt. Std. SAE	1.496	1.89	1.693	0.679
84518D	1-1/2"	6 Pt. Std. SAE	1.496	1.968	1.693	0.765
84520	8 mm	6 Pt. Std. Metric	0.866	0.571	1.496	0.11
84521D	9 mm	6 Pt. Std. Metric	0.866	0.614	1.496	0.11
84522D	10 mm	6 Pt. Std. Metric	0.866	0.657	1.496	0.143
84523D	11 mm	6 Pt. Std. Metric	0.866	0.709	1.496	0.143
84524D	12 mm	6 Pt. Std. Metric	0.866	0.748	1.496	0.143
84525D	13 mm	6 Pt. Std. Metric	0.945	0.795	1.496	0.176
84526D	14 mm	6 Pt. Std. Metric	0.945	0.846	1.496	0.176
84527D	15 mm	6 Pt. Std. Metric	0.984	0.906	1.496	0.192
84528D	16 mm	6 Pt. Std. Metric	0.984	0.984	1.496	0.192
84529D	17 mm	6 Pt. Std. Metric	1.024	1.024	1.496	0.209
84530D	18 mm	6 Pt. Std. Metric	1.063	1.063	1.496	0.225
84531	19 mm	6 Pt. Std. Metric	1.102	1.102	1.496	0.232
84532	20 mm	6 Pt. Std. Metric	1.181	1.181	1.496	0.276
84533	21 mm	6 Pt. Std. Metric	1.181	1.181	1.496	0.276
84534	22 mm	6 Pt. Std. Metric	1.26	1.26	1.496	0.318
84535	23 mm	6 Pt. Std. Metric	1.299	1.299	1.496	0.34
84536	24 mm	6 Pt. Std. Metric	1.339	1.339	1.496	0.353
84537	25 mm	6 Pt. Std. Metric	1.417	1.417	1.654	0.443
84538	26 mm	6 Pt. Std. Metric	1.417	1.417	1.654	0.43
84539	28 mm	6 Pt. Std. Metric	1.496	1.496	1.654	0.494
84540	29 mm	6 Pt. Std. Metric	1.614	1.614	1.654	0.584
84541	30 mm	6 Pt. Std. Metric	1.496	1.654	1.654	0.558
84542	31 mm	6 Pt. Std. Metric	1.496	1.654	1.654	0.558
84543	32 mm	6 Pt. Std. Metric	1.496	1.732	1.654	0.573
84544	36 mm	6 Pt. Std. Metric	1.496	1.968	1.968	0.573

6 Pt. Deep Impact Sockets SAE/METRIC 1/2" DRIVE

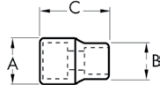

Material No.	Size	Description	Drive End (inch) A	Wrench End (inch) B	Overall Length (inch) C	Weight (lbs)
84546	3/8"	6 Pt. Deep SAE	0.866	0.63	3.071	0.331
84547	7/16"	6 Pt. Deep SAE	0.866	0.709	3.071	0.335
84548	1/2"	6 Pt. Deep SAE	0.866	0.787	3.071	0.335
84549	9/16"	6 Pt. Deep SAE	0.945	0.866	3.071	0.368
84550	5/8"	6 Pt. Deep SAE	0.984	0.984	3.071	0.401
84551	11/16"	6 Pt. Deep SAE	1.024	1.024	3.071	0.419
84552D	3/4"	6 Pt. Deep SAE	1.102	1.102	3.071	0.485
84553	13/16"	6 Pt. Deep SAE	1.181	1.181	3.071	0.54
84554D	7/8"	6 Pt. Deep SAE	1.26	1.26	3.071	0.624
84555D	15/16"	6 Pt. Deep SAE	1.339	1.339	3.071	0.706
84556	1"	6 Pt. Deep SAE	1.417	1.417	3.071	0.807
84557	1-1/16"	6 Pt. Deep SAE	1.496	1.496	3.071	0.915
84558	1-1/8"	6 Pt. Deep SAE	1.496	1.575	3.071	0.937
84560	1-1/4"	6 Pt. Deep SAE	1.496	1.732	3.071	1.08

1/2" OPEN STOCK
IMPACT SOCKETS



6 Pt. Deep Impact Sockets SAE/METRIC 1/2" DRIVE

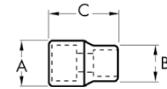

Material No.	Size	Description	Drive End (inch) A	Wrench End (inch) B	Overall Length (inch) C	Weight (lbs)
84572	14 mm	6 Pt. Deep Metric	0.945	0.846	3.071	0.37
84573	15 mm	6 Pt. Deep Metric	0.945	0.945	3.071	0.377
84574	16 mm	6 Pt. Deep Metric	0.984	0.984	3.071	0.426
84575D	17 mm	6 Pt. Deep Metric	1.024	1.024	3.071	0.419
84576	18 mm	6 Pt. Deep Metric	1.024	1.024	3.071	0.397
84577	19 mm	6 Pt. Deep Metric	1.102	1.102	3.071	0.485
84578	20 mm	6 Pt. Deep Metric	1.181	1.181	3.071	0.573
84579	21 mm	6 Pt. Deep Metric	1.181	1.181	3.071	0.54
84580	22 mm	6 Pt. Deep Metric	1.26	1.26	3.071	0.631
84581	23 mm	6 Pt. Deep Metric	1.26	1.26	3.071	0.609
84582	24 mm	6 Pt. Deep Metric	1.339	1.339	3.071	0.692
84583	25 mm	6 Pt. Deep Metric	1.417	1.417	3.071	0.794
84584	26 mm	6 Pt. Deep Metric	1.417	1.417	3.071	0.798
84585D	27 mm	6 Pt. Deep Metric	1.496	1.496	3.071	0.893
84586D	28 mm	6 Pt. Deep Metric	1.575	1.575	3.071	0.983
84587	29 mm	6 Pt. Deep Metric	1.575	1.575	3.071	0.959
84588	30 mm	6 Pt. Deep Metric	1.496	1.654	3.071	0.999
84589D	31 mm	6 Pt. Deep Metric	1.496	1.732	3.071	1.036
84590D	32 mm	6 Pt. Deep Metric	1.496	1.732	3.071	1.091

1/2" OPEN STOCK
IMPACT SOCKETS

WRENCHES

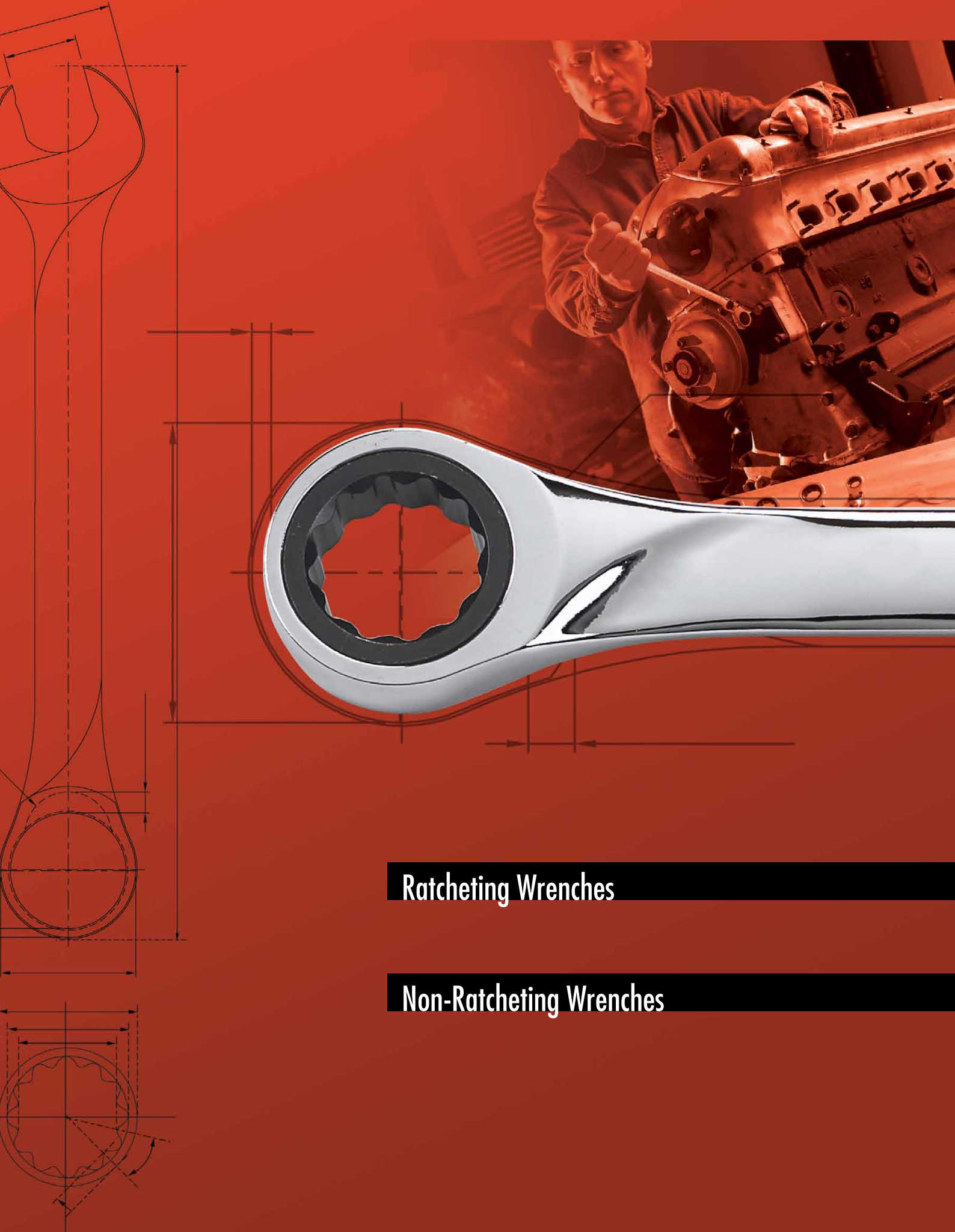

Ratcheting Wrenches

Non-Ratcheting Wrenches

RATCHETING WRENCHES

Surface Drive® box reduces fastener rounding

Ratcheting box end needs as little as 5° to move fasteners versus 30° for standard box end wrenches

Patented award-winning design

Up to 25% longer to access hard-to-reach fasteners

Hex head set screw, instead of being pinned

X-Beam™ allows you to apply force to the flat side of the wrench, reducing hand fatigue

Flexible Head

XL X-Beam Flex Ratcheting Wrench™

AVAILABLE IN:



XL Combination



XL X-Beam™



XL Locking Flex



XL Spline



XL GearBox™



Reversible



Flex



Subby Flex



Combination



Stubby



QuadBox™



Double Box



Half Moon



S-Shape

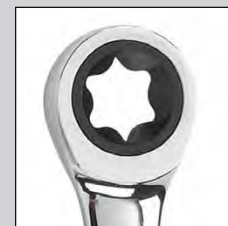

E-Torx®

WRENCHES

RATCHETING WRENCHES

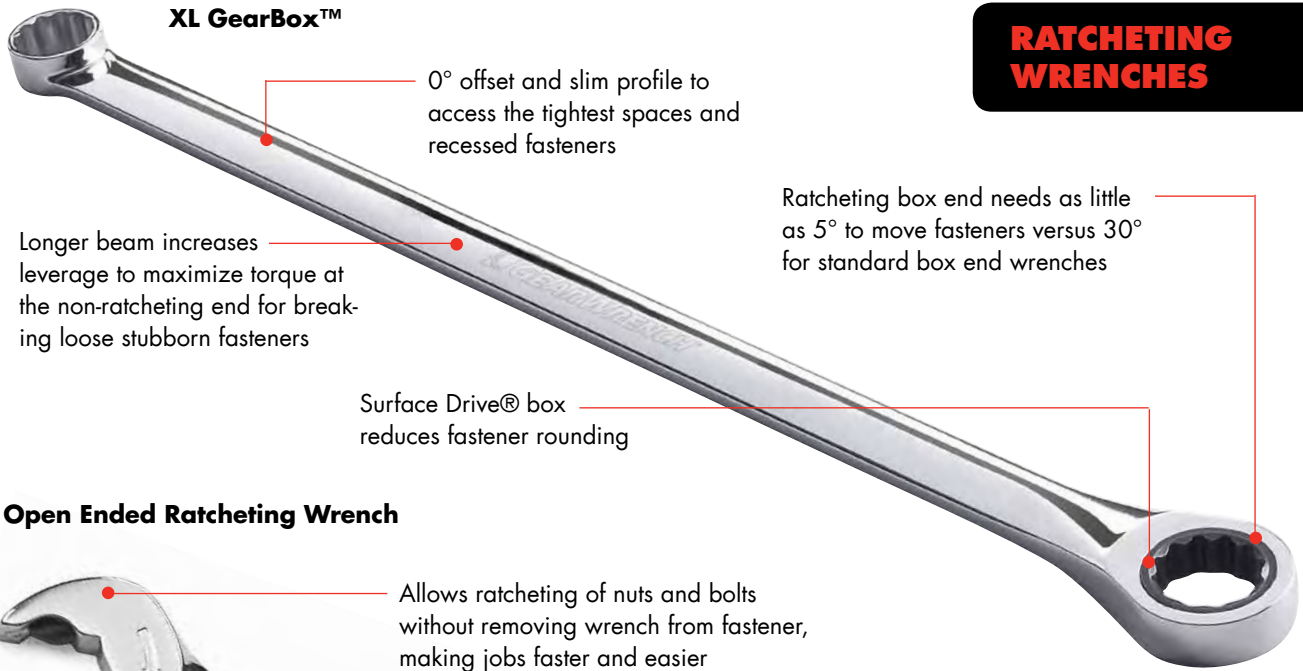

Open Ended Ratcheting Wrench

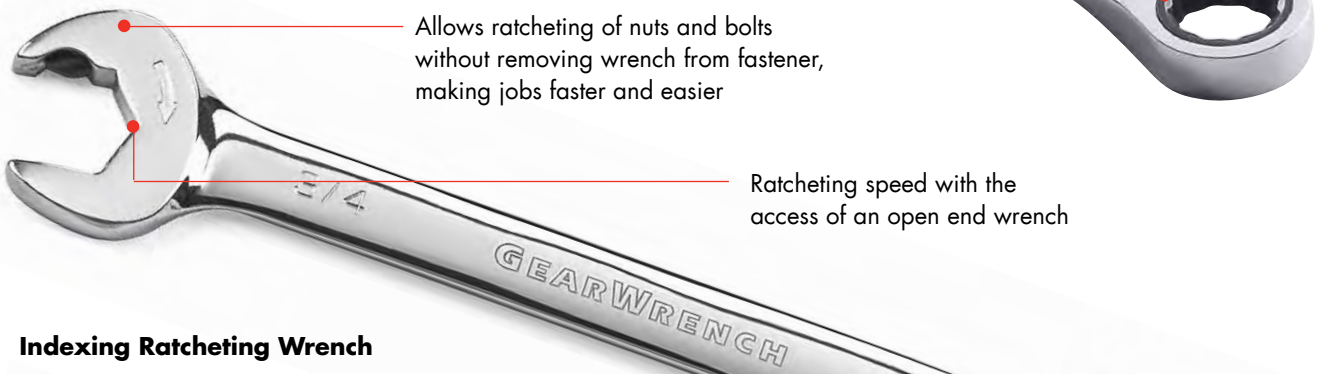

Indexing Ratcheting Wrench

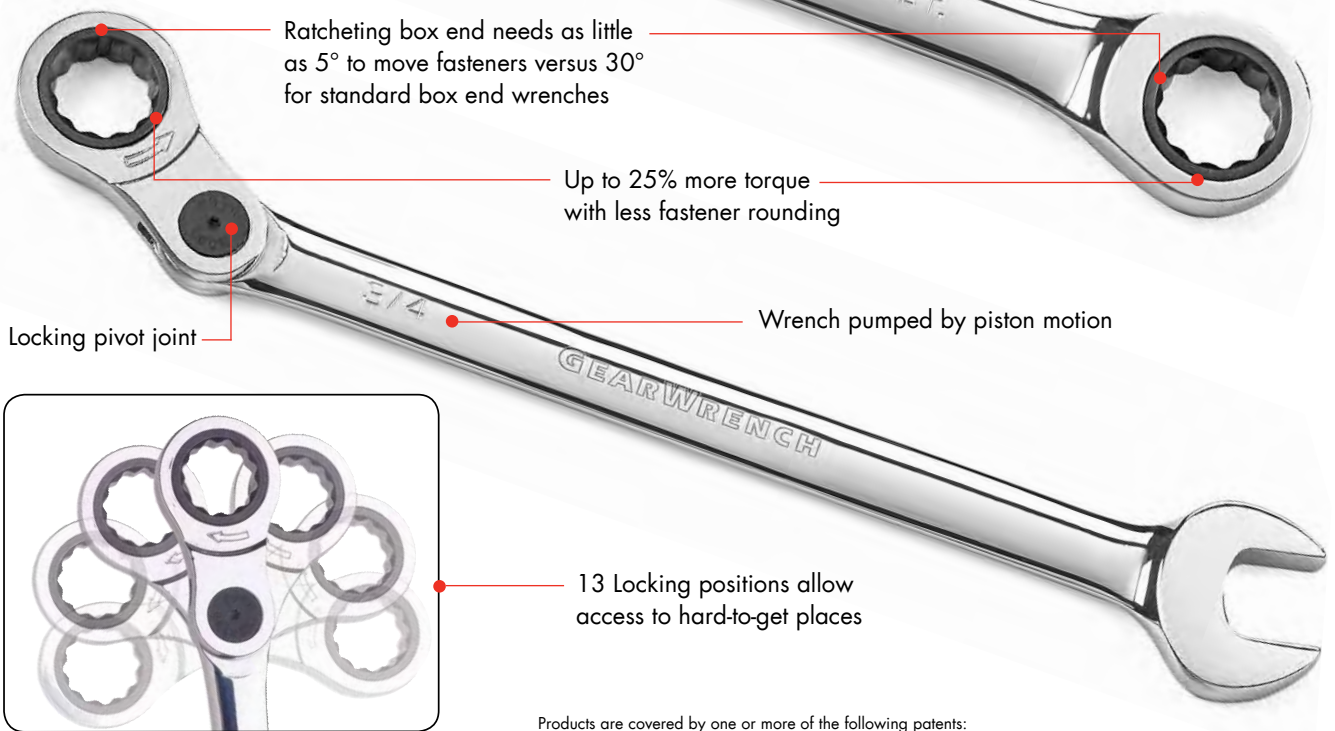

Products are covered by one or more of the following patents:
 • US 5,636,557 US 6,629,477 US 6,918,477 US 7,131,356 US 7,000,507
 US 7,165,480 US 6,868,709 US 7,231,851 US 6,840,141

WRENCHES

XL X-Beam™ *Designed to work with your Hands*



85888 - 12 Pc. XL X-Beam™ Combination Ratcheting Wrench Set METRIC

Material No.	Description
85808	8 mm XL X-Beam™ Combination Ratcheting Wrench
85809	9 mm XL X-Beam™ Combination Ratcheting Wrench
85810	10 mm XL X-Beam™ Combination Ratcheting Wrench
85811	11 mm XL X-Beam™ Combination Ratcheting Wrench
85812	12 mm XL X-Beam™ Combination Ratcheting Wrench
85813	13 mm XL X-Beam™ Combination Ratcheting Wrench
85814	14 mm XL X-Beam™ Combination Ratcheting Wrench
85815	15 mm XL X-Beam™ Combination Ratcheting Wrench
85816	16 mm XL X-Beam™ Combination Ratcheting Wrench
85817	17 mm XL X-Beam™ Combination Ratcheting Wrench
85818	18 mm XL X-Beam™ Combination Ratcheting Wrench
85819	19 mm XL X-Beam™ Combination Ratcheting Wrench



85898 - 9 Pc. XL X-Beam™ Combination Ratcheting Wrench Set SAE

Material No.	Description
85850	5/16" XL X-Beam™ Combination Ratcheting Wrench
85851	11/32" XL X-Beam™ Combination Ratcheting Wrench
85852	3/8" XL X-Beam™ Combination Ratcheting Wrench
85854	7/16" XL X-Beam™ Combination Ratcheting Wrench
85856	1/2" XL X-Beam™ Combination Ratcheting Wrench
85858	9/16" XL X-Beam™ Combination Ratcheting Wrench
85860	5/8" XL X-Beam™ Combination Ratcheting Wrench
85862	11/16" XL X-Beam™ Combination Ratcheting Wrench
85864	3/4" XL X-Beam™ Combination Ratcheting Wrench

SETS
WRENCHES

PATENTED

XL X-Beam™ *Designed to work with your Hands*

85288 - 12 Pc. XL X-Beam™ Flex Combination Ratcheting Wrench Set METRIC

Material No.	Description
85258	8 mm XL X-Beam™ Flex Combination Ratcheting Wrench
85259	9 mm XL X-Beam™ Flex Combination Ratcheting Wrench
85260	10 mm XL X-Beam™ Flex Combination Ratcheting Wrench
85261	11 mm XL X-Beam™ Flex Combination Ratcheting Wrench
85262	12 mm XL X-Beam™ Flex Combination Ratcheting Wrench
85263	13 mm XL X-Beam™ Flex Combination Ratcheting Wrench
85264	14 mm XL X-Beam™ Flex Combination Ratcheting Wrench
85265	15 mm XL X-Beam™ Flex Combination Ratcheting Wrench
85266	16 mm XL X-Beam™ Flex Combination Ratcheting Wrench
85267	17 mm XL X-Beam™ Flex Combination Ratcheting Wrench
85268	18 mm XL X-Beam™ Flex Combination Ratcheting Wrench
85269	19 mm XL X-Beam™ Flex Combination Ratcheting Wrench

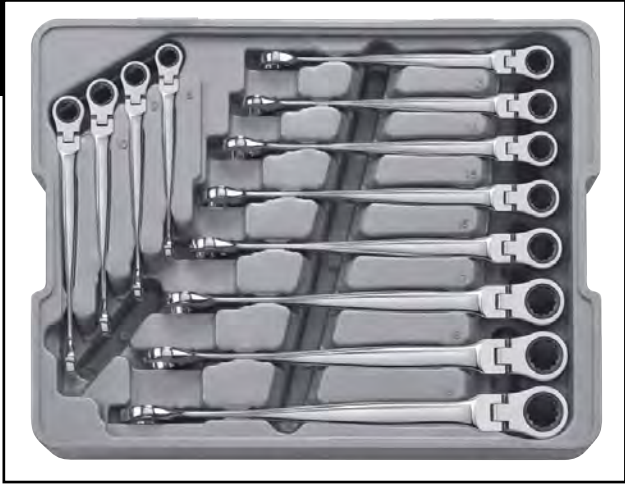

85298 - 9 Pc. XL X-Beam™ Flex Combination Ratcheting Wrench Set SAE

Material No.	Description
85270	5/16" XL X-Beam™ Flex Combination Ratcheting Wrench
85271	11/32" XL X-Beam™ Flex Combination Ratcheting Wrench
85272	3/8" XL X-Beam™ Flex Combination Ratcheting Wrench
85274	7/16" XL X-Beam™ Flex Combination Ratcheting Wrench
85276	1/2" XL X-Beam™ Flex Combination Ratcheting Wrench
85278	9/16" XL X-Beam™ Flex Combination Ratcheting Wrench
85280	5/8" XL X-Beam™ Flex Combination Ratcheting Wrench
85282	11/16" XL X-Beam™ Flex Combination Ratcheting Wrench
85284	3/4" XL X-Beam™ Flex Combination Ratcheting Wrench



SETS
WRENCHES

PATENTED

XL X-Beam™ *Designed to work with your Hands*



85388 - 12 Pc. XL X-Beam™ Reversible Combination Ratcheting Wrench Set METRIC

Material No.	Description
85308	8 mm XL X-Beam™ Reversible Combo Ratcheting Wrench
85309	9 mm XL X-Beam™ Reversible Combo Ratcheting Wrench
85310	10 mm XL X-Beam™ Reversible Combo Ratcheting Wrench
85311	11 mm XL X-Beam™ Reversible Combo Ratcheting Wrench
85312	12 mm XL X-Beam™ Reversible Combo Ratcheting Wrench
85313	13 mm XL X-Beam™ Reversible Combo Ratcheting Wrench
85314	14 mm XL X-Beam™ Reversible Combo Ratcheting Wrench
85315	15 mm XL X-Beam™ Reversible Combo Ratcheting Wrench
85316	16 mm XL X-Beam™ Reversible Combo Ratcheting Wrench
85317	17 mm XL X-Beam™ Reversible Combo Ratcheting Wrench
85318	18 mm XL X-Beam™ Reversible Combo Ratcheting Wrench
85319	19 mm XL X-Beam™ Reversible Combo Ratcheting Wrench



85398 - 9 Pc. XL X-Beam™ Reversible Combination Ratcheting Wrench Set SAE

Material No.	Description
85360	5/16" XL X-Beam™ Reversible Combo Ratcheting
85361	11/32" XL X-Beam™ Reversible Combo Ratcheting
85362	3/8" XL X-Beam™ Reversible Combo Ratcheting
85364	7/16" XL X-Beam™ Reversible Combo Ratcheting
85366	1/2" XL X-Beam™ Reversible Combo Ratcheting
85368	9/16" XL X-Beam™ Reversible Combo Ratcheting
85370	5/8" XL X-Beam™ Reversible Combo Ratcheting
85372	11/16" XL X-Beam™ Reversible Combo Ratcheting
85374	3/4" XL X-Beam™ Reversible Combo Ratcheting

SETS

WRENCHES

PATENTED

XL Combination 20 percent Longer and 25 percent Stronger

85099R - 16 Pc. XL Combination Ratcheting Wrench Set METRIC - Wrench Roll

Material No.	Description	
85008	8 mm	XL Combination Ratcheting Wrench
85009	9 mm	XL Combination Ratcheting Wrench
85010	10 mm	XL Combination Ratcheting Wrench
85011	11 mm	XL Combination Ratcheting Wrench
85012	12 mm	XL Combination Ratcheting Wrench
85013	13 mm	XL Combination Ratcheting Wrench
85014	14 mm	XL Combination Ratcheting Wrench
85015	15 mm	XL Combination Ratcheting Wrench
85016	16 mm	XL Combination Ratcheting Wrench
85017	17 mm	XL Combination Ratcheting Wrench
85018	18 mm	XL Combination Ratcheting Wrench
85019	19 mm	XL Combination Ratcheting Wrench
85020	20 mm	XL Combination Ratcheting Wrench
85021	21 mm	XL Combination Ratcheting Wrench
85022	22 mm	XL Combination Ratcheting Wrench
85024	24 mm	XL Combination Ratcheting Wrench



85199R - 13 Pc. XL Combination Ratcheting Wrench Set SAE - Wrench Roll

Item No.	Description	
85108	1/4"	XL Combination Ratcheting Wrench
85110	5/16"	XL Combination Ratcheting Wrench
85112	3/8"	XL Combination Ratcheting Wrench
85114	7/16"	XL Combination Ratcheting Wrench
85116	1/2"	XL Combination Ratcheting Wrench
85118	9/16"	XL Combination Ratcheting Wrench
85120	5/8"	XL Combination Ratcheting Wrench
85122	11/16"	XL Combination Ratcheting Wrench
85124	3/4"	XL Combination Ratcheting Wrench
85126	13/16"	XL Combination Ratcheting Wrench
85128	7/8"	XL Combination Ratcheting Wrench
85130	15/16"	XL Combination Ratcheting Wrench
85132	1"	XL Combination Ratcheting Wrench



XL Combination *20 percent Longer and 25 percent Stronger*



85098 - 12 Pc. XL Combination Ratcheting Wrench Set METRIC

Material No.	Description	
85008	8 mm	XL Combination Ratcheting Wrench
85009	9 mm	XL Combination Ratcheting Wrench
85010	10 mm	XL Combination Ratcheting Wrench
85011	11 mm	XL Combination Ratcheting Wrench
85012	12 mm	XL Combination Ratcheting Wrench
85013	13 mm	XL Combination Ratcheting Wrench
85014	14 mm	XL Combination Ratcheting Wrench
85015	15 mm	XL Combination Ratcheting Wrench
85016	16 mm	XL Combination Ratcheting Wrench
85017	17 mm	XL Combination Ratcheting Wrench
85018	18 mm	XL Combination Ratcheting Wrench
85019	19 mm	XL Combination Ratcheting Wrench



85198 - 8 Pc. XL Combination Ratcheting Wrench Set SAE

Material No.	Description	
85110	5/16"	XL Combination Ratcheting Wrench
85112	3/8"	XL Combination Ratcheting Wrench
85114	7/16"	XL Combination Ratcheting Wrench
85116	1/2"	XL Combination Ratcheting Wrench
85118	9/16"	XL Combination Ratcheting Wrench
85120	5/8"	XL Combination Ratcheting Wrench
85122	11/16"	XL Combination Ratcheting Wrench
85124	3/4"	XL Combination Ratcheting Wrench

SETS

WRENCHES

PATENTED

"Original" Ratcheting Wrench

9416 - 16 Pc. Combination Ratcheting Wrench Set METRIC

Material No.	Description
9108	8 mm Combination Ratcheting Wrench
9109	9 mm Combination Ratcheting Wrench
9110	10 mm Combination Ratcheting Wrench
9111	11 mm Combination Ratcheting Wrench
9112	12 mm Combination Ratcheting Wrench
9113	13 mm Combination Ratcheting Wrench
9114	14 mm Combination Ratcheting Wrench
9115	15 mm Combination Ratcheting Wrench
9116	16 mm Combination Ratcheting Wrench
9117	17 mm Combination Ratcheting Wrench
9118	18 mm Combination Ratcheting Wrench
9119	19 mm Combination Ratcheting Wrench
9120	20 mm Combination Ratcheting Wrench
9121	21 mm Combination Ratcheting Wrench
9122	22 mm Combination Ratcheting Wrench
9124	24 mm Combination Ratcheting Wrench



9312 - 13 Pc. Combination Ratcheting Wrench Set SAE

Material No.	Description
9008	1/4" Combination Ratcheting Wrench
9010	5/16" Combination Ratcheting Wrench
9012	3/8" Combination Ratcheting Wrench
9014	7/16" Combination Ratcheting Wrench
9016	1/2" Combination Ratcheting Wrench
9018	9/16" Combination Ratcheting Wrench
9020	5/8" Combination Ratcheting Wrench
9022	11/16" Combination Ratcheting Wrench
9024	3/4" Combination Ratcheting Wrench
9026	13/16" Combination Ratcheting Wrench
9028	7/8" Combination Ratcheting Wrench
9030	15/16" Combination Ratcheting Wrench
9032	1" Combination Ratcheting Wrench



SETS
WRENCHES

PATENTED

"Original" Ratcheting Wrench



9412 - 12 Pc. Combination Ratcheting Wrench Set METRIC

Material No.	Description
9108	8 mm Combination Ratcheting Wrench
9109	9 mm Combination Ratcheting Wrench
9110	10 mm Combination Ratcheting Wrench
9111	11 mm Combination Ratcheting Wrench
9112	12 mm Combination Ratcheting Wrench
9113	13 mm Combination Ratcheting Wrench
9114	14 mm Combination Ratcheting Wrench
9115	15 mm Combination Ratcheting Wrench
9116	16 mm Combination Ratcheting Wrench
9117	17 mm Combination Ratcheting Wrench
9118	18 mm Combination Ratcheting Wrench
9119	19 mm Combination Ratcheting Wrench



9418 - 10 Pc. Combination Ratcheting Wrench Set SAE/METRIC

Material No.	Description
9010	15/16" Combination Ratcheting Wrench
9012	3/8" Combination Ratcheting Wrench
9014	17/16" Combination Ratcheting Wrench
9016	1/2" Combination Ratcheting Wrench
9018	9/16" Combination Ratcheting Wrench
9108	8 mm Combination Ratcheting Wrench
9110	10 mm Combination Ratcheting Wrench
9112	12 mm Combination Ratcheting Wrench
9113	13 mm Combination Ratcheting Wrench
9114	14 mm Combination Ratcheting Wrench



9308D - 8 Pc. Combination Ratcheting Wrench Set SAE

Material No.	Description
9010	15/16" Combination Ratcheting Wrench
9012	3/8" Combination Ratcheting Wrench
9014	17/16" Combination Ratcheting Wrench
9016	1/2" Combination Ratcheting Wrench
9018	9/16" Combination Ratcheting Wrench
9020	5/8" Combination Ratcheting Wrench
9022	11/16" Combination Ratcheting Wrench
9024	3/4" Combination Ratcheting Wrench

PATENTED

SETS
WRENCHES

"Original" Ratcheting Wrench

9317 - 7 Pc. Combination Ratcheting Wrench Set SAE

Material No.	Description	
9010	15/16"	Combination Ratcheting Wrench
9012	3/8"	Combination Ratcheting Wrench
9014	17/16"	Combination Ratcheting Wrench
9016	1/2"	Combination Ratcheting Wrench
9018	9/16"	Combination Ratcheting Wrench
9020	5/8"	Combination Ratcheting Wrench
9024	3/4"	Combination Ratcheting Wrench

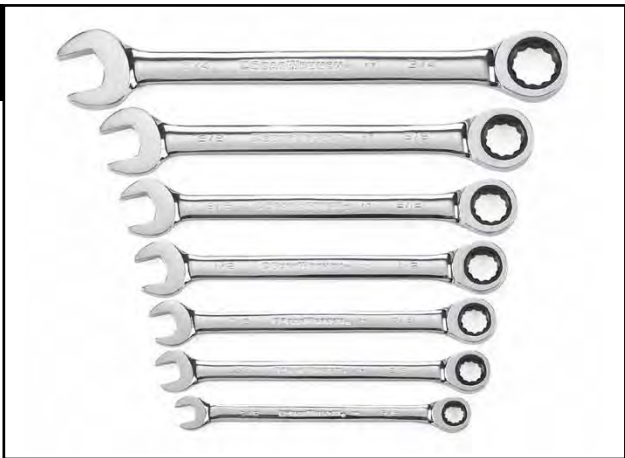

9417 - 7 Pc. Combination Ratcheting Wrench Set METRIC

Material No.	Description	
9108	8 mm	Combination Ratcheting Wrench
9110	10 mm	Combination Ratcheting Wrench
9112	12 mm	Combination Ratcheting Wrench
9113	13 mm	Combination Ratcheting Wrench
9114	14 mm	Combination Ratcheting Wrench
9115	15 mm	Combination Ratcheting Wrench
9118	18 mm	Combination Ratcheting Wrench



93005 - 5 Pc. Combination Ratcheting Wrench Set SAE

Material No.	Description	
9012	3/8"	Combination Ratcheting Wrench
9014	17/16"	Combination Ratcheting Wrench
9016	1/2"	Combination Ratcheting Wrench
9018	9/16"	Combination Ratcheting Wrench
9020	5/8"	Combination Ratcheting Wrench



93004D - 5 Pc. Combination Ratcheting Wrench Set METRIC

Material No.	Description	
9110	10 mm	Combination Ratcheting Wrench
9112	12 mm	Combination Ratcheting Wrench
9113	13 mm	Combination Ratcheting Wrench
9114	14 mm	Combination Ratcheting Wrench
9115	15 mm	Combination Ratcheting Wrench



SETS
WRENCHES

PATENTED

"Original" Ratcheting Wrench

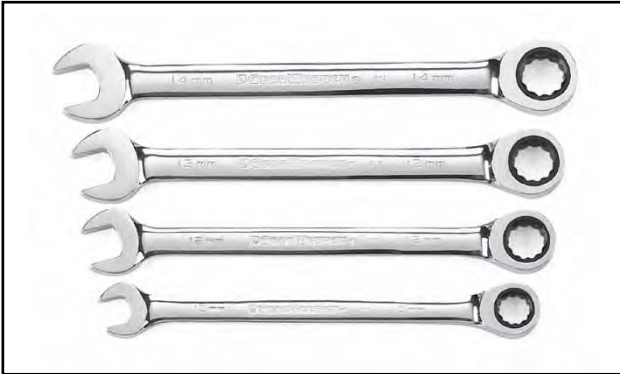

9404 - 4 Pc. Combination Ratcheting Wrench Set METRIC

Material No.	Description	
9110	10 mm	Combination Ratcheting Wrench
9112	12 mm	Combination Ratcheting Wrench
9113	13 mm	Combination Ratcheting Wrench
9114	14 mm	Combination Ratcheting Wrench

"Original" Ratcheting Wrench



Open Stock - Combination Ratcheting Wrench SAE

Material No.	Opening Inches/Metric	Overall Length (inch) A	Width Open End (inch) B	Thickness Open End (inch) C	Width Box End (inch) D	Thickness Box End (inch) E	Weight (lbs)
9008	1/4"	4.921	0.567	0.181	0.610	0.256	0.061
9010D	5/16"	5.508	0.768	0.197	0.665	0.272	0.073
9011D	11/32"	5.882	0.768	0.213	0.701	0.272	0.083
9012D	3/8"	6.256	0.862	0.224	0.780	0.303	0.119
9014	7/16"	6.508	0.953	0.252	0.854	0.323	0.145
9016D	1/2"	7.008	1.146	0.319	0.984	0.339	0.206
9018D	9/16"	7.504	1.228	0.327	1.035	0.370	0.225
9020	5/8"	8.201	1.358	0.346	1.201	0.406	0.313
9022	11/16"	8.878	1.492	0.362	1.272	0.421	0.374
9024	3/4"	9.764	1.626	0.374	1.339	0.441	0.488
9026D	13/16"	11.476	1.811	0.390	1.535	0.512	0.739
9028D	7/8"	11.476	1.811	0.390	1.535	0.512	0.768
9030	15/16"	13.114	2.055	0.429	1.791	0.571	1.081
9032	1"	13.114	2.055	0.429	1.791	0.571	1.065
9034	1-1/16"	14.142	2.220	0.571	1.929	0.610	1.329
9036	1-1/8"	15.846	2.469	0.492	2.154	0.669	1.972
9038D	1-1/4"	16.764	2.634	0.508	2.283	0.689	2.183
9060D	1-5/16"	18.110	2.744	0.539	2.362	0.689	2.640
9062D	1-3/8"	18.110	2.744	0.539	2.362	0.689	2.640
9040	1-7/16"	19.685	3.114	0.646	2.520	0.807	3.861
9042	1-1/2"	19.685	3.114	0.646	2.520	0.807	3.828
9044	1-9/16"	22.638	3.409	0.709	2.677	0.866	5.183
9046D	1-5/8"	22.638	3.409	0.709	2.677	0.866	5.141
9048	1-11/16"	24.213	3.626	0.791	2.835	0.925	5.691
9050D	1-3/4"	24.213	3.626	0.791	2.835	0.925	5.641
9052D	1-13/16"	25.394	3.850	0.835	2.992	0.984	7.647
9054D	1-7/8"	25.394	3.850	0.835	2.992	0.984	7.594
9056D	2"	25.787	4.134	0.835	3.150	1.043	8.336

OPEN STOCK
WRENCHES

"Original" Ratcheting Wrench



Open Stock - Combination Ratcheting Wrench METRIC

Material No.	Opening Inches/Metric	Overall Length (inch) A	Width Open End (inch) B	Thickness Open End (inch) C	Width Box End (inch) D	Thickness Box End (inch) E	Weight (lbs)
9106	6 mm	4.921	0.567	0.181	0.610	0.256	0.616
9107	7 mm	5.236	0.642	0.189	0.622	0.256	0.076
9108D	8 mm	5.508	0.768	0.197	0.665	0.272	0.073
9109	9 mm	5.882	0.768	0.213	0.701	0.272	0.089
9110D	10 mm	6.256	0.862	0.224	0.780	0.303	0.117
9111	11 mm	6.508	0.953	0.252	0.854	0.323	0.135
9112	12 mm	6.756	1.047	0.291	0.906	0.339	1.707
9113D	13 mm	7.008	1.146	0.319	0.984	0.339	0.193
9114D	14 mm	7.504	1.228	0.327	1.035	0.370	0.236
9115D	15 mm	7.854	1.327	0.327	1.130	0.390	0.255
9116D	16 mm	8.201	1.358	0.346	1.201	0.406	0.306
9117D	17 mm	8.878	1.492	0.362	1.272	0.421	0.376
9118D	18 mm	9.311	1.583	0.370	1.307	0.441	0.45
9119	19 mm	9.764	1.626	0.374	1.339	0.441	0.499
9120	20 mm	11.476	1.811	0.390	1.535	0.512	0.78
9121	21 mm	11.476	1.811	0.390	1.535	0.512	0.721
9122	22 mm	11.476	1.811	0.390	1.535	0.512	0.734
9124	24 mm	13.114	2.055	0.429	1.791	0.571	1.074
9125D	25 mm	13.114	2.055	0.429	1.791	0.571	1.08
9127D	27 mm	14.142	2.220	0.571	1.929	0.610	1.333
9130D	30 mm	15.846	2.469	0.492	2.154	0.669	1.849
9132	32 mm	16.764	2.634	0.508	2.283	0.689	2.102
9134D	34 mm	18.110	2.744	0.539	2.362	0.689	2.665
9136	36 mm	19.685	3.114	0.646	2.520	0.807	3.874
9141D	41 mm	22.638	3.409	0.709	2.677	0.866	5.150
9146D	46 mm	25.394	3.850	0.835	2.992	0.984	7.643
9150	50 mm	25.787	4.134	0.835	3.150	1.043	8.369

OPEN STOCK
WRENCHES

PATENTED

Stubby Ratcheting Wrench

9520D - 10 Pc. Stubby Combination Ratcheting Wrench Set METRIC

Material No.	Description
9510	10 mm Stubby Combination Ratcheting Wrench
9511	11 mm Stubby Combination Ratcheting Wrench
9512	12 mm Stubby Combination Ratcheting Wrench
9513	13 mm Stubby Combination Ratcheting Wrench
9514	14 mm Stubby Combination Ratcheting Wrench
9515	15 mm Stubby Combination Ratcheting Wrench
9516	16 mm Stubby Combination Ratcheting Wrench
9517	17 mm Stubby Combination Ratcheting Wrench
9518	18 mm Stubby Combination Ratcheting Wrench
9519	19 mm Stubby Combination Ratcheting Wrench



9507D - 7 Pc. Stubby Combination Ratcheting Wrench Set SAE

Material No.	Description
9500	3/8" Stubby Combination Ratcheting Wrench
9501	7/16" Stubby Combination Ratcheting Wrench
9502	1/2" Stubby Combination Ratcheting Wrench
9503	9/16" Stubby Combination Ratcheting Wrench
9504	5/8" Stubby Combination Ratcheting Wrench
9505	11/16" Stubby Combination Ratcheting Wrench
9506	3/4" Stubby Combination Ratcheting Wrench



SETS
WRENCHES

Reversible *Ratcheting Wrench*



9602 - 16 Pc. Reversible Combination Ratcheting Wrench Set METRIC

Material No.	Description	
9608	8 mm	Reversible Combination Ratcheting Wrench
9609	9 mm	Reversible Combination Ratcheting Wrench
9610	10 mm	Reversible Combination Ratcheting Wrench
9611	11 mm	Reversible Combination Ratcheting Wrench
9612	12 mm	Reversible Combination Ratcheting Wrench
9613	13 mm	Reversible Combination Ratcheting Wrench
9614	14 mm	Reversible Combination Ratcheting Wrench
9615	15 mm	Reversible Combination Ratcheting Wrench
9616	16 mm	Reversible Combination Ratcheting Wrench
9617	17 mm	Reversible Combination Ratcheting Wrench
9618	18 mm	Reversible Combination Ratcheting Wrench
9619	19 mm	Reversible Combination Ratcheting Wrench
9621	21 mm	Reversible Combination Ratcheting Wrench
9622	22 mm	Reversible Combination Ratcheting Wrench
9624	24 mm	Reversible Combination Ratcheting Wrench
9625	25 mm	Reversible Combination Ratcheting Wrench



9602R - 16 Pc. Reversible Combination Ratcheting Wrench Set Roll METRIC

Material No.	Description	
9608	8 mm	Reversible Combination Ratcheting Wrench
9609	9 mm	Reversible Combination Ratcheting Wrench
9610	10 mm	Reversible Combination Ratcheting Wrench
9611	11 mm	Reversible Combination Ratcheting Wrench
9612	12 mm	Reversible Combination Ratcheting Wrench
9613	13 mm	Reversible Combination Ratcheting Wrench
9614	14 mm	Reversible Combination Ratcheting Wrench
9615	15 mm	Reversible Combination Ratcheting Wrench
9616	16 mm	Reversible Combination Ratcheting Wrench
9617	17 mm	Reversible Combination Ratcheting Wrench
9618	18 mm	Reversible Combination Ratcheting Wrench
9619	19 mm	Reversible Combination Ratcheting Wrench
9621	21 mm	Reversible Combination Ratcheting Wrench
9622	22 mm	Reversible Combination Ratcheting Wrench
9624	24 mm	Reversible Combination Ratcheting Wrench
9625	25 mm	Reversible Combination Ratcheting Wrench

SETS
WRENCHES

PATENTED

Reversible Ratcheting Wrench

9509N - 13 Pc. Reversible Combination Ratcheting Wrench Set SAE

Material No.	Description
9525	5/16" Reversible Combination Ratcheting Wrench
9521	11/32" Reversible Combination Ratcheting Wrench
9526	3/8" Reversible Combination Ratcheting Wrench
9527	7/16" Reversible Combination Ratcheting Wrench
9528	1/2" Reversible Combination Ratcheting Wrench
9529	9/16" Reversible Combination Ratcheting Wrench
9530	5/8" Reversible Combination Ratcheting Wrench
9531	11/16" Reversible Combination Ratcheting Wrench
9532	3/4" Reversible Combination Ratcheting Wrench
9534	13/16" Reversible Combination Ratcheting Wrench
9538	7/8" Reversible Combination Ratcheting Wrench
9539	15/16" Reversible Combination Ratcheting Wrench
9540	1" Reversible Combination Ratcheting Wrench



9509R - 13 Pc. Reversible Combination Ratcheting Wrench Set Roll SAE

Material No.	Description
9525	5/16" Reversible Combination Ratcheting Wrench
9521	11/32" Reversible Combination Ratcheting Wrench
9526	3/8" Reversible Combination Ratcheting Wrench
9527	7/16" Reversible Combination Ratcheting Wrench
9528	1/2" Reversible Combination Ratcheting Wrench
9529	9/16" Reversible Combination Ratcheting Wrench
9530	5/8" Reversible Combination Ratcheting Wrench
9531	11/16" Reversible Combination Ratcheting Wrench
9532	3/4" Reversible Combination Ratcheting Wrench
9534	13/16" Reversible Combination Ratcheting Wrench
9538	7/8" Reversible Combination Ratcheting Wrench
9539	15/16" Reversible Combination Ratcheting Wrench
9540	1" Reversible Combination Ratcheting Wrench



SETS
WRENCHES

PATENTED

Reversible *Ratcheting Wrench*



9620D - 12 Pc. Reversible Combination Ratcheting Wrench Set METRIC

Material No.	Description	
9608	8 mm	Reversible Combination Ratcheting Wrench
9609	9 mm	Reversible Combination Ratcheting Wrench
9610	10 mm	Reversible Combination Ratcheting Wrench
9611	11 mm	Reversible Combination Ratcheting Wrench
9612	12 mm	Reversible Combination Ratcheting Wrench
9613	13 mm	Reversible Combination Ratcheting Wrench
9614	14 mm	Reversible Combination Ratcheting Wrench
9615	15 mm	Reversible Combination Ratcheting Wrench
9616	16 mm	Reversible Combination Ratcheting Wrench
9617	17 mm	Reversible Combination Ratcheting Wrench
9618	18 mm	Reversible Combination Ratcheting Wrench
9619	19 mm	Reversible Combination Ratcheting Wrench



9533DD - 8 Pc. Reversible Combination Ratcheting Wrench Set SAE

Material No.	Description	
9525	5/16"	Reversible Combination Ratcheting Wrench
9526	3/8"	Reversible Combination Ratcheting Wrench
9527	7/16"	Reversible Combination Ratcheting Wrench
9528	1/2"	Reversible Combination Ratcheting Wrench
9529	9/16"	Reversible Combination Ratcheting Wrench
9530	5/8"	Reversible Combination Ratcheting Wrench
9531	11/16"	Reversible Combination Ratcheting Wrench
9532	3/4"	Reversible Combination Ratcheting Wrench



9543 - 8 Pc. Reversible Combination Ratcheting Wrench Set METRIC

Material No.	Description	
9608	8 mm	Reversible Combination Ratcheting Wrench
9610	10 mm	Reversible Combination Ratcheting Wrench
9612	12 mm	Reversible Combination Ratcheting Wrench
9613	13 mm	Reversible Combination Ratcheting Wrench
9614	14 mm	Reversible Combination Ratcheting Wrench
9615	15 mm	Reversible Combination Ratcheting Wrench
9617	17 mm	Reversible Combination Ratcheting Wrench
9619	19 mm	Reversible Combination Ratcheting Wrench

SETS
WRENCHES

Reversible Ratcheting Wrench



Open Stock - Combination Ratcheting Wrench SAE/METRIC

Material No.	Opening Inches/Metric	Overall Length (inch) A	Width Open End (inch) B	Thickness Open End (inch) C	Width Box End (inch) D	Thickness Box End (inch) E	Weight (lbs)
9525D	5/16"	5.433	0.768	0.197	0.665	0.272	0.08
9521D	11/32"	5.795	0.768	0.213	0.701	0.272	0.901
9526	3/8"	6.169	0.862	0.224	0.780	0.303	0.137
9527	7/16"	6.413	0.953	0.252	0.854	0.323	0.156
9528	1/2"	6.902	1.146	0.319	0.984	0.339	0.207
9529	9/16"	7.398	1.228	0.327	1.035	0.370	0.242
9530	5/8"	8.087	1.358	0.346	1.201	0.406	0.344
9531DD	11/16"	8.740	1.492	0.362	1.272	0.421	0.399
9532D	3/4"	9.594	1.626	0.374	1.339	0.441	0.536
9534D	13/16"	11.476	1.811	0.390	1.535	0.512	0.785
9538	7/8"	11.476	1.811	0.390	1.535	0.512	0.76
9539	15/16"	14.000	2.055	0.429	1.791	0.571	1.174
9540	1"	14.000	2.055	0.429	1.791	0.571	1.317
9608	8 mm	5.433	0.768	0.197	0.665	0.272	0.073
9609D	9 mm	5.795	0.768	0.213	0.701	0.272	0.09
9610D	10 mm	6.169	0.862	0.224	0.780	0.303	0.115
9611	11 mm	6.413	0.953	0.252	0.854	0.323	0.16
9612D	12 mm	6.657	1.047	0.291	0.906	0.339	0.166
9613D	13 mm	6.902	1.146	0.319	0.984	0.339	0.193
9614D	14 mm	7.398	1.228	0.327	1.035	0.370	0.244
9615D	15 mm	7.748	1.327	0.327	1.130	0.390	0.281
9616D	16 mm	8.087	1.358	0.346	1.201	0.406	0.35
9617	17 mm	8.740	1.492	0.362	1.272	0.421	0.401
9618D	18 mm	9.169	1.583	0.370	1.307	0.441	0.461
9619	19 mm	9.594	1.626	0.374	1.339	0.441	0.536
9621D	21 mm	11.476	1.811	0.390	1.535	0.512	0.785
9622	22 mm	11.476	1.811	0.390	1.535	0.512	0.76
9624D	24 mm	14.000	2.055	0.429	1.791	0.571	1.174
9625	25 mm	14.000	2.055	0.429	1.791	0.571	1.15

OPEN STOCK
WRENCHES

XL Locking Flex *Ratcheting* Wrench



85698 - 12 Pc. XL Locking Flex Combination Ratcheting Wrench Set *METRIC*

Material No.	Description
85608	8 mm XL Locking Flex Combination Ratcheting Wrench
85609	9 mm XL Locking Flex Combination Ratcheting Wrench
85610	10 mm XL Locking Flex Combination Ratcheting Wrench
85611	11 mm XL Locking Flex Combination Ratcheting Wrench
85612	12 mm XL Locking Flex Combination Ratcheting Wrench
85613	13 mm XL Locking Flex Combination Ratcheting Wrench
85614	14 mm XL Locking Flex Combination Ratcheting Wrench
85615	15 mm XL Locking Flex Combination Ratcheting Wrench
85616	16 mm XL Locking Flex Combination Ratcheting Wrench
85617	17 mm XL Locking Flex Combination Ratcheting Wrench
85618	18 mm XL Locking Flex Combination Ratcheting Wrench
85619	19 mm XL Locking Flex Combination Ratcheting Wrench



85698R - 12 Pc. XL Locking Flex Combination Ratcheting Wrench Set Roll *METRIC*



85798 - 8 Pc. XL Locking Flex Combination Ratcheting Wrench Set *SAE*

Material No.	Description
85710	5/16" XL Locking Flex Combination Ratcheting Wrench
85712	3/8" XL Locking Flex Combination Ratcheting Wrench
85714	7/16" XL Locking Flex Combination Ratcheting Wrench
85716	1/2" XL Locking Flex Combination Ratcheting Wrench
85718	9/16" XL Locking Flex Combination Ratcheting Wrench
85720	5/8" XL Locking Flex Combination Ratcheting Wrench
85722	11/16" XL Locking Flex Combination Ratcheting Wrench
85724	3/4" XL Locking Flex Combination Ratcheting Wrench



85798R - 8 Pc. XL Locking Flex Combination Ratcheting Wrench Set Roll *SAE*

SETS
WRENCHES

PATENTED

Flex Ratcheting Wrench

9901D - 12 Pc. Flex Combination Ratcheting Wrench Set METRIC

Material No.	Description	
9908	8 mm	Flex Combination Ratcheting Wrench
9909	9 mm	Flex Combination Ratcheting Wrench
9910	10 mm	Flex Combination Ratcheting Wrench
9911	11 mm	Flex Combination Ratcheting Wrench
9912	12 mm	Flex Combination Ratcheting Wrench
9913	13 mm	Flex Combination Ratcheting Wrench
9914	14 mm	Flex Combination Ratcheting Wrench
9915	15 mm	Flex Combination Ratcheting Wrench
9916	16 mm	Flex Combination Ratcheting Wrench
9917	17 mm	Flex Combination Ratcheting Wrench
9918	18 mm	Flex Combination Ratcheting Wrench
9919	19 mm	Flex Combination Ratcheting Wrench



9701 - 8 Pc. Flex Combination Ratcheting Wrench Set SAE

Material No.	Description	
9705	5/16"	Flex Combination Ratcheting Wrench
9706	3/8"	Flex Combination Ratcheting Wrench
9707	7/16"	Flex Combination Ratcheting Wrench
9708	1/2"	Flex Combination Ratcheting Wrench
9709	9/16"	Flex Combination Ratcheting Wrench
9710	5/8"	Flex Combination Ratcheting Wrench
9711	11/16"	Flex Combination Ratcheting Wrench
9712	3/4"	Flex Combination Ratcheting Wrench



9700 - 7 Pc. Flex Combination Ratcheting Wrench Set SAE

Material No.	Description	
9706	3/8"	Flex Combination Ratcheting Wrench
9707	7/16"	Flex Combination Ratcheting Wrench
9708	1/2"	Flex Combination Ratcheting Wrench
9709	9/16"	Flex Combination Ratcheting Wrench
9710	5/8"	Flex Combination Ratcheting Wrench
9711	11/16"	Flex Combination Ratcheting Wrench
9712	3/4"	Flex Combination Ratcheting Wrench



SETS
WRENCHES

PATENTED

Flex Ratcheting Wrench



9900D - 7 Pc. Flex Combination Ratcheting Wrench Set METRIC

Material No.	Description	
9910	10 mm	Flex Combination Ratcheting Wrench
9912	12 mm	Flex Combination Ratcheting Wrench
9913	13 mm	Flex Combination Ratcheting Wrench
9914	14 mm	Flex Combination Ratcheting Wrench
9915	15 mm	Flex Combination Ratcheting Wrench
9917	17 mm	Flex Combination Ratcheting Wrench
9919	19 mm	Flex Combination Ratcheting Wrench

PATENTED

Flex Ratcheting Wrench



Open Stock - Flex Combination Ratcheting Wrench SAE/METRIC

Material No.	Opening Inches/Metric	Overall Length (inch) A	Width Open End (inch) B	Thickness Open End (inch) C	Width Box End (inch) D	Thickness Box End (inch) E	Weight (lbs)
9704D	11/32"	5.882	0.768	0.213	0.701	0.272	0.11
9705	5/16"	5.508	0.768	0.197	0.665	0.272	0.087
9706	3/8"	6.252	0.862	0.224	0.780	0.303	0.138
9707	7/16"	6.504	0.953	0.252	0.854	0.323	0.168
9708	1/2"	7.004	1.146	0.319	0.984	0.339	0.238
9709	9/16"	7.504	1.228	0.327	1.035	0.370	0.282
9710	5/8"	8.197	1.358	0.346	1.201	0.406	0.383
9711	11/16"	8.878	1.492	0.362	1.272	0.421	0.448
9712	3/4"	9.764	1.626	0.374	1.339	0.441	0.588
9713	13/16"	11.476	1.811	0.390	1.535	0.512	0.9
9714D	7/8"	11.476	1.811	0.390	1.535	0.512	0.864
9715D	15/16"	13.114	2.055	0.429	1.791	0.571	1.316
9716D	1"	13.114	2.055	0.429	1.791	0.571	1.292
9908D	8 mm	5.508	0.768	0.197	0.665	0.272	0.086
9909D	9 mm	5.882	0.768	0.213	0.701	0.272	0.103
9910D	10 mm	6.252	0.862	0.224	0.780	0.303	0.138
9911D	11 mm	6.504	0.953	0.252	0.854	0.323	0.162
9912D	12 mm	6.756	1.047	0.291	0.906	0.339	0.197
9913D	13 mm	7.004	1.146	0.319	0.984	0.339	0.238
9914D	14 mm	7.504	1.228	0.327	1.035	0.370	0.279
9915D	15 mm	7.854	1.327	0.327	1.130	0.390	0.334
9916D	16 mm	8.197	1.358	0.346	1.201	0.406	0.383
9917	17 mm	8.878	1.492	0.362	1.272	0.421	0.451
9918	18 mm	9.315	1.583	0.370	1.307	0.441	0.517
9919D	19 mm	9.764	1.626	0.374	1.339	0.441	0.59
9921D	21 mm	11.476	1.811	0.390	1.535	0.512	0.886
9922D	22 mm	11.476	1.811	0.390	1.535	0.512	0.868
9924D	24 mm	13.114	2.055	0.429	1.791	0.571	1.31
9925D	25 mm	14.000	2.055	0.429	1.791	0.571	1.15

OPEN STOCK
WRENCHES

Stubby Flex *Ratcheting Wrench*



9550 - 10 Pc. Stubby Flex Combination Ratcheting Wrench Set METRIC

Material No.	Description	
9551	10 mm	Stubby Flex Combination Ratcheting Wrench
9552	11 mm	Stubby Flex Combination Ratcheting Wrench
9553	12 mm	Stubby Flex Combination Ratcheting Wrench
9554	13 mm	Stubby Flex Combination Ratcheting Wrench
9555	14 mm	Stubby Flex Combination Ratcheting Wrench
9556	15 mm	Stubby Flex Combination Ratcheting Wrench
9557	16 mm	Stubby Flex Combination Ratcheting Wrench
9558	17 mm	Stubby Flex Combination Ratcheting Wrench
9559	18 mm	Stubby Flex Combination Ratcheting Wrench
9560	19 mm	Stubby Flex Combination Ratcheting Wrench

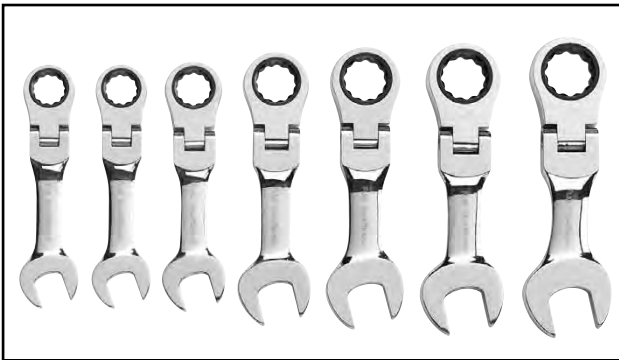

9570 - 7 Pc. Stubby Flex Combination Ratcheting Wrench Set SAE

Material No.	Description	
9571	3/8"	Stubby Flex Combination Ratcheting Wrench
9572	7/16"	Stubby Flex Combination Ratcheting Wrench
9573	1/2"	Stubby Flex Combination Ratcheting Wrench
9574	9/16"	Stubby Flex Combination Ratcheting Wrench
9575	5/8"	Stubby Flex Combination Ratcheting Wrench
9576	11/16"	Stubby Flex Combination Ratcheting Wrench
9577	3/4"	Stubby Flex Combination Ratcheting Wrench

SETS
WRENCHES

PATENTED

XL GearBox™ Ratcheting Wrenches

85988 - 12 Pc. XL GearBox™ Double Box Ratcheting Wrench Set METRIC

Material No.	Description
85908	8 mm XL GearBox™ Double Box Ratcheting Wrench
85909	9 mm XL GearBox™ Double Box Ratcheting Wrench
85910	10 mm XL GearBox™ Double Box Ratcheting Wrench
85911	11 mm XL GearBox™ Double Box Ratcheting Wrench
85912	12 mm XL GearBox™ Double Box Ratcheting Wrench
85913	13 mm XL GearBox™ Double Box Ratcheting Wrench
85914	14 mm XL GearBox™ Double Box Ratcheting Wrench
85915	15 mm XL GearBox™ Double Box Ratcheting Wrench
85916	16 mm XL GearBox™ Double Box Ratcheting Wrench



85917	17 mm	XL GearBox™ Double Box Ratcheting Wrench
85918	18 mm	XL GearBox™ Double Box Ratcheting Wrench
85919	19 mm	XL GearBox™ Double Box Ratcheting Wrench

85987 - 5 Pc. XL GearBox™ Double Box Ratcheting Wrench Add-On Set METRIC

Material No.	Description
85920	20 mm XL GearBox™ Ratcheting Wrench
85921	21 mm XL GearBox™ Ratcheting Wrench
85922	22 mm XL GearBox™ Ratcheting Wrench
85924	24 mm XL GearBox™ Ratcheting Wrench
85925	25 mm XL GearBox™ Ratcheting Wrench



ADD-ON SET (Complement to 85988)

85998 - 9 Pc. XL GearBox™ Double Box Ratcheting Wrench Set SAE

Material No.	Description
85950	5/16" XL GearBox™ Double Box Ratcheting Wrench
85951	11/32" XL GearBox™ Double Box Ratcheting Wrench
85952	3/8" XL GearBox™ Double Box Ratcheting Wrench
85954	7/16" XL GearBox™ Double Box Ratcheting Wrench
85956	1/2" XL GearBox™ Double Box Ratcheting Wrench
85958	9/16" XL GearBox™ Double Box Ratcheting Wrench
85960	5/8" XL GearBox™ Double Box Ratcheting Wrench
85962	11/16" XL GearBox™ Double Box Ratcheting Wrench
85964	3/4" XL GearBox™ Double Box Ratcheting Wrench



SETS
WRENCHES

XL GearBox™ Ratcheting Wrenches



ADD-ON SET (Complement to 85998)

85996 - 4 Pc. XL GearBox™ Double Box Ratcheting Wrench Add-On Set SAE

Material No.	Description	
85966	13/16"	XL GearBox™ Ratcheting Wrench
85968	7/8"	XL GearBox™ Ratcheting Wrench
85970	15/16"	XL GearBox™ Ratcheting Wrench
85972	1"	XL GearBox™ Ratcheting Wrench

XL Spline Ratcheting Wrenches



85598 - 9 Pc. XL Spline Combination Ratcheting Wrench Set SAE

Material No.	Description	
85548	#8 x 1/4"	XL Spline Combination Ratcheting Wrench
85550	#10 x 5/16"	XL Spline Combination Ratcheting Wrench
85552	#12 x 3/8"	XL Spline Combination Ratcheting Wrench
85554	#14 x 7/16"	XL Spline Combination Ratcheting Wrench
85556	#16 x 1/2"	XL Spline Combination Ratcheting Wrench
85558	#18 x 9/16"	XL Spline Combination Ratcheting Wrench
85560	#20 x 5/8"	XL Spline Combination Ratcheting Wrench
85562	#22 x 11/16"	XL Spline Combination Ratcheting Wrench
85564	#24 x 3/4"	XL Spline Combination Ratcheting Wrench

SETS
WRENCHES

PATENTED

Indexing Ratcheting Wrenches

85488 - 12 Pc. Indexing Combination Wrench Set METRIC

Material No.	Description
85418	8 mm Indexing Combination Wrench
85439	9 mm Indexing Combination Wrench
85440	10 mm Indexing Combination Wrench
85441	11 mm Indexing Combination Wrench
85442	12 mm Indexing Combination Wrench
85443	13 mm Indexing Combination Wrench
85444	14 mm Indexing Combination Wrench
85445	15 mm Indexing Combination Wrench
85446	16 mm Indexing Combination Wrench
85447	17 mm Indexing Combination Wrench
85448	18 mm Indexing Combination Wrench
85449	19 mm Indexing Combination Wrench

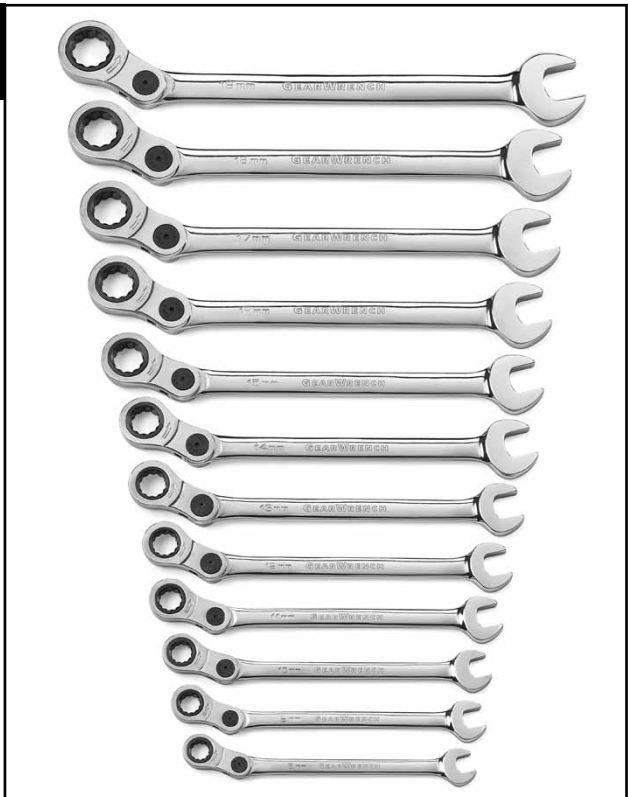

85498 - 8 Pc. Indexing Combination Wrench Set SAE

Material No.	Description
85450	5/16" Indexing Combination Wrench
85452	3/8" Indexing Combination Wrench
85454	7/16" Indexing Combination Wrench
85456	1/2" Indexing Combination Wrench
85458	9/16" Indexing Combination Wrench
85460	5/8" Indexing Combination Wrench
85462	11/16" Indexing Combination Wrench
85464	3/4" Indexing Combination Wrench



SETS
WRENCHES

PATENTED

Open End *Ratcheting Wrenches*



85597 - 12 Pc. Open End Ratcheting Set METRIC

Material No.	Description
85508	8 mm Ratcheting Open End Wrench
85509	9 mm Ratcheting Open End Wrench
85510	10 mm Ratcheting Open End Wrench
85511	11 mm Ratcheting Open End Wrench
85512	12 mm Ratcheting Open End Wrench
85513	13 mm Ratcheting Open End Wrench
85514	14 mm Ratcheting Open End Wrench
85515	15 mm Ratcheting Open End Wrench
85516	16 mm Ratcheting Open End Wrench
85517	17 mm Ratcheting Open End Wrench
85518	18 mm Ratcheting Open End Wrench
85519	19 mm Ratcheting Open End Wrench



85599 - 8 Pc. Open End Ratcheting Set SAE

Material No.	Description
85570	5/16" Ratcheting Open End Wrench
85572	3/8" Ratcheting Open End Wrench
85574	7/16" Ratcheting Open End Wrench
85576	1/2" Ratcheting Open End Wrench
85578	9/16" Ratcheting Open End Wrench
85580	5/8" Ratcheting Open End Wrench
85582	11/16" Ratcheting Open End Wrench
85584	3/4" Ratcheting Open End Wrench

SETS

WRENCHES

PATENTED

Open End *Ratcheting* Wrenches

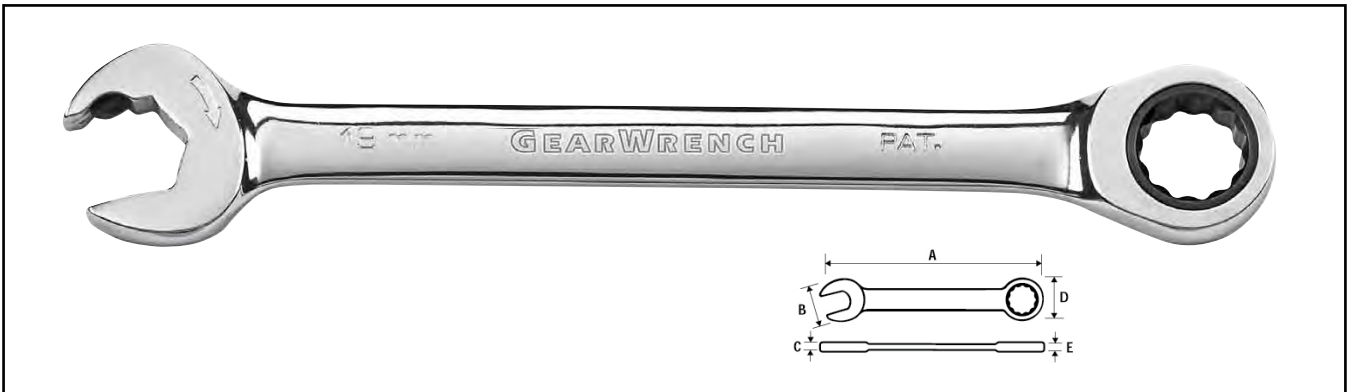

Open Stock - Open End Ratcheting Wrenches *SAE/METRIC*

Material No.	Opening Inches/Metric	Overall Length (inch) A	Width Open End (inch) B	Thickness Open End (inch) C	Width Box End (inch) D	Thickness Box End (inch) E	Weight (lbs)
85570	5/16"	5.508	0.658	0.197	0.625	0.256	0.046
85572	3/8"	6.256	0.822	0.220	0.750	0.287	0.062
85574	7/16"	6.508	0.905	0.240	0.811	0.303	0.071
85576	1/2"	7.008	1.069	0.303	0.930	0.339	0.093
85578	9/16"	7.504	1.152	0.307	1.020	0.354	0.121
85580	5/8"	8.201	1.316	0.346	1.130	0.390	0.143
85582	11/16"	8.878	1.399	0.370	1.201	0.406	0.196
85584	3/4"	9.764	1.563	0.386	1.278	0.441	0.273
85508	8 mm	5.508	0.658	0.197	0.625	0.256	0.064
85509	9 mm	5.882	0.741	0.209	0.689	0.272	0.090
85510	10 mm	6.256	0.822	0.220	0.750	0.287	0.123
85511	11 mm	6.508	0.905	0.240	0.811	0.303	0.141
85512D	12 mm	6.756	0.988	0.260	0.855	0.323	0.176
85513	13 mm	7.008	1.069	0.303	0.930	0.339	0.185
85514D	14 mm	7.504	1.152	0.307	1.020	0.354	0.236
85515	15 mm	7.854	1.233	0.315	1.070	0.370	0.287
85516	16 mm	8.201	1.316	0.346	1.130	0.390	0.340
85517	17 mm	8.878	1.399	0.370	1.201	0.406	0.414
85518	18 mm	9.315	1.480	0.370	1.239	0.421	0.428
85519	19 mm	9.764	1.563	0.386	1.278	0.441	0.708

OPEN STOCK
WRENCHES

PATENTED

QuadBox™ Ratcheting Wrenches



85204 - 3 Pc. QuadBox™ Double Box Ratcheting Wrench Set SAE

Material No. Description

85201	5/16", 3/8", 7/16", 1/2"	QuadBox™ Ratcheting Wrench
85202	9/16", 5/8", 11/16", 3/4"	QuadBox™ Ratcheting Wrench
85203	13/16", 7/8", 15/16", 1"	QuadBox™ Ratcheting Wrench



85215 - 4 Pc. QuadBox™ Double Box Ratcheting Wrench Set METRIC

Material No. Description

85211	8, 10, 12, 13 mm	QuadBox™ Ratcheting Wrench
85212	16, 17, 18, 19 mm	QuadBox™ Ratcheting Wrench
85213	9, 11, 14, 15 mm	QuadBox™ Ratcheting Wrench
85214	20, 21, 22, 24 mm	QuadBox™ Ratcheting Wrench

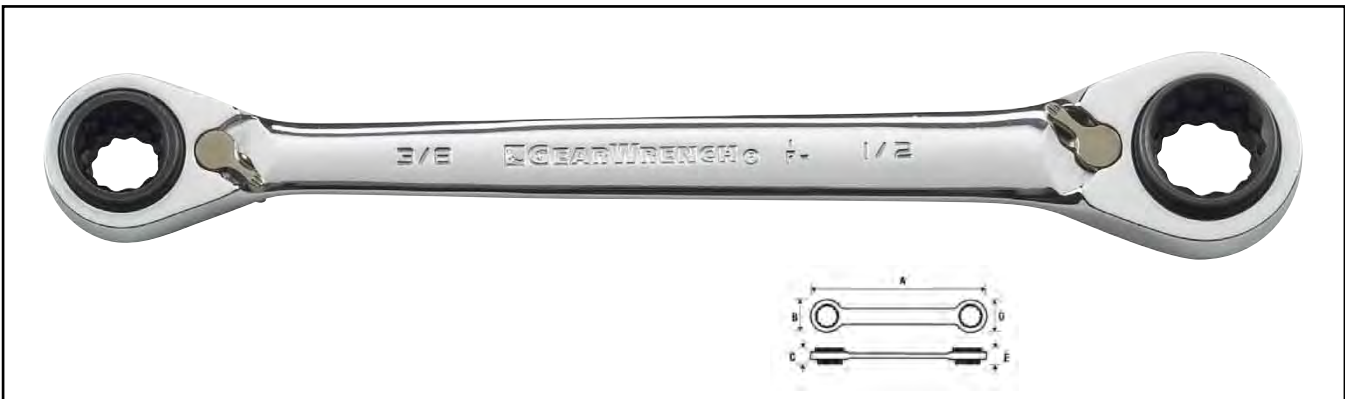

Open Stock - QuadBox™ Ratcheting Wrench SAE/METRIC

Material No.	Opening Inches/Metric	Overall Length (inch) A	Width Box End (inch) B	Thickness Box End (inch) C	Width Box End (inch) D	Thickness Box End (inch) E	Weight (lbs)
85201	5/16", 3/8", 7/16", 1/2"	6.3	0.78	0.47	0.98	0.59	0.185
85202D	9/16", 5/8", 11/16", 3/4"	8.27	1.2	0.67	1.34	0.75	0.449
85203	13/16", 7/8", 15/16", 1"	11.42	1.54	0.91	1.79	1.1	1.10
85211	8, 10, 12, 13 mm	6.3	0.78	0.47	0.98	0.59	0.189
85212	16, 17, 18, 19 mm	9.06	1.27	0.71	1.34	0.79	0.491
85213	9, 11, 14, 15 mm	7.09	0.85	0.51	1.13	0.63	0.253
85214	20, 21, 22, 24 mm	11.42	1.54	0.91	1.79	1.1	1.056

PATENTED

SETS

WRENCHES

QuadBox™ Reversible Ratcheting Wrenches

95551 - 13 Pc. QuadBox™ Reversible Ratcheting Wrench Set SAE

Material No.	Description
85201	5/16", 3/8", 7/16", 1/2" QuadBox™ Reversible Ratcheting Wrench
85202	9/16", 5/8", 11/16", 3/4" QuadBox™ Reversible Ratcheting Wrench
	1/4" Access Bit Adapter
#1	Phillips Bit 1/4"
#2	Phillips Bit 1/4"
#3	Phillips Bit 1/4"
5/32	Slotted Bit 1/4"
7/32	Slotted Bit 1/4"
1/4	Slotted Bit 1/4"
T-15	Torx® Bit 1/4"
T-20	Torx® Bit 1/4"
T-25	Torx® Bit 1/4"
T-27	Torx® Bit 1/4"



95552 - 13 Pc. QuadBox™ Reversible Ratcheting Wrench Set METRIC

Material No.	Description
85211	8, 10, 12, 13 mm QuadBox™ Reversible Ratcheting Wrench
85212	16, 17, 18, 19 mm QuadBox™ Reversible Ratcheting Wrench
	1/4" Access Bit Adapter
#1	Phillips Bit 1/4"
#2	Phillips Bit 1/4"
#3	Phillips Bit 1/4"
5/32	Slotted Bit 1/4"
7/32	Slotted Bit 1/4"
1/4	Slotted Bit 1/4"
T-15	Torx® Bit 1/4"
T-20	Torx® Bit 1/4"
T-25	Torx® Bit 1/4"
T-27	Torx® Bit 1/4"



SETS
WRENCHES

PATENTED

Double Box Ratcheting Wrenches



9260 - 6 Pc. Double Box Ratcheting Wrench Set METRIC

Material No.	Description
9210	8 X 9 mm Double Box Ratcheting Wrench
9211	10 X 11 mm Double Box Ratcheting Wrench
9212	12 X 13 mm Double Box Ratcheting Wrench
9213	14 X 15 mm Double Box Ratcheting Wrench
9214	16 X 18 mm Double Box Ratcheting Wrench
9215	17 X 19 mm Double Box Ratcheting Wrench



9240D - 4 Pc. Double Box Ratcheting Wrench Set SAE

Material No.	Description
9201	5/16" x 3/8" Double Box Ratcheting Wrench
9202	7/16" x 1/2" Double Box Ratcheting Wrench
9203	9/16" x 5/8" Double Box Ratcheting Wrench
9204	11/16" x 3/4" Double Box Ratcheting Wrench

Half Moon Ratcheting Wrenches



9850 - 5 Pc. Half Moon Reversible Double Box Ratcheting Wrench Set METRIC

Material No.	Description
9851	10 x 12 mm Half Moon Ratcheting Wrench
9852	11 x 13 mm Half Moon Ratcheting Wrench
9853	14 x 16 mm Half Moon Ratcheting Wrench
9854	15 x 17 mm Half Moon Ratcheting Wrench
9855	19 x 22 mm Half Moon Ratcheting Wrench



9840D - 4 Pc. Half Moon Reversible Double Box Ratcheting Wrench Set SAE

Material No.	Description
9841	3/8" x 7/16" Half Moon Ratcheting Wrench
9842	1/2" x 9/16" Half Moon Ratcheting Wrench
9843	5/8" x 11/16" Half Moon Ratcheting Wrench
9844	3/4" x 7/8" Half Moon Ratcheting Wrench

PATENTED

SETS

WRENCHES

S-Shape Ratcheting Wrenches

85299 - 5 Pc. S-Shape Reversible Double Box Ratcheting Wrench Set METRIC

Material No.	Description
85222	10 x 12 mm S-Shape Ratcheting Wrench
85224	11 x 13 mm S-Shape Ratcheting Wrench
85230	14 x 16 mm S-Shape Ratcheting Wrench
85232	15 x 17 mm S-Shape Ratcheting Wrench
85241	19 x 22 mm S-Shape Ratcheting Wrench



85399 - 4 Pc. S-Shape Reversible Double Box Ratcheting Wrench Set SAE

Material No.	Description
85326	3/8" x 7/16" S-Shape Ratcheting Wrench
85334	1/2" x 9/16" S-Shape Ratcheting Wrench
85342	5/8" x 11/16" S-Shape Ratcheting Wrench
85352	3/4" x 7/8" S-Shape Ratcheting Wrench



E-Torx® Ratcheting Wrenches

9224D - 4 Pc. E-Torx® Double Box Ratcheting Wrench Set TORX®

Material No.	Description
9220	E6 x E8 E-Torx Ratcheting Wrench
9221	E10 x E12 E-Torx Ratcheting Wrench
9222	E14 x E18 E-Torx Ratcheting Wrench
9223	E20 x E24 E-Torx Ratcheting Wrench

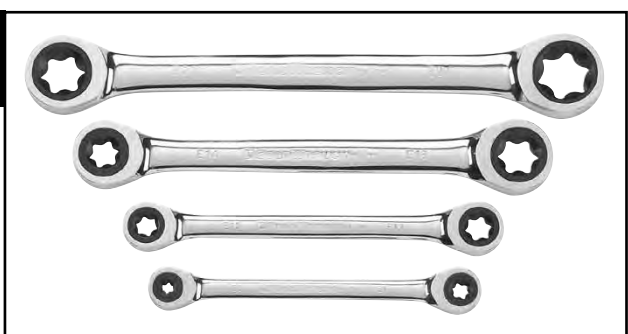

SETS
WRENCHES

PATENTED

**NON-RATCHETING
WRENCHES**

AVAILABLE IN:

- 6 Point
- 12 Point

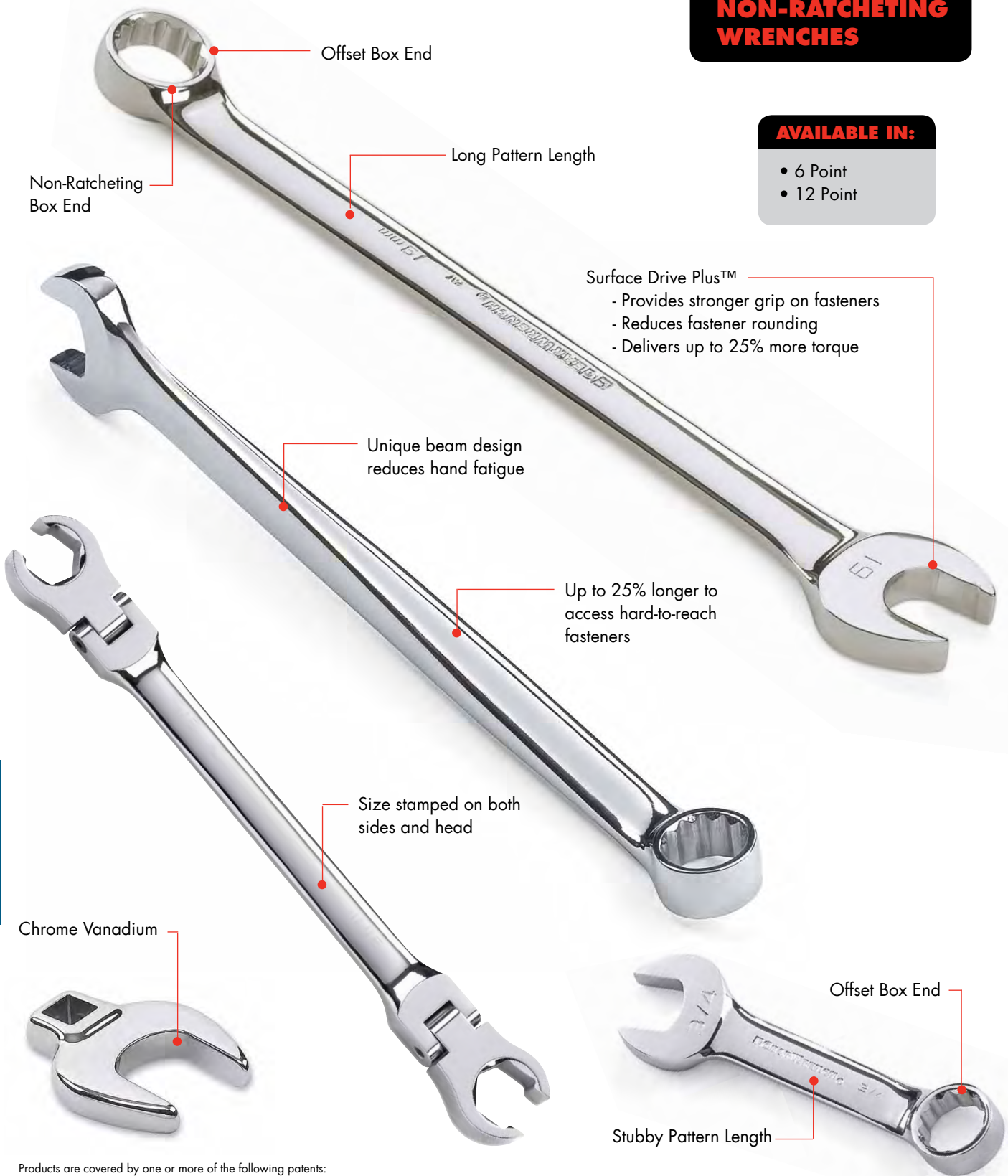

Offset Box End

Non-Ratcheting Box End

Long Pattern Length

Surface Drive Plus™

- Provides stronger grip on fasteners
- Reduces fastener rounding
- Delivers up to 25% more torque

Unique beam design reduces hand fatigue

Up to 25% longer to access hard-to-reach fasteners

Size stamped on both sides and head

Chrome Vanadium

Offset Box End

Stubby Pattern Length

Products are covered by one or more of the following patents:

- US 6,263,769 US 6,267,028 US 6,082,228 D412819 D437536

81912 - 12 Pc. XL X-Beam™ Combination Non-Ratcheting Wrench Set METRIC

Material No.	Description	
81698	8 mm	XL X-Beam™ Combination Wrench
81699	9 mm	XL X-Beam™ Combination Wrench
81700	10 mm	XL X-Beam™ Combination Wrench
81701	11 mm	XL X-Beam™ Combination Wrench
81703	12 mm	XL X-Beam™ Combination Wrench
81705	13 mm	XL X-Beam™ Combination Wrench
81706	14 mm	XL X-Beam™ Combination Wrench
81707	15 mm	XL X-Beam™ Combination Wrench
81709	16 mm	XL X-Beam™ Combination Wrench
81710	17 mm	XL X-Beam™ Combination Wrench
81711	18 mm	XL X-Beam™ Combination Wrench
81713	19 mm	XL X-Beam™ Combination Wrench



81913 - 9 Pc. XL X-Beam™ Combination Non-Ratcheting Wrench Set SAE

Material No.	Description	
81714	5/16"	XL X-Beam™ Combination Wrench
81715	11/32"	XL X-Beam™ Combination Wrench
81717	3/8"	XL X-Beam™ Combination Wrench
81718	7/16"	XL X-Beam™ Combination Wrench
81719	1/2"	XL X-Beam™ Combination Wrench
81721	9/16"	XL X-Beam™ Combination Wrench
81722	5/8"	XL X-Beam™ Combination Wrench
81723	11/16"	XL X-Beam™ Combination Wrench
81725	3/4"	XL X-Beam™ Combination Wrench



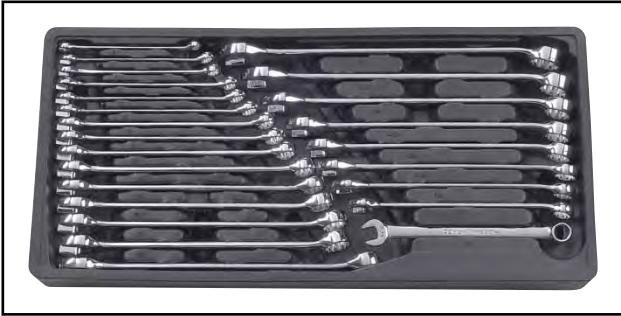

81900 - 24 Pc. Long Pattern Combination Non-Ratcheting Wrench Set SAE/METRIC

Material No.	Description	
81656	1/2"	Long Pattern Combination Wrench
81657	9/16"	Long Pattern Combination Wrench
81658	5/8"	Long Pattern Combination Wrench
81659	11/16"	Long Pattern Combination Wrench
81660	3/4"	Long Pattern Combination Wrench
81661	13/16"	Long Pattern Combination Wrench
81662	7/8"	Long Pattern Combination Wrench
81663	15/16"	Long Pattern Combination Wrench
81664	1"	Long Pattern Combination Wrench

Material No.	Description	
81665	8 mm	Long Pattern Combination Wrench
81666	9 mm	Long Pattern Combination Wrench
81667	10 mm	Long Pattern Combination Wrench
81668	11 mm	Long Pattern Combination Wrench
81669	12 mm	Long Pattern Combination Wrench
81670	13 mm	Long Pattern Combination Wrench
81671	14 mm	Long Pattern Combination Wrench
81672	15 mm	Long Pattern Combination Wrench
81673	16 mm	Long Pattern Combination Wrench
81674	17 mm	Long Pattern Combination Wrench
81675	18 mm	Long Pattern Combination Wrench
81676	19 mm	Long Pattern Combination Wrench
81677	20 mm	Long Pattern Combination Wrench
81678	21 mm	Long Pattern Combination Wrench
81679	22 mm	Long Pattern Combination Wrench



81901 - 15 Pc. Long Pattern Combination Non-Ratcheting Wrench Set SAE

Material No.	Description	
81652	5/16"	Long Pattern Combination Wrench
81653	11/32"	Long Pattern Combination Wrench
81654	3/8"	Long Pattern Combination Wrench
81655	7/16"	Long Pattern Combination Wrench
81656	1/2"	Long Pattern Combination Wrench
81657	9/16"	Long Pattern Combination Wrench
81658	5/8"	Long Pattern Combination Wrench
81659	11/16"	Long Pattern Combination Wrench
81660	3/4"	Long Pattern Combination Wrench
81661	13/16"	Long Pattern Combination Wrench
81662	7/8"	Long Pattern Combination Wrench
81663	15/16"	Long Pattern Combination Wrench
81664	1"	Long Pattern Combination Wrench
81650	1/4"	Long Pattern Combination Wrench
81651	9/32"	Long Pattern Combination Wrench

SETS
WRENCHES

81917 - 18 Pc. Long Pattern Combination Non-Ratcheting Wrench Set SAE

Material No.	Description	
81650	1/4"	Long Pattern Combination Wrench
81651	9/32"	Long Pattern Combination Wrench
81652	5/16"	Long Pattern Combination Wrench
81653	11/32"	Long Pattern Combination Wrench
81654	3/8"	Long Pattern Combination Wrench
81655	7/16"	Long Pattern Combination Wrench
81656	1/2"	Long Pattern Combination Wrench
81657	9/16"	Long Pattern Combination Wrench
81658	5/8"	Long Pattern Combination Wrench
81659	11/16"	Long Pattern Combination Wrench
81660	3/4"	Long Pattern Combination Wrench
81661	13/16"	Long Pattern Combination Wrench
81662	7/8"	Long Pattern Combination Wrench
81663	15/16"	Long Pattern Combination Wrench



Material No.	Description	
81664	1"	Long Pattern Combination Wrench
81733	1-1/6"	Long Pattern Combination Wrench
81734	1-1/8"	Long Pattern Combination Wrench
81735	1-1/4"	Long Pattern Combination Wrench

81902 - 15 Pc. Long Pattern Combination Non-Ratcheting Wrench Set METRIC

Material No.	Description	
81665	8 mm	Long Pattern Combination Wrench
81666	9 mm	Long Pattern Combination Wrench
81667	10 mm	Long Pattern Combination Wrench
81668	11 mm	Long Pattern Combination Wrench
81669	12 mm	Long Pattern Combination Wrench
81670	13 mm	Long Pattern Combination Wrench
81671	14 mm	Long Pattern Combination Wrench
81672	15 mm	Long Pattern Combination Wrench
81673	16 mm	Long Pattern Combination Wrench
81674	17 mm	Long Pattern Combination Wrench
81675	18 mm	Long Pattern Combination Wrench
81676	19 mm	Long Pattern Combination Wrench
81677	20 mm	Long Pattern Combination Wrench
81678	21 mm	Long Pattern Combination Wrench
81679	22 mm	Long Pattern Combination Wrench



SETS
WRENCHES

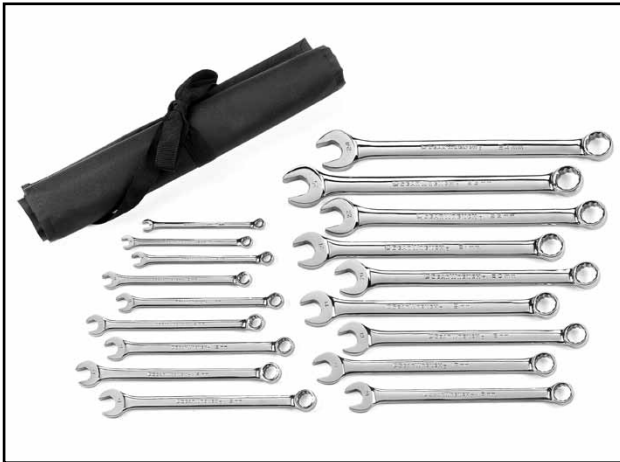

81920 - 18 Pc. Long Pattern Combination Non-Ratcheting Wrench Set METRIC

Material No.	Description	
81668	11 mm	Long Pattern Combination Wrench
81669	12 mm	Long Pattern Combination Wrench
81670	13 mm	Long Pattern Combination Wrench
81671	14 mm	Long Pattern Combination Wrench
81672	15 mm	Long Pattern Combination Wrench
81673	16 mm	Long Pattern Combination Wrench
81674	17 mm	Long Pattern Combination Wrench
81675	18 mm	Long Pattern Combination Wrench
81676	19 mm	Long Pattern Combination Wrench
81677	20 mm	Long Pattern Combination Wrench
81678	21 mm	Long Pattern Combination Wrench
81679	22 mm	Long Pattern Combination Wrench
81741	23 mm	Long Pattern Combination Wrench
81742	24 mm	Long Pattern Combination Wrench

Material No.	Description	
81737	7 mm	Long Pattern Combination Wrench
81665	8 mm	Long Pattern Combination Wrench
81666	9 mm	Long Pattern Combination Wrench
81667	10 mm	Long Pattern Combination Wrench



Open Stock - Long Pattern Combination Non-Ratcheting Wrenches SAE/METRIC

Material No.	Opening Inches/Metric	Overall Length (inch) A	Width Open End (inch) B	Thickness Open End (inch) C	Width Box End (inch) D	Thickness Box End (inch) E	Weight (lbs)
81650	1/4"	5.090	0.520	0.161	0.449	0.197	0.046
81651D	9/32"	5.440	0.567	0.169	0.484	0.209	0.062
81652D	5/16"	5.800	0.654	0.177	0.535	0.217	0.071
81653	11/32"	6.220	0.728	0.185	0.583	0.244	0.093
81654	3/8"	6.540	0.807	0.213	0.634	0.272	0.121
81655	7/16"	7.290	0.894	0.236	0.685	0.295	0.143
81656	1/2"	8.110	1.051	0.252	0.780	0.335	0.196
81657	9/16"	8.740	1.138	0.276	0.846	0.366	0.273
81658	5/8"	9.520	1.291	0.303	0.941	0.413	0.328
81659	11/16"	10.230	1.382	0.319	1.016	0.433	0.408
81660	3/4"	10.972	1.551	0.362	1.098	0.476	0.525
81661	13/16"	11.827	1.701	0.390	1.201	0.520	0.635
81662	7/8"	12.520	1.783	0.406	1.264	0.539	0.705
81663	15/16"	13.252	1.945	0.429	1.327	0.579	0.899
81664	1"	14.035	2.024	0.445	1.398	0.598	0.977

SETS
WRENCHES

Item No.	Opening Inches/Metric	Overall Length (inch)	Width Open End (inch)	Thickness Open End (inch)	Width Box End (inch)	Thickness Box End (inch)	Weight (lbs)
		A	B	C	D	E	
81733	1-1/16"	14.750	2.220	0.469	1.531	0.650	1.496
81734	1-1/8"	16.000	2.469	0.500	1.685	0.697	1.848
81735	1-1/4"	16.000	2.634	0.524	1.811	0.724	2.134
81749	1-5/16"	18.740	3.102	0.610	2.185	0.925	2.056
81750	1-1/2"	19.720	3.102	0.610	2.185	0.925	2.061
81736	6 mm	5.094	0.520	0.161	0.449	0.197	0.066
81737	7 mm	5.445	0.567	0.169	0.484	0.209	0.077
81665	8 mm	5.799	0.654	0.177	0.535	0.217	0.064
81666	9 mm	6.220	0.728	0.185	0.583	0.244	0.090
81667	10 mm	6.543	0.807	0.213	0.634	0.272	0.123
81668	11 mm	7.291	0.894	0.236	0.685	0.295	0.141
81669	12 mm	7.736	0.969	0.244	0.728	0.327	0.176
81670	13 mm	8.114	1.051	0.252	0.780	0.335	0.185
81671	14 mm	8.740	1.138	0.276	0.846	0.366	0.236
81672	15 mm	9.134	1.213	0.291	0.890	0.390	0.287
81673	16 mm	9.524	1.291	0.303	0.941	0.413	0.340
81674	17 mm	10.232	1.382	0.319	1.016	0.433	0.414
81675	18 mm	10.602	1.461	0.339	1.047	0.453	0.428
81676	19 mm	10.970	1.55	0.360	1.080	0.472	0.550
81677	20 mm	11.400	1.65	0.381	1.110	0.491	0.620
81678	21 mm	11.830	1.700	0.400	1.140	0.510	0.683
81679	22 mm	12.520	1.783	0.406	1.264	0.539	0.708
81741	23 mm	12.752	1.870	0.417	1.287	0.559	0.902
81742	24 mm	13.252	1.945	0.429	1.327	0.579	1.034
81751	25 mm	14.035	2.024	0.445	1.398	0.598	2.077
81752	26 mm	14.331	2.138	0.449	1.472	0.622	2.891
81743	27 mm	14.752	2.220	0.469	1.531	0.650	1.540
81753	28 mm	16.000	2.469	0.500	1.685	0.697	2.931
81744	30 mm	17.000	2.555	0.524	1.685	0.724	2.046
81745D	32 mm	17.362	2.634	0.524	1.811	0.724	2.047

OPEN STOCK

WRENCHES



**81905 - 10 Pc. Stubby Combination
Non-Ratcheting Wrench Set SAE**

Material No.	Description	
81624	3/8"	Stubby Combination Wrench
81625	7/16"	Stubby Combination Wrench
81626	1/2"	Stubby Combination Wrench
81627	9/16"	Stubby Combination Wrench
81628	5/8"	Stubby Combination Wrench
81629	11/16"	Stubby Combination Wrench
81630	3/4"	Stubby Combination Wrench
81631	13/16"	Stubby Combination Wrench
81632	7/8"	Stubby Combination Wrench
81633	15/16"	Stubby Combination Wrench



**81904 - 10 Pc. Stubby Combination
Non-Ratcheting Wrench Set METRIC**

Material No.	Description	
81634	10 mm	Stubby Combination Wrench
81635	11 mm	Stubby Combination Wrench
81636	12 mm	Stubby Combination Wrench
81637	13 mm	Stubby Combination Wrench
81638	14 mm	Stubby Combination Wrench
81639	15 mm	Stubby Combination Wrench
81640	16 mm	Stubby Combination Wrench
81641	17 mm	Stubby Combination Wrench
81642	18 mm	Stubby Combination Wrench
81643	19 mm	Stubby Combination Wrench

**81910 - 5 Pc. Flex Flare Nut
Non-Ratcheting Wrench Set SAE**

Material No.	Description
81693	1/4" x 5/16" Flex Flare Nut Wrench
81694	3/8 x 7/16" Flex Flare Nut Wrench
81695	1/2" x 9/16" Flex Flare Nut Wrench
81696	5/8" x 11/16" Flex Flare Nut Wrench
81697	3/4" x 7/8" Flex Flare Nut Wrench



**81911 - 6 Pc. Flex Flare Nut
Non-Ratcheting Wrench Set METRIC**

Material No.	Description
81686	9 x 11 mm Flex Flare Nut Wrench
81687	10 x 12 mm Flex Flare Nut Wrench
81688	13 x 14 mm Flex Flare Nut Wrench
81689	15 x 17 mm Flex Flare Nut Wrench
81690	16 x 18 mm Flex Flare Nut Wrench
81692	19 x 21 mm Flex Flare Nut Wrench

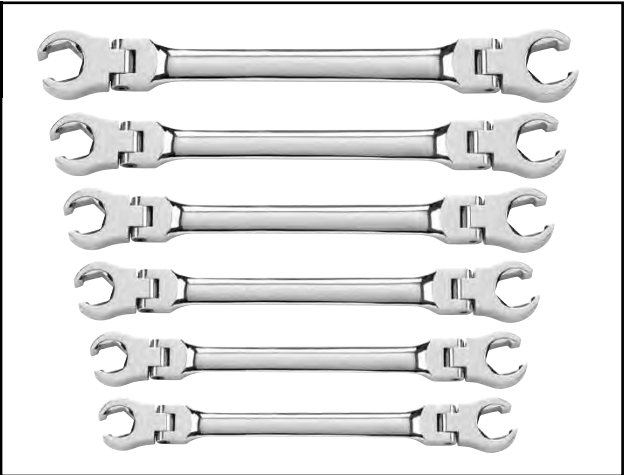



81926 - 5 Pc. 30 Degree Deep Offset Box Non-Ratcheting Wrench Set SAE

Material No.	Description
81787	3/8 X 1" 30 Degree Deep Offset Box Wrench
81788	1/2" x 9/16" 30 Degree Deep Offset Box Wrench
81789	11/16 X 3/4" 30 Degree Deep Offset Box Wrench
81790	13/16 X 7/8" 30 Degree Deep Offset Box Wrench
81791	15/16 X 1" 30 Degree Deep Offset Box Wrench



81927 - 5 Pc. 30 Degree Deep Offset Box Non-Ratcheting Wrench Set METRIC

Material No.	Description
81782	8 x 10 mm 30 Degree Deep Offset Box Wrench
81783	10 x 12 mm 30 Degree Deep Offset Box Wrench
81784	11 X 13 mm 30 Degree Deep Offset Box Wrench
81785	12 x 14 mm 30 Degree Deep Offset Box Wrench
81786	17 x 19 mm 30 Degree Deep Offset Box Wrench

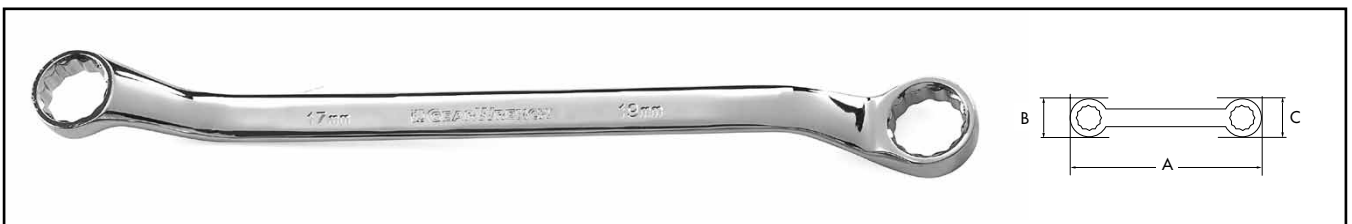

Open Stock - 30 Degree Deep Offset Box Non-Ratcheting Wrenches SAE

Material No.	Opening Inches/Metric	Overall Length (inch) A	Width Open End (inch) B	Width Open End (inch) D	Weight (lbs)
81787	3/8" x 1"	7.677	0.640	0.724	0.185
81788	1/2" x 9/16"	8.661	0.778	0.856	0.449
81789	11/16" x 3/4"	9.843	1.047	1.093	1.100
81790	13/16" x 7/8"	11.417	1.211	1.309	0.189
81791	15/16" x 1"	14.173	1.343	1.467	0.491
81782	8 x 10 mm	7.283	0.561	0.640	0.185
81783	10 x 12 mm	7.677	0.640	0.724	0.449
81784	11 x 13 mm	8.071	0.724	0.817	1.100
81785	12 x 14 mm	8.661	0.778	0.856	0.189
81786	17 x 19 mm	9.843	1.047	1.093	0.491

81929 - 7 Pc. Full Polish Open End Non-Ratcheting Wrench Set SAE

Material No.	Description	
81798	1/4 X 5/16"	Full Polish Open End Wrench
81799	3/8" x 7/16"	Full Polish Open End Wrench
81801	1/2 X 9/16"	Full Polish Open End Wrench
81802	5/8 X 11/16"	Full Polish Open End Wrench
81803	13/16 X 3/4"	Full Polish Open End Wrench
81804	15/16" x 1"	Full Polish Open End Wrench
81805	1-1/8 X 1-1/4"	Full Polish Open End Wrench



81928 - 6 Pc. Full Polish Open End Non-Ratcheting Wrench Set METRIC

Material No.	Description	
81792	6 x 7 mm	Full Polish Open End Wrench
81793	8 x 10 mm	Full Polish Open End Wrench
81794	10 x 12 mm	Full Polish Open End Wrench
81795	11 x 13 mm	Full Polish Open End Wrench
81796	12 x 14 mm	Full Polish Open End Wrench
81797	17 x 19 mm	Full Polish Open End Wrench



Open Stock - Full Polish Open End Non-Ratcheting Wrenches SAE

Material No.	Opening Inches/Metric	Overall Length (inch) A	Width Open End (inch) B	Thickness Open End (inch) C	Width Open End (inch) D	Thickness Open End (inch) E	Weight (lbs)
81798	1/4" x 5/16"	4.882	0.494	0.130	0.658	0.146	0.185
81799	3/8" x 7/16"	5.902	0.822	0.173	0.905	0.189	0.449
81801	1/2" x 9/16"	6.925	1.069	0.213	1.152	0.228	1.010
81802	5/8" x 11/16"	7.945	1.316	0.252	1.399	0.268	0.189
81803	13/16" x 3/4"	8.965	1.399	0.268	1.563	0.307	0.491
81804	15/16" x 1"	11.008	1.974	0.366	2.057	0.382	0.524
81805	1-1/8" x 1-1/4"	12.205	2.468	0.445	2.632	0.461	0.615
81792	6 x 7 mm	4.862	0.494	0.130	0.658	0.146	0.185
81793	8 x 10 mm	5.882	0.658	0.217	0.822	0.217	0.449
81794D	10 x 12 mm	6.390	0.822	0.232	0.988	0.232	1.100
81795	11 x 13 mm	6.858	0.905	0.244	1.069	0.244	0.189
81796	12 x 14 mm	7.327	0.988	0.260	1.152	0.260	0.491
81797	17 x 19 mm	8.917	1.399	0.268	1.563	0.307	0.524

SETS/OPEN STOCK

WRENCHES



Open Stock - Adjustable Cushion Grip Wrenches

Material No.	Overall Length (inch)	Capacity (inch)	Weight (lbs)
81891	9.000"	0.938	0.622
81892	11.000"	1.125	1.016
81893	13.000"	1.312	1.600

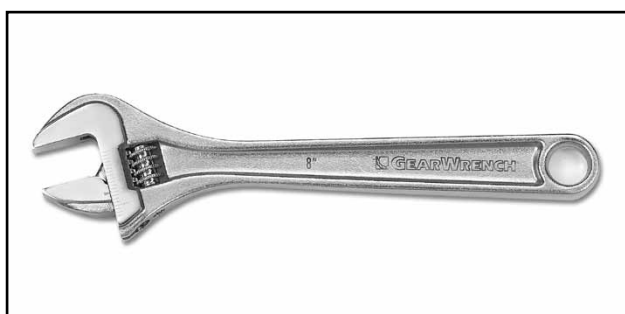

Open Stock Chrome Adjustable Wrenches

Material No.	Overall Length (inch)	Capacity (inch)	Weight (lbs)
81881	6.200"	0.750	0.599
81882	8.200"	0.938	0.599
81883	10.100"	1.125	1.000
81884	12.100"	1.312	1.400
81886	18.100"	1.750	2.800
81887	24.100"	2.000	4.400



Open Stock - Black Adjustable Wrenches

Material No.	Overall Length (inch)	Capacity (inch)	Weight (lbs)
81870	4.600	0.650	0.100
81871	6.200	0.750	0.599
81872	8.200	0.938	0.600
81873	10.100	1.125	1.000
81874	12.100	1.312	1.400
81875	15.000	1.500	2.800
81876	18.100	1.750	2.800
81877	24.100	2.000	4.400

OPEN STOCK

WRENCHES

TORQUE WRENCHES

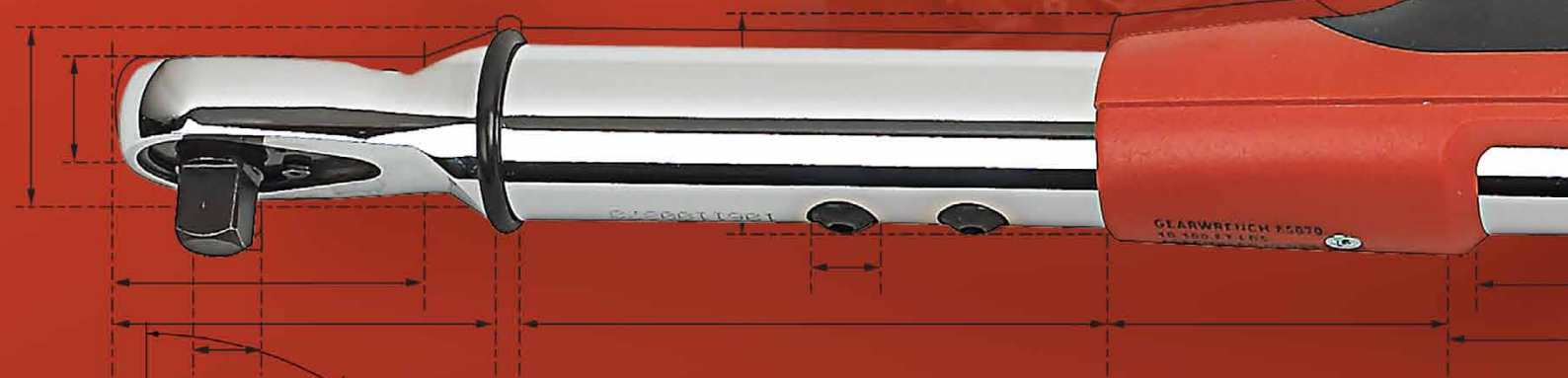
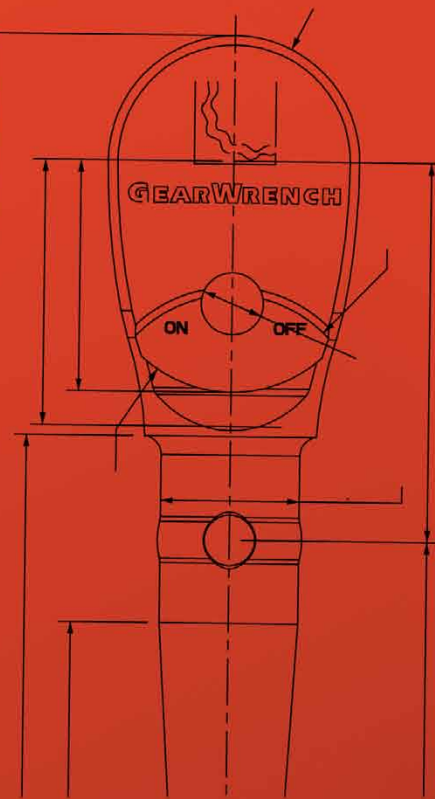

Torque Wrenches

Electronic Torque Wrenches
Micrometer Torque Wrenches

ELECTRONIC TORQUE WRENCHES WITH ANGLE



Sealed design guards against dirt infiltration

Backlit LCD Screen makes reading torque and angle values quick and easy



Digitally tracks torque and angle measurements. Buzzer with Red, Yellow and Green lights alerts you when targets are reached.

Shock-resistant housing provides durability



Thin-profile, high-strength teardrop head flexes for easier access and features a 60-tooth gear with 6° ratcheting arc

Torque Accuracy: +/- 2% CW, +/- 3% CCW from 20% to 100% full scale.
Angle Accuracy: +/- 1% of reading

Knurled Aluminum Grip resists slipping

MICROMETER TORQUE WRENCHES

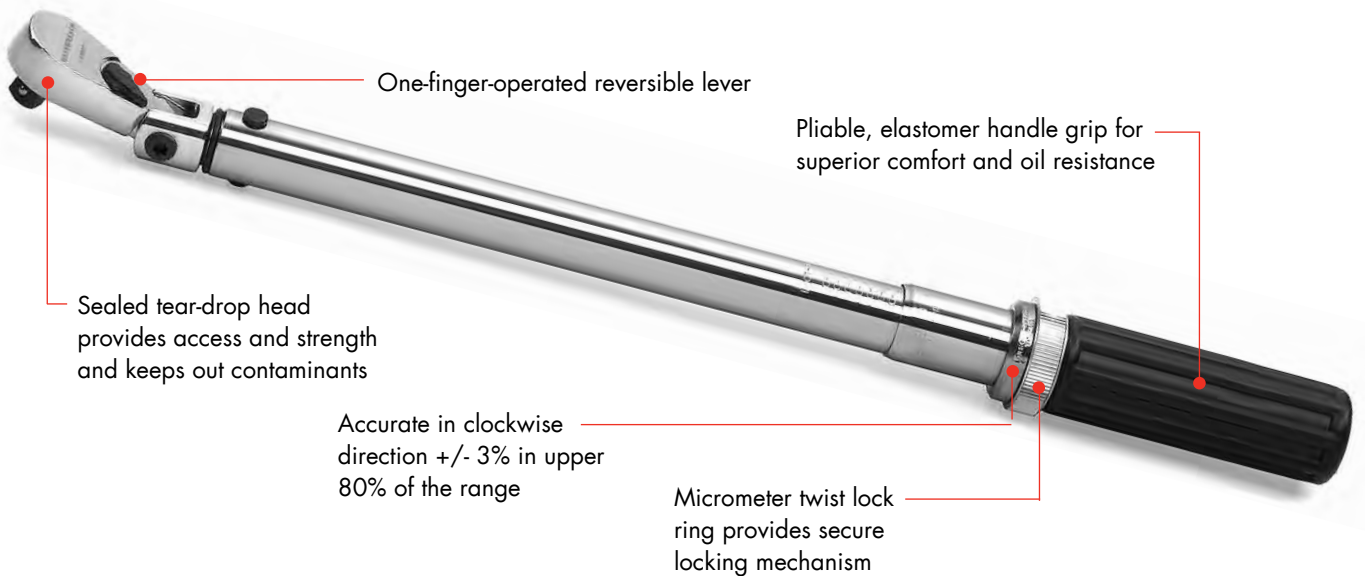

One-finger-operated reversible lever

Pliable, elastomer handle grip for superior comfort and oil resistance

Sealed tear-drop head provides access and strength and keeps out contaminants

Accurate in clockwise direction +/- 3% in upper 80% of the range

Micrometer twist lock ring provides secure locking mechanism

TORQUE WRENCHES

Electronic Torque Wrench

Material No.	Drive Size	Torque Range	Weight (lbs)
85070	3/8"	10 - 100 ft/lbs	3.2
85071	1/2"	25 - 250 ft/lbs	4.8



85050 - Micrometer Torque Wrench 1/4" Drive

Torque Range	Weight (lbs)
30 - 200 in/lbs	1.35



3/8" Drive - Micrometer Torque Wrench

Material No.	Torque Range	Weight (lbs)
85051	25 - 250 in/lbs	2.5
85052	10 - 100 ft/lbs	3.2

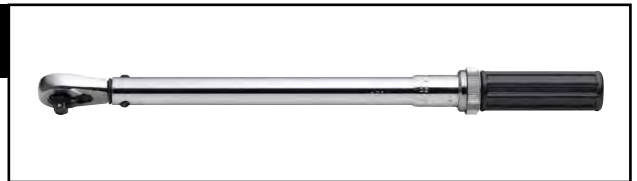

1/2" Drive - Micrometer Torque Wrench

Material No.	Torque Range	Weight (lbs)
85053	20 - 150 ft/lbs	4.2
85054	20 - 250 ft/lbs	5

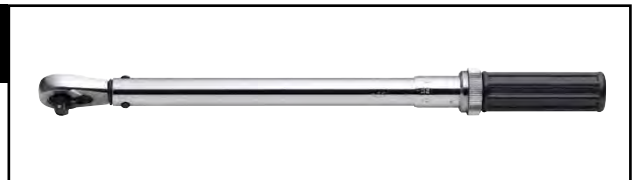

85055 - Micrometer Torque Wrench 3/4" Drive

Torque Range	Weight (lbs)
100 - 600 ft/lbs	16

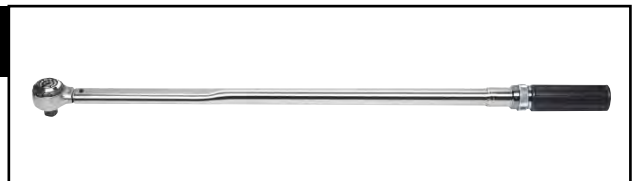

SCREWDRIVERS & NUTDRIVERS

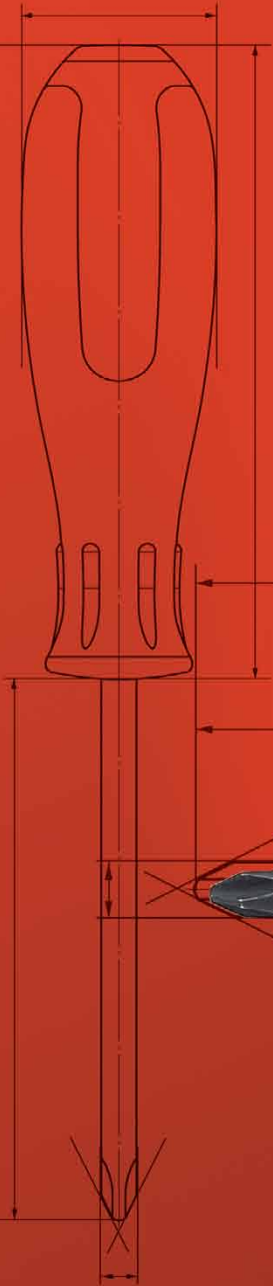
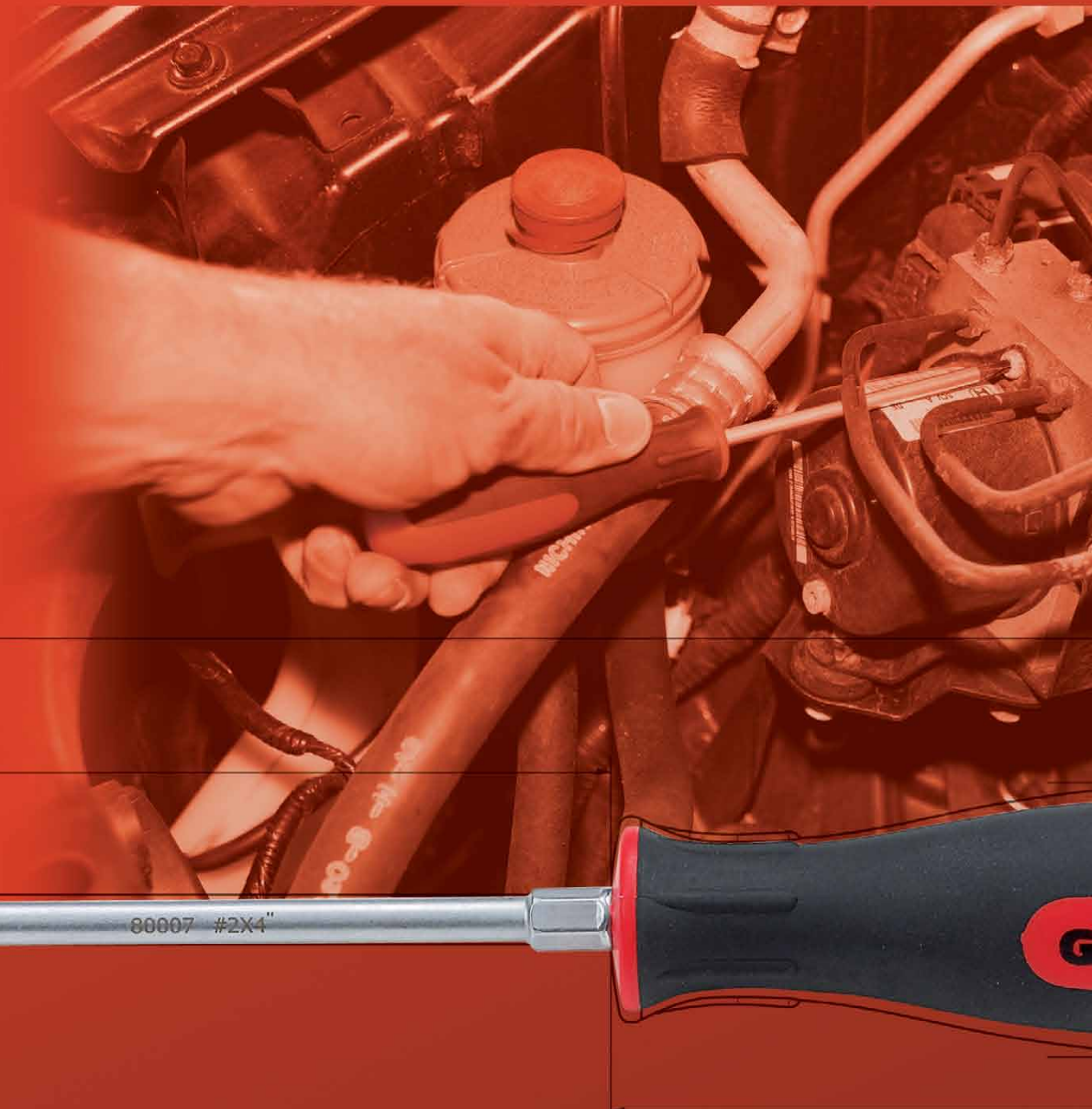

Screwdrivers & Nutdrivers

Dual Material Screwdrivers
Cushion Grip Screwdrivers
Nutdrivers
Ratcheting Nutdrivers

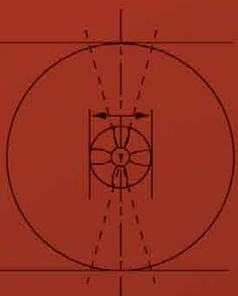

**DUAL MATERIAL
SCREWDRIVERS**

- AVAILABLE IN:**
- Phillips
 - Slotted
 - Torx®
 - Pozidrive®



**MINI
SCREWDRIVERS**



"Speed Zone" for turning in lower torque applications

Black Oxide Non-Slip Tip

Innovative Dual Material Handle for Comfort and Performance

AVAILABLE IN:

- Phillips
- Slotted
- Torx®

Cap color indicates tip style

- Black - Phillips
- Red - Slotted
- Grey - Torx®

**RATCHETING
SCREWDRIVERS**



Interchangeable shafts allow access to nearly any fastener

8° Reversible Ratcheting mechanism, Ratcheting or Non-ratcheting mode

Dual durometer ergonomic shape handle helps reduce fatigue and improve grip and high torque

- AVAILABLE IN:**
- Standard
 - T-Handle
 - Stubby

Removable end cap allows convenient storage for up to 12 bits

Products are covered by one or more of the following patents:

- US 7,137,320

80066 - 20 Pc. Master Dual Material Screwdriver Set

Material No.	Description
80012	1/4" x 1-1/2" Slotted Screwdriver
80018	3/16" x 6" Slotted Screwdriver
80013	1/4" x 4" Slotted Screwdriver
80014	1/4" x 6" Slotted Screwdriver
80023	5/16" x 6" Slotted Screwdriver
80022	3/8" x 8" Slotted Screwdriver
80000	#0 x 2-1/2" Phillips Screwdriver
80001	#1 x 3" Phillips Screwdriver
80004	#1 x 6" Phillips Screwdriver
80005	#2 x 1-1/2" Phillips Screwdriver
80007	#2 x 4" Phillips Screwdriver
80011	#3 x 6" Phillips Screwdriver
80034	1.5mm Mini Slotted Screwdriver
80035	2.0mm Mini Slotted Screwdriver
80036	2.5mm Mini Slotted Screwdriver
80031	#00 Mini Phillips Screwdriver
80032	#0 Mini Phillips Screwdriver
80033	#1 Mini Phillips Screwdriver
80025	T-15 Torx® Screwdriver
80026	T-20 Torx® Screwdriver



80051 - 12 Pc. Combination Dual Material Screwdriver Set

Material No.	Description
80012	1/4" x 1-1/2" Slotted Screwdriver
80018	3/16" x 6" Slotted Screwdriver
80013	1/4" x 4" Slotted Screwdriver
80014	1/4" x 6" Slotted Screwdriver
80023	5/16" x 6" Slotted Screwdriver
80022	3/8" x 8" Slotted Screwdriver
80000	#0 x 2-1/2" Phillips Screwdriver
80001	#1 x 3" Phillips Screwdriver
80004	#1 x 6" Phillips Screwdriver
80005	#2 x 1-1/2" Phillips Screwdriver
80007	#2 x 4" Phillips Screwdriver
80011	#3 x 6" Phillips Screwdriver





80050 - 6 Pc. Combination Dual Material Screwdriver Set

Material No.	Description
80015	1/8" x 3" Slotted Screwdriver
80013	1/4" x 4" Slotted Screwdriver
80023	5/16" x 6" Slotted Screwdriver
80022	3/8" x 8" Slotted Screwdriver
80001	#1 x 3" Phillips Screwdriver
80007	#2 x 4" Phillips Screwdriver

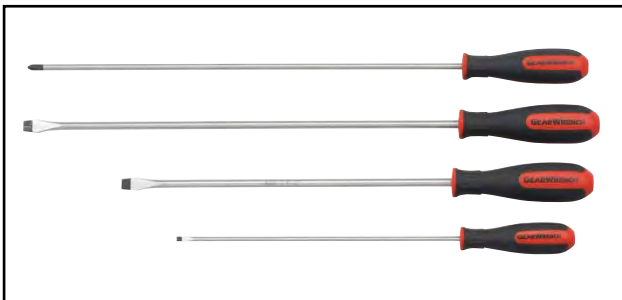

80059 - 4 Pc. Long Dual Material Screwdriver Set

Material No.	Description
80021	3/8" x 16" Long Slotted Screwdriver
80019	3/16" x 10" Long Slotted Screwdriver
80020	3/8" x 12" Long Slotted Screwdriver
80006	#2 x 16" Long Phillips Screwdriver



80055 - 6 Pc. Mini Dual Material Screwdriver Set

Material No.	Description
80034	1.5mm Mini Slotted Screwdriver
80035	2.0mm Mini Slotted Screwdriver
80036	2.5mm Mini Slotted Screwdriver
80031	#00 Mini Phillips Screwdriver
80032	#0 Mini Phillips Screwdriver
80033	#1 Mini Phillips Screwdriver



80060 - 10 Pc. Combination and Pozidriv® Dual Material Screwdriver Set

Material No.	Description
80043	#0 x 2-1/2" Pozidriv® Screwdriver
80044	#1 x 3" Pozidriv® Screwdriver
80045	#2 x 4" Pozidriv® Screwdriver
80046	#3 x 6" Pozidriv® Screwdriver
80015	1/8" x 3" Slotted Screwdriver
80017	3/16" x 4" Slotted Screwdriver
80013	1/4" x 4" Slotted Screwdriver
80023	5/16" x 6" Slotted Screwdriver
80001	#1 x 3" Phillips Screwdriver
80007	#2 x 4" Phillips Screwdriver



82765 - 7 Pc. Full Hollow Shaft Cushion Grip Nut Driver Set SAE

Material No.	Description	
82750	3/16" Nut Driver, Hollow Shaft	Black
82751	1/4" Nut Driver, Hollow Shaft	Red
82752	5/16" Nut Driver, Hollow Shaft	Yellow
82753	11/32" Nut Driver, Hollow Shaft	Green
82754	3/8" Nut Driver, Hollow Shaft	Blue
82755	7/16" Nut Driver, Hollow Shaft	Brown
82756	1/2" Nut Driver, Hollow Shaft	Red



82764 - 7 Pc. Full Hollow Shaft Cushion Grip Nut Driver Set METRIC

Material No.	Description
82757	5 mm Nut Driver, Hollow Shaft
82758	6 mm Nut Driver, Hollow Shaft
82759	7mm Nut Driver, Hollow Shaft
82760	8 mm Nut Driver, Hollow Shaft
82761	9 mm Nut Driver, Hollow Shaft
82762	10 mm Nut Driver, Hollow Shaft
82763	11 mm Nut Driver, Hollow Shaft



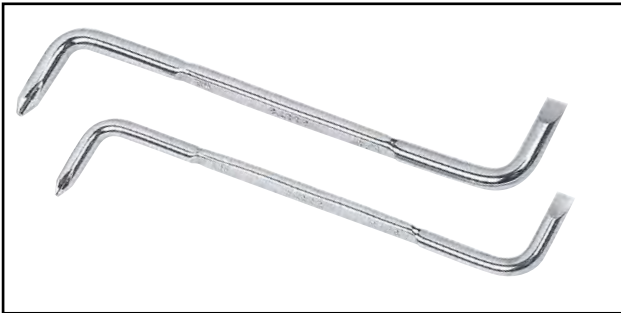

80072 - 2 Pc. Offset Screwdriver Set

Item No.	Description
	1/4" Slotted x #2 Phillips Offset Screwdriver
	3/16" Slotted x #1 Phillips Offset Screwdriver

Open Stock - Screw Holding Drivers



Item No.	Size	Blade Length (inch)	Blade Dia. (inch)	Overall Length (inch)	Handle Size (D x L) (inch)	Weight (lbs)
82791	3/16" x 6 Slotted	6"	0.197	9.74	1.24 x 3.74	0.212
82792	#1 x 3 Phillips	3"	0.197	6.74	1.24 x 3.74	0.173
82793	#2 x 7 Phillips	7"	0.236	11.33	1.42 x 4.33	0.300



**8916D - 16 Pc. Ratcheting Nut Driver Set
SAE/ METRIC**

Item No.	Description
890005GD	Ratcheting Screwdriver Stubby Handle - Red
890060GD	3/16" Nut Driver Shaft
890080GD	1/4" Nut Driver Shaft
890100GD	5/16" Nut Driver Shaft
890110GD	11/32" Nut Driver Shaft
890120GD	3/8" Nut Driver Shaft
890140GD	7/16" Nut Driver Shaft
890160GD	1/2" Nut Driver Shaft
891050GD	5mm Nut Driver Shaft
891060GD	6mm Nut Driver Shaft
891070GD	7mm Nut Driver Shaft
891080GD	8mm Nut Driver Shaft
891090GD	9mm Nut Driver Shaft
891100GD	10mm Nut Driver Shaft
891110GD	11mm Nut Driver Shaft
891120GD	12mm Nut Driver Shaft

SETS/OPEN STOCK
SCREWDRIVERS
NUT DRIVERS

PLIERS

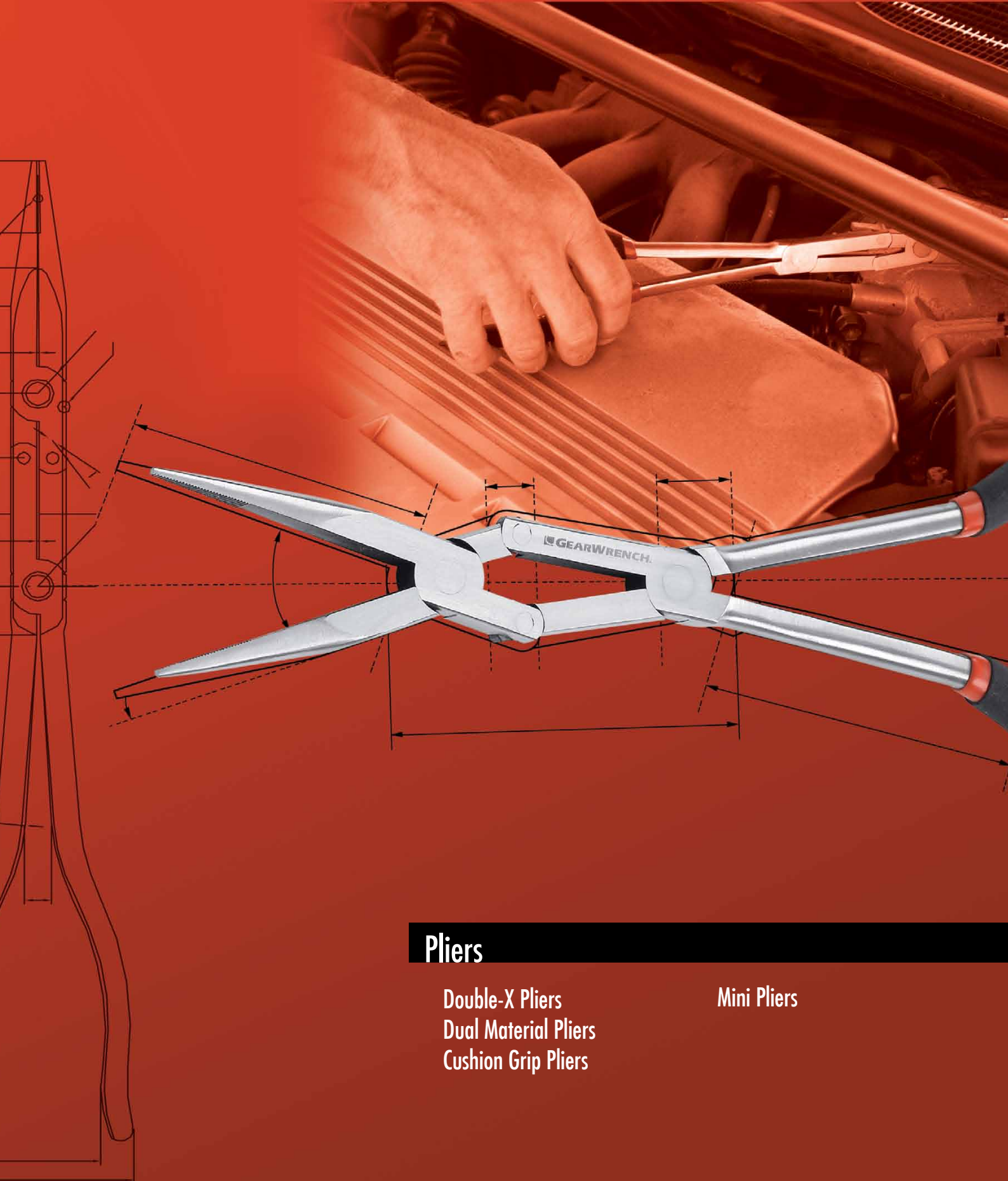

Pliers

Double-X Pliers
Dual Material Pliers
Cushion Grip Pliers

Mini Pliers

**DOUBLE-X™
PLIERS**

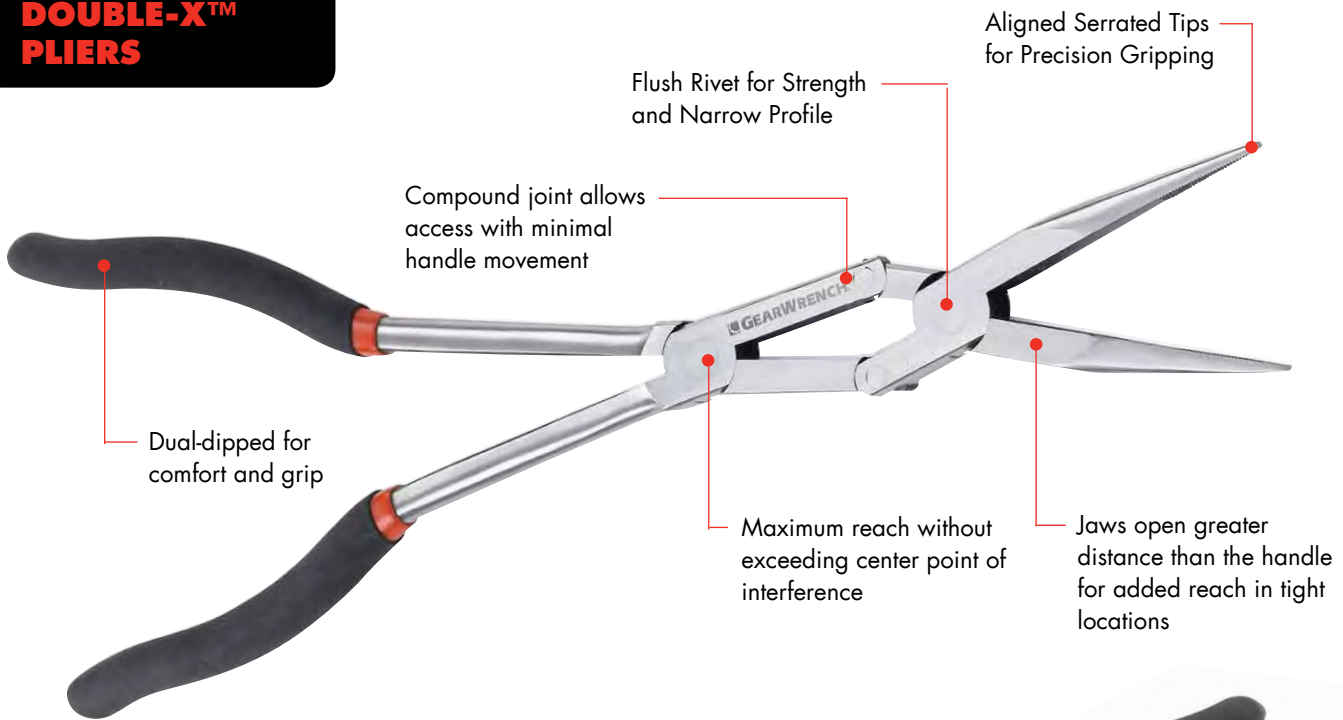

- AVAILABLE IN:**
- Straight Standard Pliers
 - 45° Standard Pliers
 - Duck Bill Standard Pliers
 - Internal / External Snap Ring Pliers
 - Straight Hemostat Pliers
 - 45° Hemostat Pliers



- APPLICATIONS**
- Long reach cotter pin removal
 - Use as a pick-up tool
 - Tight access under engine cowlings in aviation and automotive
 - Electrical terminal removal and installation

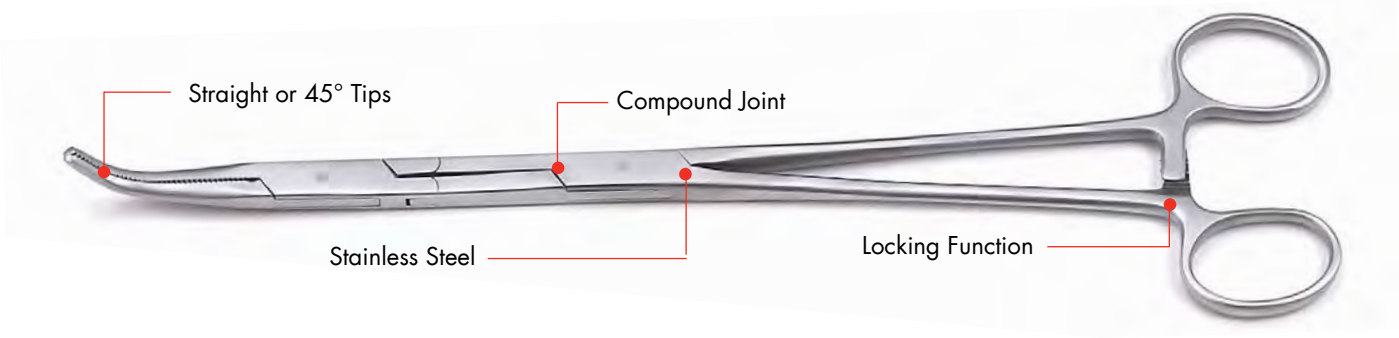

DUAL MATERIAL GRIP PLIERS

- AVAILABLE IN:**
- Slip Joint Pliers
 - Duck Bill Pliers
 - Diagonal Pliers
 - Linesmans Pliers
 - Bent Nose Pliers
 - Groove Joint Pliers
 - Long Nose Pliers
 - Fence Pliers

PLIERS



CUSHION GRIP PLIERS





82108 - 7 Pc. Mixed Pliers Set

Material No.	Description
82011	Tongue and Groove Pliers
82012	Diagonal Cutting Pliers
82013	Long Nose Pliers
82014	Slip Joint Pliers
82020	12" Groove Joint Pliers with Straight Jaw
82025	8" Linesman Pliers
82028	8" End Nipper Pliers

Weight 5.5 lbs



82103 - 4 Pc. Mixed Pliers Set

Material No.	Description
82011	Tongue and Groove Pliers
82012	Diagonal Cutting Pliers
82013	Long Nose Pliers
82014	Slip Joint Pliers

Weight 3.1 lbs



80058 - 8 Pc. Mini Screwdriver & Pliers Set

Material No.	Description
82001	Long Nose Mini Pliers
82000	Diagonal Cutting Mini Pliers
80034	1.5 mm Mini Slotted Screwdriver
80035	2.0 mm Mini Slotted Screwdriver
80036	2.5 mm Mini Slotted Screwdriver
80031	#00 Mini Phillips Screwdriver
80032	#0 Mini Phillips Screwdriver
80033	#1 Mini Phillips Screwdriver

Weight 1.5 lbs



82100 - 5 Pc. Mixed Mini Pliers Set

Material No.	Description
82000	Diagonal Cutting Mini Pliers
82001	Long Nose Mini Pliers
82002	Needle Nose Mini Pliers
82003	End Cutting Nipper Mini Pliers
82004	Flat Nose Mini Pliers

Weight 0.99 lbs

82005D - Straight Double-X™ Pliers

Jaw Length A	Jaw Width B	Jaw Thickness C	Overall Length D	Weight (lbs)
3.15"	0.68"	0.39"	13.46"	0.84

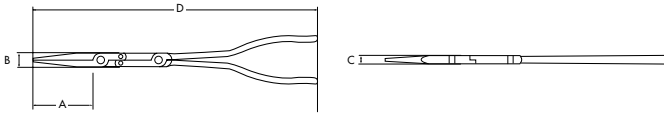

82006D - 45 Degree Double-X™ Pliers

Jaw Length A	Jaw Width B	Jaw Thickness C	Overall Length D	Weight (lbs)
2.95"	0.68"	0.39"	13.27"	0.86

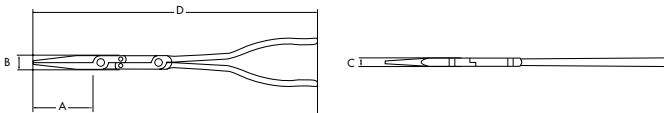

82007 - Duck Bill Double-X™ Pliers

Jaw Length A	Jaw Width B	Jaw Thickness C	Overall Length D	Weight (lbs)
1.65"	0.68"	0.39"	11.97"	0.79

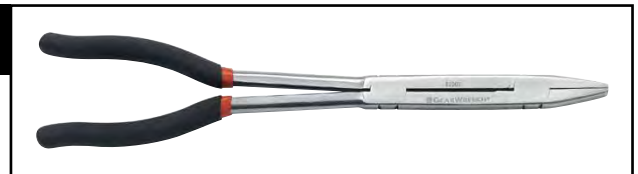
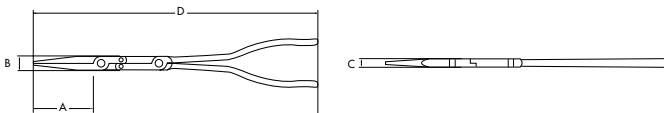

Open Stock - Hose Grip Double-X™ Pliers

Material No.	Size	Jaw Length A	Jaw Width B	Jaw Thickness C	Overall Length D	Weight (lbs)
82017	5/16"	2.87"	0.68"	0.39"	13.19"	0.83
82018	1/2"	2.81"	0.68"	0.39"	13.13"	0.83
82019	3/4"	2.72"	0.68"	0.39"	13.03"	0.83

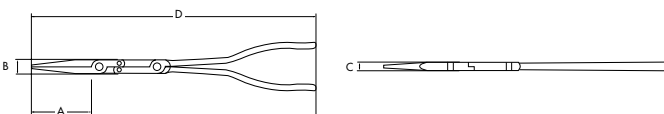



82032 - Double-X™ Internal Snap Ring Pliers

Jaw Length A	Jaw Width B	Jaw Thickness C	Overall Length D	Weight (lbs)
3.15"	0.68"	0.39"	13.46"	0.88

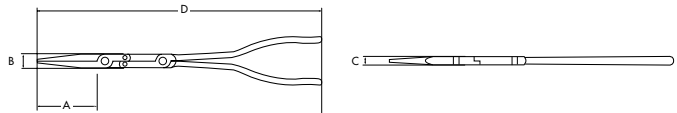

82033 - Double-X™ External Snap Ring Pliers

Jaw Length A	Jaw Width B	Jaw Thickness C	Overall Length D	Weight (lbs)
3.15"	0.68"	0.39"	13.46"	0.88

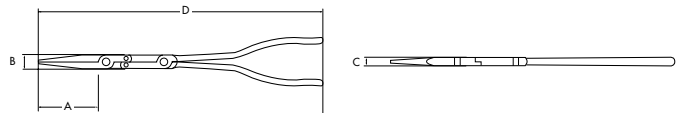

82034 - Double-X™ Straight Hemostat Pliers

Jaw Length A	Jaw Width B	Jaw Thickness C	Overall Length D	Weight (lbs)
4.22"	0.16"	0.13"	9.84"	0.21

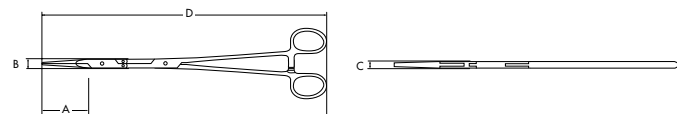

82035 - Double-X™ 45 Degree Hemostat Pliers

Jaw Length A	Jaw Width B	Jaw Thickness C	Overall Length D	Weight (lbs)
4.09"	0.16"	0.13"	9.73"	0.21

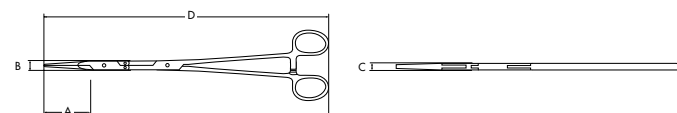

PRY BARS



Pry Bars

Indexing Pry Bar
Extendable Pry Bar

INDEXING PRY BARS

PRY BARS

AVAILABLE IN:

- Fixed Handle
- Extendable Handle

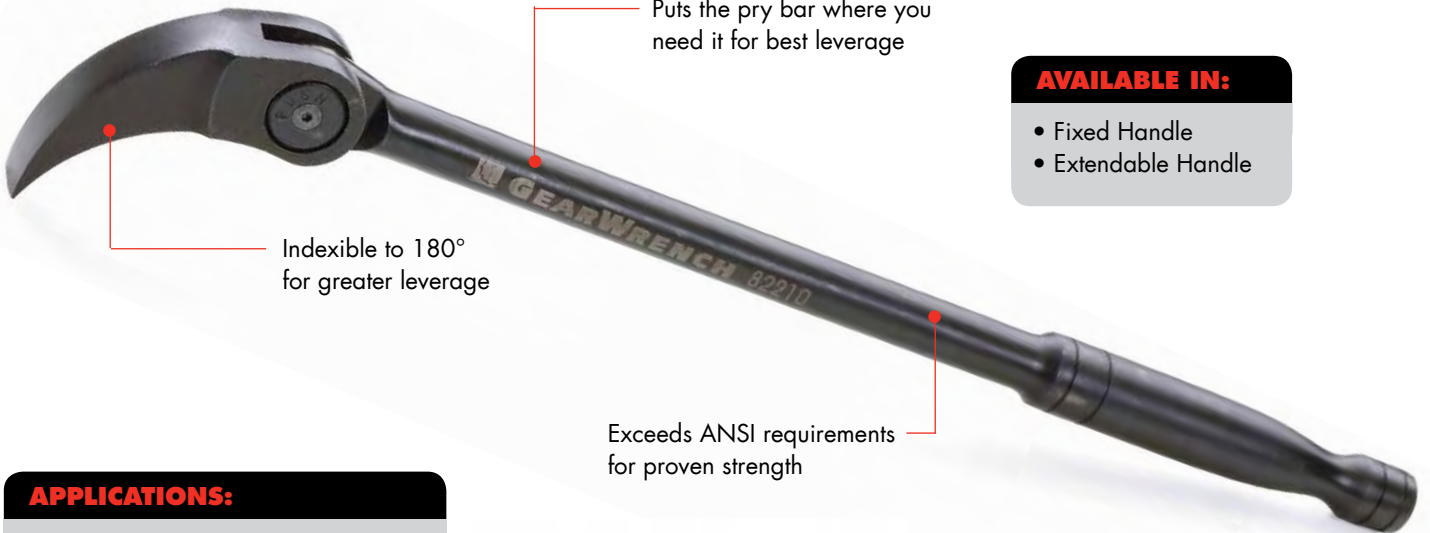

Puts the pry bar where you need it for best leverage

Indexible to 180° for greater leverage

Exceeds ANSI requirements for proven strength

APPLICATIONS:

- Demolition of roof rafters and floor joists
- Removing broken concrete
- Repositioning equipment
- Aligning steel components and fabrications
- Engine repositioning and placement



14 Locking positions for unmatched access

Grooved profile adds traction on 24", 33" and Extendable Models





Extendable pry bar extends for greater access and leverage and collapses so you can store it securely in your tool box



PRY BARS

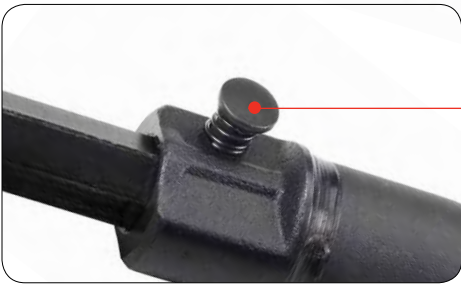

Extends from 18" to 29"

Push button to extend reach

Products are covered by one or more of the following patents:
• US 6,840,141



Open Stock - Indexing Pry Bar

Material No.	Description
82224	24" Indexing Pry Bar



Open Stock - Extendable Pry Bar

Material No.	Description
82220	18" to 29" Extendable Pry Bar

PUNCHES & CHISELS

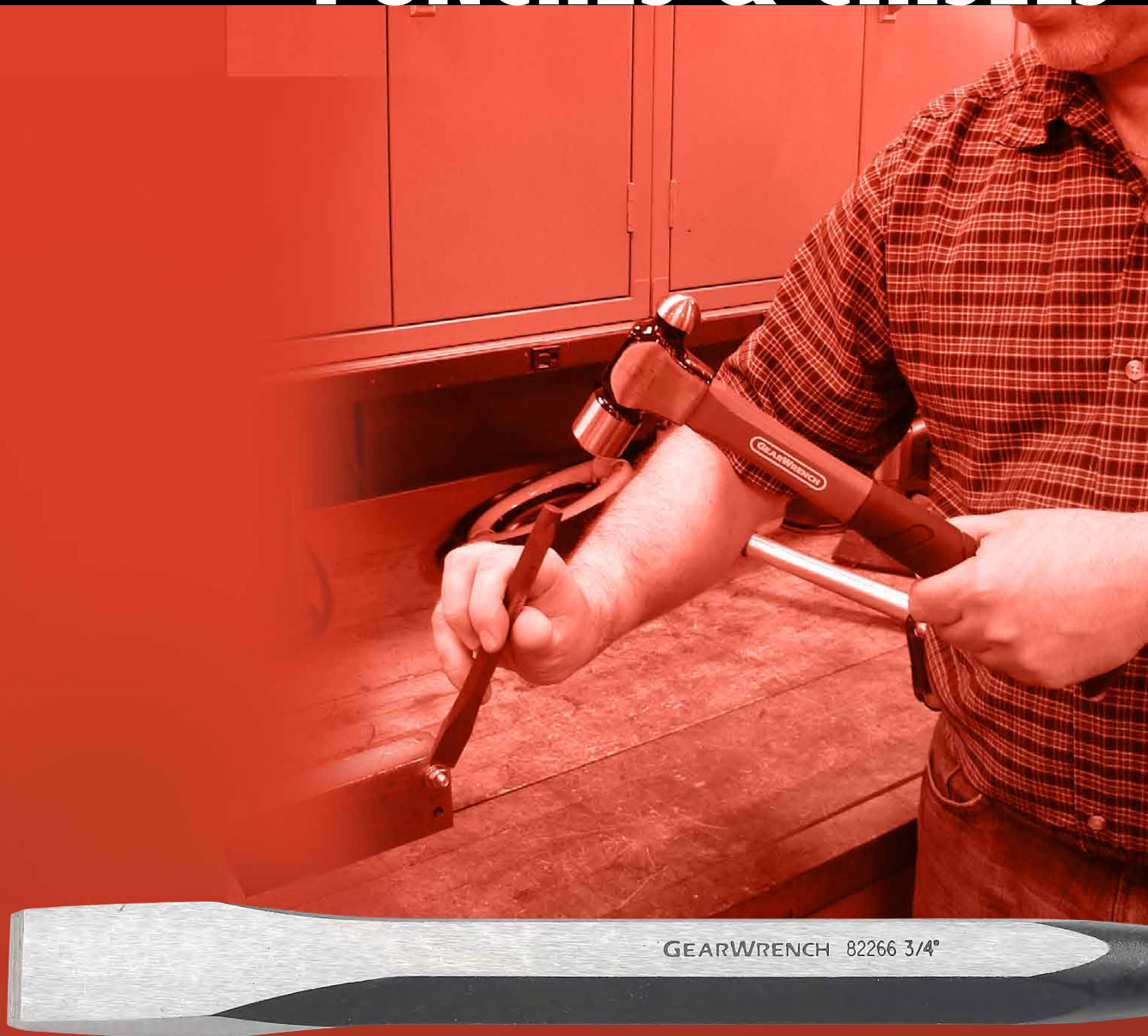

GEARWRENCH 82266 3/4"

Punches & Chisels

Punches
Chisels

CHISELS AND PUNCHES

AVAILABLE IN:

- Cold Chisels
- Centre Punches
- Pin Punches
- Long Taper Punches

Hardened Tips

Precision Hardened Alloy Steel

Surface Ground for Easy Size identification

Softened Striking Surface



PUNCHES AND CHISELS

82304 - 5 Pc. Punch and Chisel Set

Material No.	Description
82270	3/8" x 5" Center Punch
82273	1/8" x 5" x 5/16" Pin Punch
82274	5/32" x 5-1/4" x 5/16" Pin Punch
82275	3/16" x 5-1/2" x 5/16" Pin Punch
82264	1/2" x 6" x 3/8" Cold Chisel



82308 - 4 Pc. Cold Chisel Set

Material No.	Description
82263	7/16" x 5-1/2" x 3/8" Cold Chisel
82264	1/2" x 6" x 3/8" Cold Chisel
82265	5/8" x 6-1/2" x 3/8" Cold Chisel
82266	3/4" x 7" x 5/8" Cold Chisel



82309 - 5 Pc. Pin Punch Set

Material No.	Description
82273	1/8" x 5" x 5/16" Pin Punch
82274	5/32" x 5-1/4" x 5/16" Pin Punch
82275	3/16" x 5-1/2" x 5/16" Pin Punch
82276	1/4" x 7" x 3/8" Pin Punch
82277	5/16" x 7" x 1/2" Pin Punch



82307 - 4 Pc. Long Taper Punch Set

Material No.	Description
82278	1/8" x 8" x 3/8" Long Taper Punch
82279	5/32" x 8-1/2" x 1/2" Long Taper
82280	3/16" x 9" x 1/2" Long Taper Punch
82281	1/4" x 11" x 5/8" Long Taper Punch



RATCHETING TAPS & DIES

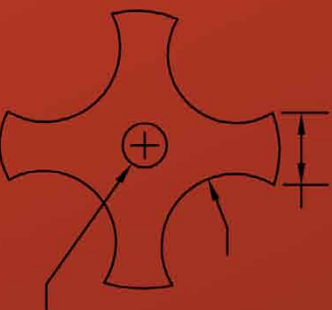
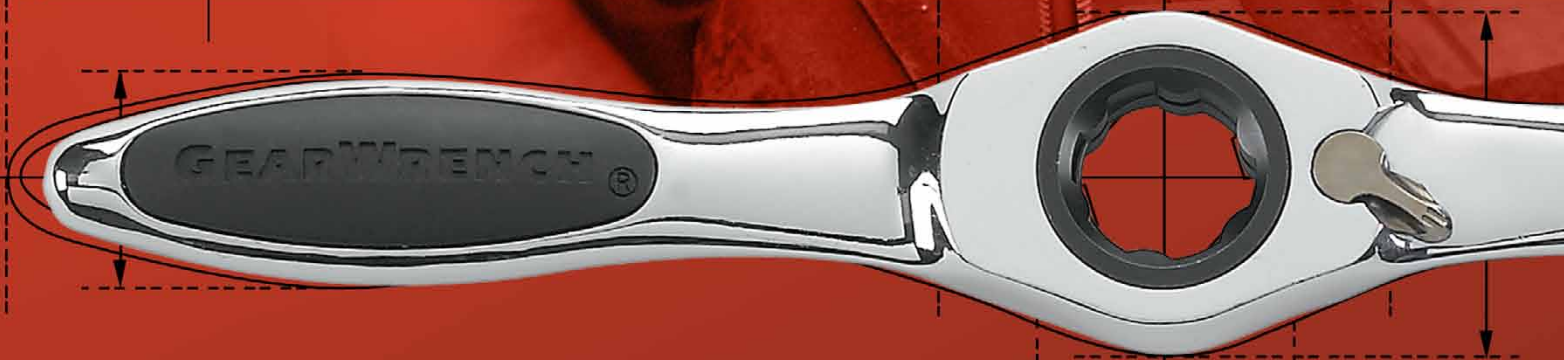
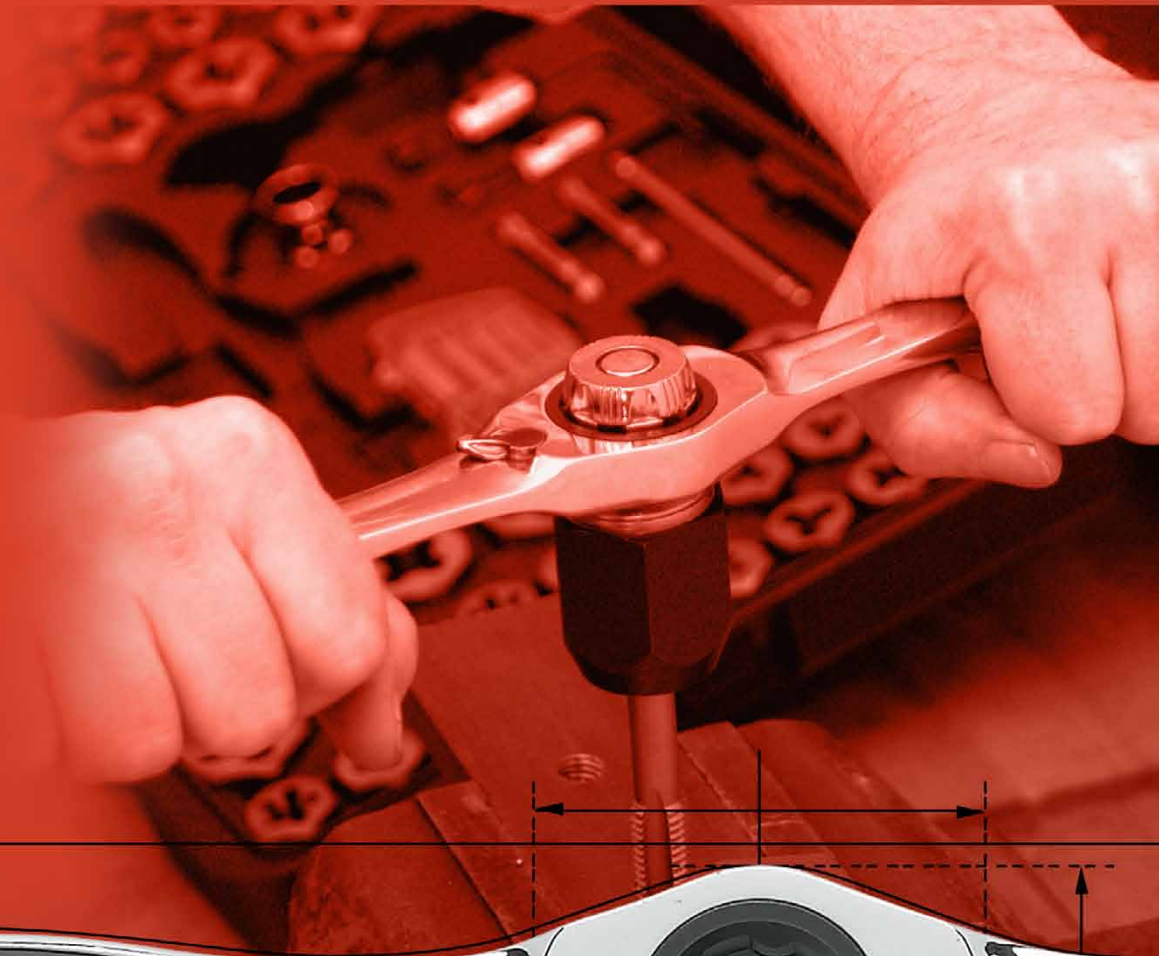

Tap & Die Tools

Ratcheting Tap & Die Sets
T-Wrenches
Adapters

RATCHETING TAP AND DIE DRIVE TOOLS



Auto locking feature allows for safe removal of tap adapter

Spring-loaded cap allows for quick-release of large tap adapter

Extension adapters provide access in tight confined areas

Extend the length of tap and die system by combining adapters and any standard 3/8" drive extension.



Works on round and hex shaped dies

Die adapter works with Pass-Thru® Ratchet and Socket System as well as Vortex™ socket accessories.

5° Ratcheting arc with reversible lever eliminates hand over hand turning

Patented Twist Lock Guide System reduces "back walk" of die guard



Products are covered by one or more of the following patents:

- US 6,868,759
- US 7,231,851
- US 7,168,346

RATCHETING TAPS & DIES



3887 - 75 Pc. Medium Ratcheting Tap and Die Drive Tool Set SAE/METRIC

Material No.	Description
3881	Medium Tap and Die Ratcheting "T" Wrench
3882	Small Tap Adapter
3883	Medium Tap Adapter
3884	Medium Hex Die Adapter
	Sliding "T" for adapters
	SAE screw pitch gauge
	METRIC screw pitch gauge
	#5 screwdriver

Taps

1/4 - 20 NC taper	1/4 - 20 NC taper
1/4 - 28 NF taper	1/4 - 28 NF taper
5/16 - 18 NC taper	5/16 - 18 NC taper
5/16 24 NF taper	5/16 24 NF taper
3/8 - 16 NC plug	3/8 - 16 NC plug
3/8 - 24 NF plug	3/8 - 24 NF plug
7/16 -14 NC plug	7/16 -14 NC plug
7/16 - 20 NF plug	7/16 - 20 NF plug
1/2 - 13 NC plug	1/2 - 13 NC plug
1/2 - 20 NF plug	1/2 - 20 NF plug
4 - 40 taper	4 - 40 taper
6 - 32 taper	6 - 32 taper
8 - 32 taper	8 - 32 taper
10 - 24 taper	10 - 24 taper
10 - 32 taper	10 - 32 taper
12 - 24 taper	12 - 24 taper
1/8 - 27 NPT	1/8 - 27 NPT

Hex Dies

1/4 - 20 NC	3 x .50 taper
1/4 - 28 NF	3 x .60 taper
5/16 - 18 NC	4 x .70 taper
5/16 - 24 NF	4 x .75 taper
3/8 - 16 NC	5 x .80 taper
3/8 - 24 NF	5 x .90 taper
7/16 -14 NC	6 x 1.00 taper
7/16 - 20 NF	7 x 1.00 taper
1/2 -13 NC	8 x 1.25 plug
1/2 - 20 NF	9 x 1.00 plug
4 - 40 taper	9 x 1.25 plug
6 - 32 taper	10 x 1.25 plug
8 - 32 taper	10 x 1.50 plug
10 - 24 taper	11 x 1.50 plug
10 - 32 taper	12 x 1.50 plug
12 - 24 taper	12 x 1.75 plug
1/8 - 27 NPT	1/8 - 28BSP

3885 - 40 Pc. Medium Ratcheting Tap and Die Drive Tool Set SAE

Material No.	Description
3881	Medium Tap and Die Ratcheting "T" Wrench
3882	Small Tap Adapter
3883	Medium Tap Adapter
3884	Medium Hex Die Adapter
	Sliding "T" for adapters
	Thread gauge
	#5 screwdriver

Taps

1/4 - 20 NC taper
1/4 - 28 NF taper
5/16 - 18 NC taper
5/16 - 24 NF taper
3/8 - 16 NC plug
3/8 - 24 NF plug
7/16 - 14 NC plug
7/16 - 20 NF plug
1/2 - 13 NC plug
1/2 - 20 NF plug
4 - 40 taper
6 - 32 taper
8 - 32 taper
10 - 24 taper
10 - 32 taper
12 - 24 taper
1/8 - 27 NPT

Hex Dies

1/4 - 20 NC
1/4 - 28 NF
5/16 - 18 NC
5/16 - 24 NF
3/8 - 16 NC
3/8 - 24 NF
7/16 - 14 NC
7/16 - 20 NF
1/2 - 13 NC
1/2 - 20 NF
4 - 40 taper
6 - 32 taper
8 - 32 taper
10 - 24 taper
10 - 32 taper
12 - 24 taper
1/8 - 27 NPT





3886 - 40 Pc. Medium Ratcheting Tap and Die Drive Tool Set METRIC

Material No.	Description
3881	Medium Tap and Die Ratcheting "T" Wrench
3882	Small Tap Adapter
3883	Medium Tap Adapter
3884	Medium Hex Die Adapter
	Sliding "T" for adapters
	Thread gauge
	#5 screwdriver

Taps	Hex Dies
3 x .50 taper	3 x .60
3 x .60 taper	4 x .70
4 x .70 taper	4 x .75
4 x .75 taper	5 x .80
5 x .80 taper	5 x .90
5 x .90 taper	6 x 1.00
6 x 1.00 taper	7 x 1.00
7 x 1.00 taper	8 x 1.25
8 x 1.25 plug	9 x 1.00
9 x 1.00 plug	9 x 1.25
9 x 1.25 plug	10 x 1.25
10 x 1.25 plug	10 x 1.50
10 x 1.50 plug	11 x 1.50
11 x 1.50 plug	12 x 1.50
12 x 1.50 plug	12 x 1.75
12 x 1.75 plug	1/8 - 28BSP

82808 - 17 Pc. Large Ratcheting Tap and Die Set SAE

Material No.	Description
82800	Large Ratcheting "T" Wrench
82801	Large Locking Tap Adapter
82802	Large Hex Die Adapter
	SAE Thread Gauge
	4mm Hex Key

Taps	Hex Dies
9/16 - 12 NC plug	9/16 - 12 NC
9/16 - 18 NF plug	9/16 - 18 NF
5/8 - 11 NC plug	5/8 - 11 NC
5/8 - 18 NF plug	5/8 - 18 NF
3/4 - 10 NC plug	3/4 - 10 NC
3/4 - 16 NF plug	3/4 - 16 NF



PATENTED

82809 - 17 Pc. Large Ratcheting Tap and Die Set METRIC

Material No.	Description
82800	Large Ratcheting "T" Wrench
82801	Large Locking Tap Adapter
82802	Large Hex Die Adapter
	Metric Thread Gauge
	4mm Hex Key

Taps	Hex Dies
14 x 1.25 plug	14 x 1.25 plug
14 x 2.00 plug	14 x 2.00 plug
16 x 1.50 plug	16 x 1.50 plug
16 x 2.00 plug	16 x 2.00 plug
18 x 1.50 plug	18 x 1.50 plug
18 x 2.50 plug	18 x 2.50 plug



PATENTED



82805D - 2 Pc. Ratcheting Tap and Die 3/8"
Drive Extension Adapter Set

Material No.	Description
82803	Male Extension Adapter - 3/8" Drive
82804	Female Extension Adapter - 3/8" Drive

OPEN STOCK

RATCHETING TAPS & DIES

SPECIALTY & GENERAL PURPOSE TOOLS

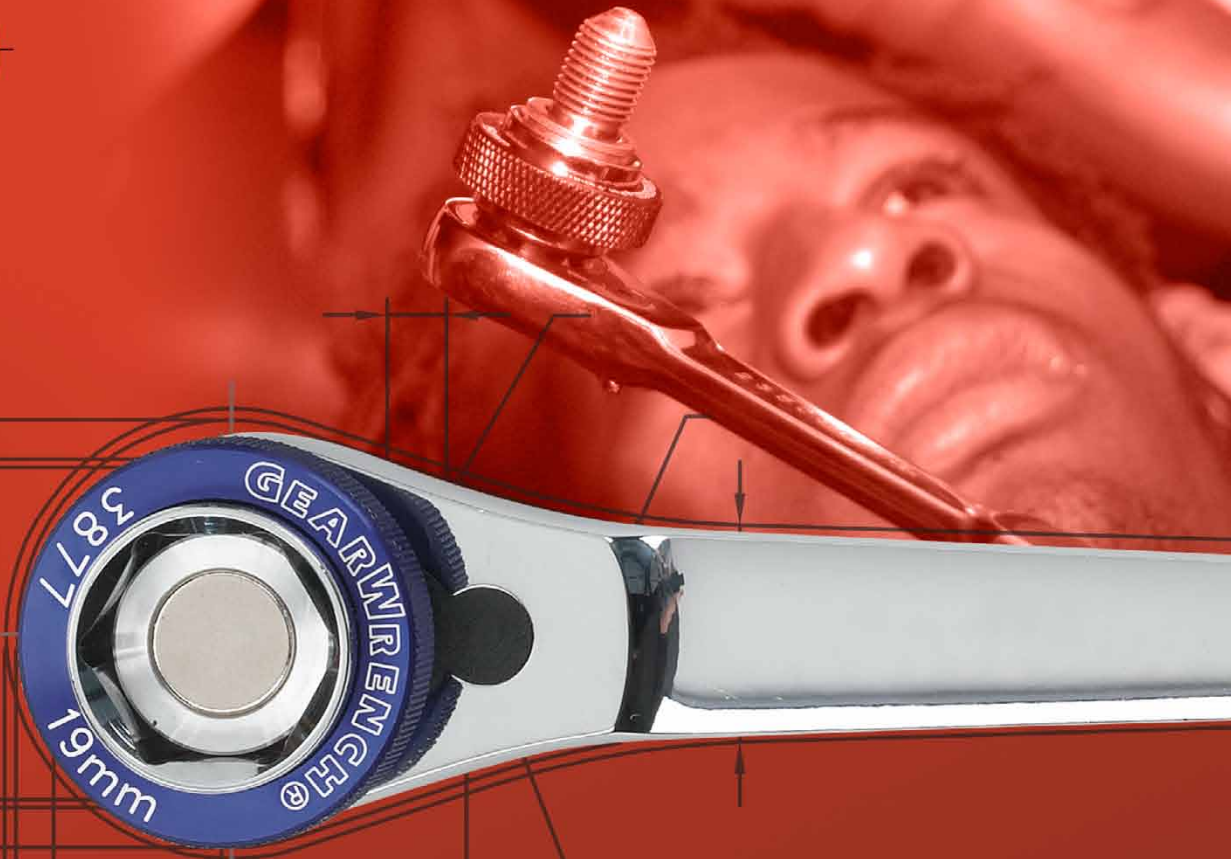
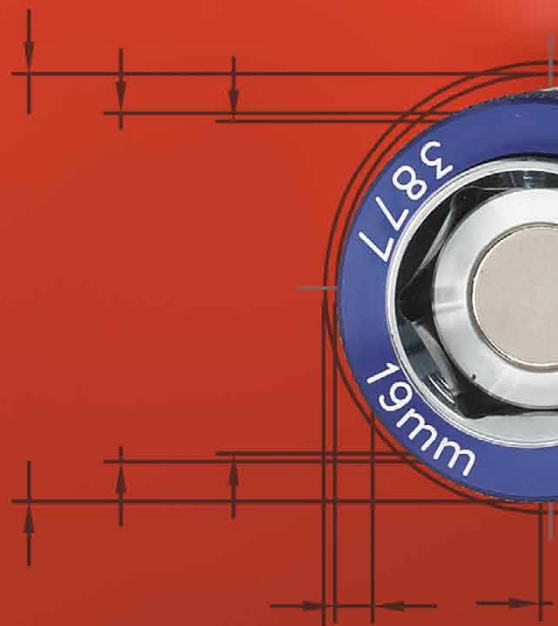
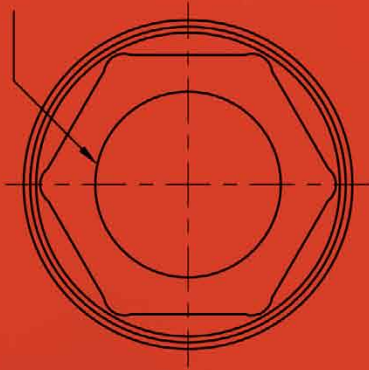

Specialty Tools

Oil Drain Plug Sockets

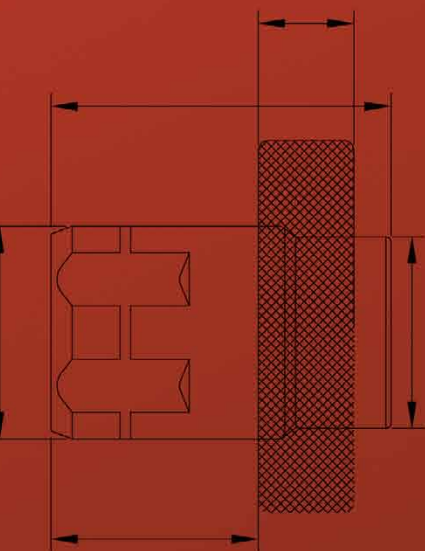

General Purpose Tools

Flashlight
Gloves

**OIL DRAIN
PLUG SOCKETS**

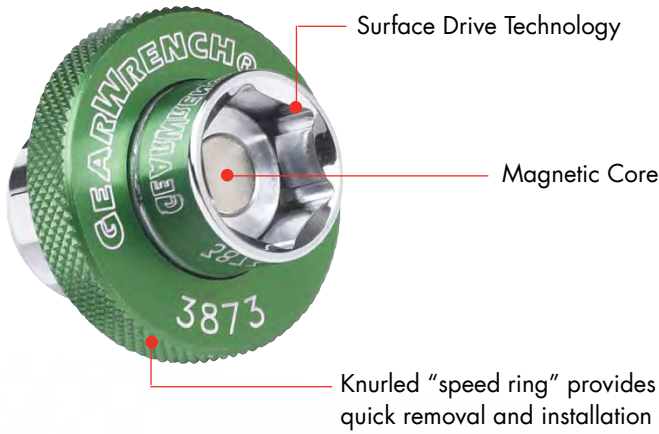

Anodized color coded aluminum

Fits most domestic and import vehicles

SPECIALTY & GENERAL

Can be used with Pass-Thru® Ratchets Featuring GearRatchet™ handles, or standard 3/8" Drive ratchets



Products are covered by one or more of the following patents:

- US 7,159,491
- US 7,658,132



3870D - 7 Pc. Magnetic Oil Drain Plug Socket Set

Material No.	Description
235080GR	3/8" (20 mm) GearRatchet® Handle
3872	13 mm Magnetic Oil Drain Plug Socket
3873	14 mm Magnetic Oil Drain Plug Socket
3874	15 mm Magnetic Oil Drain Plug Socket
3875	16 mm Magnetic Oil Drain Plug Socket
3876	17 mm Magnetic Oil Drain Plug Socket
3877	19 mm Magnetic Oil Drain Plug Socket



83132 - Flashlight Aluminium

- Aluminium body with rubber grip.
- Five LED bulbs above 13000 mcd, white light.
- Weatherproof.
- Rubber ring around head of flashlight.
- Includes carry case.



86990 - Mechanics Gloves



86991 - Fender Cover

- Magnetic
- Oil Resistant
- Measure 876mm/34½"W x 470mm/18½"L



APEX TOOL GROUP - CUSTOMER SUPPORT

Sales Phone: 02 6021 6666

Sales Fax: 1800 021 940

Sales E-Mail: alburysales@apextoolgroup.com

HEAD OFFICE

Apex Tool Group
519 Nurigong Street PO Box 366
ALBURY NSW 2640 ALBURY NSW 2640
Phone: 02 6058 0300 Fax: 02 6021 7403
Email: apextoolaus@apextoolgroup.com
Web: www.apextoolgroup.com.au

REGIONAL SALES TEAM & AGENTS

NSW

STEPHEN BRADLEY

Sales Supervisor
Mobile: 0457 750 475
stephen.bradley@apextoolgroup.com

PHIL CROWE

Sales Supervisor
Phone: 02 4735 2298
Fax: 02 4735 2296
Mobile: 0418 474 949
phil.crowe@apextoolgroup.com

GEOFF NELSON

Sales Supervisor
Phone: 02 4920 8936
Fax: 02 4920 8936
Mobile: 0418 478 086
geoff.nelson@apextoolgroup.com

IAN BROWN

Sales Supervisor
Phone: 02 9648 1990
Fax: 02 9648 1990
Mobile: 0417 028 221
ian.brown2@apextoolgroup.com

PATRICK McINTOSH

Manager Business Development
Fax: 02 6336 0273
Mobile: 0418 673 361
patrick.mcintosh@apextoolgroup.com

QLD

ASHLEY PRICE

Regional Manager
Phone: 07 3801 2601
Fax: 07 3209 7088
Mobile: 0418 475 804
ashley.price@apextoolgroup.com

WARWICK STONE

Sales Supervisor
Phone: 07 3264 5258
Fax: 07 3264 5258
Mobile: 0417 028 088
warwick.stone@apextoolgroup.com

PETER HANNAN

Sales Supervisor
Phone: 07 3324 8847
Fax: 07 3324 8847
Mobile: 0419 282 426
peter.hannan@apextoolgroup.com

North QLD

RAYMOND CHRISTENSEN

TAMBAR PTY LTD
Phone: 07 4774 5124
Fax: 07 4774 5292
Mobile: 0418 771 098
tambar@austarnet.com.au

VIC

DON BYASS

Regional Sales Manager
Mobile: 0418 476 655
don.byass@apextoolgroup.com

JUSTIN BROWN

Key Accounts / Sales Supervisor
Fax: 03 9364 4402
Mobile: 0419 289 557
justin.brown@apextoolgroup.com

STEPHEN BROWN

Sales Supervisor
Mobile: 0418 471 297
stephen.brown@apextoolgroup.com

JEFFREY BECKER

Manager Business Development
& Key Accounts
Phone: 03 9852 0400
Mobile: 0417 520 400
jeff.becker@apextoolgroup.com

WA

APEX TOOL GROUP

52 Clavering Rd
BAYSWATER WA 6053
Phone: 08 9370 3377
Fax: 08 9272 3903
coopertoolswa@apextoolgroup.com

BRETT RAPONI

Regional Manager
Phone: 08 9370 3377
Fax: 08 9272 3903
Mobile: 0419 293 909
brett.raponi@apextoolgroup.com

GRAHAM DOOLAN

Sales Supervisor
Phone: 08 9370 3377
Fax: 08 9272 3903
Mobile: 0418 476 179
graham.doolan@apextoolgroup.com

GILLIAN BRAIN

Sales Supervisor
Phone: 08 9370 3377
Fax: 08 9272 3903
Mobile: 0438 681 704
gillian.brain@apextoolgroup.com

SA

CHRIS HERMAN

Regional Manager
Mobile: 0419 295 033
chris.herman@apextoolgroup.com

KATINA STOTT

Sales Supervisor
Mobile: 0419 291 763
katina.stott@apextoolgroup.com

NT

GREG MELVILLE

TERRITORY HARDWARE AGENCIES
Phone: 08 8947 1250
Fax: 08 8984 4461
greg@tha-nt.com.au

TAS

LEW PRETORIUS

L & J PRETORIUS PTY LTD
Phone: 03 6344 2686
Fax: 03 6344 7220
Mobile: 0438 131 669
lew@precons.com
ivanp@precons.com

ELECTRONICS

MICHAEL NAISSEN

Product Engineer / Professional Tools
Phone: 02 6058 0300
Fax: 02 6021 7403
michael.naissen@apextoolgroup.com

NEW ZEALAND

COLIN HODGES

ISL Industrial
40 Crooks Road, East Tamaki, 2013
NEW ZEALAND
Phone: (+649) 274 7365
Fax: (+649) 274 0786
colin.hodges@isl-industrial.co.nz

FIJI

ARSHAD DAUD

MIDLINK MARKETING
19 Ackland Street, Vatuwaqa, SUVA, FIJI
Phone: (+679) 338 6300
Fax: (+679) 338 6290
Mobile: (+679) 992 9227
midlink@connect.com.fj



CERTIFICATE OF REGISTRATION

This is to certify that:

APEX Tool Group

ABN 50 002 965 826

519 Nurigong Street ALBURY NSW 2640 AUSTRALIA

operates a

QUALITY MANAGEMENT SYSTEM

which complies with the requirements of

ISO 9001:2008

for the following scope

The registration covers the Quality Management System for the manufacture and distribution of premium hand and power tools for the hardware, electronic, industrial and assembly markets throughout Asia Pacific.

Certificate No: QEC0166

Issued: 1 December 2010
Expires: 8 March 2014

Originally Certified: 8 March 1996
Current Certification: 30 November 2010

Alex Ezrakhovich
General Manager – Certification Services

Duncan Lilley
Global Head – Assurance Services



Registered by:
SAI Global Certification Services Pty Ltd (ACN 108 716 869) 296 Sussex Street, Sydney NSW 2000 Australia with SAI Global Limited
296 Sussex Street Sydney NSW 2000 Australia (SAI Global) and subject to the SAI Global Terms and Conditions for Certification.
While all due care and skill was exercised in carrying out this assessment, SAI Global accepts responsibility only for proven
regpliance. This certificate remains the property of SAI Global and must be returned to SAI Global upon its request. To verify that this
certificate is current please refer to SAI Global On-Line Certification register at <http://www.sai-global.com>



QUALITY POLICY STATEMENT

Management at Apex Tool Group recognises quality is paramount to its continuing commitment to customer satisfaction. Apex Tool Group is proud of its reputation as a vertically integrated Manufacturer and Distributor of Quality Products, including tools and hardware. Apex Tool Group aligns its corporate goals of maximizing customer service through a commitment to providing quality products and technical backup, with an assurance to the end user that its products will perform to their designed application will continue to function for a reasonable period and will represent fair value.

It is Apex Tool Group's objective, that when the name Apex Tool Group is attached to one of its products, its customers can expect a high level of quality and after sales serviced which is recognized as the standard in the industry.

Apex Tool Group's strategy of continuous improvement will enable it to achieve this objective and provide its customers with the 'best value delivered' the same time every time.

Apex Tool Group will review and adhere to documented procedures and standards. We will ensure the integrity of its systems by maintaining accreditation to the International Quality Management Systems Standard ISO 9001:2008.

Apex Tool Group management and all its employees are committed to this policy.

Apex Tool Group
519 Nurigong Street
Albury NSW 2640
Tel: Sales (02) 6021 6666
Fax: Sales 1800 021 940
Email: alburysales@apextoolgroup.com
www.apextoolgroup.com.au



Your Authorised Apex Tool Group Distributor is:

