



VERMONT TAP & DIE



GREENFIELD THREADING



Taps And Dies



**GREENFIELD
INDUSTRIES**

a product of

#GTCAT - August 2016



Greenfield Industries' tradition of excellence has stood the test of time. Since 1834 the mission remains the same, provide the highest quality cutting tools at the greatest value possible. As part of the TDC Group, that mission is easily fulfilled with direct access to the finest raw materials from our own mines. These materials are then refined in our own mills and made into the raw material used in manufacturing Greenfield's unparalleled drills, end mills, taps, dies and other specially manufactured tools.

This catalog showcases the range of taps available along with machining parameters. Various coatings are available for our taps designed for specific applications.

This catalog is also available to download at our website, www.gfii.com. There you will find catalogs and supplements to our other globally recognized brands.

For more information, contact our Customer Service at 800-348-2885 or by email at standard.distributors@gfii.com, or visit the our web site, www.gfii.com.

Greenfield is moving from 302 to 302A tap styles beginning August 1st, 2015. Look for this rolling change in your orders and continue to enjoy the superior quality and reliability you have always known in Greenfield!





VERMONT TAP & DIE



We are proud to announce the combination of our Greenfield Threading brand with Vermont Tap & Die. Greenfield Industries' centuries old **dedication** to our customers has brought these two products lines together, creating a **commitment** of high-quality taps and dies. This provides you, our customer, the confidence that you are receiving the quality and reliability you expect from the

Greenfield family of tools.

All taps in the Greenfield Threading line are designed to machine a broad range of materials and are manufactured out of premium high speed steel.

In the ever-changing demands of industry and technology, we are continuously researching and finding ways to provide our customers with **all of your cutting tool needs.**





Metal Cutting Safety

Information to read before using Greenfield Threading products —

Modern metalcutting operations involve high energy, high spindle or cutter speeds, and high temperatures and cutting forces. Hot, flying chips may be projected from the workpiece during metalcutting. Although advanced cutting tool materials are designed and manufactured to withstand the high cutting forces and temperatures that normally occur in these operations, they are susceptible to fragmenting in service, particularly if they are subjected to over-stress, severe impact, or otherwise abused. Therefore, precautions should be taken to adequately protect workers, observers, and equipment against hot, flying chips, fragmented cutting tools, broken workpieces, or other similar projectiles. Machines should be fully guarded and personal protective equipment should be used at all times.

When grinding advanced cutting tool materials, a suitable means for collection and disposal of dust, mist, or sludge should be provided. Overexposure to dust or mist containing metallic particles can be hazardous to health, particularly if exposure continues over an extended period of time, and may cause eye, skin, and mucous membrane irritation and temporary or permanent respiratory disease. Certain existing pulmonary and skin conditions may be aggravated by exposure to dust or mist. Adequate ventilation, respiratory protection, and eye protection should be provided when grinding, and workers should avoid breathing of and prolonged skin contact with dust or mist.

General Industry Safety and Health Regulations, Part 1910, U.S. Department of Labor, published in Title 29 of the Code of Federal Regulations should be consulted. Obtain a copy from Greenfield and read the applicable Material Safety Data Sheet before grinding.

Cutting tools are only one part of the worker /machine-tool system. Many variables exist in machining operations, including the metal removal rate; the workpiece size, shape, strength and rigidity; the chucking and fixturing; the load carrying capability of centers; the cutter and spindle speed and torque limitations; the holder and boring bar overhang; the available power; and the condition of the tooling and the machine. A safe metalcutting operation must take all of these variables, and others, into consideration.

Greenfield has no control over the end use of its products or the environment into which those products are placed. Greenfield urges that its customers adhere to the recommended standards of use of their metalcutting machines and tools, and that they follow procedures that ensure safe metalcutting operations. The information included throughout this catalog under the heading "Technical Data" and other recommendations on machining practices referred to herein are only advisory in nature and do not constitute representations or warranties and are not necessarily appropriate for any particular work environment or application.

TIN - TiCN

Recommendations

Surface Treatments for Taps

	Recommended Applications	Precautions
TiN (Titanium Nitride)	For ferrous and non-metallic materials: free-machining steels and irons, high tensile steels, tough machining steels, plastics, hard rubber, and fiber. The hard, smooth finish increases tool life, improves finish, and allows higher speeds.	Use with caution in titanium, titanium alloys, and aluminum die casting due to tendency to gall.
TiCN (Titanium Carbonitride)	For ferrous and non-ferrous materials: cast iron, aluminum, stainless steel, brass, abrasive materials, high-silicon automotive aluminum, glass-filled plastics, and composites. The hard, smooth finish increases tool life and improves finish.	Use with caution in titanium and titanium alloys due to tendency to gall.



Style Number	Description	Page
--------------	-------------	------

Machine Taps for Through or Blind Holes

HTHM	CNC Straight Flute Hand Tap for Cast Iron and Harder Materials	6
HTGP	General Purpose Straight Flute Hand Tap	7-9
HTGP / SPGP Sets	General Purpose Straight Flute Hand Tap Sets	10
HTGPL	General Purpose Left-Hand Straight Flute Hand Tap	11

Spiral Point Taps for Through Holes

SPS	CNC Spiral Point Tap for Steels and Stainless Steel	12
SPGP	General Purpose Spiral Point Tap	13-15
SPGPX	6" Extended Length General Purpose Spiral Point Tap	16
SPLS	Low Shear General Purpose Spiral Point Tap	17
SPAR	Spiral Point Tap for Aerospace Fasteners	18
SPHD	CNC Heavy-Duty Spiral Point	19

Spiral Flute Taps for Blind Holes

SFS	CNC Spiral Flute Tap for Steels and Stainless Steel	20
SFHD	CNC Heavy-Duty Spiral Flute Tap	21
SFGP	High-Spiral General Purpose Spiral Flute Tap	22

Thread Forming Taps

FTGP	General Purpose Thread Forming Tap	23
------	------------------------------------	----

Pipe Taps

PTT	NPT/NPTF Medium Hook Taper Pipe Tap	24
PTTI	NPT/NPTF Medium Hook Interrupted Thread Taper Pipe Tap	25
PTS	NPS/NPSM/NPSC and NPSF Medium Hook Straight Pipe	26
ELPTT	CNC Extra Length Medium Hook Taper Pipe Tap with Machine Tap Shank	27

Dies

377	Hexagon Rethreading Dies, Carbon Steel	28-29
382, 6382	Round Adjustable Dies, Carbon Steel and High-Speed Steel	30-32
1750, 1790	Die Stocks for Round Adjustable Dies	32
T&RAD Sets	Tap & Round Adjustable Die Set	33
1386	Little Giant® Two-Piece Die Systems	34-35
1381, 1382, A1	Accessories for Little Giant® Two-Piece Dies	36
300, 330	Tap Wrenches	37
335	Screw Extractors	38

Sets

All available / Cost Saving Sets	55-56
----------------------------------	-------

Index by Order Number

Full index	60-65
------------	-------

Technical Information

Tap / Drill Recommendations	4
Pipe Tap Recommendations	24
Tapping Speeds	39-41
Tap Nomenclature	42-43
Standard Tap Marking System	44
302 / 302A / 311 Standard Tap Dimensions	45-47
Thread Limits – Taper Pipe Taps – Ground Thread	47
Thread Limits – Fractional Taps – Ground Thread	48
Thread Limits – Machine Screw Taps – Ground Thread	49
Thread Limits – Metric Taps – Ground Thread	50
Basic Thread Dimensions – Fractional Sizes	51-52
Basic Thread Dimensions – Machine Screw Sizes	53
Quick Shipment Program – Special Taps – Ground Thread	54
Decimal Equivalent Chart	inside back cover

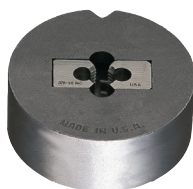
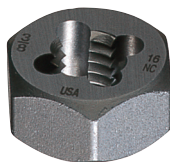



Color Code: Machine Screw, Fractional, and Metric Sizes

Tap Size & Pitch		Cutting Taps		Forming Taps	
		drill size	decimal inch	drill size	decimal inch
inch	metric				
0-80		3/64	.0469	54	.0550
	M1,6 x 0,35	1,25	.0492	1,45	.0571
	M1,8 x 0,35	1,45	.0571	1,65	.0650
1-64		53	.0595	51	.0670
1-72		53	.0595	51	.0670
	M2 x 0,4	1,6	.0630	1,8	.0709
2-56		50	.0700	5/64	.0781
2-64		50	.0700	47	.0785
	M2,2 x 0,45	1,75	.0689	2,0	.0787
	M2,5 x 0,45	2,05	.0807	2,3	.0906
3-48		47	.0785	43	.0890
3-56		46	.0810	2,3	.0906
4-40		43	.0890	38	.1015
4-48		42	.0935	2,6	.1024
	M3 x 0,5	2,5	.0984	7/64	.1094
5-40		38	.1015	33	.1130
5-44		37	.1040	2,9	.1142
	M3,5 x 0,6	2,9	.1142	3,2	.1260
6-32		36	.1065	1/8	.1250
6-40		33	.1130	3,25	.1280
	M4 x 0,7	3,3	.1299	3,7	.1457
8-32		29	.1360	25	.1495
8-36		29	.1360	24	.1520
	M4,5 x 0,75	3,7	.1457	4,1	.1614
10-24		26	.1470	11/64	.1719
10-32		21	.1590	16	.1770
	M5 x 0,8	4,2	.1654	14	.1820
12-24		16	.1770	8	.1990
12-28		15	.1800	7	.2010
	M6 x 1	5,0	.1969	7/32	.2188
1/4-20		7	.2010	1	.2280
1/4-28		3	.2130	15/64	.2340
	M7 x 1	6,0	.2362	F	.2570
5/16-18		F	.2570	L	.2900
5/16-24		I	.2720	M	.2950
	M8 x 1,25	6,7	.2638	7,4	.2913
	M8 x 1	7,0	.2756	19/64	.2969
3/8-16		5/16	.3125	S	.3480
3/8-24		Q	.3320	T	.3580
	M10 x 1,5	8,5	.3346	U	.3680
	M10 x 1,25	8,7	.3425	9,4	.3701
7/16-14		U	.3680	Y	.4040
7/16-20		25/64	.3906	Z	.4130

Tap Size & Pitch		Cutting Taps		Forming Taps	
		drill size	decimal inch	drill size	decimal inch
inch	metric				
	M12 x 1,75	10,2	.4016	11,2	.4409
	M12 x 1,25	10,8	.4252	11,5	.4528
1/2-13		27/64	.4219	15/32	.4688
1/2-20		29/64	.4531	12,25	.4823
	M14 x 2	12,0	.4724	33/64	.5156
9/16-12		31/64	.4844	17/32	.5312
9/16-18		33/64	.5156	13,5	.5315
5/8-11		17/32	.5312	14,75	.5807
5/8-18		37/64	.5781	15,25	.6004
	M16 x 2	14,0	.5512	19/32	.5938
	M16 x 1,5	14,5	.5709	15,25	.6004
	M18 x 2,5	15,5	.6102	39/64	.6094
	M18 x 1,5	16,5	.6496	17,25	.6791
3/4-10		21/32	.6562	45/64	.7031
3/4-16		11/16	.6875	23/32	.7188
	M20 x 2,5	17,5	.6890		
	M20 x 1,5	18,5	.7283		
	M22 x 2,5	19,5	.7677		
	M22 x 1,5	20,5	.8071		
7/8-9		49/64	.7656		
7/8-14		13/16	.8125		
	M24 x 3	21,0	.8268		
	M24 x 2	22,0	.8661		
1-8		7/8	.8750		
1-12		59/64	.9219		
	M27 x 3	24,0	.9449		
	M27 x 2	25,0	.9843		
1-1/8-7		63/64	.9844		
1-1/8-12		1-3/64	1.0469		
	M30 x 3,5	26,5	1.0433		
	M30 x 2	28,0	1.1024		
1-1/4-7		1-7/64	1.1094		
1-1/4-12		1-11/64	1.1719		
	M33 x 3,5	29,5	1.1614		
	M33 x 2	31,0	1.2205		
1-3/8-6		1-7/32	1.2188		
1-3/8-12		1-19/64	1.2969		
	M36 x 4	32,0	1.2598		
	M36 x 3	33,0	1.2992		
1-1/2-6		1-11/32	1.3438		
1-1/2-12		1-27/64	1.4219		
	M39 x 4	35,0	1.3780		
	M39 x 3	36,0	1.4173		

**FORM
TAPS
NOT
AVAILABLE
IN
THESE
SIZES**

✓ = BEST Performance * Also Suitable

Icon	Material	Hardness	Surface Treatment Suggestion		
			TiN	TiCN	TiAlN
M	Austenitic Stainless Steel	< 35 HRc		*	✓
	Martensitic Stainless Steel	< 35 HRc		*	✓
	Martensitic Stainless Steel	>= 35 HRc			✓
	PH Stainless Steel	< 35 HRc		*	✓
	PH Stainless Steel	<= 35 HRc		*	✓
S	Ni, Co, Fe Based Super Alloys				✓
	Titanium				✓
P	Alloy Steel	16-23 HRc	*	*	✓
	Alloy Steel	23-38 HRc	*	*	✓
	Alloy Steel	> 38 HRc		*	✓
	Carbon Steel	16-23 HRc	*	*	✓
	Carbon Steel	23-38 HRc	*	*	✓
	Carbon Steel	> 38 HRc		*	✓
	Low Carbon Steel	13-23 HRc	*	*	✓
	Low Carbon Steel	23-38 HRc	*	*	✓
	Low Carbon Steel	> 38 HRc		*	✓
K	Gray Cast Iron	18-22 HRc		*	✓
	Nodular Cast Iron	22-32 HRc	*	✓	
N	Aluminum	< 10% Si	*	✓	
	Aluminum	> 10% Si	*	✓	
H	Hardened Steel	>45 HRc		*	✓

Surface Treatment

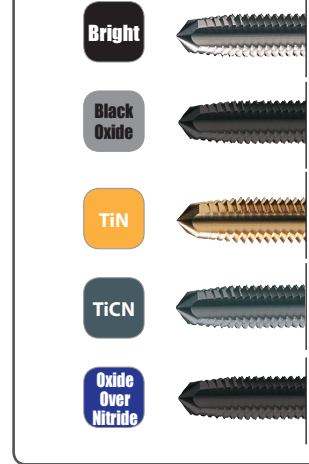

Additional treatments available upon request.

Base Material

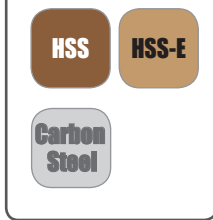

Applications

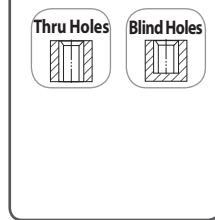

Geometry

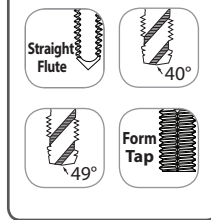

Chamfers

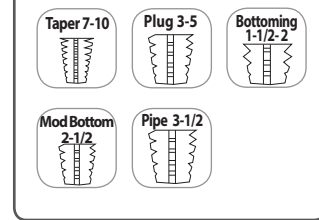

Styles

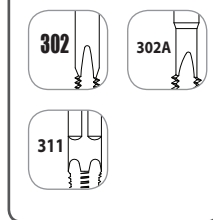

Pipe



CNC Straight Flute
Cast Iron and Harder Materials

Machine Tap for Through or Blind Holes



Style: **HTHM**

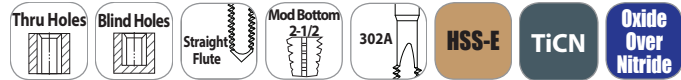

Note
Tapping speeds -
see page 39-41.

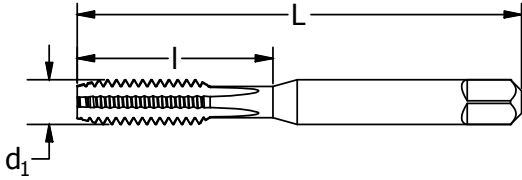

diameter & pitch	thread form	d ₁ in	number of flutes	H-limit	L in	I in	order number	
							Oxide over Nitride	TiCN
10-24	UNC	.1900	4	H3	2.375	.875	330259	—
10-32	UNF	.1900	4	H3	2.375	.875	330260	—
1/4-20	UNC	.2500	4	H3	2.500	1.000	330261	300216
1/4-20	UNC	.2500	4	H5	2.500	1.000	330278	—
1/4-28	UNF	.2500	4	H3	2.500	1.000	330262	—
5/16-18	UNC	.3125	4	H3	2.719	1.125	330263	300217
5/16-18	UNC	.3125	4	H5	2.719	1.125	330279	—
5/16-24	UNF	.3125	4	H3	2.719	1.125	330264	—
3/8-16	UNC	.3750	4	H3	2.938	1.250	330265	—
3/8-16	UNC	.3750	4	H5	2.938	1.250	330280	—
7/16-14	UNC	.4375	4	H3	3.156	1.438	330267	—
7/16-14	UNC	.4375	4	H5	3.156	1.438	330281	—
1/2-13	UNC	.5000	4	H3	3.375	1.656	330269	—
1/2-13	UNC	.5000	4	H5	3.375	1.656	330283	—
1/2-20	UNF	.5000	4	H5	3.375	1.656	330284	—
3/4-16	UNF	.7500	4	H5	4.250	2.000	330290	—

Metric - CNC Straight Flute
Cast Iron and Harder Materials

Style: **HTHM**

diameter & pitch	d ₁ mm	number of flutes	D-limit	L in	I in	order number	
						Oxide over Nitride	TiCN
M5 x 0.8	5.00	3	D4	2.375	.875	330291	—
M6 x 1	6.00	3	D5	2.500	1.000	330292	—
M8 x 1.25	8.00	4	D5	2.719	1.125	330293	—
M10 x 1.5	10.00	4	D6	2.938	1.250	330294	300218
M12 x 1.25	12.00	4	D6	3.375	1.656	330295	—
M12 x 1.75	12.00	4	D6	3.375	1.656	330296	300219
M14 x 1.5	14.00	4	D6	3.594	1.656	330298	—



Machine Tap for Through or Blind Holes

Style: **HTGP**

General Purpose
Straight Flute

P N

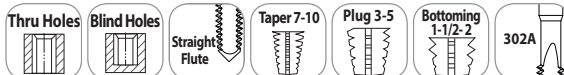

HSS Bright TiN TiCN Black Oxide

Note

Tapping speeds - see page 39-41.

Set consists of one each taper, plug, bottoming chamfer.

* #0 - #3 and 7/8" and larger: 302 blank style.

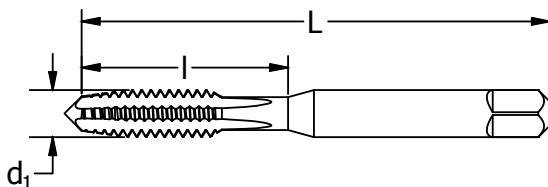

order number

diameter & pitch	thrd form	d ₁ in	no. flts	H-limit	L in	l in	taper		plug				bottoming		set	
							Bright	TiN	Bright	Oxide	TiN	TiCN	Bright	TiN	Bright	TiN
*0-80	UNF	.0600	2	H1	1.625	0.313	330004	—	330016	—	—	—	330066	—	—	—
*0-80	UNF	.0600	2	H2	1.625	0.313	—	—	300041	—	300047	—	300058	300054	—	—
*1-64	UNC	.0730	2	H1	1.688	0.375	330005	—	330017	—	—	—	330067	—	—	—
*1-72	UNF	.0730	2	H1	1.688	0.375	330006	—	300165	—	—	—	330068	—	—	—
*2-56	UNC	.0860	2	H2	1.750	0.438	—	—	330018	—	—	—	330069	—	—	—
*2-56	UNC	.0860	3	H1	1.750	0.438	330007	—	330019	—	—	—	300264	—	—	—
*2-56	UNC	.0860	3	H2	1.750	0.438	300272	300278	300280	—	300286	330035	300299	300294	341573	174511
*2-64	UNF	.0860	3	H2	1.750	0.438	330008	—	330020	—	—	—	330070	—	—	—
*3-48	UNC	.0990	3	H2	1.813	0.500	300512	339044	300520	—	300526	—	300538	339045	341599	355802
*3-56	UNF	.0990	3	H2	1.813	0.500	300637	339046	300645	—	339047	—	300652	339048	341607	355803
4-40	UNC	.1120	2	H1	1.875	0.563	—	—	330021	—	—	—	—	—	—	—
4-40	UNC	.1120	2	H2	1.875	0.563	—	—	300769	—	—	—	300778	—	—	—
4-40	UNC	.1120	3	H2	1.875	0.563	300819	300815	300827	—	300823	330036	300835	300831	341623	174530
4-48	UNF	.1120	3	H2	1.875	0.563	300934	300930	300942	—	300948	—	300959	300955	341649	174531
5-40	UNC	.1250	2	H2	1.938	0.625	—	—	301007	—	—	—	301015	—	—	—
5-40	UNC	.1250	3	H2	1.938	0.625	301056	301052	301064	—	301060	—	301072	301078	341664	174536
5-44	UNF	.1250	3	H2	1.938	0.625	301171	301177	301189	—	—	—	301197	301193	341672	174537
6-32	UNC	.1380	2	H2	2.000	0.688	—	—	301247	—	—	—	301254	—	—	—
6-32	UNC	.1380	2	H3	2.000	0.688	—	—	301270	—	—	—	301288	—	—	—
6-32	UNC	.1380	3	H2	2.000	0.688	301320	—	301338	—	330062	—	301346	—	341698	—
6-32	UNC	.1380	3	H3	2.000	0.688	301353	301359	301361	330037	301367	330038	301379	301375	341706	174538
6-40	UNF	.1380	3	H2	2.000	0.688	301478	301474	301486	—	301482	—	301494	301490	341714	174539
8-32	UNC	.1640	2	H1	2.125	0.750	—	—	330022	—	—	—	—	—	—	—
8-32	UNC	.1640	2	H2	2.125	0.750	—	—	301544	—	—	—	301551	—	—	—
8-32	UNC	.1640	2	H3	2.125	0.750	—	—	301577	—	—	—	301585	—	—	—
8-32	UNC	.1640	3	H2	2.125	0.750	—	—	301635	—	—	—	301643	—	—	—
8-32	UNC	.1640	3	H3	2.125	0.750	—	—	301668	—	—	—	301676	—	—	—
8-32	UNC	.1640	4	H2	2.125	0.750	301718	—	301726	—	330063	—	301734	—	341730	—
8-32	UNC	.1640	4	H3	2.125	0.750	301742	301748	301759	330039	301755	330040	301767	301763	341748	174544
8-36	UNF	.1640	4	H2	2.125	0.750	301924	301920	301933	—	301938	—	301940	301946	341755	174545

continued on next page

**General Purpose
Straight Flute**

Machine Tap for Through or Blind Holes

Style: HTGP (continued)



Machine Taps	diameter & pitch	thrd form	d ₁ in	no. flts	H-limit	L in	I in	order number									
								taper		plug				bottoming		set	
								Bright	TiN	Bright	Oxide	TiN	TiCN	Bright	TiN	Bright	TiN
	10-24	UNC	.1900	2	H2	2.375	0.875	—	—	301999	—	—	—	—	—	—	—
	10-24	UNC	.1900	2	H3	2.375	0.875	—	—	302021	—	—	—	302039	—	—	—
	10-24	UNC	.1900	3	H3	2.375	0.875	—	—	302112	—	—	—	302120	—	—	—
	10-24	UNC	.1900	4	H2	2.375	0.875	302161	—	302179	—	—	—	302187	—	341771	—
	10-24	UNC	.1900	4	H3	2.375	0.875	302195	302191	302203	330041	302209	330042	302211	302217	341789	174508
	10-32	UNF	.1900	2	H2	2.375	0.875	—	—	302260	—	—	—	302278	—	—	—
	10-32	UNF	.1900	2	H3	2.375	0.875	—	—	302294	—	—	—	302302	—	—	—
	10-32	UNF	.1900	3	H3	2.375	0.875	—	—	302385	—	330045	—	302393	—	—	—
	10-32	UNF	.1900	4	H2	2.375	0.875	302435	—	302443	—	—	—	302450	—	341805	—
	10-32	UNF	.1900	4	H3	2.375	0.875	302468	302464	302476	330043	302472	330044	302484	302480	341813	174509
	12-24	UNC	.2160	4	H3	2.375	0.938	302526	302522	302534	—	302530	—	302542	302548	341821	174510
	12-28	UNF	.2160	4	H3	2.375	0.938	302583	—	302591	—	330046	—	302609	—	341839	—
	1/4-20	UNC	.2500	2	H3	2.500	1.000	—	—	326004	—	—	—	326012	—	—	—
	1/4-20	UNC	.2500	3	H2	2.500	1.000	—	—	330024	—	—	—	—	—	—	—
	1/4-20	UNC	.2500	3	H3	2.500	1.000	—	—	326160	—	—	—	326178	—	—	—
	1/4-20	UNC	.2500	3	H5	2.500	1.000	—	—	330025	—	—	—	—	—	—	—
	1/4-20	UNC	.2500	4	H1	2.500	1.000	305008	—	305016	—	—	—	305024	—	330080	—
	1/4-20	UNC	.2500	4	H2	2.500	1.000	305033	—	305040	—	—	—	305057	—	342514	—
	1/4-20	UNC	.2500	4	H3	2.500	1.000	305065	305061	305073	330047	305079	330048	305081	305087	342522	174506
	1/4-20	UNC	.2500	4	H5	2.500	1.000	—	—	305107	—	305103	—	305115	305111	—	—
	1/4-20	UNC	.2500	4	H11	2.500	1.000	—	—	330026	—	—	—	—	—	—	—
	1/4-28	UNF	.2500	2	H3	2.500	1.000	—	—	326087	—	—	—	326095	—	—	—
	1/4-28	UNF	.2500	3	H3	2.500	1.000	—	—	326244	—	326240	—	326251	—	—	—
	1/4-28	UNF	.2500	4	H2	2.500	1.000	—	—	305198	—	—	—	305206	305209	—	—
	1/4-28	UNF	.2500	4	H3	2.500	1.000	305214	305210	305222	330049	305228	330051	305230	305236	342530	174507
	5/16-18	UNC	.3125	2	H3	2.719	1.125	—	—	326285	—	—	—	326293	—	—	—
	5/16-18	UNC	.3125	3	H3	2.719	1.125	—	—	326368	—	—	—	326376	—	—	—
	5/16-18	UNC	.3125	4	H2	2.719	1.125	—	—	305370	—	—	—	305388	—	—	—
	5/16-18	UNC	.3125	4	H3	2.719	1.125	305396	305392	305404	330052	305403	330053	305412	305418	342555	174532
	5/16-18	UNC	.3125	4	H5	2.719	1.125	—	—	305438	—	—	—	305446	—	—	—
	5/16-18	UNC	.3125	4	H11	2.719	1.125	—	—	330027	—	—	—	—	—	—	—
	5/16-24	UNF	.3125	3	H3	2.719	1.125	—	—	326442	—	—	—	326459	—	—	—
	5/16-24	UNF	.3125	4	H3	2.719	1.125	305511	305517	305529	—	305525	—	305537	305533	342563	174533
	5/16-24	UNF	.3125	4	H4	2.719	1.125	—	—	305552	—	—	—	305560	—	—	—
	3/8-16	UNC	.3750	3	H3	2.938	1.250	—	—	326525	—	326521	—	326533	326539	—	—
	3/8-16	UNC	.3750	4	H2	2.938	1.250	—	—	305677	—	—	—	305685	—	—	—
	3/8-16	UNC	.3750	4	H3	2.938	1.250	305693	305699	305701	330055	305707	330057	305719	305715	342589	174528
	3/8-16	UNC	.3750	4	H5	2.938	1.250	—	—	305735	—	305731	—	305743	305749	—	—
	3/8-24	UNF	.3750	3	H3	2.938	1.250	—	—	326608	—	—	—	326616	—	—	—
	3/8-24	UNF	.3750	4	H3	2.938	1.250	305818	305814	305826	330058	305822	—	305834	305830	342597	174529
	7/16-14	UNC	.4375	4	H3	3.156	1.438	305990	305996	306006	—	306002	—	306014	306010	342605	174540
	7/16-14	UNC	.4375	4	H5	3.156	1.438	—	—	306030	—	306036	—	306048	306044	—	—
	7/16-20	UNF	.4375	4	H3	3.156	1.438	306113	306119	306121	—	306127	—	306139	306135	342613	174541
	7/16-20	UNF	.4375	4	H5	3.156	1.438	—	—	306154	—	306157	—	306162	306165	—	—
	1/2-13	UNC	.5000	3	H3	3.375	1.656	—	—	326681	—	—	—	326699	—	—	—
	1/2-13	UNC	.5000	4	H1	3.375	1.656	—	—	306246	—	—	—	—	—	—	—
	1/2-13	UNC	.5000	4	H3	3.375	1.656	306295	306291	306303	330059	306309	330060	306311	306317	342621	174504
	1/2-13	UNC	.5000	4	H5	3.375	1.656	—	—	306337	—	—	—	306345	306341	—	—
	1/2-20	UNF	.5000	3	H3	3.375	1.656	—	—	326707	—	—	—	—	—	—	—
	1/2-20	UNF	.5000	4	H3	3.375	1.656	306444	306440	306451	—	306457	—	306469	306465	342639	174505
	1/2-20	UNF	.5000	4	H5	3.375	1.656	—	—	306485	—	—	—	—	—	—	—
	9/16-12	UNC	.5625	4	H3	3.594	1.656	306626	306622	306634	—	306630	—	306642	306648	342647	174546
	9/16-18	UNF	.5625	4	H3	3.594	1.656	306741	—	306758	—	306754	—	306766	306762	342654	—

continued on next page



Machine Tap for Through or Blind Holes

Style: **HTGP** (continued)

General Purpose
Straight Flute

diameter & pitch	thrd form	d ₁ in	no. flts	H- limit	L in	I in	order number									
							taper		plug		bottoming		set			
							Bright	TiN	Bright	Oxide	TiN	TiCN	Bright	TiN	Bright	TiN
5/8-11	UNC	.6250	4	H3	3.813	1.813	306923	306929	306931	330061	306937	—	306949	306945	342662	174534
5/8-11	UNC	.6250	4	H5	3.813	1.813	—	—	306964	—	—	—	306972	306978	—	—
5/8-18	UNF	.6250	4	H3	3.813	1.813	307046	307042	307053	—	307059	—	307061	307067	342670	174535
11/16-11	UNS	.6875	4	H3	4.031	1.813	307160	—	307178	—	—	—	307186	—	342688	—
11/16-16	UNS	.6875	4	H3	4.031	1.813	307194	—	307202	—	—	—	307210	—	342696	—
3/4-10	UNC	.7500	4	H3	4.250	2.000	307343	307349	307350	—	307356	—	307368	307364	342704	174513
3/4-16	UNF	.7500	4	H3	4.250	2.000	307467	307463	307475	—	307471	—	307483	307489	342712	174514
*7/8-9	UNC	.8750	4	H4	4.468	2.219	307707	307703	307715	—	307711	—	307723	307729	342720	174543
*7/8-14	UNF	.8750	4	H4	4.468	2.219	307822	307828	307830	—	307836	—	307848	307844	342738	174542
*1-8	UNC	1.0000	4	H4	5.125	2.500	308069	308065	308077	—	308073	—	308085	308081	342746	174503
*1-12	UNF	1.0000	4	H4	5.125	2.500	308184	—	308192	—	330065	—	308200	—	—	—
*1-14	UNS	1.0000	4	H4	5.125	2.500	308275	—	308283	—	—	—	308291	—	342761	—
*1-1/8-7	UNC	1.1250	4	H4	5.438	2.563	308424	—	308432	—	—	—	308440	—	—	—
*1-1/8-12	UNF	1.1250	4	H4	5.438	2.563	308457	—	308465	—	—	—	308473	—	—	—
*1-1/4-7	UNC	1.2500	4	H4	5.750	2.563	308549	—	308556	—	—	—	308564	—	—	—
*1-1/4-12	UNF	1.2500	6	H4	5.750	2.563	308572	—	308580	—	—	—	308598	—	—	—
*1-3/8-6	UNC	1.3750	4	H4	6.063	3.000	—	—	308671	—	—	—	—	—	—	—
*1-3/8-12	UNF	1.3750	6	H4	6.063	3.000	—	—	308705	—	—	—	308713	—	—	—
*1-1/2-6	UNC	1.5000	4	H4	6.375	3.000	308788	—	308796	—	—	—	308804	—	—	—
*1-1/2-12	UNF	1.5000	6	H4	6.375	3.000	308812	—	308820	—	—	—	308838	—	—	—

Style: **HTGP**

Metric - General Purpose
Straight Flute

diameter & pitch	d ₁ mm	no. flts	D- limit	L in	I in	order number							
						taper		plug		bottoming		set	
						Bright	TiN	Bright	TiN	Bright	TiN	Bright	TiN
M1.6 x 0.35	1.60	2	D3	1.625	.313	—	—	328018	—	330071	—	—	—
M2 x 0.4	2.00	3	D3	1.750	.438	328067	328684	328075	328685	328083	328686	174516	343502
M2.5 x 0.45	2.50	3	D3	1.813	.500	328158	328688	328166	328689	328174	328690	174559	343503
M3 x 0.5	3.00	3	D3	1.938	.625	328182	328691	328190	328188	328208	328205	174519	343504
M3.5 x 0.6	3.50	3	D4	2.000	.688	328240	—	328257	328693	328265	—	174560	—
M4 x 0.7	4.00	4	D4	2.125	.750	328273	328695	328281	328287	328299	328295	174520	343506
M4.5 x 0.75	4.50	4	D4	2.375	.875	328331	—	328349	328697	328356	—	174561	—
M5 x 0.8	5.00	4	D4	2.375	.875	328364	328698	328372	328378	328380	328386	174521	343508
M6 x 1.0	6.00	4	D5	2.500	1.000	328422	328699	328430	328436	328448	328444	174522	343509
M7 x 1.0	7.00	4	D5	2.719	1.125	330009	—	328497	—	330072	—	—	—
M8 x 1.0	8.00	4	D5	2.719	1.125	330010	—	330028	—	330073	—	—	—
M8 x 1.25	8.00	4	D5	2.719	1.125	328547	328703	328554	328550	328562	328568	174524	343511
M10 x 1.25	10.00	4	D5	2.938	1.250	330011	—	330029	—	330074	—	—	—
M10 x 1.5	10.00	4	D6	2.938	1.250	328604	328704	328612	328618	328620	328626	174548	343512
M12 x 1.25	12.00	4	D5	3.375	1.656	330012	—	330030	—	330075	—	—	—
M12 x 1.75	12.00	4	D6	3.375	1.656	328661	328705	328679	328675	328687	328683	174549	343513
M14 x 1.5	14.00	4	D6	3.594	1.656	330013	—	330031	—	330076	—	—	—
M14 x 2.0	14.00	4	D7	3.594	1.656	328752	328706	328760	328707	328778	328708	174550	343514
M16 x 1.5	16.00	4	D6	3.813	1.813	330014	—	330032	—	330077	—	—	—
M16 x 2.0	16.00	4	D7	3.813	1.813	328810	328709	328828	328710	328836	328711	174551	343515
M18 x 1.5	18.00	4	D6	4.031	1.813	330015	—	330033	—	—	—	—	—
M18 x 2.5	18.00	4	D7	4.031	1.813	328877	—	328885	—	328893	—	174552	—
M20 x 1.5	20.00	4	D6	4.469	2.000	—	—	330034	—	330078	—	—	—
M20 x 2.5	20.00	4	D7	4.469	2.000	328935	—	328943	328716	328950	328717	174553	—
M24 x 3.0	24.00	4	D8	4.906	2.219	329057	—	329065	328719	329073	328720	—	—
M30 x 3.5	30.00	4	D9	5.438	2.563	—	—	329180	—	—	—	—	—



Machine Taps

303SET Plug Hand Tap Set (10-Piece)

style	sizes	order number
H3, 4 Flute	1/4-20, 1/4-28, 5/16-18, 5/16-24, 3/8-16, 3/8-24, 7/16-14, 7/16-20, 1/2-13, 1/2-20	330082

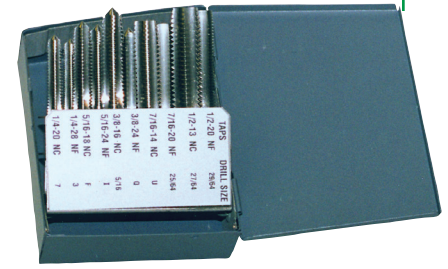

Spiral Point Taps

HT18 Jobber Drill, Plug Hand Tap Set (18-Piece)

style	sizes	order number
Jobber (Bright)	5/16, 27/64, LET-F, LET-U, #7, #21, #25, #29, #36	330083
H3, 4 Flute	1/4-20, 5/16-18, 3/8-16, 7/16-14, 1/2-13, 6-32, 8-32, 10-24, 10-32	

Spiral Flute Taps

HT18T Jobber Drill, Plug Hand Tap Set - TiN (18-Piece)

style	sizes	order number
Jobber (Titanium)	5/16, 27/64, #7, #21, #25, #29, #36, LET-F, LET-U	330084
H3, 4 Flute	1/4-20, 5/16-18, 3/8-16, 7/16-14, 1/2-13, 6-32, 8-32, 10-24, 10-32	

Thread Forming Taps

GT18 Jobber Drill, Plug Spiral PT Tap Set (18-Piece)

style	sizes	order number
Jobber (Bright)	5/16, 27/64, LET-F, LET-U, #7, #21, #25, #29, #36	330085
H3, 2 Flute	1/4-20, 5/16-18, 6-32, 8-32, 10-24, 10-32	
H3, 3 Flute	3/8-16, 7/16-14, 1/2-13	

Pipe Taps

HT36 Jobber Drill, Plug NC/NF Hand Tap Set (36-Piece)

style	sizes	order number
Jobber (Bright)	5/16, 25/64, 27/64, 29/64, LET-F, LET-I, LET-Q, LET-U, #3, #7, #15, #16, #21, #25, #29, #33, #36	330086
H2, 3 Flute	6-40	
H2, 4 Flute	8-36	
H3, 3 Flute	6-32	
H3, 4 Flute	1/4-20, 1/4-28, 5/16-18, 5/16-24, 3/8-16, 3/8-24, 7/16-14, 7/16-20, 1/2-13, 1/2-20, 8-32, 10-24, 10-32, 12-24, 12-28,	

Dies

Technical Info

68 Screw Machine Drill, Plug Hand Tap Set (20-Piece)

style	sizes	order number
Screw Mach (Bright)	5/16, 27/64, #7, #25, #29, #36, #39, #44, LET-F, LET-U	330087
H2, 3 Flute	4-40, 5-40	
H3, 3 Flute	6-32	
H3, 4 Flute	1/4-20, 5/16-18, 3/8-16, 7/16-14, 1/2-13, 8-32, 10-24	

Sets

HM18 Jobber Drill, Plug Hand Tap Set (18-Piece)

style	sizes	order number
Jobber (Black Oxide)	2.05, 2.50, 2.90, 3.30, 4.20, 5.00, 6.70, 8.5, 10.20	330088
D3, 3 Flute	M2.5x0.45, M3x0.5	
D4, 3 Flute	M3.5x0.6, M4x0.7,	
D4, 4 Flute	M5x0.8	
D5, 4 Flute	M6X1.0, M8X1.25,	
D6, 4 Flute	M10x1.5, M12x1.75	

Index



Machine Tap for Through or Blind Holes

Style: **HTGPL**

General Purpose Left-Hand
Straight Flute



Note
Tapping speeds - see
page 39-41.

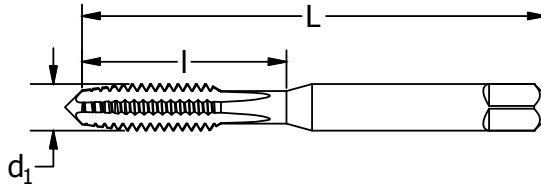
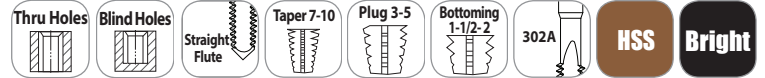

diameter & pitch	thread form	d ₁ in	number of flutes	H-limit	L in	l in	order number			
							taper Bright	plug Bright	bottoming Bright	set taper/plug/bottom
6-32	UNC	.1380	3	H3	2.000	.688	—	313010	313028	—
8-32	UNC	.1640	4	H3	2.125	.750	313036	313044	313051	341912
10-24	UNC	.1900	4	H3	2.375	.875	313069	313077	313085	—
10-32	UNF	.1900	4	H3	2.375	.875	313093	313102	313119	341938
1/4-20	UNC	.2500	4	H3	2.500	1.000	—	317516	—	—
1/4-28	UNF	.2500	4	H3	2.500	1.000	317532	317540	317557	318779
5/16-18	UNC	.3125	4	H3	2.719	1.125	—	317573	—	—
5/16-24	UNF	.3125	4	H3	2.719	1.125	—	317607	—	—
3/8-16	UNC	.3750	4	H3	2.938	1.250	—	317631	—	—
3/8-24	UNF	.3750	4	H3	2.938	1.250	—	317664	—	—
7/16-20	UNF	.4375	4	H3	3.156	1.438	—	317722	—	—
1/2-13	UNC	.5000	4	H3	3.375	1.656	—	317755	—	—
1/2-20	UNF	.5000	4	H3	3.375	1.656	—	317789	—	—
5/8-18	UNF	.6250	4	H3	3.813	1.813	—	317904	—	—
3/4-10	UNC	.7500	4	H3	4.250	2.000	—	317995	—	—
3/4-16	UNF	.7500	4	H3	4.250	2.000	—	318027	—	—

Machine Taps

Spiral Point Taps

Spiral Flute Taps

Thread Forming Taps

Pipe Taps

Dies

Technical Info

Sets

Index



Note
Tapping speeds - see page 39-41.

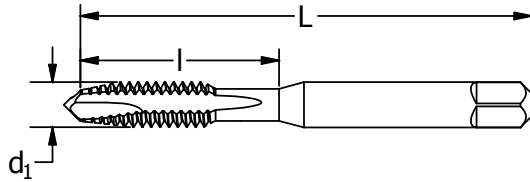

diameter & pitch	thread form	d ₁ in	number of flutes	H-limit	L in	I in	order number
4-40	UNC	.1120	2	H2	1.875	.563	330302
6-32	UNC	.1380	2	H3	2.000	.688	330309
8-32	UNC	.1640	3	H3	2.125	.750	330310
8-32	UNC	.1640	3	H5	2.125	.750	330333
10-24	UNC	.1900	3	H3	2.375	.875	330311
10-32	UNF	.1900	3	H3	2.375	.875	330312
1/4-20	UNC	.2500	3	H3	2.500	1.000	330313
1/4-20	UNC	.2500	3	H5	2.500	1.000	330336
5/16-18	UNC	.3125	3	H3	2.719	1.125	330315
5/16-24	UNF	.3125	3	H3	2.719	1.125	330316
3/8-16	UNC	.3750	3	H3	2.938	1.250	330317
1/2-13	UNC	.5000	3	H3	3.375	1.656	330321

Tech Tip

How to request Made-to-Order taps:

Information required for every order:

- quantity
- ordering number

Information required for some orders, depending on tool style:

- exact tool size
- threads per inch
- pitch
- thread form
- right-hand or left-hand configuration
- limit
- pitch diameter
- class of fit
- chamfer
- number of chamfered threads
- chamfer angle
- number of lube grooves
- short projections

Other features available:

- surface treatment
- special hook
- male centers removed
- special back tape
- recessed neck
- shank flats
- special shank diameter
- special rake
- thread relief
- interrupted threads
- controlled root
- ETTCO notch
- shank grooves



Spiral Point Taps for Through Holes

Style: **SPGP**

General Purpose
Spiral Point

P **N**



HSS

Bright

TiN

TiCN

Black Oxide

Note

Tapping speeds - see page 39-41.

* #0 - #3: 302 blank style.

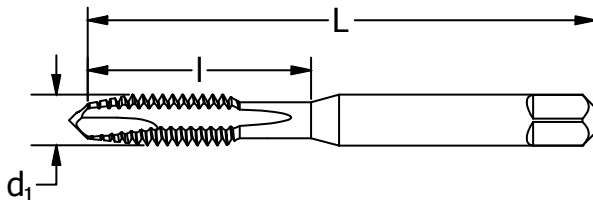

diameter & pitch	thread form	d ₁ in	# of flutes	H-limit	L in	l in	order number					
							plug				bottoming	
							Bright	Black Oxide	TiN	TiCN	Bright	TiN
*0-80	UNF	.0600	2	H1	1.625	.313	356002	—	—	—	—	—
*0-80	UNF	.0600	2	H2	1.625	.313	356027	330100	360023	330148	356035	—
*1-64	UNC	.0730	2	H2	1.688	.375	356068	—	356061	—	—	—
*1-72	UNF	.0730	2	H1	1.688	.375	356084	—	—	—	—	—
*1-72	UNF	.0730	2	H2	1.688	.375	356102	—	356106	—	—	—
*2-56	UNC	.0860	2	H2	1.750	.438	356142	330101	356148	330149	356159	—
*2-64	UNF	.0860	2	H2	1.750	.438	356183	—	—	—	—	—
*3-48	UNC	.0990	2	H2	1.813	.500	356225	—	356221	—	—	—
*3-56	UNF	.0990	2	H2	1.813	.500	356266	—	356262	—	—	—
4-40	UNC	.1120	2	H1	1.875	.563	356308	—	—	—	—	—
4-40	UNC	.1120	2	H2	1.875	.563	356324	330102	356320	330150	356332	356338
4-48	UNF	.1120	2	H2	1.875	.563	356365	—	356361	—	—	—
5-40	UNC	.1250	2	H2	1.938	.625	356407	330103	356403	330151	356415	—
6-32	UNC	.1380	2	H1	2.000	.688	356421	—	—	—	—	—
6-32	UNC	.1380	2	H2	2.000	.688	356422	330104	356486	—	356498	—
6-32	UNC	.1380	2	H3	2.000	.688	356506	330105	356502	330152	356514	356510
6-32	UNC	.1380	2	H7	2.000	.688	359005	—	—	—	—	—
6-40	UNF	.1380	2	H2	2.000	.688	356548	—	356544	—	—	—
8-32	UNC	.1640	2	H2	2.125	.750	356589	330106	356858	—	—	—
8-32	UNC	.1640	2	H3	2.125	.750	356633	330107	356602	330153	356634	356635
8-32	UNC	.1640	2	H7	2.125	.750	359047	—	330138	—	—	—
8-36	UNF	.1640	2	H2	2.125	.750	356647	—	330139	—	—	—
10-24	UNC	.1900	2	H1	2.375	.875	356662	—	—	—	—	—
10-24	UNC	.1900	2	H2	2.375	.875	356688	—	330140	—	—	—
10-24	UNC	.1900	2	H3	2.375	.875	356704	—	356703	330154	356712	356718
10-24	UNC	.1900	2	H7	2.375	.875	359088	—	330141	—	—	—
10-32	UNF	.1900	2	H2	2.375	.875	356746	—	356742	—	—	—
10-32	UNF	.1900	2	H3	2.375	.875	356761	—	356767	330155	356779	356775
10-32	UNF	.1900	2	H7	2.375	.875	359120	—	330142	—	—	—
12-24	UNC	.2160	2	H3	2.375	.938	356803	330108	356809	330156	—	—
12-28	UNF	.2160	2	H3	2.375	.938	356845	—	356841	—	—	—

continued on next page

**General Purpose
Spiral Point**

Spiral Point Taps for Through Holes

Style: SPGP (continued)



Machine
Taps

Spiral Point
Taps

Spiral Flute
Taps

Thread Forming
Taps

Pipe Taps

Dies

Technical Info

Sets

Index

diameter & pitch	thread form	d ₁ in	# of flutes	H- limit	L in	I in	order number							
							plug				bottoming			
							Bright	Black Oxide	TiN	TiCN	Bright	TiN		
1/4-20	UNC	.2500	2	H1	2.500	1.000	357009	—	330143	—	—	—		
1/4-20	UNC	.2500	2	H2	2.500	1.000	357025	330109	357021	—	—	—		
1/4-20	UNC	.2500	2	H3	2.500	1.000	357041	330110	357047	—	357058	357054		
1/4-20	UNC	.2500	2	H5	2.500	1.000	357066	—	357062	—	—	—		
1/4-20	UNC	.2500	2	H11	2.500	1.000	330111	—	—	—	—	—		
1/4-20	UNC	.2500	3	H3	2.500	1.000	357082	330112	357088	330157	—	—		
1/4-20	UNC	.2500	3	H5	2.500	1.000	357108	—	357101	—	—	—		
1/4-20	UNC	.2500	3	H13	2.500	1.000	358494	—	358490	—	—	—		
1/4-28	UNF	.2500	2	H2	2.500	1.000	330113	—	—	—	—	—		
1/4-28	UNF	.2500	2	H3	2.500	1.000	357165	330114	357161	—	357173	357179		
1/4-28	UNF	.2500	3	H2	2.500	1.000	330115	—	—	330158	—	—		
5/16-18	UNC	.3125	2	H1	2.719	1.125	357249	—	—	—	—	—		
5/16-18	UNC	.3125	2	H2	2.719	1.125	357264	—	330144	—	—	—		
5/16-18	UNC	.3125	2	H3	2.719	1.125	357280	330116	357286	—	357298	357294		
5/16-18	UNC	.3125	2	H5	2.719	1.125	357306	—	330145	—	—	—		
5/16-18	UNC	.3125	3	H3	2.719	1.125	357322	330117	357328	330159	300016	—		
5/16-18	UNC	.3125	3	H5	2.719	1.125	357348	—	357344	—	—	—		
5/16-18	UNC	.3125	3	H13	2.719	1.125	358510	—	—	—	—	—		
5/16-24	UNF	.3125	2	H1	2.719	1.125	357363	—	—	—	—	—		
5/16-24	UNF	.3125	2	H3	2.719	1.125	357405	330118	357401	—	357413	—		
5/16-24	UNC	.3125	3	H4	2.719	1.125	330119	—	—	330160	—	—		
3/8-16	UNC	.3750	3	H2	2.938	1.250	357504	—	330146	—	—	—		
3/8-16	UNC	.3750	3	H3	2.938	1.250	357520	330120	357526	330161	—	—		
3/8-16	UNC	.3750	3	H5	2.938	1.250	357546	—	357542	—	—	—		
3/8-24	UNF	.3750	3	H1	2.938	1.250	357561	—	—	—	—	—		
3/8-24	UNF	.3750	3	H2	2.938	1.250	357587	—	—	—	—	—		
3/8-24	UNF	.3750	3	H3	2.938	1.250	357603	330121	357609	330162	—	—		
3/8-24	UNF	.3750	3	H4	2.938	1.250	357629	—	—	—	—	—		
7/16-14	UNC	.4375	3	H2	3.156	1.438	357660	—	—	—	—	—		
7/16-14	UNC	.4375	3	H3	3.156	1.438	357686	330122	357682	—	—	—		
7/16-14	UNC	.4375	3	H5	3.156	1.438	357702	—	—	—	—	—		
7/16-20	UNF	.4375	3	H3	3.156	1.438	357769	—	357765	330163	—	—		
7/16-20	UNF	.4375	3	H5	3.156	1.438	357785	—	—	—	—	—		
1/2-13	UNC	.5000	3	H2	3.375	1.656	357819	—	—	—	—	—		
1/2-13	UNC	.5000	3	H3	3.375	1.656	357827	330123	357823	330164	—	—		
1/2-13	UNC	.5000	3	H5	3.375	1.656	357835	—	357831	—	—	—		
1/2-20	UNF	.5000	3	H3	3.375	1.656	357868	330125	357864	330165	—	—		
5/8-11	UNC	.6250	3	H3	3.813	1.813	357926	330126	357922	330166	—	—		
5/8-11	UNC	.6250	3	H5	3.813	1.813	357934	—	357930	—	—	—		
5/8-18	UNF	.6250	3	H3	3.813	1.813	357942	330128	—	—	—	—		
3/4-10	UNC	.7500	3	H3	4.250	2.000	357967	330129	357963	330167	—	—		
3/4-10	UNC	.7500	3	H5	4.250	2.000	357975	—	—	—	—	—		
3/4-16	UNF	.7500	3	H3	4.250	2.000	330130	—	—	—	—	—		

metric sizes listed on next page



diameter & pitch	d ₁ mm	number of flutes	D- limit	L in	I in	order number		
						Bright	plug TiN	TiCN
M1.6 x 0.35	1.60	2	D3	1.625	.313	360755	—	—
M1.8 x 0.35	1.80	2	D3	1.688	.375	330131	—	—
M2 x 0.4	2.00	2	D3	1.750	.438	360771	360774	—
M2.2 x 0.45	2.20	2	D3	1.750	.438	330132	—	—
M2.5 x 0.45	2.50	2	D3	1.813	.500	360797	—	—
M3 x 0.5	3.00	2	D3	1.938	.625	360805	360801	330168
M3.5 x 0.6	3.50	2	D4	2.000	.688	360821	—	—
M4 x 0.7	4.00	2	D4	2.125	.750	360839	360835	330169
M4.5 x 0.75	4.50	2	D4	2.375	.875	360854	—	—
M5 x 0.8	5.00	2	D4	2.375	.875	360862	360868	330170
M6 x 1.0	6.00	2	D5	2.500	1.000	360888	360884	330171
M7 x 1.0	7.00	2	D5	2.719	1.125	360904	—	—
M8 x 1.0	8.00	2	D5	2.719	1.125	330133	—	—
M8 x 1.25	8.00	2	D5	2.719	1.125	360920	360926	330172
M10 x 1.25	10.00	3	D5	2.938	1.250	330134	—	—
M10 x 1.5	10.00	3	D6	2.938	1.250	360946	360942	330173
M12 x 1.25	12.00	3	D5	3.375	1.656	330135	330147	—
M12 x 1.75	12.00	3	D6	3.375	1.656	360961	360967	330174
M14 x 1.5	14.00	3	D6	3.594	1.656	330136	—	—
M14 x 2	14.00	3	D7	3.594	1.656	360995	—	—
M16 x 1.5	16.00	3	D6	3.813	1.813	330137	—	—
M16 x 2	16.00	3	D7	3.813	1.813	361019	—	—
M20 x 2.5	20.00	3	D7	4.469	2.000	361050	—	—

Machine Taps
Spiral Point Taps
Spiral Flute Taps
Thread Forming Taps
Pipe Taps

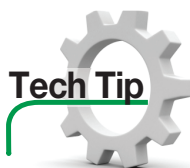

The Proper Use of Lubricants in Tapping

Applying the proper lubricants in tapping operations can result in longer tap life, increased production, better workpiece size control, smoother and more accurate threads, less resharping, and more efficient chip removal. Generally, for best tap performance, straight cutting oil should be used. For non-ferrous and non-metallic materials, a coolant or a cutting fluid (light oil or soluble oil) is recommended.

Often, machining centers are equipped with a coolant or a cutting fluid that contains enough water and oil to provide adequate cooling and lubrication for a variety of tools and workpieces. However, most soluble blends are not suitable for tapping applications. Tapping, especially with thread-forming taps, requires more lubrication than cooling. A coolant or cutting fluid might lack the lubrication necessary to obtain acceptable tool life and part finish. Get recommendations from a coolant specialist.

After you select the proper lubricant, choose the right method of application and pressure. For tapping, use multiple nozzles around the tap. Nozzles should be as close to the surface of the part as possible, positioned at an angle close to the axis of the tool, and should point directly into the hole to flush chips from the flutes. For

horizontal tapping, where the tap is stationary and the workpieces rotate, consider using two streams of lubricant, one on each side of the tap.

Whether you are tapping vertically, horizontally, or at an angle, make sure the lubricant reaches the cutting lands of the tap at all times, especially at the point or chamfered sections. Brushing or squirting oil or fluid onto the tap does not provide sufficient lubrication. In fact, heavy viscosity oil may cause the chips to stick or cling to a tap, increasing the chance of breakage. In addition, if the lubricant is automatically applied only on the forward motion of the tap, time the application of the lubricant so that it will reach the hole before the tap starts to cut, particularly with machines on which the cutting fluid is automatically shut off when the tap reverses. For maximum effectiveness, it is better to force the lubricant into the hole under pressure, which will vary depending on the tapping method, hole depth, and tapping speed.

Keep tapping lubricants as clean as possible using a filtering system or other equipment. Dust and other foreign particles can contaminate oil and decrease its effectiveness. Thoroughly clean machines and oil tanks when adding new lubricant and at regular intervals to ensure optimum results.

Dies
Technical Info
Sets
Index

General Purpose
Extended Length (6")

Spiral Point Taps for Through Holes

Style: **SPGPX**



Note
Tapping speeds - see page 39-41.

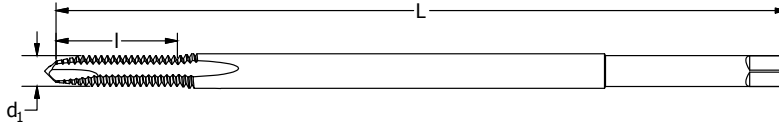

diameter & pitch	thread form	d ₁ in	number of flutes	H-limit	L in	I in	order number
8-32	UNC	.1640	2	H3	6.000	.750	918932
10-24	UNC	.1900	2	H3	6.000	.875	918934
10-32	UNF	.1900	2	H3	6.000	.875	918935
1/4-20	UNC	.2500	2	H3	6.000	1.000	918936
1/4-28	UNF	.2500	2	H3	6.000	1.000	918937
5/16-18	UNC	.3125	2	H3	6.000	1.125	918938
5/16-24	UNF	.3125	2	H3	6.000	1.125	918939
3/8-16	UNC	.3750	3	H3	6.000	1.250	918940
3/8-24	UNF	.3750	3	H3	6.000	1.250	918941



Spiral Point Taps for Through Holes

Style: **SPLS**

General Purpose
Low Shear

P N

Note
Tapping speeds - see page 39-41.

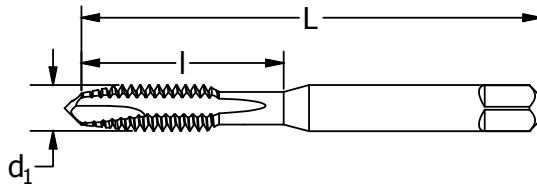

diameter & pitch	thread form	d ₁ in	number of flutes	H-limit	L in	I in	order number
4-40	UNC	.1120	2	H2	1.875	.563	330175
5-40	UNC	.1250	2	H2	1.938	.625	330176
6-32	UNC	.1380	2	H3	2.000	.688	330177
8-32	UNC	.1640	2	H3	2.125	.750	330178
10-24	UNF	.1900	2	H3	2.375	.875	330179
10-32	UNC	.1900	2	H3	2.375	.875	330180
12-24	UNC	.2160	2	H3	2.375	.938	330181
1/4-20	UNC	.2500	2	H1	2.500	1.000	330182
1/4-20	UNC	.2500	2	H2	2.500	1.000	330183
1/4-20	UNC	.2500	2	H3	2.500	1.000	330184
1/4-20	UNC	.2500	2	H11	2.500	1.000	330185
1/4-28	UNF	.2500	2	H3	2.500	1.000	330186
5/16-18	UNC	.3125	2	H3	2.719	1.125	330187
5/16-24	UNF	.3125	2	H3	2.719	1.125	330188
3/8-16	UNC	.3750	3	H3	2.938	1.250	330189
7/16-14	UNC	.4375	3	H3	3.156	1.438	330190
1/2-13	UNC	.5000	3	H3	3.375	1.656	330191
5/8-11	UNC	.6250	3	H3	3.813	1.813	330192

Machine Taps

Spiral Point Taps

Spiral Flute Taps

Thread Forming Taps

Pipe Taps

Dies

Technical Info

Sets

Index



Note
Tapping speeds - see page 39-41.

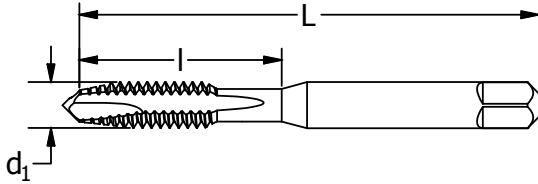

diameter & pitch	thread form	d ₁ in	number of flutes	H-limit	L in	I in	order number plug - TiN
6-32	UNC	.1380	3	H3	2.000	.688	285057
8-32	UNC	.1640	3	H3	2.125	.750	285107
10-24	UNC	.1900	3	H3	2.375	.875	285156
10-32	UNF	.1900	3	H3	2.375	.875	285206
10-32	UNF	.1900	3	H5	2.375	.875	285222
1/4-20	UNC	.2500	3	H3	2.500	1.000	285255
1/4-28	UNF	.2500	3	H3	2.500	1.000	285354
1/4-28	UNF	.2500	3	H5	2.500	1.000	285370
5/16-18	UNC	.3125	3	H3	2.719	1.125	285404
5/16-24	UNF	.3125	3	H3	2.719	1.125	285453
5/16-24	UNF	.3125	3	H5	2.719	1.125	285479
3/8-16	UNC	.3750	3	H3	2.938	1.250	285503
3/8-16	UNC	.3750	3	H5	2.938	1.250	285552
3/8-24	UNF	.3750	3	H5	2.938	1.250	285628
7/16-14	UNC	.4375	3	H3	3.156	1.438	285651
7/16-20	UNF	.4375	3	H3	3.156	1.438	285701
1/2-13	UNC	.5000	3	H5	3.375	1.656	285801
1/2-20	UNF	.5000	3	H3	3.375	1.656	285859



Spiral Point Taps for Through Holes

Style: **SPHD**

Spiral Point Taps
CNC Heavy-Duty



Note
Tapping speeds - see page 39-41.

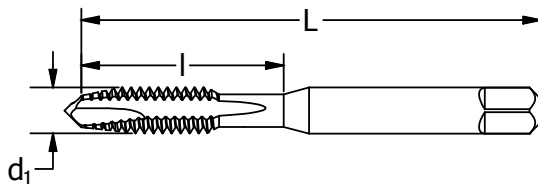

diameter & pitch	thread form	d ₁ in	number of flutes	H-limit	L in	I in	order number	
							Bright	TiN
6-32	UNC	.1380	3	H3	2.000	.688	282108	280108
8-32	UNC	.1640	3	H3	2.125	.750	282157	280157
10-24	UNC	.1900	3	H3	2.375	.875	282207	280207
10-32	UNF	.1900	3	H3	2.375	.875	282256	280256
1/4-20	UNC	.2500	3	H3	2.500	1.000	282306	280306
1/4-20	UNC	.2500	3	H5	2.500	1.000	282355	280355
1/4-28	UNF	.2500	3	H3	2.500	1.000	282405	280405
5/16-18	UNC	.3125	3	H3	2.719	1.125	282454	280454
5/16-18	UNC	.3125	3	H5	2.719	1.125	282470	280470
5/16-24	UNF	.3125	3	H3	2.719	1.125	282504	280504
3/8-16	UNC	.3750	3	H3	2.938	1.250	282553	280553
3/8-16	UNC	.3750	3	H5	2.938	1.250	282603	280603
3/8-24	UNF	.3750	3	H3	2.938	1.250	282652	280652
1/2-13	UNC	.5000	3	H3	3.375	1.656	282801	280801
1/2-13	UNC	.5000	3	H5	3.375	1.656	282850	280850
1/2-20	UNF	.5000	3	H3	3.375	1.656	282901	280901
5/8-11	UNC	.6250	3	H3	3.813	1.813	282959	280959

Style: **SPHD**

Metric - Spiral Point Taps
CNC Heavy-Duty

diameter & pitch	d ₁ mm	number of flutes	D-limit	L in	I in	order number
M6 x 1.0	6.00	3	D5	2.500	1.000	Bright 272550

Machine Taps
Spiral Point Taps
Spiral Flute Taps
Thread Forming Taps
Pipe Taps
Dies
Technical Info
Sets
Index

CNC Spiral Flute
Steels and Stainless Steels

Spiral Flute Taps for Blind Holes



Style: **SFS**



Note
Tapping speeds - see page 39-41.

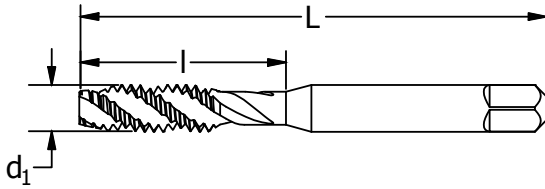

diameter & pitch	thread form	d ₁ in	number of flutes	H-limit	L in	I in	order number
10-32	UNF	.1900	3	H3	2.375	.875	330465
1/4-20	UNC	.2500	3	H3	2.500	1.000	330466
1/4-20	UNC	.2500	3	H5	2.500	1.000	330489
5/16-18	UNC	.3125	3	H3	2.719	1.125	330468
5/16-18	UNC	.3125	3	H5	2.719	1.125	330490
3/8-16	UNC	.3750	3	H3	2.938	1.250	330470
3/8-16	UNC	.3750	3	H5	2.938	1.250	330491
1/2-13	UNC	.5000	3	H3	3.375	1.656	330474
1/2-13	UNC	.5000	3	H5	3.375	1.656	330494
1/2-20	UNF	.5000	3	H5	3.375	1.656	330495
5/8-11	UNC	.6250	4	H3	3.813	1.813	330478
5/8-11	UNC	.6250	4	H5	3.813	1.813	330496

Metric - CNC Spiral Flute
Steels and Stainless Steels

Style: **SFS**

diameter & pitch	d ₁ mm	number of flutes	D-limit	L in	I in	order number
M4 x 0.7	4.00	3	D4	2.125	.750	330498
M5 x 0.8	5.00	3	D4	2.375	.875	330499
M6 x 1	6.00	3	D5	2.500	1.000	330502
M8 x 1.25	8.00	3	D5	2.719	1.125	330503
M10 x 1.5	10.00	3	D6	2.938	1.250	330504
M12 x 1.75	12.00	3	D6	3.375	1.656	330505



Spiral Flute Taps for Blind Holes

Style: **SFHD**

Spiral Flute
CNC Heavy-Duty



Note
Tapping speeds - see
page 39-41.

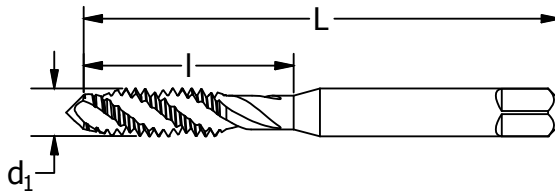
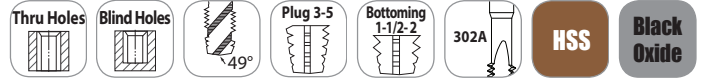

diameter & pitch	thread form	d ₁ in	number of flutes	H-limit	L in	l in	order number	
							plug Black Oxide	bottoming Black Oxide
6-32	UNC	.1380	3	H3	2.000	.688	281957	282005
8-32	UNC	.1640	3	H3	2.125	.750	282054	282104
10-24	UNC	.1900	3	H3	2.375	.875	282062	282120
10-32	UNF	.1900	3	H3	2.375	.875	282153	282203
1/4-20	UNC	.2500	3	H3	2.500	1.000	282252	282302
1/4-28	UNF	.2500	3	H3	2.500	1.000	282351	282401
5/16-18	UNC	.3125	3	H3	2.719	1.125	282450	282501
5/16-24	UNF	.3125	3	H3	2.719	1.125	282468	282526
3/8-16	UNC	.3750	3	H3	2.938	1.250	282559	282609
3/8-24	UNF	.3750	3	H3	2.938	1.250	282567	282625
1/2-13	UNC	.5000	3	H3	3.375	1.656	282757	282807
1/2-20	UNF	.5000	3	H3	3.375	1.656	282765	282823

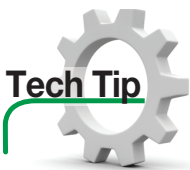

Tech Tip

Ground Thread Tap Limits

All standard ground thread taps made to USCTI Tables 327 and 329 will be marked **G** to designate ground thread. **G** will be followed by **H** to designate above basic or **L** for below basic and a numeral to designate the pitch diameter limits. For example: **GH3** indicates a ground thread tap with pitch diameter limits .0010" to .0015" over basic. See table at right.

For taps over 1-1/2" diameter with H or L limit numbers, divide the H or L limit number by 2 to get the amount (in thousandths of an inch) the maximum tap pitch diameter is over basic for the H series or under basic for the L series. In H series taps, the tolerance shown in USCTI Table 331, Column D, subtracted from the maximum pitch diameter will give the minimum pitch diameter. In L series taps the tolerance shown in Table 331, Column D, added to the minimum pitch diameter will give the maximum pitch diameter. These taps will be marked with the appropriate H or L limit number.

Pitch Diameter Limits

for taps through 1" diameter

- L1 = basic to basic - .0005
- H1 = basic to basic + .0005
- H2 = basic + .0005 to basic + .0010
- H3 = basic + .0010 to basic + .0015
- H4 = basic + .0015 to basic + .0020
- H5 = basic + .0020 to basic + .0025
- H6 = basic + .0025 to basic + .0030

for taps over 1" diameter through 1-1/2" diameter

- H4 = basic + .0010 to basic + .0020

Machine Taps
Spiral Point Taps
Spiral Flute Taps
Thread Forming Taps
Pipe Taps
Dies
Technical Info
Sets
Index

General Purpose Spiral Flute
High-Spiral

Spiral Flute Taps for Blind Holes



Style: **SFGP**



Note
Tapping speeds - see page 39-41.

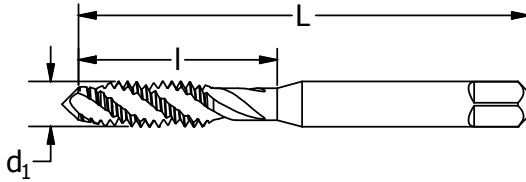

diameter & pitch	thread form	d ₁ in	number of flutes	H-limit	L in	I in	order number			
							plug		bottoming	
							Bright	TiN	Bright	TiN
4-40	UNC	.1120	2	H2	1.875	.563	367149	—	367156	330202
6-32	UNC	.1380	2	H3	2.000	.688	367222	330193	367230	330203
8-32	UNC	.1640	3	H3	2.125	.750	367263	330194	367271	330204
10-24	UNC	.1900	3	H3	2.375	.875	367305	330195	367313	—
10-32	UNF	.1900	3	H3	2.375	.875	367321	330196	367339	330205
1/4-20	UNC	.2500	3	H3	2.500	1.000	367909	—	367917	367913
1/4-28	UNF	.2500	3	H3	2.500	1.000	367925	—	367933	—
5/16-18	UNC	.3125	3	H3	2.719	1.125	367941	—	367958	—
5/16-24	UNF	.3125	3	H3	2.719	1.125	367966	—	367974	—
3/8-16	UNC	.3750	3	H3	2.938	1.250	367982	—	367990	—
3/8-24	UNF	.3750	3	H3	2.938	1.250	368006	—	368014	—
1/2-13	UNC	.5000	3	H3	3.375	1.656	368063	—	368071	—
1/2-20	UNF	.5000	3	H3	3.375	1.656	368089	—	368097	—

Metric - Gen Purpose Spiral Flute
High-Spiral

Style: **SFGP**

diameter & pitch	d ₁ mm	number of flutes	D-limit	L in	I in	order number			
						plug		bottoming	
						Bright	TiCN	Bright	TiCN
M3 x 0.5	3.00	2	D3	1.938	.625	366110	—	366112	330206
M4 x 0.7	4.00	3	D4	2.125	.750	366130	330197	366132	330207
M5 x 0.8	5.00	3	D4	2.375	.875	366140	330198	366142	330208
M6 x 1.0	6.00	3	D5	2.500	1.000	366150	330199	366152	330209
M8 x 1.25	8.00	3	D5	2.719	1.125	366160	330200	366162	330210
M10 x 1.5	10.00	3	D6	2.938	1.250	366170	330201	366172	330211
M12 x 1.75	12.00	3	D6	3.375	1.656	366180	—	366182	—



Thread Forming Taps

Styles: **FTGP**

General Purpose
Thread Forming

P N



Machine Taps

Spiral Point Taps

Spiral Flute Taps

Thread Forming Taps

Pipe Taps

Dies

Technical Info

Sets

Index

Note

Modify tapping speeds listed on page 39-41 as follows: double the speeds versus thread cutting taps.

* #0 - #3: 302 blank style.

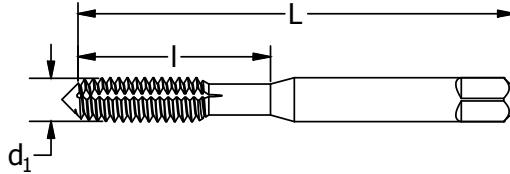

diameter & pitch	thrd form	d ₁ in	H-limit	L in	I in	order number			
						plug		bottoming	
						Bright	TiN	Bright	TiN
*0-80	UNF	.0600	H2	1.625	.313	-	-	330214	-
*2-56	UNC	.0860	H2	1.750	.438	-	-	330215	-
4-40	UNC	.1120	H3	1.875	.563	289004	-	289012	-
5-40	UNC	.1250	H3	1.938	.625	289087	-	289095	-
6-32	UNC	.1380	H3	2.000	.688	289202	287004	289210	287053
6-32	UNC	.1380	H5	2.000	.688	289228	287103	289236	287152
8-32	UNC	.1640	H3	2.125	.750	289269	287202	289277	287251
8-32	UNC	.1640	H5	2.125	.750	289285	287301	289293	287350
10-24	UNC	.1900	H4	2.375	.875	289368	287400	289376	287459
10-24	UNC	.1900	H6	2.375	.875	289384	287509	289392	287558
10-32	UNF	.1900	H4	2.375	.875	289426	-	289434	-
10-32	UNF	.1900	H6	2.375	.875	289442	287608	289459	287657
1/4-20	UNC	.2500	H4	2.500	1.000	289525	-	289533	-
1/4-20	UNC	.2500	H6	2.500	1.000	289541	287707	289558	287756
1/4-28	UNF	.2500	H4	2.500	1.000	289582	-	289590	-
5/16-18	UNC	.3125	H5	2.719	1.125	289640	-	289657	-
5/16-18	UNC	.3125	H7	2.719	1.125	289665	287905	289673	287954
3/8-16	UNC	.3750	H7	2.938	1.250	289780	288101	289798	288150
3/8-24	UNF	.3750	H5	2.938	1.250	330212	-	-	-
3/8-24	UNF	.3750	H7	2.938	1.250	330213	-	-	-
1/2-13	UNC	.5000	H8	3.375	1.656	289988	288408	289996	288457

Style: **FTGP**

Metric - General Purpose
Thread Forming

diameter & pitch	d ₁ mm	D-limit	L in	I in	order number			
					plug		bottoming	
					Bright	TiCN	Bright	TiCN
M3 x 0.5	3.00	D5	1.938	.625	291001	291006	291018	291014
M4 x 0.7	4.00	D6	2.125	.750	291083	291089	291091	291097
M5 x 0.8	5.00	D7	2.375	.875	291125	291123	291133	291139
M6 x 1.0	6.00	D8	2.500	1.000	291166	291162	291174	291170
M8 x 1.25	8.00	D9	2.719	1.125	291240	291246	291257	291253
M10 x 1.5	10.00	D10	2.938	1.250	291176	291287	291178	291295

Taper Pipe
NPT/NPTF Medium Hook

Pipe Taps

Style: **PTT**

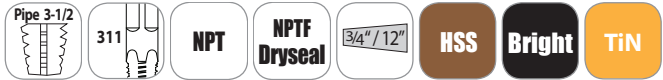

Machine Taps

Spiral Point Taps

Spiral Flute Taps

Thread Forming Taps

Pipe Taps

Dies

Technical Info

Sets

Index

P

Note
Tapping speeds - see page 39-41.

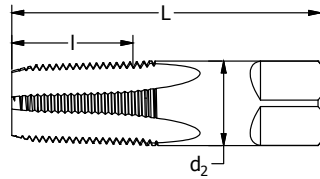

diameter & pitch	d ₂ in	number of flutes	L in	I in	order number			
					NPT Bright	NPT TiN	NPTF Bright	NPTF TiN
1/16-27	.3125	4	2.1250	0.6875	385307	385328	385323	385329
*1/8-27	.3125	4	2.1250	0.7500	385331	385357	385356	385359
1/8-27	.4375	4	2.1250	0.7500	385364	385385	385380	385386
1/4-18	.5625	4	2.4375	1.0625	385398	385409	385413	385410
3/8-18	.7000	4	2.5625	1.0625	385422	385443	385448	385444
1/2-14	.6875	4	3.1250	1.3750	385455	385458	385471	385477
3/4-14	.9063	5	3.2500	1.3750	385489	385500	385505	385501
1 - 11-1/2	1.1250	5	3.7500	1.7500	385513	385534	385539	385536
1-1/4 - 11-1/2	1.3125	5	4.0000	1.7500	385547	385680	385562	385685
1-1/2 - 11-1/2	1.5000	7	4.2500	1.7500	385570	385681	—	—
2 - 11-1/2	1.8750	7	4.5000	1.7500	385604	385682	—	—

*small shank

Taper Pipe
NPT/NPTF Medium Hook

SET

Style: **PTT**

	order number
NPT Pipe Tap: 1/8 - 1" NPT	353768

Tech Tip

Tap Drill Recommendations - NPT, NPTF, NPSM, NPSC, NPSF Sizes

Color Code:
Wire Gage - Purple
Fractional - Red,
Letter - Blue,
and
Metric Sizes - Green

Nominal Tap Size & Pitch	NPT & NPTF		NPSM	NPSC	NPSF
	w/o reamer	w/ reamer			
1/16 - 27	C (.242)	A (.234)	—	1/4	D (.246)
1/8 - 27	Q (.332)	21/64	T (.358)	Q	R (.339)
1/4 - 18	7/16	27/64	15/32	7/16	7/16
3/8 - 18	9/16	9/16	.603*	37/64	37/64
1/2 - 14	45/64	11/16	19.0mm	23/32	.705*
3/4 - 14	29/32	57/64	61/64	59/64	59/64
1 - 11 ¹ / ₂	1-9/64	1-1/8	1-13/64	1-5/32	1-5/32
1 ¹ / ₄ - 11 ¹ / ₂	1-31/64	1-15/32	1.546*	1-1/2	—
1 ¹ / ₂ - 11 ¹ / ₂	1-23/32	1-45/64	1-25/32	1-47/64	—
2 - 11 ¹ / ₂	2-3/16	2-11/64	2-1/4	2-1/4	—

*special



Pipe Taps

Style: **PTTI**

Taper Pipe
NPT/NPTF Medium Hook Interrupted

P



Machine Taps

Spiral Point Taps

Spiral Flute Taps

Thread Forming Taps

Pipe Taps

Dies

Technical Info

Sets

Index

Note

Tapping speeds - see page 39-41.

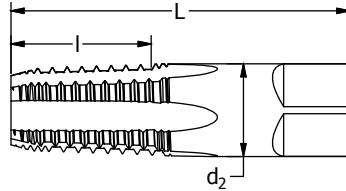

diameter & pitch	d ₂ in	number of flutes	L in	I in	order number		
					NPT Bright	NPTF Bright	NPTF TiN
*1/8-27	.3125	4	2.125	.750	—	385752	—
1/8-27	.4375	4	2.125	.750	385737	385729	385755
1/4-18	.5625	4	2.438	1.063	385760	385786	385789
3/8-18	.7000	4	2.563	1.063	385794	385810	385813
1/2-14	.6875	4	3.125	1.375	385828	385844	385847
3/4-14	.9063	5	3.250	1.375	385851	385877	385870
1-11-1/2	1.1250	5	3.750	1.750	385885	—	—

* small shank

Tech Tip



Pipe Taps

General purpose pipe taps are appropriate for threading a wide variety of materials, both ferrous and non-ferrous.

Ground thread pipe taps are standard in American Standard Pipe Form (NPT) and American Standard Dryseal Pipe Form (NPFT). NPT threads require the use of a sealer, like Teflon[®] tape or pipe compound. Dryseal taps are used to tap fittings which will give a pressure-tight joint without the use of a sealer.

The nominal size of a pipe tap is that of the pipe fitting to be tapped, not the actual size of the tap. The thread tapers 3/4" per foot.

All pipe taps are furnished with 2 1/2 to 3-1/2 thread chamfer.

Short projection pipe taps are made with a projection shorter than standard for taper pipe tapping where the depth of tapping is limited. Special short projection pipe taps and left hand pipe taps are available as specials.

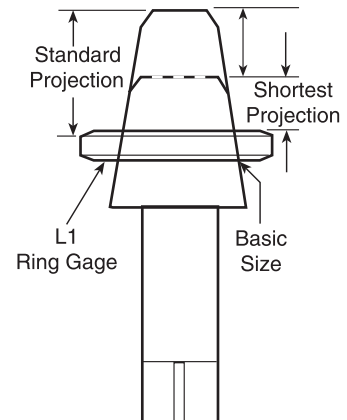

P

Mod 3-5 311 NPS NPSF Dryseal NPSM NPSC 3/4" / 12" HSS Bright

Note
Tapping speeds -
see page 39-41.

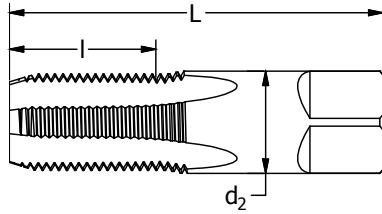

order number

diameter & pitch	d ₂ in	number of flutes	L in	l in	order number	
					NPS/NPSM NPSC Bright	NPSF Bright
*1/8-27	.3125	4	2.125	.750	—	387212
1/8-27	.4375	4	2.125	.750	387113	387220
1/4-18	.5625	4	2.438	1.063	387121	387238
3/8-18	.7000	4	2.563	1.063	387139	387246
1/2-14	.6875	4	3.125	1.375	387147	387253

* small shank

- Machine Taps
- Spiral Point Taps
- Spiral Flute Taps
- Thread Forming Taps
- Pipe Taps
- Dies
- Technical Info
- Sets
- Index



Pipe Taps
Style: **ELPTT**

CNC Extra Length Med. Hook
with Machine Tap Shanks

P

Note

Tapping speeds - see page 39-41.



NPT

NPTF Dryseal

3/4" / 12"

HSS

Bright

TiN

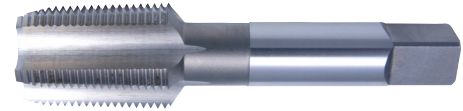
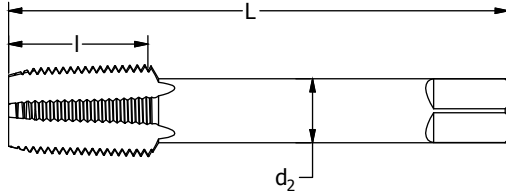

diameter & pitch	d ₂ in	number of flutes	L in	I in	order number		
					NPT Bright	NPTF Bright	NPTF TiN
1/8-27	0.318	4	3.000	.750	384524	386008	386129
1/4-18	0.480	4	3.500	1.063	384525	386024	386152
3/8-18	0.480	4	3.750	1.063	384526	386040	386186
1/2-14	0.480	4	4.375	1.375	384527	—	—
3/4-14	0.800	5	4.625	1.375	384528	—	—
1-11-1/2	0.800	5	5.250	1.750	384529	—	—

- Machine Taps
- Spiral Point Taps
- Spiral Flute Taps
- Thread Forming Taps
- Pipe Taps**
- Dies
- Technical Info
- Sets
- Index

Inch - Carbon Steel
Re-threading Dies

Hexagon Dies

Style: **377**



MOST GENERAL PURPOSE MATERIALS

Note

For dressing over bruised or rusty threads.

No special holder required; use standard wrenches.

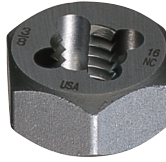

die diameter TPI & series	decimal equivalent	length across flats - in	thickness in	order number carbon steel
1/4-20 UNC	.2500	.5938	.2500	403108
1/4-28 UNF	.2500	.5938	.2500	403116
5/16-18 UNC	.3125	.6875	.3125	403124
5/16-24 UNF	.3125	.6875	.3125	403132
3/8-16 UNC	.3750	.7812	.3750	403140
3/8-24 UNF	.3750	.7812	.3750	403157
7/16-14 UNC	.4375	.8750	.4375	403165
7/16-20 UNF	.4375	.8750	.4375	403173
1/2-13 UNC	.5000	1.0625	.5000	403181
1/2-20 UNF	.5000	1.0625	.5000	403199
9/16-12 UNC	.5625	1.0625	.5000	403207
9/16-18 UNF	.5625	1.0625	.5000	403215
5/8-11 UNC	.6250	1.2500	.6250	403223
5/8-18 UNF	.6250	1.2500	.6250	403231
11/16-11 UNS	.6875	1.4375	.7500	403249
11/16-16 UNS	.6875	1.4375	.7500	403256
3/4-10 UNC	.7500	1.4375	.7500	403264
3/4-16 UNF	.7500	1.4375	.7500	403272
7/8-9 UNC	.8750	1.6250	.8750	403280
7/8-14 UNF	.8750	1.6250	.8750	403298
1-8 UNC	1.0000	1.8125	1.0000	403306
1-12 UNF	1.0000	1.8125	1.0000	403314
1-14 UNS	1.0000	1.8125	1.0000	403322
1-1/8-7 UNC	1.1250	2.0000	1.0000	403330
1-1/8-12 UNF	1.1250	2.0000	1.0000	403348
1-1/4-7 UNC	1.2500	2.1875	1.0000	403355
1-1/4-12 UNF	1.2500	2.1875	1.0000	403363
1-3/8-6 UNC	1.4100	2.3750	1.0000	403371
1-3/8-12 UNF	1.4100	2.3750	1.0000	403389
1-1/2-6 UNC	1.5000	2.5625	1.0000	403397
1-1/2-12 UNF	1.5000	2.5625	1.0000	403405

Taper - Carbon Steel
Re-threading Dies

Style: **377**

die diameter TPI & series	decimal equiv.	length across flats - in	thickness in	order number carbon steel
1/8-27 NPT	.1250	1.0625	.3750	411895
1/4-18 NPT	.2500	1.2500	.6250	411896
3/8-18 NPT	.3750	1.4375	.6250	411897
1/2-14 NPT	.5000	1.6250	.7500	411898
3/4-14 NPT	.7500	2.0000	.8125	411899
1 - 11 1/2 NPT	1.0000	2.3750	1.0000	411900

metric sizes on next page



Hexagon Dies

Style: **377**

Metric - Carbon Steel Re-threading Dies

die diameter & TPI	decimal equiv.	mm equiv.	length across flats - in	thickness in	order number carbon steel
M5 x 0.8	.1969	5.00	.5938	.2500	404808
M6 x 1	.2362	6.00	.5938	.2500	404809
M8 x 1.25	.3150	8.00	.6875	.3125	404833
M10 x 1.5	.3937	10.00	.8750	.4375	404858
M12 x 1.75	.4724	12.00	1.0125	.5000	404882
M14 x 2	.5512	14.00	1.0125	.5000	404916
M16 x 2	.6299	16.00	1.2500	.6250	404932
M20 x 2.5	.7874	20.00	1.6250	.8750	404973

SET

Style: **377**

Carbon Steel Re-threading Dies



set number	number of sizes	die sizes		order number
481	8	1/4-20 NC	1/2-13 NC	403512
		5/16-18 NC	9/16-12 NC	
		3/8-16 NC	5/8-11 NC	
		7/16-14 NC	3/4-10 NC	
482	10	1/4-20 NC	9/16-12 NC	403553
		5/16-18 NC	5/8-11 NC	
		3/8-16 NC	3/4-10 NC	
		7/16-14 NC	7/8-9 NC	
		1/2-13 NC	1-8 NC	
490	10	1/4-20 NC	1/4-28 NF	403520
		5/16-18 NC	5/16-24 NF	
		3/8-16 NC	3/8-24 NF	
		7/16-14 NC	7/16-20 NF	
		1/2-13 NC	1/2-20 NF	
492	20	1/4-20 NC	1/4-28 NF	403595
		5/16-18 NC	5/16-24 NF	
		3/8-16 NC	3/8-24 NF	
		7/16-14 NC	7/16-20 NF	
		1/2-13 NC	1/2-20 NF	
		9/16-12 NC	9/16-18 NF	
		5/8-11 NC	5/8-18 NF	
		3/4-10 NC	3/4-16 NF	
		7/8-9 NC	7/8-14 NF	
		1-8 NC	1-14 NF	
485	7	M6 x 1	M14 x 2	403522
		M8 x 1.25	M16 x 2	
		M10 x 1.5	M20 x 2.5	
		M12 x 1.75		

- Machine Taps
- Spiral Point Taps
- Spiral Flute Taps
- Thread Forming Taps
- Pipe Taps
- Dies
- Technical Info
- Sets
- Index

Inch - Round Adjustable Dies
382 - Carbon Steel / 6382 - HSS

Round Adjustable Dies
Styles: 382 and 6382



MOST GENERAL PURPOSE MATERIALS

Note
 Use in hand-held die stocks or machine holders.
 Chamfered on both faces, 2 to 3 threads on one side and 1 to 2-1/2 threads on the other for threading close to the shoulder.
 Beveled screw slot to remove screw when die is used in a machine holder.
Pipe and Metric sizes after inch.

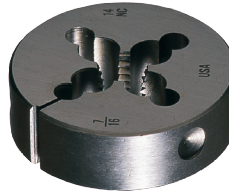

die diameter TPI & series		decimal equiv.	outside dia. in	thickness in	order number	
					style 382 carbon steel	style 6382 high-speed steel
0-80	UNF	.0600	.8125	.2500	401003	—
1-64	UNC	.0730	.8125	.2500	401029	—
1-72	UNF	.0730	.8125	.2500	401037	—
2-56	UNC	.0860	.8125	.2500	401045	—
2-64	UNF	.0860	.8125	.2500	401052	—
3-48	UNC	.0990	.8125	.2500	401060	—
3-56	UNF	.0990	.8125	.2500	401078	—
4-40	UNC	.1120	.8125	.2500	401102	—
4-48	UNF	.1120	.8125	.2500	401110	—
5-40	UNC	.1250	.8125	.2500	401128	400013
5-44	UNF	.1250	.8125	.2500	401129	400021
6-32	UNC	.1380	.8125	.2500	401168	400039
6-32	UNC	.1380	1.000	.3750	401409	400138
6-40	UNF	.1380	.8125	.2500	401169	400047
8-32	UNC	.1640	.8125	.2500	401177	400054
8-32	UNC	.1640	1.0000	.3750	401433	400145
8-36	UNF	.1640	.8125	.2500	400178	400062
10-24	UNC	.1900	.8125	.2500	401201	400070
10-24	UNC	.1900	1.0000	.3750	401466	400179
10-32	UNF	.1900	.8125	.2500	401227	400088
10-32	UNF	.1900	1.0000	.3750	401482	400187
12-24	UNC	.2160	.8125	.2500	401242	400096
12-24	UNC	.2160	1.0000	.3750	401490	400195
12-28	UNF	.2160	.8125	.2500	401243	400104
1/4-20	UNC	.2500	.8125	.2500	401244	400211
1/4-20	UNC	.2500	1.0000	.3750	401979	400302
1/4-20	UNC	.2500	1.5000	.5000	402209	400401
1/4-20	UNC	.2500	2.0000	.6250	402407	—
1/4-28	UNF	.2500	.8125	.2500	—	400229
1/4-28	UNF	.2500	1.0000	.3750	401995	400310
1/4-28	UNF	.2500	1.5000	.5000	402225	400419
1/4-28	UNF	.2500	2.0000	.6250	402423	—
5/16-18	UNC	.3125	.8125	.2500	—	400237
5/16-18	UNC	.3125	1.0000	.3750	402019	400328
5/16-18	UNC	.3125	1.5000	.5000	402241	400427
5/16-18	UNC	.3125	2.0000	.6250	402449	—
5/16-24	UNF	.3125	.8125	.2500	—	400245
5/16-24	UNF	.3125	1.0000	.3750	402027	400336
5/16-24	UNF	.3125	1.5000	.5000	402258	400435
5/16-24	UNF	.3125	2.0000	.6250	402456	—

continued on next page



Round Adjustable Dies

Styles: 382 and 6382 (continued)

Inch - Round Adjustable Dies

382 - Carbon Steel / 6392 - HSS

die diameter TPI & series		decimal equiv.	outside dia in	thickness in	order number	
					style 382 carbon steel	style 6382 high-speed steel
3/8-16	UNC	.3750	1.0000	.3750	402043	400344
3/8-16	UNC	.3750	1.5000	.5000	402274	400445
3/8-16	UNC	.3750	2.0000	.6250	402472	—
3/8-24	UNF	.3750	1.0000	.3750	402050	400351
3/8-24	UNF	.3750	1.5000	.5000	402282	400450
3/8-24	UNF	.3750	2.0000	.6250	402480	—
7/16-14	UNC	.4375	1.0000	.3750	402068	400369
7/16-14	UNC	.4375	1.5000	.5000	402290	400468
7/16-14	UNC	.4375	2.0000	.6250	402498	—
7/16-20	UNF	.4375	1.0000	.3750	402076	400377
7/16-20	UNF	.4375	1.5000	.5000	402308	400476
7/16-20	UNF	.4375	2.0000	.6250	402506	—
1/2-13	UNC	.5000	1.0000	.3750	402077	—
1/2-13	UNC	.5000	1.5000	.5000	402316	400484
1/2-13	UNC	.5000	2.0000	.6250	402514	—
1/2-20	UNF	.5000	1.0000	.3750	402078	—
1/2-20	UNF	.5000	1.5000	.5000	402324	400492
1/2-20	UNF	.5000	2.0000	.6250	402522	—
9/16-12	UNC	.5625	1.5000	.5000	402332	400500
9/16-12	UNC	.5625	2.0000	.6250	402530	—
9/16-18	UNF	.5625	1.5000	.5000	402340	400518
9/16-18	UNF	.5625	2.0000	.6250	402548	—
5/8-11	UNC	.6250	1.5000	.5000	402357	400526
5/8-11	UNC	.6250	2.0000	.6250	402555	400609
5/8-11	UNC	.6250	2.5000	.7500	402746	—
5/8-18	UNF	.6250	1.5000	.5000	402365	400534
5/8-18	UNF	.6250	2.0000	.6250	402563	400617
3/4-10	UNC	.7500	1.5000	.5000	402370	—
3/4-10	UNC	.7500	2.0000	.6250	402597	400625
3/4-10	UNC	.7500	2.5000	.7500	402787	—
3/4-16	UNF	.7500	1.5000	.5000	402377	—
3/4-16	UNF	.7500	2.0000	.6250	402605	400633
3/4-16	UNF	.7500	2.5000	.7500	402795	—
7/8-9	UNC	.8750	2.0000	.6250	402613	400641
7/8-9	UNC	.8750	2.5000	.7500	402803	—
7/8-14	UNF	.8750	2.0000	.6250	402621	400658
7/8-14	UNF	.8750	2.5000	.7500	402811	—
1-8	UNC	1.0000	2.0000	.6250	402625	—
1-8	UNC	1.0000	2.5000	.7500	402829	—
1-8	UNC	1.0000	3.0000	1.0000	402902	—
1-12	UNF	1.0000	2.0000	.6250	402627	—
1-12	UNF	1.0000	2.5000	.7500	402837	—
1-12	UNF	1.0000	3.0000	1.0000	402910	—
1-14	UNF	1.0000	2.0000	.6250	402630	—
1-1/8-7	UNC	1.1250	3.0000	1.0000	402936	—
1-1/8-12	UNF	1.1250	3.0000	1.0000	402944	—
1-1/4-7	UNC	1.2500	3.0000	1.0000	402951	—
1-1/4-12	UNF	1.2500	3.0000	1.0000	402969	—
1-3/8-6	UNC	1.3750	3.0000	1.0000	402977	—
1-3/8-12	UNF	1.3750	3.0000	1.0000	402985	—
1-1/2-6	UNC	1.5000	3.0000	1.0000	402993	—
1-1/2-12	UNF	1.5000	3.0000	1.0000	403009	—

pipe and metric sizes continued on next page

- Machine Taps
- Spiral Point Taps
- Spiral Flute Taps
- Thread Forming Taps
- Pipe Taps
- Dies
- Technical Info
- Sets
- Index



Pipe - Round Adjustable Dies
382 - Carbon Steel / 6392 - HSS

Styles: **382** and **6382** (continued)

Machine Taps

Spiral Point Taps

Spiral Flute Taps

Thread Forming Taps

Pipe Taps

Dies

Technical Info

Sets

Index

die diameter TPI & series		decimal equiv.	outside dia in	thickness in	order number style 382 carbon steel
1/8-27	NPT	.1250	1.0000	.3750	405202
1/8-27	NPT	.1250	1.5000	.5000	405251
1/4-18	NPT	.2500	1.5000	.5000	405269
1/4-18	NPT	.2500	2.0000	.6250	405301
3/8-18	NPT	.3750	1.5000	.5000	405277
3/8-18	NPT	.3750	2.0000	.6250	405319
1/2-14	NPT	.5000	2.0000	.6250	405327

Pipe size round adjustable dies are not split.

Metric - Round Adjustable Dies
382 - Carbon Steel / 6392 - HSS

Styles: **382** and **6382** (continued)

die diameter TPI & series	decimal equiv.	mm equiv.	outside dia in	thickness in	order number style 6382 high-speed steel
M2.5 x 0.45	.0984	2.50	.8125	.2500	415721
M3 x 0.5	.1181	3.00	.8125	.2500	415724
M3.5 x 0.6	.1378	3.50	.8125	.2500	415732
M4 x 0.7	.1575	4.00	.8125	.2500	415737
M4.5 x 0.75	.1772	4.50	.8125	.2500	415742
M5 x 0.8	.1969	5.00	.8125	.2500	415747
M6 x 1	.2362	6.00	.8125	.2500	415757
M6 x 1	.2362	6.00	1.0000	.3750	415801
M7 x 1	.2756	7.00	1.0000	.3750	415807
M8 x 1.25	.3150	8.00	1.0000	.3750	415813
M10 x 1.5	.3937	10.00	1.0000	.3750	415824
M12 x 1.75	.4724	12.00	1.0000	.3750	415833
M14 x 2	.5512	14.00	1.5000	.5000	415880
M16 x 2	.6300	16.00	1.5000	.5000	415889
M18 x 2.5	.7087	18.00	1.5000	.5000	415896
M20 x 2.5	.7874	20.00	1.5000	.5000	415901

Die Stock

Round Adjustable Dies

Styles: **1750** and **1790**

Style **1750** holds round adjustable dies with three adjusting screws.

Style **1790** stocks have built-in workpiece guide and lock in place with two set screws.



product number	die o.d.	overall length	order no. style 1750
#1851	13/16	7	420514
#2	13/16	6-1/4	423008
#1852	1	10-1/2	420522
#3	1	9	423009
#1853	1-1/2	14-1/2	420548
#5	1-1/2	13-7/8	423010
#6	2	23	420555
#7	2-1/2	29	420563
#8	3	40	420571

product number	die o.d.	overall length	order no. style 1790
#13	13/16	6-1/4	423011
#14	1	13	423012
#15	1-1/2	17-3/4	423013
#16	2	26	423014



OK Jr. Tap & Die Sets with HSS Production Hand Taps and Carbon Steel Round Adjustable Dies - Inch

set number	no. of sizes	tap and die sizes	tap wrench	die stock	order number
17	7	4-40 UNC 6-32 UNC 8-32 UNC	10-24 UNC 10-32 UNF 12-24 UNC 1/4-20 UNC	329 13	423001
18	5	1/4-20 UNC 5/16-18 UNC	3/8-16 UNC 7/16-14 UNC 1/2-13 UNC	333 14	423002
25	8	0-80 UNF 1-72 UNF 2-56 UNC 3-48 UNC	4-40 UNC 6-32 UNC 8-32 UNC 10-24 UNC	329 13	423003
T4	8	2-56 UNC 3-48 UNC 4-40 UNC 6-32 UNC	8-32 UNC 10-24 UNC 10-32 UNF 12-24 UNC	0 1851	420359
26	10	4-40 UNC	4-48 UNF	329 13	420361
T6	20	1/4-20 UNC 5/16-18 UNC 3/8-16 UNC 7/16-14 UNC 1/2-13 UNC 9/16-12 UNC 5/8-11 UNC 3/4-10 UNC 7/8-9 UNC 1-8 UNC	1/4-28 UNF 5/16-24 UNF 3/8-24 UNF 7/16-20 UNF 1/2-20 UNF 9/16-18 UNF 5/8-18 UNF 3/4-18 UNF 7/8-14 UNF 1-12 UNF	7 1852	420363
28	11	1/4-20 UNC 5/16-18 UNC 3/8-16 UNC 7/16-14 UNC 1/2-13 UNC pipe size	1/4-28 UNF 5/16-24 UNF 3/8-24 UNF 7/16-20 UNF 1/2-20 UNF 1/8-27 (short shank)	333 1	423004
32	21	1/4-20 UNC 5/16-18 UNC 3/8-16 UNC 7/16-14 UNC 1/2-13 UNC 9/16-12 UNC 5/8-11 UNC 3/4-10 UNC 7/8-9 UNC 1-8 UNC pipe size	1/4-28 UNF 5/16-24 UNF 3/8-24 UNF 7/16-20 UNF 1/2-20 UNF 9/16-18 UNF 5/8-18 UNF 3/4-16 UNF 7/8-14 UNF 1-14 UNS 1/8-27 (long shank)	15 14 7 15 16	423005

continued on next column

OK Jr. Tap & Die Sets with HSS Production Hand Taps and Carbon Steel Round Adjustable Dies - Inch

set number	no. of sizes	tap and die sizes	tap wrench	die stock	screw-driver	order number
33	28 Taps 15 Dies	4-40 UNC 6-32 UNC 8-32 UNC 10-24 UNC 10-32 UNF 12-24 UNC 1/4-20 UNC 1/4-28 UNF 5/16-18 UNC 5/16-24 UNF	3/8-16 UNC 3/8-24 UNF 7/16-14 UNC 7/16-20 UNF 1/2-13 UNC 1/2-20 UNF 9/16-12 UNC 9/16-18 UNF 5/8-18 UNF 3/4-16 UNF 7/8-14 UNF 1-14 UNS 1/8-27 NPT 1/4-18NPT 3/8-18 NPT 1/2-14 NPT	329 336 15	14 15 16 7	423006

Tap & Die Sets with Production Hand Taps and HSS Round Adjustable Dies - Metric

set number	no. of sizes	tap and die sizes	tap wrench	die stock	screw-driver	order number
48	7	M2.5 x 0.45 M3 x 0.5 M3.5 x 0.6 M4 x 0.7 M4.5 x 0.75 M5 x 0.8 M6 x 1.0	333	1790	300	420365

Tap & Die Sets with Production Hand Taps, and HSS Round Adjustable Dies (metric sizes)

set number	no. of sizes	tap and die sizes	tap wrench	die stock	screw-driver	order number
49	5	M6 x 1.0 M7 x 1.0 M8 x 1.25 M10 x 1.5 M12 x 1.75	333	1790	300	420367

Tap & Die Sets with Production Hand Taps, Black Oxide Jobber Length Drills, and HSS Round Adjustable Dies (metric sizes)

set number	no. of sizes	tap and die sizes	drill sizes	tap wrench	die stock	screw-driver	order number
49D	5	M6 x 1.0 M7 x 1.0 M8 x 1.25 M10 x 1.5 M12 x 1.75	5.0 6.0 6.7 8.5 10.2	333	1790	300	420368

- Machine Taps
- Spiral Point Taps
- Spiral Flute Taps
- Thread Forming Taps
- Pipe Taps
- Dies
- Technical Info
- Sets
- Index

Little Giant®
Two-Piece Die System

Die Systems

Styles: 1386



Carbon Steel **Bright**

- Little Giant® Two-Piece Die System consists of these parts
Series 380 — Die
Series 1383 — Cap
Series 1384 — Guide
Series 1385 — Collet
- Inch sizes are sold as a complete assembly or in their component parts.
- Metric sizes are sold in their component parts only.

- Use with Style 1381 Little Giant® die stocks.
- Collet assembly for use with Little Giant® dies consists of a cap and a guide; order cap and guide separately, or assembled as a collet.
- Die halves are seated in the beveled cap slot and held in place by the guide, which screws into the underside of the cap.
- Die is adjusted by the set screws at either end of the slot.

- Caps of a given outside diameter are made with several different sizes of slots.
- Separate guide is required for each cutting size.
- To order separate guides, specify cutting size of the die and the size of the collet for 1/4" through 1/2" dies.
- For metric sizes where guide and collet assembly are not available, use Style 1382 Little Giant® Jr. die stock to hold dies.

Style 1386



Style 380

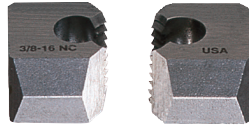

Style 1385
(combined Cap and Guide)



Style 1383



Style 1384



Inch Sizes

nominal size tpi and series	decimal equiv.	style 1386		style 380		style 1385		style 1383		style 1384
		complete assembly	die blank	die order number	collet assembly no.	order no.	cap o.d.	cap order no.	guide order no.	
4-40 UNC	.1120	423019	A1	423058	A1	423100	1.250	423121	423128	
6-32 UNC	.1380	423020	A1	423059	A1	423101	1.250	423121	423129	
8-32 UNC	.1640	423021	A1	423060	A1	423102	1.250	423121	423130	
10-24 UNC	.1900	423022	A1	423061	A1	423103	1.250	423121	423131	
10-32 UNF	.1900	423023	A1	423062	A1	423103	1.250	423121	423131	
12-24 UNC	.2160	423024	A1	423063	A1	423104	1.250	423121	423132	
1/4-20 UNC	.2500	423025	A1	423064	A1	423105	1.250	423121	423133	
1/4-20 UNC	.2500	423026	A	423065	1	423106	2.000	423122	423134	
1/4-20 UNC	.2500	423027	A	423065	5	423107	2.750	423123	423135	
1/4-28 UNF	.2500	423028	A1	423067	A1	423105	1.250	423121	423133	
1/4-28 UNF	.2500	423029	A	423068	1	423106	2.000	423122	423134	
1/4-28 UNF	.2500	423030	A	423068	5	423107	2.750	423123	423135	
5/16-18 UNC	.3125	423031	A	423069	1	423108	2.000	423122	423137	
5/16-18 UNC	.3125	423032	A	423069	5	423109	2.750	423123	423136	
5/16-24 UNF	.3125	423033	A	423070	1	423108	2.000	423122	423137	
5/16-24 UNF	.3125	423034	A	423070	5	423109	2.750	423123	423136	
3/8-16 UNC	.3750	423035	B	423071	1	423110	2.000	423124	423138	
3/8-16 UNC	.3750	423036	B	423071	5	423111	2.750	423125	423139	
3/8-24 UNF	.3750	423037	B	423072	1	423110	2.000	423124	423138	
3/8-24 UNF	.3750	423038	B	423072	5	423111	2.750	423125	423139	
7/16-14 UNC	.4375	423039	B	423073	1	423112	2.000	423124	423141	
7/16-14 UNC	.4375	423040	B	423073	5	423113	2.750	423125	423140	
7/16-20 UNF	.4375	423041	B	423074	1	423112	2.000	423124	423141	
7/16-20 UNF	.4375	423042	B	423074	5	423113	2.750	423125	423140	
1/2-13 UNC	.5000	423043	B	423075	1	423114	2.000	423124	423142	
1/2-13 UNC	.5000	423044	C	423076	5	423115	2.750	423126	423143	
1/2-20 UNF	.5000	423045	B	423077	1	423114	2.000	423124	423142	
1/2-20 UNF	.5000	423046	C	423078	5	423115	2.750	423126	423143	
9/16-12 UNC	.5625	423047	C	423079	5	423116	2.750	423126	423144	
9/16-18 UNF	.5625	423048	C	423080	5	423116	2.750	423126	423144	
5/8-11 UNC	.6250	423049	C	423081	5	423117	2.750	423126	423145	
5/8-18 UNF	.6250	423050	C	423082	5	423117	2.750	423126	423145	
3/4-10 UNC	.7500	423051	C	423083	5	423118	2.750	423126	423146	
3/4-16 UNF	.7500	423052	C	423084	5	423118	2.750	423126	423146	
7/8-9 UNC	.8750	423053	D	423085	5	423119	2.750	423127	423147	
7/8-14 UNF	.8750	423054	D	423086	5	423119	2.750	423127	423147	
1-8 UNC	1.0000	423055	D	423087	5	423120	2.750	423127	423148	
1-12 UNF	1.0000	423056	D	423088	5	423120	2.750	423127	423148	
1-14 UNS	1.0000	423057	D	423089	5	423120	2.750	423127	423148	



Die Systems

Styles: 1386 (continued)

Metric - Little Giant®
Two-Piece Die System

nominal size and tpi	decimal equiv.	mm equiv.	style 380		style 1385		style 1383		style 1384
			die blank	die order number	collet assembly no.	order no.	cap o.d.	cap order no.	guide order no.
M6 x 1	.2362	6.00	A	423090	5	*	2.750	*	423149
M8 x 1.25	.3150	8.00	A	423091	5	*	2.750	*	423150
M10 x 1.5	.3937	10.00	B	423092	5	*	2.750	*	423151
M12 x 1.75	.4724	12.00	B	423093	5	*	2.750	*	423152
M14 x 2	.5512	14.00	C	423094	5	423115	2.750	423126	423153
M16 x 2	.6300	16.00	C	423095	5	423116	2.750	423126	423154
M18 x 2.5	.7087	18.00	C	423096	5	423117	2.750	423126	423155
M20 x 2.5	.7874	20.00	C	423097	5	423118	2.750	423126	423156
M22 x 2.5	.8661	22.00	D	423098	5	423119	2.750	423127	423157
M24 x 3	.9449	24.00	D	423099	5	423120	2.750	423127	423158

*Use Style 382 Quick-Set Jr. die stock instead of collet assembly for these sizes.

SET

Style: 1386

Little Giant®
Two-Piece Die System Set

Tap & Die Sets with Collet

- Carbon steel two-piece dies and collets
- Hand taps
- Tap wrench, die stock

set no.	no. of sizes	tap & die sizes	collet no.	tap wrench	die stock	order no.	
59	7	4-40 NC 6-32 NC 8-32 NC	10-24 NC 10-32 NF 12-24 NC 1/4-20 NC	A1	T9, A1	A1	423159
510	5	1/4-20 NC 5/16-18 NC 3/8-16 NC	7/16-14 NC 1/2-13 NC	1	#5	#1	423160
511	10	1/4-20 NC 5/16-18 NC 3/8-16 NC 7/16-14 NC 1/2-13 NC	9/16-18 NC 5/8-18 NC 3/4-16 NC 7/8-14 NC 1-8 NC	5	#5, #7	5A	423173
512	10	1/4-20 NC 5/16-18 NC 3/8-16 NC 7/16-14 NC 1/2-13 NC	1/4-28 NF 5/16-24 NF 3/8-24 NF 7/16-20 NF 1/2-20 NF	1	#5	#1	423162
513	20	1/4-20 NC 5/16-18 NC 3/8-16 NC 7/16-14 NC 1/2-13 NC 9/16-12 NC 5/8-11 NC 3/4-10 NC 7/8-9 NC 1-8 NC	1/4-28 NF 5/16-24 NF 3/8-24 NF 7/16-20 NF 1/2-20 NF 9/16-18 NF 5/8-18 NF 3/4-16 NF 7/8-14 NF 1-14 NS	1,5	#5, #7	#1, #5B	423163
514	7	M6 x 1 M8 x 1.25 M10 x 1.5 M12 x 1.75	M14 x 2 M16 x 2 M18 x 2.5	5	#6	#5	423164

Tap & Die Set without Collet

- Carbon steel Quick-Set two-piece dies and guides.
- HSS production hand taps
- Tap wrenches
- Die stock to hold dies without collet

set no.	# of sizes	tap & die sizes	tap wrench	die stock	order no.	
58	20	1/4-20 NC 5/16-18 NC 3/8-16 NC 7/16-14 NC 1/2-13 NC 9/16-12 NC 5/8-11 NC 3/4-10 NC 7/8-9 NC 1-8 NC	1/4-28 NF 5/16-24 NF 3/8-24 NF 7/16-20 NF 1/2-20 NF 9/16-18 NF 5/8-18 NF 3/4-16 NF 7/8-14 NF 1-14NS	#5, #7	#1, #5	423165



Little Giant® Accessories

Two-Piece Die with collet

Die Systems

Style: **1381**



Carbon Steel **Steam Oxide**

- Use with all Series 1386 Little Giant collets with two-piece dies.
- Little Giant die stocks have center holes corresponding to the outside diameter of the Little Giant collets.



stock no.	collet no.	collet capacity	length of stock	order number
#A1	A1	1-1/4	7-1/2	423166
#1	1	2	14-1/2	423167
#5	5	2-3/4	23	423168
#5A	5	2-3/4	26	423169
#5B	5	2-3/4	29	423170

Little Giant Jr.® Accessories

Two-Piece Die without collet

Style: **1382**

Carbon Steel **Steam Oxide**

- Use with all Series 380 Little Giant two-piece dies without collet.
- Little Giant Jr. die stocks are designed to use Little Giant dies without collets.
- Double slots enable use of two different size blanks in the same stock.
- Dies fit directly into the stock and are held in place by a screw guide.



stock no.	cutting size	die blank size	guide no.	cutting size range	length of stock	order number
#1	1/4 to 5/16	A	1	1/4 to 1/2	14-1/2	423171
	3/8 to 1/2	B				
#5	9/16 to 3/4	C	5	9/16 to 1	26	423172
	7/8 to 1	D				

Little Giant® Accessories

Spanner Wrench

Style: **A1**

- Because A1 guides are so small and round instead of square, a standard wrench cannot be used.
- Fits into two holes to turn guide.

stock no.	collet no.	collet capacity	order number
#A1	A1	1-1/4	423173



Accessories

Dies - Tap Wrenches
Standard Straight

Style: 300

Note
Used for hand tapping



product number	mach screw	tap size ranges			overall length	order number
		fractional	metric	pipe		
0	0 to 14	1/16 to 1/4	M1.5 to M6.3		7	420910
14	0 to 14	1/16 to 3/8	M1.5 to M10	—	9	423015
5	8 to 14	5/32 to 1/2	M4 to M12.5	1/8	11	420936
6	8 to 14	5/32 to 3/4	M4 to M19	1/8 to 1/4	15	420944
7	—	1/4 to 1-1/8	M12 to M28	1/8 to 3/4	19	420951
8	—	3/4 to 1-5/8	M19 to M40	3/8 to 1-1/4	40	420977
22	—	1 to 2-1/2	M25 to M56	3/4 to 2	54	423016

Dies - Tap Wrenches
Plain T-Handle

Style: 330

Note
Used for hand tapping in out-in-the-open jobs



product number	mach screw	tap size ranges			overall length	order number
		fractional	metric			
T9	0 to 14	1/16 to 1/4	M1.5 to M6.3	2-3/4	420845	
T10	12 to 14	7/32 to 1/2	M5.5 to M12.5	3-5/8	421852	

Dies - Tap Wrenches
Slip T-Handle

Style: 330

Note
Used for hand tapping or in difficult spaces requiring a slip handle



product number	mach screw	tap size ranges			overall length	order number
		fractional	metric			
T11	0 to 14	1/16 to 1/4	M1.5 to M6.3	2-3/4	420803	
T12	12 to 14	7/32 to 1/2	M5.5 to M12.5	3-5/8	420829	

Dies - Tap Wrenches
Combination Ratchet and Slip T-Handle

Style: 330

Note
Used for hand tapping in difficult spaces needing ratchet drive



product number	mach screw	tap size ranges			overall length	order number
		fractional	metric			
T13	0 to 14	1/16 to 1/4	M1.5 to M6.3	3-3/4	420860	
T14	12 to 14	7/32 to 1/2	M5.5 to M12.5	5	420878	

Dies - Tap Wrenches
Long Shank T-Handle

Style: 330

Note
Used for hand tapping where extra reach is required



product number	mach screw	tap size ranges			overall length	order number
		fractional	metric			
T16	0 to 14	1/16 to 1/4	M1.5 to M6.3	8-3/4	423017	
T17	12 to 14	7/32 to 1/2	M5.5 to M12.5	10-5/8	423018	

Machine Taps
Spiral Point Taps
Spiral Flute Taps
Thread Forming Taps
Pipe Taps
Dies
Technical Info
Sets
Index



Screw Extractors

Style: 335



extractor number	small end	large end	OAL	screw & bolt size	pipe size	drill size	order number
# 1	1/16	1/8	2	3-16 - 1/4	-	5/64	421909
# 2	3/32	13/64	2-3/8	1/4 - 5/16	-	7/64	421917
# 3	1/8	1/4	2-11/16	5/16 - 7/16	-	5/32	421925
# 4	3/16	11/32	3	7/16 - 9/16	-	1/4	421933
# 5	1/4	7/16	3-3/8	9/16 - 3/4	1/8, 1/4	9/32	421941
# 6	3/8	19/32	3-3/4	3/4 - 1	3/8	13/32	421958
# 7	1/2	25/32	4-1/8	1 - 1-3/8	-	17/32	421966

Accessories

Screw Extractors

SET

Style: 335

extractor number	order number
# 15 Set 5 pieces sizes # 1 thru # 5	422006

- Machine Taps
- Spiral Point Taps
- Spiral Flute Taps
- Thread Forming Taps
- Pipe Taps
- Dies
- Technical Info
- Sets
- Index



Tapping Speeds

Consider these factors when trying to determine the best tapping speeds.

- Material to be tapped
- Length of chamfer on tap
- Percentage of full thread to be cut
- Length of hole (depth of thread)
- Pitch of thread
- Cutting fluids
- Machine equipment
- Horizontal or vertical tapping

The best and most efficient operating speeds for taps cannot be calculated with the same certainty as for many other metalcutting tools. With other tools, the feed per revolution can be set at any desired point and can be varied as conditions demand. Taps, on the other hand, must always be advanced at a rate equal to one pitch for every revolution. The style of tap may vary the conditions. For example, with a bottoming tap, the first thread on each land cuts the full height of thread, while, with a taper or starting tap, a number of threads do their share of the cutting before the full height of thread is reached.

The depth of thread also varies, depending on the pitch. The coarser the thread, the greater the advance of the tap per revolution and the greater the amount of material removed.

The method of feeding the tap, and the type of equipment for driving, also influence the permissible speeds. If taps are mechanically fed at the proper rate of advance, they can be operated at higher speeds than if they are required to feed themselves and pull some part of the machine along with them.

Speeds may be modified to take into account any or all of the factors listed above. Speeds must be lowered as the length of thread increases, because, in deep thread holes, the accumulated chips increase friction and interfere with lubrication.

Bottoming taps must be run slower than plug taps.

Tapping of full height of thread calls for slower speed than if the commercial 75% height only is required.

Coarse-thread taps in the larger diameters should be run more slowly than fine-thread taps of the same diameters.

The quantity and quality of cutting fluid may affect the permissible speeds as much as 100%.

Taper threaded taps, such as pipe taps, should be operated from 1/2 to 3/4 the speed of a straight thread tap of comparable major diameter.

Tapping Definitions

- SFM = Surface Feet per Minute
- RPM = Revolutions Per Minute
- IPM = Inches Per Minute
- TPI = Threads Per Inch
- S m/m = Surface Meters per Minute
- p = 3.1416
- mm/m = Millimeters per Minute
- P = Pitch (1/ No of Threads Per Inch)

Suggested Speeds for Uncoated and Coated Taps

Work Material	Speed-feet-per-minute	
	Uncoated Tap	Coated Tap
Alloy Steels:		
125-225 Bhn	30-60	60-120
225-325 Bhn	20-45	40-90
325-425 Bhn	10-35	20-70
Aluminum Alloys	75-150	150-300
Carbon Steels, 225 Bhn or less:		
low carbon (.10-.25C)	50-75	100-150
medium carbon (.30-.55C)	40-65	80-130
high carbon (.60-.95C)	30-55	90-110
Cast Iron		
ductile, annealed	40-60	80-120
ductile, as cast	20-45	40-90
gray (class 20, 25)	40-80	80-160
gray (class 30-50)	25-50	50-100
malleable, 200 Bhn or less	30-60	60-120
Copper Alloys	40-100	80-200
Graphites & Carbons	5-10	10-20
High-Temperature Alloys:		
cobalt base (Haynes alloys)	3-8	5-16
iron base (Incoloy, A-286	7-15	15-30
nickel base (Hastelloy, Inconel)	4-10	8-20
Magnesium	100-150	150-200
Plastics	25-50	50-100
Stainless Steels	15-35	30-70
Titanium:		
pure	25-55	50-110
alloys (Ti-6Al-4V)	10-25	20-50
Tool Steels:		
200-275 Bhn	15-30	30-60
300-350 Bhn	10-25	20-50
40-50 Rc	5-15	10-30
Zinc Alloys	100-150	150-250

**Success of coated taps in non-ferrous materials depends on the machining conditions used.*

Tapping Formula

Inch Sizes

$$\begin{aligned} \text{SFM} &= (\text{RPM} \times \text{tool diameter}) / 3.82 \\ &\text{or } 0.26 \times \text{RPM} \times \text{tool diameter} \\ \text{RPM} &= (3.82 \times \text{SFM}) / \text{tool diameter} \\ \text{IPM} &= \text{RPM} / \text{TPI}^* \\ &\text{or } *P \times \text{RPM} \end{aligned}$$

Metric Sizes

$$\begin{aligned} \text{S m/m} &= (\text{p} \times \text{tool diameter} \times \text{RPM}) / 1000 \\ \text{RPM} &= (\text{m/m} \times 1000) / \text{p} \times \text{tool diameter} \\ \text{mm/m} &= \text{mm P} \times \text{RPM} \end{aligned}$$





Tapping Speeds

Tapping Information (continued)

UNC/UNF and NPT/NPTF Sizes

Table with columns for Tap Size, Surface Feet per Minute (SFM), and Revolutions per Minute (RPM) for various sizes from 0 to 2. Includes sub-headers for Machine Taps, Spiral Point Taps, Spiral Flute Taps, Thread Forming Taps, and Pipe Taps.

Metric Sizes

Table with columns for Tap Size, Surface Feet per Minute (SFM), and Revolutions per Minute (RPM) for metric sizes from M1 to M30. Includes sub-headers for Surface Feet per Minute (SFM) and Revolutions per Minute (RPM).



Use this table to match the hardness of your workpiece material to the correct tap.

10 M/M Ball 3000 Kg	120° Cone 150 Kg	1/16" Ball 100 Kg	Model C	1000 Lb. per Sq. In.	10 M/M Ball 3000 Kg	120° Cone 150 Kg	1/16" Ball 100 Kg	Model C	1000 Lb. per Sq. In.
Brinell	Rockwell C	Rockwell B	Shore Scleroscope	Tensile Strength	Brinell	Rockwell C	Rockwell B	Shore Scleroscope	Tensile Strength
800	72	—	100	—	276	30	105	42	136
780	71	—	99	—	269	29	104	41	132
760	70	—	98	—	261	28	103	40	129
745	68	—	97	367	258	27	102	39	127
725	67	—	96	357	255	26	102	39	125
712	66	—	95	350	249	25	101	38	123
682	65	—	93	337	245	24	100	37	119
668	64	—	91	326	240	23	99	36	117
652	63	—	89	318	237	23	99	35	115
626	62	—	87	306	229	22	98	34	113
614	61	—	85	299	224	21	97	33	110
601	60	—	83	292	217	20	96	33	107
590	59	—	81	290	211	19	95	32	104
576	57	—	79	281	206	18	94	32	102
552	56	—	76	270	203	17	94	31	100
545	55	—	75	268	200	16	93	31	98
529	54	—	74	259	196	15	92	30	96
514	53	120	72	254	191	14	92	30	94
502	52	119	70	247	187	13	91	29	92
495	51	119	69	244	185	12	91	29	91
477	49	118	67	233	183	11	90	28	90
461	48	117	66	227	180	10	89	28	89
451	47	117	65	223	175	9	88	27	86
444	46	116	64	219	170	7	87	27	84
427	45	115	62	209	167	6	87	27	82
415	44	115	60	204	165	5	86	26	81
401	43	114	58	196	163	4	85	26	80
388	42	114	57	191	160	3	84	25	78
375	41	113	55	184	156	2	83	25	76
370	40	112	54	182	154	1	82	25	75
362	39	111	53	179	152	—	82	24	74
351	38	111	51	173	150	—	81	24	74
346	37	110	50	170	147	—	80	24	72
341	37	110	49	168	145	—	79	23	71
331	36	109	47	163	143	—	79	23	70
323	35	109	46	158	141	—	78	23	69
311	34	108	46	153	140	—	77	22	69
301	33	107	45	148	135	—	75	22	67
293	32	106	44	144	130	—	72	22	65
285	31	105	43	140					

Machine
Taps

Spiral Point
Taps

Spiral Flute
Taps

Thread Forming
Taps

Pipe Taps

Dies

Technical Info

Sets

Index



Definitions

Nomenclature

Tap Nomenclature

Bottoming Tap

A tap having a chamfer length of 1-2 threads.

Chamfer

The tapering of the threads at the front end of each land of a chaser, tap or die by cutting away and relieving the crest of the first few teeth to distribute the cutting action over several teeth.

Chamfer Angle

The angle formed between the chamfer and the axis of the tap or die by cutting away and relieving the crest of the first few teeth to distribute the cutting action over several teeth.

Crest

The surface of the thread which joins the flanks of the thread and is farthest from the cylinder or cone from which the thread projects.

Flank

The part of a helical thread surface which connects the crest and the root and which is theoretically a straight line in an axial plane section.

Flute

The longitudinal channel formed in a tap to create cutting edges on the thread profile and to provide chip spaces and cutting fluid passage.

Hand of Threads

A thread, when viewed axially, winds in a clockwise and receding direction for LEFT-HAND THREADS and counter-clockwise and receding direction for RIGHT-HAND THREADS.

Hook, Chordal

A concave face having an angle of inclination specified between a chord passing through the root and crest of a thread form at the cutting face, and a radial line through the crest at the cutting edge.

Hook, Tangential

A concave face having an angle of inclination specified between a line tangent to the hook surface at the cutting edge and a radial line to the same point.

Hook Angle

The angle of inclination of a concave face, usually specified either as CHORDAL HOOK or TANGENTIAL HOOK.

Interrupted Thread Tap

A tap having an odd number of lands with alternate teeth in the thread helix removed. In some cases alternate teeth are removed only for a portion of the thread length.

Land

One of the threaded sections between the flutes of a tap.

continued on next page

Illustration of Tap Terms

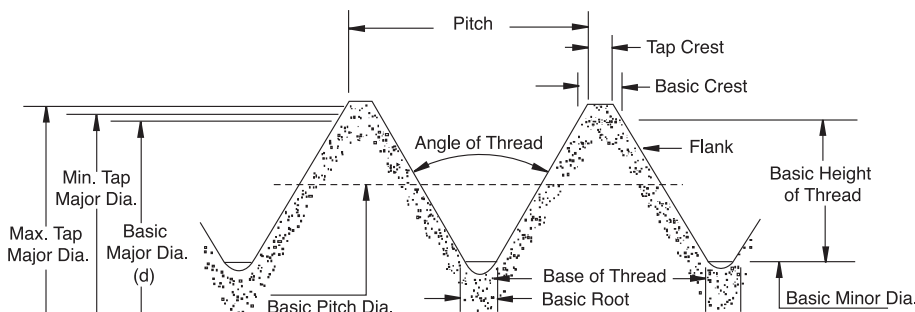

Tap Chamfers

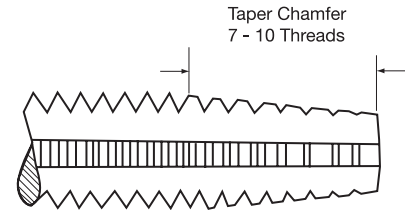

Taper (7 to 10 pitches) – The taper chamfer has the longest standard chamfer ensuring easier starting. It requires less tapping torque because of more working teeth.

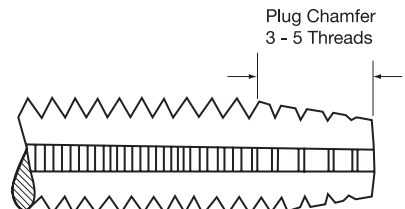

Plug (3 to 5 pitches) – The most common chamfer for use by hand or machine in through or blind holes. This chamfer is more efficient than a bottoming or modified-bottoming chamfer.

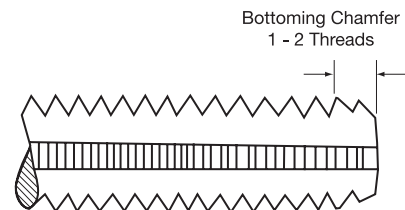

Bottoming (1 to 2 pitches) – For threading close to the bottom of blind holes, the bottoming chamfer is the least efficient chamfer available.

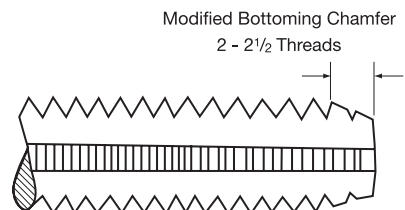

Modified-Bottoming (2 to 2 1/2 pitches) – This short chamfer allows for threading close to the bottom of blind holes. Due to the slightly longer chamfer and more working teeth, this chamfer is more efficient than a bottoming chamfer.

- Machine Taps
- Spiral Point Taps
- Spiral Flute Taps
- Thread Forming Taps
- Pipe Taps
- Dies
- Technical Info
- Sets
- Index

Lead of Thread

The distance a screw thread advances axially in one complete turn. On a single start tap the lead and pitch are identical. On a multiple start tap the lead is the multiple of the pitch.

Major Diameter

The diameter of the major cylinder or cone, at a given position on the axis, that bounds the crests of an external thread or the roots of an internal thread.

Minor Diameter

The diameter of the minor cylinder or cone, at a given position on the axis, that bounds the roots of an external thread or the crests of an internal thread.

Pitch Diameter

The diameter of an imaginary cylinder or cone, at a given point on the axis, of such a diameter and location of its axis that its surface would pass through the thread in such a manner as to make the thread ridge and the thread groove equal and, therefore, is located equidistant between the sharp major and minor cylinders or cones of a given thread form. On a theoretically perfect thread, these widths are equal to one half of the basic pitch (measured parallel to the axis). See illustration below

Plug Tap

A tap with 3 to 5 chamfered threads.

Spiral Point

The angular fluting in the cutting face of the land at the chamfered end. It is formed at an angle with respect to the tap axis of opposite hand to that of rotation. Its length is usually greater than the chamfer length and its angle with respect to the tap axis is usually made great enough to direct the chips ahead of the tap. The tap may or may not have longitudinal flutes.

Square

Four driving flats parallel to the axis on a tap shank forming a square or square with round corners.

Taper Tap

A tap having a chamfer length of 7 to 10 threads.

Pitch Diameter

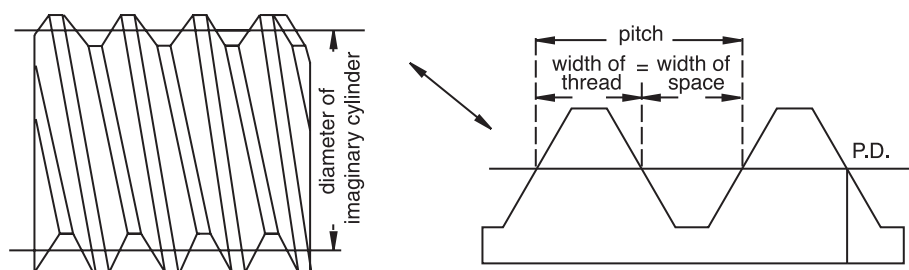

Tap End Views

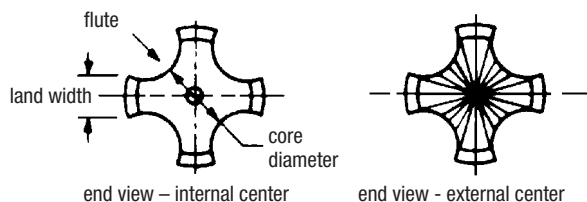

Screw Thread Tolerances

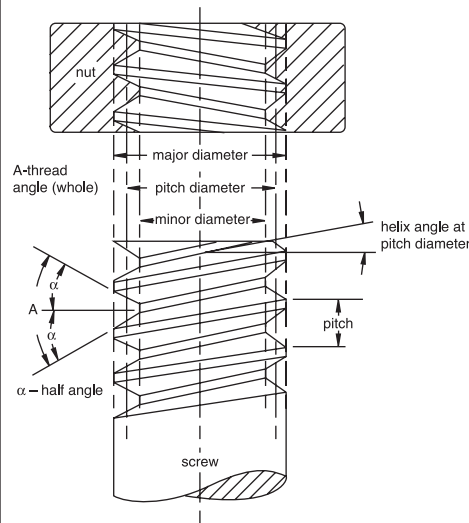

It is generally recognized that, in mass production, it is impossible to reproduce in exact detail the theoretically perfect product as laid out on the drawing board. The allowed slight variation between the theoretically perfect product and each unit of the actual product is called the TOLERANCE.

Allowance

An intentional difference in correlated dimensions of mating parts. It is the minimum clearance or maximum interference between such parts.

Angle of Thread

The angle included between the flanks of the thread measured in an axial plane.

Half Angle of Thread

The angle included between a flank of the thread and the normal (90°) to the axis, measured in an axial plane.

Lead of Thread

The distance a screw thread advances axially in one turn. On a single-thread screw the lead and pitch are identical. On a double thread the lead is 2X pitch, on a triple thread the lead is 3X pitch, etc.

Major Diameter

The largest diameter of a straight screw thread.

Minor Diameter

The smallest diameter of a straight screw thread.

Pitch

The distance from a point on a screw thread to a corresponding point on the next thread measured parallel to the axis. The pitch in inches = $\frac{1}{\text{no. of threads per inch}}$

Machine Taps

Spiral Point Taps

Spiral Flute Taps

Thread Forming Taps

Pipe Taps

Dies

Technical Info

Sets

Index



Definitions

Standard Tap Marking System

Taps, dies, and other threading tools will be marked with the nominal size, number of threads per inch, and the proper symbol to identify the thread form. The symbols below are

in agreement with the ASME B1.7 1965 (R 1972) Standard on nomenclature, definitions and letter symbols for screw threads and other national standards.

Symbol	Reference
ACME-C	Acme Thread-Centralizing
ACME-G	Acme Thread-General Purpose
AMO	American Standard Microscope Objective Thread
ANPT	Aeronautical National Form Taper Pipe Thread (Ground Thread Tap marked NPT)
BA	British Association Standard Thread
BSF	British Standard Fine Thread Series
BSPP	British Standard Pipe (Parallel) Thread
BSPT	British Standard Taper Pipe Thread
BSW	British Standard Whitworth Coarse Thread Series
M	Metric Standard Threads
N	American National 8, 12 and 16 Thread Series (8N, 12N, 16N)
N BUTT	American Buttress Thread
NC	American National Coarse Thread Series
NEF	American National Extra-Fine Thread Series
NF	American National Fine Thread Series
NGO	National Gas Outlet Thread (specify right or left hand)
NGS	National Gas Straight Thread
NGT	National Gas Taper Thread (See also "SGT")
NH	American National Hose Coupling & Firehose Coupling Threads
NPS	For Tap marking Only (See NPSC, NPSM)
NPSC	American National Standard Straight Pipe Thread in Pipe Couplings (Tap Marked NPS)
NPSF	Dryseal American National Standard Fuel Internal Straight Pipe Thread
NPSH	American National Standard Straight Pipe Thread for Hose Couplings
NPSI	Dryseal American National Standard Intermediate Internal Straight Pipe Thread
NPSL	American National Standard Straight Pipe Thread for Loose-Fitting Mechanical Joints with locknuts.
NPSM	American National Standard Straight Pipe Threads for Free-Fitting Mechanical Joints for Fixtures (Tap Marked NPS)
NPT	American National Standard Taper Pipe Thread (see ANPT, NPTR)

Symbol	Reference
NPTF	Dryseal American National Standard Taper Pipe Thread
NPTR	American National Standard Taper Pipe Thread for Railing Joints (Tap Marked NPT)
NR	American National Thread with a 0.108p to 0.144p Controlled Root Radius
NS	American National Thread-Special
PTF-SAE	Short Dryseal SAE Short Taper Pipe Thread
SGT	Special Gas Taper Thread
SPL-PTF	Dryseal Special Taper Pipe Thread
STI	Special Thread for Helical Coil Wire Screw Thread Inserts
Stub Acme	Stub Acme Thread
*UN	Unified Constant-Pitch Thread Series
*UNC	Unified Coarse Thread Series
*UNEF	Unified Extra-Fine Thread Series
*UNF	Unified Fine Thread Series
UNJ	Unified Thread Series with a 0.150lp to 0.18042p Controlled Root Radius on External Thread only.
UNJC	Unified Coarse Thread Series with a 0.150lp to 0.18042p Controlled Root Radius on External Thread only.
UNJF	Unified Fine Thread Series with a 0.150lp to 0.18042p Controlled Root Radius on External Thread only.
UNM	Unified Miniature Thread Series
UNR	Unified Constant-pitch Thread Series with a 0.108p to 0.144p Controlled Root Radius
UNRC	Unified Coarse Thread Series with a 0.108p to 0.144p Controlled Root Radius
UNRF	Unified Fine Thread Series with a 0.108p to 0.144p Controlled Root Radius
*UNS	Unified Thread-Special
V	A 60 "V" thread with Truncated Crest and Root. The theoretical "V" Form is usually flattened to the user's specifications.

*Taps are not marked with "U", but with the symbol for the corresponding American Standard thread form with which it is compatible.

Machine Taps

Spiral Point Taps

Spiral Flute Taps

Thread Forming Taps

Pipe Taps

Dies

Technical Info

Sets

Index



Technical Information
302 / 302A Specifications

Standard Tap Dimensions
Ground Thread

USCTI Table 302

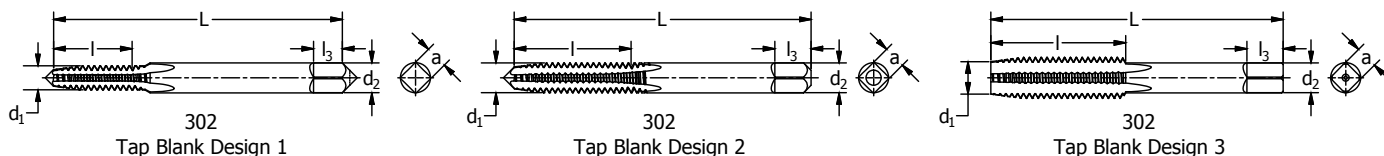

USCTI Table 302A

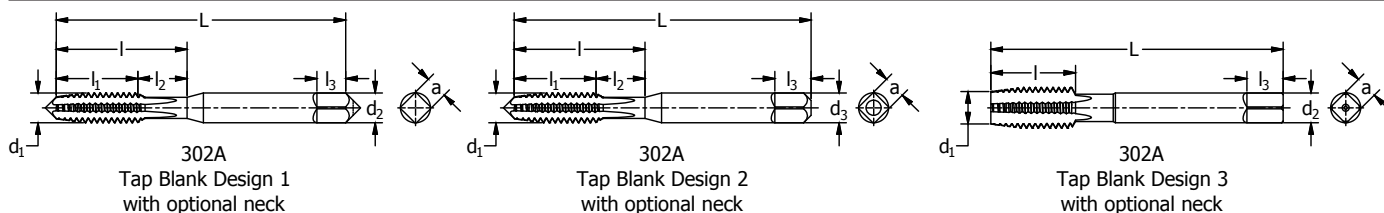

Fractional Sizes

nominal inch diameter d_1		nominal diameter range over to (inclusive)		tap blank design (see above)	overall length L	thread length l	optional length short thd l_1	optional length neck l_2	square length l_3	shank diameter d_2	square size a
fractional	decimal	over	to (inclusive)								
1/4	.2500	.223	.260	2	2.500	1.000	.630	.380	.310	.255	.191
5/16	.3125	.260	.323	2	2.719	1.125	.690	.440	.380	.318	.238
3/8	.3750	.323	.395	2	2.938	1.250	.750	.500	.440	.381	.286
7/16	.4375	.395	.448	3	3.156	1.438	.880	—	.410	.323	.242
1/2	.5000	.448	.510	3	3.375	1.656	.940	—	.440	.367	.275
9/16	.5625	.510	.573	3	3.594	1.656	.000	—	.500	.429	.322
5/8	.6250	.573	.635	3	3.813	1.813	.090	—	.560	.480	.360
11/16	.6875	.635	.709	3	4.031	1.813	1.090	—	.630	.542	.406
3/4	.7500	.709	.760	3	4.250	2.000	1.220	—	.690	.590	.442
13/16	.8125	.760	.823	3	4.470	2.000	1.220	—	.690	.652	.489
7/8	.8750	.823	.885	3	4.688	2.219	1.340	—	.750	.697	.523
15/16	.9375	.885	.948	3	4.910	2.220	1.340	—	.750	.760	.570
1	1.0000	.948	1.010	3	5.125	2.500	1.500	—	.810	.800	.600
1-1/16	1.0625	1.010	1.073	3	5.130	2.500	—	—	.880	.896	.672
1-1/8	1.1250	1.073	1.135	3	5.438	2.563	—	—	.880	.896	.672
1-3/16	1.1875	1.135	1.198	3	5.440	2.560	—	—	1.000	1.021	.766
1-1/4	1.2500	1.198	1.260	3	5.750	2.563	—	—	1.000	1.021	.766
1-5/16	1.3125	1.260	1.323	3	5.750	2.560	—	—	1.060	1.108	.831
1-3/8	1.3750	1.323	1.385	3	6.063	3.000	—	—	1.060	1.108	.831
1-7/16	1.4375	1.358	1.448	3	6.060	3.000	—	—	1.130	1.233	.925
1-1/2	1.5000	1.448	1.510	3	6.375	3.000	—	—	1.130	1.233	.925
1-5/8	1.6250	1.510	1.635	3	6.690	3.190	—	—	1.130	1.305	.979
1-3/4	1.7500	1.635	1.760	3	7.000	3.190	—	—	1.250	1.430	1.072
1-7/8	1.8750	1.760	1.885	3	7.310	3.560	—	—	1.250	1.519	1.139
2	2.0000	1.885	2.010	3	7.630	3.560	—	—	1.380	1.644	1.233

Machine Screw Sizes

nominal inch diameter d_1		nominal diameter range over to (inclusive)		tap blank design (see above)	overall length L	thread length l	optional length short thd l_1	optional length neck l_2	square length l_3	shank diameter d_2	square size a
MS#	decimal	over	to (inclusive)								
0	.0600	.052	.065	1	1.625	.313	—	—	.190	.141	.110
1	.0730	.065	.078	1	1.688	.375	—	—	.190	.141	.110
2	.0860	.078	.091	1	1.750	.438	—	—	.190	.141	.110
3	.0990	.091	.104	1	1.813	.500	—	—	.190	.141	.110
4	.1120	.104	.117	1	1.875	.563	.310	.250	.190	.141	.110
5	.1250	.117	.130	1	1.938	.625	.310	.310	.190	.141	.110
6	.1380	.130	.145	1	2.000	.688	.380	.310	.190	.141	.110
8	.1640	.145	.171	1	2.125	.750	.380	.380	.250	.168	.131
10	.1900	.171	.197	1	2.375	.875	.500	.380	.250	.194	.152
12	.2160	.197	.223	1	2.375	.938	.500	.440	.280	.220	.165

Machine Taps
Spiral Point Taps
Spiral Flute Taps
Thread Forming Taps
Pipe Taps
Dies
Technical Info
Sets
Index



Metric Sizes

	nominal diameter range		tap blank design (see above)	overall length L	thread length l	optional length		square length l₃	shank diameter d₂	square size a	
	mm	decimal				over	to (inclusive)				short thd l₁
M1.6	.063	.052	.065	1	1.625	.313	—	—	.190	.141	.110
M1.8	.071	.065	.078	1	1.688	.375	—	—	.190	.141	.110
M2	.079	.078	.091	1	1.750	.438	—	—	.190	.141	.110
M2.2	.087	.078	.091	1	1.750	.438	—	—	.190	.141	.110
M2.5	.098	.091	.104	1	1.813	.500	—	—	.190	.141	.110
M3	.118	.117	.130	1	1.938	.625	.310	.310	.190	.141	.110
M3.5	.138	.130	.145	1	2.000	.688	.380	.310	.190	.141	.110
M4	.158	.145	.171	1	2.125	.750	.380	.380	.250	.168	.131
M4.5	.177	.171	.197	1	2.375	.875	.500	.380	.250	.194	.152
M5	.197	.171	.197	1	2.375	.875	.500	.440	.250	.194	.152
M6	.236	.223	.260	2	2.500	1.000	.630	.380	.310	.255	.191
M7	.276	.260	.323	2	2.719	1.125	.690	.440	.380	.318	.238
M8	.315	.260	.323	2	2.719	1.125	.690	.440	.380	.318	.238
M10	.394	.323	.395	2	2.938	1.250	.750	.500	.440	.381	.286
M12	.472	.448	.510	3	3.375	1.656	.940	—	.440	.367	.275
M14	.551	.510	.573	3	3.594	1.656	1.000	—	.500	.429	.322
M16	.630	.573	.635	3	3.813	1.813	1.090	—	.560	.480	.360
M18	.709	.635	.709	3	4.031	1.813	1.090	—	.630	.542	.406
M20	.787	.760	.823	3	4.469	2.000	1.220	—	.690	.652	.489
M22	.866	.823	.885	3	4.690	2.220	1.340	—	.750	.697	.523
M24	.945	.885	.948	3	4.906	2.219	1.340	—	.750	.760	.570
M25	.984	.948	1.010	3	5.130	2.500	1.500	—	.810	.800	.600
M27	1.063	1.010	1.073	3	5.130	2.500	—	—	.880	.896	.672
M30	1.181	1.135	1.198	3	5.438	2.563	—	—	1.000	1.021	.766

Standard Tap Dimension Tolerances

nominal diameter range (in.)		overall length L	thread length l	tolerances (in.)		
over	to (inc.)			square length l₃	shank diameter d₂	square size a
.0520	.2230	+/- .031	+/- .047	+/- .031	-.0015	-.004
.2230	.5100	+/- .031	+/- .063	+/- .031	-.0015	-.004
.5100	.6350	+/- .031	+/- .094	+/- .031	-.0015	-.006
.6350	1.0100	+/- .031	+/- .094	+/- .031	-.0020	-.006
1.0100	1.5100	+/- .063	+/- .094	+/- .063	-.0020	-.008
1.5100	2.0100	+/- .063	+/- .125	+/- .063	-.0030	-.008
2.0100	4.0100	+/- .063	+/- .125	+/- .063	-.0030	-.010

Machine Taps
Spiral Point Taps
Spiral Flute Taps
Thread Forming Taps
Pipe Taps
Dies
Technical Info
Sets
Index

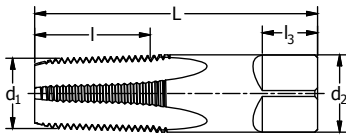

311
Pipe Tap Blank Design 1

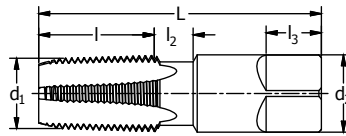

311
Pipe Tap Blank Design 2
with optional neck

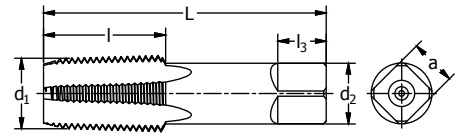

311
Pipe Tap Blank Design 3

Inch Pipe Tap Sizes

nominal inch diameter d1		tap blank design (see above)	overall length L	thread length l1	optional neck length l2	square length l3	shank diameter d2	square size a
fractional	decimal							
1/16	.0625	1 or 2	2.130	.690	.375	.380	.3125	.234
1/8	.1250	1	2.130	.750	—	.380	.3125	.234
1/8	.1250	1 or 2	2.130	.750	.375	.380	.4375	.328
1/4	.2500	1 or 2	2.440	1.060	.375	.440	.5625	.421
3/8	.3750	1 or 2	2.560	1.060	.375	.500	.7000	.531
1/2	.5000	1	3.130	1.380	—	.630	.6875	.515
3/4	.7500	1	3.250	1.380	—	.690	.9063	.679
1	1.0000	1	3.750	1.750	—	.810	1.1250	.843
1-1/4	1.2500	1	4.000	1.750	—	.940	1.3125	.984
1-1/2	1.5000	1	4.250	1.750	—	1.000	1.5000	1.125
2	2.0000	3	4.500	1.750	—	1.130	1.8750	1.406

Standard Pipe Tap Dimension Tolerances

nominal inch diameter d1		overall length L	thread length l1	square length l3	shank diameter d2	square size a
fractional	decimal					
1/16	.0625	+/- .031	+/- .063	+/- .031	-.0015	-.004
1/8	.1250	+/- .031	+/- .063	+/- .031	-.0015	-.004
1/8	.1250	+/- .031	+/- .063	+/- .031	-.0015	-.004
1/4	.2500	+/- .031	+/- .063	+/- .031	-.0020	-.006
3/8	.3750	+/- .031	+/- .063	+/- .031	-.0020	-.006
1/2	.5000	+/- .031	+/- .063	+/- .031	-.0020	-.006
3/4	.7500	+/- .031	+/- .063	+/- .031	-.0020	-.006
1	1.0000	+/- .063	+/- .094	+/- .063	-.0020	-.008
1-1/4	1.2500	+/- .063	+/- .094	+/- .063	-.0030	-.008
1-1/2	1.5000	+/- .063	+/- .125	+/- .063	-.0030	-.008
2	2.0000	+/- .063	+/- .125	+/- .063	-.0030	-.008

Thread Limits – Taper Pipe Taps – Ground Thread

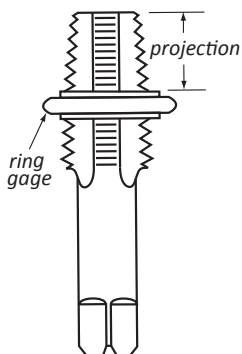

nominal tap size (inch)	threads per inch	projection (inch)	projection tolerance +/- inch	taper per foot (inch)		ring gage thickness	tap drill size NPT, ANPT, NPTF
				min.	max.		
1/16	27	.312	.063	.719	.781	.160	C
1/8	27	.312	.063	.719	.781	.1615	Q
1/4	18	.459	.063	.719	.781	.2278	7/16
3/8	18	.454	.063	.719	.781	.240	9/16
1/2	14	.579	.063	.719	.781	.320	45/64
3/4	14	.565	.063	.719	.781	.339	29/32
1	11-1/2	.678	.094	.719	.781	.400	1 9/64
1-1/4	11-1/2	.686	.094	.719	.781	.420	1 31/64
1-1/2	11-1/2	.699	.094	.719	.781	.420	1 23/32
2	11-1/2	.667	.094	.719	.781	.436	2 3/16

Machine Taps
Spiral Point Taps
Spiral Flute Taps
Thread Forming Taps
Pipe Taps
Dies
Technical Info
Sets
Index



Thread Limits

Unified and American National Form

Fractional Taps – Ground Thread

Lead Tolerance

A maximum lead error of + / - .0005" in 1" of thread is permitted.

Angle Tolerance

Threads Per Inch	Error in Half Angle
6 to 9 inclusive	25' + / -
10 to 28 inclusive	30' + / -

Pitch Diameter Limits

for taps through 1" diameter:

- H1 = basic to basic plus .0005"
- H2 = basic plus .0005" to basic plus .001"
- H3 = basic plus .001" to basic plus .0015"
- H4 = basic plus .0015" to basic plus .002"
- H5 = basic plus .002" to basic plus .0025"
- H6 = basic plus .0025" to basic plus .003"

for Taps over 1" Diameter Through 1-1/2" diameter:

- H4 = basic plus .001" to basic plus .002"

Formulae (Approximate)

- Max. Major Diameter = Basic Major Diameter + A*
 - Min. Major Diameter = Max. Major Diameter - B*
- *See USCTI Table 331.*

Thread Limits

nom size	threads per inch			major diameter			basic pitch dia	pitch diameter limits											
	NC UNC	NF UNF	NS UNS	basic	min	max		H1 limit		H2 limit		H3 limit		H4 limit		H5 limit		H6 limit	
								min	max	min	max	min	max	min	max	min	max	min	max
1/4	20	-	-	.2500	.2540	.2550	.2175	.2175	.2180	.2180	.2185	.2185	.2190	-	-	.2195	.2200	-	-
1/4	-	28	-	.2500	.2525	.2535	.2268	.2268	.2273	.2273	.2278	.2278	.2283	.2283	.2288	-	-	-	-
5/16	18	-	-	.3125	.3170	.3180	.2764	.2764	.2769	.2769	.2774	.2774	.2779	-	-	.2784	.2789	-	-
5/16	-	24	-	.3125	.3155	.3165	.2854	.2854	.2859	.2859	.2864	.2864	.2869	.2869	.2874	-	-	-	-
3/8	16	-	-	.3750	.3800	.3810	.3344	.3344	.3349	.3349	.3354	.3354	.3359	-	-	.3364	.3369	-	-
3/8	-	24	-	.3750	.3780	.3790	.3479	.3479	.3484	.3484	.3489	.3489	.3494	.3494	.3499	-	-	-	-
7/16	14	-	-	.4375	.4435	.4445	.3911	-	-	.3916	.3921	.3921	.3926	-	-	.3931	.3936	-	-
7/16	-	20	-	.4375	.4415	.4425	.4050	-	-	-	.4060	.4065	.4065	-	-	.4070	.4075	-	-
1/2	13	-	-	.5000	.5065	.5075	.4500	.4500	.4505	.4505	.4510	.4510	.4515	-	-	.4520	.4525	-	-
1/2	-	20	-	.5000	.5040	.5050	.4675	.4675	.4680	.4680	.4685	.4685	.4690	-	-	.4695	.4700	-	-
9/16	12	-	-	.5625	.5690	.5700	.5084	-	-	.5089	-	-	.5099	-	-	.5104	.5109	-	-
9/16	-	18	-	.5625	.5670	.5680	.5264	-	-	.5269	.5274	.5274	.5279	-	-	.5284	.5289	-	-
5/8	11	-	-	.6250	.6320	.6330	.5660	-	-	.5665	.5670	.5670	.5675	-	-	.5680	.5685	-	-
5/8	-	18	-	.6250	.6295	.6305	.5889	-	-	.5894	.5899	.5899	.5904	-	-	.5909	.5914	-	-
11/16	-	-	11	.6875	.6945	.6955	.6285	-	-	-	-	.6295	.6300	-	-	-	-	-	-
11/16	-	-	16	.6875	.6925	.6935	.6469	-	-	-	-	.6479	.6484	-	-	-	-	-	-
3/4	10	-	-	.7500	.7575	.7590	.7094	-	.6855	.6855	.6860	.6860	.6865	-	-	.6870	.6875	-	-
3/4	-	16	-	.7500	.7550	.7560	.7094	.7094	.7099	.7099	.7104	.7104	.7109	-	-	.7114	.7119	-	-
7/8	9	-	-	.8750	.8835	.8850	.8028	-	-	-	-	-	-	.8043	.8048	-	-	.8053	.8058
7/8	-	14	-	.8750	.8810	.8820	.8286	-	-	.8291	.8296	-	-	.8301	.8306	-	-	.8311	.8316
1	8	-	-	1.0000	1.0095	1.0110	.9188	-	-	.9193	.9198	-	-	.9203	.9208	-	-	.9213	.9218
1	-	12	-	1.0000	1.0065	1.0075	.9459	-	-	-	-	-	-	.9474	.9479	-	-	-	-
1	-	-	14	1.0000	1.0060	1.0070	.9536	-	-	-	-	-	-	.9551	.9556	-	-	-	-
1 1/8	7	-	-	1.1250	1.1350	1.1370	1.0322	-	-	-	-	-	-	1.0332	1.0342	-	-	-	-
1-1/8	-	12	-	1.1250	1.1320	1.1325	1.0709	-	-	-	-	-	-	1.0719	1.0729	-	-	-	-
1-1/4	7	-	-	1.2500	1.2600	1.2620	1.1572	-	-	-	-	-	-	1.1582	1.1592	-	-	-	-
1-1/4	-	12	-	1.2500	1.2565	1.2575	1.1959	-	-	-	-	-	-	1.1969	1.1979	-	-	-	-
1-3/8	6	-	-	1.3750	1.3870	1.3890	1.2667	-	-	-	-	-	-	1.2677	1.2687	-	-	-	-
1-3/8	-	12	-	1.3750	1.3815	1.3825	1.3209	-	-	-	-	-	-	1.3219	1.3229	-	-	-	-
1-1/2	6	-	-	1.5000	1.5120	1.5140	1.3917	-	-	-	-	-	-	1.3927	1.3937	-	-	-	-
1 1/2	-	12	-	1.5000	1.5070	1.5075	1.4459	-	-	-	-	-	-	1.4469	1.4479	-	-	-	-



Machine Screw Taps – Ground Thread

Lead Tolerance

A maximum lead error of + / - .0005" in 1" of thread is permitted.

Angle Tolerance

Threads Per Inch Error in Half Angle
20 to 80 inclusive 30' + / -

Pitch Diameter Limits

H1 = basic to basic + .0005" to basic + .001"
H2 = basic + .0005" to basic + .001"
H3 = basic + .001" to basic + .0015"
H7 = basic + .003" to basic + .0035"

Formulae

Max. Major Diameter= Basic Major Diameter + A
Min. Major Diameter= Max. Major Diameter - B

A = Constant to add: 45% of the theoretical truncation to nearest .0005"
B = Major diameter tolerance.

Thread Limits

nom size	threads per inch			major diameter			basic pitch dia	pitch diameter limits							
	NC UNC	NF UNF	NS UNS	basic	min	max		H1 limit		H2 limit		H3 limit		H7 limit	
								min	max	min	max	min	max	min	max
0	-	80	-	.0600	.0605	.0615	.0519	.0519	.0524	.0524	.0529	-	-	-	-
1	64	-	-	.0730	.0735	.0745	.0629	.0629	.0634	.0634	.0639	-	-	-	-
1	-	72	-	.0730	.0735	.0745	.0640	.0640	.0645	.0645	.0650	-	-	-	-
2	56	-	-	.0860	.0865	.0875	.0744	.0744	.0749	.0749	.0754	-	-	-	-
2	-	64	-	.0860	.0865	.0875	.0759	-	-	.0764	.0769	-	-	-	-
3	48	-	-	.0990	.1000	.1010	.0855	.0855	.0860	.0860	.0865	-	-	-	-
3	-	56	-	.0990	.0995	.1005	.0874	.0874	.0879	.0879	.0884	-	-	-	-
4	-	-	36	.1120	.1135	.1145	.0940	-	-	.0945	.0950	-	-	-	-
4	40	-	-	.1120	.1135	.1145	.0958	.0958	.0963	.0963	.0968	-	-	-	-
4	-	48	-	.1120	.1130	.1140	.0985	.0985	.0990	.0990	.0995	-	-	-	-
5	40	-	-	.1250	.1265	.1275	.1088	.1088	.1093	.1093	.1098	-	-	-	-
5	-	44	-	.1250	.1260	.1270	.1102	-	-	.1107	.1112	-	-	-	-
6	32	-	-	.1380	.1400	.1410	.1177	.1177	.1182	.1182	.1187	.1187	.1192	.1207	.1212
6	-	40	-	.1380	.1395	.1405	.1218	.1218	.1223	.1223	.1228	-	-	-	-
8	32	-	-	.1640	.1660	.1670	.1437	.1437	.1442	.1442	.1447	.1447	.1452	.1467	.1472
8	-	36	-	.1640	.1655	.1665	.1460	-	-	.1465	.1470	-	-	-	-
10	24	-	-	.1900	.1930	.1940	.1629	.1629	.1634	.1634	.1639	.1639	.1644	.1659	.1664
10	-	32	-	.1900	.1920	.1930	.1697	.1697	.1702	.1702	.1707	.1707	.1712	.1727	.1732
12	24	-	-	.2160	.2190	.2200	.1889	-	-	-	-	.1899	.1904	-	-
12	-	28	-	.2160	.2185	.2195	.1928	-	-	-	-	.1938	.1943	-	-





Thread Limits

Metric Taps

Ground Thread

General

These tables and formulae are used in determining the limits and tolerances for ground thread metric taps unless otherwise specified. They apply only to metric threads having a 60° form with a P/8 flat at the major diameter of the basic thread form.

Note: When the tap major diameter must be determined from a specific tap pitch diameter, the minimum major diameter equals the maximum specified tap pitch diameter minus constant Y, plus the basic size height of thread (.64952P), plus constant W.

Lead Tolerance

A maximum lead error of + / - .0005" in 1" of thread is permitted.

Angle Tolerance

Pitch mm	Deviation in Half Angle
over 0.25 to 2.5 inclusive	30' + / -
over 2.5 to 4 inclusive	25' + / -
over 4 to 6 inclusive	20' + / -

Formulae

- Max. Major Diameter = Min. + X
- Min. Major Diameter = Basic + W
- Max. Pitch Diameter = Basic + Y
- Min. Pitch Diameter = Max. - Z
- W = Constant to add to Basic Major Diameter (.080P converted to inches)
- X = Major Diameter Tolerance
- Y = Amount over Basic for Maximum Pitch Diameter
- Z = Pitch Diameter Tolerance

Values for W, X, Y and Z (inches)

pitch mm	inch equivalent	W	X	Y	Y	Y	Y	Z	Z	Z	Z
		inch	inch	M1.6 thru M6.3	over M6.3 thru M25	over M25 thru M90	over M90	M1.6 thru M6.3	over M6.3 thru M25	over M25 thru M90	over M90
0.3	.01181	.0009	.0010	.0015	.0015	.0020	.0020	.0006	.0006	.0008	.0008
0.35	.01378	.0011	.0010	.0015	.0015	.0020	.0020	.0006	.0006	.0008	.0008
0.4	.01575	.0013	.0010	.0015	.0020	.0020	.0020	.0006	.0006	.0008	.0010
0.45	.01772	.0014	.0010	.0015	.0020	.0020	.0020	.0006	.0008	.0008	.0010
0.5	.01968	.0016	.0010	.0015	.0020	.0020	.0025	.0006	.0008	.0010	.0010
0.6	.02362	.0019	.0010	.0020	.0020	.0025	.0025	.0008	.0008	.0010	.0010
0.7	.02756	.0022	.0016	.0020	.0020	.0025	.0025	.0008	.0008	.0010	.0010
0.75	.02953	.0024	.0016	.0020	.0025	.0025	.0030	.0008	.0010	.0010	.0012
0.8	.03150	.0025	.0016	.0020	.0025	.0025	.0030	.0008	.0010	.0010	.0012
0.9	.03543	.0028	.0016	.0020	.0025	.0025	.0030	.0008	.0010	.0010	.0012
1	.03937	.0032	.0016	.0025	.0025	.0030	.0030	.0010	.0010	.0012	.0012
1.25	.04921	.0039	.0025	.0025	.0025	.0030	.0035	.0010	.0012	.0012	.0016
1.5	.05906	.0047	.0025	.0025	.0030	.0030	.0035	.0010	.0012	.0012	.0016
1.75	.06890	.0055	.0025	—	.0030	.0035	.0040	—	.0012	.0016	.0016
2	.07874	.0063	.0025	—	.0035	.0035	.0040	—	.0016	.0016	.0016
2.5	.09843	.0079	.0025	—	.0035	.0040	.0045	—	.0016	.0016	.0020
3	.11811	.0095	.0039	—	.0040	.0040	.0050	—	.0016	.0020	.0020
3.5	.13780	.0110	.0039	—	.0040	.0045	.0050	—	.0016	.0020	.0020
4	.15748	.0126	.0039	—	.0040	.0045	.0055	—	.0020	.0020	.0025
4.5	.17717	.0142	.0039	—	—	.0050	.0055	—	.0020	.0020	.0025
5	.19685	.0158	.0039	—	—	.0050	.0060	—	—	.0025	.0025
5.5	.21654	.0158	.0039	—	—	.0050	.0060	—	—	.0025	.0025
6	.23622	.0189	.0039	—	—	.0055	.0060	—	—	.0025	.0025



Technical Information

Fractional Sizes

Basic Thread Dimensions

nominal size & TPI	basic major diameter	basic pitch diameter	basic minor diameter	max minor diameter Class 3B internal thread
1/16	64	.0625	.0524	.0422
3/32	48	.0938	.0803	.0667
1/8	40	.1250	.1088	.0925
5/32	32	.1563	.1360	.1157
5/32	36	.1563	.1382	.1202
3/16	24	.1875	.1604	.1334
3/16	32	.1875	.1672	.1469
7/32	24	.2188	.1917	.1646
7/32	32	.2188	.1985	.1782
1/4	20	.2500	.2175	.1850
1/4	24	.2500	.2229	.1959
1/4	28	.2500	.2268	.2036
1/4	32	.2500	.2297	.2094
5/16	18	.3125	.2764	.2403
5/16	20	.3125	.2800	.2476
5/16	24	.3125	.2854	.2584
5/16	32	.3125	.2922	.2719
3/8	16	.3750	.3344	.2938
3/8	20	.3750	.3425	.3100
3/8	24	.3750	.3479	.3209
3/8	32	.3750	.3547	.3344
7/16	14	.4375	.3911	.3447
7/16	20	.4375	.4050	.3726
7/16	24	.4375	.4104	.3834
7/16	28	.4375	.4143	.3911
1/2	12	.5000	.4459	.3918
1/2	13	.5000	.4500	.4001
1/2	20	.5000	.4675	.4351
1/2	24	.5000	.4729	.4459
1/2	28	.5000	.4768	.4536
9/16	12	.5625	.5084	.4542
9/16	18	.5625	.5264	.4903
9/16	24	.5625	.5354	.5084
5/8	11	.6250	.5660	.5069
5/8	12	.6250	.5709	.5168
5/8	18	.6250	.5889	.5528
5/8	24	.6250	.5979	.5709
11/16	11	.6875	.6285	.5694
11/16	12	.6875	.6334	.5793
11/16	16	.6875	.6469	.6063
11/16	24	.6875	.6604	.6334
3/4	10	.7500	.6850	.6201
3/4	12	.7500	.6959	.6418

nominal size & TPI	basic major diameter	basic pitch diameter	basic minor diameter	max minor diameter Class 3B internal thread
3/4	16	.7500	.7094	.6688
3/4	20	.7500	.7175	.6850
13/16	12	.8125	.7584	.7042
13/16	16	.8125	.7719	.7313
13/16	20	.8125	.7800	.7475
7/8	9	.8750	.8028	.7307
7/8	12	.8750	.8209	.7668
7/8	14	.8750	.8286	.7822
7/8	16	.8750	.8344	.7938
7/8	18	.8750	.8389	.8028
7/8	20	.8750	.8425	.8100
15/16	12	.9375	.8834	.8293
15/16	16	.9375	.8969	.8563
15/16	20	.9375	.9050	.8725
1	8	1.0000	.9188	.8376
1	12	1.0000	.9459	.8918
1	14	1.0000	.9536	.9072
1	16	1.0000	.9594	.9188
1	20	1.0000	.9675	.9350
1 1/16	12	1.0625	1.0084	.9543
1 1/16	16	1.0625	1.0219	.9813
1 1/16	18	1.0625	1.0264	.9903
1 1/8	7	1.1250	1.0322	.9394
1 1/8	8	1.1250	1.0438	.9626
1 1/8	12	1.1250	1.0709	1.0168
1 1/8	16	1.1250	1.0844	1.0438
1 1/8	18	1.1250	1.0889	1.0528
1 3/16	12	1.1875	1.1334	1.0793
1 3/16	16	1.1875	1.1469	1.1063
1 3/16	18	1.1875	1.1514	1.1153
1 1/4	7	1.2500	1.1572	1.0644
1 1/4	8	1.2500	1.1688	1.0876
1 1/4	12	1.2500	1.1959	1.1418
1 1/4	16	1.2500	1.2094	1.1688
1 1/4	18	1.2500	1.2139	1.1778
1 5/16	12	1.3125	1.2584	1.2043
1 5/16	16	1.3125	1.2719	1.2313
1 5/16	18	1.3125	1.2764	1.2403
1 3/8	6	1.3750	1.2667	1.1585
1 3/8	8	1.3750	1.2938	1.2126
1 3/8	12	1.3750	1.3209	1.2668
1 3/8	16	1.3750	1.3344	1.2938
1 3/8	18	1.3750	1.3389	1.3028

continued on next page

- Machine Taps
- Spiral Point Taps
- Spiral Flute Taps
- Thread Forming Taps
- Pipe Taps
- Dies
- Technical Info
- Sets
- Index



Basic Thread Dimensions

Fractional Sizes (continued)

Machine Taps

Spiral Point Taps

Spiral Flute Taps

Thread Forming Taps

Pipe Taps

Dies

Technical Info

Sets

Index

nominal size & TPI		basic major diameter	basic pitch diameter	basic minor diameter	max minor diameter Class 3B internal thread	nominal size & TPI		basic major diameter	basic pitch diameter	basic minor diameter	max minor diameter Class 3B internal thread
1 7/16	12	1.4375	1.3834	1.3293	1.3573	2 7/16	16	2.4375	2.3969	2.3563	2.3783
1 7/16	16	1.4375	1.3969	1.3563	1.3783	2 1/2	4	2.5000	2.3376	2.1752	2.2594
1 7/16	18	1.4375	1.4014	1.3653	1.3855	2 1/2	8	2.5000	2.4188	2.3376	2.3797
1 1/2	6	1.5000	1.3917	1.2835	1.3396	2 1/2	12	2.5000	2.4459	2.3918	2.4198
1 1/2	8	1.5000	1.4188	1.3376	1.3797	2 1/2	16	2.5000	2.4594	2.4188	2.4408
1 1/2	12	1.5000	1.4459	1.3918	1.4198	2 5/8	12	2.6250	2.5709	2.5168	2.5448
1 1/2	16	1.5000	1.4594	1.4188	1.4408	2 5/8	16	2.6250	2.5844	2.5438	2.5658
1 1/2	18	1.5000	1.4639	1.4278	1.4480	2 3/4	4	2.7500	2.5876	2.4252	2.5094
1 1/2	16	1.5625	1.5219	1.4813	1.5033	2 3/4	8	2.7500	2.6688	2.5876	2.6297
1 1/2	18	1.5625	1.5264	1.4903	1.5105	2 3/4	12	2.7500	2.6959	2.6418	2.6698
1 5/8	6	1.6250	1.5167	1.4085	1.4646	2 3/4	16	2.7500	2.7094	2.6688	2.6908
1 5/8	8	1.6250	1.5438	1.4626	1.5047	2 7/8	12	2.8750	2.8209	2.7668	2.7948
1 5/8	12	1.6250	1.5709	1.5168	1.5448	2 7/8	16	2.8750	2.8344	2.7938	2.8158
1 5/8	16	1.6250	1.5844	1.5438	1.5658	3	4	3.0000	2.8376	2.6752	2.7594
1 5/8	18	1.6250	1.5889	1.5528	1.5730	3	8	3.0000	2.9188	2.8376	2.8797
1 11/16	16	1.6875	1.6469	1.6063	1.6283	3	12	3.0000	2.9459	2.8918	2.9198
1 11/16	18	1.6875	1.6514	1.6153	1.6355	3	16	3.0000	2.9594	2.9188	2.9408
1 3/4	5	1.7500	1.6201	1.4902	1.5575	3 1/8	12	3.1250	3.0709	3.0168	3.0448
1 3/4	8	1.7500	1.6688	1.5876	1.6297	3 1/8	16	3.1250	3.0844	3.0438	3.0658
1 3/4	12	1.7500	1.6959	1.6418	1.6698	3 1/4	4	3.2500	3.0876	2.9252	3.0094
1 3/4	16	1.7500	1.7094	1.6688	1.6908	3 1/4	8	3.2500	3.1688	3.0876	3.1297
1 13/16	16	1.8125	1.7719	1.7313	1.7533	3 1/4	12	3.2500	3.1959	3.1418	3.1698
1 7/8	8	1.8750	1.7938	1.7126	1.7547	3 1/4	16	3.2500	3.2094	3.1688	3.1908
1 7/8	12	1.8750	1.8209	1.7668	1.7948	3 3/8	12	3.3750	3.3209	3.2668	3.2948
1 7/8	16	1.8750	1.8344	1.7938	1.8158	3 3/8	16	3.3750	3.3344	3.2938	3.3158
1 15/16	16	1.9375	1.8969	1.8563	1.8783	3 3/8	4	3.5000	3.3376	3.1752	3.2594
2	4 1/2	2.0000	1.8557	1.7113	1.7861	3 1/2	8	3.5000	3.4188	3.3376	3.3797
2	8	2.0000	1.9188	1.8376	1.8797	3 1/2	12	3.5000	3.4459	3.3918	3.4198
2	12	2.0000	1.9459	1.8918	1.9198	3 1/2	16	3.5000	3.4594	3.4188	3.4408
2	16	2.0000	1.9594	1.9188	1.9408	3 5/8	12	3.6250	3.5709	3.5168	3.5448
2 1/16	16	2.0625	2.0219	1.9813	2.0033	3 5/8	16	3.6250	3.5844	3.5438	3.5658
2 1/8	8	2.1250	2.0438	1.9626	2.0047	3 3/4	4	3.7500	3.5876	3.4252	3.5094
2 1/8	12	2.1250	2.0709	2.0168	2.0448	3 3/4	8	3.7500	3.6688	3.5876	3.6297
2 1/8	16	2.1250	2.0844	2.0438	2.0658	3 3/4	12	3.7500	3.6959	3.6418	3.6698
2 3/16	16	2.1875	2.1469	2.1063	2.1283	3 3/4	16	3.7500	3.7094	3.6686	3.6908
2 1/4	4 1/2	2.2500	2.1057	1.9613	2.0361	3 7/8	12	3.8750	3.8209	3.7669	3.7948
2 1/4	8	2.2500	2.1688	2.0876	2.1297	3 7/8	16	3.8750	3.8344	3.7938	3.8158
2 1/4	12	2.2500	2.1959	2.1418	2.1698	4	4	4.0000	3.8376	3.6752	3.7594
2 1/4	16	2.2500	2.2094	2.1688	2.1908	4	8	4.0000	3.9188	3.8376	3.8797
2 5/16	16	2.3125	2.2719	2.2313	2.2533	4	12	4.0000	3.9459	3.8918	3.9198
2 3/8	12	2.3750	2.3209	2.2668	2.2948	4	16	4.0000	3.9594	3.9188	3.9408
2 3/8	16	2.3750	2.3344	2.2938	2.3158	4	16	1.8125	1.7719	1.7313	1.7533



Thread Dimensions

nominal size & TPI		basic major diameter	basic pitch diameter	basic minor diameter	max minor diameter Class 3B internal thread	nominal size & TPI		basic major diameter	basic pitch diameter	basic minor diameter	max minor diameter Class 3B internal thread
0	80	.0600	.0519	.0438	.0514	6	32	.1380	.1177	.0974	.1140
1	64	.0730	.0629	.0527	.0623	6	36	.1380	.1200	.1019	.1165
1	72	.0730	.0640	.0550	.0635	6	40	.1380	.1218	.1055	.1186
2	56	.0860	.0744	.0628	.0737	8	32	.1640	.1437	.1234	.1389
2	64	.0860	.0759	.0657	.0753	8	36	.1640	.1460	.1279	.1416
3	48	.0990	.0855	.0719	.0845	8	40	.1640	.1478	.1315	.1437
3	56	.0990	.0874	.0758	.0865	10	24	.1900	.1629	.1359	.1516
4	32	.1120	.0917	.0714	.0880	10	28	.1900	.1668	.1436	.1604
4	36	.1120	.0940	.0759	.0919	10	30	.1900	.1684	.1467	.1630
4	40	.1120	.0958	.0795	.0939	10	32	.1900	.1697	.1494	.1641
4	48	.1120	.0985	.0849	.0968	12	24	.2160	.1889	.1619	.1807
5	40	.1250	.1088	.0925	.1062	12	28	.2160	.1928	.1696	.1857
5	44	.1250	.1102	.0955	.1079	12	32	.2160	.1957	.1754	.1895
						14	20	.2420	.2095	.1770	.1987
						14	24	.2420	.2149	.1879	.2059

Constants for Finding Pitch Diameter and Minor Diameter of Screw Threads

Basic Pitch Diameter = Basic Major Diameter – Constant for Basic Pitch Diameter for TPI

Basic Minor Diameter = Basic Major Diameter – Constant for Basic Minor Diameter for TPI

threads per inch	pitch in	pitch mm	constant for basic pitch dia.		constant for basic minor dia.		threads per inch	pitch in	pitch mm	constant for basic pitch dia.		constant for basic minor dia.	
			Unified	ISO	Unified	ISO				Unified	ISO		
-	.0079	0.2	-	.00511	-	.01022	18	.0555	-	.03608	-	.07216	-
-	.0088	0.225	-	.00575	-	.01150	-	.0590	1.5	-	.03836	-	.07672
-	.0098	0.25	-	.00639	-	.01278	16	.0625	-	.04060	-	.08120	-
-	.0118	0.3	-	.00767	-	.01534	-	.0689	1.75	-	.04475	-	.08950
80	.0125	-	.00812	-	.01624	-	14	.0714	-	.04639	-	.09278	-
-	.0138	0.35	-	.00895	-	.01790	13	.0769	-	.04996	-	.09992	-
72	.0139	-	.00902	-	.01804	-	-	.0787	2.0	-	.05117	-	.10228
64	.0156	-	.01015	-	.02030	-	12	.0833	-	.05413	-	.10826	-
-	.0157	0.4	-	.01023	-	.02046	11.5	.0869	-	.05648	-	.11296	-
-	.0177	0.45	-	.01151	-	.02302	11	.0909	-	.05905	-	.11810	-
56	.0178	-	.01160	-	.02320	-	-	.0984	2.5	-	.06393	-	.12786
-	.0197	0.5	-	.01279	-	.02558	10	.1000	-	.06495	-	.12990	-
48	.0208	-	.01353	-	.02706	-	9	.1111	-	.07217	-	.14434	-
44	.0227	-	.01476	-	.02952	-	-	.1181	3.0	-	.07672	-	.15344
-	.0236	0.6	-	.01534	-	.03068	8	.1250	-	.08119	-	.16238	-
40	.0250	-	.01624	-	.03248	-	-	.1378	3.5	-	.08950	-	.17900
-	.0275	0.7	-	.01790	-	.03580	7	.1428	-	.09279	-	.18558	-
36	.0278	-	.01804	-	.03608	-	-	.1575	4.0	-	.10229	-	.20458
-	.0295	0.75	-	.01918	-	.03836	6	.1667	-	.10825	-	.21650	-
32	.0312	-	.02030	-	.04060	-	-	.1772	4.5	-	.11507	-	.23014
-	.0315	0.8	-	.02046	-	.04092	5	.1968	-	.12786	-	.25572	-
28	.0357	-	.02320	-	.04640	-	4.5	.2000	-	.12990	-	.25980	-
27	.0370	-	.02406	-	.04812	-	-	.2165	5.5	-	.14064	-	.28128
-	.0394	1.0	-	.02557	-	.05114	4.5	.2222	-	.14434	-	.28868	-
24	.0417	-	.02706	-	.05412	-	-	.2362	6.0	-	.15343	-	.30353
-	.0492	1.25	-	.03196	-	.06392	4	.2500	-	.16238	-	.32476	-
20	.0500	-	.03248	-	.06496	-							



Ground Thread

Quick Shipment Program - Special Taps

Prices for special taps are available upon request. Special taps can be furnished in quantities to meet your specific requirements. All special metric taps will produce internal threads which conform to ISO, ISO modified, and the

obsolete OMFS thread systems and are manufactured to USCTI standard blank dimensions to fit the tap holders and machine spindles now in use in the USA.

Call Customer Service at 800.348.2885 for your quote.

General

The following tables and formulae are used in determining the limits and tolerances for ground thread taps having special diameter or special pitch or both and having a thread lead angle not in excess of 5%, unless otherwise specified. This table does not apply to the diameter and pitch combinations shown in Tables 327 and 329.

Note: When the tap major diameter must be determined from a specific tap pitch diameter, the maximum major diameter = the minimum specified pitch diameter - constant C, + constant A.

Lead Tolerance

A maximum lead error of + / - .0005" in 1" of thread is permitted.

Angle Tolerance

Threads Per Inch	Error in Half Angle
4 to 5-1/2 inclusive	20' + / -
6 to 9 inclusive	25' + / -
10 to 80 inclusive	30' + / -

Formulae

- Max. Major Diameter = Basic Major Diameter + A
- Min. Major Diameter = Max. Major Diameter - B
- Max. Pitch Diameter = Min. Pitch Diameter + D
- Min. Pitch Diameter = Basic Pitch Diameter + C

A = constant to add:

- 35% of the theoretical truncation for 4 to 5 threads per inch
- 40% for 5-1/2 to 12 threads per inch
- 45% for 13 to 80 threads per inch
- to nearest .005" for 8 or more threads per inch

B = Major diameter tolerance

C = Amount over basic for minimum pitch diameter

D = Pitch diameter tolerance

Values for A, B, C, and D

threads per inch	A	B	C thru 5/8"	C over 5/8" thru 2-1/2"	C over 2-1/2"	D thru 1"	D over 1" thru 1-1/2"	D over 1-1/2" thru 2-1/2"	D over 2-1/2"
80	.0015	.0010	.0005	.0010	.0015	.0005	.0010	.0010	.0015
56	.0015	.0010	.0005	.0010	.0015	.0005	.0010	.0010	.0015
48	.0020	.0010	.0005	.0010	.0015	.0005	.0010	.0010	.0015
44	.0020	.0010	.0005	.0010	.0015	.0005	.0010	.0010	.0015
40	.0025	.0010	.0005	.0010	.0015	.0005	.0010	.0010	.0015
36	.0025	.0010	.0005	.0010	.0015	.0005	.0010	.0010	.0015
32	.0030	.0010	.0010	.0010	.0015	.0005	.0010	.0010	.0015
28	.0035	.0010	.0010	.0010	.0015	.0005	.0010	.0010	.0015
24	.0040	.0010	.0010	.0010	.0015	.0005	.0010	.0015	.0015
20	.0050	.0010	.0010	.0010	.0015	.0005	.0010	.0015	.0015
18	.0055	.0010	.0010	.0010	.0015	.0005	.0010	.0015	.0015
16	.0060	.0010	.0010	.0010	.0015	.0005	.0010	.0015	.0020
14	.0070	.0010	.0010	.0015	.0015	.0005	.0010	.0015	.0020
13	.0075	.0010	.0010	.0015	.0015	.0005	.0010	.0015	.0020
12	.0075	.0010	.0010	.0015	.0015	.0005	.0010	.0015	.0020
11	.0080	.0010	.0010	.0015	.0020	.0005	.0010	.0015	.0020
10	.0090	.0015	-	.0015	.0020	.0005	.0010	.0015	.0020
9	.0100	.0015	-	.0015	.0020	.0005	.0010	.0015	.0020
8	.0110	.0015	-	.0015	.0020	.0005	.0010	.0015	.0020
7	.0120	.0020	-	.0015	.0020	.0010	.0010	.0020	.0025
6	.0140	.0020	-	.0015	.0020	.0010	.0010	.0020	.0025
5 1/2	.0160	.0025	-	.0015	.0020	.0010	.0015	.0020	.0025
5	.0160	.0025	-	.0015	.0020	.0010	.0015	.0020	.0025
4 1/2	.0170	.0025	-	.0015	.0020	.0010	.0015	.0020	.0025
4	.0190	.0025	-	.0015	.0020	.0010	.0015	.0020	.0025

For intermediate pitches use value for next coarser pitch



See product specific page for additional information

set number	no. of pieces	H-limit / flutes	sizes	case type	order number HTGP / SPGP
Hand Tap - Straight Flute, General Purpose					
	3		See product page for set - Includes Taper, Plug, and Bottoming Tap		see product page
Plug Hand Tap					
303SET	10	H3, 4	1/4-20, 1/4-28, 5/16-18, 5/16-24, 3/8-16, 3/8-24, 7/16-14, 7/16-20, 1/2-13, 1/2-20	metal	330082
Jobber Drill (Bright), Plug Hand Tap					
HT18	18	H3, 4	1/4-20, 5/16-18, 3/8-16, 7/16-14, 1/2-13, 6-32, 8-32, 10-24, 10-32		330083
		Jobber	5/16, 27/64, LET-F, LET-U, #7, #21, #25, #29, #36		
Jobber Drill (Titanium), Plug Hand Tap - TiN					
HT18T	18	H3, 4	1/4-20, 5/16-18, 3/8-16, 7/16-14, 1/2-13, 6-32, 8-32, 10-24, 10-32		330084
		Jobber	5/16, 27/64, #7, #21, #25, #29, #36, LET-F, LET-U		
Jobber Drill (Bright), Plug Spiral PT Tap					
GT18	18	H3, 2	1/4-20, 5/16-18, 6-32, 8-32, 10-24, 10-32		330085
		H3, 3	3/8-16, 7/16-14, 1/2-13		
		Jobber	5/16, 27/64, LET-F, LET-U, #7, #21, #25, #29, #36		
Jobber Drill (Bright), Plug NC/NF Hand Tap					
HT36	36	H2, 3	6-40		330086
		H2, 4	8-36		
		H3, 4	6-32		
		H3, 3	1/4-20, 1/4-28, 5/16-18, 5/16-24, 3/8-16, 3/8-24, 7/16-14, 7/16-20, 1/2-13, 1/2-20, 8-32, 10-24, 10-32, 12-24, 12-28		
		Jobber	5/16, 25/64, 27/64, 29/64, LET-F, LET-I, LET-Q, LET-U, #3, #7, #15, #16, #21, #25, #29, #33, #36		
Screw Machine Drill (Bright), Plug Hand Tap					
68	20	H2, 3	4-40, 5-40		330087
		H3, 3	6-32		
		H3, 4	1/4-20, 5/16-18, 3/8-16, 7/16-14, 1/2-13, 8-32, 10-24		
		Screw Machine	5/16, 27/64, #7, #25, #29, #36, #39, #44, LET-F, LET-U		
Jobber Drill (Black Oxide), Plug Hand Tap					
HM18	18	D3, 3	M2.5x0.45, M3x0.5		330088
		D4, 3	M3.5x0.6, M4x0.7		
		D4, 4	M5x0.8		
		D5, 4	M6X1.0, M8X1.25		
		D6, 4	M10x1.5, M12x1.75		
		Jobber	2.05, 2.50, 2.90, 3.30, 4.20, 5.00, 6.70, 8.5, 10.20		

set number	no. of sizes	die sizes	case type	order number
Taper Pipe Sets - NPT/NPTF Medium Hook				
		NPT Pipe Tap: 1/8 - 1" NPT	wood	Style: PTT 353768
Re-threading Dies - Carbon Steel				
481	8	Course Thrd (UNC): 1/4-20, 5/16-18, 3/8-16, 7/16-14, 1/2-13, 9/16-12, 5/8-11, 3/4-10	metal	Style: 377 403512
482	10	Course Thrd (UNC): 1/4-20, 5/16-18, 3/8-16, 7/16-14, 1/2-13, 9/16-12, 5/8-11, 3/4-10, 7/8-9, 1-8	metal	403553
490	10	Course Thrd (UNC): 1/4-20, 5/16-18, 3/8-16, 7/16-14, 1/2-13 Fine Thrd (UNF): 1/4-28, 5/16-24, 3/8-24, 7/16-20, 1/2-20	metal	403520
492	20	Course Thrd (UNC): 1/4-20, 5/16-18, 3/8-16, 7/16-14, 1/2-13, 9/16-12, 5/8-11, 3/4-10, 7/8-9, 1-8 Fine Thrd (UNF): 1/4-28, 5/16-24, 3/8-24, 7/16-20, 1/2-20, 9/16-18, 5/8-18, 3/4-16, 7/8-14, 1-14	metal	403595
485	7	M6 x 1, M8 x 1.25, M10 x 1.5, M12 x 1.75, M14 x 2, M16 x 2, M20 x 2.5	metal	403522



Machine Taps
Spiral Point Taps
Spiral Flute Taps
Thread Forming Taps
Pipe Taps
Dies
Technical Info
Sets
Index



Sets
Cost Saving / Organize

Set (continued)

See product specific page for additional information

Machine Taps	set number	no. of sizes	tap & die sizes	tap wrench	die stock	order number	
	OK Jr. Tap & Die Sets: HSS Production Hand Taps / Carbon Steel Round Adjustable Dies - Inch						
	17	7	Course Thrd (UNC): 4-40, 6-32, 8-32, 10-24, 12-24, 1/4-20 Fine Thrd (UNF): 10-32	329	13	423001	
	18	5	Course Thrd (UNC): 1/4-20, 5/16-18, 3/8-16, 7/16-14, 1/2-13	333	14	423002	
	25	8	Course Thrd (UNC): 2-56, 3-48, 4-40, 6-32, 8-32, 10-24 Fine Thrd (UNF): 0-80, 1-72	329	13	423003	
	T4	8	Course Thrd (UNC): 2-56, 3-48, 4-40, 6-32, 8-32, 10-24, 12-24 Fine Thrd (UNF): 10-32	0	1851	420359	
	26	10	Course Thrd (UNC): 4-40 Fine Thrd (UNF): 4-48	329	13	420361	
	T6	20	Course Thrd (UNC): 1/4-20, 5/16-18, 3/8-16, 7/16-14, 1/2-13, 9/16-12, 5/8-11, 3/4-10, 7/8-9, 1-8 Fine Thrd (UNF): 1/4-28, 5/16-24, 3/8-24, 7/16-20, 1/2-20, 9/16-18, 5/8-18, 3/4-18, 7/8-14, 1-12	7	1852	420363	
	28	11	Course Thrd (UNC): 1/4-20, 5/16-18, 3/8-16, 7/16-14, 1/2-13 Fine Thrd (UNF): 1/4-28, 5/16-24, 3/8-24, 7/16-20, 1/2-20 Pipe Size (Short shank): 1/8-27	333	1	423004	
	32	21	Course Thrd (UNC): 1/4-20, 5/16-18, 3/8-16, 7/16-14, 1/2-13, 9/16-12, 5/8-11, 3/4-10, 7/8-9, 1-8 Fine Thrd (UNF): 1/4-28, 5/16-24, 3/8-24, 7/16-20, 1/2-20, 9/16-18, 5/8-18, 3/4-16, 7/8-14 UNS: 1-14 Pipe Size (Long shank): 1/8-27	15 7	14 15 16	423005	
	33	28 Taps 15 Dies	Course Thrd (UNC): 4-40, 6-32, 8-32, 10-24, 12-24, 1/4-20, 5/16-18, 3/8-16, 7/16-14, 1/2-13, 9/16-12 Fine Thrd (UNF): 10-32, 1/4-28, 5/16-24, 3/8-24, 7/16-20, 1/2-20, 9/16-18, 5/8-18, 3/4-16, 7/8-14 UNS: 1-14 Pipe Size: 1/8-27, 1/4-18, 3/8-18, 1/2-14	329	14 15 16 7	423006	
	Tap & Die Set: with Production Hand Taps and HSS Round Adjustable Dies - Metric						
	48	7	M2.5 x 0.45, M3 x 0.5, M3.5 x 0.6, M4 x 0.7, M4.5 x 0.75, M5 x 0.8, M6 x 1.0 Screwdriver: 300	333	1790	420365	
	49	5	M6 x 1.0, M7 x 1.0, M8 x 1.25, M10 x 1.5, M12 x 1.75 Screwdriver: 300	333	1790	420367	
	Tap & Die Set: with Production Hand Taps, Black Oxide Jobber Length Drills, and HSS Round Adjustable Dies - Metric						
	49D	5	M6 x 1.0, M7 x 1.0, M8 x 1.25, M10 x 1.5, M12 x 1.75 Drill Sizes: 5.0, 6.0, 6.7, 8.5, 10.2 Screwdriver: 300	333	1790	420368	
Thread Forming Taps	set number	no. of sizes	tap & die sizes	collet number	tap wrench	die stock	order number
	Tap & Die Set: without Collet						
	59	7	Course Thrd (UNC): 4-40, 6-32, 8-32, 10-24, 12-24, 1/4-20 NC Fine Thrd (UNF): 10-32	A1	T9, A1	A1	423159
	510	5	Course Thrd (UNC): 1/4-20, 5/16-18, 3/8-16, 7/16-14, 1/2-13	1	#5, #7	#1	423160
	511	10	Course Thrd (UNC): 1/4-20, 5/16-18, 3/8-16, 7/16-14, 1/2-13, 9/16-18, 5/8-18, 3/4-16, 7/8-14, 1-8	5	#5	5A	423173
	512	10	Course Thrd (UNC): 1/4-20, 5/16-18, 3/8-16, 7/16-14, 1/2-13 Fine Thrd (UNF): 1/4-28, 5/16-24, 3/8-24, 7/16-20, 1/2-20	1	#5	#1	423162
	513	20	Course Thrd (UNC): 1/4-20, 5/16-18, 3/8-16, 7/16-14, 1/2-13, 9/16-12, 5/8-11, 3/4-10, 7/8-9, 1-8 Fine Thrd (UNF): 1/4-28, 5/16-24, 3/8-24, 7/16-20, 1/2-20, 9/16-18, 5/8-18, 3/4-16, 7/8-14, 1-14	1, 5	#5 #7	#1 #5B	423163
	514	7	M6 x 1, M8 x 1.25, M10 x 1.5, M12 x 1.75, M14 x 2, M16 x 2, M18 x 2.5	5	#6	#5	423164
	58	20	Course Thrd (UNC): 1/4-20, 5/16-18, 3/8-16, 7/16-14, 1/2-13, 9/16-12, 5/8-11, 3/4-10, 7/8-9, 1-8 Fine Thrd (UNF): 1/4-28, 5/16-24, 3/8-24, 7/16-20, 1/2-20, 9/16-18, 5/8-18, 3/4-16, 7/8-14 UNS: 1-14	-	#5 #7	#1 #5	423165
	Screw Extractors						
	15 Set	5 pcs.	Sizes: #1 through #5	-	-	-	Style: 335 422006

Machine Taps

Spiral Point Taps

Spiral Flute Taps

Thread Forming Taps

Pipe Taps

Dies

Technical Info

Sets

Index



Lined area for notes, consisting of multiple horizontal lines across the page.







Index

Reference Information

Machine Taps

Spiral Point Taps

Spiral Flute Taps

Thread Forming Taps

Pipe Taps

Dies

Technical Info

Sets

Index

Table with 15 columns: Order Number, Series Number, Page Number. It lists various tap and die part numbers and their corresponding page numbers in the index.





Index by Part Number
Reference Information

Index

Order Number	Series Number	Page Number	Order Number	Series Number	Page Number	Order Number	Series Number	Page Number	Order Number	Series Number	Page Number	Order Number	Series Number	Page Number
356506	SPGP	13	357587	SPGP	14	366160	SFGP	22	385505	PTT	24	400310	6382	30
356510	SPGP	13	357603	SPGP	14	366162	SFGP	22	385513	PTT	24	400328	6382	30
356514	SPGP	13	357609	SPGP	14	366170	SFGP	22	385534	PTT	24	400336	6382	30
356544	SPGP	13	357629	SPGP	14	366172	SFGP	22	385536	PTT	24	400344	6382	31
356548	SPGP	13	357660	SPGP	14	366180	SFGP	22	385539	PTT	24	400351	6382	31
356589	SPGP	13	357682	SPGP	14	366182	SFGP	22	385547	PTT	24	400369	6382	31
356602	SPGP	13	357686	SPGP	14	367149	SFGP	22	385562	PTT	24	400377	6382	31
356633	SPGP	13	357702	SPGP	14	367156	SFGP	22	385570	PTT	24	400401	6382	30
356634	SPGP	13	357765	SPGP	14	367222	SFGP	22	385604	PTT	24	400419	6382	30
356635	SPGP	13	357769	SPGP	14	367230	SFGP	22	385680	PTT	24	400427	6382	30
356647	SPGP	13	357785	SPGP	14	367263	SFGP	22	385681	PTT	24	400435	6382	30
356662	SPGP	13	357819	SPGP	14	367271	SFGP	22	385682	PTT	24	400445	6382	31
356688	SPGP	13	357823	SPGP	14	367305	SFGP	22	385685	PTT	24	400450	6382	31
356703	SPGP	13	357827	SPGP	14	367313	SFGP	22	385729	PTTI	25	400468	6382	31
356704	SPGP	13	357831	SPGP	14	367321	SFGP	22	385737	PTTI	25	400476	6382	31
356712	SPGP	13	357835	SPGP	14	367339	SFGP	22	385752	PTTI	25	400484	6382	31
356718	SPGP	13	357864	SPGP	14	367909	SFGP	22	385755	PTTI	25	400492	6382	31
356742	SPGP	13	357868	SPGP	14	367913	SFGP	22	385760	PTTI	25	400500	6382	31
356746	SPGP	13	357922	SPGP	14	367917	SFGP	22	385786	PTTI	25	400518	6382	31
356761	SPGP	13	357926	SPGP	14	367925	SFGP	22	385789	PTTI	25	400526	6382	31
356767	SPGP	13	357930	SPGP	14	367933	SFGP	22	385794	PTTI	25	400534	6382	31
356775	SPGP	13	357934	SPGP	14	367941	SFGP	22	385810	PTTI	25	400609	6382	31
356779	SPGP	13	357942	SPGP	14	367958	SFGP	22	385813	PTTI	25	400617	6382	31
356803	SPGP	13	357963	SPGP	14	367966	SFGP	22	385828	PTTI	25	400625	6382	31
356809	SPGP	13	357967	SPGP	14	367974	SFGP	22	385844	PTTI	25	400633	6382	31
356841	SPGP	13	357975	SPGP	14	367982	SFGP	22	385847	PTTI	25	400641	6382	31
356845	SPGP	13	358490	SPGP	14	367990	SFGP	22	385851	PTTI	25	400658	6382	31
356858	SPGP	13	358494	SPGP	14	368006	SFGP	22	385870	PTTI	25	401003	382	30
357009	SPGP	14	358510	SPGP	14	368014	SFGP	22	385877	PTTI	25	401029	382	30
357021	SPGP	14	359005	SPGP	13	368063	SFGP	22	385885	PTTI	25	401037	382	30
357025	SPGP	14	359047	SPGP	13	368071	SFGP	22	386008	ELPTT	27	401045	382	30
357041	SPGP	14	359088	SPGP	13	368089	SFGP	22	386024	ELPTT	27	401052	382	30
357047	SPGP	14	359120	SPGP	13	368097	SFGP	22	386040	ELPTT	27	401060	382	30
357054	SPGP	14	360023	SPGP	13	384524	ELPTT	27	386129	ELPTT	27	401078	382	30
357058	SPGP	14	360755	SPGP	15	384525	ELPTT	27	386152	ELPTT	27	401102	382	30
357062	SPGP	14	360771	SPGP	15	384526	ELPTT	27	386186	ELPTT	27	401110	382	30
357066	SPGP	14	360774	SPGP	15	384527	ELPTT	27	387113	PTS	26	401128	382	30
357082	SPGP	14	360797	SPGP	15	384528	ELPTT	27	387121	PTS	26	401129	382	30
357088	SPGP	14	360801	SPGP	15	384529	ELPTT	27	387139	PTS	26	401168	382	30
357101	SPGP	14	360805	SPGP	15	385307	PTT	24	387147	PTS	26	401169	382	30
357108	SPGP	14	360821	SPGP	15	385323	PTT	24	387212	PTS	26	401177	382	30
357161	SPGP	14	360835	SPGP	15	385328	PTT	24	387220	PTS	26	401201	382	30
357165	SPGP	14	360839	SPGP	15	385329	PTT	24	387238	PTS	26	401227	382	30
357173	SPGP	14	360854	SPGP	15	385331	PTT	24	387246	PTS	26	401242	382	30
357179	SPGP	14	360862	SPGP	15	385356	PTT	24	387253	PTS	26	401243	382	30
357249	SPGP	14	360868	SPGP	15	385357	PTT	24	400013	6382	30	401244	382	30
357264	SPGP	14	360884	SPGP	15	385359	PTT	24	400021	6382	30	401409	382	30
357280	SPGP	14	360888	SPGP	15	385364	PTT	24	400039	6382	30	401433	382	30
357286	SPGP	14	360904	SPGP	15	385380	PTT	24	400047	6382	30	401466	382	30
357294	SPGP	14	360920	SPGP	15	385385	PTT	24	400054	6382	30	401482	382	30
357298	SPGP	14	360926	SPGP	15	385386	PTT	24	400062	6382	30	401490	382	30
357306	SPGP	14	360942	SPGP	15	385398	PTT	24	400070	6382	30	401979	382	30
357322	SPGP	14	360946	SPGP	15	385409	PTT	24	400088	6382	30	401995	382	30
357328	SPGP	14	360961	SPGP	15	385410	PTT	24	400096	6382	30	402019	382	30
357344	SPGP	14	360967	SPGP	15	385413	PTT	24	400104	6382	30	402027	382	30
357348	SPGP	14	360995	SPGP	15	385422	PTT	24	400138	6382	30	402043	382	31
357363	SPGP	14	361019	SPGP	15	385443	PTT	24	400145	6382	30	402050	382	31
357401	SPGP	14	361050	SPGP	15	385444	PTT	24	400178	382	30	402068	382	31
357405	SPGP	14	366110	SFGP	22	385448	PTT	24	400179	6382	30	402076	382	31
357413	SPGP	14	366112	SFGP	22	385455	PTT	24	400187	6382	30	402077	382	31
357504	SPGP	14	366130	SFGP	22	385458	PTT	24	400195	6382	30	402078	382	31
357520	SPGP	14	366132	SFGP	22	385471	PTT	24	400211	6382	30	402209	382	30
357526	SPGP	14	366140	SFGP	22	385477	PTT	24	400229	6382	30	402225	382	30
357542	SPGP	14	366142	SFGP	22	385489	PTT	24	400237	6382	30	402241	382	30
357546	SPGP	14	366150	SFGP	22	385500	PTT	24	400245	6382	30	402258	382	30
357561	SPGP	14	366152	SFGP	22	385501	PTT	24	400302	6382	30	402274	382	31

- Machine Taps
- Spiral Point Taps
- Spiral Flute Taps
- Thread Forming Taps
- Pipe Taps
- Dies
- Technical Info
- Sets
- Index



DRILL SIZE	DECIMAL INCHES	DRILL SIZE	DECIMAL INCHES	DRILL SIZE	DECIMAL INCHES	DRILL SIZE	DECIMAL INCHES	DRILL SIZE	DECIMAL INCHES	DRILL SIZE	DECIMAL INCHES
0.30mm	.0118	1.40mm	.0551	3.20mm	.1260	7/32	.2188	8.60mm	.3386	37/64	.5781
0.32mm	.0126	1.45mm	.0571	30	.1285	5.60mm	.2205	R	.3390	14.75mm	.5807
80	.0135	1.50mm	.0591	3.30mm	.1299	2	.2210	8.70mm	.3425	15.00mm	.5906
0.35mm	.0138	53	.0595	3.40mm	.1339	5.70mm	.2244	11/32	.3438	19/32	.5938
79	.0145	1.55mm	.0610	29	.1360	1	.2280	8.80mm	.3465	15.25mm	.6004
0.38mm	.0150	1/16	.0625	3.50mm	.1378	5.80mm	.2283	S	.3480	39/64	.6094
1/64	.0156	1.60mm	.0630	28	.1405	5.90mm	.2323	8.90mm	.3504	15.50mm	.6102
0.40mm	.0157	52	.0635	9/64	.1406	A	.2340	9.00mm	.3543	15.75mm	.6201
78	.0160	1.65mm	.0650	3.60mm	.1417	15/64	.2344	T	.3580	5/8	.6250
0.42mm	.0165	1.70mm	.0669	27	.1440	6.00mm	.2362	9.10mm	.3583	16.00mm	.6299
0.45mm	.0177	51	.0670	3.70mm	.1457	B	.2380	23/64	.3594	16.25mm	.6398
77	.0180	1.75mm	.0689	26	.1470	6.10mm	.2402	9.20mm	.3622	41/64	.6406
0.48mm	.0189	50	.0700	25	.1495	C	.2420	9.30mm	.3661	16.50mm	.6496
0.50mm	.0197	1.80mm	.0709	3.80mm	.1496	6.20mm	.2441	U	.3680	21/32	.6562
76	.0200	1.85mm	.0728	24	.1520	D	.2460	9.40mm	.3701	16.75mm	.6594
75	.0210	49	.0730	3.90mm	.1535	6.30mm	.2480	9.50mm	.3740	17.00mm	.6693
0.55mm	.0217	1.90mm	.0748	23	.1540	1/4	.2500	3/8	.3750	43/64	.6719
74	.0225	48	.0760	5/32	.1562	E	.2500	V	.3770	17.25mm	.6791
0.60mm	.0236	1.95mm	.0768	22	.1570	6.40mm	.2520	9.60mm	.3780	11/16	.6875
73	.0240	5/64	.0781	4.00mm	.1575	6.50mm	.2559	9.70mm	.3819	17.50mm	.6890
0.62mm	.0244	47	.0785	21	.1590	F	.2570	9.80mm	.3858	45/64	.7031
72	.0250	2.00mm	.0787	20	.1610	6.60mm	.2598	W	.3860	18.00mm	.7087
0.65mm	.0256	2.05mm	.0807	4.10mm	.1614	G	.2610	9.90mm	.3898	23/32	.7188
71	.0260	46	.0810	4.20mm	.1654	6.70mm	.2638	25/64	.3906	18.50mm	.7283
0.70mm	.0276	45	.0820	19	.1660	17/64	.2656	1.00mm	.3937	47/64	.7344
70	.0280	2.10mm	.0827	4.30mm	.1693	H	.2660	X	.3970	19.00mm	.7480
69	.0292	2.15mm	.0846	18	.1695	6.80mm	.2677	1.20mm	.4016	3/4	.7500
0.75mm	.0295	44	.0860	11/64	.1719	6.90mm	.2717	Y	.4040	49/64	.7656
68	.0310	2.20mm	.0866	17	.1730	I	.2720	13/32	.4062	19.50mm	.7677
1/32	.0312	2.25mm	.0886	4.40mm	.1732	7.00mm	.2756	Z	.4130	25/32	.7812
0.80mm	.0315	43	.0890	16	.1770	J	.2770	10.50mm	.4134	20.00mm	.7874
67	.0320	2.30mm	.0906	4.50mm	.1772	7.10mm	.2795	27/64	.4219	51/64	.7969
66	.0330	2.35mm	.0925	15	.1800	K	.2810	10.80mm	.4252	20.50mm	.8071
0.85mm	.0335	42	.0935	4.60mm	.1811	9/32	.2812	11.00mm	.4331	13/16	.8125
65	.0350	3/32	.0938	14	.1820	7.20mm	.2835	7/16	.4375	21.00mm	.8268
0.90mm	.0354	2.40mm	.0945	4.70mm	.1850	7.30mm	.2874	11.20mm	.4409	53/64	.8281
64	.0360	41	.0960	13	.1850	L	.2900	11.50mm	.4528	27/32	.8438
63	.0370	2.45mm	.0965	3/16	.1875	7.40mm	.2913	29/64	.4531	21.50mm	.8465
0.95mm	.0374	40	.0980	12	.1890	M	.2950	11.80mm	.4646	55/64	.8594
62	.0380	2.50mm	.0984	4.8mm	.1890	7.50mm	.2953	15/32	.4688	22.00mm	.8661
61	.0390	39	.0995	11	.1910	19/64	.2969	12.00mm	.4724	7/8	.8750
1.00mm	.0394	38	.1015	4.90mm	.1929	7.60mm	.2992	12.20mm	.4803	22.50mm	.8858
60	.0400	2.60mm	.1024	10	.1935	N	.3020	31/64	.4844	57/64	.8906
59	.0410	37	.1040	9	.1960	7.70mm	.3031	12.50mm	.4921	23.00mm	.9055
1.05mm	.0413	2.70mm	.1063	5.00mm	.1969	7.80mm	.3071	1/2	.5000	29/32	.9062
58	.0420	36	.1065	8	.1990	7.90mm	.3110	12.80mm	.5039	59/64	.9219
57	.0430	7/64	.1094	5.10mm	.2008	5/16	.3125	13.00mm	.5118	23.50mm	.9252
1.10mm	.0433	35	.1100	7	.2010	8.00mm	.3150	33/64	.5156	15/16	.9375
1.15mm	.0453	2.80mm	.1102	13/64	.2031	O	.3160	13.20mm	.5197	24.00mm	.9449
56	.0465	34	.1110	6	.2040	8.10mm	.3189	17/32	.5312	61/64	.9531
3/64	.0469	33	.1130	5.20mm	.2047	8.20mm	.3228	13.50mm	.5315	24.50mm	.9646
1.20mm	.0472	2.90mm	.1142	5	.2055	P	.3230	13.80mm	.5433	31/32	.9688
1.25mm	.0492	32	.1160	5.30mm	.2087	8.30mm	.3268	35/64	.5469	25.00mm	.9843
1.30mm	.0512	3.00mm	.1181	4	.2090	21/64	.3281	14.00mm	.5512	63/64	.9844
55	.0520	31	.1200	5.40mm	.2126	8.40mm	.3307	14.25mm	.5610	1	1.0000
1.35mm	.0531	3.10mm	.1220	3	.2130	Q	.3320	9/16	.5625		
54	.0550	1/8	.1250	5.50mm	.2165	8.50mm	.3346	14.50mm	.5709		

FRACTIONAL - RED

WIRE GAGE - PURPLE

LETTER - BLUE

METRIC - GREEN



www.gfii.com

2501 Davis Creek Road, Seneca, SC 29678 USA

email: standard.distributors@gfii.com - USA
national.distributors@gfii.com - National Accounts
canada.distributors@gfii.com - Canada
international.distributors@gfii.com - International
greenfield.information@gfii.com - Tech Support

Phone: 800.348.2885 USA & Canada

706.650.4196 International
800.892.4281 Tech Support

Fax: 800.892.4290 USA

800.387.6649 Canada
706.854.4054 International

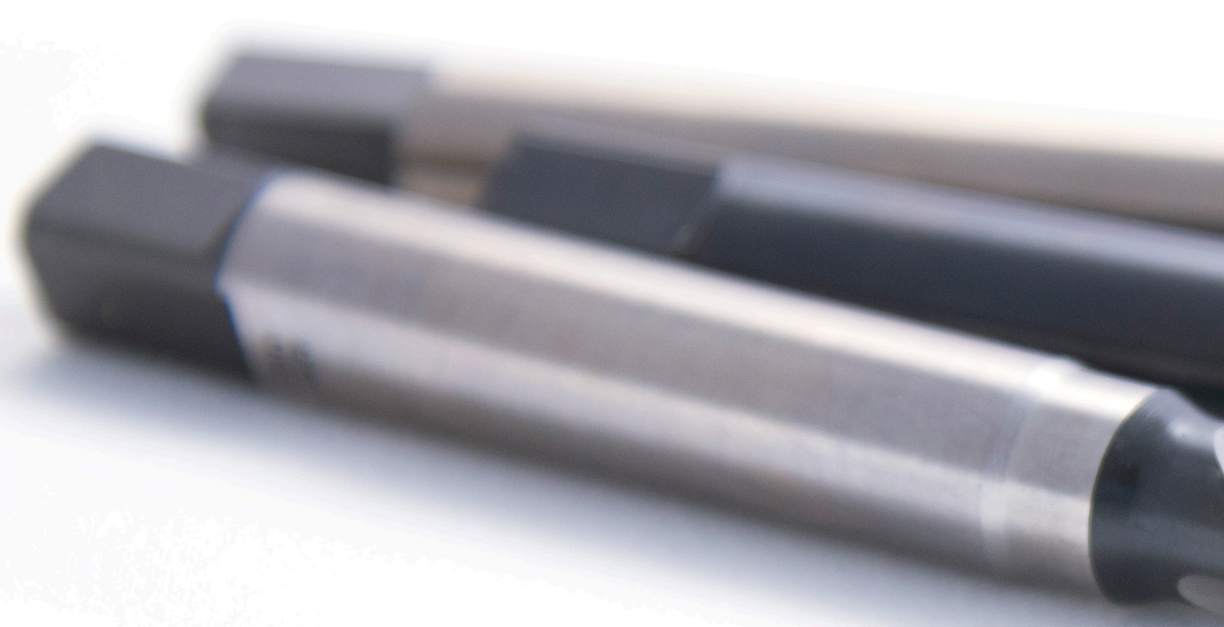

Distributed by:

