

IRWIN®

HANSON®

Taps & Dies



www.irwin.com

Driving Performance Through Innovation

IRWIN® HANSON® has been manufacturing High Carbon Steel threading tools for over 100 years, and has proven itself to be a brand you can trust. Performance, thread quality, durability, and ease of use – proven for over a century.

At IRWIN, we understand it's all about performance, and you only get out of a tool what you put into a tool. The new **Performance Threading System™** from IRWIN HANSON is a prime example. With exceptional innovation, these threading tools are now easier to use, and maintain the high thread quality and durability professionals trust. The IRWIN HANSON **Performance Threading System** includes self-aligning taps and dies for the perfect thread, every single time. New, innovative drive tools make set-up a snap. And, it's all available in handy, modular set cases that fit in the smallest drawers, have removable lids, and easy-to-read marked sizes. Professionals can choose only what they need.



PERFORMANCE THREADING SYSTEM FEATURES

1. Chip Breaking Technology (CBT) cuts chips easier
2. Tap size and recommended drill bit size are laser etched on each tool for easy identification

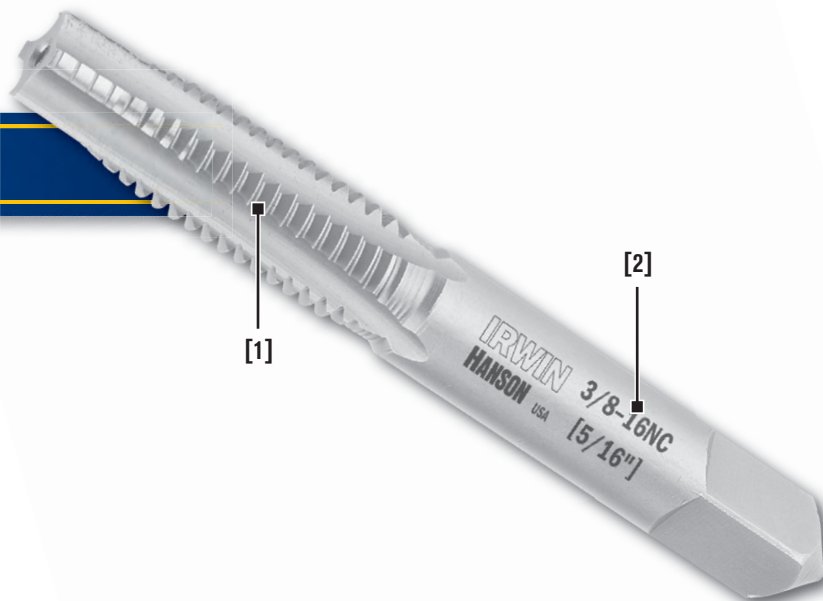

TAPS & DIES

Material Types

High Carbon Steel (HCS)

For hand tapping applications

High Speed Steel (HSS)

For machine tapping where critical dimensions are required



Tap Point Styles

Self-Aligning Taps

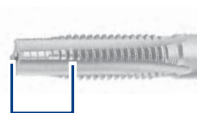

8-10 threads

- Starts straight every time
- Chip-breaking technology cuts chips easier

Plug Taps

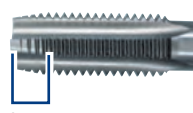

3-5 threads

- 3 to 5 threads chamfered
- Most common chamfer
- Ideal for all general purpose threading

Taper Taps

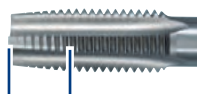

8-10 threads

- 8 to 10 threads chamfered
- Ideal for tough starting applications
- Preferred use with deep or through hole applications

Bottom Taps



1-2 threads

- 1 to 2 threads chamfered
- Shortest and least efficient standard chamfer
- Ideal for threading close to the bottom of blind holes

Die Styles

Self-Aligning Dies



Additional Strength

- Tap size and recommended drill bit size are laser etched on each tool for easy identification



1" Across Hex Flats

- Threads straight every turn
- More steel at critical points for extra strength

Hexagon Dies



5/8", 1", 1-7/16" & 1-13/16" Across Hex Flats

- Best suited for maintenance and repair work
- Recommended for use with hexagonal die stock handles
- In area with limited space, die can be used with a wrench or socket

Solid Round Dies



1" & 1-1/2" Overall Diameter

- Ideal for general purpose threading
- Fits into adjustable guide or plain die stock handles

Adjustable Round Dies



1", 1-1/2", 2" & 3" Overall Diameter

- Adjustable dies allow the user to under or over cut their threads
- Ideal for a precision threading with the adjustment of die made by set screw
- Fits into adjustable guide or plain die stock handles
- Meets Federal Specifications GGG-D-296

TAPS & DIES

Tap & Die Description Guide

10-24 NC		
Fastener Diameter	Thread Type	Applications
10 - Machine screw size	NC = National Coarse (USS)	General purpose machines and appliances
5/8" - Fractional	NF = National Fine (SAE)	Automotive parts requiring extreme pressures
8 mm - Metric	NS = National Special	Special threads – either diameter or threads per inch
	NEF = National Extra Fine	For optical or thin wall parts
	NPT = National Pipe Taper	For all pipe threads
	BSP = British Standard Pipe	For all pipe threads
	(no thread symbol required for metric fasteners)	
Thread Pitch		
Threads per inch (machine & fractional)		
Distance between threads (metric)		

Taps & Dies

Tap & Drill Selection Chart

TAPS & DIES

Diam/Type	Decimal Equiv.	Fractional Tap	Machine Screw Tap	Metric Tap	Screw Ext.
1/64"	.0516				
1/32"	.0312				
1.0 mm	.0394				
60	.0400				
59	.0410				
58	.0420				
57	.0430				
56	.0465				
3/64"	.0469		0 - 80 NF		
55	.0520				
54	.0550				
1.5 mm	.0591				
53	.0595		1 - 64 NC 1 - 72NF		
1/16"	.0625				
52	.0635				
51	.0670				
50	.0700		2 - 56 NC 2 - 64 NF		
49	.0730				
48	.0760				
5/64"	.0781		3 - 48 NC		EX-1
47	.0785				
2.0 mm	.0787				
46	.0810				
45	.0820		3 - 56 NF		
44	.0860		4 - 36 NS		
43	.0890		4 - 40 NC		
42	.0935				
3/32"	.0938		4 - 48 NF		
41	.0960			3 mm - 0.60	
40	.0980				
2.5 mm	.0984			3 mm - 0.50	
39	.0995			3 mm - 0.50	
38	.1015	1/8" - 40 NS	5 - 40 NC		
37	.1040		5 - 44 NF		
36	.1065		6 - 32 NC		
7/64"	.1094				EX-2
35	.1100				
34	.1110		6 - 36 NS		
33	.1130		6 - 40 NF		
32	.1160		6 - 48 NS		
3.0 mm	.1181				
31	.1200				
1/8"	.1250				
30	.1285			4 mm - 0.70 4 mm - 0.75	
29	.1360		8 - 32 NC 8 - 36 NF		
3.5 mm	.1378				
28	.1405				

Diam/Type	Decimal Equiv.	Fractional Tap	Machine Screw Tap	Metric Tap	Screw Ext.
9/64"	.1406	8 - 40 NS			ST-1
27	.1440				
26	.1470	3/16"-24 NS			
25	.1495		10 - 24 NC		
24	.1520				
23	.1540				
5/32"	.1562	3/16"-32 NS			EX-3
22	.1570				
4.0 mm	.1575				
21	.1590		10 - 32 NF		
20	.1600			5 mm - 0.90	
19	.1660			5 mm - 0.80	
18	.1695				
11/64"	.1719				
17	.1730				
16	.1770		12 - 24 NC		
4.5 mm	.1772				
15	.1800				
14	.1820		12 - 28 NEF		
13	.1850				
3/16"	.1875				ST-2
12	.1890				
11	.1910				
10	.1935		14 - 20 NS		
9	.1960				
5.0 mm	.1969			6 mm - 1.00	
8	.1990			6 mm - 1.00	
7	.2010	1/4" - 20 NC			
13/64"	.2031		14 - 24 NS		
6	.2040				
5	.2055				
4	.2090	1/4" - 24 NS			
3	.2130	1/4" - 28 NF			
5.5 mm	.2165				
7/32"	.2188	1/4" - 32 NEF			
2	.2210				
1	.2280	1/4" - 40 NS			
A	.2340				
15/64"	.2344			7 mm - 1.00	ST-3
6.0 mm	.2362			7 mm - 1.00	
B	.2380				
C	.2420				
D	.2460				
E	.2500				
1/4"	.2500				EX-4
6.5 mm	.2559				
F	.2570	5/16"- 18 NC			

Machine Screw Reference Guide

Before cutting a thread, you must know the rod diameter.

Use the chart at right to determine the appropriate machine screw size:

Machine Screw	Rod Diameter
#0	.060"
#1	.073"
#2	.086"
#3	.099"
#4	.112"
#5	.125"
#6	.138"

Machine Screw	Rod Diameter
#7	.151"
#8	.164"
#9	.179"
#10	.190"
#12	.216"
#14	.242"

Diam/Type	Decimal Equiv.	Fractional Tap	Pipe Tap	Metric Tap	Screw Ext.
G	.2610				
17/64"	.2656			8 mm - 1.25	
H	.2660				
I	.2720	5/16"-24 NF			
7.0 mm	.2756			8 mm - 1.00	
J	.2770			8 mm - 1.00	
K	.2810				
9/32"	.2812	5/16"-32 NEF			
L	.2900				
M	.2950				
7.5 mm	.2953				
19/64"	.2969				EX-5
N	.3020			9 mm - 1.25	
5/16"	.3125	3/8"- 16 NC			ST-4
8.0 mm	.3150			9 mm - 1.00	
O	.3160			9 mm - 1.00	
P	.3230			9 mm - 0.75	
21/64"	.3281		1/8" - 28 BSP		
Q	.3320	3/8"- 24 NF	1/8" - 27 NPT		
8.5 mm	.3346			10 mm - 1.50	
R	.3390			10 mm - 1.50	
11/32"	.3438			10 mm - 1.25	
S	.3480				
9.0 mm	.3543			10 mm - 1.00	
T	.3580			10 mm - 1.00	
23/64"	.3594				
U	.3680	7/16"- 14 NC			
9.5 mm	.3740			11 mm - 1.50	
3/8"	.3750			11 mm - 1.50	ST-5
V	.3770				
W	.3806				
25/64"	.3906	7/16"- 20 NF			
10.0 mm	.3937				
X	.3970				
Y	.4040				
13/32"	.4062			12 mm - 1.75	EX-6
Z	.4130			12 mm - 1.50	
10.5 mm	.4134			12 mm - 1.50	
27/64"	.4219	1/2"- 13 NC		12 mm - 1.25	
11.0 mm	.4331				
7/16"	.4375		1/4" - 18 NPT		
11.5 mm	.4528				
29/64"	.4531	1/2"-20 NF 1/2"-24 NS	1/4" - 19 BSP		
15/32"	.4688			14 mm - 2.00	ST-6
12.0 mm	.4724			14 mm - 2.00	
31/64"	.4844	9/16"- 12 NC			
12.5 mm	.4921			14 mm - 1.50	

Diam/Type	Decimal Equiv.	Fractional Tap	Pipe Tap	Metric Tap	Screw Ext.
1/2"	.5000			14 mm - 1.25 14 mm - 1.50	
13.0 mm	.5118			14 mm - 1.25	
33/64"	.5156	9/16"- 18 NF			
17/32"	.5313	5/8"- 11 NC			EX-7
35/64"	.5469			16 mm - 2.00	
9/16"	.5625		3/8" - 18 NPT		ST-7
37/64"	.5781	5/8"- 18 NF		16 mm - 1.50	
19/32"	.5938	11/16"-11 NS			
39/64"	.6094			18 mm - 2.50	
5/8"	.6250	11/16"-16 NS			
41/64"	.6406				
21/32"	.6562	3/4" - 10 NC		18 mm - 1.50	
43/64"	.6719				
11/16"	.6875	3/4" - 16 NF		20 mm - 2.50	
45/64"	.7031		1/2" - 14 NPT		
23/32"	.7188				
47/64"	.7344				
3/4"	.7500				
49/64"	.7656				
25/32"	.7812	7/8" - 9 NC			
51/64"	.7969				
13/16"	.8125	7/8" - 14 NF		22 mm - 1.50	EX-8
53/64"	.8281			24 mm - 3.00	
27/32"	.8438				
55/64"	.8594				
7/8"	.8750	1" - 8 NC		24 mm - 2.00	
57/64"	.8906				
29/32"	.9062				
59/64"	.9219	1" - 12 NF	3/4" - 14 NPT		
15/16"	.9375	1" - 14 NS			
61/64"	.9531				
31/32"	.9688				
63/64"	.9844	1-1/8"- 7 NC			
1"	1.0000				
1-1/64"	1.0156				
1-1/32"	1.0312				
1-1/16"	1.0625				EX-9
1-3/32"	1.0938				
1-1/8"	1.1250				
1-5/32"	1.1562		1" - 11-1/2" NPT		
1-3/16"	1.1875				
1-1/4"	1.2500				
1-5/16"	1.3125				
1-3/8"	1.3750				
1-7/16"	1.4375				
1-1/2"	1.5000		1-1/4" - 11-1/2" NPT		

NC = National Coarse (USS)
 NS = National Special
 NF = National Fine (SAE)

NEF = National Extra Fine
 NPT = National Pipe Taper
 BSP = British Standard Pipe

TAPS & DIES



HANSON® PTS Die Stock Handle



4935054

- Die Lock – no more set screws needed
- Simply twist to insert and remove die

HANSON Adjustable Tap Handle & Reamer Wrenches



4935052

- Versatile base, drives with die stock, 3/8" ratchet or T-handle (included)
- Adjustable jaw has two tap sockets that fit No. 4 to 1/2" or 3 mm to 12 mm

HANSON Plain Die Stock Handles



12416

- Dies easily lock in position with set screw

HANSON Offset Handle Adjustable Tap & Reamer Wrenches



12421

- Straight handle design provides greater leverage, especially when using larger diameter taps

HANSON Adjustable Tap Handle & Reamer Wrenches



12498

- Straight handle design provides greater leverage, especially when using larger diameter taps
- Designed for use with taps, reamers, screw extractors and other tools with a square shank

HANSON Adjustable Guide Die Stock Handles



12428

- Maintains alignment for accurate, straight threading

HANSON Reamers



11221

- For deburring and enlarging holes in sheet metal and similar materials
- Not for use in machine tools

Description	Usage	Carded Item #	Bulk Item #
Hanson PTS Die Stock & Tap Driver			
Tap Driver - Small	For Taps No. 4 to 1/4" (3mm to 6mm)	1766068	4935052
Tap Driver - Medium	For Taps 1/4" to 1/3" (6mm to 12mm)	1766069	4935053
Die Stock	For 1" Hexagon Dies; Accepts Small & Medium Adj. Tap Sockets to Drive Taps	1766070	4935054
HANSON Plain Die Stock Handles			
DS - 57	For 5/8" Hexagon Dies	-	12457
DS - 13	For 13/16" Round Dies	-	12416
DS - 9	For 1" Hexagon or Round Dies	12008	11008
HANSON Adj. Guide Die Stock Handles			
DS - 28	For 1" Adjustable Round Dies	-	12428
DS - 35	For 1-1/2" Adjustable Round Dies	-	12435
DS - 45	For 2" Adjustable Round Dies	-	12445
DS - 26	For 1" Hexagon or Round Dies	12026	11026
DS - 36	For 1-7/16" Hexagon Dies	-	12436
DS - 46	For 1-13/16" Hexagon Dies	-	12446
HANSON Offset Handle Adj. Tap Handle & Reamer Wrenches			
TR - 21	For Taps No. 0 to 1/2" (3 mm to 12 mm)	12021	12421
TR - 121	For Taps No. 1/4" to 1" (6 mm to 24 mm)	-	11212
HANSON Adj. Tap Handle & Reamer Wrenches			
TR - 88	For Taps No. 0 to 1/2" (3 mm to 12 mm)	12088	311088
TR - 98	For Taps 1/4" to 1" (6 mm to 24 mm)	-	12498
HANSON Reamers			
Repair Reamer (1/8" to 1/2")		11214	-
Repair Reamer Pouched (1/2" to 1")		11221	-

HANSON Tap Adaptors



3095001

- Adaptors feature a 3/8" square drive to accommodate socket wrench or extension
- Designed for use with taps, reamers, screw extractors, and other tools with a square shank
- Not recommended for cutting new threads

HANSON Metric Measuring Kit with Thread Gauges

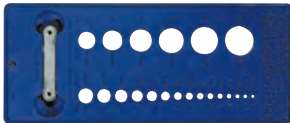

12087

- Shows 21 outside diameters (OD) in millimeters and decimals from 2.3 mm (.0906) to 24 mm (.9449)
- Measures thread pitch in millimeters from 0.35 to 3.00

HANSON T-Handle Tap Wrenches



12401

- Designed for use with taps, reamers, screw extractors and other tools with a square shank
- Adjusted and tightened to size by twisting knurled nut
- End of TR-50 & TR-73 wrench has 3/8" square drive to accommodate socket wrench or extension when desired

HANSON Thread Pitch Gauges



11016

HANSON T-Handle Ratcheting Tap Wrench



21112

- Three position gear box for quick, efficient ratcheting action
- Designed for use with taps, reamers, screw extractors and other tools with a square shank

TAPS & DIES

Description	Usage	Carded Item #	Bulk Item #
HANSON Tap Adaptors			
2pc Tap Adaptor Set	2 Sizes for Taps No. 0 to 1/2"	3095001	-
Small Tap Adaptor	For Taps No. 0 to 1/4"	-	3095001A
Large Tap Adaptor	For Taps 1/4" to 1/2"	-	3095001B
HANSON T-Handle Tap Wrench			
TR - 1E	For Taps No. 0 to 1/4" (3 mm to 6 mm)	12001	12401
TR - 1-1/2E	For Taps No. 12 to 5/16"	12115	12415
TR - 2E	For Taps 1/4" to 1/2" (6 mm to 12 mm)	12002	12402
HANSON Tap Wrenches with 3/8" Drive			
TR - 50	For Taps 1/4" to 1/2" (6 mm to 12 mm)	12050	12450
TR - 73*	For Taps No. 0 to 1/4" (3 mm - 6 mm) *	12073	12473
HANSON T-Handle Ratcheting Tap Wrench			
-	For Tap Sizes No. 0 to 1/4" (3 mm to 6 mm)	21201	21101
-	For Tap Sizes 1/4" to 1/2" (6 mm to 12 mm)	21202	21102
-	10" Extended Length for Tap Sizes #0 - 1/4" (3 mm to 6 mm)	21210	21110
-	12" Extended Length for Tap Sizes 1/4" - 1/2" (6 mm to 12 mm)	21212	21112
HANSON Metric Measuring Kit w/Thread Gauges			
Metric Measuring Kit		-	12087
HANSON Thread Pitch Gauges			
16-Leaf Metric Thread Pitch Gauge		12016	11016
16-Leaf Standard and Metric Thread Pitch Gauge		12017	11017
18-Leaf Standard Thread Pitch Gauge		12018	11018

*Note: TR-73 comes with a hexagon nut

Taps & Dies

High Carbon Steel Taps

HANSON® Machine Screw Taps (HCS)



1032



1132



1232

- Self-aligning tap
- Ideal for routine maintenance, repair work and for rethreading where high accuracy and tolerance thread is not critical
- Straight flutes are ground to provide rapid chip removal for efficient threading
- Designed for hand threading work in a variety of materials
- Taps produce a class 2B thread

Description	No. of Flutes	Plug Carded Item #	Plug Bulk Item #	Taper Bulk Item #	Bottom Bulk Item #	Self Aligning Bulk Item #
0 - 80 NF	2	-	1102	1002	1202	-
1 - 64 NC	2	-	1104	1004	1204	-
1 - 72 NF	2	-	1105	1005	1205	-
2 - 56 NC	3	-	1106	1006	1206	-
2 - 64 NF	3	-	1107	1007	1207	-
3 - 48 NC	3	-	1108	1008	1208	-
3 - 56 NF	3	-	1109	1009	1209	-
4 - 36 NS	3	8011	1111	1011	1211	-
4 - 40 NC	3	8012	1112	1012	1212	4935222
4 - 48 NF	3	-	1113	1013	1213	-
5 - 40 NC	3	-	1116	1016	1216	-
5 - 44 NF	3	-	1117	1017	1217	-
6 - 32 NC	3	8018	1118	1018	1218	4935223
6 - 36 NS	3	-	1119	1019	1219	-
6 - 40 NF	3	-	1120	1020	1220	-
6 - 48 NS	3	-	1121	1021	1221	-
8 - 32 NC	4	8024	1124	1024	1224	4935224
8 - 36 NF	4	-	1125	1025	1225	-
8 - 40 NS	4	-	1126	1026	1226	-
10 - 24 NC	4	8028	1128	1028	1228	4935225
10 - 32 NF	4	8031	1131	1031	1231	4935226
12 - 24 NC	4	8032	1132	1032	1232	4935227
12 - 28 NF	4	-	1133	1033	1233	-
12 - 32 NEF	4	-	1134	1034	1234	-
14 - 20 NS	4	8035	1135	1035	1235	-
14 - 24 NS	4	-	1136	1036	1236	-

HANSON Fractional Taps (HCS)



1323



1423



1523

- Self-aligning tap
- Ideal for routine maintenance, repair work and for rethreading where high accuracy and tolerance thread is not critical
- Straight flutes are ground to provide rapid chip removal for efficient threading
- Designed for hand threading work in a variety of materials
- Taps produce a class 2B thread

Description	No. of Flutes	Plug Carded Item #	Plug Bulk Item #	Taper Bulk Item #	Bottom Bulk Item #	Self Aligning Bulk Item #
1/8" - 40 NS	3	-	1406	1306	1506	-
1/8" - 44 NS	3	-	1407	-	-	-
5/32" - 32 NS	3	-	1410	-	-	-
5/32" - 36 NS	3	-	1411	-	-	-
3/16" - 24 NS	4	-	1412	1312	1512	-
3/16" - 32 NS	4	-	1413	1313	1513	-
1/4" - 20 NC	4	8120	1420	1320	1520	4935228
1/4" - 24 NS	4	-	1421	1321	1521	-
1/4" - 28 NF	4	8123	1423	1323	1523	4935229
1/4" - 32 NEF	4	-	1424	1324	1524	-
1/4" - 40 NS	4	-	1425	1325	1525	-
5/16" - 18 NC	4	8127	1427	1327	1527	4935230
5/16" - 24 NF	4	8129	1429	1329	1529	4935231
5/16" - 32 NEF	4	-	1431	1331	1531	-
3/8" - 16 NC	4	8134	1434	1334	1534	4935232
3/8" - 24 NF	4	8136	1436	1336	1536	4935233
7/16" - 14 NC	4	8139	1439	1339	1539	4935234
7/16" - 20 NF	4	8140	1440	1340	1540	4935235
1/2" - 13 NC	4	8144	1444	1344	1544	4935236
1/2" - 20 NF	4	8145	1445	1345	1545	4935237
1/2" - 24 NS	4	-	1446	1346	1546	-
9/16" - 12 NC	4	8148	1448	1348	1548	-
9/16" - 18 NF	4	8149	1449	1349	1549	-
5/8" - 11 NC	4	8152	1452	1352	1552	-
5/8" - 18 NF	4	8154	1454	1354	1554	-
11/16" - 11 NS	4	-	1456	1356	1556	-
11/16" - 16 NS	4	-	1457	1357	1557	-
3/4" - 10 NC	4	8158	1458	1358	1558	-
3/4" - 16 NF	4	8160	1460	1360	1560	-
7/8" - 9 NC	4	-	1461	1361	1561	-
7/8" - 14 NF	4	-	1463	1363	1563	-
1" - 8 NC	4	-	1465	1365	1565	-
1" - 12 NF	4	-	1466	1366	1566	-
1" - 14 NS	4	-	1467	1367	1567	-

TAPS & DIES

HANSON Metric Taps (HCS)



1859

- Ideal for auto repair and machinery where metric threads are specified

Description	No. of Flutes	Plug Carded Item #	Plug Bulk Item #	Bottom Bulk Item #	Self Aligning Bulk Item #
3 mm - 0.50	3	8312	1712	1812	4935238
3 mm - 0.60	3	-	1713	-	-
4 mm - 0.70	4	8317	1717	1817	4935239
4 mm - 0.75	4	8318	1718	1818	4935240
5 mm - 0.80	4	8322	1722	1822	4935241
5 mm - 0.90	4	8323	1723	1823	4935242
6 mm - 1.00	4	8327	1727	1827	4935243
6.3 mm - 1.00	4	-	1729	1829	-
7 mm - 1.00	4	8331	1731	1831	4935244
8 mm - 1.00	4	8333	1733	1833	4935245
8 mm - 1.25	4	8334	1734	1834	4935246
9 mm - 0.75	4	8335	1735	-	-
9 mm - 1.00	4	8336	1736	-	4935247
9 mm - 1.25	4	8337	1737	1837	4935248
10 mm - 1.00	4	8338	1738	1838	-
10 mm - 1.25	4	8339	1739	1839	4935249
10 mm - 1.50	4	8340	1740	1840	4935250
11 mm - 1.50	4	8341	1741	-	4935251
12 mm - 1.25	4	8342	1742	1842	4935252
12 mm - 1.50	4	8343	1743	-	-
12 mm - 1.75	4	8344	1744	1844	4935253
14 mm - 1.25	4	-	1749	1849	-
14 mm - 1.50	4	-	1750	-	-
14 mm - 2.00	4	-	1752	1852	-
16 mm - 1.00	4	-	1754	-	-
16 mm - 1.50	4	-	1755	1855	-
16 mm - 2.00	4	-	1756	1856	-
18 mm - 1.50	4	-	1759	1859	-
18 mm - 2.50	4	-	1761	1861	-
20 mm - 2.50	4	-	1764	1864	-
22 mm - 1.50	4	-	1765	1865	-
24 mm - 2.00	4	-	1768	1868	-
24 mm - 3.00	4	-	1769	1869	-

HANSON Pipe Taper Taps (HCS)



1903

- Cuts internal threads in pipes
- Nominal size of the tap is that of the pipe fitting being tapped
- Available in National Pipe Taper (NPT) and British Standard Pipe Taper (BSP)
- Ideal for pipe fittings
- Tapered at a rate of 3/4" per foot

Description	No. of Flutes	Plug Carded Item #	Taper Pouched Item #	Taper Bulk Item #
1/8" - 27 NPT	4	8202	-	1902
1/4" - 18 NPT	4	8203	-	1903
3/8" - 18 NPT	4	-	1904P	1904
1/2" - 14 NPT	4	-	1905P	1905
3/4" - 14 NPT	5	-	1906P	1906
1" - 11-1/2 NPT	5	-	-	1907
1-1/4" - 11-1/2 NPT	5	-	-	1908
1-1/2" - 11-1/2 NPT	6	-	-	1909
2" - 11-1/2 NPT	6	-	-	1910
1/8" - 28 BSP	4	-	-	1911
1/4" - 19 BSP	4	-	-	1912

HANSON 6-pc Pipe Taper Tap Set (HCS)



1921

Contents	Item # 1921
1/8" - 27 NPT	1902
1/4" - 18 NPT	1903
3/8" - 18 NPT	1904
1/2" - 14 NPT	1905
3/4" - 14 NPT	1906
1" - 11-1/2 NPT	1907

Taps & Dies

High Carbon Steel Taps

HANSON Spark Plug Taps (HCS)



2459

- Available in standard and metric threads
- Ideal for threading or re-threading spark plug holes

Description	No. of Flutes	Bulk Item #
14 mm - 1.25	4	2449
18 mm - 1.50	4	2459

HANSON Tap Sets with Taper, Bottoming & Plug Point Styles

2652



- Set contains all three chamfer styles for various uses

Description	No. of Flutes	Item #
6 - 32 NC	3	2518
8 - 32 NC	4	2524
10 - 24 NC	4	2528
10 - 32 NF	4	2531
1/8" - 40 NS	3	2606
1/8" - 44 NS	3	2607
5/32" - 32 NS	4	2610
5/32" - 36 NS	4	2611
3/16" - 24 NS	4	2612
3/16" - 32 NS	4	2613ZR
1/4" - 20 NC	4	2620
1/4" - 28 NF	4	2623
5/16" - 18 NC	4	2627
5/16" - 24 NF	4	2629
3/8" - 16 NC	4	2634
3/8" - 24 NF	4	2636
7/16" - 14 NC	4	2639
7/16" - 20 NF	4	2640
1/2" - 13 NC	4	2644
1/2" - 20 NF	4	2645
9/16" - 12 NC	4	2648
9/16" - 18 NF	4	2649ZR
5/8" - 11 NC	4	2652
5/8" - 18 NF	4	2654
3/4" - 10 NC	4	2658
3/4" - 16 NF	4	2660
7/8" - 9 NC	4	2661
7/8" - 14 NF	4	2663
1" - 8 NC	4	2665
1" - 12 NS	4	2666
1" - 14 NF	4	2667
3 mm - 0.50	3	2712
5 mm - 0.80	4	2722
6 mm - 1.00	4	2727
7 mm - 1.00	4	2731
8 mm - 1.00	4	2733
8 mm - 1.25	4	2734
10 mm - 1.00	4	2738
10 mm - 1.25	4	2739
10 mm - 1.50	4	2740
12 mm - 1.25	4	2742
12 mm - 1.75	4	2744
14 mm - 2.00	4	2752
16 mm - 2.00	4	2756

TAPS & DIES

HANSON Tap (HCS) & Drill Bit (HSS)



80238

- High speed steel drill bits ensure fast, precise drilling
- High carbon steel plug taps are ideal for general purpose threading

HANSON Tap (HCS) & Drill Bit (HSS) Self Aligning Performance Threading System (PTS)



1765531



HANSON Tap (HCS) & Drill Bit (HSS) Sets



80185

- These drill and tap combinations produce a thread that is strong and easy to tap
- 135° split point HSS drill bits ensure fast, precise drilling
- High carbon steel plug taps are ideal for general purpose threading

Description	Plug Carded Item #
4 - 40 NC Tap + No. 43 Drill Bit	80209
6 - 32 NC Tap + 7/64" Drill Bit	80213
8 - 32 NC Tap + No. 29 Drill Bit	80217
10 - 24 NC Tap + No. 25 Drill Bit	80220
10 - 32 NF Tap + No. 21 Drill Bit	80221
12 - 24 NC Tap + No. 16 Drill Bit	80222
1/4" - 20 NC Tap + 13/64" Drill Bit	80230
1/4" - 28 NF Tap + No. 3 Drill Bit	80232
5/16" - 18 NC Tap + Letter G Drill Bit	80235
3/8" - 16 NC Tap + Letter O Drill Bit	80238
1/2" - 13 NC Tap + 27/64" Drill Bit	80242
1/4" - 18 NPT Tap + 7/16" Drill Bit	80260
6 mm - 1.00 Tap + 5mm Drill Bit	80327
8 mm - 1.25 Tap + 17/64" Drill Bit	80334
10 mm - 1.50 Tap + 8.5 Drill Bit	80340

Description	Self Aligning Carded Item #
6 - 32 NC Tap + No. 36 Drill Bit	1765531
8 - 32 NC Tap + No. 29 Drill Bit	1765534
10 - 24 NC Tap + No. 25 Drill Bit	1765535
10 - 32 NF Tap + No. 21 Drill Bit	1765536
12 - 24 NC Tap + No. 16 Drill Bit	1765537
1/4" - 20 NC Tap + No. 7 Drill Bit	1765538
5/16" - 18 NC Tap + Letter F Drill Bit	1765539
3/8" - 16 NF Tap + 5/16" Drill Bit	1765540

Description	Contents		Item #
13-pc Set	Lock & Hardware Drill & Tap Set		80185
Thread Size	Plug Tap Item #	Drill Bit Size	Drill Bit Item #
6 - 32 NC	1118	7/64"	30107
8 - 32 NC	1124	No. 29	20129
10 - 24 NC	1128	No. 25	20125
10 - 32 NF	1131	No. 21	20121
12 - 24 NC	1132	No. 16	20116
1/4" - 20 NC	1420	13/64"	30113
Threading Tools			Item #
T-Handle Tap Wrench			12401

Description	Contents		Item #
13-pc Set	All-Purpose Drill & Tap Set		80187
Thread Size	Plug Tap Item #	Drill Bit Size	Drill Bit Item #
4 - 40 NC	1112	No. 43	20143
6 - 32 NC	1118	No. 35	20135
8 - 32 NC	1124	No. 29	20129
10 - 24 NC	1128	No. 25	20125
10 - 32 NF	1131	No. 21	20121
1/4" - 20 NC	1420	No. 7	20107
Threading Tools			Item #
T-Handle Tap Wrench			12401

Taps & Dies

High Carbon Steel Dies

HANSON® Self Aligning Dies (HCS) Performance Threading System (PTS)



4935027

- Threads straight every turn
- More steel at critical points for extra strength



TAPS & DIES

Description	1" Across Flat Self Aligning Bulk Item #
DIE SA 4-40NC 1" HEX	4935018
DIE SA 6-32NC 1" HEX	4935019
DIE SA 8-32NC 1" HEX	4935020
DIE SA 10-24NC 1" HEX	4935021
DIE SA 10-32NF 1" HEX	4935022
DIE SA 12-24NC 1" HEX	4935023
DIE SA 1/4"-20NC 1" HEX	4935024
DIE SA 1/4"-28NF 1" HEX	4935025
DIE SA 5/16"-18NC 1" HEX	4935026
DIE SA 5/16"-24NF 1" HEX	4935027
DIE SA 3/8"-16NC 1" HEX	4935028
DIE SA 3/8"-24NF 1" HEX	4935029
DIE SA 7/16"-14NC 1" HEX	4935030
DIE SA 7/16"-20NF 1" HEX	4935031
DIE SA 1/2"-13NC 1" HEX	4935032
DIE SA 1/2"-20NF 1" HEX	4935033
DIE SA 3-0 5MM 1" HEX	4935035
DIE SA 4-0 7MM 1" HEX	4935036
DIE SA 4-0 75MM 1" HEX	4935037
DIE SA 5-0 8MM 1" HEX	4935038
DIE SA 5-0 9MM 1" HEX	4935039
DIE SA 6-1MM 1" HEX	4935040
DIE SA 7-1MM 1" HEX	4935041
DIE SA 8-1MM 1" HEX	4935042
DIE SA 8-1 25MM 1" HEX	4935043
DIE SA 9-1MM 1" HEX	4935044
DIE SA 9-1 25MM 1" HEX	4935045
DIE SA 10-1 25MM 1" HEX	4935046
DIE SA 10-1 5MM 1" HEX	4935047
DIE SA 11-1 5MM 1" HEX	4935048
DIE SA 12-1 25MM 1" HEX	4935049
DIE SA 12-1 75MM 1" HEX	4935050
DIE SA 1/8" - 28BSP 1"HEX	4935051

HANSON Hexagon Machine Screw Dies (HCS)



6432

HANSON Hexagon Fractional Dies (HCS)



6544



8461

- Ideal for maintenance and repair work
- Recommended for use with hexagon die stock
- Die can be used with a wrench or socket when space is limited

Description	1" Across Flat Carded Item #	1" Across Flat Bulk Item #	1-7/16" Across Flat Bulk Item #	1-13/16" Across Flat Bulk Item #
Machine				
4 - 36 NS	9311	6411	-	-
4 - 40 NC	9312	6412	-	-
5 - 40 NC	-	6416	-	-
6 - 32 NC	9318	6418	-	-
8 - 32 NC	9324	6424	-	-
10 - 24 NC	9328	6428	-	-
10 - 32 NF	9331	6431	-	-
12 - 24 NC	9332	6432	-	-
14 - 20 NS	9335	6435	-	-

Description	1" Across Flat Carded Item #	1" Across Flat Bulk Item #	1-7/16" Across Flat Bulk Item #	1-13/16" Across Flat Bulk Item #
Fractional				
3/16" - 24 NS	-	6512	-	-
1/4" - 20 NC	9420	6520	-	-
1/4" - 28 NF	9423	6523	-	-
5/16" - 18 NC	9427	6527	-	-
5/16" - 24 NF	9429	6529	-	-
3/8" - 16 NC	9434	6534	-	-
3/8" - 24 NF	9436	6536	-	-
7/16" - 14 NC	9439	6539	-	-
7/16" - 20 NF	9440	6540	-	-
1/2" - 13 NC	9444	6544	-	-
1/2" - 20 NF	9445	6545	-	-
9/16" - 12 NC	-	-	6848	-
9/16" - 18 NF	-	-	6849	-
5/8" - 11 NC	-	-	6852	-
5/8" - 18 NF	-	-	6854	-
3/4" - 10 NC	-	-	6858	-
3/4" - 16 NF	-	-	6860	-
7/8" - 9 NC	-	-	-	8461
7/8" - 14 NF	-	-	-	8463
1" - 8 NC	-	-	-	8465
1" - 14 NS	-	-	-	8467

TAPS & DIES

Taps & Dies

High Carbon Steel Dies

HANSON Hexagon Pipe Taper Dies (HCS)



6703



7004

- Ideal for plumbing and air applications

Description	1" Across Flat Carded Item #	1" Across Flat Bulk Item #	1-7/16" Across Flat Bulk Item #
1/8" - 27 NPT	9502	6702	-
1/4" - 18 NPT	9503	6703	-
3/8" - 18 NPT	-	-	7004
1/2" - 14 NPT	-	-	7005
1/8" - 28 BSP	-	6711	-
1/4" - 19 BSP	-	6712	-

HANSON® Hexagon Metric Dies (HCS)

TAPS & DIES



6638



6949



8569

- Ideal for automotive repair and machinery where metric threads are specified

Description	1"Across Flat Carded Item #	1" Across Flat Bulk Item #	1-7/16" Across Flat Bulk Item #	1-13/16" Across Flat Bulk Item #
3 mm - 0.50	9712	6612	-	-
3 mm - 0.60	-	6613	-	-
4 mm - 0.70	9717	6617	-	-
4 mm - 0.75	9718	6618	-	-
5 mm - 0.80	9722	6622	-	-
5 mm - 0.90	9723	6623	-	-
6 mm - 1.00	9727	6627	-	-
6.3 mm - 1.00	-	6629	-	-
7 mm - 1.00	9731	6631	-	-
8 mm - 1.00	9733	6633	-	-
8 mm - 1.25	9734	6634	-	-
9 mm - 0.75	9735	6635	-	-
9 mm - 1.00	9736	6636	-	-
9 mm - 1.25	9737	6637	-	-
10 mm - 1.00	9738	6638	-	-
10 mm - 1.25	9739	6639	-	-
10 mm - 1.50	9740	6640	-	-
11 mm - 1.50	9741	6641	-	-
12 mm - 1.25	9742	6642	-	-
12 mm - 1.50	9743	6643	-	-
12 mm - 1.75	9744	6644	-	-
14 mm - 1.25	-	-	6949	-
14 mm - 1.50	-	-	6950	-
14 mm - 2.00	-	-	6952	-
16 mm - 1.00	-	-	6954	-
16 mm - 1.50	-	-	6955	-
16 mm - 2.00	-	-	6956	-
18 mm - 1.50	-	-	6959	-
18 mm - 2.50	-	-	6961	-
20 mm - 2.50	-	-	-	8564
22 mm - 1.50	-	-	-	8565
24 mm - 2.00	-	-	-	8568
24 mm - 3.00	-	-	-	8569

HANSON Round Machine Screw Dies (HCS)



3718



3028

- Solid round dies ideal for general purpose threading
- Adjustable round dies ideal for precision threading

Description	1" Overall Diam. Screw Adj. Bulk Item #	1" Overall Diam. Solid Bulk Item #
4 - 40 NC	3712	—
4 - 48 NF	3713	—
5 - 40 NC	3716	—
5 - 44 NF	3717	—
6 - 32 NC	3718	—
6 - 36 NS	3719	—
6 - 40 NF	3720	—
6 - 48 NS	3721	—
8 - 32 NC	3724	—
8 - 36 NF	3725	—
8 - 40 NS	3726	—
10 - 24 NC	3728	3028
10 - 32 NF	3731	—
12 - 24 NC	3732	—
12 - 28 NF	3733	—
14 - 20 NS	3735	—

HANSON Round Fractional Dies (HCS)



3820



3120

- Solid round dies ideal for general purpose threading
- Adjustable round dies ideal for precision threading

Description	1" Overall Diam. Screw Adj. Bulk Item #	1" Overall Diam. Solid Bulk Item #
3/16" - 32 NS	3813	—
1/4" - 20 NC	3820	3120
1/4" - 24 NS	3821	—
1/4" - 28 NF	3823	—
1/4" - 32 NEF	3824	—
1/4" - 40 NS	3825	—
5/16" - 18 NC	3827	3127
5/16" - 24 NF	3829	—
5/16" - 32 NEF	3831	—
3/8" - 16 NC	3834	3134
3/8" - 24 NF	3836	—
7/16" - 14 NC	3839	—
7/16" - 20 NF	3840	—
1/2" - 13 NC	3844	—
1/2" - 20 NF	3845	—
1/2" - 24 NS	3846	—

Taps & Dies

High Carbon Steel Dies

HANSON Adjustable Round Fractional Dies Right & Left-Hand (HCS)



4020



7520



7652

TAPS & DIES

- Adjustable round dies ideal for precision threading
- Left-hand dies cut threads with a left-hand rotation

Description	Right-Hand 1-1/2" O.D. Bulk Item #	Right-Hand 2" O.D. Bulk Item #	Right-Hand 3" O.D. Bulk Item #	Left-Hand 1" O.D. Bulk Item #	Left-Hand 1-1/2" O.D. Bulk Item #
1/4" - 20 NC	4020	-	-	7520	-
1/4" - 28 NF	4023	-	-	7523	-
5/16" - 18 NC	4027	-	-	7527	-
5/16" - 24 NF	4029	-	-	7529	-
3/8" - 16 NC	4034	-	-	7534	-
3/8" - 24 NF	4036	-	-	7536	-
7/16" - 14 NC	4039	-	-	7539	-
7/16" - 20 NF	4040	-	-	7540	-
1/2" - 13 NC	4044	-	-	7544	-
1/2" - 20 NF	4045	-	-	7545	-
9/16" - 12 NC	4048	-	-	-	7648
9/16" - 18 NF	4049	-	-	-	7649
5/8" - 11 NC	4052	-	-	-	7652
5/8" - 18 NF	4054	-	-	-	7654
11/16" - 11 NS	4056	-	-	-	-
11/16" - 16 NS	4057	-	-	-	-
3/4" - 10 NC	4058	-	-	-	7658
3/4" - 16 NF	4060	-	-	-	7660
7/8" - 9 NC	-	4261	-	-	-
7/8" - 14 NF	-	4263	-	-	-
1" - 8 NC	-	4265	-	-	-
1" - 12 NF	-	4266	-	-	-
1" - 14 NS	-	4267	-	-	-
1-1/8" - 7 NC	-	-	4668	-	-
1-1/8" - 12 NF	-	-	4669	-	-
1-1/4" - 7 NC	-	-	4670	-	-
1-1/4" - 12 NF	-	-	4671	-	-
1-3/8" - 6 NC	-	-	4672	-	-
1-3/8" - 12 NF	-	-	4673	-	-
1-1/2" - 6 NC	-	-	4674	-	-
1-1/2" - 12 NF	-	-	4675	-	-

HANSON Round Pipe Taper Dies (HCS)



4102

Description	1-1/2" O.D. Solid Round Bulk Item #	1-1/2" O.D. Screw Adj. Bulk Item #	1" O.D. Screw Adj. Bulk Item #	2" O.D. Screw Adj. Bulk Item #
1/8" - 27 NPT	4102	5102	502101*	-
1/4" - 18 NPT	4103	5103	-	-
3/8" - 18 NPT	4104	5104	-	-
1/2" - 14 NPT	4105	5105	-	-
1/2" - 14 NPT	-	-	-	4305
3/4" - 14 NPT	-	-	-	4306

*Note: 502101 is a High Speed Steel Die

The IRWIN HANSON Performance Threading System is available in handy modular set configurations, so professionals can choose only what they need. SAE and Metric taps and dies are available. Sizes are clearly imprinted on the cases for easier replacement and storage. Plus, sets have clear, detachable lids, and they're only 1-1/2" thick, to easily fit in the smallest drawer in the toolbox.



HANSON PTS Fractional Tap & Die Modules



4935352

4935058

HANSON PTS Metric Tap & Die Modules



4935353

4935059

Set Contents	Item # 4935056	Item # 4935352	Item # 4935060	Item # 4935058
Thread Size Fractional	Tap Item # Plug Style	Tap Item # Alignment Style	1" Solid Hex Die Item # Plug Style	1" Solid Hex Die Item # Alignment Style
4 - 40 NC	1112	4935222	6412	4935018
6 - 32 NC	1118	4935223	6418	4935019
8 - 32 NC	1124	4935224	6424	4935020
10 - 24 NC	1128	4935225	6428	4935021
10 - 32 NF	1131	4935226	6431	4935022
12 - 24 NC	1132	4935227	6432	4935023
1/4" - 20 NC	1420	4935228	6520	4935024
1/4" - 28 NF	1423	4935229	6523	4935025
5/16" - 18 NC	1427	4935230	6527	4935026
5/16" - 24 NF	1429	4935231	6529	4935027
3/8" - 16 NC	1434	4935232	6534	4935028
3/8" - 24 NF	1436	4935233	6536	4935029
7/16" - 14 NC	1439	4935234	6539	4935030
7/16" - 20 NF	1440	4935235	6540	4935031
1/2" - 13 NC	1444	4935236	6544	4935032
1/2" - 20 NF	1445	4935237	6545	4935033
1/8" - 27NPT	1902	1902	6702	6702

Set Contents	Item # 4935057	Item # 4935353	Item # 4935061	Item # 4935059
Thread Size Metric	Tap Item # Plug Style	Tap Item # Alignment Style	1" Solid Hex Die Item # Plug Style	1" Solid Hex Die Item # Alignment Style
3 - 0.50MM	1712	4935238	6612	4935035
4 - 0.70MM	1717	4935239	6617	4935036
4 - 0.75MM	1718	4935240	6618	4935037
5 - 0.80MM	1722	4935241	6622	4935038
5 - 0.90MM	1723	4935242	6623	4935039
6 - 1.00MM	1727	4935243	6627	4935040
7 - 1.00MM	1731	4935244	6631	4935041
8 - 1.00MM	1733	4935245	6633	4935042
8 - 1.25MM	1734	4935246	6634	4935043
9 - 1.00MM	1736	4935247	6636	4935044
9 - 1.25MM	1737	4935248	6637	4935045
10 - 1.25MM	1739	4935249	6639	4935046
10 - 1.50MM	1740	4935250	6640	4935047
11 - 1.50MM	1741	4935251	6641	4935048
12 - 1.25MM	1743	4935252	6642	4935049
12 - 1.75MM	1744	4935253	6644	4935050
1/8" - 28BSP	1911	1911	6711	6711

HANSON PTS Drive Tool Module



4935055

Threading Tools

Item # 4935055

Tap Driver - Small: Adj Tap Socket Drives Taps Sizes No. 4 (3mm) To 1/4" (6mm)	4935052
Tap Driver - Medium: Adj Tap Socket Drives Taps Sizes 1/4" (3mm) To 1/2" (12mm)	4935053
Die Stock: Drives 1" Hex Dies With And Without Alignment, Accepts Sm & Med Adj Tap Sockets	4935054
Metric Pitch Gauge	11016
SAE Pitch Gauge	11018
Die Spacer Bulk, Hex - IRWIN	1775311
T-Bar For Adj. Tap Socket Bulk - IRWIN	1775312

HANSON PTS Plug Module Combo Sets



4935354

Plug Set Contents	Item # 4935354	Item # 4935062	Item # 4935063	Item # 4935064
SAE Tap Plug Style	4935056	4935056	-	4935056
Metric Tap Plug Style	4935057	-	4935057	4935057
1" Solid Hex SAE Die Plug Style	4935060	4935060	-	-
1" Solid Hex Metric Die Plug Style	4935061	-	4935061	-
Drive Tools	4935055	4935055	4935055	4935055

TAPS & DIES

HANSON PTS Alignment Module Combo Sets



4935357

Alignment Set Contents	Item # 4935355	Item # 4935356	Item # 4935357	Item # 4935358	Item # 4935359
SAE Tap Alignment Style	4935352	4935352	-	4935352	
Metric Tap Alignment Style	4935353	-	4935353	4935353	
1" Solid Hex SAE Die Alignment Style	4935058	4935058	-	-	4935058
1" Solid Hex Metric Die Alignment Style	4935059	-	4935059	-	4935059
Drive Tools	4935055	4935055	4935055	4935055	4935055



HANSON 117-piece Machine Screw/ Fractional/Metric Tap & Hex Die and Drill Bit Deluxe Set



26377

Set Contents				Set Item # 26377	
Thread Size Machine Screw	Tap Item # Plug Style	Die Item # 5/8" Hexagon	Drill Bit Size	Drill Bit Item #	
4 - 40 NC	1112	6112	No. 43	80143	
6 - 32 NC	1118	6118	No. 36	80136	
8 - 32 NC	1124	6124	No. 29	80129	
10 - 24 NC	1128	6128	No. 25	80125	
10 - 32 NF	1131	6131	No. 21	80121	
12 - 24 NC	1132	6132	No. 16	80116	
Fractional					
		1" Hexagon			
1/4" - 20 NC	1420	6520	No. 7	80107	
1/4" - 28 NF	1423	6523	No. 3	80103	
5/16" - 18 NC	1427	6527	Letter F	40106	
5/16" - 24 NF	1429	6529	Letter I	40109	
3/8" - 16 NC	1434	6534	5/16"	60120	
3/8" - 24 NF	1436	6536	Letter Q	40117	
7/16" - 14 NC	1439	6539	Letter U	40121	
7/16" - 24 NF	1440	6540	25/64"	60125	
1/2" - 13 NC	1444	6544	27/64"	60127	
1/2" - 20 NF	1445	6545	29/64"	60129	
Metric					
		5/8" Hexagon			
3 mm - 0.50	1712	6312	No. 39	80139	
4 mm - 0.70	1717	6317	No. 30	80130	
4 mm - 0.75	1718	6318	No. 30	80130*	
5 mm - 0.80	1722	6322	No. 19	90119	
5 mm - 0.90	1723	6323	No. 20	80120	
6 mm - 1.00	1727	6327	No. 9	80109	
		1" Hexagon			
7 mm - 1.00	1731	6631	Letter B	40102	
8 mm - 1.00	1733	6633	Letter J	40110	
8 mm - 1.25	1734	6634	Letter H	40108	
9 mm - 1.00	1736	6636	Letter O	40115	
9 mm - 1.25	1737	6637	5/16"	60120*	
10 mm - 1.25	1739	6639	Letter S	40119	
10 mm - 1.50	1740	6640	Letter R	40118	
11 mm - 1.50	1741	6641	3/8"	60124	
12 mm - 1.50	1743	6643	Letter Z	40126	
12 mm - 1.75	1744	6644	13/32"	60126	
Pipe					
1/8" - 27 NPT	1902	6702	Letter Q	40117*	
1/8" - 28 BSP	1911	6711	21/64"	60121	
Spiral Flute Screw Extractor			Drill Bit Size	Item #	
EX - 1			5/64"	60105	
EX - 2			7/64"	60107	
EX - 3			5/32"	60110	
EX - 4			1/4"	60116	
EX - 5			19/64"	60119	
Threading Tools					Item #
Adjustable Die Stock - 1" Dies					11026
Plain Die Stock - 5/8" Hexagon Dies					12457
Adj. Handle Tap Wrench - Taps No. 0 to 1/2"					311088
Two-in-One Tap Wrench - Taps 1/4" to 1/2"					12450
T-Handle Wrench - Taps No. 0 to 1/4"					12473
16 Leaf Metric Thread Pitch Gauge					11016
18 Leaf Standard Thread Pitch Gauge					11018
Empty Plastic Case For 26377					26377MT

* Duplicate

Taps & Dies

High Carbon Steel Combination Sets

HANSON® 76-piece Machine Screw/ Fractional/Metric Tap & Hex Die Set



26376

TAPS & DIES

Set Contents		Item # 26376
Thread Size Machine Screw	Tap Item # Plug Style	Die Item # 5/8" Hexagon
4 - 40 NC	1112	6112
6 - 32 NC	1118	6118
8 - 32 NC	1124	6124
10 - 24 NC	1128	6128
10 - 32 NF	1131	6131
12 - 24 NC	1132	6132
Fractional		1" Hexagon
1/4" - 20 NC	1420	6520
1/4" - 28 NF	1423	6523
5/16" - 18 NC	1427	6527
5/16" - 24 NF	1429	6529
3/8" - 16 NC	1434	6534
3/8" - 24 NF	1436	6536
7/16" - 14 NC	1439	6539
7/16" - 20 NF	1440	6540
1/2" - 13 NC	1444	6544
1/2" - 20 NF	1445	6545
Metric		5/8" Hexagon
3 mm - 0.50	1712	6312
4 mm - 0.70	1717	6317
4 mm - 0.75	1718	6318
5 mm - 0.80	1722	6322
5 mm - 0.90	1723	6323
6 mm - 1.00	1727	6327
		1" Hexagon
7 mm - 1.00	1731	6631
8 mm - 1.00	1733	6633
8 mm - 1.25	1734	6634
9 mm - 1.00	1736	6636
9 mm - 1.25	1737	6637
10 mm - 1.25	1739	6639
10 mm - 1.50	1740	6640
11 mm - 1.50	1741	6641
12 mm - 1.50	1743	6643
12 mm - 1.75	1744	6644
Pipe		
1/8" - 27 NPT	1902	6702
1/8" - 28 BSP	1911	6711
Threading Tools		Item #
Adj. Die Stock - 1" Dies		11026
Plain Die Stock - 5/8" Hexagon Dies		12457
Adj. Handle Tap Wrench - Taps No. 0 to 1/2"		311088
Two-in-One Tap Wrench - Taps 1/4" to 1/2"		12450
T-Handle Wrench - Taps No. 0 to 1/4"		12473
16 Leaf Metric Thread Pitch Gauge		11016
18 Leaf Standard Thread Pitch Gauge		11018
Empty Plastic Case For 26376		26376MT

HANSON 66-piece Machine Screw/ Fractional Tap & Hex Die Set

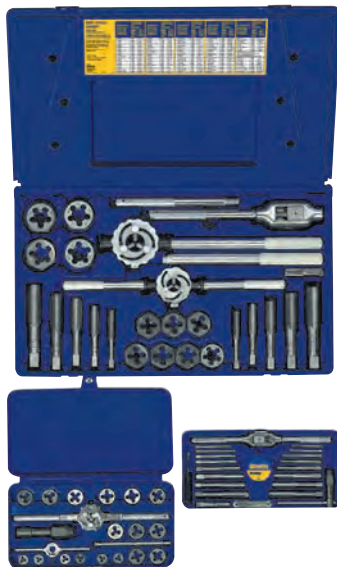

97606

Set Contents		Item # 97606
Thread Size	Tap Item #	Die Item #
Machine Screw	Plug Style	5/8" Hexagon
4 - 40 NC	1112	6112
6 - 32 NC	1118	6118
8 - 32 NC	1124	6124
10 - 24 NC	1128	6128
10 - 32 NF	1131	6131
12 - 24 NC	1132	6132
Fractional		1" Hexagon
1/4" - 20 NC	1420	6520
1/4" - 28 NF	1423	6523
5/16" - 18 NC	1427	6527
5/16" - 24 NF	1429	6529
3/8" - 16 NC	1434	6534
3/8" - 24 NF	1436	6536
7/16" - 14 NC	1439	6539
7/16" - 20 NF	1440	6540
1/2" - 13 NC	1444	6544
1/2" - 20 NF	1445	6545
		1-7/16" Hexagon
9/16" - 12 NC	1448	6848
9/16" - 18 NF	1449	6849
5/8" - 11 NC	1452	6852
5/8" - 18 NF	1454	6854
3/4" - 10 NC	1458	6858
3/4" - 16 NF	1460	6860
		1-13/16" Hexagon
7/8" - 9 NC	1461	8461
7/8" - 14 NF	1463	8463
1" - 8 NC	1465	8465
1" - 14 NS	1467	8467
Pipe		1" Hexagon
1/8" - 27 NPT	1902	6702
1/4" - 18 NPT	1903	7003
Threading Tools		Item #
Adj. Die Stock - 1" Dies		11026
Adj. Die Stock - 1-7/16" Hexagon Dies		12436
Adj. Die Stock - 1-13/16" Hexagon Dies		12446
Plain Die Stock - 5/8" Hexagon Dies		12457
Adj. Handle Tap Wrench - Taps No. 0 to 1/2"		311088
Adj. Handle Tap Wrench - Taps 1/4" to 1"		12498
Two-in-One Tap Wrench - Taps 1/4" to 1/2"		12450
T-Handle Wrench - Taps No. 0 to 1/4"		12473
18 Leaf Standard Thread Pitch Gauge		11018

Taps & Dies

High Carbon Steel Combination Sets

HANSON® 66-piece Metric Tap & Hex Die Set



97312

TAPS & DIES

Set Contents		Item # 97312
Thread Size Metric	Tap Item # Plug Style	Die Item # 5/8" Hexagon
3 mm - 0.50	1712	6312
4 mm - 0.70	1717	6317
4 mm - 0.75	1718	6318
5 mm - 0.80	1722	6322
5 mm - 0.90	1723	6323
6 mm - 1.00	1727	6327
		1" Hexagon
7 mm - 1.00	1731	6631
8 mm - 1.00	1733	6633
8 mm - 1.25	1734	6634
9 mm - 1.00	1736	6636
9 mm - 1.25	1737	6637
10 mm - 1.25	1739	6639
10 mm - 1.50	1740	6640
11 mm - 1.50	1741	6641
12 mm - 1.50	1743	6643
12 mm - 1.75	1744	6644
		1-7/16" Hexagon
14 mm - 1.25	2449	6949
14 mm - 1.50	1750	6950
14 mm - 2.00	1752	6952
16 mm - 1.50	1755	6955
16 mm - 2.00	1756	6956
18 mm - 1.50	1759	6959
18 mm - 2.50	1761	6961
		1-13/16" Hexagon
20 mm - 2.50	1764	8564
22 mm - 1.50	1765	8565
24 mm - 2.00	1768	8568
24 mm - 3.00	1769	8569
Pipe		1" Hexagon
1/8" - 28 BSP	1911	6711
Threading Tools		Item #
Adj. Die Stock - 1" Dies		11026
Adj. Die Stock - 1-7/16" Hexagon Dies		12436
Adj. Die Stock - 1-3/16" Hexagon Dies		12446
Plain Die Stock - 5/8" Hexagon Dies		12457
T-Handle Wrench - Taps No. 0 to 1/4"		12473
Adj. Handle Tap Wrench - Taps No. 0 to 1/2"		311088
Adj. Handle Tap Wrench - Taps 1/4" to 1"		12498
Two-in-One Tap Wrench - Taps 1/4" to 1/2"		12450
16 Leaf Metric Thread Pitch Gauge		11016

HANSON 53-piece Machine Screw/ Fractional Tap & Hex Die Set



24640

HANSON 53-piece Metric Tap & Hex Die Set



26394

Set Contents		Item # 24640
Thread Size	Tap Item #	Die Item #
Machine Screw	Plug Style	1" Hexagon
6 - 32 NC	1118	6418
8 - 32 NC	1124	6424
10 - 24 NC	1128	6428
10 - 32 NF	1131	6431
12 - 24 NC	1132	6432
Fractional		
1/4" - 20 NC	1420	6520
1/4" - 28 NF	1423	6523
5/16" - 18 NC	1427	6527
5/16" - 24 NF	1429	6529
3/8" - 16 NC	1434	6534
3/8" - 24 NF	1436	6536
7/16" - 14 NC	1439	6539
7/16" - 20 NF	1440	6540
1/2" - 13 NC	1444	6544
1/2" - 20 NF	1445	6545
1-7/16" Hexagon		
9/16" - 12 NC	1448	6848
9/16" - 18 NF	1449	6849
5/8" - 11 NC	1452	6852
5/8" - 18 NF	1454	6854
3/4" - 10 NC	1458	6858
3/4" - 16 NF	1460	6860
Pipe		
1/8" - 27 NPT Pipe	1902	6072
1/4" - 18 NPT Pipe	1903	6703
Threading Tools		Item #
Adj. Die Stock - 1" Dies		11026
Adj. Die Stock - 1-7/16" Hexagon Dies		12436
T-Handle Wrench - Taps No. 0 to 1/4"		12473
Adj. Handle Tap Wrench - Taps No. 0 to 1/2"		311088
Adj. Handle Tap Wrench - Taps 1/4" to 1"		12498
18 Leaf Standard Thread Pitch Gauge		11018
Set Contents		Item # 26394
Thread Size	Tap Item #	Die Item #
Metric Screw	Plug Style	1" Hexagon
3 mm - 0.50	1712	6612
4 mm - 0.70	1717	6617
4 mm - 0.75	1718	6618
5 mm - 0.80	1722	6622
5 mm - 0.90	1723	6623
6 mm - 1.00	1727	6627
7 mm - 1.00	1731	6631
8 mm - 1.25	1734	6634
9 mm - 1.00	1736	6636
9 mm - 1.25	1737	6637
10 mm - 1.25	1739	6639
10 mm - 1.50	1740	6640
11 mm - 1.50	1741	6641
12 mm - 1.50	1743	6643
12 mm - 1.75	1744	6644
1-7/16" Hexagon		
14 mm - 1.25	1749	6949
14 mm - 2.00	1752	6952
16 mm - 1.50	1755	6955
16 mm - 2.00	1756	6956
18 mm - 1.50	1759	6959
18 mm - 2.50	1761	6961
Pipe		
1/8" - 28 BSP	1911	6711
1/4" - 19 BSP	1912	6712
Threading Tools		Item #
Adj. Die Stock - 1" Dies		11026
Adj. Die Stock - Hexagon Dies		12436
T-Handle Wrench - Taps No. 0 to 1/4"		12473
T-Handle Wrench - Taps No. 0 to 1/2"		311088
Adj. Handle Tap Wrench - Taps 1/4" to 1"		12498
16 Leaf Metric Thread Pitch Gauge		11016
Empty Plastic Case		26394MT

HANSON® 41-piece Machine Screw/Fractional Tap & Hex Die Set



24606

- Plastic storage case with removable tray keeps all tools organized

TAPS & DIES

HANSON 41-piece Metric Tap & Hex Die Set



26317

Set Contents		Item # 24606
Thread Size	Tap Item #	Die Item #
Machine Screw	Plug Style	5/8" Hexagon
4 - 40 NC	1112	6112
6 - 32 NC	1118	6118
8 - 32 NC	1124	6124
10 - 24 NC	1128	6128
10 - 32 NF	1131	6131
12 - 24 NC	1132	6132
Fractional		1" Hexagon
1/4" - 20 NC	1420	6520
1/4" - 28 NF	1423	6523
5/16" - 18 NC	1427	6527
5/16" - 24 NF	1429	6529
3/8" - 16 NC	1434	6534
3/8" - 24 NF	1436	6536
7/16" - 14 NC	1439	6539
7/16" - 20 NF	1440	6540
1/2" - 13 NC	1444	6544
1/2" - 20 NF	1445	6545
Pipe		1" Hexagon
1/8" - 27 NPT	1902	6702
Threading Tools		Item #
Adj. Die Stock - 1" Dies		11026
Plain Die Stock - 5/8" Hexagon Dies		12457
Adj. Handle Tap Wrench - Taps No. 0 to 1/2"		311088
T-Handle Wrench - Taps No. 0 to 1/4"		12473
Two-in-One Tap Wrench - Taps 1/4" to 1/2"		12450
18 Leaf Standard Thread Pitch Gauge		11018
Empty Plastic Case		24606MT

Set Contents		Item # 26317
Thread Size	Tap Item #	5/8" Die Item #
Metric	Plug Style	Item #
3 mm - 0.50	1712	6312
4 mm - 0.70	1717	6317
4 mm - 0.75	1718	6318
5 mm - 0.80	1722	6322
5 mm - 0.90	1723	6323
6 mm - 1.00	1727	6327
		1" Die Item #
7 mm - 1.00	1731	6631
8 mm - 1.00	1733	6633
8 mm - 1.25	1734	6634
9 mm - 1.00	1736	6636
9 mm - 1.25	1737	6637
10 mm - 1.25	1739	6639
10 mm - 1.50	1740	6640
11 mm - 1.50	1741	6641
12 mm - 1.50	1743	6643
12 mm - 1.75	1744	6644
Pipe		Item #
1/8" - 28 BSP	1911	6711
Threading Tools		Item #
Adj. Die Stock - 1" Dies		11026
Plain Die Stock - 5/8" Hexagon Dies		12457
Adj. Handle Tap Wrench - Taps No. 0 to 1/2"		311088
T-Handle Wrench - Taps No. 0 to 1/4"		12473
Two-in-One Tap Wrench - Taps 1/4" to 1/2"		12450
16 Leaf Metric Thread Pitch Gauge		11016
Empty Plastic Case		26317MT

HANSON® 25-piece Fractional Tap & Hex Die Set



97094

Set Contents

Thread Size Fractional	Tap Item # Plug Style	Die Item # 1-7/16" Hexagon	Item # 97094
9/16" - 12 NC	1448	6848	
9/16" - 18 NF	1449	6849	
5/8" - 11 NC	1452	6852	
5/8" - 18 NF	1454	6854	
3/4" - 10 NC	1458	6858	
3/4" - 16 NF	1460	6860	
			1-13/16" Hexagon
7/8" - 9 NC	1461	8461	
7/8" - 14 NF	1463	8463	
1" - 8 NC	1465	8465	
1" - 14 NS	1467	8467	
Pipe			1-7/16" Hexagon
1/4" - 18 NPT	1903	7003	
Threading Tools			Item #
Adj. Die Stock - 1-7/16" Hexagon Dies			12436
Adj. Die Stock - 1-13/16" Hexagon Dies			12446
Adj. Handle Tap Wrench - Taps 1/4" to 1"			12498
Empty Plastic Case			97094MT

HANSON 25-piece Metric Tap & Hex Die Set

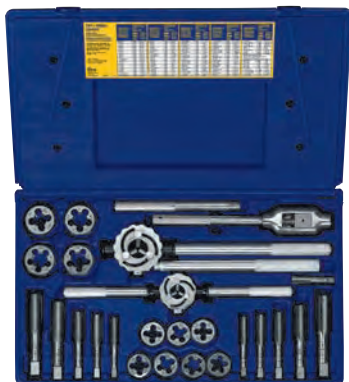

97311

Set Contents

Thread Size Metric	Tap Item # Plug Style	Die Item # 1-7/16" Hexagon	Item # 97311
14 mm - 1.25	2449*	6949	
14 mm - 1.50	1750	6950	
14 mm - 2.00	1752	6952	
16 mm - 1.50	1755	6955	
16 mm - 2.00	1756	6956	
18 mm - 1.50	1759	6959	
18 mm - 2.50	1761	6961	
			1-13/16" Hexagon
20 mm - 2.50	1764	8564	
22 mm - 1.50	1765	8565	
24 mm - 2.00	1768	8568	
24 mm - 3.00	1769	8569	
Threading Tools			Item #
Adj. Die Stock - 1-7/16" Hexagon Dies			12436
Adj. Die Stock - 1-13/16" Hexagon Dies			12446
Adj. Handle Tap Wrench - Taps 1/4" to 1"			12498
Empty Plastic Case			97311MT

Taps & Dies

High Carbon Steel Combination Sets

HANSON® 41-piece Machine Screw/ Fractional/Metric Tap & Hex Die Set



26319

TAPS & DIES

HANSON 12-piece Machine Screw/ Fractional Tap & Hex Die Set



24605

HANSON 12-piece PTS Self-Aligning Machine Screw/Metric Tap & Die Set



1765541

Set Contents		Item # 26319
Thread Size	Tap Item #	Die Item #
Machine Screw	Plug Style	5/8" Hexagon
6 - 32 NC	1118	6118
8 - 32 NC	1124	6124
10 - 24 NC	1128	6128
Fractional		1" Hexagon
1/4" - 20 NC	1420	6520
5/16" - 18 NC	1427	6527
3/8" - 16 NC	1434	6534
7/16" - 14 NC	1439	6539
1/2" - 13 NC	1444	6544
1/8" - 27 NPT	1902	6702
Metric		5/8" Hexagon
4 mm - 0.75	1718	6318
5 mm - 0.80	1722	6322
6 mm - 1.00	1727	6327
		1" Hexagon
7 mm - 1.00	1731	6631
8 mm - 1.25	1734	6634
10 mm - 1.25	1739	6639
10 mm - 1.50	1740	6640
12 mm - 1.75	1744	6644
Threading Tools		Item #
Adj. Die Stock - 1" Dies		11026
Plain Die Stock - 5/8" Hexagon Dies		12457
Adj. Handle Tap Wrench - Taps No. 0 to 1/2"		311088
T-Handle Wrench - Taps No. 0 to 1/4"		12473
Two-in-One Tap Wrench - Taps 1/4" to 1/2"		12450
Standard and Metric Thread Pitch Gauge		11017

Set Contents		Item # 24605
Thread Size	Tap Item #	Die Item #
Machine Screw	Plug Style	5/8" Hexagon
6 - 32 NC	1118	6118
8 - 32 NC	1124	6124
10 - 24 NC	1128	6128
10 - 32 NF	1131	6131
Fractional		
1/4" - 20 NC	1420	6220
Threading Tools		Item #
Plain Die Stock - 5/8" Hexagon Dies		12457
T-Handle Tap Wrench - Taps No. 0 to 1/4"		12401

Set Contents		Item # 1765541
Thread Size	Tap Item #	Die Item #
Machine Screw	Plug Style	5/8" Hexagon
3mm - 0.50	1712	6312
4mm - 0.70	1717	6317
5mm - 0.80?	1722	6322
6mm - 1.00	1727	6327
7mm - 1.00	1731	6631
Threading Tools		Item #
Plain Die Stock - 5/8" Hexagon Dies		12457
T-Handle Tap Wrench - Taps No. 0 to 1/4"		12401

HANSON 24-piece Fractional Tap & Hex Die Set



24614

Set Contents		Item # 24614
Thread Size Fractional	Tap Item # Plug Style	Die Item # 1" Hexagon
1/4" - 20 NC	1420	6520
1/4" - 28 NF	1423	6523
5/16" - 18 NC	1427	6527
5/16" - 24 NF	1429	6529
3/8" - 16 NC	1434	6534
3/8" - 24 NF	1436	6536
7/16" - 14 NC	1439	6539
7/16" - 20 NF	1440	6540
1/2" - 13 NC	1444	6544
1/2" - 20 NF	1445	6545
Pipe		
1/8" - 27 NPT	1902	6702
Threading Tools		Item #
Plain Die Stock - 1" Dies		11008
Offset Adj. Tap Wrench - Taps No. 0 to 1/2"		12421

HANSON 24-piece Metric Tap & Hex Die Set

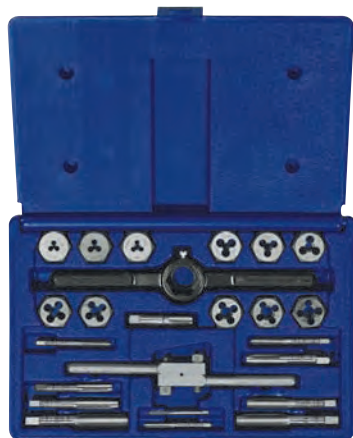

26313

Set Contents		Item # 26313
Thread Size Metric	Tap Item # Plug Style	Die Item # 1" Hexagon
3 mm - 0.50	1712	6612
4 mm - 0.70	1717	6617
5 mm - 0.80	1722	6622
6 mm - 1.00	1727	6627
7 mm - 1.00	1731	6631
8 mm - 1.25	1734	6634
9 mm - 1.25	1737	6637
10 mm - 1.50	1740	6640
12 mm - 1.50	1743	6643
12 mm - 1.75	1744	6644
Pipe		
1/8" - 28 BSP	1911	6711
Threading Tools		Item #
Plain Die Stock - 1" Dies		11008
Offset Adj. Tap Wrench - Taps No. 0 to 1/2"		12421

HANSON 12-piece Fractional Tap & Hex Die Set



24612

Set Contents		Item # 24612
Thread Size Fractional	Tap Item # Plug Style	Die Item # 1" Hexagon
1/4" - 20 NC	1420	6520
5/16" - 18 NC	1427	6527
3/8" - 16 NC	1434	6534
7/16" - 14 NC	1439	6539
1/2" - 13 NC	1444	6544
Threading Tools		Item #
Plain Die Stock - 1" Dies		11008
Offset Adj. Tap Wrench - Taps No. 0 to 1/2"		12421

Taps & Dies

High Carbon Steel Combination Sets

HANSON® 64-piece Machine Screw/ Fractional Tap & Solid/ Adjustable Round Die Set



98614

TAPS & DIES

Set Contents

Item # 98614

Thread Size Machine Screw	Tap Item # Plug Style	Die Item # 1" Solid Round
4 - 40 NC	1112	3012
6 - 32 NC	1118	3018
8 - 32 NC	1124	3024
10 - 24 NC	1128	3028
10 - 32 NF	1131	3031
12 - 24 NC	1132	3032
Fractional		
1/4" - 20 nc	1420	3120
1/4" - 28 nf	1423	3123
5/16" - 18 nc	1427	3127
5/16" - 24 nf	1429	3129
3/8" - 16 nc	1434	3134
3/8" - 24 nf	1436	3136
7/16" - 14 nc	1439	3139
7/16" - 20 nf	1440	3140
1/2" - 13 nc	1444	3144
1/2" - 20 nf	1445	3145
1-1/2" Adj. Round		
9/16" - 12 NC	1448	4048
9/16" - 18 NF	1449	4049
5/8" - 11 NC	1452	4052
5/8" - 18 NF	1454	4054
3/4" - 10 NC	1458	4058
3/4" - 16 NF	1460	4060
2" Adj. Round		
7/8" - 9 NC	1461	4261
7/8" - 14 NF	1463	4263
1" - 8 NC	1465	4265
1" - 12 NF	1466	4266
Pipe		
		1" Solid Round
1/8" - 27 NPT	1902	3202
		1-1/2" Solid Round
1/4" - 18 NPT	1903	4103
Threading Tools		Item #
Adj. Die Stock - 1" Dies		11026
Adj. Die Stock - 1-1/2" Adj. Round Dies		12435
Adj. Die Stock - 2" Adj. Round Dies		12445
Adj. Handle Tap Wrench - Taps No. 0 to 1/2"		311088
Adj. Handle Tap Wrench - Taps 1/4" to 1"		12498
T-Handle Wrench - Taps No. 0 to 1/4"		12401
18 Leaf Standard Thread Pitch Gauge		11018

**HANSON 64-piece Machine Screw/
Fractional Tap & Adjustable/Solid
Round Die Set**



98146

Set Contents		Item # 98146
Thread Size Machine Screw	Tap Item # Plug Style	Die Item # 1" Adj. Round
4 - 40 NC	1112	3712
6 - 32 NC	1118	3718
8 - 32 NC	1124	3724
10 - 24 NC	1128	3728
10 - 32 NF	1131	3731
12 - 24 NC	1132	3732
Fractional		
1/4" - 20 nc	1420	3820
1/4" - 28 nf	1423	3823
5/16" - 18 nc	1427	3827
5/16" - 24 nf	1429	3829
3/8" - 16 nc	1434	3834
3/8" - 24 nf	1436	3836
7/16" - 14 nc	1439	3839
7/16" - 20 nf	1440	3840
1/2" - 13 nc	1444	3844
1/2" - 20 nf	1445	3845
1-1/2" Adj. Round		
9/16" - 12 NC	1448	4048
9/16" - 18 NF	1449	4049
5/8" - 11 NC	1452	4052
5/8" - 18 NF	1454	4054
3/4" - 10 NC	1458	4058
3/4" - 16 NF	1460	4060
2" Adj. Round		
7/8" - 9 NC	1461	4261
7/8" - 14 NF	1463	4263
1" - 8 NC	1465	4265
1" - 12 NF	1466	4266
Pipe		
1" Solid Round		
1/8" - 27 NPT	1902	3202
1-1/2" Solid Round		
1/4" - 18 NPT	1903	4103
Threading Tools		Item #
Adj. Die Stock - 1" Adj. Round Dies		12428
Adj. Die Stock - 1-1/2" Adj. Round Dies		12435
Adj. Die Stock - 2" Adj. Round Dies		12445
Adj. Handle Tap Wrench - Taps No. 0 to 1/2"		311088
Adj. Handle Tap Wrench - Taps 1/4" to 1"		12498
T-Handle Wrench - Taps No. 0 to 1/4"		12401
18 Leaf Standard Thread Pitch Gauge		11018

TAPS & DIES

Taps & Dies

High Carbon Steel Combination Sets

HANSON® 41-piece Fractional Tap & Adjustable/Solid Round Die Set



25941

TAPS & DIES

Set Contents		Item # 25941
Thread Size Fractional	Tap Item # Plug Style	Die Item # 1-1/2" Adj. Round
1/4" - 20 NC	1420	4020
1/4" - 28 NF	1423	4023
5/16" - 18 NC	1427	4027
5/16" - 24 NF	1429	4029
3/8" - 16 NC	1434	4034
3/8" - 24 NF	1436	4036
7/16" - 14 NC	1439	4039
7/16" - 20 NF	1440	4040
1/2" - 13 NC	1444	4044
1/2" - 20 NF	1445	4045
9/16" - 12 NC	1448	4048
9/16" - 18 NF	1449	4049
5/8" - 11 NC	1452	4052
5/8" - 18 NF	1454	4054
3/4" - 10 NC	1458	4058
3/4" - 16 NF	1460	4060
Pipe		1-1/2" Solid Round
1/8" - 27 NPT	1902	4102
1/4" - 18 NPT	1903	4103
Threading Tools		Item #
Adj. Die Stock - 1-1/2" Dies		12435
T-Handle Wrench - Taps 1/4" to 1/2"		12402
Adj. Handle Tap Wrench - Taps 1/4" to 1"		12498
18 Leaf Standard Thread Pitch Gauge		11018
Empty Plastic Case		25941MT

**HANSON 39-piece Machine Screw/
Fractional Tap & Solid Round Die Set**



23614

**HANSON 39-piece Machine Screw/
Fractional Tap & Adjustable Round Die Set**



25914

Set Contents		Item # 23614
Thread Size	Tap Item #	Die Item #
Machine Screw	Plug Style	1" Solid Round
4 - 40 NC	1112	3012
6 - 32 NC	1118	3018
8 - 32 NC	1124	3024
10 - 24 NC	1128	3028
10 - 32 NF	1131	3031
12 - 24 NC	1132	3032
Fractional		
1/4" - 20 NC	1420	3120
1/4" - 28 NF	1423	3123
5/16" - 18 NC	1427	3127
5/16" - 24 NF	1429	3129
3/8" - 16 NC	1434	3134
3/8" - 24 NF	1436	3136
7/16" - 14 NC	1439	3139
7/16" - 20 NF	1440	3140
1/2" - 13 NC	1444	3144
1/2" - 20 NF	1445	3145
Pipe		
1/8" - 27 NPT	1902	3202
Threading Tools		Item #
Adj. Die Stock - 1" Dies		11026
T-Handle Wrench - Taps No. 0 to 1/4"		12401
Adj. Handle Tap Wrench - Taps No. 0 to 1/2"		311088
18 Leaf Standard Thread Pitch Gauge		11018
Empty Plastic Case		23614MT

Set Contents		Item # 25914
Thread Size	Tap Item #	Die Item #
Machine Screw	Plug Style	1-1/2" Adj. Round
4 - 40 NC	1112	3712
6 - 32 NC	1118	3718
8 - 32 NC	1124	3724
10 - 24 NC	1128	3728
10 - 32 NF	1131	3731
12 - 24 NC	1132	3732
Fractional		
1/4" - 20 NC	1420	3820
1/4" - 28 NF	1423	3823
5/16" - 18 NC	1427	3827
5/16" - 24 NF	1429	3829
3/8" - 16 NC	1434	3834
3/8" - 24 NF	1436	3836
7/16" - 14 NC	1439	3839
7/16" - 20 NF	1440	3840
1/2" - 13 NC	1444	3844
1/2" - 20 NF	1445	3845
Pipe		
1/8" - 27 NPT	1902	3202
Threading Tools		Item #
Adj. Die Stock - 1" Adj. Round Dies		12428
T-Handle Wrench - Taps No. 0 to 1/4"		12401
Adj. Handle Tap Wrench - Taps No. 0 to 1/2"		311088
18 Leaf Standard Thread Pitch Gauge		11018
Empty Plastic Case		25914MT

TAPS & DIES

Taps & Dies

High Speed Steel Combination Sets

HANSON® 25-piece Fractional Tap & Adjustable/Solid Round Die Set

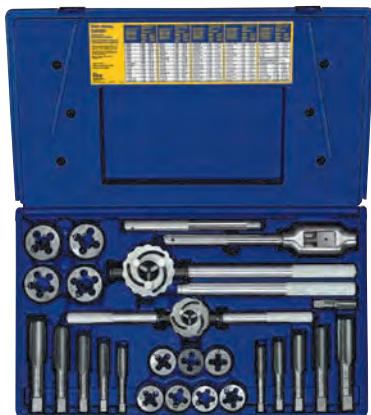

98000

Set Contents

Item # 98000

Thread Size Fractional	Tap Item # Plug Style	Die Item # 1-1/2" Adj. Round
9/16" - 12 NC	1448	4048
9/16" - 18 NF	1449	4049
5/8" - 11 NC	1452	4052
5/8" - 18 NF	1454	4054
3/4" - 10 NC	1458	4058
3/4" - 16 NF	1460	4060
		2" Adj. Round
7/8" - 9 NC	1461	4261
7/8" - 14 NF	1463	4263
1" - 8 NC	1465	4265
1" - 12 NF	1466	4266
Pipe		1-1/2" Solid Round
1/4" - 18 NPT	1903	4103
Threading Tools		Item #
Adj. Die Stock - 1-1/2" Adj. Round Dies		12435
Adj. Die Stock - 2" Adj. Round Dies		12445
Adj. Handle Tap Wrench - Taps 1/4" to 1"		12498
Empty Plastic Case		98000MT

TAPS & DIES

HANSON 24-piece Fractional Tap & Solid Round Die Set



23622

Set Contents

Item # 23622

Thread Size Fractional	Tap Item # Plug Style	Die Item # 1" Solid Round
1/4" - 20 NC	1420	3120
1/4" - 28 NF	1423	3123
5/16" - 18 NC	1427	3127
5/16" - 24 NF	1429	3129
3/8" - 16 NC	1434	3134
3/8" - 24 NF	1436	3136
7/16" - 14 NC	1439	3139
7/16" - 20 NF	1440	3140
1/2" - 13 NC	1444	3144
1/2" - 20 NF	1445	3145
Pipe		
1/8" - 27 NPT	1902	3202
Threading Tools		Item #
Plain Die Stock - 1" Dies		11008
Offset Adj. Tap Wrench - Taps No. 0 to 1/2"		12421

HANSON Cut Thread Machine Screw Taps (HSS)



400023



403025



406025

- Straight fluted, hand taps
- Taps produce a class 2B thread

HANSON Cut Thread Fractional Taps (HSS)



410022



413022



416022

- Straight fluted, hand taps
- Taps produce a class 2B thread
- Works in most materials including stainless & alloy steels

HANSON Cut Thread Pipe Taper Taps (HSS)



459002

- Cuts internal threads in pipes
- Ideal for pipe fittings
- Tapered at a rate of 3/4" per foot

Description	No. of Flutes	Plug Bulk Item #	Taper Bulk Item #	Bottom Bulk Item #
6 - 32 NC	3	403015	400015	406015
6 - 48 NS	3	403017	400017	406017
8 - 32 NC	4	403019	400019	406019
8 - 40 NS	4	403021	400021	406021
10 - 24 NC	4	403022	400022	406022
10 - 32 NF	4	403023	400023	406023
12 - 24 NC	4	403025	400025	-
14 - 20 NS	4	403028	-	-

Description	No. of Flutes	Plug Bulk Item #	Taper Bulk Item #	Bottom Bulk Item #
1/4" - 20 NC	4	413010	410010	416010
1/4" - 28 NF	4	413012	-	416012
5/16" - 18 NC	4	413015	410015	416015
5/16" - 24 NF	4	413016	-	416016
3/8" - 16 NC	4	413018	410018	416018
3/8" - 24 NF	4	413019	410019	-
7/16" - 14 NC	4	413020	410020	416020
7/16" - 20 NF	4	413021	410021	-
1/2" - 13 NC	4	413022	410022	416022
1/2" - 20 NF	4	413023	410023	-
9/16" - 12 NC	4	413024	-	-
5/8" - 11 NC	4	413026	410026	-
3/4" - 10 NC	4	-	410028	-

Description	No. of Flutes	Taper Item #
1/8" - 27 NPT	4	459001
1/4" - 18 NPT	4	459002
3/8" - 18 NPT	4	459003
1/2" - 14 NPT	4	459004
3/4" - 14 NPT	5	459005
1" - 11-1/2 NPT	5	459006
1-1/4" - 11-1/2 NPT	5	459007
1-1/2" - 11-1/2 NPT	6	459008

Taps & Dies

High Speed Steel Taps

HANSON 6-piece Cut Thread Pipe Taper Tap Set (HSS)



1924

Contents	Item # 1924
1/8" - 27 NPT	459001
1/4" - 18 NPT	459002
3/8" - 18 NPT	459003
1/2" - 14 NPT	459004
3/4" - 14 NPT	459005
1" - 11-1/2 NPT	459006

Tips

- Always use cutting fluid
- When threading a blind hole, clean the chips from the hole often and do not bottom out the tap - it can cause tap breakage.

HANSON Ground Thread Fractional Taps (HSS)



310310



313310



316310

- Ground thread taps produce a tighter thread tolerance than cut thread taps
- Designed to .0005" pitch diameter tolerance
- Straight fluted, hand taps

TAPS & DIES

Description	No. of Flutes	Pitch Diameter Limits	Plug Bulk Item #	Taper Bulk Item #	Bottom Bulk Item #
1/4" - 20 NC	4	H3	313310	310310	316310
1/4" - 28 NF	4	H3	313312	310312	316312
5/16" - 18 NC	4	H3	313315	310315	316315
5/16" - 24 NF	4	H3	313316	310316	316316
3/8" - 16 NC	4	H3	313318	310318	316318
3/8" - 24 NF	4	H3	313319	310319	316319
7/16" - 14 NC	4	H3	313320	310320	316320
1/2" - 13 NC	4	H3	313322	310322	316322
1/2" - 20 NF	4	H3	313325	310323	316323
9/16" - 18 NF	4	H3	313326	-	-
5/8" - 11 NC	4	H3	313327	310327	316327
5/8" - 18 NF	4	H3	313328	310328	316328
3/4" - 10 NC	4	H3	313331	310331	316331
3/4" - 16 NF	4	H3	313332	310332	316332
7/8" - 9 NC	4	H4	313433	310433	316433
7/8" - 14 NF	4	H4	313434	310434	316434
1" - 8 NC	4	H4	313435	310435	316435
1" - 12 NF	4	H4	313436	-	-
1" - 14 NS	4	H4	313437	-	-
1-1/8" - 7 NC	4	H4	313438	310438	316438
1-1/8" - 12 NF	4	H4	313439	310439	316439
1-1/4" - 7 NC	4	H4	313440	310440	316440
1-1/4" - 12 NF	6	H4	313441	310441	316441
1-3/8" - 6 NC	4	H4	-	310442	-
1-3/8" - 12 NF	6	H4	-	310443	-
1-1/2" - 6 NC	4	H4	-	310444	316444
1-1/2" - 12 NF	6	H4	313445	-	-

HANSON Ground Thread Machine Screw Taps (HSS)



300325

- Ideal for maintenance and repair work
- Ground thread taps produce a tighter thread tolerance than cut thread taps
- Designed to .0005" pitch diameter tolerance
- Straight fluted, hand taps

Description	No. of Flutes	Pitch Diameter Limits	Plug Bulk Item #	Taper Bulk Item #	Bottom Bulk Item #
0 - 80 NF	2	H1	303101	-	-
1 - 64 NC	2	H1	303102	-	-
1 - 72 NC	2	H1	303103	-	-
2 - 56 NC	3	H2	303205	-	306205
6 - 32 NC	3	H3	-	300315	-
8 - 32 NC	4	H3	303319	300319	-
10 - 24 NC	4	H3	303322	300322	-
10 - 32 NF	4	H3	303323	300323	-
12 - 24 NC	4	H3	-	300325	-
12 - 28 NF	4	H3	-	300326	-

HANSON Ground Thread Left-hand Fractional Plug Taps (HSS)



2120

- Left-hand taps cut threads with a left-hand rotation
- Used in applications where left-hand studs or fasteners are required

HANSON Ground Thread Pipe Taper Taps (HSS)



359003

- Ideal for pipe fittings
- Tapered at a rate of 3/4" per foot

HANSON Ground Thread Spiral Point* (Gun Taps) Chip Driver Machine Screw/Fractional Taps (HSS)



323325

- Engineered specifically for tapping of "through" holes
- Designed to .0005-inches pitch tolerance
- Cuts with a shearing action that shoots the chips ahead of the tap, producing a cleaner thread
- Recommended for production use in machine tools

Description	No. of Flutes	Pitch Diameter Limits	Bulk Item #
1/4" - 20 NC	4	H3	2120
1/4" - 28 NF	4	H3	2123
5/16" - 18 NC	4	H3	2127
5/16" - 24 NF	4	H3	2129
3/8" - 16 NC	4	H3	2134
3/8" - 24 NF	4	H3	2136
7/16" - 14 NC	4	H3	2139
7/16" - 20 NF	4	H3	2140
1/2" - 13 NC	4	H3	2144
1/2" - 20 NF	4	H3	2145
9/16" - 12 NC	4	H3	2148
9/16" - 18 NF	4	H3	2149
5/8" - 11 NC	4	H3	2152
5/8" - 18 NF	4	H3	2154
3/4" - 10 NC	4	H3	2158
3/4" - 16 NF	4	H3	2160

Description	No. of Flutes	Bulk Item #
1/16" - 27 NPT	4	359010
1/8" - 27 NPT	4	359001
1/4" - 18 NPT	4	359002
3/8" - 18 NPT	4	359003
1/2" - 14 NPT	4	359004
3/4" - 14 NPT	5	359005

Description	No. of Flutes	Pitch Diameter Limits	Taper Bulk Item #
Machine			
6 - 32 NC	2	H3	323315
8 - 32 NC	2	H3	323319
10 - 24 NC	2	H3	323322
10 - 32 NF	2	H3	323323
12 - 24 NC	2	H3	323325
14 - 20 NS	2	H3	323328
Fractional			
1/4 - 20 NC	3	H3	333310
1/4" - 28 NF	2	H3	333312
5/16" - 18 NC	2	H3	333315
3/8" - 16 NC	3	H3	333318
7/16" - 14 NC	3	H3	333320
7/16" - 20 NF	3	H3	333321
1/2" - 13 NC	3	H3	333322
1/2" - 20 NF	3	H3	333323

*Spiral Point taps should only be used on "through" hole applications

HANSON Adjustable Round Machine Screw & Fractional Dies (HSS)



502024



504053

- HSS ideal for machine cutting where critical dimensions are required
- Adjustable round dies for precision threading

TAPS & DIES

Description	1" Overall Diam. Bulk Item #	2" Overall Diam. Bulk Item #
Machine		
4 - 40 NC	502009	-
6 - 32 NC	502014	-
6 - 40 NF	502015	-
8 - 32 NC	502018	-
8 - 36 NF	502019	-
10 - 24 NC	502021	-
10 - 32 NF	502022	-
12 - 24 NC	502024	-
12 - 28 NF	502025	-
Fractional		
1/4" - 20 NC	502038	-
1/4" - 28 NF	502039	-
5/16" - 18 NC	502041	-
5/16" - 24 NF	502042	-
3/8" - 16 NC	502044	-
3/8" - 24 NF	502045	-
7/16" - 14 NC	502046	-
7/16" - 20 NF	502047	-
1/2" - 13 NC	502048	-
1/2" - 20 NF	502049	-
5/8" - 11 NC	-	504053
5/8" - 18 NF	-	504054
3/4" - 10 NC	-	504057
3/4" - 16 NF	-	504058
7/8" - 9 NC	-	504059
7/8" - 14 NF	-	504060
1" - 8 NC	-	504061
1" - 12 NF	-	504062
1" - 14 NS	-	504063

HANSON 41-piece HSS Cut Thread Fractional Tap & Adjustable Die Set



543715

Set Contents		Stock # 543715
Thread Size	Tap Stock #	Die Stock #
Fractional	Plug Style	1-1/2" Adj. Round
1/4" - 20 NC	413010	503038
1/4" - 28 NF	413012	503039
5/16" - 18 NC	413015	503041
5/16" - 24 NF	413016	503042
3/8" - 16 NC	413018	503044
3/8" - 24 NF	413019	503045
7/16" - 14 NC	413020	503046
7/16" - 20 NF	413021	503047
1/2" - 13 NC	413022	503048
1/2" - 20 NF	413023	503049
9/16" - 12 NC	413024	503051
9/16" - 18 NF	413025	503052
5/8" - 11 NC	413026	503053
5/8" - 18 NF	413027	503054
3/4" - 10 NC	413028	503057
3/4" - 16 NF	413029	503058
1/8" - 27 NPT	459001	503102
1/4" - 18 NPT	459002	503101
Threading Tools		Stock #
Adj. Die Stock - 1-1/2" Round Dies		12435
T-Handle Wrench - Taps No. 1/4" to 1/2"		12402
Adj. Handle Tap Wrench - Taps 1/4" to 1"		12498
18 Leaf Standard Thread Pitch Gauge		11018

HANSON 39-piece HSS Cut Thread Machine Screw/Fractional Tap & Adjustable Round Die Set



541614

Set Contents		Stock # 541614
Thread Size	Tap Stock #	Die Stock #
Machine Screw	Plug Style	1" Adj. Round
4 - 40 NC	403009	502009
6 - 32 NC	403015	502014
8 - 32 NC	403019	502018
10 - 24 NC	403022	502021
10 - 32 NF	403023	502022
12 - 24 NC	403025	502024
Fractional		
1/4" - 20 NC	413010	502038
1/4" - 28 NF	413012	502039
5/16" - 18 NC	413015	502041
5/16" - 24 NF	413016	502042
3/8" - 16 NC	413018	502044
3/8" - 24 NF	413019	502045
7/16" - 14 NC	413020	502046
7/16" - 20 NF	413021	502047
1/2" - 13 NC	413022	502048
1/2" - 20 NF	413023	502049
Pipe		
1/8" - 27 NPT	459001	502101
Threading Tools		Stock #
Adjustable Die Stock - 1" Adj. Round Dies		12428
T-Handle Wrench - Taps No. 0 to 1/4"		12401
Adj. Handle Tap Wrench - Taps No. 0 to 1/2"		311088
18 Leaf Standard Thread Pitch Gauge		11018

Deep Well ThreadChaser

The IRWIN® HANSON® Deep Well ThreadChaser allows you to reach and repair threads that your current tools can't touch. Whether you're repairing wheel studs, bolts, or other fasteners, the Deep Well ThreadChaser will fix your threads quickly and correctly.

DEEP WELL THREAD CHASER FEATURES

1. Reduced profile head enables use in confined spaces
2. Rethread design repairs & cleans bent, dented, rusted, painted, or damaged threads
3. Deep well design fits over exposed studs and repairs the full length
4. Tougher than tool steel, high carbon steel ensures longer life and greater durability

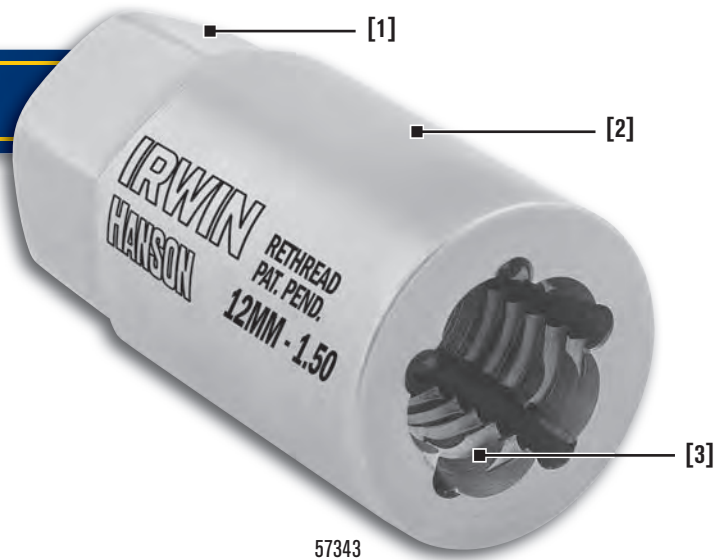

TAPS & DIES



3094102



3094104

Description	Pack Qty	Item #
3/8" - 16 NC ThreadChaser	4	57234
3/8" - 24 NF ThreadChaser	4	57236
7/16" - 14 NC ThreadChaser	4	57239
7/16" - 20 NF ThreadChaser	4	57240
1/2" - 13 NC ThreadChaser	4	57244
1/2" - 20 NF ThreadChaser	4	57245
9/16" - 12 NC ThreadChaser	4	57248
9/16" - 18 NF ThreadChaser	4	57249
5/8" - 11 NC ThreadChaser	4	57252
5/8" - 18 NF ThreadChaser	4	57254
12 mm - 1.25 ThreadChaser	4	57342
12 mm - 1.50 ThreadChaser	4	57343
14 mm - 1.50 ThreadChaser	4	57349
16 mm - 1.50 ThreadChaser	4	57355
ThreadChaser 5pc SAE Coarse Set	1	3094100
ThreadChaser 5pc SAE Fine Set	1	3094101
ThreadChaser 10pc SAE Complete Set	1	3094102
ThreadChaser 4pc Metric Set	1	3094104

HANSON® Hexagon Re-threading Pipe Taper Dies (HCS)



7403

- Ideal for repairing damaged threads on plumbing and air pipe applications

HANSON Re-threading Hexagon Metric Right & Left-hand Dies (HCS)



7349

- Ideal for repairing damaged bolts and studs where metric threads are specified

HANSON Re-threading Hexagon Fractional Right & Left-hand Dies (HCS)



7220



7720

- Designed for repairing damaged bolts and studs

Description	Width Across Hex Flats	Thickness of Hex Die	Bulk Item #
1/8" - 27 NPT	1-1/16"	3/8"	7402
1/4" - 18 NPT	1-1/4"	5/8"	7403
3/8" - 18 NPT	1-7/16"	5/8"	7404
1/2" - 14 NPT	1-5/8"	3/4"	7405
3/4" - 14 NPT	2"	3/16"	7406
1" - 11-1/2 NPT	2-3/8"	1"	7407

Description	Width Across Hex Flats	Thickness of Hex Die	Right-Hand Bulk Item #	Left-Hand Bulk Item #
14 mm - 1.25	1-1/16"	1/2"	7349	-
14 mm - 1.50	1-1/16"	1/2"	7350	-
14 mm - 2.00	1-1/16"	1/2"	7352	-
16 mm - 1.50	1-1/4"	5/8"	7355	7855
16 mm - 2.00	1-1/4"	5/8"	7356	-
18 mm - 1.00	1-7/16"	3/4"	7358	-
18 mm - 1.50	1-7/16"	3/4"	7359	7859
18 mm - 2.50	1-7/16"	3/4"	7361	-
20 mm - 2.50	1-7/16"	3/4"	7364	-
22 mm - 1.50	1-5/8"	7/8"	7365	7865
24 mm - 1.50	1-13/16"	1"	7367	-
30 mm - 1.50	2"	1"	7373	-

Description	Width Across Hex Flats	Thickness of Hex Die	Right-Hand Bulk Item #	Left-Hand Bulk Item #
1/4" - 20 NC	19/32"	1/4"	7220	7720
1/4" - 28 NF	19/32"	1/4"	7223	7723
5/16" - 18 NC	11/16"	5/16"	7227	7727
5/16" - 24 NF	11/16"	5/16"	7229	7729
3/8" - 16 NC	25/32"	3/8"	7234	7734
3/8" - 24 NF	25/32"	3/8"	7236	7736
7/16" - 14 NC	7/8"	7/16"	7239	7739
7/16" - 20 NF	7/8"	7/16"	7240	7740
1/2" - 13 NC	1-1/16"	1/2"	7244	7744
1/2" - 20 NF	1-1/16"	1/2"	7245	7745
9/16" - 12 NC	1-1/16"	1/2"	7248	7748
9/16" - 18 NF	1-1/16"	1/2"	7249	7749
5/8" - 11 NC	1-1/4"	5/8"	7252	7752
5/8" - 18 NF	1-1/4"	5/8"	7254	7754
11/16" - 11 NS	1-7/16"	3/4"	7256	7756
11/16" - 16 NS	1-7/16"	3/4"	7257	7757
3/4" - 10 NC	1-7/16"	3/4"	7258	7758
3/4" - 16 NF	1-7/16"	3/4"	7260	7760
7/8" - 9 NC	1-5/8"	7/8"	7261	7761
7/8" - 14 NF	1-5/8"	7/8"	7263	7763
1" - 8 NC	1-13/16"	1"	7265	7765
1" - 12 NF	1-13/16"	1"	7266	7766
1" - 14 NS	1-13/16"	1"	7267	7767
1-1/8" - 7 NC	2"	1"	7268	-
1-1/8" - 12 NF	2"	1"	7269	-
1-1/4" - 7 NC	2-3/16"	1"	7270	-
1-1/4" - 12 NF	2-3/16"	1"	7271	-
1-3/8" - 6 NC	2-3/8"	1"	7272	-
1-3/8" - 12 NF	2-3/8"	1"	7273	-
1-1/2" - 6 NC	2-9/16"	1"	7274	-
1-1/2" - 12 NF	2-9/16"	1"	7275	-

HANSON 10-piece Hexagon Re-threading Fractional NC Die Set (HCS)



25701

Set Contents	Item # 25701
Die Size	
1/4" - 20 NC	7220
5/16" - 18 NC	7227
3/8" - 16 NC	7234
7/16" - 14 NC	7239
1/2" - 13 NC	7244
9/16" - 12 NC	7248
5/8" - 11 NC	7252
3/4" - 10 NC	7258
7/8" - 9 NC	7261
1" - 8 NC	7265

HANSON 10-piece Hexagon Re-threading Fractional NF Die Set (HCS)



24801

Set Contents	Item # 24801
Die Size	
1/4" - 28 NF	7223
5/16" - 24 NF	7229
3/8" - 24 NF	7236
7/16" - 20 NF	7240
1/2" - 20 NF	7245
9/16" - 18 NF	7249
5/8" - 18 NF	7252
3/4" - 16 NF	7260
7/8" - 14 NF	7263
1" - 12 NF	7266

HANSON 6-piece Hexagon Re-threading Fractional Pipe Taper Die Set (HCS)

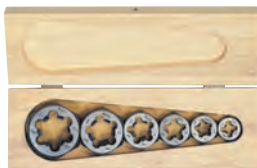

1922

Set Contents	Item # 1922
Die Size	
1/8" - 27 NPT	7402
1/4" - 18 NPT	7403
3/8" - 18 NPT	7404
1/2" - 14 NPT	7405
3/4" - 14 NPT	7406
1" - 11-1/2 NPT	7407

HANSON 16-piece Hexagon Re-threading Fractional Die Set (HCS)



24839

Set Contents		Item # 24839
Die Size		
1/4" - 20 NC		7220
1/4" - 28 NF		7223
5/16" - 18 NC		7227
5/16" - 24 NF		7229
3/8" - 16 NC		7234
3/8" - 24 NF		7236
7/16" - 14 NC		7239
7/16" - 20 NF		7240
1/2" - 13 NC		7244
1/2" - 20 NF		7245
9/16" - 12 NC		7248
9/16" - 18 NF		7249
5/8" - 11 NC		7252
5/8" - 18 NF		7254
3/4" - 10 NC		7258
3/4" - 16 NF		7260

HANSON 12-piece Tap & Re-threading Hexagonal Pipe Die Sets (HCS) & (HSS)



1920

Set Contents		Item # 1920
Thread Size Pipe	Tap Item #	Hex Die Item #
1/8" - 27 NPT	1902	7402
1/4" - 18 NPT	1903	7403
3/8" - 18 NPT	1904	7404
1/2" - 14 NPT	1905	7405
3/4" - 14 NPT	1906	7406
1" - 11-1/2 NPT	1907	7407
Empty Wooden Case		1920MT

Set Contents		Item # 1923
Thread Size Pipe	Tap Item #	Hex Die Item #
1/8" - 27 NPT	459001	7402
1/4" - 18 NPT	459002	7403
3/8" - 18 NPT	459003	7404
1/2" - 14 NPT	459004	7405
3/4" - 14 NPT	459005	7406
1" - 11-1/2 NPT	459006	7407

TAPS & DIES