



STANLEY

**PROTO**

# SCREWDRIVERS AND HEX KEYS 9

SCREWDRIVERS

NUT DRIVERS

HEX KEYS

BIT HOLDERS AND BITS





# SCREWDRIVERS AND HEX KEYS

# 9

Proto's broad line of professional screwdrivers offers a variety of shapes, sizes, and tips configurations to handle almost any screw turning operation. Screwdrivers are available in Slotted, Cabinet, Torx®, and Phillips® tip configurations. Both round and square shanks are offered. A selection of sets and screwdrivers accessories are also available.

## PROTO SCREWDRIVERS

All screwdrivers have an alloy steel shank, heat-treated the entire length to provide strength against twisting action. Tips are precision machined to ensure proper fit. Tip edges are ground to a precise width and thickness to properly fit the screw slot. Standard and cabinet tips are cross ground for consistent fit.

**Super Proto Screwdrivers** have a innovative tri-lobed, non-slip handle made from bi-material that ensures a secure grip.

**Proto Insulated Screwdrivers** are tested to 10,000 Volts, rated to 1000V AC / 1500V DC. Molded handles are wear resistant, in safety orange for quick identification.

## PROTO NUT DRIVERS

Proto nut drivers are available in standard and hollow shaft designs. The hex opening is precision formed for proper fastener fit. Chrome plated shanks provide corrosion protection. Shanks are heat-treated for strength and durability.

## HEX KEYS

Available in Proto T-Handle, "L" Handle and Folding styles with hex, ball and Torx® tips. Proto hex keys are precision formed ensuring a secure fastener fit. All shafts are heat treated for durability and receive a rust resistant black oxide finish.

## SAFETY

- Use safety goggles. Serious eye injury is possible.
- Do not pry, punch, chisel, scrapes or otherwise misuse.
- Fit screwdriver tip width and thickness to fastener slot size.
- Only use Proto insulated 1000V screwdriver on electrical circuits. Always turn power off. Standard screwdrivers have no insulation.
- Prevent slipping. Keep tools clean.

TORX® is a registered trademark of Texton.  
PHILLIPS® is a registered trademark of Phillips Screw Co.









**SET NO. 88819**  
**19 PC. COMBINATION**  
**SUPER PROTO SCREWDRIVER SET**

• Square and round shanks.

Product ID No.	Contents	Description	L1
88819	88203	Cabinet Tip	3"
	88204	Cabinet Tip	4"
	88208	Cabinet Tip	8"
	88214	Cabinet Tip	4"
	88218	Cabinet Tip	8"
	88002	Stubby Std. Tip	1-1/2"
	88322	Stubby Phillips® No. 2	1-1/2"
	88393	Phillips® No. 0	2-1/2"
	88313	Phillips® No. 1	3"
	88318	Phillips® No. 1	8"
	88324	Phillips® No. 2	4"
	88328	Phillips® No. 2	8"
	88336	Phillips® No. 3	6"
	88348	Phillips® No. 4	8"
	88102	Standard Tip	4"
	88106	Standard Tip	6"
	88108	Standard Tip	8"
	88112	Standard Tip	12"
	88104	Standard Tip	4"



**SET NO. 88808**  
**8 PC. COMBINATION**  
**SUPER PROTO SCREWDRIVER SET**

• Round shanks.

Product ID No.	Contents	Description	L1
88808	88004	Standard Tip	4"
	88006	Standard Tip	6"
	88213	Cabinet Tip	3"
	88214	Cabinet Tip	4"
	88215	Cabinet Tip	5"
	88313	Phillips® No. 1	3"
	88324	Phillips® No. 2	4"
	88336	Phillips® No. 3	6"



**SET NO. 88816**  
**6 PC. STANDARD**  
**SUPER PROTO SCREWDRIVER SET**

• Square shanks.

Product ID No.	Contents	Description	L1
88816	88002	Stubby Std. Tip	1-1/2"
	88104	Standard Tip	4"
	88102	Standard Tip	4"
	88106	Standard Tip	6"
	88108	Standard Tip	8"
	88112	Standard Tip	12"

**REFERENCE MEASUREMENT KEY**

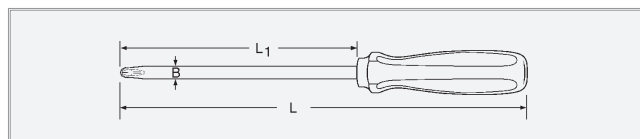

PHILLIPS® is a registered trademark of Phillips Screw Co.





**SET NO. 88836  
6 PC. PHILLIPS<sup>®</sup> SUPER PROTO SCREWDRIVER SET**

Product ID No.	Contents	Description	L1
88836	88322	Stubby Phillips <sup>®</sup> No. 2	1-1/2"
	88393	Phillips <sup>®</sup> No. 0	2-1/2"
	88313	Phillips <sup>®</sup> No. 1	3"
	88324	Phillips <sup>®</sup> No. 2	4"
	88336	Phillips <sup>®</sup> No. 3	6"
	88348	Phillips <sup>®</sup> No. 4	8"



**SET NO. 88814  
4 PC. STANDARD SUPER PROTO SCREWDRIVER SET**

• Square shanks.

Product ID No.	Contents	Description	L1
88814	88103	Standard Tip	3"
	88104	Standard Tip	4"
	88106	Standard Tip	6"
	88108	Standard Tip	8"



**SET NO. 88806  
6 PC. STANDARD SUPER PROTO SCREWDRIVER SET**

• Round shanks.

Product ID No.	Contents	Description	L1
88806	88002	Stubby Std. Tip	1-1/2"
	88004	Standard Tip	4"
	88006	Standard Tip	6"
	88008	Standard Tip	8"
	88010	Standard Tip	10"
	88214	Cabinet Tip	4"



**SET NO. 88837B  
6 PC. PROTOBLACK<sup>™</sup> PHILLIPS<sup>®</sup> SUPER PROTO SCREWDRIVER SET**

• Black oxide finish.

Product ID No.	Contents	Description	L1
88837B	88322B	Stubby Phillips <sup>®</sup> No. 2	1-1/2"
	88393B	Phillips <sup>®</sup> No. 0	2-1/2"
	88313B	Phillips <sup>®</sup> No. 1	3"
	88324B	Phillips <sup>®</sup> No. 2	4"
	88336B	Phillips <sup>®</sup> No. 3	6"
	88348B	Phillips <sup>®</sup> No. 4	8"

PHILLIPS<sup>®</sup> is a registered trademark of Phillips Screw Co.

**REFERENCE MEASUREMENT KEY**

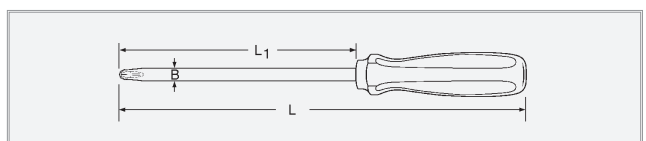



**SET NO. 88818B**  
**8 PC. PROTOBLACK™**  
**COMBINATION SUPER PROTO SCREWDRIVER SET**

- Black oxide finish.
- Round shanks.

Product ID No.	Contents	Description	L1
88818B	88004B	Standard Tip	4"
	88006B	Standard Tip	6"
	88203B	Cabinet Tip	3"
	88213B	Cabinet Tip	3"
	88216B	Cabinet Tip	6"
	88313B	Phillips® No. 1	3"
	88324B	Phillips® No. 2	4"
	88336B	Phillips® No. 3	6"



**SET NO. 88857**  
**7 PC. TORX® SUPER PROTO SCREWDRIVER SET**

Product ID No.	Contents		L1
88857	88510	T10	3-1/8"
	88515	T15	1-1/4"
	88520	T20	3-1/4"
	88525	T25	3-1/4"
	88527	T27	4"
	88530	T30	4"
	88540	T40	6"

PHILLIPS® is a registered trademark of Phillips Screw Co.  
TORX® is a registered trademark of Textron.



**SUPER PROTO STANDARD TIP—ROUND SHANK**

Product ID No.		B	L1	L	Weight lbs.
88004	1/4"	1/4"	4"	8-1/4"	.120
88006	5/16"	5/16"	6"	10-5/16"	.196
88008	3/8"	3/8"	8"	12-3/4"	.270
88010	3/8"	3/8"	10"	14-3/4"	.305



**SUPER PROTO STANDARD TIP—SQUARE SHANK**

- Square shank to permit use of a wrench for added leverage.

Product ID No.		B	L1	L	Weight lbs.
88102	1/4"	1/4"	4"	8-1/4"	.131
88103	1/4"	1/4"	3"	7-3/16"	.123
88104	3/16"	3/16"	4"	8"	.172
88106	5/16"	5/16"	6"	10-5/16"	.220
88108	3/8"	3/8"	8"	12-5/16"	.317
88110	3/8"	3/8"	10"	14-3/4"	.362
88112	3/8"	3/8"	11-3/4"	16-3/4"	.406



**SUPER PROTO CABINET TIP—ROUND SHANK**

- Black oxide finish.

Product ID No.		B	L1	L	Weight lbs.
88203	1/8"	1/8"	3"	6-3/8"	.018
88204	1/8"	1/8"	4"	7-1/4"	.020
88206	1/8"	1/8"	6"	9-1/4"	.023
88208	1/8"	1/8"	8"	11-1/4"	.026
88213	3/16"	3/16"	3"	7-7/8"	.072
88214	3/16"	3/16"	4"	8"	.075
88215	3/16"	3/16"	5"	8-7/8"	.079
88216	3/16"	3/16"	6"	9-3/4"	.082
88218	3/16"	3/16"	8"	11-3/4"	.089

**REFERENCE MEASUREMENT KEY**

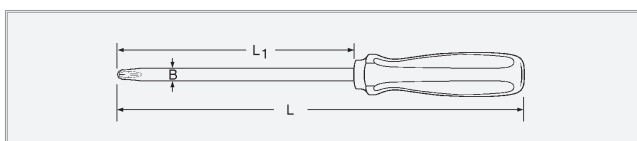



**SUPER PROTO  
CABINET TIP PROTOBLACK™—ROUND SHANK**

• Black oxide finish.

Product ID No.		B	L1	L	Weight lbs.
88203B	1/8"	1/8"	3"	6-3/8"	.018
88213B	3/16"	3/16"	3"	7-7/8"	.072
88216B	3/16"	3/16"	6"	9-3/4"	.082



**SUPER PROTO  
PHILLIPS® TIP PROTOBLACK™—ROUND SHANK**

• Black oxide finish..

Product ID No.		B	L1 (mm)	L (mm)	Weight lbs.
88393B	0	3mm	75	160	.018
88313B	1	3/16"	75	175	.073
88324B	2	1/4"	100	212	.120
88336B	3	5/16"	150	275	.196
88348B	4	3/8"	200	325	.270



**SUPER PROTO PHILLIPS® TIP—ROUND SHANK**

Product ID No.		B	L1	L	Weight lbs.
88393	0	3mm	3"	6-3/8"	.018
88313	1	3/16"	3"	6-7/8"	.073
88318	1	3/16"	8"	11-3/4"	.094
88324	2	1/4"	4"	8-1/4"	.120
88328	2	1/4"	8"	12-1/2"	.150
88336	3	5/16"	6"	10-5/16"	.196
88348	4	3/8"	8"	12-5/16"	.270



**SUPER PROTO  
PHILLIPS® TIP—STUBBY ROUND SHANK**

Product ID No.		B	L1	L	Weight lbs.
88322	2	1/4"	1-9/16"	3-3/4"	.056



**SUPER PROTO  
STANDARD TIP—STUBBY SQUARE SHANK**

Product ID No.		B	L1	L	Weight lbs.
88002	1/4"	1/4"	1-9/16"	3-3/4"	.058



**SUPER PROTO  
STANDARD TIP PROTOBLACK™—ROUND SHANK**

• Black oxide finish.

Product ID No.		B	L1	L	Weight lbs.
88004B	1/4"	1/4"	4"	4"	.120
88006B	5/16"	5/16"	6"	10-5/16"	.196

PHILLIPS® is a registered trademark of Phillips Screw Co

**REFERENCE MEASUREMENT KEY**

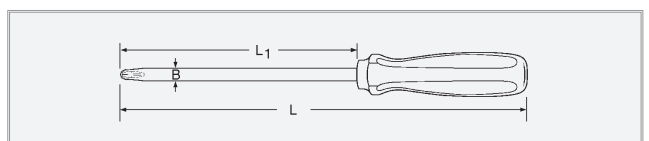



## SET NO. 9511 11 PC. INSULATED TOOL SET

- Tested to 10,000 Volts, Rated to 1000V AC/1500V DC.
- Convenient zipper case for storage and transport.

Product ID No.	Contents	Description	L
9511	9501	Phillips® No. 1 Screwdriver	6-3/4"
	9502	Phillips® No. 2 Screwdriver	8"
	9503	Phillips® No. 3 Screwdriver	10-1/4"
	9514	Standard Tip Screwdriver	4"
	9515	Standard Tip Screwdriver	5"
	9516	Standard Tip Screwdriver	6"
	9517	Standard Tip Screwdriver	7"
	181	Linesman Plier	8"
	184	Diagonal Plier	6-19/64"
	186	Needle Nose Pliers	6-3/4"
	187	Needle Nose Pliers	8"
	9511SC	Zipper Case	



## SET NO. 9507 7 PC. INSULATED TOOL SET

- Tested to 10,000 Volts, Rated to 1000V AC/1500V DC.
- Weight: 1.75 lbs.

Product ID No.	Contents	Description	L
9507	9501	Phillips® No. 1 Screwdriver	3-1/8"
	9502	Phillips® No. 2 Screwdriver	4"
	9503	Phillips® No. 3 Screwdriver	6"
	9514	Standard Tip Screwdriver	4"
	9515	Standard Tip Screwdriver	5"
	9516	Standard Tip Screwdriver	6"
	9518	Standard Tip Screwdriver	7"
	9507P	Pouch	

PHILLIPS® is a registered trademark of Phillips Screw Co



## INSULATED SCREWDRIVERS—STANDARD TIP

- Individually tested to 10,000 Volts.
- Rated to 1000V AC/1500V DC.
- Wear resistant molded handle and shank.
- Comfortable handle design.
- Black oxide tips.
- Meet ASTM F1505-94, IEC 900/EN 60900, VDE 0680/201.
- Safety orange for quick identification.

Product ID No.	Description		B	L1	L	Weight lbs.	
9513	Standard Tip Screwdriver		3/32"	3/32"	3"	5-3/4"	.04
9514	Standard Tip Screwdriver		5/32"	5/32"	4"	7-1/2"	.10
9515	Standard Tip Screwdriver		7/32"	7/32"	5"	9"	.18
9516	Standard Tip Screwdriver		1/4"	1/4"	6"	10"	.22
9517	Standard Tip Screwdriver		5/16"	5/16"	7"	11-1/4"	.34



## INSULATED SCREWDRIVERS®—PHILLIPS TIP

- Individually tested to 10,000 Volts.
- Rated to 1000V AC/1500V DC.
- Wear resistant molded handle and shank.
- Comfortable handle design.
- Black oxide tips.
- Meet ASTM F1505-94, IEC 900/EN 60900, VDE 0680/201.
- Safety orange for quick identification.

Product ID No.	Description		B	L1	L	Weight lbs.	
9501	Phillips® No. 1 Screwdriver		1	11/64"	3-1/8"	6-3/4"	.10
9502	Phillips® No. 2 Screwdriver		2	15/64"	4"	8"	.18
9503	Phillips® No. 3 Screwdriver		3	5/16"	6"	10-1/4"	.31

## REFERENCE MEASUREMENT KEY

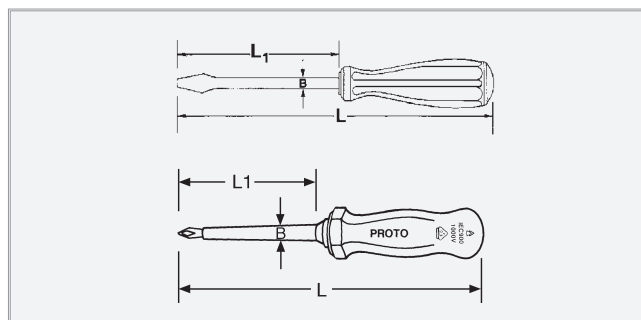





### SET NO. 61929 28 PC. MAGNETIC SCREWDRIVER BIT SET

- Packaged in plastic blow molded box for easy storage.
- Weight: 1.07 lbs.

Product ID No.	Contents	Description	Length
61929	—	#0 Phillips <sup>®</sup>	1"
	60002	#1 Phillips <sup>®</sup>	1"
	60008	#2 Phillips <sup>®</sup>	1"
	60020	#3 Phillips <sup>®</sup>	1"
	60200	3F-4R Slotted	1"
	60202	4F-5R Slotted	1"
	60204	6F-8R Slotted	1"
	60206	8F-10R Slotted	1"
	60208	10F-12R Slotted	1"
	60508	T10 Torx <sup>®</sup>	1"
	60510	T15 Torx <sup>®</sup>	1"
	60512	T20 Torx <sup>®</sup>	1"
	60514	T25 Torx <sup>®</sup>	1"
	60518	T30 Torx <sup>®</sup>	1"
	60520	T40 Torx <sup>®</sup>	1"
	61000	#0 Square	1"
	61002	#1 Square	1"
	61004	#2 Square	1"
	61006	#3 Square	1"
	60802	5/64" Socket Head	1"
	60804	3/32" Socket Head	1"
	60808	1/8" Socket Head	1"
	60812	5/32" Socket Head	1"
	60814	3/16" Socket Head	1"
	61085	1/8" Clutch	1"
	61087	5/32" Clutch	1"
	61239	Magnetic Bit Holder	2-1/4"
	9300MS	Magnetic Screwdriver	7-9/16"



### SET NO. 61906 38 PC. INSERT/POWER BIT SET

- Magnetic base provides tool organization as well as portability.
- Strong magnetic bond allows for superior holding strength.
- Allows bits to remain organized in a tool box drawer as well as on any metal surface.
- Weight: 1.21 lbs.

Product ID No.	Contents	Description	Length
61906	—	#0 Phillips <sup>®</sup>	1"
	60002	#1 Phillips <sup>®</sup>	1"
	60008	#2 Phillips <sup>®</sup>	1"
	60020	#3 Phillips <sup>®</sup>	1"
	60026	#2 Phillips <sup>®</sup> Reduced Diameter	1"
	60202	4F-5R Slotted	1"
	60204	6F-5R Slotted	1"
	60206	8F-10R Slotted	1"
	60208	10F-12R Slotted	1"
	60218	12F-14R Slotted	1-1/2"
	60220	14F-16R Slotted	1-1/2"
	60500	T6 Torx <sup>®</sup>	1"
	60502	T7 Torx <sup>®</sup>	1"
	60504	T8 Torx <sup>®</sup>	1"
	60506	T9 Torx <sup>®</sup>	1"
	60508	T10 Torx <sup>®</sup>	1"
	60510	T15 Torx <sup>®</sup>	1"
	60512	T20 Torx <sup>®</sup>	1"
	60514	T25 Torx <sup>®</sup>	1"
	60518	T30 Torx <sup>®</sup>	1"
	60520	T40 Torx <sup>®</sup>	1"
	60700	#1 Pozidriv <sup>®</sup>	1"
	60702	#2 Pozidriv <sup>®</sup>	1"
	60804	3/32" Socket Head	1-1/4"
	60806	7/64" Socket Head	1-1/4"
	60808	1/8" Socket Head	1-1/4"
	60810	9/64" Socket Head	1-1/4"
	60812	5/32" Socket Head	1-1/4"
	60814	3/16" Socket Head	1-1/4"
	61000	#0 Square Recess	1"
	61002	#1 Square Recess	1"
	61004	#2 Square Recess	1"
	61006	#3 Square Recess	1"
	61085	1/8" Clutch	1"
	61087	5/32" Clutch	1"
	61089	3/16" Clutch	1"
	61222	Magnetic Bit Holder	2-1/4"
	6925	Bit Holder	1"
	—	Magnetic Base	7"

PHILLIPS<sup>®</sup> is a registered trademark of Phillips Screw Co.  
POZIDRIV<sup>®</sup> is a registered trademark of Phillips Screw Co.  
TORX<sup>®</sup> is a registered trademark of Textron, Inc.



**PHILLIPS® INSERT BITS—1/4" HEX**

Product ID No.		Length
60002	1	1"
60008	2	1"
60020	3	1"



**SLOTTED INSERT BITS—1/4" HEX**

Product ID No.	Screw Size	Blade Thickness		Length
60202	4F-5R	.034	3/16"	1"
60204	6F-8R	.040	7/32"	1"
60208	10F-12R	.046	9/32"	1"



**TORX® INSERT BITS—1/4" HEX**

Product ID No.		Length
60508	T10	1"
60510	T15	1"
60512	T20	1"
60514	T25	1"
60516	T27	1"
60518	T30	1"
60520	T40	1"



**SQUARE RECESS INSERT BITS—1/4" HEX**

Product ID No.		Length
61002	1	1"
61004	2	1"



**SET NO. 9322  
11 PC. MAGNETIC  
RATCHETING SCREWDRIVER BIT SET**

- Gearless Ratcheting Screwdriver provides smooth operation, infinite ratcheting angle.
- Convenient bit storage in handle.
- Weight: .76 lbs.

Product ID No.	Contents	Description	Length
9322	60002	#1 Phillips®	1"
	60008	#2 Phillips®	1"
	60202	4F-5R Slotted	1"
	60206	8F-10R Slotted	1"
	—	3/16" Nut Setter	1-1/2"
	—	1/4" Nut Setter	1-1/2"
	—	9/32" Nut Setter	1-1/2"
	—	5/16" Nut Setter	1-1/2"
	—	11/32" Nut Setter	1-1/2"
	—	7/16" Nut Setter	1-1/2"
	—	Magnetic Ratcheting Screwdriver	8-3/4"



**SET NO. 9224  
5 PC. MAGNETIC  
SCREWDRIVER BIT SET—LONG REACH**

- Extra long handle allows greater access to confined, restricted areas.
- Convenient bit storage in handle.
- Weight: .38 lbs.

Product ID No.	Contents	Description	Length
9224	60002	#1 Phillips®	1"
	60008	#2 Phillips®	1"
	60202	4F-5R Slotted	1"
	60206	8F-10R Slotted	1"
	9300MX	Magnetic Screwdriver—Long Reach	11-5/16"

PHILLIPS® is a registered trademark of Phillips Screw Co.  
TORX® is a registered trademark of Textron, Inc.



**SCREW STARTERS—PHILLIPS® TIP**

• Pocket clip.

Product ID No.	Length	Weight lbs.
9884	5-3/4"	.04



**SCREW STARTERS—STANDARD TIP**

• Pocket clip.

Product ID No.	Length	Weight lbs.
9853	5-5/8"	.04
9855	9-5/8"	.07

Fed'l Specs.: GGG-S-121E



**SCREW STARTER—STANDARD AND PHILLIPS® TIPS**

• Pocket clip.

Product ID No.	Length	Weight lbs.
9866	6-1/4"	.04



**OFFSET SCREWDRIVERS—STANDARD TIP**

• Black oxide finish.

Product ID No.		Length	Weight lbs.
36 1/4	1/4"	4-5/8"	.08
36 5/16	5/16"	4-7/8"	.13
36 3/8	3/8"	6-1/8"	.22

Fed'l Specs.: GGG-S-121E



**OFFSET SCREWDRIVERS—PHILLIPS® TIP**

• Precision milled tips for precise fit.

• Black oxide finish.

Product ID No.		Length	Weight lbs.
34 1/4	1 & 2	4-3/4"	.08
34 3/8	3 & 4	6-1/8"	.24

Fed'l Specs.: GGG-S-121E



**SET NO. 9200H  
7 PC. HOLLOW SHAFT NUT DRIVER SET**

• Weight: 4.22 lbs.

Product ID No.	Contents	 in.	Length
9200H	9206H	3/16"	6-11/16"
	9208H	1/4"	6-11/16"
	9210H	5/16"	6-11/16"
	9211H	11/32"	6-11/16"
	9212H	3/8"	6-11/16"
	9214H	7/16"	7"
9216H	1/2"	7"	
9200CBB	Blow Mold Box		



**SET NO. 9201MB  
11 PC. METRIC NUT DRIVER SET**

• Weight: 4.39 lbs.

Product ID No.	Contents	 mm	Length
9201MB	9204M	4	6-49/64"
	9205M	5	6-49/64"
	92055M	5.5	6-49/64"
	9206M	6	6-49/64"
	9207M	7	6-49/64"
	9208M	8	6-49/64"
	9209M	9	6-49/64"
	9210M	10	6-49/64"
	9211M	11	6-49/64"
	9213M	13	7"
9214M	14	7"	
9200DPB	Blow Mold Box		

PHILLIPS® is a registered trademark of Phillips Screw Co.





**SET NO. 9200DB**  
**11 PC. NUT DRIVER SET**

• Weight: 4.22 lbs.

Product ID No.	Contents	Hex in.	Length
9200	9206	3/16"	6-11/16"
	9207	7/32"	6-11/16"
	9208	1/4"	6-11/16"
	9209	9/32"	6-11/16"
	9210	5/16"	6-11/16"
	9211	11/32"	6-11/16"
	9212	3/8"	6-11/16"
	9214	7/16"	7"
	9216	1/2"	7"
	9218	9/16"	7"
	9220	5/8"	7"
	9200DPB	Blow Mold Box	



**SET NO. 9230M**  
**7 PC. METRIC NUT DRIVER SET**

• Weight: 1.59 lbs.

Product ID No.	Contents	Hex mm	Length (mm)
9230M	9205M	5	172
	92055M	5.5	172
	9206M	6	172
	9207M	7	172
	9208M	8	172
	9209M	9	172
	9210M	10	172
	2488	Kit	



**SET NO. 9200C**  
**7 PC. NUT DRIVER SET**

• Weight: 1.77 lbs.

Product ID No.	Contents	Hex in.	Length
9200C	9206	3/16"	6-11/16"
	9207	7/32"	6-11/16"
	9208	1/4"	6-11/16"
	9209	9/32"	6-11/16"
	9210	5/16"	6-11/16"
	9211	11/32"	6-11/16"
	9212	3/8"	6-11/16"
	2488	Kit	



**SET NO. 9200M**  
**5 PC. MIDGET NUT DRIVER SET**

• Weight: 13 lbs.

Product ID No.	Contents	Hex in.	Length
9200M	92021/2	5/64"	2-1/2"
	9203	3/32"	2-1/2"
	92031/2	7/64"	2-1/2"
	9204	1/8"	2-1/2"
	9205	5/32"	2-1/2"
	2427	Kit	



**HOLLOW SHAFT NUT DRIVERS**

- Full hollow shaft design for maximum bolt clearance.
- One piece shaft design for greater strength and durability.
- Ideal for electronics, assembly, and various industrial applications.
- Color coded handles for easy size identification.

Product ID No.	in.	Bolt Clearance	L
9206H	3/16"	4-5/16"	6-11/16"
9208H	1/4"	4-5/16"	6-11/16"
9210H	5/16"	4-3/8"	6-11/16"
9211H	11/32"	4-3/8"	6-11/16"
9212H	3/8"	4-3/8"	6-11/16"
9214H	7/16"	5-1/16"	7"
9216H	1/2"	5-1/16"	7"

Fed'l Specs.: GGG-W-657C  
ANSI Spec.: B107.12



**METRIC NUT DRIVERS**

- Blue handle for easy metric identification.

Product ID No.	mm	L1	L (mm)	Weight lbs.
9204M	4	73	172	.19
9205M	5	73	172	.19
92055M*	5.5	73	172	.19
9206M*	6	73	172	.19
9207M*	7	73	172	.19
9208M*	8	73	172	.21
9209M*	9	73	172	.22
9210M*	10	73	172	.29
9211M*	11	73	172	.28
9213M*	13	73	178	.34
9214M	14	73	178	.43

\*ANSI Spec.: B107.12



**NUT DRIVERS**

- Precision formed, heat treated hex openings.
- Color coded handles for easy identification.

Product ID No.	in.	L1	L	Weight lbs.
9206	3/16"	2-7/8"	6-11/16"	.18
9207	7/32"	2-7/8"	6-11/16"	.14
9208	1/4"	2-7/8"	6-11/16"	.19
9209	9/32"	2-7/8"	6-11/16"	.22
9210	5/16"	2-7/8"	6-11/16"	.22
9211	11/32"	2-7/8"	6-11/16"	.22
9212	3/8"	2-7/8"	6-11/16"	.22
9214	7/16"	2-7/8"	7"	.33
9216	1/2"	2-7/8"	7"	.34
9218	9/16"	2-7/8"	7"	.43
9220	5/8"	2-7/8"	7"	.45

Fed'l Specs.: GGG-W-657C  
ANSI Spec.: B107.12



**MIDGET NUT DRIVERS**

- Designed for work on precision instrumentation, and miniature assemblies.

Product ID No.	in.	Bolt Clearance	Weight lbs.
9204	1/8"	2-1/2"	.03
9205	5/32"	2-1/2"	.03

Fed'l Specs.: GGG-W-657C  
ANSI Spec.: B107.12

**REFERENCE MEASUREMENT KEY**

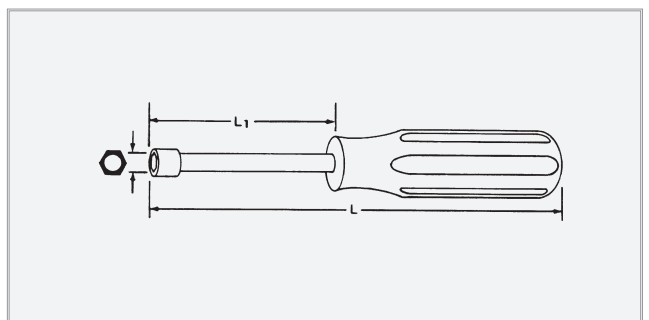



**SET NO. 4995**  
**13 PC. BALL STYLE HEX KEY SET**

• Screws can be tightened or loosened at angles up to 25°.

Product ID No.	in.	Length
4995	.050"	2-15/16"
	1/16"	3-1/16"
	5/64"	3-1/4"
	3/32"	3-1/2"
	7/64"	3-11/16"
	1/8"	3-7/8"
	9/64"	4-1/8"
	5/32"	4-5/16"
	3/16"	4-11/16"
	7/32"	5-1/8"
	1/4"	5-1/2"
	5/16"	6-1/4"
	3/8"	7-1/16"

Molded Plastic Holder



**SET NO. 4969**  
**6 PC. METRIC T-HANDLE HEX KEY SET**

• Weight: 1.0 lbs.

Product ID No.	mm	Length
4969	2	152
	2.5	152
	3	152
	4	152
	5	152
	6	152

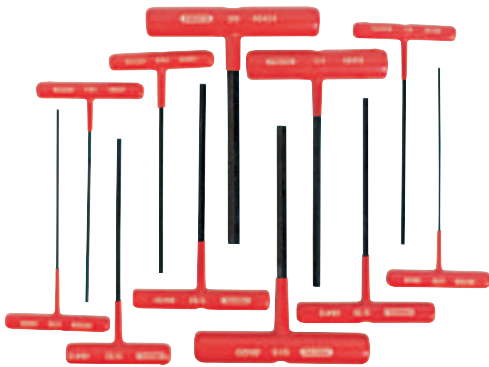

**SET NO. 4968**  
**11 PC. T-HANDLE HEX KEY SET**

• Weight: 3.98 lbs.

Product ID No.	in.	Length
4968	5/64"	6"
	3/32"	6"
	7/64"	6"
	1/8"	6"
	9/64"	6"
	5/32"	6"
	3/16"	6"
	7/32"	6"
	1/4"	6"
	5/16"	6"
	3/8"	6"



**SET NO. 4986**  
**18 PC. HEX KEY SET**

• Weight: 3.36 lbs.

Product ID No.	in.	Length
4986	.028"	1-1/4"
	.035"	1-1/4"
	.050"	1-11/16"
	1/16"	1-3/4"
	5/64"	1-7/8"
	3/32"	2"
	7/64"	2-1/8"
	1/8"	2-1/4"
	9/64"	2-3/8"
	5/32"	2-1/2"
	3/16"	2-3/4"
	7/32"	3"
	1/4"	3-1/4"
	5/16"	3-3/4"
	3/8"	4-1/4"
	1/2"	5-1/4"
	9/16"	5-3/4"
	5/8"	6-1/4"

Metal Box





**SET NO. 4980  
13 PC. HEX KEY SET**

• Weight: .60 lbs.

Product D No.	in.	Length
4980	.050"	1-11/16"
	1/16"	1-3/4"
	5/64"	1-7/8"
	3/32"	2"
	7/64"	2-1/8"
	1/8"	2-1/4"
	9/64"	2-3/8"
	5/32"	2-1/2"
	3/16"	2-3/4"
	7/32"	3"
	1/4"	3-1/4"
	5/16"	3-3/4"
	3/8"	4-1/4"

Molded Plastic Holder

Fed'l Specs.: GGG-K-275D



**SET NO. 4987  
14 PC. LONG HEX KEY SET**

• Weight: 2.28 lbs.

Product D No.	in.	Length
4987	.050"	2-7/8"
	1/16"	3"
	5/64"	3-3/16"
	3/32"	3-3/8"
	7/64"	3-9/16"
	1/8"	3-3/4"
	9/64"	3-15/16"
	5/32"	4-1/8"
	3/16"	4-1/2"
	7/32"	4-7/8"
	1/4"	5-1/4"
	5/16"	6"
	3/8"	6-3/4"
	1/2"	8-1/4"

Metal Box

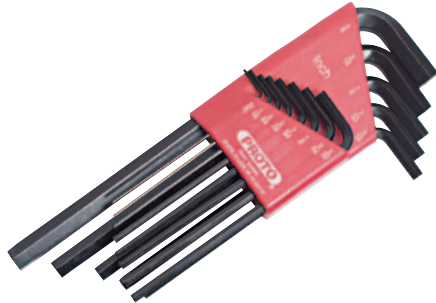

**SET NO. 4983  
13 PC. LONG HEX KEY SET**

• Weight: .84 lbs.

Product D No.	in.	Length
4983	.050"	2-7/8"
	1/16"	3"
	5/64"	3-3/16"
	3/32"	3-3/8"
	7/64"	3-9/16"
	1/8"	3-3/4"
	9/64"	3-15/16"
	5/32"	4-1/8"
	3/16"	4-1/2"
	7/32"	4-7/8"
	1/4"	5-1/4"
	5/16"	6"
	3/8"	6-3/4"

Molded Plastic Holder

Fed'l Specs.: GGG-K-275D

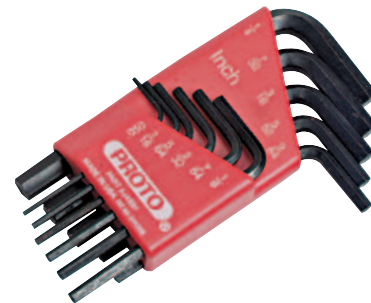

**SET NO. 4981  
11 PC. HEX KEY SET**

• Weight: .24 lbs.

Product D No.	in.	Length
4981	.050"	1-11/16"
	1/16"	1-3/4"
	5/64"	1-7/8"
	3/32"	2"
	7/64"	2-1/4"
	1/8"	2-1/4"
	9/64"	2-1/2"
	5/32"	2-1/2"
	3/16"	2-3/4"
	7/32"	3"
	1/4"	3-1/4"

Molded Plastic Holder

Fed'l Specs.: GGG-K-275D



**SET NO. 4996**  
**9 PC. METRIC BALL STYLE HEX KEY SET**

- Screws can be tightened or loosened at angles up to 25°.
- Weight: 1.7 lbs.

Product ID No.	mm	Length (mm)
4996	1.5	78
	2	84
	2.5	92
	3	102
	4	114
	5	130
	6	156
	8	178
	10	197

Molded Plastic Holder

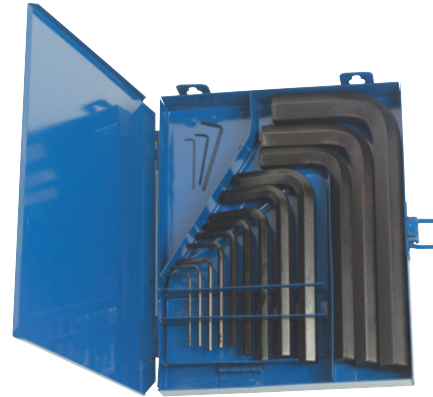

**SET NO. 4988M**  
**15 PC. METRIC HEX KEY SET**

- Weight: 3.4 lbs.

Product ID No.	mm	Length (mm)
4988M	.07	31
	.09	31
	1.3	41
	1.5	44
	2	49
	2.5	55
	3	62
	4	68
	5	78
	6	88
	8	98
	10	109
	12	122
	14	136
	17	156

Metal Box

Fed'l Specs.: GGG-K-275D



**SET NO. 4961**  
**10 PC. TORX® KEY SET**

- Weight: .76.

Product ID No.		Length
4961	T10	2-3/8"
	T15	2-1/2"
	T20	2-11/16"
	T25	2-1/8"
	T27	3"
	T30	3-1/4"
	T40	3-15/16"
	T45	4-1/16"
	T50	4-9/16"
	T55	5-3/16"

Plastic Pouch



**SET NO. 4984**  
**9 PC. METRIC HEX KEY SET**

- Weight: 54 lbs.

Product ID No.	mm	Length (mm)
4984	1.5	44
	2	49
	2.5	55
	3	62
	4	68
	5	78
	6	88
	8	98
	10	109

Molded Plastic Holder

Fed'l Specs.: GGG-K-275D

TORX® is a registered trademark of Textron.

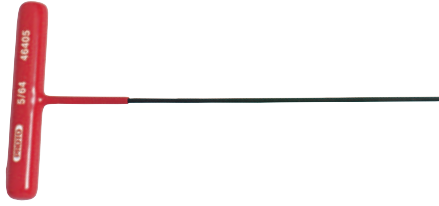

**T-HANDLE HEX KEYS**

- T-handle design for greater torque.
- Cushion grip handle provides added comfort.
- Hex size is printed on handle for easy size identification.

Product ID No.	in.	Handle Width	Length
46405	5/64"	3"	6"
46406	3/32"	3"	6"
46408	1/8"	3"	6"
46409	9/64"	3"	6"
46410	5/32"	3"	6"
46412	3/16"	4"	6"
46416	1/4"	4"	6"
46420	5/16"	6"	6"
46424	3/8"	6"	6"



**HEX KEYS**

Product ID No.	in.	Long Arm	Short Arm
46136	9/16"	5-3/4"	1-3/4"
46140	5/8"	6-1/4"	1-7/8"



**HEX KEYS—LONG**

Product ID No.	in.	Long Arm	Short Arm
46203	.050"	2-7/8"	1/2"
46204	1/16"	3"	9/16"
46205	5/64"	3-3/16"	5/8"
46206	3/32"	3-3/8"	11/16"
46207	7/64"	3-9/16"	23/32"
46208	1/8"	3-3/4"	3/4"
46209	9/64"	3-15/16"	13/16"
46210	5/32"	4-1/8"	27/32"
46212	3/16"	4-1/2"	15/16"
46214	7/32"	4-7/8"	1"
46216	1/4"	5-1/4"	1-1/8"
46220	5/16"	6"	1-1/4"
46224	3/8"	6-3/4"	1-3/8"
46228	7/16"	7-1/2"	1-1/2"
46232	1/2"	8-1/4"	1-5/8"



**METRIC HEX KEYS**

Product ID No.	mm	Long Arm (mm)	Short Arm (mm)
46300	.07	31	6
46302	.09	31	9
46304	1.3	41	13
46306	1.5	44	13



