



PROTO



**WE'RE OUT TO MAKE WORK, LESS WORK. ONE TURN
OF THE WRENCH AT A TIME.**

That begins with a comprehensive product line that puts the right wrench for the task in your hand.

Ours includes standard, extra long, flex-head, angle-head, box, deep offset box, ratcheting box,

obstruction, adjustable, flare nut, striking, slugging, spanner and ... you get the point. Most of these

incorporate time (and knuckle) saving features like Anti-Slip Design™ technology on open ends and

TorquePlus™ drive configurations on box ends. And all wrenches are forged, polished and finished to last.

WRENCHES



Full Polish Anti-Slip Combination Wrenches

PROTO

ENGINEERED FOR INDUSTRY

Proto® offers a wide range of sizes for many types of ends, with innovations like ratcheting splines and flex-head sockets. We also offer a wide range of angled and bent offsets to meet specific job applications.

Chrome plating to aerospace standards where applicable.

Precision broached for tight tolerances.

Premium alloy steel for strength.

Anti-Slip Design locks the fastener into place.

ASD increases the applied force to the flat of the fastener and away from corners.

FINISHES AVAILABLE



Polish Chrome Satin Chrome Black Oxide Black Chrome

DIFFERENT KINDS OF OFFSETS

- › **Angled Offsets:** The end lies flat with the handle, and the end turns either left or right.
- › **Bent Offsets:** The end is centered with the handle, but bent. The end does not lie flat.
- › **Deep Offsets:** Two bends offset the handle away from the end for better clearance.

DIFFERENT KINDS OF ENDS



WRENCH GUIDE

COMBINATION WRENCHES

Same sizes of two different types.



DOUBLE BOX AND OPEN END WRENCHES

Two different sizes of the same type.



RATCHETING WRENCHES

Reversables have an offset. Non-Reversables are flat.



CROWFOOT WRENCHES

With locking extensions to reach around obstacles.



PIPE WRENCHES

Available in Aluminum and Cast Iron.



STRIKING WRENCHES

Hit them with a hammer. Available with flat or offset ends.



ADJUSTABLE WRENCHES

Featuring Klik-Stop®. The wrench clicks at different sizings so you can feel your adjustments without looking.



INSULATED WRENCHES

Insulated to 1000V AC or 1500V DC.



X-LARGE WRENCHES

For work on oversized equipment.

FULL POLISH COMBINATION REVERSIBLE RATCHETING WRENCHES - SPLINE

Delayed Availability

- › Anti-Slip Design (ASD) open end.
- › Smooth transition from head to shank.
- › Industrial strength I-Beam shank provides broad bearing surface helping improve comfort and helping reduce hand fatigue.
- › Protected switch lever helps prevent accidental reversal.
- › Compact ratcheting head improves access.
- › 72-teeth provide 5° ratcheting.



Product #	Size (in)	Throat Depth (in) (B)	Outside Head Width (in) (C)	Head Thickness (in) (D)	Outside Head Width (in) (C1)	Head Thickness (in) (D1)	Overall Length (in)	Weight (lbs)
JSCV08A	1/4	5/16	35/64	5/32	35/64	1/4	4-59/64	0.05
JSCV09A	9/32	5/16	39/64	11/64	43/64	1/4	5-5/32	0.07
JSCV10A	5/16	25/64	11/16	11/64	43/64	1/4	5-27/64	0.08
JSCV11A	11/32	13/32	25/32	3/16	3/4	17/64	5-43/64	0.10
JSCV12A	3/8	29/64	27/32	13/64	25/32	9/32	5-29/32	0.12
JSCV14A	7/16	1/2	15/16	7/32	55/64	19/64	6-29/32	0.16
JSCV16A	1/2	39/64	1-5/64	1/4	1	11/32	7-29/32	0.24
JSCV18A	9/16	11/16	1-13/64	9/32	1-5/64	23/64	8-49/64	0.30
JSCV20A	5/8	3/4	1-21/64	19/64	1-3/16	25/64	9-33/64	0.40
JSCV22A	11/16	53/64	1-7/16	5/16	1-1/4	13/32	10-17/64	0.49
JSCV24A	3/4	29/32	1-37/64	11/32	1-21/64	7/16	11-3/64	0.60
JSCV26A	13/16	31/32	1-23/32	23/64	1-37/64	33/64	11-13/16	0.80
JSCV28A	7/8	1-3/64	1-7/8	3/8	1-37/64	33/64	12-35/64	0.86
JSCV30A	15/16	1-1/8	1-31/32	25/64	1-53/64	37/64	13-5/16	1.09
JSCV32A	1	1-13/64	2-3/32	27/64	1-53/64	37/64	14-1/16	1.17
JSCV34A	1-1/16	1-9/32	2-7/32	15/32	2-3/64	39/64	14-15/16	1.44
JSCV36A	1-1/8	1-23/64	2-11/32	1/2	2-9/32	43/64	15-7/8	1.85
JSCV40A	1-1/4	1-1/2	2-19/32	35/64	2-15/32	11/16	16-59/64	2.29

THE STORY BEHIND THE OFFSET OPEN END



A standard combination wrench gets stuck.



The Proto® Wrench with the Offset Open End still has 10 - 12° of turning angle.

Reaching a fastener behind an obstruction is frustrating, especially when you can reach it with the wrench, but you can't turn the wrench.

Rethinking the standard combination wrench allowed Proto® engineers to discover a better way reach and turn something in a difficult place.

By turning the open end to an angle, the patented Offset Open End has an improved angle of attack onto the fastener. It can squeeze an extra 10 to 12 degrees of turning angle when obstructions are nearby.

FULL POLISH METRIC COMBINATION REVERSIBLE RATCHETING WRENCHES - SPLINE

METRIC
Delayed Availability

- › Anti-Slip Design (ASD) open end.
- › Smooth transition from head to shank.
- › Industrial strength I-Beam shank provides broad bearing surface helping improve comfort and helping reduce hand fatigue.
- › Protected switch lever helps prevent accidental reversal.
- › Compact ratcheting head improves access.
- › 72-teeth provide 5° ratcheting.



Product #	Size (mm)	Throat Depth (in) (B)	Outside Head Width (in) (C)	Head Thickness (in) (D)	Outside Head Width (in) (C1)	Head Thickness (in) (D1)	Overall Length (in)	Weight (lbs)
JSCVM06A	6	5/16	35/64	5/32	35/64	1/4	4-59/64	0.05
JSCVM07A	7	5/16	39/64	11/64	43/64	1/4	5-5/32	0.07
JSCVM08A	8	25/64	11/16	11/64	43/64	1/4	5-27/64	0.08
JSCVM09A	9	13/32	25/32	3/16	3/4	17/64	5-43/64	0.10
JSCVM10A	10	29/64	27/32	13/64	25/32	9/32	5-29/32	0.12
JSCVM11A	11	1/2	15/16	7/32	55/64	19/64	6-29/32	0.16
JSCVM12A	12	35/64	1-1/64	15/64	29/32	21/64	7-23/32	0.20
JSCVM13A	13	39/64	1-5/64	1/4	1	11/32	7-29/32	0.24
JSCVM14A	14	11/16	1-13/64	9/32	1-5/64	23/64	8-49/64	0.30
JSCVM15A	15	23/32	1-17/64	9/32	1-7/64	3/8	9-9/64	0.34
JSCVM16A	16	3/4	1-21/64	19/64	1-3/16	25/64	9-33/64	0.40
JSCVM17A	17	53/64	1-7/16	5/16	1-1/4	13/32	10-17/64	0.49
JSCVM18A	18	55/64	1-33/64	21/64	1-9/32	27/64	10-11/16	0.55
JSCVM19A	19	29/32	1-37/64	11/32	1-21/64	7/16	11-3/64	0.60
JSCVM21A	21	31/32	1-23/32	23/64	1-37/64	33/64	11-13/16	0.80
JSCVM22A	22	1-3/64	1-7/8	3/8	1-37/64	33/64	12-35/64	0.86
JSCVM24A	24	1-1/8	1-31/32	25/64	1-53/64	37/64	13-5/16	1.09
JSCVM27A	27	1-9/32	2-7/32	15/32	2-3/64	39/64	14-15/16	1.44
JSCVM30A	30	1-23/64	2-11/32	1/2	2-9/32	43/64	15-7/8	1.85
JSCVM32A	32	1-1/2	2-19/32	35/64	2-15/32	11/16	16-59/64	2.29

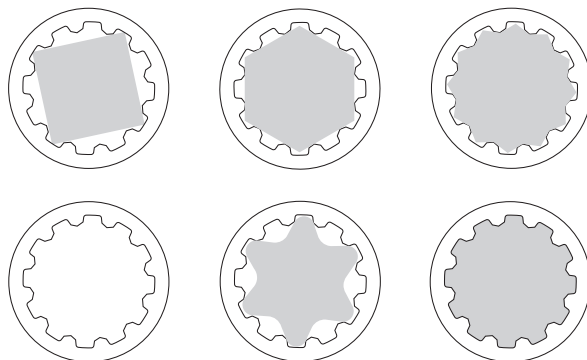

Versatile usages on 4pt, 6pt, 12pt, spline, Torx®, and slightly rounded fasteners.

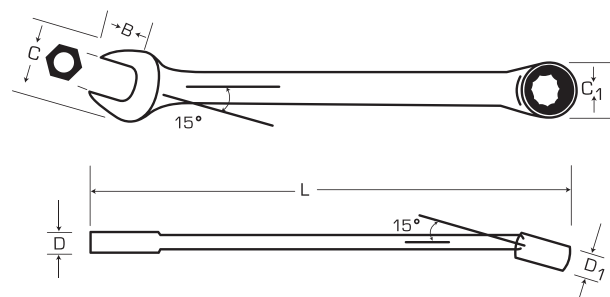

20 PIECE REVERSIBLE COMBINATION RATCHETING WRENCH SET - SPLINE

Product #: **JSCV-20S**

Contents	Size (in)	Point Count	Overall Length (in)
JSCV07	7/32	Spline	5
JSCV08	1/4	Spline	5
JSCV09	9/32	Spline	5-1/2
JSCV10	5/16	Spline	5-1/2
JSCV11	11/32	Spline	5-15/16
JSCV12	3/8	Spline	6-1/4
JSCV14	7/16	Spline	6-1/2
JSCV16	1/2	Spline	7
JSCV18	9/16	Spline	7-1/2
JSCV20	5/8	Spline	8-3/16
JSCV22	11/16	Spline	8-7/8
JSCV24	3/4	Spline	9-3/4
JSCV26	13/16	Spline	1-17/16
JSCV28	7/8	Spline	1-17/16
JSCV30	15/16	Spline	12-3/4
JSCV32	1	Spline	12-3/4
JSCV34	1-1/16	Spline	14-1/8
JSCV36	1-1/8	Spline	15-7/8
JSCV40	1-1/4	Spline	16-3/4
JSCV48	1-1/2	Spline	19-5/16
JSCV20SP	Tool Roll		

- ▶ Black chrome finish is corrosion resistant and visually distinctive.
- ▶ Fractional spline wrenches can be used on fractional 4, 6, 12 point, spline and Torx® fasteners.
- ▶ The chrome-vanadium switch lever allows for easy changes in turning direction which helps improve speed.
- ▶ 15° angled offset box end helps keep shank clear of obstructions.
- ▶ Anti-Slip Design (ASD) open end.
- ▶ Weight (lbs): 16.20



22 PIECE METRIC REVERSIBLE COMBINATION RATCHETING WRENCH SET - SPLINE

METRIC

Product #: **JSCVM-22S**

Contents	Size (mm)	Point Count	Overall Length (in)
JSCVM06	6	Spline	5
JSCVM07	7	Spline	5-1/2
JSCVM08	8	Spline	5-1/2
JSCVM09	9	Spline	5-15/16
JSCVM10	10	Spline	6-1/4
JSCVM11	11	Spline	6-9/16
JSCVM12	12	Spline	6-3/4
JSCVM13	13	Spline	7
JSCVM14	14	Spline	7-1/2
JSCVM15	15	Spline	7-7/8
JSCVM16	16	Spline	8-3/16
JSCVM17	17	Spline	8-7/8
JSCVM18	18	Spline	9-5/16
JSCVM19	19	Spline	9-3/4
JSCVM21	21	Spline	11-7/16
JSCVM22	22	Spline	11-7/16
JSCVM24	24	Spline	12-3/4
JSCVM27	27	Spline	14-1/8
JSCVM30	30	Spline	15-7/8
JSCVM32	32	Spline	16-3/4
JSCVM34	34	Spline	18-1/8
JSCVM36	36	Spline	19-5/16
JSCVM22SP	Tool Roll		

- ▶ Metric Spline wrenches can be used on metric 4, 6, 12 point, spline and Torx® fasteners.
- ▶ The chrome-vanadium switch lever allows for easy changes in turning direction which helps improve speed.
- ▶ 15° angled offset box end helps keep shank clear of obstructions.
- ▶ Chrome-vanadium box ends and switch levers provide high strength and durability.
- ▶ Box end is countersunk for easy application to the fastener.
- ▶ Spline design was created for use with speciality spline bolts which are used when weight and size of bolt heads must be minimized.
- ▶ Spline design enables the wrench to contact conventional fasteners away from the corners, which applies force over a larger area, reducing risk of fastener scoring and helps prevent rounding of the corners and other fasteners damage that could lead to Foreign Object Damage (FOD).
- ▶ The high contact surface area which is away from fastener points enables turning of highly rounded fasteners.
- ▶ Anti-Slip Design (ASD) open end.
- ▶ Black chrome finish is corrosion resistant and visually distinctive.
- ▶ Weight (lbs): 17.10



13 PIECE METRIC REVERSIBLE COMBINATION RATCHETING WRENCH SET - SPLINE

METRIC

Product #: **JSCVM-13S**

- › Metric Spline wrenches can be used on metric 4, 6, 12 point, spline and Torx® fasteners.
- › The chrome-vanadium switch lever allows for easy changes in turning direction which helps improve speed.
- › 15° angled offset box end helps keep shank clear of obstructions.
- › Chrome-vanadium box ends and switch levers provide high strength and durability.
- › Box end is countersunk for easy application to the fastener.
- › Spline design was created for use with speciality spline bolts which are used when weight and size of bolt heads must be minimized.
- › Spline design enables the wrench to contact conventional fasteners away from the corners, which applies force over a larger area, reducing risk of fastener scoring and helps prevent rounding of the corners and other fasteners damage that could lead to Foreign Object Damage (FOD).
- › The high contact surface area which is away from fastener points enables turning of highly rounded fasteners.
- › Anti-Slip Design (ASD) open end.
- › Black chrome finish is corrosion resistant and visually distinctive.
- › Weight (lbs): 3.02

Contents	Size (mm)	Point Count	Overall Length (in)
JSCVM07	7	Spline	5-1/2
JSCVM08	8	Spline	5-1/2
JSCVM09	9	Spline	5-15/16
JSCVM10	10	Spline	6-1/4
JSCVM11	11	Spline	6-9/16
JSCVM12	12	Spline	6-3/4
JSCVM13	13	Spline	7
JSCVM14	14	Spline	7-1/2
JSCVM15	15	Spline	7-7/8
JSCVM16	16	Spline	8-3/16
JSCVM17	17	Spline	8-7/8
JSCVM18	18	Spline	9-5/16
JSCVM19	19	Spline	9-3/4
JSCVM13SP	Tool Roll		



9 PIECE REVERSIBLE COMBINATION RATCHETING WRENCH SET - SPLINE

Product #: **JSCV-9S**

- › Black chrome finish is corrosion resistant and visually distinctive.
- › Fractional spline wrenches can be used on fractional 4, 6, 12 point, spline fasteners and Torx® fasteners.
- › The chrome-vanadium switch lever allows for easy changes in turning direction which helps improve speed.
- › 15° angled offset box end helps keep shank clear of obstructions.
- › Anti-Slip Design (ASD) open end.
- › Weight (lbs): 1.90

Contents	Size (in)	Point Size	Overall Length (in)
JSCV09	9/32	Spline	5-1/2
JSCV10	5/16	Spline	5-1/2
JSCV12	3/8	Spline	6-1/4
JSCV14	7/16	Spline	6-1/2
JSCV16	1/2	Spline	7
JSCV18	9/16	Spline	7-1/2
JSCV20	5/8	Spline	8-3/16
JSCV22	11/16	Spline	8-7/8
JSCV24	3/4	Spline	9-3/4
JSCV9SP	Tool Roll		



BLACK CHROME COMBINATION REVERSIBLE RATCHETING WRENCHES - SPLINE

- › Fractional spline wrenches can be used on fractional 4, 6, 12 point, spline and Torx® fasteners.
- › The chrome-vanadium switch lever allows for easy changes in turning direction which helps improve speed.
- › 15° angled offset box end helps keep shank clear of obstructions.
- › Chrome-vanadium box ends and switch levers provide high strength and durability.
- › Box end is countersunk for easy application to the fastener.
- › Spline design was created for use with specialty spline bolts which are used when weight and size of bolt heads must be minimized.
- › Spline design enables the wrench to contact conventional fasteners away from the corners, which applies force over a larger area, reducing risk of fastener scoring and helps prevent rounding of the corners and other fasteners damage that could lead to Foreign Object Damage (FOD).
- › The high contact surface area which is away from fastener points enables turning of highly rounded fasteners.
- › Anti-Slip Design (ASD) open end.
- › Black chrome finish is corrosion resistant and visually distinctive.



Product #	Size (in)	Outside Head Width (in) (C)	Head Thickness (in) (D)	Head Thickness (in) (D1)	Overall Length (in)	Weight (lbs)
JSCV07	7/32	9/16	1/8	1/8	5	0.06
JSCV08	1/4	9/16	1/8	1/8	5	0.06
JSCV09	9/32	11/16	1/8	1/8	5-1/2	0.07
JSCV10	5/16	11/16	1/8	1/8	5-1/2	0.07
JSCV11	11/32	3/4	1/8	1/8	5-15/16	0.09
JSCV12	3/8	13/16	1/8	1/8	6-1/4	0.11
JSCV14	7/16	15/16	1/8	1/8	6-1/2	0.14
JSCV16	1/2	1-1/16	3/16	3/16	7	0.20
JSCV18	9/16	1-1/8	3/16	3/16	7-1/2	0.22
JSCV20	5/8	1-5/16	3/16	3/16	8-3/16	0.33
JSCV22	11/16	1-3/8	3/16	3/16	8-7/8	0.37
JSCV24	3/4	1-9/16	1/4	1/4	9-3/4	0.48
JSCV26	13/16	1-13/16	1/4	1/4	1-17/16	0.77
JSCV28	7/8	1-13/16	1/4	1/4	1-17/16	0.73
JSCV30	15/16	2-1/16	1/4	1/4	12-3/4	1.02
JSCV32	1	2-1/16	1/4	1/4	12-3/4	1.00
JSCV34	1-1/16	2-1/4	5/16	5/16	14-1/8	1.45
JSCV36	1-1/8	2-5/16	5/16	5/16	15-7/8	1.96
JSCV40	1-1/4	2-1/2	5/16	5/16	16-3/4	2.30
JSCV48	1-1/2	2-13/16	3/8	3/8	19-5/16	3.09

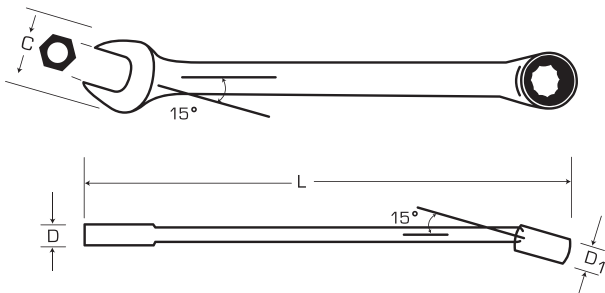

BLACK CHROME METRIC COMBINATION REVERSIBLE RATCHETING WRENCHES - SPLINE

METRIC

- › Metric Spline wrenches can be used on metric 4, 6, 12 point, spline and Torx® fasteners.
- › The chrome-vanadium switch lever allows for easy changes in turning direction which helps improve speed.
- › 15° angled offset box end helps keep shank clear of obstructions.
- › Chrome-vanadium box ends and switch levers provide high strength and durability.
- › Box end is countersunk for easy application to the fastener.
- › Spline design was created for use with specialty spline bolts which are used when weight and size of bolt heads must be minimized.
- › Spline design enables the wrench to contact conventional fasteners away from the corners, which applies force over a larger area, reducing risk of fastener scoring and helps prevent rounding of the corners and other fasteners damage that could lead to Foreign Object Damage (FOD).
- › The high contact surface area which is away from fastener points enables turning of highly rounded fasteners.
- › Anti-Slip Design (ASD) open end.
- › Black chrome finish is corrosion resistant and visually distinctive.



WRENCHES

RATCHETING

Product #	Size (mm)	Outside Head Width (in) (C)	Head Thickness (in) (D)	Head Thickness (in) (D1)	Overall Length (in)	Weight (lbs)
JSCVM06	6	9/16	1/8	1/8	5	0.06
JSCVM07	7	11/16	1/8	1/8	5-1/2	0.07
JSCVM08	8	11/16	1/8	1/8	5-1/2	0.07
JSCVM09	9	3/4	1/8	1/8	5-15/16	0.09
JSCVM10	10	13/16	1/8	1/8	6-1/4	0.11
JSCVM11	11	15/16	1/8	1/8	6-9/16	0.14
JSCVM12	12	1	3/16	3/16	6-3/4	0.17
JSCVM13	13	1-11/16	3/16	3/16	7	0.20
JSCVM14	14	1-1/8	3/16	3/16	7-1/2	0.24
JSCVM15	15	1-1/4	3/16	3/16	7-7/8	0.28
JSCVM16	16	1-5/16	3/16	3/16	8-3/16	0.33
JSCVM17	17	1-3/8	3/16	3/16	8-7/8	0.39
JSCVM18	18	1-1/2	3/16	3/16	9-5/16	0.43
JSCVM19	19	1-9/16	1/4	1/4	9-3/4	0.50
JSCVM21	21	1-13/16	1/4	1/4	11-7/16	0.76
JSCVM22	22	1-13/16	1/4	1/4	11-7/16	0.76
JSCVM24	24	2-1/16	1/4	1/4	12-3/4	1.06
JSCVM27	27	2-1/4	5/16	5/16	14-1/8	1.42
JSCVM30	30	2-5/16	5/16	5/16	15-7/8	1.89
JSCVM32	32	2-1/2	5/16	5/16	16-3/4	2.32
JSCVM34	34	2-1/2	3/8	3/8	18-1/8	2.65
JSCVM36	36	2-13/16	3/8	3/8	19-5/16	3.09

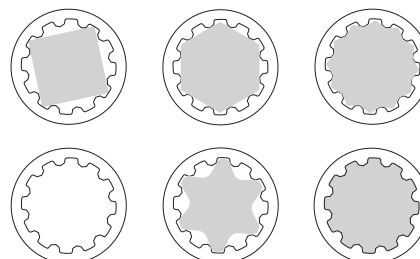

Versatile usages on 4pt, 6pt, 12pt, spline, Torx®, and slightly rounded fasteners.

9 PIECE NON-REVERSIBLE COMBINATION WRENCH SET - SPLINE

Product #: JSCR-9S

- › Black chrome finish is corrosion resistant and visually distinctive.
- › Non-reversing ratcheting wrenches can be flipped over to turn the fastener in the opposite direction.
- › Ratcheting spline box end is countersunk for easy application to the fastener.
- › Spline design was created for use with specialty spline bolts which are used when weight and size of bolt heads must be minimized.
- › Spline design enables the wrench to contact conventional fasteners away from the corners, which help apply force over a large area helping to reduce risk of fastener rounding.
- › Spline design also helps prevent rounding of corners and other fastener damage that could lead to Foreign Object Damage (FOD).
- › The high contact surface area which is away from fastener points enables turning of highly rounded fasteners.
- › Anti-Slip Design (ASD) open end.
- › Fractional spline wrenches can be used on fractional 4, 6, 12 point, spline and Torx® fasteners.
- › Weight (lbs): 2.71

Contents	Size (in)	Point Count	Overall Length (in)
JSCR08	1/4	Spline	5
JSCR10	5/16	Spline	5-1/2
JSCR12	3/8	Spline	6-1/4
JSCR14	7/16	Spline	6-1/2
JSCR16	1/2	Spline	7
JSCR18	9/16	Spline	7-1/2
JSCR20	5/8	Spline	8-3/16
JSCR22	11/16	Spline	8-7/8
JSCR24	3/4	Spline	9-3/4
JSCR9SP	Tool Roll		



10 PIECE METRIC NON-REVERSIBLE COMBINATION WRENCH SET - SPLINE

METRIC

Product #: JSCRM-10S

- › Metric Spline wrenches can be used on metric 4, 6, 12 point, spline and Torx® fasteners.
- › The chrome-vanadium switch lever allows for easy changes in turning direction which helps improve speed.
- › 15° angled offset box end helps keep shank clear of obstructions.
- › Chrome-vanadium box ends and switch levers provide high strength and durability.
- › Box end is countersunk for easy application to the fastener.
- › Spline design was created for use with speciality spline bolts which are used when weight and size of bolt heads must be minimized.
- › Spline design enables the wrench to contact conventional fasteners away from the corners, which applies force over a larger area, reducing risk of fastener scoring and helps prevent rounding of the corners and other fasteners damage that could lead to Foreign Object Damage (FOD).
- › The high contact surface area which is away from fastener points enables turning of highly rounded fasteners.
- › Anti-Slip Design (ASD) open end.
- › Black chrome finish is corrosion resistant and visually distinctive.
- › Weight (lbs): 2.71

Contents	Size (mm)	Point Count	Overall Length (in)
JSCRM10	10	Spline	6-1/4
JSCRM11	11	Spline	6-1/2
JSCRM12	12	Spline	6-3/4
JSCRM13	13	Spline	7
JSCRM14	14	Spline	7-1/2
JSCRM15	15	Spline	7-7/8
JSCRM16	16	Spline	8-3/16
JSCRM17	17	Spline	8-7/8
JSCRM18	18	Spline	9-5/16
JSCRM19	19	Spline	9-3/4
JSCRM10SP	Tool Roll		



BLACK CHROME COMBINATION NON-REVERSIBLE RATCHETING WRENCHES - SPLINE

- › Fractional spline wrenches can be used on fractional 4, 6, 12 point, spline and Torx® fasteners.
- › The chrome-vanadium switch lever allows for easy changes in turning direction which helps improve speed.
- › 15° angled offset box end helps keep shank clear of obstructions.
- › Chrome-vanadium box ends and switch levers provide high strength and durability.
- › Box end is countersunk for easy application to the fastener.
- › Spline design was created for use with speciality spline bolts which are used when weight and size of bolt heads must be minimized.
- › Spline design enables the wrench to contact conventional fasteners away from the corners, which applies force over a larger area, reducing risk of fastener scoring and helps prevent rounding of the corners and other fasteners damage that could lead to Foreign Object Damage (FOD).
- › The high contact surface area which is away from fastener points enables turning of highly rounded fasteners.
- › Anti-Slip Design (ASD) open end.
- › Black chrome finish is corrosion resistant and visually distinctive.



Product #	Size (in)	Outside Head Width (in) (C)	Head Thickness (in) (D)	Head Thickness (in) (D1)	Overall Length (in)	Weight (lbs)
JSCR08	1/4	9/16	1/8	1/8	5	0.05
JSCR10	5/16	11/16	1/8	1/8	5-1/2	0.06
JSCR11	11/32	3/4	1/8	1/8	5-15/16	0.08
JSCR12	3/8	13/16	1/8	1/8	6-1/4	0.10
JSCR14	7/16	15/16	1/8	1/8	6-1/2	0.13
JSCR16	1/2	1-1/16	3/16	3/16	7	0.18
JSCR18	9/16	1-1/8	3/16	3/16	7-1/2	0.22
JSCR20	5/8	1-5/16	3/16	3/16	8-3/16	0.32
JSCR22	11/16	1-3/8	3/16	3/16	8-7/8	0.38
JSCR24	3/4	1-9/16	1/4	1/4	9-3/4	0.47
JSCR26	13/16	1-13/16	1/4	1/4	11-7/16	0.70
JSCR28	7/8	1-13/16	1/4	1/4	11-7/16	0.70
JSCR30	15/16	2-1/16	1/4	1/4	12-3/4	1.02
JSCR32	1	2-1/16	1/4	1/4	12-3/4	1.02

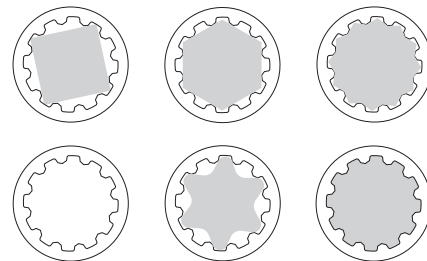
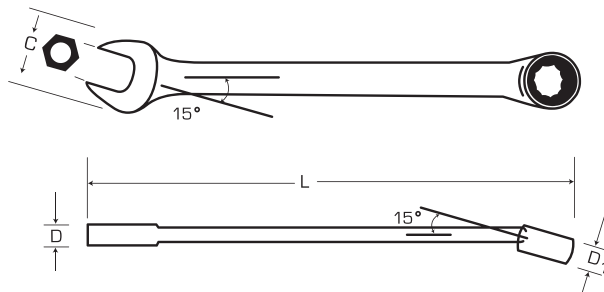

Versatile usages on 4pt, 6pt, 12pt, spline, Torx®, and slightly rounded fasteners.

BLACK CHROME METRIC COMBINATION NON-REVERSIBLE RATCHETING WRENCHES - SPLINE

- › Metric Spline wrenches can be used on metric 4, 6, 12 point, spline and Torx® fasteners.
- › The chrome-vanadium switch lever allows for easy changes in turning direction which helps improve speed.
- › 15° angled offset box end helps keep shank clear of obstructions.
- › Chrome-vanadium box ends and switch levers provide high strength and durability.
- › Box end is countersunk for easy application to the fastener.
- › Spline design was created for use with specialty spline bolts which are used when weight and size of bolt heads must be minimized.
- › Spline design enables the wrench to contact conventional fasteners away from the corners, which applies force over a larger area, reducing risk of fastener scoring and helps prevent rounding of the corners and other fasteners damage that could lead to Foreign Object Damage (FOD).
- › The high contact surface area which is away from fastener points enables turning of highly rounded fasteners.
- › Anti-Slip Design (ASD) open end.
- › Black chrome finish is corrosion resistant and visually distinctive.



Product #	Size (mm)	Outside Head Width (in) (C)	Head Thickness (in) (D)	Head Thickness (in) (D1)	Overall Length (in)	Weight (lbs)
JSCRM08	8	11/16	1/8	1/8	5-1/2	0.06
JSCRM09	9	3/4	1/8	1/8	5-15/16	0.08
JSCRM10	10	13/16	1/8	1/8	6-1/4	0.10
JSCRM11	11	15/16	1/8	1/8	6-1/2	0.13
JSCRM12	12	1	1/8	1/8	6-3/4	0.16
JSCRM13	13	1-1/16	3/16	3/16	7	0.18
JSCRM14	14	1-1/8	3/16	3/16	7-1/2	0.22
JSCRM15	15	1-1/4	3/16	3/16	7-7/8	0.25
JSCRM16	16	1-5/16	3/16	3/16	8-3/16	0.32
JSCRM17	17	1-7/16	3/16	3/16	8-7/8	0.38
JSCRM18	18	1-1/2	3/16	3/16	9-5/16	0.46
JSCRM19	19	1-9/16	1/4	1/4	9-3/4	0.47

8 PIECE DOUBLE BOX REVERSIBLE RATCHETING WRENCH SET - SPLINE

Product #: **JSBV-8S**

- › Black chrome finish is corrosion resistant and visually distinctive.
- › Non-reversing ratcheting wrenches can be flipped over to turn the fastener in the opposite direction.
- › Ratcheting spline box end is countersunk for easy application to the fastener.
- › Spline design was created for use with specialty spline bolts which are used when weight and size of bolt heads must be minimized.
- › Spline design enables the wrench to contact conventional fasteners away from the corners, which help apply force over a large area helping to reduce risk of fastener rounding.
- › Spline design also helps prevent rounding of corners and other fastener damage that could lead to Foreign Object Damage (FOD).
- › The fractional spline wrenches can be used on fractional 4, 6, 12 point and spline fasteners.
- › The high contact surface area which is away from fastener points enables turning of highly rounded fasteners.
- › Weight (lbs): 4.12

Contents	Size (in)	Point Count	Overall Length (in)
JSBV0709	7/32 x 9/32	Spline	4-1/2
JSBV0810	1/4 x 5/16	Spline	4-1/2
JSBV1214	3/8 x 7/16	Spline	5-15/16
JSBV1618	1/2 x 9/16	Spline	7-1/16
JSBV2022	5/8 x 11/16	Spline	7-7/8
JSBV2428	3/4 x 7/8	Spline	9-5/8
JSBV2630	13/16 x 15/16	Spline	10-1/4
JSBV3236	1 x 1-1/8	Spline	11-5/8
JSBV8SP	Tool Roll		



BLACK CHROME DOUBLE BOX REVERSIBLE RATCHETING WRENCHES - SPLINE

- › Black chrome finish is corrosion resistant and visually distinctive.
- › Ratcheting spline box end is countersunk for easy application to the fastener.
- › Spline design was created for use with specialty spline bolts which are used when weight and size of bolt heads must be minimized.
- › Spline design enables the wrench to contact conventional fasteners away from the corners, which help apply force over a large area helping to reduce risk of fastener rounding.
- › Spline design also helps prevent rounding of corners and other fastener damage that could lead to Foreign Object Damage (FOD).
- › The fractional spline wrenches can be used on fractional 4, 6, 12 point and spline fasteners.
- › The high contact surface area which is away from fastener points enables turning of highly rounded fasteners.



Product #	Size (in)	Outside Head Width (in) (C)	Head Thickness (in) (D)	Head Thickness (in) (D1)	Overall Length (in)	Weight (lbs)
JSBV0709	7/32 x 9/32	11/16	1/8	1/8	4-1/2	0.08
JSBV0810	1/4 x 5/16	11/16	1/8	1/8	4-1/2	0.08
JSBV1214	3/8 x 7/16	7/8	1/8	1/8	5-15/16	0.12
JSBV1618	1/2 x 9/16	1	3/16	3/16	7-1/16	0.23
JSBV2022	5/8 x 11/16	1-3/16	3/16	3/16	7-7/8	0.35
JSBV2428	3/4 x 7/8	1-5/8	1/4	1/4	9-5/8	0.63
JSBV2630	13/16 x 15/16	1-13/16	1/4	1/4	10-1/4	0.84
JSBV3236	1 x 1-1/8	2-5/16	5/16	5/16	11-5/8	0.95

4 PIECE RATCHETING WRENCH ADAPTER SET

Product #: **JHA4S**

- › Full polish finish provides corrosion resistance and easy clean surfaces.
- › Converts ratcheting wrench into super-thin ratchets or ratcheting bit drivers.
- › Inserts into box end with a stable locking and release mechanism.
- › Converts:
 - › 3/8" Ratcheting Wrench to 1/4" Drive Bit Adapter
 - › 3/8" Ratcheting Wrench to 1/4" Drive Adapter
 - › 1/2" Ratcheting Wrench to 3/8" Drive Adapter
 - › 3/4" Ratcheting Wrench to 1/2" Drive Adapter
- › Weight (lbs): 0.21



4 PIECE METRIC RATCHETING WRENCH ADAPTER SET

METRIC

Product #: **JHAM4S**

- › Full polish finish provides corrosion resistance and easy clean surfaces.
- › Converts ratcheting wrench into super-thin ratchets or ratcheting bit drivers.
- › Inserts into box end with a stable locking and release mechanism.
- › Easy to read markings.
- › Converts:
 - › 10 mm Ratcheting Wrench to 1/4" Drive Bit Adapter
 - › 10 mm Ratcheting Wrench to 1/4" Drive Adapter
 - › 13 mm Ratcheting Wrench to 3/8" Drive Adapter
 - › 19 mm Ratcheting Wrench to 1/2" Drive Adapter
- › Weight (lbs): 0.22



5 PIECE OFFSET REVERSIBLE RATCHETING BOX WRENCH SET - 6 AND 12 POINT

Product #: **J1180A**

- › 25° offset box end helps keep shank clear of obstructions.
- › Shorter length for access to confined workspaces.
- › Reversing switch lever allows for easy changes in turning direction which helps improve speed.
- › Full polish finish on handle provides corrosion resistance and easy to clean surfaces.
- › 6 point box end allows for large wrench to fastener contact area which helps prevent rounding of the fastener.
- › 12 point box end allows for fine indexing, helping to improve speed and access.
- › Weight (lbs): 2.24

Contents	Size (in)	Point Count	Overall Length (in)
J1181-A	1/4 x 5/16	6	4-1/4
J1182-A	3/8 x 7/16	6	5-7/16
J1183-A	1/2 x 9/16	6	6-3/4
J1184-A	5/8 x 11/16	12	8
J1185-A	3/4 x 7/8	12	9-1/8
J25TR06C	Tool Roll		



7 PIECE METRIC OFFSET RATCHETING BOX WRENCH SET - 6 AND 12 POINT

METRIC

Product #: **J1180MA**

- › Full polish finish provides corrosion resistance and easy to clean surfaces.
- › 12 point box end allows for fine indexing, helping to improve speed and access. Fits 4, 6 and 12 point fasteners.
- › 6 point box end allows larger wrench to fastener contact area which helps prevent rounding of the fastener.
- › 25° offset box end helps keep shank clear of obstructions.
- › Reversing switch lever allows for easy changes in turning direction which helps improve speed.
- › Weight (lbs): 3.60

Contents	Size (mm)	Point Count	Overall Length (in)
J1181M-A	7 x 8	6	4-1/4
J1182M-A	9 x 10	6	5-7/16
J1183MA-A	11 x 13	6	6-3/4
J1184MA-A	12 x 14	6	6-3/4
J1185M-A	15 x 17	12	8
J1186M-A	16 x 18	12	8
J1187M-A	19 x 21	12	9-1/8
J25TR01C	Tool Roll		



OFFSET REVERSIBLE RATCHETING DOUBLE BOX WRENCHES - 6 POINT

- › 25° offset box end helps keep shank clear of obstructions.
- › Shorter length for access to confined workspaces.
- › Reversing switch lever allows for easy changes in turning direction which helps improve speed.
- › Full polish finish on handle provides corrosion resistance and easy to clean surfaces.
- › 6 point box end allows for large wrench to fastener contact area which helps prevent rounding of the fastener.



Product #	Size (in)	Outside Head Width (in) (C)	Head Thickness (in) (D)	Outside Head Width (in) (C1)	Head Thickness (in) (D1)	Overall Length (in)	Weight (lbs)
J1181-A	1/4 x 5/16	19/32	3/8	43/64	3/8	4-1/4	0.15
J1182-A	3/8 x 7/16	25/32	3/8	7/8	3/8	5-7/16	0.21
J1183-A	1/2 x 9/16	1	1/2	1-9/64	1/2	6-3/4	0.43

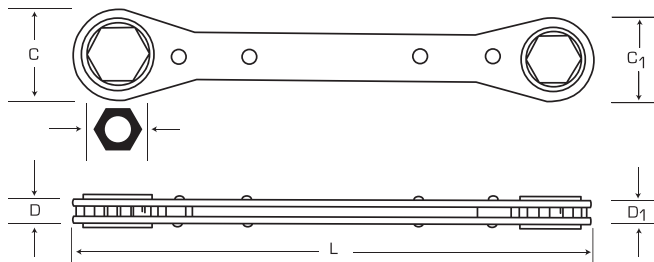

METRIC OFFSET REVERSIBLE RATCHETING DOUBLE BOX WRENCHES - 6 POINT

METRIC

- › Full polish finish provides corrosion resistance and easy to clean surfaces.
- › 25° offset box end helps keep shank clear of obstructions.
- › Shorter length for access to confined workspaces.
- › 6 point box end allows larger wrench to fastener contact area which helps prevent rounding of the fastener.
- › Reversing switch lever allows for easy changes in turning direction which helps improve speed.
- › The wrench self-aligns with the fastener.



Product #	Size (mm)	Outside Head Width (in) (C)	Head Thickness (in) (D)	Outside Head Width (in) (C1)	Head Thickness (in) (D1)	Overall Length (in)	Weight (lbs)
J1181M-A	7 x 8	19/32	3/8	43/64	3/8	4-1/4	0.13
J1182M-A	9 x 10	25/32	3/8	7/8	3/8	5-7/16	0.22
J1183MA-A	11 x 13	1-1/64	1/2	1-5/32	1/2	6-3/4	0.32
J1184MA-A	12 x 14	1-1/64	1/2	1-5/32	1/2	6-3/4	0.32



OFFSET REVERSIBLE RATCHETING DOUBLE BOX WRENCHES - 12 POINT

- › Full polish finish provides corrosion resistance and easy to clean surfaces.
- › 25° offset box end helps keep shank clear of obstructions for greater accessibility.
- › Shorter length for access to confined workspaces.
- › Reversing switch lever allows for easy changes in turning direction which helps improve speed.
- › 12 point box end allows for fine indexing.
- › Fits 4, 6 and 12 point fasteners.



Product #	Size (in)	Outside Head Width (in) (C)	Head Thickness (in) (D)	Outside Head Width (in) (C1)	Head Thickness (in) (D1)	Overall Length (in)	Weight (lbs)
J1179T	7/32 x 9/32	19/32	3/8	43/64	3/8	4-1/4	0.15
J1181T	1/4 x 5/16	19/32	3/8	41/64	3/8	4-1/4	0.15
J1182T	3/8 x 7/16	25/32	3/8	7/8	3/8	5-7/16	0.21
J1183T	1/2 x 9/16	1	1/2	1-9/64	1/2	6-3/4	0.43
J1184-A	5/8 x 11/16	1-19/64	1/2	1-7/16	1/2	8	0.58
J1185-A	3/4 x 7/8	1-13/32	1/2	1-9/16	1/2	9-1/8	0.77
J1186	5/8 x 3/4	1-19/64	1/2	1-7/16	1/2	8	0.58



METRIC OFFSET REVERSIBLE RATCHETING DOUBLE BOX WRENCHES - 12 POINT

METRIC

- › Full polish finish provides corrosion resistance and easy to clean surfaces.
- › Built in retaining ring in each ratchet wheel adds speed and convenience.
- › Shorter length for access to confined workspaces.
- › Reversing switch lever allows for easy changes in turning direction which helps improve speed.
- › The wrench self-aligns with the fastener.
- › 12 point box end allows for fine indexing.
- › Fits 4, 6 and 12 point fasteners.



Product #	Size (mm)	Outside Head Width (in) (C)	Head Thickness (in) (D)	Outside Head Width (in) (C1)	Head Thickness (in) (D1)	Overall Length (in)	Weight (lbs)
J1185M-A	15 x 17	1-19/64	1/2	1-7/16	1/2	8	0.46
J1186M-A	16 x 18	1-19/64	1/2	1-7/16	1/2	8	0.46
J1187M-A	19 x 21	1-13/32	1/2	1-37/64	1/2	9-1/8	0.52

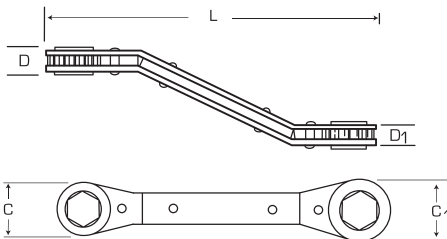

5 PIECE REVERSIBLE RATCHETING BOX WRENCH SET - 12 POINT

Product #: **J1190LO**

- › Full polish finish on handle provides corrosion resistance and easy to clean surfaces.
- › Built-in retaining ring in each ratchet wheel adds speed and convenience for greater accessibility.
- › Wrench self-aligns on the fastener which helps save time.
- › 12 point box end allows for fine indexing, helping improve speed and access.
- › Fits 4, 6 and 12 point fasteners.
- › Weight (lbs): 2.18

Contents	Size (in)	Point Count	Overall Length (in)
J1191LO	1/4 x 5/16	12	4-1/2
J1192LO	3/8 x 7/16	12	5-1/2
J1193LO	1/2 x 9/16	12	6-7/8
J1194LO	5/8 x 11/16	12	8-1/8
J1195LO	3/4 x 7/8	12	9-1/4
J25TR06C	Tool Roll		



5 PIECE METRIC REVERSIBLE RATCHETING BOX WRENCH SET - 12 POINT

METRIC

Product #: **J1190MLO**

- › Full polish finish provides corrosion resistance and easy to clean surfaces.
- › Built in retaining ring in each ratchet wheel adds speed and convenience for greater accessibility.
- › Shorter length for access to confined workspaces.
- › Reversing switch lever allows for easy changes in turning direction which helps improve speed.
- › The wrench self-aligns with the fastener.
- › 12 point box end allows for fine indexing.
- › Fits 4, 6 and 12 point fasteners.
- › Weight (lbs): 2.03

Contents	Size (mm)	Overall Length (in)
J1191MLO	7 x 8	4-1/2
J1192MLO	9 x 10	5-1/2
J1193MLO	11 x 12	6-7/8
J1194MLO	13 x 14	6-7/8
J1195MLO	15 x 17	8-1/8
J25TR06C	Tool Roll	



REVERSIBLE RATCHETING DOUBLE BOX WRENCHES - 12 POINT

- › Full polish finish provides corrosion resistance and easy to clean surfaces.
- › Built in retaining ring in each ratchet wheel adds speed and convenience.
- › Shorter length for access to confined workspaces.
- › Reversing switch lever allows for easy changes in turning direction which helps improve speed.
- › The wrench self-aligns with the fastener.
- › 12 point box end allows for fine indexing.
- › Fits 4, 6 and 12 point fasteners.

Product #	Size (in)	Overall Length	
		(in)	Weight (lbs)
J1191LO	1/4 x 5/16	4-1/2	0.15
J1192LO	3/8 x 7/16	5-1/2	0.21
J1193LO	1/2 x 9/16	6-7/8	0.31
J1194LO	5/8 x 11/16	8-1/8	0.58
J1195LO	3/4 x 7/8	9-1/4	0.67

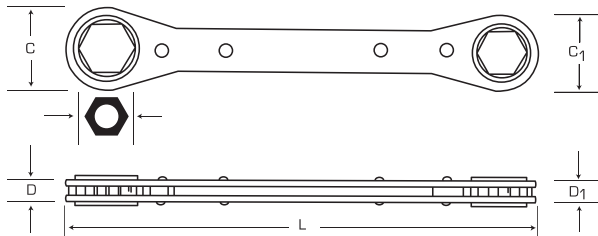

METRIC REVERSIBLE RATCHETING DOUBLE BOX WRENCHES - 12 POINT

- › Full polish finish provides corrosion resistance and easy to clean surfaces.
- › Built in retaining ring in each ratchet wheel adds speed and convenience for greater accessibility.
- › Shorter length for access to confined workspaces.
- › Reversing switch lever allows for easy changes in turning direction which helps improve speed.
- › The wrench self-aligns with the fastener.
- › 12 point box end allows for fine indexing.
- › Fits 4, 6 and 12 point fasteners.

METRIC

Product #	Size (mm)	Overall Length	
		(in)	Weight (lbs)
J1191MLO	7 x 8	4-1/2	0.16
J1192MLO	9 x 10	5-1/2	0.23
J1193MLO	11 x 12	6-7/8	0.33
J1194MLO	13 x 14	6-7/8	0.61
J1195MLO	15 x 17	8-1/8	0.7



5 PIECE METRIC RATCHETING BOX WRENCH SET - 6 AND 12 POINT

Product #: **J1190MA**

METRIC

- › Full polish finish provides corrosion resistance and easy to clean surfaces.
- › Shorter length for access to confined workspaces.
- › The wrench self-aligns with the fastener.
- › 6 point box end allows for a large wrench to fastener contact area which helps prevent fastener rounding.
- › 12 point box end allows for fine indexing.
- › Fits 4, 6 and 12 point fasteners.
- › Weight (lbs): 2.12

Contents	Size (mm)	Point Count	Overall Length (in)
J1191M-A	7 x 8	6	4-1/2
J1192M-A	9 x 10	6	5-1/2
J1193MA-A	11 x 13	6	6-7/8
J1194MA-A	12 x 14	6	6-7/8
J1195M-A	15 x 17	12	8-1/8
J25TR06C	Tool Roll		



WRENCHES



5 PIECE RATCHETING BOX WRENCH SET - 12 POINT

Product #: **J1190A**

- › Full polish finish provides corrosion resistance and easy to clean surfaces.
- › Shorter length for access to confined workspaces.
- › The wrench self-aligns with the fastener.
- › 12 point box end allows for fine indexing.
- › Fits 4, 6 and 12 point fasteners.
- › Weight (lbs): 1.72

Contents	Size (in)	Point Count	Overall Length (in)
J1191T-A	1/4 x 5/16	12	4-1/2
J1192T-A	3/8 x 7/16	12	5-1/2
J1193T-A	1/2 x 9/16	12	6-7/8
J1194-A	5/8 x 11/16	12	8-1/8
J1195-A	3/4 x 7/8	12	9-1/4
J25TR06C	Tool Roll		



RATCHETING

3 PIECE RATCHETING BOX WRENCH SET - 12 POINT

Product #: **J1190B**

- › Full polish finish provides corrosion resistance and easy to clean surfaces.
- › Built in retaining ring in each ratchet wheel adds speed and convenience for greater accessibility.
- › Shorter length for access to confined workspaces.
- › The wrench self-aligns with the fastener.
- › 12 point box end allows for fine indexing.
- › Fits 4, 6 and 12 point fasteners.
- › Weight (lbs): 1.10



Contents	Size (in)	Point Count	Overall Length (in)
J1192T-A	3/8 x 7/16	12	5-1/2
J1193T-A	1/2 x 9/16	12	6-7/8
J1194-A	5/8 x 11/16	12	8-1/8
J25TR17C	Tool Roll		

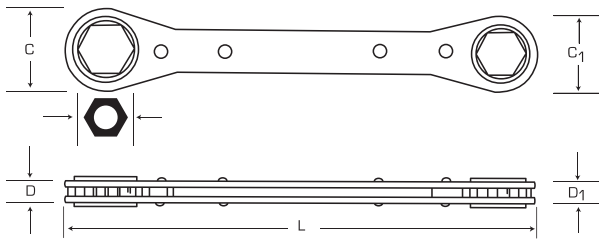

RATCHETING DOUBLE BOX WRENCHES - 6 POINT

- › Full polish finish provides corrosion resistance and easy to clean surfaces.
- › Shorter length for access to confined workspaces.
- › The wrench self-aligns with the fastener.
- › 6 point box end allows for large wrench to fastener contact area which helps prevent fastener rounding.



Product #	Size (in)	Outside Head Width (in) (C)	Head Thickness (in) (D)	Outside Head Width (in) (C1)	Head Thickness (in) (D1)	Overall Length (in)	Weight (lbs)
J1191-A	1/4 x 5/16	19/32	3/8	43/64	3/8	4-1/2	0.12
J1192-A	3/8 x 7/16	3/4	1/2	7/8	1/2	5-1/2	0.18
J1193-A	1/2 x 9/16	1	1/2	1-1/8	1/2	6-7/8	0.29



METRIC RATCHETING DOUBLE BOX WRENCHES - 6 POINT

METRIC

- › Full polish finish provides corrosion resistance and easy to clean surfaces.
- › Shorter length for access to confined workspaces.
- › The wrench self-aligns with the fastener.
- › 6 point box end allows for large wrench to fastener contact area which helps prevent fastener rounding.



Product #	Size (mm)	Outside Head Width (in) (C)	Head Thickness (in) (D)	Outside Head Width (in) (C1)	Head Thickness (in) (D1)	Overall Length (in)	Weight (lbs)
J1191M-A	7 x 8	19/32	3/8	43/64	3/8	4-1/2	0.12
J1192M-A	9 x 10	25/32	3/8	7/8	3/8	5-1/2	0.17
J1193MA-A	11 x 13	1-1/64	1/2	1-5/32	1/2	6-7/8	0.31
J1194MA-A	12 x 14	1-1/64	1/2	1-5/32	1/2	6-7/8	0.39



RATCHETING DOUBLE BOX WRENCHES - 12 POINT

- › Full polish finish provides corrosion resistance and easy to clean surfaces.
- › Shorter length for access to confined workspaces.
- › The wrench self-aligns with the fastener.
- › 12 point box end allows for fine indexing.
- › Fits 4, 6 and 12 point fasteners.



Product #	Size (in)	Outside Head Width (in) (C)	Head Thickness (in) (D)	Outside Head Width (in) (C1)	Head Thickness (in) (D1)	Overall Length (in)	Weight (lbs)
J1191T-A	1/4 x 5/16	9/32	3/8	43/64	3/8	4-1/2	0.12
J1192T-A	3/8 x 7/16	3/4	3/8	7/8	3/8	5-1/2	0.17
J1193T-A	1/2 x 9/16	1	1/2	1-1/8	1/2	6-7/8	0.29
J1194-A	5/8 x 11/16	1-19/64	1/2	1-7/16	1/2	8-1/8	0.44
J1195-A	3/4 x 7/8	1-13/32	1/2	1-37/64	1/2	9-1/4	0.52
J1196-A	5/8 x 3/4	1-19/64	1/2	1-7/16	1/2	8-1/8	0.47
J1197-A	13/16 x 15/16	1-13/32	1/2	1-37/64	1/2	9-1/4	0.52
J1198*	1-1/4 x 1-1/16	1-29/32	9/16	2-1/4	9/16	15	1.38
J1199*	1-1/16 x 1-1/4	1-29/32	9/16	2-1/4	9/16	15	1.38

* Reversible



METRIC RATCHETING DOUBLE BOX WRENCHES - 12 POINT



- › Full polish finish provides corrosion resistance and easy to clean surfaces.
- › Shorter length for access to confined workspaces.
- › The wrench self-aligns with the fastener.
- › 12 point box end allows for fine indexing and fits 4, 6 and 12 point fasteners.
- › Fits 4, 6 and 12 point fasteners.



Product #	Size (mm)	Outside Head Width (in) (C)	Head Thickness (in) (D)	Outside Head Width (in) (C1)	Head Thickness (in) (D1)	Overall Length (in)	Weight (lbs)
J1195M-A	15 x 17	1-19/64	1/2	1-7/16	1/2	8-7/64	0.48
J1196M	16 x 18	1-19/64	1/2	1-7/16	1/2	8-7/64	0.48
J1197M	19 x 21	1-13/32	1/2	1-37/64	1/2	9-15/64	0.55



REFRIGERATION WRENCHES

- › Full polish finish provides corrosion resistance and easy to clean surfaces.
- › Designed for servicing automotive, commercial, and residential air conditioners, refrigeration units and freezers.
- › Hex openings are used for packing gland fittings, mounting bolts, clutch bolts, tubing fittings, dust cap nuts and oil check plugs.
- › Square openings are used on male service valves, plug fittings, compressor valves and refrigerant charging tanks.
- › Reversing switch lever allows for easy changes in turning direction which helps improve speed.



Product #	Size	Size	Overall Length (in)	Weight (lbs)
J1111	1/4 x 3/16 Square	9/16 x 1/2 Hex	7	0.35
J1112	1/4 x 3/16 Square	1/4 x 3/16 Hex	5-1/2	0.25

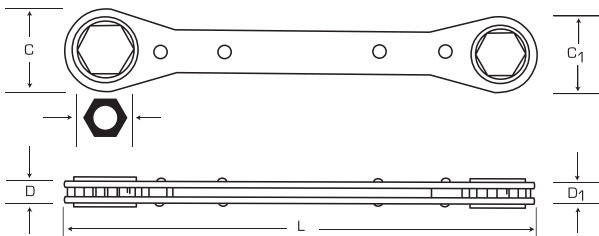

7 PIECE RATCHETING FLARE NUT WRENCH SET - 12 POINT

Product #: J3800A

- › Black oxide finish.
- › Non-reflective black oxide finish for use where non-plated products are required.
- › 12 Point flare nut box end allows for fine indexing, helping to improve speed and access.
- › Pivoting head allows user to place the wrench over the connected pipes to reach the fastener.
- › Weight (lbs): 1.93

Contents	Size (in)	Point Count	Overall Length (in)
J3812	3/8	12	5-7/16
J3814	7/16	12	5-7/16
J3816	1/2	12	5-7/16
J3818	9/16	12	7-1/4
J3820	5/8	12	7-1/4
J3822	11/16	12	7-1/4
J3824	3/4	12	7-1/4
J25TR03C	Tool Roll		



WRENCHES



RATCHETING FLARE NUT WRENCHES - 12 POINT

- › Black oxide finish.
- › Non-reflective black oxide finish for use where non-plated products are required.
- › 12 Point flare nut box end allows for fine indexing, helping to improve speed and access.
- › Pivoting head allows user to place the wrench over the connected pipes to reach the fastener.



Product #	Size (in)	Outside Head Width (in) (C)	Head Thickness (in) (D)	Overall Length (in)	Weight (lbs)
J3812	3/8	1	9/32	5-7/16	0.17
J3814	7/16	1	9/32	5-7/16	0.17
J3816	1/2	1	9/32	5-7/16	0.17
J3818	9/16	1-5/16	3/8	7-1/4	0.31
J3820	5/8	1-5/16	3/8	7-1/4	0.31
J3822	11/16	1-5/16	3/8	7-1/4	0.31
J3824	3/4	1-5/16	3/8	7-1/4	0.31
J3826	13/16	1-11/16	7/16	9-3/8	0.58
J3828	7/8	1-11/16	7/16	9-3/8	0.58
J3830	15/16	1-11/16	1/2	9-3/8	0.58
J3832	1	1-11/16	1/2	9-3/8	0.58

RATCHETING

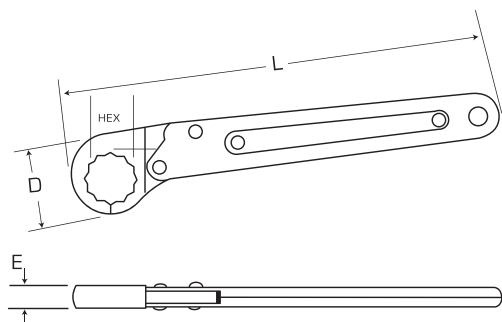

17 PIECE METRIC COMBINATION WRENCH SET - 12 POINT

METRIC

Product #: J1200RM-T500

- › Full polish finish provides corrosion resistance and easy to clean surfaces.
- › 12 point box end allows for fine indexing, helping to improve speed and access. Fits 4, 6 and 12 point fasteners.
- › Anti-Slip Design (ASD) open end. Metric sizes 9 mm and smaller do not have ASD feature.
- › Box ends incorporate the TorquePlus™ system.
- › Weight (lbs): 6.92



Contents	Size (mm)	Point Count	Overall Length (in)
J1207M-T500	7	12	5-5/32
J1208M-T500	8	12	5-13/32
J1209M-T500	9	12	5-21/32
J1210M-T500	10	12	5-29/32
J1211M-T500	11	12	6-29/32
J1212M-T500	12	12	7-45/64
J1213M-T500	13	12	7-29/32
J1214M-T500	14	12	8-13/16
J1215M-T500	15	12	9-5/32
J1216M-T500	16	12	9-35/64
J1217M-T500	17	12	10-9/32
J1218M-T500	18	12	10-11/16
J1219M-T500	19	12	11-1/32
J1220M-T500	20	12	11-27/64
J1221M-T500	21	12	11-13/16
J1222M-T500	22	12	12-17/32
J1224M-T500	24	12	13-5/16
J25TR36C	Tool Roll		



ASME B107.100



15 PIECE COMBINATION ASD WRENCH SET - 12 POINT

Product #: J1200F-T500

- › Full polish finish provides corrosion resistance and easy to clean surfaces.
- › 12 point box end allows for fine indexing, helping to improve speed and access. Fits 4, 6, and 12 point fasteners.
- › Anti-Slip Design (ASD) open end. Fractional sizes 1 1/32" and smaller do not have the ASD feature.
- › Box ends incorporate the TorquePlus™ system.
- › Weight (lbs): 9.76



Contents	Size (in)	Point Count	Overall Length (in)
J1210-T500	5/16	12	5-3/8
J1212-T500	3/8	12	6
J1214-T500	7/16	12	7
J1216-T500	1/2	12	8
J1218-T500	9/16	12	8-7/8
J1220-T500	5/8	12	9-1/2
J1222-T500	11/16	12	10-1/4
J1224-T500	3/4	12	11
J1226-T500	13/16	12	11-7/8
J1228-T500	7/8	12	12-1/2
J1230-T500	15/16	12	13-1/4
J1232-T500	1	12	14
J1234-T500	1-1/16	12	15-1/4
J1236-T500	1-1/8	12	15-7/8
J1240-T500	1-1/4	12	16-7/8
J25TR34C	Tool Roll		



ASME B107.100



7 PIECE COMBINATION ASD WRENCH SET - 12 POINT

Product #: **J1200H-T500**

- › Full polish finish provides corrosion resistance and easy to clean surfaces.
- › 12 point box end allows for fine indexing, helping to improve speed and access. Fits 4, 6, and 12 point fasteners.
- › Anti-Slip Design (ASD) open end.
- › Box ends incorporate the TorquePlus™ system.
- › Weight (lbs): 2.02



Contents	Size (in)	Point Count	Overall Length (in)
J1212-T500	3/8	12	6
J1214-T500	7/16	12	7
J1216-T500	1/2	12	8
J1218-T500	9/16	12	8-7/8
J1220-T500	5/8	12	9-1/2
J1222-T500	11/16	12	10-1/4
J1224-T500	3/4	12	11
J25TR33C	Tool Roll		

ASME B107.100



FEATURES AND BENEFITS — ANTI-SLIP DESIGN (ASD)

The Anti-Slip Design consists of two features:

- › A notch to lock the fastener in place.
- › A curve for greater contact area against the fastener.

An ASD Wrench does not apply load to the corners of the fastener, so it helps to prevent rounding. Because of the greater surface contact, the wrench can also successfully apply greater torque without slipping.

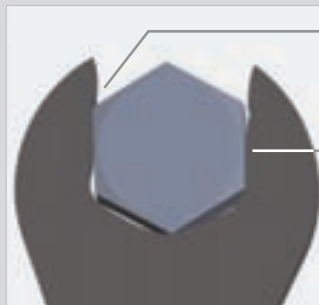

The groove locks the fastener in place.

The curved edge grips the flat of the bolt for a better grip and less rounding.

9 PIECE METRIC COMBINATION WRENCH SET - 12 POINT

METRIC

Product #: **J1200HM-T500**

- › Full polish finish provides corrosion resistance and easy to clean surfaces.
- › 12 point box end allows for fine indexing, helping to improve speed and access. Fits 4, 6 and 12 point fasteners.
- › Anti-Slip Design (ASD) open end. Metric sizes 9 mm and smaller do not have ASD feature.
- › Box ends incorporate the TorquePlus™ system.
- › Weight (lbs): 1.62



Contents	Size (mm)	Point Count	Overall Length (in)
J1207M-T500	7	12	5-5/32
J1208M-T500	8	12	5-13/32
J1209M-T500	9	12	5-21/32
J1210M-T500	10	12	5-29/32
J1211M-T500	11	12	6-29/32
J1212M-T500	12	12	7-45/64
J1213M-T500	13	12	7-29/32
J1214M-T500	14	12	8-13/16
J1215M-T500	15	12	9-5/32
J25TR35C	Tool Roll		

ASME B107.100



FULL POLISH COMBINATION WRENCHES - 6 POINT

Delayed Availability

- › Full polish finish provides corrosion resistance and easy to clean surfaces.
- › 6 point box end allows for large wrench to fastener contact area which helps prevent rounding of the fastener.
- › Anti-Slip Design (ASD) open end. Fractional sizes 11/32" and smaller do not have the ASD feature.
- › Box ends incorporate the TorquePlus™ system.



Product #	Size (in)	Throat Depth (in) (B)	Outside Head Width (in) (C)	Head Thickness (in) (D)	Outside Head Width (in) (C1)	Head Thickness (in) (D1)	Overall Length (in)	Weight (lbs)
J1208H-T500	1/4	19/64	39/64	5/32	27/64	15/64	4-59/64	0.04
J1210H-T500	5/16	3/8	45/64	13/64	33/64	17/64	5-7/16	0.08
J1211H-T500	11/32	13/32	25/32	21/32	17/32	7/32	5-43/64	0.08
J1212H-T500	3/8	13/32	13/16	1/4	39/64	5/16	5-29/32	0.10
J1214H-T500	7/16	17/32	15/16	17/64	43/64	21/64	6-29/32	0.14
J1216H-T500	1/2	39/64	1-5/64	21/64	49/64	11/32	7-29/32	0.20
J1218H-T500	9/16	11/16	1-3/16	11/32	27/32	23/64	8-13/16	0.27
J1220H-T500	5/8	3/4	1-21/64	25/64	15/16	13/32	9-35/64	0.35
J1222H-T500	11/16	13/16	1-29/64	27/64	1-1/64	7/16	10-19/64	0.38
J1224H-T500	3/4	57/64	1-37/64	31/64	1-3/32	15/32	11-3/64	0.52
J1226H-T500	13/16	31/32	1-11/16	33/64	1-11/64	1/2	11-13/16	0.54
J1228H-T500	7/8	1-1/16	1-13/16	35/64	1-1/4	33/64	12-35/64	0.65
J1230H-T500	15/16	1-1/8	1-29/32	39/64	1-27/64	37/64	13-5/16	0.74
J1232H-T500	1	1-13/64	2-1/64	21/32	1-13/32	37/64	14-1/16	0.95
J1234H-T500	1-1/16	1-9/32	2-9/64	45/64	1-31/64	39/64	15-1/4	1.13
J1236H-T500	1-1/8	1-23/64	2-17/64	3/4	1-21/32	41/64	15-7/8	1.38
J1238H-T500	1-3/16	1-23/64	2-25/64	3/4	1-21/32	21/32	15-7/8	1.54
J1240H-T500	1-1/4	1-1/2	2-33/64	53/64	1-3/4	45/64	16-59/64	1.89

ASME B107.100

FULL POLISH METRIC COMBINATION WRENCHES - 6 POINT



Delayed Availability

- › Full polish finish provides corrosion resistance and easy to clean surfaces.
- › 6 point box end allows for large wrench to fastener contact area which helps prevent rounding of the fastener.
- › Anti-Slip Design (ASD) open end. Metric sizes 9 mm and smaller do not have ASD feature.
- › Box ends incorporate the TorquePlus™ system.



Product #	Size (mm)	Throat Depth (in) (B)	Outside Head Width (in) (C)	Head Thickness (in) (D)	Outside Head Width (in) (C1)	Head Thickness (in) (D1)	Overall Length (in)	Weight (lbs)
J1206MH-T500	6	19/64	35/64	5/32	25/64	5/32	4-59/64	0.04
J1207MH-T500	7	5/16	19/32	3/16	13/32	15/64	5-11/64	0.04
J1208MH-T500	8	25/64	11/16	13/64	1/2	17/64	5-7/16	0.07
J1209MH-T500	9	13/32	3/4	7/32	35/64	17/64	5-43/64	0.08
J1210MH-T500	10	31/64	7/8	1/4	21/32	5/16	5-29/32	0.13
J1211MH-T500	11	33/64	59/64	17/64	11/16	21/64	6-29/32	0.14
J1212MH-T500	12	9/16	1	19/64	47/64	11/32	7-23/32	0.17
J1213MH-T500	13	39/64	1-1/32	21/64	25/32	11/32	7-29/32	0.18
J1214MH-T500	14	11/16	1-3/16	11/32	55/64	23/64	8-13/16	0.22
J1215MH-T500	15	3/4	1-1/4	3/8	7/8	23/64	9-9/64	0.25
J1216MH-T500	16	3/4	1-21/64	25/64	15/16	13/32	9-35/64	0.26
J1217MH-T500	17	53/64	1-25/64	27/64	1-1/32	7/16	10-19/64	0.38
J1218MH-T500	18	55/64	1-33/64	29/64	1-1/16	29/64	10-11/16	0.41
J1219MH-T500	19	29/32	1-37/64	31/64	1-7/64	15/32	11-3/64	0.46

ASME B107.100



FULL POLISH COMBINATION WRENCHES - 12 POINT

- › Full polish finish provides corrosion resistance and easy to clean surfaces.
- › 12 point box end allows for fine indexing, helping to improve speed and access. Fits 4, 6, and 12 point fasteners.
- › Anti-Slip Design (ASD) open end.
- › Fractional sizes 11/32" and smaller do not have the ASD feature.
- › Box ends incorporate the TorquePlus™ system.



Product #	Size (in)	Throat	Outside Head	Head	Outside Head	Head	Overall Length (in)	Weight (lbs)
		Depth (in) (B)	Width (in) (C)	Thickness (in) (D)	Width (in) (C1)	Thickness (in) (D1)		
J1208-T500	1/4	19/64	39/64	3/16	27/64	15/64	4-7/8	0.04
J1209-T500	9/32	23/64	41/64	3/16	29/64	7/32	5-5/32	0.06
J1210-T500	5/16	3/8	45/64	3/16	33/64	17/64	5-3/8	0.08
J1211-T500	11/32	13/32	25/32	3/16	17/32	7/32	5-5/8	0.08
J1212-T500	3/8	13/32	13/16	3/16	39/64	5/16	6	0.10
J1214-T500	7/16	17/32	15/16	15/64	43/64	21/64	7	0.14
J1216-T500	1/2	39/64	1-5/64	1/4	49/64	11/32	8	0.20
J1218-T500	9/16	11/16	1-3/16	9/32	27/32	23/64	8-7/8	0.27
J1220-T500	5/8	3/4	1-21/64	19/64	15/16	13/32	9-1/2	0.35
J1222-T500	11/16	13/16	1-29/64	5/16	1-1/64	7/16	10-1/4	0.38
J1224-T500	3/4	57/64	1-37/64	11/32	1-3/32	15/32	11	0.52
J1226-T500	13/16	31/32	1-11/16	23/64	1-11/64	1/2	11-7/8	0.54
J1228-T500	7/8	1-1/16	1-13/16	3/8	1-1/4	33/64	12-1/2	0.65
J1230-T500	15/16	1-1/8	1-29/32	13/32	1-27/64	37/64	13-1/4	0.74
J1232-T500	1	1-13/64	2-1/64	13/32	1-13/32	37/64	14	0.95
J1234-T500	1-1/16	1-9/32	2-9/64	29/64	1-31/64	39/64	15-1/4	1.13
J1236-T500	1-1/8	1-23/64	2-17/64	15/32	1-21/32	41/64	15-7/8	1.38
J1240-T500	1-1/4	1-1/2	2-33/64	33/64	1-3/4	45/64	16-7/8	1.89



ASME B107.100

FULL POLISH METRIC COMBINATION WRENCHES - 12 POINT

METRIC

- › Full polish finish provides corrosion resistance and easy to clean surfaces.
- › 12 point box end allows for fine indexing, helping to improve speed and access. Fits 4, 6 and 12 point fasteners.
- › Anti-Slip Design (ASD) open end.
- › Metric sizes 9 mm and smaller do not have ASD feature.
- › Box ends incorporate the TorquePlus™ system.



Product #	Size (mm)	Throat	Outside Head	Head	Outside Head	Head	Overall Length (in)	Weight (lbs)
		Depth (in) (B)	Width (in) (C)	Thickness (in) (D)	Width (in) (C1)	Thickness (in) (D1)		
J1207M-T500	7	5/16	19/32	11/64	13/32	15/64	5-5/32	0.04
J1208M-T500	8	25/64	11/16	3/16	1/2	17/64	5-13/32	0.07
J1209M-T500	9	13/32	3/4	3/16	35/64	17/64	5-21/32	0.08
J1210M-T500	10	31/64	7/8	7/32	21/32	5/16	5-29/32	0.13
J1211M-T500	11	33/64	59/64	15/64	11/16	21/64	6-29/32	0.14
J1212M-T500	12	9/16	1	1/4	47/64	11/32	7-45/64	0.17
J1213M-T500	13	39/64	1-1/32	1/4	25/32	11/32	7-29/32	0.18
J1214M-T500	14	11/16	1-3/16	9/32	55/64	23/64	8-13/16	0.22
J1215M-T500	15	3/4	1-1/4	19/64	7/8	23/64	9-5/32	0.25
J1216M-T500	16	3/4	1-21/64	5/16	15/16	13/32	9-35/64	0.26
J1217M-T500	17	53/64	1-25/64	21/64	1-1/32	7/16	10-9/32	0.38
J1218M-T500	18	55/64	1-33/64	11/32	1-1/16	29/64	10-11/16	0.41
J1219M-T500	19	29/32	1-37/64	11/32	1-7/64	15/32	11-1/32	0.46
J1220M-T500	20	63/64	1-11/16	23/64	1-3/16	31/64	11-27/64	0.55
J1221M-T500	21	63/64	1-11/16	23/64	1-3/16	31/64	11-13/16	0.54
J1222M-T500	22	1-3/64	1-25/32	3/8	1-17/64	1/2	12-17/32	0.62
J1224M-T500	24	1-1/8	1-57/64	13/32	1-11/32	35/64	13-5/16	0.77



ASME B107.100

FULL POLISH COMBINATION WRENCHES - SPLINE

- › Proto® Spline Tools are designed to service high tensile strength fasteners used widely on military and commercial aircraft and in heavy machinery applications where vibration is prevalent. They are also used in automotive and industrial areas where high performance torque needs to be achieved.
- › Spline fasteners help tighten high strength bolts to high torque loads.
- › They help lower the force required to turn standard fasteners by allowing the torque load to be moved away from the corners, helping prevent fastener rounding. They also turn fasteners with damaged corners.
- › Spline helps reduce foreign object debris (FOD) by having a precise fit between the fastening tool and its fastener.
- › Full polish finish provides corrosion resistance and an easy to clean surface.
- › Anti-Slip Design (ASD) open end.
- › Fractional sizes 11/32" and smaller do not have the ASD feature.



Product #	Size (in)	Throat Depth (in) (B)	Outside Head Width (in) (C)	Head Thickness (in) (D)	Outside Head Width (in) (C1)	Head Thickness (in) (D1)	Overall Length (in)	Weight (lbs)
J1208SPL	1/4	17/64	35/64	5/32	25/64	11/64	4-29/32	0.06
J1209SPL	9/32	19/64	39/64	11/64	7/16	11/64	5-5/32	0.07
J1210SPL	5/16	21/64	11/16	11/64	31/64	3/16	5-27/64	0.08
J1211SPL	11/32	23/64	25/32	3/16	35/64	7/32	5-21/32	0.09
J1212SPL	3/8	13/32	27/32	13/64	37/64	15/64	5-59/62	0.10
J1214SPL	7/16	15/32	15/16	7/32	43/64	17/64	6-29/32	0.14
J1216SPL	1/2	17/32	1-5/64	1/4	47/64	5/16	7-29/32	0.20
J1218SPL	9/16	19/32	1-13/64	9/32	13/16	11/32	8-53/64	0.26
J1220SPL	5/8	43/64	1-21/64	19/64	57/64	3/8	9-35/64	0.34
J1222SPL	11/16	47/64	1-7/16	5/16	63/64	13/32	10-19/64	0.42
J1224SPL	3/4	51/64	1-37/64	11/32	1-5/64	15/32	11-3/64	0.50
J1226SPL	13/16	55/64	1-23/32	23/64	1-3/16	33/64	11-53/64	0.59
J1228SPL	7/8	15/16	1-27/32	3/8	1-1/4	17/32	12-17/32	0.73
J1230SPL	15/16	1	1-31/32	25/64	1-23/64	37/64	13-5/16	0.90
J1232SPL	1	1-1/16	2-3/32	27/64	1-29/64	37/64	14-1/16	1.10

FEATURES AND BENEFITS — A SPLINE END FITS MANY TYPES OF FASTENERS

Spline End Wrenches are versatile tools that handle several types of fasteners better than conventional wrenches.

- › One Spline End wrench can replace many because the innovative spline end can grab and turn several types of fasteners.
- › The contact points for spline end sockets are always away from the corners of the fastener. This design, by its nature, reduces the problem of rounding.
- › The same grip also turns previously-rounded fasteners better, because the splines grip the head along the flat edge.

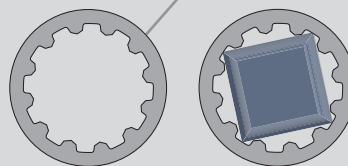

One wrench replaces many wrenches.

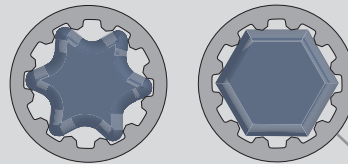

A better grip on rounded fasteners.

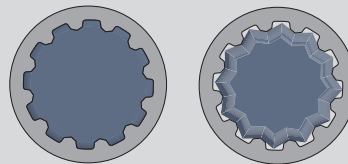

31 PIECE COMBINATION ASD WRENCH SET - 12 POINT

Product #: **J1200-90ASD**

Contents	Size (in)	Point Count	Overall Length (in)
J1210A	5/16	12	5-3/8
J1212ASD	3/8	12	6
J1214ASD	7/16	12	7
J1216ASD	1/2	12	8
J1218ASD	9/16	12	8-7/8
J1220ASD	5/8	12	9-1/2
J1222ASD	11/16	12	10-1/4
J1224ASD	3/4	12	11
J1226ASD	13/16	12	11-7/8
J1228ASD	7/8	12	12-1/2
J1230ASD	15/16	12	13-1/4
J1232ASD	1	12	14
J1234ASD	1-1/16	12	15-1/4
J1236ASD	1-1/8	12	15-7/8
J1240ASD	1-1/4	12	16-7/8
J1242	1-5/16	12	17-5/8
J1244	1-3/8	12	18-1/2
J1246	1-7/16	12	19-3/8
J1248	1-1/2	12	20-1/4
J1252	1-5/8	12	23
J1254	1-11/16	12	23
J1256	1-3/4	12	25
J1258	1-13/16	12	25
J1260	1-7/8	12	28
J1264	2	12	28
J1266	2-1/16	12	29-1/2
J1268	2-1/8	12	29-1/2
J1270	2-3/16	12	29-1/2
J1272	2-1/4	12	29-1/2
J1276	2-3/8	12	31-1/2
J1280	2-1/2	12	31-1/2
J25TR34C	Tool Roll		

 ASME B107.100

- › Satin finish provides corrosion resistance and a slip-resistant grip.
- › 12 point box end allows for fine indexing, helping to improve speed and access. Fits 4, 6 and 12 point fasteners.
- › Anti-Slip Design (ASD) open end. Fractional sizes 11/32" and smaller and 1-15/16" and larger do not have the ASD feature.
- › Box ends incorporate the TorquePlus™ system.
- › Weight (lbs): 124



FEATURES AND BENEFITS — ANTI-SLIP DESIGN (ASD)

The Anti-Slip Design consists of two features:

- › A notch to lock the fastener in place.
- › A curve for greater contact area against the fastener.

An ASD Wrench does not apply load to the corners of the fastener, so it helps to prevent rounding. Because of the greater surface contact, the wrench can also successfully apply greater torque without slipping.

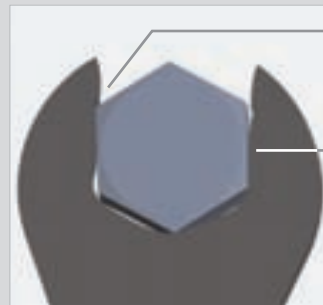

The groove locks the fastener in place.

The curved edge grips the flat of the bolt for a better grip and less rounding.

26 PIECE COMBINATION ASD WRENCH SET - 12 POINT

Product #: **J1200-80ASD**

Contents	Size (in)	Point Count	Overall Length (in)
J1208A	1/4	12	4-7/8
J1210A	5/16	12	5-3/8
J1212ASD	3/8	12	6
J1214ASD	7/16	12	7
J1216ASD	1/2	12	8
J1218ASD	9/16	12	8-7/8
J1220ASD	5/8	12	9-1/2
J1222ASD	11/16	12	10-1/4
J1224ASD	3/4	12	11
J1226ASD	13/16	12	11-7/8
J1228ASD	7/8	12	12-1/2
J1230ASD	15/16	12	13-1/4
J1232ASD	1	12	14
J1234ASD	1-1/16	12	15-1/4
J1236ASD	1-1/8	12	15-7/8
J1240ASD	1-1/4	12	16-7/8
J1242	1-5/16	12	17-5/8
J1244	1-3/8	12	18-1/2
J1246	1-7/16	12	19-3/8
J1248	1-1/2	12	20-1/4
J1252	1-5/8	12	23
J1254	1-11/16	12	23
J1256	1-3/4	12	25
J1258	1-13/16	12	25
J1260	1-7/8	12	28
J1264	2	12	28



ASME B107.100

- › Satin finish provides corrosion resistance and a slip-resistant grip.
- › 12 point box end allows for fine indexing, helping to improve speed and access. Fits 4, 6 and 12 point fasteners.
- › Anti-Slip Design (ASD) open end. Fractional sizes 11/32" and smaller and sizes 1-5/16" and larger do not have the ASD feature.
- › Box ends incorporate the TorquePlus™ system.
- › Weight (lbs): 57.42



PRODUCT FEATURES AND BENEFITS —



- › High performance drive configuration allows for quick and easy socket engagement to the fastener flats, not the corners.
- › Employs a radius-corner design, shifting contact area and stress away from the fastener corners and distributing contact stresses over a large area of the socket, minimizing slippage.
- › The internal design minimizes fastener rounding, helps to extend fastener life, and allows the user to more easily turn worn, rounded, or rusted fasteners.

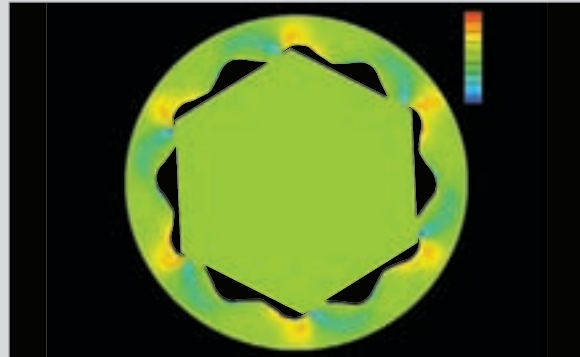

18 PIECE METRIC COMBINATION ASD WRENCH SET - 12 POINT METRIC

Product #: J1200R-MASD

Contents	Size (mm)	Point Count	Overall Length (in)
J1207MA	7	12	5-5/32
J1208MA	8	12	5-13/32
J1209MA	9	12	5-21/32
J1210MASD	10	12	5-29/32
J1211MASD	11	12	6-29/32
J1212MASD	12	12	7-45/64
J1213MASD	13	12	7-29/32
J1214MASD	14	12	8-13/16
J1215MASD	15	12	9-5/32
J1216MASD	16	12	9-35/64
J1217MASD	17	12	10-9/32
J1218MASD	18	12	10-11/16
J1219MASD	19	12	11-1/32
J1220MASD	20	12	11-27/64
J1221MASD	21	12	11-13/16
J1222MASD	22	12	12-17/32
J1223MASD	23	12	12-59/64
J1224MASD	24	12	13-5/16
J25TR42C	Tool Roll		

 ASME B107.100

- › Satin finish provides corrosion resistance and a slip-resistant grip.
- › 12 point box end allows for fine indexing, helping to improve speed and access. Fits 4, 6 and 12 point fasteners.
- › Anti-Slip Design (ASD) open end. Metric sizes 9 mm and smaller do not have ASD feature.
- › Box ends incorporate the TorquePlus™ system.
- › Weight (lbs): 8.1



16 PIECE COMBINATION WRENCH SET - 12 POINT

Product #: J1200F-HD

Contents	Size (in)	Point Count	Overall Length (in)
J1242	1-5/16	12	17-5/8
J1244	1-3/8	12	18-1/2
J1246	1-7/16	12	19-3/8
J1248	1-1/2	12	20-1/4
J1252	1-5/8	12	23
J1254	1-11/16	12	23
J1256	1-3/4	12	25
J1258	1-13/16	12	25
J1260	1-7/8	12	28
J1264	2	12	28
J1266	2-1/16	12	29-1/2
J1268	2-1/8	12	29-1/2
J1270	2-3/16	12	29-1/2
J1272	2-1/4	12	29-1/2
J1276	2-3/8	12	31-1/2
J1280	2-1/2	12	31-1/2

 ASME B107.100

- › Satin finish provides corrosion resistance and a slip-resistant grip.
- › 12 point box end allows for fine indexing, helping to improve speed and access. Fits 4, 6 and 12 point fasteners.
- › 15° angled offset box end helps keep shank clear of obstructions.
- › The box end is countersunk for easy application to the fastener.
- › Box ends incorporate the TorquePlus™ system.
- › Weight (lbs): 113.5



15 PIECE COMBINATION ASD WRENCH SET - 12 POINT

Product #: **J1200FASD**

Contents	Size (in)	Point Count	Overall Length (in)
J1210A	5/16	12	5-3/8
J1212ASD	3/8	12	6
J1214ASD	7/16	12	7
J1216ASD	1/2	12	8
J1218ASD	9/16	12	8-7/8
J1220ASD	5/8	12	9-1/2
J1222ASD	11/16	12	10-1/4
J1224ASD	3/4	12	11
J1226ASD	13/16	12	11-7/8
J1228ASD	7/8	12	12-1/2
J1230ASD	15/16	12	13-1/4
J1232ASD	1	12	14
J1234ASD	1-1/16	12	15-1/4
J1236ASD	1-1/8	12	15-7/8
J1240ASD	1-1/4	12	16-7/8
J25TR34C	Tool Roll		

ASME B107.100

- › Satin finish provides corrosion resistance and a slip-resistant grip.
- › 12 point box end allows for fine indexing, helping to improve speed and access. Fits 4, 6 and 12 point fasteners.
- › Anti-Slip Design (ASD) open end. Fractional sizes 11/32" and smaller do not have the ASD feature.
- › Box ends incorporate the TorquePlus™ system.
- › Weight (lbs): 9.75



15 PIECE METRIC COMBINATION ASD WRENCH SET - 12 POINT **M**ETRIC

Product #: **J1200F-MASD**

Contents	Size (mm)	Point Count	Overall Length (in)
J1207MA	7	12	5-5/32
J1208MA	8	12	5-13/32
J1209MA	9	12	5-21/32
J1210MASD	10	12	5-29/32
J1211MASD	11	12	6-29/32
J1212MASD	12	12	7-45/64
J1213MASD	13	12	7-29/32
J1214MASD	14	12	8-13/16
J1215MASD	15	12	9-5/32
J1216MASD	16	12	9-35/64
J1217MASD	17	12	10-9/32
J1218MASD	18	12	10-11/16
J1219MASD	19	12	11-1/32
J1220MASD	20	12	11-27/64
J1221MASD	21	12	11-13/16
J25TR41C	Tool Roll		

ASME B107.100

- › Satin finish provides corrosion resistance and a slip-resistant grip.
- › 12 point box end allows for fine indexing, helping to improve speed and access. Fits 4, 6 and 12 point fasteners.
- › Anti-Slip Design (ASD) open end. Metric sizes 9 mm and smaller do not have ASD feature.
- › Box ends incorporate the TorquePlus™ system.
- › Weight (lbs): 4.25



15 PIECE METRIC COMBINATION ASD WRENCH SET - 12 POINT METRIC

Product #: J1200P-MASD

Contents	Size (mm)	Point Count	Overall Length (in)
J1207MA	7	12	5-5/32
J1208MA	8	12	5-13/32
J1210MASD	10	12	5-29/32
J1212MASD	12	12	7-45/64
J1214MASD	14	12	8-13/16
J1216MASD	16	12	9-35/64
J1218MASD	18	12	10-11/16
J1220MASD	20	12	11-27/64
J1222MASD	22	12	12-17/32
J1224MASD	24	12	13-5/16
J1226MASD	26	12	14-41/64
J1228MASD	28	12	15-35/64
J1229MASD	29	12	15-55/64
J1230MASD	30	12	15-55/64
J1232MASD	32	12	16-59/64
J25TR41C	Tool Roll		

 ASME B107.100

- › Satin finish provides corrosion resistance and a slip-resistant grip.
- › 12 point box end allows for fine indexing, helping to improve speed and access. Fits 4, 6 and 12 point fasteners.
- › Anti-Slip Design (ASD) open end. Metric sizes 9 mm and smaller do not have ASD feature.
- › Box ends incorporate the TorquePlus™ system.
- › Weight (lbs): 4.25



10 PIECE COMBINATION ASD WRENCH SET - 12 POINT

Product #: J1200GASD

Contents	Size (in)	Point Count	Overall Length (in)
J1214ASD	7/16	12	7
J1216ASD	1/2	12	8
J1218ASD	9/16	12	8-7/8
J1220ASD	5/8	12	9-1/2
J1222ASD	11/16	12	10-1/4
J1224ASD	3/4	12	11
J1226ASD	13/16	12	11-7/8
J1228ASD	7/8	12	12-1/2
J1230ASD	15/16	12	13-1/4
J1232ASD	1	12	14
J25TR05C	Tool Roll		

 ASME B107.100

- › Satin finish provides corrosion resistance and a slip-resistant grip.
- › 12 point box end allows for fine indexing, helping to improve speed and access. Fits 4, 6 and 12 point fasteners.
- › Anti-Slip Design (ASD) open end.
- › Box ends incorporate the TorquePlus™ system.
- › Weight (lbs): 4.88



10 PIECE METRIC COMBINATION ASD WRENCH SET - 12 POINT METRIC

Product #: J1200K-MASD

Contents	Size (mm)	Point Count	Overall Length (in)
J1210MASD	10	12	5-29/32
J1211MASD	11	12	6-29/32
J1212MASD	12	12	7-45/64
J1213MASD	13	12	7-29/32
J1214MASD	14	12	8-13/16
J1215MASD	15	12	9-5/32
J1216MASD	16	12	9-35/64
J1217MASD	17	12	10-9/32
J1218MASD	18	12	10-11/16
J1219MASD	19	12	11-1/32
J25TR39C	Tool Roll		

 ASME B107.100

- › Satin finish provides corrosion resistance and a slip-resistant grip.
- › 12 point box end allows for fine indexing, helping to improve speed and access. Fits 4, 6 and 12 point fasteners.
- › Anti-Slip Design (ASD) open end.
- › Box ends incorporate the TorquePlus™ system.
- › Weight (lbs): 2.71



10 PIECE COMBINATION ASD WRENCH SET - 6 POINT

Product #: **J1200GHASD**

Contents	Size (in)	Point Count	Overall Length (in)
J1214HASD	7/16	6	7
J1216HASD	1/2	6	8
J1218HASD	9/16	6	8-7/8
J1220HASD	5/8	6	9-1/2
J1222HASD	11/16	6	10-1/4
J1224HASD	3/4	6	11
J1226HASD	13/16	6	11-7/8
J1228HASD	7/8	6	12-1/2
J1230HASD	15/16	6	13-1/4
J1232HASD	1	6	14
J25TR05C	Tool Roll		

ASME B107.100

- › Satin finish provides corrosion resistance and a slip-resistant grip.
- › 6 point box end allows for large wrench to fastener contact area which helps prevent rounding of the fastener.
- › Anti-Slip Design (ASD) open end.
- › Box ends incorporate the TorquePlus™ system.
- › Weight (lbs): 4.88



10 PIECE METRIC COMBINATION ASD WRENCH SET - 6 POINT METRIC

Product #: **J1200MHASD**

Contents	Size (mm)	Point Count	Overall Length (in)
J1210MHASD	10	6	5-29/32
J1211MHASD	11	6	6-29/32
J1212MHASD	12	6	7-45/64
J1213MHASD	13	6	7-29/32
J1214MHASD	14	6	8-13/16
J1215MHASD	15	6	9-5/32
J1216MHASD	16	6	9-35/64
J1217MHASD	17	6	10-9/32
J1218MHASD	18	6	10-11/16
J1219MHASD	19	6	11-1/32
J25TR39C	Tool Roll		

ASME B107.100

- › Satin finish provides corrosion resistance and a slip-resistant grip.
- › 6 point box end allows for large wrench to fastener contact area which helps prevent rounding of the fastener.
- › Anti-Slip Design (ASD) open end.
- › Box ends incorporate the TorquePlus™ system.
- › Weight (lbs): 3.46



9 PIECE METRIC COMBINATION ASD WRENCH SET - 12 POINT METRIC

Product #: **J1200H-MASD**

Contents	Size (mm)	Point Count	Overall Length (in)
J1207MA	7	12	5-5/32
J1208MA	8	12	5-13/32
J1209MA	9	12	5-21/32
J1210MASD	10	12	5-29/32
J1211MASD	11	12	6-29/32
J1212MASD	12	12	7-45/64
J1213MASD	13	12	7-29/32
J1214MASD	14	12	8-13/16
J1215MASD	15	12	9-5/32
J25TR38C	Tool Roll		

ASME B107.100

- › Satin finish provides corrosion resistance and a slip-resistant grip.
- › 12 point box end allows for fine indexing, helping to improve speed and access. Fits 4, 6 and 12 point fasteners.
- › Anti-Slip Design (ASD) open end. Metric sizes 9 mm and smaller do not have ASD feature.
- › Box ends incorporate the TorquePlus™ system.
- › Weight (lbs): 1.43



8 PIECE SHORT COMBINATION WRENCH SET - 6 POINT

Product #: **J1200EF**

Contents	Size (in)	Point Count	Overall Length (in)
J1204EF	1/8	6	2-49/64
J1205EF	5/32	6	2-57/64
J1206EF	3/16	6	3-1/4
J1208EF	1/4	6	3-17/64
J1209EF	9/32	6	3-7/16
J1210EF	5/16	6	4-1/8
J1211EF	11/32	6	4-7/16
J1212EF	3/8	6	4-5/8
J25TR12C	Tool Roll		

ASME B107.100

- › Satin finish provides corrosion resistance and a slip-resistant grip.
- › 6 point box end allows for large wrench to fastener contact area which helps prevent rounding of the fastener.
- › Compact shank design and short length for access in confined spaces.
- › 15° angled offset box end helps keep shank clear of obstructions.
- › Standard open end.
- › Weight (lbs): 0.35



7 PIECE COMBINATION ASD WRENCH SET - 12 POINT

Product #: **J1200HASD**

Contents	Size (in)	Point Count	Overall Length (in)
J1212ASD	3/8	12	6
J1214ASD	7/16	12	7
J1216ASD	1/2	12	8
J1218ASD	9/16	12	8-7/8
J1220ASD	5/8	12	9-1/2
J1222ASD	11/16	12	10-1/4
J1224ASD	3/4	12	11
J25TR37C	Tool Roll		



ASME B107.100

- › Satin finish provides corrosion resistance and a slip-resistant grip.
- › 12 point box end allows for fine indexing, helping to improve speed and access. Fits 4, 6 and 12 point fasteners.
- › Anti-Slip Design (ASD) open end.
- › Box ends incorporate the TorquePlus™ system.
- › Weight (lbs): 2.40



FACOM® 16 PIECE METRIC COMBINATION SHORT WRENCH SET

Product #: **FM-39.JE16T**

Contents	Size (mm)	Point Count	Overall Length (in)
FM-39.3.2H	3.2	6	3-1/32
FM-39.4H	4	6	3-1/32
FM-39.5H	5	6	3-7/32
FM-39.5.5H	5.5	6	3-5/16
FM-39.6	6	12	3-17/32
FM-39.7	7	12	3-17/32
FM-39.8	8	12	3-19/32
FM-39.9	9	12	3-27-32
FM-39.10	10	12	4-1/16
FM-39.11	11	12	4-9/32
FM-39.12	12	12	5
FM-39.13	13	12	5-9/16
FM-39.14	14	12	5-25/32
FM-39.15	15	12	5-31/32
FM-39.16	16	12	6-7/32
FM-39.17	17	12	6-1/2

- › Short shank and compact heads help improve access to tight spots.
- › Box end angled at 15°.
- › 12 point box end allows for fine indexing, helping to improve speed and access.
- › 6 point box end allows for large wrench to fastener contact area which helps prevent rounding the fastener.
- › Fits 4, 6 and 12 point fasteners.
- › Satin finish provides corrosion resistance and a slip-resistant grip.
- › Weight (lbs): 1.58



SATIN COMBINATION WRENCHES - 6 POINT

- › Satin finish provides corrosion resistance and a slip-resistant grip.
- › 6 point box end allows for large wrench to fastener contact area which helps prevent rounding of the fastener.
- › Fractional sizes 11/32" and smaller and sizes 1-5/16" and larger do not have the ASD feature.
- › Box ends incorporate the TorquePlus™ system.



Product #	Size (in)	Throat		Outside Head		Head		Overall Length (in)	Weight (lbs)
		Depth (in) (B)	Width (in) (C)	Thickness (in) (D)	Width (in) (C1)	Thickness (in) (D1)			
J1208HA	1/4	19/64	39/64	3/16	27/64	15/64	4-7/8	0.04	
J1210HA	5/16	5/16	45/64	3/16	33/64	17/64	5-3/8	0.08	
J1211HA	11/32	11/32	25/32	3/16	17/32	7/32	5-5/8	0.08	
J1212HASD	3/8	13/32	13/16	3/16	39/64	5/16	6	0.10	
J1214HASD	7/16	17/32	15/16	15/64	43/64	21/64	7	0.14	
J1216HASD	1/2	39/64	1-5/64	1/4	49/64	11/32	8	0.18	
J1218HASD	9/16	11/16	1-3/16	9/32	27/32	23/64	8-7/8	0.21	
J1220HASD	5/8	3/4	1-21/64	19/64	15/16	13/32	9-1/2	0.29	
J1222HASD	11/16	13/16	1-29/64	5/16	1-1/64	7/16	10-1/4	0.35	
J1224HASD	3/4	57/64	1-37/64	11/32	1-3/32	15/32	11	0.41	
J1226HASD	13/16	31/32	1-11/16	23/64	1-11/64	1/2	11-7/8	0.54	
J1228HASD	7/8	1-1/16	1-13/16	3/8	1-1/4	33/64	12-1/2	0.64	
J1230HASD	15/16	1-1/8	1-29/32	13/32	1-27/64	37/64	13-1/4	0.74	
J1232HASD	1	1-13/64	2-1/64	13/32	1-13/32	37/64	14	0.95	
J1234HASD	1-1/16	1-9/32	2-9/64	45/64	1-31/64	39/64	15-1/4	1.13	
J1236HASD	1-1/8	1-23/64	2-17/64	3/4	1-21/32	41/64	15-7/8	1.38	
J1238HASD	1-3/16	1-23/64	2-25/64	3/4	1-21/32	21/32	15-7/8	1.54	
J1240HASD	1-1/4	1-1/2	2-33/64	53/64	1-3/4	45/64	16-59/64	1.89	

ASME B107.100

SATIN METRIC COMBINATION WRENCHES - 6 POINT

METRIC

- › Satin finish provides corrosion resistance and a slip-resistant grip.
- › 6 point box end allows for large wrench to fastener contact area which helps prevent rounding of the fastener.
- › Anti-Slip Design (ASD) open end.
- › Metric Sizes 9 mm and smaller do not have ASD feature.
- › Box ends incorporate the TorquePlus™ system.



Product #	Size (mm)	Throat		Outside Head		Head		Overall Length (in)	Weight (lbs)
		Depth (in) (B)	Width (in) (C)	Thickness (in) (D)	Width (in) (C1)	Thickness (in) (D1)			
J1206MHA	6	19/64	35/64	5/32	25/64	5/32	4-59/64	0.05	
J1207MHA	7	19/64	39/64	11/64	7/16	3/16	4-53/64	0.06	
J1208MHA	8	3/8	11/16	11/64	31/64	13/64	5-13/32	0.07	
J1209MHA	9	13/32	49/64	3/16	17/32	7/32	5-21/32	0.08	
J1210MHASD	10	31/64	7/8	7/32	41/64	5/16	5-29/32	0.13	
J1211MHASD	11	17/32	59/64	15/64	11/16	21/64	6-29/32	0.14	
J1212MHASD	12	9/16	1	1/4	47/64	21/64	7-45/64	0.17	
J1213MHASD	13	39/64	1-1/32	11/32	25/32	1/4	7-29/32	0.18	
J1214MHASD	14	11/16	1-3/16	9/32	55/64	23/64	8-13/16	0.22	
J1215MHASD	15	3/4	1-1/4	19/64	57/64	23/64	9-5/32	0.25	
J1216MHASD	16	49/64	1-21/64	5/16	15/16	13/32	9-35/64	0.26	
J1217MHASD	17	53/64	1-29/64	21/64	1-1/32	7/16	10-9/32	0.38	
J1218MHASD	18	55/64	1-33/64	11/32	1-5/64	7/16	10-11/16	0.41	
J1219MHASD	19	29/32	1-37/64	11/32	1-7/64	31/64	11-1/32	0.46	

ASME B107.100



SATIN COMBINATION WRENCHES - 12 POINT

- › Satin finish provides corrosion resistance and a slip-resistant grip.
- › 12 point box end allows for fine indexing, helping to improve speed and access. Fits 4, 6 and 12 point fasteners.
- › Anti-Slip Design (ASD) open end.
- › Fractional sizes 11/32" and smaller and sizes 1-5/16" and larger do not have the ASD feature.
- › Box ends incorporate the TorquePlus™ system.



Product #	Size (in)	Throat Depth (in) (B)	Outside Head Width (in) (C)	Head Thickness (in) (D)	Outside Head Width (in) (C1)	Head Thickness (in) (D1)	Overall Length (in)	Weight (lbs)
J1208A	1/4	19/64	39/64	3/16	27/64	15/64	4-7/8	0.04
J1209A	9/32	23/64	41/64	3/16	29/64	7/32	5-5/32	0.06
J1210A	5/16	3/8	45/64	3/16	33/64	17/64	5-3/8	0.08
J1211A	11/32	13/32	25/32	3/16	17/32	7/32	5-5/8	0.08
J1212ASD	3/8	13/32	13/16	3/16	39/64	5/16	6	0.11
J1214ASD	7/16	17/32	15/16	15/64	43/64	21/64	7	0.14
J1216ASD	1/2	39/64	1-5/16	1/4	49/64	11/32	8	0.18
J1218ASD	9/16	11/16	1-3/16	9/32	3/4	23/64	8-7/8	0.21
J1220ASD	5/8	3/4	1-21/64	19/64	15/16	13/32	9-1/2	0.29
J1222ASD	11/16	13/16	1-29/64	5/16	1-1/64	7/16	10-1/4	0.35
J1224ASD	3/4	57/64	1-37/64	11/32	1-3/32	15/32	11	0.41
J1226ASD	13/16	31/32	1-11/16	23/64	1-11/64	1/2	11-7/8	0.54
J1228ASD	7/8	1-1/16	1-13/16	3/8	1-1/4	33/64	12-1/2	0.65
J1230ASD	15/16	1-1/8	1-29/32	13/32	1-27/64	37/64	13-1/4	0.74
J1232ASD	1	1-13/64	2-1/64	13/32	1-13/32	37/64	14	0.95
J1234ASD	1-1/16	1-9/32	2-9/64	29/64	1-31/64	39/64	15-1/4	1.13
J1236ASD	1-1/8	1-23/64	2-17/64	15/32	1-21/32	41/64	15-7/8	1.38
J1238ASD	1-3/16	1-23/64	2-25/64	3/4	1-21/32	21/32	15-7/8	1.54
J1240ASD	1-1/4	1-1/2	2-33/64	33/64	1-3/4	45/64	16-7/8	1.89
J1242	1-5/16	1-37/64	2-41/64	17/32	1-27/32	47/64	17-5/8	2.15
J1244	1-3/8	1-21/32	2-49/64	35/64	1-15/16	25/32	18-1/2	2.34
J1246	1-7/16	1-47/64	2-57/64	37/64	2-3/64	51/64	19-3/8	2.67
J1248	1-1/2	1-51/64	3-1/64	39/64	2-1/8	53/64	20-1/4	3.18
J1252	1-5/8	1-63/64	3-25/64	21/32	2-13/32	29/32	23	4.64
J1254	1-11/16	1-63/64	3-25/64	21/32	2-13/32	29/32	23	4.74
J1256	1-3/4	2-11/64	3-41/64	45/64	2-39/64	31/32	25	5.64
J1258	1-13/16	2-11/64	3-41/64	45/64	2-39/64	31/32	25	5.64
J1260	1-7/8	2-25/64	4-1/64	49/64	2-57/64	1-1/16	28	7.46
J1264	2	2-25/64	4-1/64	49/64	2-57/64	11/16	28	7.35
J1266	2-1/16	2-45/64	4-33/64	27/32	3-1/4	13/16	29-1/2	9.88
J1268	2-1/8	2-45/64	4-33/64	27/32	3-1/4	13/16	29-1/2	9.74
J1270	2-3/16	2-45/64	4-33/64	27/32	3-1/4	1-3/16	29-1/2	9.45
J1272	2-1/4	2-45/64	4-33/64	27/32	3-1/4	1-3/16	29-1/2	8.25
J1276	2-3/8	2-55/64	5	31/32	3-5/8	1-5/16	31-1/2	13.12
J1280	2-1/2	3	5	31/32	3-5/8	1-5/16	31-1/2	12.49

See pages 595 and 598 for larger sizes.



AS 954

ASME B107.100

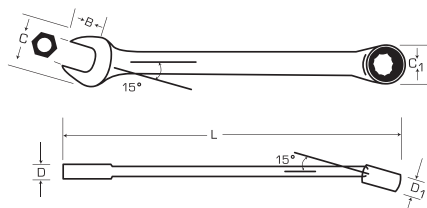

SATIN METRIC COMBINATION WRENCHES - 12 POINT



- › Satin finish provides corrosion resistance and a slip-resistant grip.
- › 12 point box end allows for fine indexing, helping to improve speed and access. Fits 4, 6 and 12 point fasteners.
- › Anti-Slip Design (ASD) open end.
- › Metric sizes 9 mm and smaller and sizes 36 mm and larger do not have the ASD feature.
- › Box ends incorporate the TorquePlus™ system.



Product #	Size (mm)	Throat Depth (in) (B)	Outside Head Width (in) (C)	Head Thickness (in) (D)	Outside Head Width (in) (C1)	Head Thickness (in) (D1)	Overall Length (in)	Weight (lbs)
J1206MA	6	19/64	35/64	5/32	25/64	5/32	4-29/32	0.05
J1207MA	7	5/16	19/32	11/64	13/32	15/64	5-5/32	0.06
J1208MA	8	25/64	11/16	3/16	1/2	17/64	5-13/32	0.07
J1209MA	9	13/32	3/4	3/16	35/64	17/64	5-21/32	0.08
J1210MASD	10	31/64	7/8	7/32	21/32	5/16	5-29/32	0.11
J1211MASD	11	33/64	59/64	15/64	11/16	21/64	6-29/32	0.15
J1212MASD	12	9/16	1	1/4	47/64	11/32	7-45/64	0.18
J1213MASD	13	39/64	1-1/32	1/4	25/32	11/32	7-29/32	0.21
J1214MASD	14	11/16	1-3/16	9/32	55/64	23/64	8-13/16	0.29
J1215MASD	15	3/4	1-1/4	19/64	7/8	23/64	9-5/32	0.25
J1216MASD	16	3/4	1-21/64	5/16	15/16	13/32	9-35/64	0.26
J1217MASD	17	53/64	1-25/64	21/64	1-1/32	7/16	10-9/32	0.38
J1218MASD	18	55/64	1-33/64	11/32	1-1/16	29/64	10-11/16	0.41
J1219MASD	19	29/32	1-37/64	11/32	1-7/64	15/32	11-1/32	0.46
J1220MASD	20	63/64	1-11/16	23/64	1-3/16	31/64	11-27/64	0.55
J1221MASD	21	63/64	1-11/16	23/64	1-3/16	31/64	11-13/16	0.54
J1222MASD	22	1-3/64	1-25/32	3/8	1-17/64	1/2	12-17/32	0.62
J1223MASD	23	1-1/8	1-57/64	13/32	1-11/32	35/64	12-59/64	0.77
J1224MASD	24	1-1/8	1-57/64	13/32	1-11/32	35/64	13-5/16	0.77
J1225MASD	25	1-13/64	2	27/64	1-27/64	19/32	14-1/16	0.85
J1226MASD	26	1-13/64	2-1/64	27/64	1-27/64	19/32	14-41/64	0.97
J1227MASD	27	1-7/32	2-9/64	29/64	1-31/64	39/64	15-15/64	1.17
J1228MASD	28	1-23/64	2-17/64	15/32	1-21/32	41/64	15-35/64	1.37
J1229MASD	29	1-23/64	2-17/64	15/32	1-21/32	41/64	15-55/64	1.39
J1230MASD	30	1-23/64	2-17/64	15/32	1-21/32	41/64	15-55/64	1.41
J1232MASD	32	1-1/2	2-33/64	33/64	1-49/64	45/64	16-59/64	1.82
J1236M	36	1-47/64	2-57/64	17/32	2-3/64	51/64	19-3/8	2.77
J1241M	41	2-1/64	3-25/64	41/64	2-27/64	59/64	23	4.34
J1246M	46	2-11/64	3-41/64	43/64	2-39/64	31/32	25	5.5
J1250M	50	2-25/64	4-1/64	47/64	2-57/64	1-1/16	28	6.97

See pages 595 and 599 for larger sizes.



ASME B107.100

PRODUCT FEATURES AND BENEFITS —



- › High performance drive configuration allows for quick and easy socket engagement to the fastener flats, not the corners.
- › Employs a radius-corner design, shifting contact area and stress away from the fastener corners and distributing contact stresses over a large area of the socket, minimizing slippage.
- › The internal design minimizes fastener rounding, helps to extend fastener life, and allows the user to more easily turn worn, rounded, or rusted fasteners.

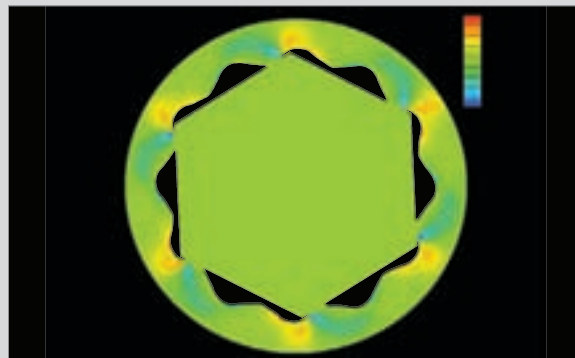

SHORT SATIN COMBINATION WRENCHES - 6 POINT

- › Satin finish provides corrosion resistance and a slip-resistant grip.
- › 6 point box end allows for large wrench to fastener contact area which helps prevent rounding of the fastener.
- › Compact shank design and short length for access in confined spaces.
- › 15° angled offset box end helps keep shank clear of obstructions.
- › Standard open end.



Product #	Size (in)	Throat Depth (in) (B)	Outside Head Width (in) (C)	Head Thickness (in) (D)	Outside Head Width (in) (C1)	Head Thickness (in) (D1)	Overall Length (in)	Weight (lbs)
J1204EF	1/8	11/64	11/32	1/8	9/32	1/8	2-49/64	0.01
J1205EF	5/32	13/64	13/32	1/8	19/64	1/8	2-57/64	0.01
J1206EF	3/16	15/64	15/32	1/8	11/32	5/32	3-1/4	0.02
J1207EF	7/32	1/4	1/8	1/8	3/8	5/32	3-1/8	0.02
J1208EF	1/4	19/64	9/16	5/32	27/64	3/16	3-17/64	0.03
J1209EF	9/32	21/64	5/8	5/32	7/16	3/16	3-7/16	0.04
J1210EF	5/16	3/8	11/16	5/32	1/2	1/4	4-1/8	0.04
J1211EF	11/32	25/64	47/64	3/16	17/32	1/4	4-7/16	0.05
J1212EF	3/8	7/16	53/64	3/16	37/64	1/4	4-5/8	0.07
J1214EF	7/16	33/64	7/8	7/32	5/8	9/32	5-1/16	0.12
J1216EF	1/2	19/32	1	7/32	3/4	5/16	5-1/4	0.16
J1218EF	9/16	43/64	1-1/8	1/4	51/64	11/32	5-7/8	0.16
J1220EF	5/8	47/64	1-17/64	9/32	57/64	3/8	6-3/16	0.17

ASME B107.100

FACOM® SHORT SATIN METRIC COMBINATION WRENCHES - 6 POINT

- › Short shank and compact heads help improve access to tight spots.
- › Box end angled at 15°.
- › Satin finish provides corrosion resistance and a slip-resistant grip.



Product #	Size (mm)	Outside Head Width (in) (C)	Head Thickness (in) (D)	Outside Head Width (in) (C1)	Head Thickness (in) (D1)	Overall Length (in)	Weight (lbs)
FM-39.3.2H	3.2	25/64	1/8	9/32	1/8	3-1/32	0.02
FM-39.4H	4	25/64	1/8	5/16	1/8	3-1/32	0.01
FM-39.5H	5	15/32	5/32	23/64	5/32	3-7/32	0.02
FM-39.5.5H	5.5	15/32	5/32	3/8	5/32	3-5/16	0.02

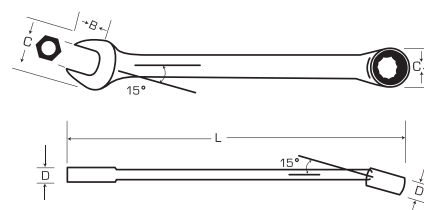

SHORT SATIN COMBINATION WRENCHES - 12 POINT

- › Satin finish provides corrosion resistance and a slip-resistant grip.
- › 12 point box end allows for fine indexing, helping to improve speed and access. Fits 4, 6 and 12 point fasteners.
- › Compact shank design and short length for access in confined spaces.
- › 15° angled offset box end helps keep shank clear of obstructions.
- › Standard open end.



Product #	Size (in)	Throat Depth (in) (B)	Outside Head Width (in) (C)	Head Thickness (in) (D)	Outside Head Width (in) (C1)	Head Thickness (in) (D1)	Overall Length (in)	Weight (lbs)
J1208TF	1/4	19/64	17/32	1/8	25/64	5/16	3-1/4	0.02
J1209TF	9/32	21/64	5/8	5/32	7/16	3/16	3-7/16	0.04
J1210TF	5/16	3/8	41/64	3/16	5/32	7/32	3-1/2	0.04
J1211TF	11/32	25/64	47/64	3/16	17/32	1/4	4-7/16	0.05
J1212TF	3/8	7/16	3/4	13/64	35/64	1/4	4-5/8	0.07
J1214TF	7/16	33/64	7/8	15/64	5/8	17/64	5-1/16	0.10
J1216TF	1/2	19/32	1	1/4	23/64	19/64	5-11/16	0.11
J1218TF	9/16	43/64	1-1/8	9/32	51/64	21/64	5-13/16	0.16
J1220TF	5/8	47/64	1-17/64	23/64	57/64	11/32	6-3/16	0.18
J1222TF	11/16	13/16	1-25/64	11/32	31/32	3/8	7-1/16	0.23
J1224TF	3/4	57/64	1-33/64	3/8	1-3/64	13/32	8-1/16	0.33

ASME B107.100

FACOM® SHORT SATIN METRIC COMBINATION WRENCHES - 12 POINT



- › Short shank and compact heads help improve access to tight spots.
- › Box end angled at 15°.
- › 12 point box end allows for fine indexing, helping to improve speed and access.
- › Fits 4, 6 and 12 point fasteners.
- › Satin finish provides corrosion resistance and a slip-resistant grip.



Product #	Size (mm)	Outside Head Width (in) (C)	Head Thickness (in) (D)	Outside Head Width (in) (C1)	Head Thickness (in) (D1)	Overall Length (in)	Weight (lbs)
FM-39.6	6	19/32	5/32	13/32	13/64	3-17/32	0.04
FM-39.7	7	19/32	5/32	29/64	13/64	3-17/32	0.03
FM-39.8	8	43/64	11/64	31/64	15/64	3-19/32	0.04
FM-39.9	9	49/64	3/16	35/64	15/64	3-27/32	0.05
FM-39.10	10	27/32	13/64	39/64	1/4	4-1/16	0.06
FM-39.11	11	15/16	13/64	21/32	17/64	4-9/32	0.08
FM-39.12	12	1-1/32	7/32	45/64	19/64	5	0.1
FM-39.13	13	1-7/64	15/64	49/64	5/16	5-9/16	0.12
FM-39.14	14	1-3/16	15/64	13/16	21/64	5-25/32	0.15
FM-39.15	15	1-17/64	1/4	7/8	23/64	5-31/32	0.17
FM-39.16	16	1-23/64	17/64	59/64	3/8	6-7/32	0.19
FM-39.17	17	1-7/16	17/64	63/64	25/64	6-1/2	0.23

SATIN X-LARGE COMBINATION WRENCHES - 12 POINT

- › Satin finish provides corrosion resistance and a slip-resistant grip.
- › For use on extra large fasteners.
- › Used in Mining, Oil and Gas, Industrial Construction.
- › Forged heads with machined openings.
- › 12 point box end allows for fine indexing, helping to improve speed and access. Fits 4, 6 and 12 point.
- › Box end is countersunk for easy application to the fastener.



Product #	Size (in)	Outside Head Width (in) (C)	Outside Head Width (in) (C1)	Head Thickness (in) (D1)	Overall Length (in)	Weight (lbs)
J1282	2-9/16	4-1/2	3-5/8	1-9/16	29-3/4	13
J1284	2-9/16	4-3/4	3-3/4	1-5/8	29-3/4	13
J1288	2-3/4	4-3/4	3-3/4	1-5/8	29-3/4	13



SATIN X-LARGE METRIC COMBINATION WRENCHES - 12 POINT

METRIC

- › Satin finish provides corrosion resistance and a slip-resistant grip.
- › For use on extra large fasteners.
- › Used in Mining, Oil and Gas, Industrial Construction.
- › Forged heads with machined openings.
- › 12 point box end allows for fine indexing, helping to improve speed and access. Fits 4, 6 and 12 point.
- › Box end is countersunk for easy application to the fastener.



Product #	Size (mm)	Outside Head Width (in) (C)	Outside Head Width (in) (C1)	Head Thickness (in) (D1)	Overall Length (in)	Weight (lbs)
J1255M	55	4-1/4	3-1/4	1-3/16	28-3/4	10
J1260M	60	4-1/2	3-5/8	1-9/16	29-3/4	13
J1265M	65	4-1/2	3-5/8	1-9/16	29-3/4	13
J1270M	70	4-3/4	3-3/4	1-5/8	29-3/4	13



15 PIECE METRIC BLACK OXIDE COMBINATION ASD WRENCH SET - 12 POINT

METRIC

Product #: **J1200F-MBASD**

Contents	Size (mm)	Point Count	Overall Length (in)
J1207MBA	7	12	5-5/32
J1208MBA	8	12	5-13/32
J1209MBA	9	12	5-21/32
J1210MBASD	10	12	5-29/32
J1211MBASD	11	12	6-29/32
J1212MBASD	12	12	7-45/64
J1213MBASD	13	12	7-29/32
J1214MBASD	14	12	8-13/16
J1215MBASD	15	12	9-5/32
J1216MBASD	16	12	9-35/64
J1217MBASD	17	12	10-9/32
J1218MBASD	18	12	10-11/16
J1219MBASD	19	12	11-1/32
J1220MBASD	20	12	11-27/64
J1221MBASD	21	12	11-13/16
J25TR40C	Tool Roll		



ASME B107.100

- ▶ Non-reflective black oxide finish for use where non-plated products are required.
- ▶ 12 point box end allows for fine indexing, helping to improve speed and access. Fits 4, 6 and 12 point fasteners.
- ▶ Anti-Slip Design (ASD) open end. Metric sizes 9 mm and smaller do not have ASD feature.
- ▶ Box ends incorporate the TorquePlus™ system.
- ▶ Weight (lbs): 5.10

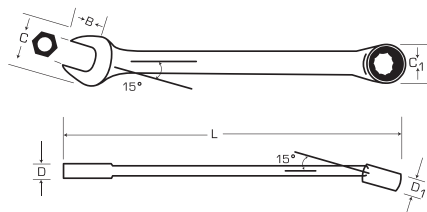

FEATURES AND BENEFITS – ANTI-SLIP DESIGN

Wrenches with the Anti-Slip Design (ASD) apply force to the flat sides of the fasteners, and not the corners. This feature helps to prevent rounding, and permits higher torques.

14 PIECE BLACK OXIDE COMBINATION ASD WRENCH SET - 12 POINT

Product #: **J1200FBASD**

Contents	Size (in)	Point Count	Overall Length (in)
J1212BASD	3/8	12	6
J1214BASD	7/16	12	7
J1216BASD	1/2	12	8-7/8
J1218BASD	9/16	12	8-7/8
J1220BASD	5/8	12	9-1/2
J1222BASD	11/16	12	10-1/4
J1224BASD	3/4	12	11
J1226BASD	13/16	12	11-7/8
J1228BASD	7/8	12	12-1/2
J1230BASD	15/16	12	13-1/4
J1232BASD	1	12	14
J1234BASD	1-1/16	12	15-1/4
J1238BASD	1-1/8	12	15-7/8
J1240BASD	1-1/4	12	16-7/8
J25TR41C	Tool Roll		



ASME B107.100

- ▶ Non-reflective black oxide finish for use where non-plated products are required.
- ▶ 12 point box end allows for fine indexing, helping to improve speed and access. Fits 4, 6 and 12 point fasteners.
- ▶ Anti-Slip Design (ASD) open end.
- ▶ Box ends incorporate the TorquePlus™ system.
- ▶ Weight (lbs): 9.70



7 PIECE BLACK OXIDE COMBINATION ASD WRENCH SET - 12 POINT

Product #: J1200HBASD

- › Non-reflective black oxide finish for use where non-plated products are required.
- › 12 point box end allows for fine indexing, helping to improve speed and access. Fits 4, 6 and 12 point fasteners.
- › Anti-Slip Design (ASD) open end.
- › Box ends incorporate the TorquePlus™ system.
- › Weight (lbs): 2.25



Contents	Size (in)	Point Count	Overall Length (in)
J1212BASD	3/8	12	6
J1214BASD	7/16	12	7
J1216BASD	1/2	12	8-7/8
J1218BASD	9/16	12	8-7/8
J1220BASD	5/8	12	9-1/2
J1222BASD	11/16	12	10-1/4
J1224BASD	3/4	12	11
J25TR37C	Tool Roll		

ASME B107.100



BLACK OXIDE COMBINATION WRENCHES - 12 POINT

- › Non-reflective black oxide finish for use where non-plated products are required.
- › 12 point box end allows for fine indexing, helping to improve speed and access. Fits 4, 6 and 12 point fasteners.
- › The box end is countersunk for easy application to the fastener.
- › 15° angled offset box end helps keep shank clear of obstructions.
- › Anti-Slip Design (ASD) open end.
- › Sizes 1-5/16" and larger do not have ASD feature.
- › Box ends incorporate the TorquePlus™ system.



Product #	Size (in)	Throat Depth (in) (B)	Outside Head Width (in) (C)	Head Thickness (in) (D)	Outside Head Width (in) (C1)	Head Thickness (in) (D1)	Overall Length (in)	Weight (lbs)
J1212BASD	3/8	27/64	13/16	7/32	39/64	5/16	6	0.10
J1214BASD	7/16	17/32	15/16	1/4	43/64	21/64	7	0.22
J1216BASD	1/2	39/64	1-5/64	17/64	49/64	11/32	8-7/8	0.26
J1218BASD	9/16	11/16	1-3/16	19/64	27/32	23/64	8-7/8	0.21
J1220BASD	5/8	3/4	1-21/64	5/16	15/16	13/32	9-1/2	0.29
J1222BASD	11/16	13/16	1-29/64	11/32	1-1/4	7/16	10-1/4	0.35
J1224BASD	3/4	57/64	1-37/64	23/64	1-3/32	15/32	11	0.41
J1226BASD	13/16	31/32	1-11/16	3/8	1-11/64	1/2	11-7/8	0.54
J1228BASD	7/8	1-1/16	1-13/16	13/32	1-1/4	17/32	12-1/2	0.64
J1230BASD	15/16	1-1/8	1-29/32	1/8	1-11/32	9/16	13-1/4	0.74
J1232BASD	1	1-13/64	2-1/64	29/64	1-13/32	19/32	14	0.95
J1234BASD	1-1/16	1-9/32	2-9/64	15/32	1-31/64	5/8	15-1/4	1.13
J1236BASD	1-1/8	1-23/64	2-17/64	33/64	1-21/32	41/64	15-7/8	1.38
J1240BASD	1-1/4	1-1/2	2-33/64	17/32	1-3/4	45/64	16-7/8	1.89
J1242B	1-5/16	1-37/64	2-41/64	17/32	2-1/8	47/64	17-5/8	2.15
J1244B	1-3/8	1-21/32	2-49/64	35/64	1-15/76	25/32	18-1/2	2.34
J1246B	1-7/16	1-47/64	2-57/64	37/64	23/64	51/64	19-3/8	2.67
J1248B	1-1/2	1-3/4	3	5/8	2-1/8	53/64	20-1/8	2.15
J1252B	1-5/8	1-63/64	3-25/64	21/32	2-13/32	29/32	23	4.64
J1254B	1-11/16	1-63/64	3-25/64	21/32	2-13/32	29/32	23	4.74
J1256B	1-3/4	1-3/4	3-41/64	45/64	2-39//64	31/32	25	5.64
J1258B	1-13/16	1-13/16	3-41/64	45/64	2-39//64	31/32	25	5.59
J1260B	1-7/8	1-7/8	4-1/64	49/64	2-57/64	1-1/16	28	7.46
J1264B	2	2	4-1/64	49/64	2-57/64	1-1/16	28	7.35

See pages 595 and 598 for larger sizes.



AS 954

ASME B107.100

BLACK OXIDE METRIC COMBINATION WRENCHES - 12 POINT



- › Non-reflective black oxide finish for use where non-plated products are required.
- › 12 point box end allows for fine indexing, helping to improve speed and access. Fits 4, 6 and 12 point fasteners.
- › The box end is countersunk for easy application to the fastener.
- › 15° angled offset box end helps keep shank clear of obstructions.
- › Anti-Slip Design (ASD) open end.
- › Inch sizes 1-5/16" and larger do not have ASD feature.
- › Box ends incorporate the TorquePlus™ system.



Product #	Size (mm)	Throat Depth (in) (B)	Outside Head Width (in) (C)	Head Thickness (in) (D)	Outside Head Width (in) (C1)	Head Thickness (in) (D1)	Overall Length (in)	Weight (lbs)
J1207MBA	7	5/16	37/64	3/16	27/64	13/64	5-5/32	0.04
J1208MBA	8	25/64	11/16	13/64	17/32	9/32	5-13/32	0.07
J1209MBA	9	13/32	47/64	13/64	17/32	9/32	5-21/32	0.08
J1210MBASD	10	31/64	7/8	15/64	41/64	5/16	5-29/32	0.13
J1211MBASD	11	17/32	15/16	1/4	11/16	21/64	6-29/32	0.14
J1212MBASD	12	9/16	1-7/64	1/4	47/64	21/64	7-45/64	0.17
J1213MBASD	13	39/64	1-3/64	17/64	25/32	11/32	7-29/32	0.18
J1214MBASD	14	11/16	1-3/16	19/64	55/64	23/64	8-13/16	0.22
J1215MBASD	15	23/32	1-7/32	19/64	7/8	23/64	9-5/32	0.25
J1216MBASD	16	3/4	1-21/64	21/64	61/64	13/32	9-35/64	0.26
J1217MBASD	17	53/64	1-29/64	11/32	1-1/32	7/16	10-9/32	0.38
J1218MBASD	18	55/64	1-33/64	21/64	1-1/16	29/64	10-11/16	0.41
J1219MBASD	19	29/32	1-37/64	23/64	1-7/64	15/32	11-1/32	0.46
J1220MBASD	20	63/64	1-11/16	25/64	1-3/16	1/2	11-27/64	0.55
J1221MBASD	21	63/64	1-11/16	13/32	1-3/16	1/2	11-13/16	0.54
J1222MBASD	22	1-3/64	1-51/64	13/32	1-9/32	35/64	12-17/32	0.62
J1223MBASD	23	1-1/8	1-29/32	13/32	1-11/32	9/16	12-59/64	0.77
J1224MBASD	24	1-1/8	1-61/64	13/32	1-11/32	9/16	13-5/16	0.77

See pages 595 and 599 for larger sizes.



ASME B107.100

BLACK OXIDE X-LARGE COMBINATION WRENCHES - 12 POINT

- › Black Oxide Finish.
- › For use on extra large fasteners.
- › Used in Mining, Oil and Gas, Industrial Construction.
- › Forged heads with machined openings.
- › 12 point box end allows for fine indexing, helping to improve speed and access. Fits 4, 6 and 12 point.
- › Box end is countersunk for easy application to the fastener.



Product #	Size (in)	Outside Head Width (in) (C)	Outside Head Width (in) (C1)	Head Thickness (in) (D1)	Overall Length (in)	Weight (lbs)
J1290	2-3/16	5-1/2	4-1/4	1-11/16	34	18
J1292	2-7/8	5-1/2	4-3/4	1-11/16	34	18
J1294	2-15/16	5-1/2	4-3/4	1-11/16	34	18
J1296	3	5-1/2	4-3/4	1-11/16	34	18
J1298	3-1/16	5-1/2	4-3/4	1-11/16	34	18
J12100	3-1/8	5-1/2	4-3/4	1-11/16	34	18
J12104	3-1/4	7	5-1/2	2-1/4	37	35
J12108	3-3/8	7	5-1/2	2-1/4	37	35
J12112	3-1/2	7	5-7/8	2-1/4	37	35
J12116	3-5/8	7	5-7/8	2-1/4	37	35
J12120	3-3/4	7	6-1/8	2-1/4	37	35
J12124	3-7/8	7	6-1/8	2-1/4	37	35
J12128	4	7	6-1/8	2-1/4	37	35



BLACK OXIDE X-LARGE METRIC COMBINATION WRENCHES - 12 POINT

METRIC

- › Black Oxide Finish.
- › For use on extra large fasteners.
- › Used in Mining, Oil and Gas, Industrial Construction.
- › Forged heads with machined openings.
- › 12 point box end allows for fine indexing, helping to improve speed and access. Fits 4, 6 and 12 point.
- › Box end is countersunk for easy application to the fastener.



Product #	Size (mm)	Outside Head Width (in) (C)	Outside Head Width (in) (C1)	Head Thickness (in) (D1)	Overall Length (in)	Weight (lbs)
J1273M	73	5-1/2	4-3/4	1-11/16	34	18
J1275M	75	5-1/2	4-3/4	1-11/16	34	18
J1280M	80	5-1/2	4-3/4	1-11/16	34	18

7 PIECE FLEX-HEAD WRENCH SET - 12 POINT

Product #: J1270A

- › Satin finish provides corrosion resistance and a slip-resistant grip.
- › 12 point box end allows for fine indexing, helping to improve speed and access. Fits 4, 6 and 12 point fasteners.
- › Use the swiveling box end to break or cinch bolts in difficult locations.
- › Heat-treated alloy steels produce a shank with high leverage.
- › Box ends incorporate the TorquePlus™ system.
- › Weight (lbs): 2.91



Contents	Size (in)	Overall Length (in)
J1270-12	3/8	6
J1270-14	7/16	6-7/8
J1270-16	1/2	7-3/4
J1270-18	9/16	8-5/8
J1270-20	5/8	9-1/2
J1270-22	11/16	10-3/8
J1270-24	3/4	11-1/4
J25TR01C	Tool Roll	



4 PIECE FLEX-HEAD WRENCH SET - 12 POINT

Product #: J1270B

- › Satin finish provides corrosion resistance and a slip-resistant grip.
- › 12 point box end allows for fine indexing, helping to improve speed and access. Fits 4, 6 and 12 point fasteners.
- › Use the swiveling box end to break or cinch bolts in difficult locations.
- › Heat-treated alloy steels produce a shank with high leverage.
- › Box ends incorporate the TorquePlus™ system.
- › Weight (lbs): 0.88



Contents	Size (in)	Overall Length (in)
J1270-14	7/16	6-7/8
J1270-16	1/2	7-3/4
J1270-18	9/16	8-5/8
J1270-20	5/8	9-1/2
J25TR18C	Tool Roll	



SATIN COMBINATION FLEX-HEAD WRENCHES - 12 POINT

- › Satin finish provides corrosion resistance and a slip-resistant grip.
- › 12 point box end allows for fine indexing, helping to improve speed and access. Fits 4, 6 and 12 point fasteners.
- › Use the swiveling box end to break or cinch bolts in difficult locations.
- › Heat-treated alloy steels produce a shank with high leverage.
- › Box ends incorporate the TorquePlus™ system.

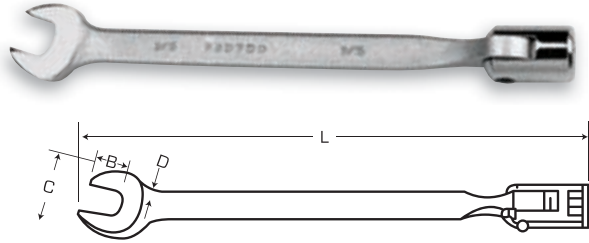

Product #	Size (in)	Throat Depth (in) (B)	Outside Head Width (in) (C)	Head Thickness (in) (D)	Overall Length (in)	Weight (lbs)
J1270-12	3/8	27/64	55/64	15/64	6	0.14
J1270-14	7/16	1/2	1	1/4	6-7/8	0.20
J1270-16	1/2	37/64	1-3/32	9/32	7-3/4	0.25
J1270-18	9/16	21/32	1-15/64	5/16	8-5/8	0.36
J1270-20	5/8	23/32	1-23/32	21/64	9-1/2	0.46
J1270-22	11/16	51/64	1-1/2	11/32	10-3/8	0.58
J1270-24	3/4	7/8	1-41/64	23/64	11-1/4	0.46
J1270-28	7/8	1-1/64	1-27/32	13/32	13	0.93



FACOM® 3 PIECE DOUBLE FLEX-HEAD SOCKET WRENCH SET

Product #: FF-66A.JU3



- › Satin chrome finish.
- › Spring-steadied pivoting 12 point socket.
- › Strength to ISO 1711-1, DIN 899, NF ISO 1711-1.
- › Weight (lbs): 1.55

Contents	Size (in)	Point Count	Overall Length (in)
FF-66A.1/2X9/1	1/2 x 9/16	12	9-1/4
FF-66A.3/8X7/1	3/8 x 7/16	12	6-1/2
FF-66A.5/8X3/4	5/8 x 3/4	12	11-1/4



FACOM® 9 PIECE DOUBLE FLEX-HEAD SOCKET WRENCH SET

Product #: FM-66A.JE9T



- › Satin chrome finish.
- › Spring-steadied pivoting 12 point socket.
- › Strength to ISO 1711-1, DIN 899, NF ISO 1711-1.
- › Weight (lbs): 4.35

Contents	Size (mm)	Point Count	Overall Length (in)
FM-66A.6X7	6 X 7	12	7-11/16
FM-66A.8X9	8 X 9	12	7-11/16
FM-66A.10X11	10 X 11	12	7-7/8
FM-66A.12X13	12 X 13	12	9-1/4
FM-66A.14X15	14 X 15	12	9-1/4
FM-66A.16X17	16 X 17	12	9-7/16
FM-66A.18X19	18 X 19	12	11-7/32
FM-66A.20X22	20 X 22	12	11-7/32
FM-66A.21X23	21 X 23	12	11-13/32



FACOM® SATIN DOUBLE FLEX-HEAD SOCKET WRENCHES - 12 POINT

- › Satin chrome finish.
- › Spring-steadied pivoting 12 point socket.
- › Strength to ISO 1711-1, DIN 899, NF ISO 1711-1.



Product #	Size (in)	Outside Head Width (in) (C)	Outside Head Width (in) (C1)	Overall Length (in)	Weight (lbs)
FF-66A.3/8X7/1	3/8 x 7/16	19/32	21/32	6-1/2	0.26
FF-66A.1/2X9/1	1/2 x 9/16	3/4	13/16	9-1/4	0.47
FF-66A.5/8X3/4	5/8 x 3/4	29/32	1-1/32	11-1/4	0.82

FACOM® SATIN METRIC DOUBLE FLEX-HEAD SOCKET WRENCHES - 12 POINT

- › Satin chrome finish.
- › Spring-steadied pivoting 12 point socket.
- › Strength to ISO 1711-1, DIN 899, NF ISO 1711-1.



Product #	Size (mm)	Outside Head Width (in) (C)	Outside Head Width (in) (C1)	Overall Length (in)	Weight (lbs)
FM-66A.6X7	6 X 7	19/32	29/64	7-11/16	0.20
FM-66A.8X9	8 X 9	19/32	35/64	7-11/16	0.21
FM-66A.10X11	10 X 11	45/64	21/32	7-7/8	0.24
FM-66A.12X13	12 X 13	53/64	3/4	9-1/4	0.42
FM-66A.14X15	14 X 15	29/32	55/64	9-1/4	0.44
FM-66A.16X17	16 X 17	29/32	15/16	9-7/16	0.49
FM-66A.18X19	18 X 19	63/64	1-1/32	11-7/32	0.77
FM-66A.20X22	20 X 22	1-5/64	1-13/64	11-7/32	0.76
FM-66A.21X23	21 X 23	1-1/8	1-15/64	11-13/32	0.82
FM-66A.24X27	24 X 27	1-19/64	1-7/16	13-3/16	1.15
FM-66A.30X32	30 X 32	1-19/32	1-11/16	13-1/8	1.32

10 PIECE FACOM® ANGLED SOCKET WRENCH SET

Product #: **FF-75.JU10**

Contents	Size (in)	Overall Length (in)
FF-75.5/16	5/16	4-31/64
FF-75.3/8	3/8	5-5/64
FF-75.7/16	7/16	5-23/64
FF-75.1/2	1/2	5-63/64
FF-75.9/16	9/16	6-21/32
FF-75.5/8	5/8	7-1/64
FF-75.11/16	11/16	7-43/64
FF-75.3/4	3/4	8-1/32
FF-75.13/16	13/16	8-45/64
FF-75.7/8	7/8	9-29/64

- › Satin finish.
- › Angle and through-hole design helps accommodate threaded rods or a bar for extra leverage, without affecting wrench strength.
- › Deep recess at one end and open end socket at the other fit over protruding studs.
- › Weight (lbs): 6.08



FACOM® SATIN ANGLED OPEN-SOCKET WRENCHES - 6 POINT X 6 POINT



Product #	Size (in)	Overall Length (in)	Weight (lbs)
FF-75.1/4	1/4	4-1/64	0.07
FF-75.5/16	5/16	4-31/64	0.13
FF-75.3/8	3/8	5-5/64	0.20
FF-75.7/16	7/16	5-23/64	0.25
FF-75.1/2	1/2	5-63/64	0.38
FF-75.9/16	9/16	6-21/32	0.49
FF-75.5/8	5/8	7-1/64	0.62
FF-75.11/16	11/16	7-43/64	0.80
FF-75.3/4	3/4	8-1/32	0.94
FF-75.13/16	13/16	8-45/64	1.08
FF-75.7/8	7/8	9-29/64	1.38
FF-75.15/16	15/16	9-27/32	1.45
FF-75.1	1	10-5/8	1.75

- › Satin finish.
- › Angle and through-hole design helps accommodate threaded rods or a bar for extra leverage, without affecting wrench strength.
- › Deep recess at one end and open end socket at the other fit over protruding studs.



FACOM® SATIN METRIC ANGLED OPEN-SOCKET WRENCHES - 12 POINT X 6 POINT



METRIC

Product #	Size (mm)	Overall Length (in)	Weight (lbs)
FM-76.6	6	4-1/64	0.07
FM-76.7	7	4-11/64	0.09
FM-76.8	8	4-31/64	0.13
FM-76.9	9	4-51/64	0.14
FM-76.10	10	5-5/64	0.21
FM-76.11	11	5-23/64	0.25
FM-76.12	12	5-43/64	0.34
FM-76.13	13	5-63/64	0.39
FM-76.14	14	6-19/64	0.44
FM-76.15	15	6-21/32	0.50
FM-76.16	16	7-1/64	0.63
FM-76.17	17	7-23/64	0.69
FM-76.18	18	7-43/64	0.80
FM-76.19	19	8-1/32	0.95
FM-76.20	20	8-11/32	0.97
FM-76.21	21	8-45/64	1.08
FM-76.22	22	9-1/16	1.18
FM-76.23	23	9-29/64	1.38
FM-76.24	24	9-27/32	1.46
FM-76.25	25	10-15/64	1.73
FM-76.26	26	10-5/8	1.75
FM-76.27	27	11-1/32	2.09
FM-76.28	28	11-27/64	2.09
FM-76.29	29	11-13/16	2.31
FM-76.30	30	12-13/64	2.87
FM-76.31	31	12-19/32	3.05
FM-76.32	32	12-63/64	3.09
FM-76.33	33	13-25/64	3.26
FM-76.34	34	13-25/32	3.42
FM-76.35	35	14-11/64	3.59
FM-76.36	36	14-9/16	3.75
FM-76.38	38	15-23/64	4.59

- › Satin finish.
- › Angle and through-hole design helps accommodate threaded rods or a bar for extra leverage, without affecting wrench strength.
- › Deep recess at one end and open end socket at the other fit over protruding studs.





7 PIECE BOX WRENCH SET - 12 POINT

Product #: J1100R

- › Full polish finish provides corrosion resistance and easy to clean surfaces.
- › 12 point box end allows for fine indexing, helping to improve speed and access. Fits 4, 6 and 12 point fasteners.
- › Box ends incorporate the TorquePlus™ system.
- › Weight (lbs): 4.23



Contents	Size (in)	Point Count	Overall Length (in)
J1170	5/16 x 3/8	12	6-15/16
J1171	7/16 x 1/2	12	8-1/16
J1172	9/16 x 5/8	12	9-7/16
J1173	11/16 x 3/4	12	11-1/8
J1174	13/16 x 7/8	12	13-1/8
J1175	15/16 x 1	12	15-1/8
J1176	1-1/16 x 1-1/8	12	17-1/2
J25TR32C	Tool Roll		

ASME B107.100



5 PIECE BOX WRENCH SET - 12 POINT

Product #: J1100G

- › Full polish finish provides corrosion resistance and easy to clean surfaces.
- › 12 point box end allows for fine indexing, helping to improve speed and access. Fits 4, 6 and 12 point fasteners.
- › Box ends incorporate the TorquePlus™ system.
- › Weight (lbs): 2.20



Contents	Size (in)	Point Count	Overall Length (in)
J1170	5/16 x 3/8	12	6-15/16
J1171	7/16 x 1/2	12	8-1/16
J1172	9/16 x 5/8	12	9-7/16
J1173	11/16 x 3/4	12	11-1/8
J1174	13/16 x 7/8	12	13-1/8
J25TR04C	Tool Roll		

ASME B107.100



11 PIECE METRIC BOX WRENCH SET - 12 POINT

METRIC

Product #: J1100S-M

- › Full polish finish provides corrosion resistance and easy to clean surfaces.
- › 12 point box end allows for fine indexing, helping to improve speed and access. Fits 4, 6 and 12 point fasteners.
- › Offset box end allows access to recessed fasteners and keeps hands clear of obstructions.
- › Box ends incorporate the TorquePlus™ system.
- › Weight (lbs): 7.40



Contents	Size (mm)	Point Count	Overall Length (in)
J1050M	6 x 7	12	5-49/64
J1051M	8 x 9	12	6-49/64
J1053M	10 x 11	12	7-31/32
J1057M	12 x 13	12	8-55/64
J1061M	14 x 15	12	9-45/64
J1064M	16 x 18	12	10-11/16
J1065M	17 x 19	12	11-23/64
J1072M	21 x 24	12	13-25/64
J1073M	22 x 24	12	13-45/64
J1077M	27 x 30	12	15-59/64
J1079M	30 x 32	12	17-13/64
J25TR44C	Tool Roll		

ASME B107.100



7 PIECE METRIC BOX WRENCH SET - 12 POINT

METRIC

Product #: J1100D-M

- › Full polish finish provides corrosion resistance and easy to clean surfaces.
- › 12 point box end allows for fine indexing, helping to improve speed and access. Fits 4, 6 and 12 point fasteners.
- › Offset box end allows access to recessed fasteners and keeps hands clear of obstructions.
- › Box ends incorporate the TorquePlus™ system.
- › Weight (lbs): 2.04



Contents	Size (mm)	Point Count	Overall Length (in)
J1050M	6 x 7	12	5-49/64
J1051M	8 x 9	12	6-49/64
J1053M	10 x 11	12	7-31/32
J1057M	12 x 13	12	8-55/64
J1061M	14 x 15	12	9-45/64
J1064M	16 x 18	12	10-11/16
J1065M	17 x 19	12	11-23/64
J25TR43C	Tool Roll		

ASME B107.100





7 PIECE OFFSET BOX WRENCH SET - 12 POINT

Product #: J1000G-500

- › Full polish finish provides corrosion resistance and easy to clean surfaces.
- › 12 point box end allows for fine indexing, helping to improve speed and access. Fits 4, 6 and 12 point fasteners.
- › Offset box end allows access to recessed fasteners and keeps hands clear of obstructions.
- › Box ends incorporate the TorquePlus™ system.
- › Weight (lbs): 3.84



Contents	Size (in)	Point Count	Overall Length (in)
J1012-500	3/8 x 7/16	12	7-3/4
J1016-500	1/2 x 9/16	12	8-7/8
J1018-500	9/16 x 5/8	12	9-1/2
J1022-500	11/16 x 3/4	12	11-3/16
J1026-500	13/16 x 7/8	12	12-11/16
J1030-500	15/16 x 1	12	14-3/8
J1034-500	1-1/16 x 1-1/8	12	16-3/4
J25TR32C	Tool Roll		

 ASME B107.100



6 PIECE DEEP OFFSET BOX WRENCH SET - 12 POINT

Product #: J8100C

- › Satin finish provides corrosion resistance and a slip-resistant grip.
- › 12 point box end allows for fine indexing, helping to improve speed and access. Fits 4, 6 and 12 point fasteners.
- › 60° deep offset helps improve access to deeply recessed fasteners.
- › Offset handle helps keep knuckles clear of obstruction to help save time.
- › Box ends incorporate the TorquePlus™ system.
- › Weight (lbs): 3.33



Contents	Size (in)	Point Count	Overall Length (in)
J8180	3/8 x 7/16	12	7-3/4
J8181	1/2 x 9/16	12	9
J8182	5/8 x 11/16	12	10-1/4
J8183A	11/16 x 13/16	12	11-1/2
J8184	3/4 x 7/8	12	12-3/4
J8185	15/16 x 1	12	14
J25TR19C	Tool Roll		

 ASME B107.100



8 PIECE BLACK OXIDE BOX WRENCH SET - 12 POINT

Product #: **J1100MB**

- › Non-reflective black oxide finish for use where non-plated products are required.
- › 12 point box end allows for fine indexing, helping to improve speed and access. Fits 4, 6 and 12 point fasteners.
- › Box ends incorporate the TorquePlus™ system.
- › Weight (lbs): 5.39



Contents	Size (in)	Point Count	Overall Length (in)
J1120LB	5/16 x 3/8	12	6-15/16
J1125LB	7/16 x 1/2	12	8-1/16
J1130LB	9/16 x 5/8	12	9-7/16
J1135B	11/16 x 3/4	12	11-1/4
J1140B	13/16 x 7/8	12	13-7/8
J1145B	15/16 x 1	12	15-1/2
J1150B	1-1/16 x 1-1/8	12	17-1/4
J1151B	1-1/16 x 1-1/4	12	18-1/4
J25TR27C	Tool Roll		



FACOM® 5 PIECE METRIC OBSTRUCTION BOX WRENCH SET

FACOM®

METRIC

Product #: **FM-57.JE5**

- › Satin finish provides corrosion resistance and slip-resistant grip.
- › Half-moon shape helps improve access to hidden, difficult to reach locations.
- › 12 point box end allows for fine indexing, helping to improve speed and access.
- › Fits 4, 6 and 12 point fasteners.
- › Weight (lbs): 1.80

Contents	Size (mm)	Point Count	Overall Length (in)
FM-57.10X12	10 x 12	12	5-5/8
FM-57.11X13	11 x 13	12	6-1/2
FM-57.14X17	14 x 17	12	7-17/32
FM-57.16X18	16 x 18	12	8-3/4
FM-57.19X22	19 x 22	12	9-31/32



FULL POLISH DOUBLE BOX WRENCHES - 12 POINT

- › Full polish finish provides corrosion resistance and easy to clean surfaces.
- › 12 point box end allows for fine indexing, helping to improve speed and access. Fits 4, 6 and 12 point fasteners.
- › Box ends incorporate the TorquePlus™ system.



Product #	Size (in)	Outside Head Width (in) (C)	Head Thickness (in) (D)	Outside Head Width (in) (C1)	Head Thickness (in) (D1)	Overall Length (in)	Weight (lbs)
J1170	5/16 x 3/8	37/64	17/64	15/32	15/64	6-15/16	0.20
J1171	7/16 x 1/2	3/4	21/64	21/32	19/64	8-1/16	0.23
J1126L	1/2 x 9/16	7/8	3/8	3/4	23/64	8-3/8	0.24
J1172	9/16 x 5/8	15/16	25/64	27/32	23/64	9-7/16	0.41
J1173	11/16 x 3/4	17/64	29/64	11/64	27/64	11-1/8	0.53
J1139	3/4 x 7/8	1-1/4	33/64	1-1/8	33/64	13-1/8	0.65
J1174	13/16 x 7/8	1-19/64	33/64	1-3/16	31/64	13-1/8	0.65
J1175	15/16 x 1	1-15/32	37/64	1-25/64	35/64	15-1/8	0.90
J1176	1-1/16 x 1-1/8	1-37/64	5/8	1-1/2	19/32	17-1/2	1.54



AS954E S3.8.1

ASME B107.100

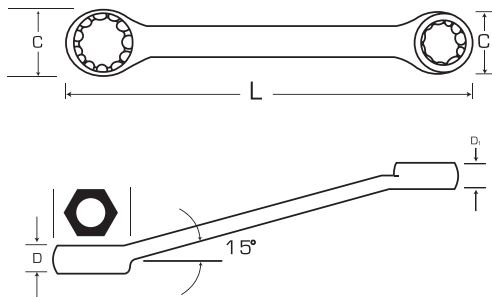

FACOM® FULL POLISH METRIC DOUBLE BOX WRENCHES - 12 POINT

- › Slim rings and short shank for clearance.
- › 12 point box ends allow for fine indexing, helping to improve speed and access.
- › Straight pattern.
- › Fits 4, 6 and 12 point fasteners.



Product #	Size (mm)	Outside Head Width (in) (C)	Head Thickness (in) (D)	Outside Head Width (in) (C1)	Head Thickness (in) (D1)	Overall Length (in)	Weight (lbs)
FM-59.6X7	6 X 7	25/64	3/16	7/16	3/16	3-15/16	0.05
FM-59.8X9	8 X 9	31/64	13/64	35/64	13/64	4-17/32	0.07
FM-59.10X11	10 x 11	39/64	1/4	21/32	1/4	5-3/64	0.11
FM-59.12X13	12 x 13	47/64	9/32	13/16	9/32	5-5/8	0.16
FM-59.14X15	14 x 15	53/64	9/32	57/64	9/32	6-3/16	0.21
FM-59.16X17	16 x 17	59/64	21/64	31/32	21/64	6-39/64	0.26
FM-59.18X19	18 x 19	1-1/32	23/64	1-5/64	23/64	7-7/16	0.32
FM-59.21X23	21 x 23	1-15/64	29/64	1-21/64	29/64	8-35/64	0.52
FM-59.22X24	22 X 24	1-15/64	29/64	1-21/64	29/64	8-35/64	0.51
FM-59.26X28	26 X 28	1-7/16	15/32	1-19/32	15/32	10-7/16	0.95
FM-59.27X29	27 X 29	1-17/32	1/2	1-45/64	1/2	11-7/32	0.92
FM-59.30X32	30 X 32	1-43/64	1/2	1-49/64	1/2	11-7/32	1.14

FULL POLISH DOUBLE BOX WRENCHES - SPLINE

- › Proto® Spline Tools are designed to service high tensile strength fasteners used widely on military and commercial aircraft and in heavy machinery applications where vibration is prevalent. They are also used in automotive and industrial areas where high performance torque needs to be achieved.
- › Spline fasteners help tighten high strength bolts to high torque loads.
- › They help lower the force required to turn standard fasteners by allowing the torque load to be moved away from the corners, helping prevent fastener rounding. They also turn fasteners with damaged corners.
- › Spline helps reduce foreign object debris (FOD) by having a precise fit between the fastening tool and its fastener.
- › Full polish finish provides corrosion resistance and an easy to clean surface.



Product #	Size (in)	Outside Head Width (in) (C)	Head Thickness (in) (D)	Outside Head Width (in) (C1)	Head Thickness (in) (D1)	Overall Length (in)	Weight (lbs)
J1118SPL	1/4 x 5/16	31/64	15/64	25/64	15/64	7-1/4	0.12
J1122SPL	3/8 x 7/16	43/64	23/64	37/64	21/64	8-1/4	0.18
J1126SPL	1/2 x 9/16	53/64	25/64	3/4	23/64	9-3/16	0.34
J1130SPL	9/16 x 5/8	59/64	29/64	53/64	25/64	9-3/4	0.4
J1135SPL	11/16 x 3/4	1-5/64	33/64	63/64	1/2	11	0.75
J1142SPL	13/16 x 15/16	1-23/64	37/64	1-5/32	17/32	12-3/4	1.03
J1144SPL	7/8 x 1	1-29/64	19/32	1-1/4	35/64	13-1/4	1.08



FEATURES AND BENEFITS — GRABBING ROUNDED HEADS

Spline End Wrenches are the better choice for working out a fastener with a rounded head. The tips of the spline always grab the fastener along the flat sides of the head, away from the damaged corners. You have a much better chance of getting a firmer grip that won't slip when you apply force.

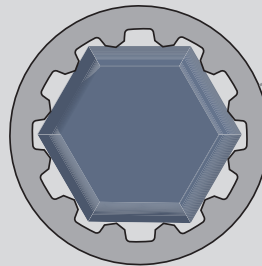

Spline tips grip away from the corners.

SATIN DOUBLE BOX WRENCHES - 12 POINT

- › Satin finish provides corrosion resistance and a slip-resistant grip.
- › 12 point box end allows for fine indexing, helping to improve speed and access. Fits 4, 6 and 12 point fasteners.
- › Box ends incorporate the TorquePlus™ system.



Product #	Size (in)	Outside Head Width (in) (C)	Head Thickness (in) (D)	Outside Head Width (in) (C1)	Head Thickness (in) (D1)	Overall Length (in)	Weight (lbs)
J1151	1-1/16 x 1-1/4	1-3/4	45/64	1-1/2	5/8	18-1/4	1.82
J1155	1-1/4 x 1-5/16	1-7/8	47/64	1-3/4	3/4	19-1/4	1.97
J1160	1-1/4 x 1-3/8	1-15/16	3/4	1-3/4	3/4	20-1/4	2.22
J1162	1-7/16 x 1-1/2	2-1/8	13/16	2-3/64	51/64	22-1/4	2.98
J1164	1-5/8 x 1-11/16	2-3/8	29/32	2-13/32	29/32	24-1/2	3.74



AS954E S3.8.1

ASME B107.100



BLACK OXIDE DOUBLE BOX WRENCHES - 12 POINT

- › Non-reflective black oxide finish for use where non-plated products are required.
- › 12 point box end allows for fine indexing, helping to improve speed and access. Fits 4, 6 and 12 point fasteners.
- › Box ends incorporate the TorquePlus™ system.



Product #	Size (in)	Outside Head Width (in) (C)	Head Thickness (in) (D)	Outside Head Width (in) (C1)	Head Thickness (in) (D1)	Overall Length (in)	Weight (lbs)
J1120LB	5/16 x 3/8	37/64	17/64	15/32	15/64	6-15/16	0.15
J1125LB	7/16 x 1/2	3/4	21/64	21/32	19/64	8-1/16	0.18
J1126LB	1/2 x 9/16	57/64	25/64	13/16	3/8	8-7/16	0.24
J1130LB	9/16 x 5/8	15/16	25/64	27/32	23/64	9-7/16	0.28
J1135B	11/16 x 3/4	1-7/64	29/64	1-1/64	27/64	11-1/4	0.48
J1139B	3/4 x 7/8	1-1/4	33/64	1-1/8	33/64	13-1/8	0.65
J1140B	13/16 x 7/8	1-19/64	33/64	1-3/16	31/64	13-7/8	0.69
J1145B	15/16 x 1	1-29/64	37/64	1-3/8	35/64	15-1/2	0.99
J1150B	1-1/16 x 1-1/8	1-39/64	5/8	1-1/2	19/32	17-1/4	1.50
J1151B	1-1/16 x 1-1/4	1-3/4	39/64	1-1/2	45/64	18-1/4	1.82



AS954E S3.8.1

FULL POLISH OFFSET BOX WRENCHES - 12 POINT

- › Full polish finish provides corrosion resistance and easy to clean surfaces.
- › 12 point box end allows for fine indexing, helping to improve speed and access. Fits 4, 6 and 12 point fasteners.
- › Offset box end allows access to recessed fasteners and keeps hands clear of obstructions.
- › Box ends incorporate the TorquePlus™ system.



Product #	Size (in)	Outside Head Width (in) (C)	Head Thickness (in) (D)	Outside Head Width (in) (C1)	Head Thickness (in) (D1)	Overall Length (in)	Weight (lbs)
J1012-500	3/8 x 7/16	21/32	5/16	37/64	19/64	7-3/4	0.11
J1016-500	1/2 x 9/16	53/64	23/64	3/4	11/32	8-7/8	0.20
J1018-500	9/16 x 5/8	59/64	13/32	53/64	23/64	9-1/2	0.27
J1022-500	11/16 x 3/4	1-3/32	15/32	1-1/64	29/64	11-3/16	0.40
J1026-500	13/16 x 7/8	1-1/4	33/64	1-11/64	31/64	12-11/16	0.67
J1030-500	15/16 x 1	1-13/32	37/64	1-21/64	35/64	14-3/8	0.88
J1034-500	1-1/16 x 1-1/8	1-9/16	41/64	1-31/64	41/64	16-3/4	1.15



AS954E S3.8.1

ASME B107.100

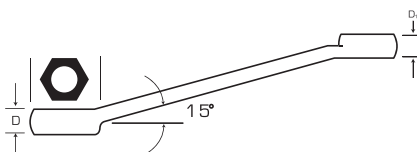
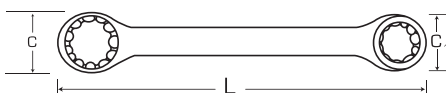

FULL POLISH METRIC OFFSET BOX WRENCHES - 12 POINT



- › Full polish finish provides corrosion resistance and easy to clean surfaces.
- › 12 point box end allows for fine indexing, helping to improve speed and access. Fits 4, 6 and 12 point fasteners.
- › Offset box end allows access to recessed fasteners and keeps hands clear of obstructions.
- › Box ends incorporate the TorquePlus™ system.



Product #	Size (mm)	Outside Head Width (in) (C)	Outside Head Width (in) (C1)	Overall Length (in)	Weight (lbs)
J1050M	6 x 7	29/64	13/32	5-49/64	0.09
J1051M	8 x 9	35/64	31/64	6-49/64	0.11
J1053M	10 x 11	21/32	39/64	7-31/32	0.19
J1057M	12 x 13	3/4	45/64	8-55/64	0.28
J1058M	12 x 14	13/16	45/64	9-1/16	0.42
J1061M	14 x 15	7/8	13/16	9-45/64	0.39
J1064M	16 x 18	1-1/32	29/32	10-11/16	0.45
J1065M	17 x 19	1-5/64	63/64	11-23/64	0.59
J1068M	19 x 21	1-3/16	1-5/64	12-15/32	0.70
J1069M	19 x 22	1-17/64	1-5/64	12-15/32	0.70
J1072M	21 x 24	1-11/32	1-3/16	13-25/64	0.99
J1073M	22 x 24	1-11/32	1-17/64	13-45/64	0.94
J1077M	27 x 30	1-43/64	1-33/64	15-59/64	1.42
J1079M	30 x 32	1-25/32	1-43/64	17-13/64	1.76



AS954E S3.8.1

ASME B107.100

SATIN DEEP OFFSET BOX WRENCHES - 12 POINT

- › Satin finish provides corrosion resistance and a slip-resistant grip.
- › 12 point box end allows for fine indexing, helping to improve speed and access. Fits 4, 6 and 12 point fasteners.
- › 60° deep offset helps improve access to deeply recessed fasteners.
- › Offset handle helps keep knuckles clear of obstruction to help save time.
- › Box ends incorporate the TorquePlus™ system.



Product #	Size (in)	Outside Head Width (in) (C)	Head Thickness (in) (D)	Outside Head Width (in) (C1)	Head Thickness (in) (D1)	Overall Length (in)	Weight (lbs)
J8180	3/8 x 7/16	39/64	5/16	45/64	11/32	7-3/4	0.19
J8181	1/2 x 9/16	51/64	23/64	57/64	23/64	9	0.32
J8182	5/8 x 11/16	31/32	13/32	1-1/32	7/16	10-1/4	0.44
J8183A	11/16 x 13/16	1-3/16	1/2	1-1/4	1/2	11-1/2	0.54
J8184	3/4 x 7/8	1-1/8	1/2	1-1/4	17/32	12-3/4	0.74
J8185	15/16 x 1	1-11/32	5/8	1-13/32	5/8	14	1.10



AS954E S3.8.1

ASME B107.100

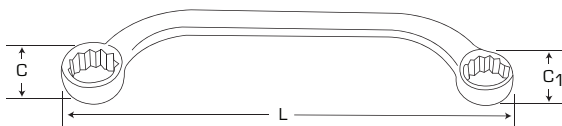

SHORT SATIN DOUBLE BOX WRENCHES - 12 POINT

- › Satin finish provides corrosion resistance and a slip-resistant grip.
- › 12 point box end allows for fine indexing, helping to improve speed and access. Fits 4, 6 and 12 point fasteners.
- › Box ends incorporate the TorquePlus™ system.



Product #	Size (in)	Outside Head Width (in) (C)	Head Thickness (in) (D)	Outside Head Width (in) (C1)	Head Thickness (in) (D1)	Overall Length (in)	Weight (lbs)
J1120	5/16 x 3/8	33/64	17/64	37/64	19/64	4-1/4	0.07
J1122	3/8 x 7/16	37/64	19/64	43/64	21/64	4-5/8	0.09
J1125	7/16 x 1/2	43/64	21/64	49/64	11/32	5	0.10
J1126	1/2 x 9/16	43/64	11/32	55/64	23/64	5-3/8	0.12
J1131	5/8 x 3/4	1-27/32	13/32	1-3/32	15/32	6-1/8	0.25



AS954E S3.8.1

ASME B107.100

SATIN OBSTRUCTION BOX WRENCHES - 12 POINT

- › Satin chrome finish provides corrosion resistance and a slip-resistant grip.
- › Made of forged steel then heat-treated.
- › Curved half-moon shape helps improve access to hidden, difficult to reach locations.
- › 12 point box end allows for fine indexing, helping to improve speed and access. Fits 4, 6 and 12 point fasteners.
- › Box ends incorporate the TorquePlus™ system.



Product #	Size (in)	Outside Head Width (in) (C)	Outside Head Width (in) (C1)	Overall Length (in)	Weight (lbs)
J1725	7/16 x 1/2	5/8	5/8	5-3/4	0.17
J1730	9/16 x 5/8	25/32	25/32	6-5/8	0.23
J1731	5/8 x 3/4	27/32	27/32	7-1/4	0.39



AS954E S3.8.1

ASME B107.100

FACOM® SATIN METRIC OBSTRUCTION BOX WRENCHES - 12 POINT

- › Satin finish provides corrosion resistance and a slip-resistant grip.
- › Half-moon shape helps improve access to hidden, difficult to reach locations.
- › 12 point box end allows for fine indexing, helping to improve speed and access.
- › Fits 4, 6 and 12 point fasteners.



Product #	Size (mm)	Outside Head Width (in) (C)	Head Thickness (in) (D)	Outside Head Width (in) (C1)	Head Thickness (in) (D1)	Overall Length (in)	Weight (lbs)
FM-57.10X12	10 x 12	43/64	5/16	49/64	5/16	5-5/8	0.15
FM-57.11X13	11 x 13	43/64	5/16	49/64	5/16	6-1/2	0.24
FM-57.13X15	13 x 15	25/32	21/64	29/32	23/64	7-15/32	0.35
FM-57.14X16	14 x 16	57/64	23/64	31/32	3/8	7-7/16	0.35
FM-57.14X17	14 x 17	57/64	23/64	31/32	3/8	7-17/32	0.34
FM-57.15X17	15 x 17	57/64	23/64	31/32	3/8	8-3/4	0.46
FM-57.16X18	16 x 18	15/16	3/8	1-1/16	25/64	8-3/4	0.45
FM-57.19X22	19 x 22	1-1/8	25/64	1-9/32	7/16	9-31/32	0.62



FACOM® INSULATED BOX WRENCHES - 12 POINT



- › Insulated to 1000V or 1500 DC.
- › 2 color warning handle insulation - color changes from orange to yellow if insulation integrity compromised.
- › 12 point box end allows for fine indexing, helping to improve speed and access.
- › Fits 4, 6 and 12 point fasteners.



Product #	Size (mm)	Outside Head Width (in) (C)	Head Thickness (in) (D)	Offset Height (in) (E)	Overall Length (in)	Weight (lbs)
FM-55.8AVSE	8	5/8	5/16	5/8	6-1/32	0.12
FM-55.9AVSE	9	43/64	23/64	43/64	6-1/2	0.13
FM-55.10AVSE	10	3/4	23/64	43/64	6-5/16	0.12
FM-55.11AVSE	11	25/32	25/64	3/4	6-11/16	0.15
FM-55.12AVSE	12	53/64	7/16	25/32	6-7/8	0.23
FM-55.13AVSE	13	29/32	15/32	25/32	7-3/32	0.22
FM-55.14AVSE	14	63/64	15/32	53/64	7-15/32	0.27
FM-55.15AVSE	15	1-1/32	15/32	53/64	7-11/16	0.29
FM-55.16AVSE	16	1-1/16	33/64	1-1/32	8-1/16	0.34
FM-55.17AVSE	17	1-3/16	35/64	1-1/16	7-7/8	0.34
FM-55.18AVSE	18	1-3/16	35/64	1-1/16	8-7/8	0.46
FM-55.19AVSE	19	1-17/64	35/64	1-1/16	9-1/4	0.49
FM-55.21AVSE	21	1-3/8	5/8	1-7/32	10-1/32	0.75

10 PIECE OPEN END WRENCH SET

Product #: J3000H

Contents	Size (in)	Overall Length (in)
J3018	1/4 x 5/16	4-31/64
J3020	5/16 x 3/8	5-1/8
J3025	7/16 x 1/2	6-3/8
J3026	1/2 x 9/16	7
J3030	9/16 x 5/8	7-5/8
J3031	5/8 x 3/4	8-9/16
J3035	11/16 x 3/4	8-7/8
J3040	13/16 x 7/8	10-1/8
J3045	15/16 x 1	11-1/2
J3050	1-1/16 x 1-1/8	12-5/8
J25TR05C	Tool Roll	

ASME B107.100

- › Satin finish provides corrosion resistance and a slip-resistant grip.
- › 15° angle heads.
- › Special heat-treated alloy steel permits slim shanks for strength and durability.
- › Standard open end configuration.
- › Weight (lbs): 4.82



10 PIECE BLACK OXIDE OPEN END WRENCH SET

Product #: J3000HB

Contents	Size (in)	Overall Length (in)
J3020B	5/16 x 3/8	5-1/4
J3025B	7/16 x 1/2	6-7/16
J3030B	9/16 x 5/8	7-47/64
J3035B	11/16 x 3/4	8-63/64
J3040B	13/16 x 7/8	10-15/64
J3045B	15/16 x 1	11-31/64
J3050B	1-1/16 x 1-1/8	12-3/8
J3055B	1-1/4 x 1-5/16	14-5/8
J3060B	1-3/8 x 1-7/16	15-7/8
J3070B	1-1/2 x 1-5/8	17-1/16
J25TR05C	Tool Roll	

- › Non-reflective black oxide finish for use where non-plated products are required.
- › 15° angle heads.
- › Special heat-treated alloy steel permits slim shanks for strength and durability.
- › Standard open-end configuration.
- › Weight (lbs): 12.62



10 PIECE METRIC OPEN END WRENCH SET

METRIC

Product #: J30000A

Contents	Size (mm)	Overall Length (in)
J30607	6 x 7	4-1/2
J30809	8 x 9	5-1/8
J31011	10 x 11	5-3/4
J31213	12 x 13	6-3/8
J31415	14 x 15	7-19/32
J31617	16 x 17	8-15/64
J31819	18 x 19	8-55/64
J32022	20 x 22	9-31/64
J32123	21 x 23	10-1/8
J32426	24 x 26	11-3/8
J25TR28C	Tool Roll	



ASME B107.100

- › Satin finish provides corrosion resistance and a slip-resistant grip.
- › 15° angle heads.
- › Special heat-treated alloy steel permits slim shanks for strength and durability.
- › Standard open end configuration.
- › Weight (lbs): 3.93



6 PIECE METRIC OPEN END WRENCH SET

METRIC

Product #: J30000R

- › Satin finish provides corrosion resistance and a slip-resistant grip.
- › 15° angle heads.
- › Special heat-treated alloy steel permits slim shanks for strength and durability.
- › Standard open end configuration.
- › Weight (lbs): 1.63

Contents	Size (mm)	Overall Length (in)
J30809	8 x 9	5-1/8
J31011	10 x 11	5-3/4
J31213	12 x 13	6-3/8
J31415	14 x 15	7-19/32
J31617	16 x 17	8-15/64
J31819	18 x 19	8-55/64
J25TR25C	Tool Roll	



ASME B107.100



5 PIECE OPEN END WRENCH SET

Product #: J3000N

- › Satin finish.
- › 15° angle heads.
- › Special heat-treated alloy steel permits slim shanks for strength and durability.
- › Standard open end configuration.
- › Weight (lbs): 1.66

Contents	Size (in)	Overall Length (in)
J3021	3/8 x 7/16	5-3/4
J3026	1/2 x 9/16	7
J3030	9/16 x 5/8	7-5/8
J3035	11/16 x 3/4	8-7/8
J3040	13/16 x 7/8	10-1/8
J25TR06C	Tool Roll	



ASME B107.100



5 PIECE METRIC OPEN END WRENCH SET

METRIC

Product #: **J3000P-M**

- › Special heat-treated alloy steel permits slim shanks for strength and durability.
- › 15° angled heads.
- › Standard open end configuration.
- › Weight (lbs): 1.92

Contents	Size (mm)	Overall Length (in)
J31011	10 x 11	5-3/4
J31213	12 x 13	6-3/8
J31415	14 x 15	7-19/32
J31819	18 x 19	8-55/64
J32123	21 x 23	10-1/8
J25TR06C	Tool Roll	



ASME B107.100



SATIN OPEN END WRENCHES

- › Satin finish provides corrosion resistance and a slip-resistant grip.
- › 15° angle heads.
- › Special heat-treated alloy steel permits slim shanks for strength and durability.
- › Standard open end configuration.



Product #	Size (in)	Throat Depth (in) (B)	Outside Head Width (in) (C)	Head Thickness (in) (D)	Throat Depth (in) (B1)	Outside Head Width (in) (C1)	Head Thickness (in) (D1)	Overall Length (in)	Weight (lbs)
J3016	3/16 x 1/4	17/64	1/2	5/32	1/4	7/16	5/32	3-7/8	0.04
J3018	1/4 x 5/16	3/8	21/32	3/16	19/64	35/64	5/32	4-31/64	0.07
J3020	5/16 x 3/8	7/16	25/32	13/64	3/8	41/64	13/64	5-1/8	0.09
J3021	3/8 x 7/16	23/64	29/32	7/22	7/16	25/32	7/32	5-3/4	0.12
J3025	7/16 x 1/2	19/32	1-1/32	1/4	29/32	29/32	1/4	6-3/8	0.19
J3026	1/2 x 9/16	43/64	1-3/16	17/64	19/32	1-1/32	17/64	7	0.23
J3030	9/16 x 5/8	3/4	1-17/64	9/32	11/16	1-5/32	9/32	7-5/8	0.28
J3031	5/8 x 3/4	29/32	1-37/64	5/16	47/64	1-5/32	5/16	8-9/16	0.39
J3034	5/8 x 11/16	53/64	1-13/32"	5/16	3/4	1-9/32	5/16	8-1/4	0.35
J3035	11/16 x 3/4	29/32	1-37/64	21/64	53/64	1-13/32	21/64	8-7/8	0.47
J3037	11/16 x 25/32	57/64	1-37/64	21/64	53/64	1-13/32	21/64	8-7/8	0.46
J3039	3/4 x 7/8	1-1/16	1-25/32	11/32	29/32	1-37/64	11/32	9-1/2	0.6
J3040	13/16 x 7/8	1-3/64	1-25/32	23/64	63/64	1-21/32	23/64	10-1/8	0.62
J3045	15/16 x 1	1-13/64	2-1/64	13/32	1-1/8	1-29/32	13/32	11-1/2	0.92
J3050	1-1/16 x 1-1/8	1-23/64	2-17/64	29/64	1-9/32	2-5/32	29/64	12-5/8	1.24
J3051	1-1/16 x 1-1/4	1-31/64	2-33/64	15/32	1-9/32	2-5/32	15/32	13-9/16	1.47
J3055	1-1/4 x 1-5/16	1-9/16	2-21/32	33/64	1-31/64	2-33/64	33/64	14-1/2	1.87
J3060	1-3/8 x 1-7/16	1-23/32	2-57/64	35/64	1-41/64	2-23/32	35/64	15-3/4	2.59
J3070	1-1/2 x 1-5/8	1-15/16	3-17/64	39/64	1-25/32	2-61/64	39/64	17	3.31
J3075	1-11/16 x 1-13/16	2-3/16	3-41/64	45/64	2	3-25/64	45/64	18-1/2	4.71
J3080	1-7/8 x 2	2-3/8	4-1/32	49/64	2-11/64	3-41/64	45/64	20	6.38



ASME B107.100



SATIN METRIC OPEN END WRENCHES

METRIC

- › Satin finish provides corrosion resistance and a slip-resistant grip.
- › 15° angle heads.
- › Special heat-treated alloy steel permits slim shanks for strength and durability.
- › Standard open end configuration.



Product #	Size (mm)	Throat Depth (in) (B)	Outside Head Width (in) (C)	Head Thickness (in) (D)	Throat Depth (in) (B1)	Outside Head Width (in) (C1)	Head Thickness (in) (D1)	Overall Length (in)	Weight (lbs)
J30607	6 x 7	3/8	41/64	11/64	19/64	1/2	11/64	4-1/2	0.06
J30809	8 x 9	7/16	25/32	3/16	3/8	21/32	3/16	5-1/8	0.09
J31011	10 x 11	17/32	29/32	7/32	29/64	25/32	7/32	5-3/4	0.13
J31213	12 x 13	19/32	1-1/32	1/4	17/32	29/32	1/4	6-3/8	0.17
J31415	14 x 15	3/4	1-9/32	9/32	11/16	1-9/64	9/32	7-19/32	0.3
J31617	16 x 17	57/64	1-13/32	19/64	3/4	1-9/32	19/64	8-15/64	0.33
J31819	18 x 19	29/32	1-37/64	21/64	53/64	1-13/32	21/64	8-55/64	0.48
J32022	20 x 22	1-3/64	1-13/16	11/32	29/32	1-37/64	11/32	9-31/64	0.58
J32123	21 x 23	1-3/64	1-25/32	23/64	63/64	1-21/32	23/64	10-1/8	0.61
J32426	24 x 26	1-13/64	2-1/64	13/32	1-1/8	1-29/32	13/32	11-3/8	0.88



ASME B107.100

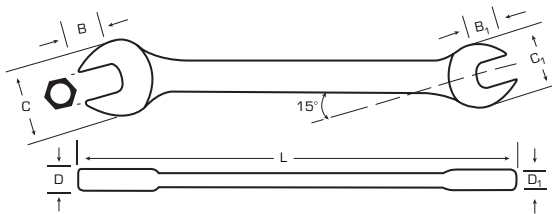

BLACK OXIDE OPEN END WRENCHES

- › Non-reflective black oxide finish for use where non-plated products are required.
- › 15° angle heads.
- › Special heat-treated alloy steel permits slim shanks for strength and durability.
- › Standard open end configuration.



Product #	Size (in)	Throat Depth (in) (B)	Outside Head Width (in) (C)	Head Thickness (in) (D)	Throat Depth (in) (B1)	Outside Head Width (in) (C1)	Head Thickness (in) (D1)	Overall Length (in)	Weight (lbs)
J3020B	5/16 x 3/8	7/16	25/32	3/16	7/32	21/32	3/16	5-1/4	0.08
J3021B	3/8 x 7/16	33/64	29/32	7/32	29/64	25/32	7/32	5-7/8	0.12
J3025B	7/16 x 1/2	39/64	1-1/32	15/64	35/64	29/32	15/64	6-7/16	0.16
J3026B	1/2 x 9/16	11/16	1-3/16	1/4	19/32	1-1/32	1/4	7-7/64	0.22
J3030B	9/16 x 5/8	3/4	1-9/32	17/64	1-1/16	1-5/32	17/64	7-47/64	0.28
J3031B	5/8 x 3/4	29/32	1-37/64	19/64	3/4	1-5/32	19/64	8-43/64	0.38
J3035B	11/16 x 3/4	29/32	1-37/64	5/16	13/16	1-13/32	5/16	8-63/64	0.44
J3039B	3/4 x 7/8	1-3/64	1-17/64	21/64	29/32	1-37/64	21/64	9-39/64	0.50
J3040B	13/16 x 7/8	1-3/64	1-25/32	23/64	61/64	1-31/32	23/64	10-15/64	0.61
J3045B	15/16 x 1	1-13/64	2-1/64	31/64	1-1/8	1-29/32	31/64	11-31/64	0.88
J3050B	1-1/16 x 1-1/8	1-23/64	2-17/64	7/16	1-15/64	2-9/64	7/16	12-3/8	1.20
J3051B	1-1/16 x 1- 1/4	1-1/2	2-33/64	29/64	1-9/32	2-9/64	29/64	13-43/64	1.47
J3055B	1-1/4 x 1-5/16	1-37/64	2-41/64	1/2	1-1/2	2-33/64	1/2	14-5/8	1.87
J3060B	1-3/8 x 1-7/16	1-47/64	2-57/64	17/32	1-21/32	2-23/32	17/32	15-7/8	2.48
J3070B	1-1/2 x 1-5/8	1-61/64	3-1/64	39/64	1-51/64	2-61/64	39/64	17-1/16	3.07



EXTRA THIN SATIN OPEN END WRENCHES

- › Satin finish provides corrosion resistance and a slip-resistant grip.
- › Ultra-thin profile and long handle produce improved access to hard-to-reach fasteners.
- › Use when high leverage or distance from a hot assembly is required.
- › Opening is designed to cover tappets, screws and lock nuts without excessive overhang which improves access.



Product #	Size (in)	Throat Depth (in) (B)	Outside Head Width (in) (C)	Head Thickness (in) (D)	Throat Depth (in) (B1)	Outside Head Width (in) (C1)	Head Thickness (in) (D1)	Overall Length (in)	Weight (lbs)
J3425	7/16 x 1/2	19/32	1-3/32	11/64	33/64	1-1/64	11/64	10	0.16
J3426	1/2 x 9/16	43/64	1-13/64	11/64	19/32	1-9/64	11/64	10	0.16
J3430	9/16 x 5/8	47/64	1-21/64	11/64	43/64	1-1/4	11/64	10	0.21
J3435	11/16 x 3/4	57/64	1-7/16	13/64	13/16	1-11/32	13/64	10	0.26
J3440	13/16 x 7/8	1-1/32	1-49/64	13/64	31/32	1-11/16	13/64	10	0.33



FACOM® 5 PIECE SHORT OPEN END WRENCH SET



Product #: **FF-22.JU5T**

- › Short shank and slim heads for access in confined spaces.
- › Weight (lbs): 0.22

Contents	Size (in)	Overall Length (in)
FF-22.1/2X9/16	1/2 x 9/16	4-11/32
FF-22.11/32X7/16	11/32 x 7/16	3-15/16
FF-22.3/16X1/4	3/16 x 1/4	3-11/32
FF-22.5/16X3/8	5/16 x 3/8	3-17/32
FF-22.7/32X9/32	7/32 x 9/32	3-11/32



FACOM® 6 PIECE METRIC SHORT OPEN END WRENCH SET



Product #: **FM-22.JE6T**

- › Short shank and slim heads for access in confined spaces.
- › Weight (lbs): 0.23

Contents	Size (mm)	Overall Length (in)
FM-22.3.2X5.5	3.2 x 5.5	2-9/32
FM-22.4X5	4 x 5	2-9/32
FM-22.6X7	6 x 7	3-5/16
FM-22.8X9	8 x 9	3-1/2
FM-22.10X11	10 x 11	3-7/8
FM-22.12X13	12 x 13	4-5/16



FACOM® SHORT SATIN OPEN END WRENCHES



- › Satin finish provides corrosion resistance and a slip-resistant grip.
- › Short shank and slim heads for access in confined spaces.
- › Standard open end configuration.



Product #	Size (in)	Outside Head Width (in) (C)	Head Thickness (in) (D)	Outside Head Width (in) (C1)	Head Thickness (in) (D1)	Overall Length (in)	Weight (lbs)
FF-22.3/16X1/4	3/16 x 1/4	35/64	1/8	5/8	1/8	3-11/32	0.03
FF-22.7/32X9/32	7/32 x 9/32	35/64	1/8	5/8	1/8	3-11/32	0.03
FF-22.5/16X3/8	5/16 x 3/8	45/64	1/8	25/32	1/8	3-17/32	0.03
FF-22.11/32X7/16	11/32 x 7/16	53/64	1/8	29/32	1/8	3-15/16	0.05
FF-22.1/2X9/16	1/2 x 9/16	1-1/32	3/32	1-7/64	3/32	4-11/32	0.08

FACOM® SHORT SATIN METRIC OPEN END WRENCHES



- › Satin finish provides corrosion resistance and a slip-resistant grip.
- › Short shank and slim heads for access in confined spaces.
- › Standard open end configuration.



Product #	Size (mm)	Outside Head Width (in) (C)	Head Thickness (in) (D)	Outside Head Width (in) (C1)	Head Thickness (in) (D1)	Overall Length (in)	Weight (lbs)
FM-22.3.2X5.5	3.2 x 5.5	25/64	3/32	33/64	3/32	2-9/32	0.01
FM-22.4X5	4 x 5	25/64	3/32	33/64	3/32	2-9/32	0.02
FM-22.6X7	6 x 7	35/64	3/32	5/8	3/32	3-5/16	0.03
FM-22.8X9	8 x 9	45/64	1/8	25/32	1/8	3-1/2	0.04
FM-22.10X11	10 x 11	53/64	1/8	29/32	1/8	3-7/8	0.05
FM-22.12X13	12 x 13	1-1/32	1/8	1-7/64	1/8	4-5/16	0.08

14 PIECE ANGLE OPEN END WRENCH SET

Product #: **J3100B**

Contents	Size (in)	Overall Length (in)
J3112	3/8	4-3/4
J3114	7/16	5
J3116	1/2	5-1/4
J3118	9/16	5-5/8
J3120	5/8	6
J3122	11/16	6-1/2
J3124	3/4	7
J3126	13/16	7-1/2
J3128	7/8	8
J3130	15/16	8-3/4
J3132	1	9-1/2
J3134	1-1/16	10-1/4
J3136	1-1/8	11
J3140	1-1/4	12-1/4
J25TR08C	Tool Roll	

- › Full polish finish provides corrosion resistance and easy to clean surfaces.
- › Double nickel strike for rust resistance and prolonged life.
- › 15° and 60° angle heads.
- › Weight (lbs): 5.58



ASME B107.100

11 PIECE METRIC ANGLE OPEN END WRENCH SET

METRIC

Product #: **J3100M**

- › Full polish finish provides corrosion and easy to clean surfaces.
- › 15° and 60° angle heads allow wrench to be used in four different turning angles for greater access in tight work areas.
- › Weight (lbs): 1.79

Contents	Size (mm)	Overall Length (in)
J3109M	9	4-3/4
J3110M	10	4-7/8
J3111M	11	5
J3112M	12	5-1/4
J3113M	13	5-1/2
J3114M	14	5-5/8
J3115M	15	5-15/16
J3116M	16	6-1/8
J3117M	17	6-1/2
J3118M	18	6-3/4
J3119M	19	7
J25TR13C	Tool Roll	

 ASME B107.100



7 PIECE ANGLE OPEN END WRENCH SET

Product #: **J3100A**

- › Full polish finish provides corrosion resistance and easy to clean surfaces.
- › 15° and 60° angle heads allow wrench to be used in four different turning angles for greater access in tight work areas.
- › Weight (lbs): 1.02

Contents	Size (in)	Overall Length (in)
J3112	3/8	4-3/4
J3114	7/16	5
J3116	1/2	5-1/4
J3118	9/16	5-5/8
J3120	5/8	6
J3122	11/16	6-1/2
J3124	3/4	7
J25TR07C	Tool Roll	

 ASME B107.100

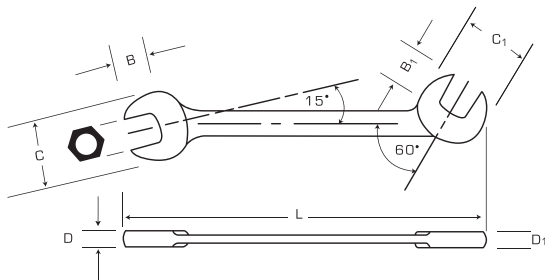

FULL POLISH ANGLE OPEN END WRENCHES

- › Full polish finish provides corrosion and easy to clean surfaces.
- › Double nickel strike for rust resistance and prolonged life.
- › 15° and 60° angle heads combined with the same size opening on both ends allow wrench to be used in four different turning angles for greater access in tight work areas.



Product #	Size (in)	Throat Depth (in) (B)	Outside Head Width (in) (C)	Head Thickness (in) (D)	Throat Depth (in) (B1)	Outside Head Width (in) (C1)	Head Thickness (in) (D1)	Overall Length (in)	Weight (lbs)
J3112	3/8	13/32	3/4	13/64	13/32	3/4	13/64	4-3/4	0.06
J3114	7/16	15/32	7/8	13/64	15/32	7/8	13/64	5	0.08
J3116	1/2	35/64	1	15/64	35/64	1	15/64	5-1/4	0.10
J3118	9/16	39/64	1-7/64	15/64	39/64	1-7/64	15/64	5-5/8	0.14
J3120	5/8	21/32	1-7/32	17/64	21/32	1-7/32	17/64	6	0.17
J3122	11/16	23/32	1-21/64	17/64	23/32	1-21/64	17/64	6-1/2	0.21
J3124	3/4	25/32	1-7/16	9/32	25/32	1-7/16	9/32	7	0.26
J3126	13/16	27/32	1-9/16	19/64	27/32	1-9/16	19/64	7-1/2	0.50
J3128	7/8	57/64	1-21/32	5/16	57/64	1-21/32	5/16	8	0.61
J3130	15/16	31/32	1-25/32	21/64	31/32	1-25/32	21/64	8-3/4	0.71
J3132	1	1-1/32	1-59/64	11/32	1-1/32	1-59/64	11/32	9-1/2	0.88
J3134	1-1/16	1-1/16	2-1/64	23/64	1-1/16	2-1/64	23/64	10-1/4	1.04
J3136	1-1/8	1-1/8	2-1/8	3/8	1-1/8	2-1/8	3/8	11	1.20
J3140	1-1/4	1-1/4	2-11/32	13/32	1-1/4	2-11/32	13/32	12-1/4	1.47
J3142	1-5/16	1-5/16	2-29/64	27/64	1-5/16	2-29/64	27/64	13-1/8	1.87
J3144	1-3/8	1-13/32	2-37/64	7/16	1-13/32	2-37/64	7/16	13-3/4	2.17
J3146	1-7/16	1-13/32	2-5/8	29/64	1-13/32	2-5/8	29/64	14	2.48
J3148	1-1/2	1-31/64	2-3/4	15/32	1-31/64	2-3/4	15/32	14-1/2	2.77
J3152	1-5/8	1-43/64	3-1/64	1/2	1-43/64	3-1/64	1/2	15	3.07
J3156	1-3/4	1-31/32	3-31/64	33/64	1-31/32	3-31/64	33/64	17	3.81
J3158	1-13/16	1-63/64	3-31/64	33/64	1-63/64	3-31/64	33/64	18-3/8	4.56
J3160	1-7/8	2-7/32	3-29/32	21/32	2-7/32	3-29/32	21/32	19-3/4	5.24
J3164	2	2-9/32	3-29/32	21/32	2-9/32	3-29/32	21/32	21-1/4	5.92



ASME B107.100

FULL POLISH METRIC ANGLE OPEN END WRENCHES



- › Full polish finish provides corrosion and easy to clean surfaces.
- › 15° and 60° angle heads allow wrench to be used in four different turning angles for greater access in tight work areas.



Product #	Size (mm)	Throat Depth (in) (B)	Outside Head Width (in) (C)	Head Thickness (in) (D)	Throat Depth (in) (B1)	Outside Head Width (in) (C1)	Head Thickness (in) (D1)	Overall Length (in)	Weight (lbs)
J3109M	9	13/32	49/64	13/64	13/32	49/64	13/64	4-3/4	0.06
J3110M	10	7/16	13/16	13/64	7/16	13/16	13/64	4-7/8	0.07
J3111M	11	15/32	7/8	7/32	15/32	7/8	7/32	5	0.08
J3112M	12	1/2	59/64	15/64	1/2	59/64	15/64	5-1/4	0.10
J3113M	13	17/32	63/64	15/64	17/32	63/64	15/64	5-1/2	0.13
J3114M	14	39/64	1-7/64	1/4	39/64	1-7/64	1/4	5-5/8	0.14
J3115M	15	5/8	1-5/32	17/64	5/8	1-5/32	17/64	5-15/16	0.16
J3116M	16	21/32	1-7/32	17/64	21/32	1-7/32	17/64	6-1/8	0.19
J3117M	17	47/64	1-11/32	9/32	47/64	1-11/32	9/32	6-1/2	0.21
J3118M	18	23/32	1-11/32	9/32	23/32	1-11/32	9/32	6-3/4	0.24
J3119M	19	25/32	1-7/16	9/32	25/32	1-7/16	9/32	7	0.26



ASME B107.100



FACOM® 16 PIECE METRIC SHORT ANGLE OPEN END WRENCH SET

Product #: **FM-34.JL16T**



Contents	Size (mm)	Overall Length (in)
FM-34.3.2	3.2	2-3/4
FM-34.4	4	2-3/4
FM-34.5	5	2-61/64
FM-34.5.5	5.5	2-61/64
FM-34.6	6	3-5/32
FM-34.7	7	3-5/32
FM-34.8	8	3-35/64
FM-34.9	9	3-35/64
FM-34.10	10	3-15/16
FM-34.11	11	3-15/16
FM-34.12	12	3-15/16
FM-34.13	13	4-23/32
FM-34.14	14	4-23/32
FM-34.15	15	5-33/64
FM-34.16	16	5-33/64
FM-34.17	17	5-33/64

- › Satin finish provides corrosion resistance and a slip-resistant grip.
- › 15° and 75° angled heads for fasteners out of standard-tool reach.
- › Short shanks and slim heads.
- › Standard open end configuration.
- › Weight (lbs): 1.12

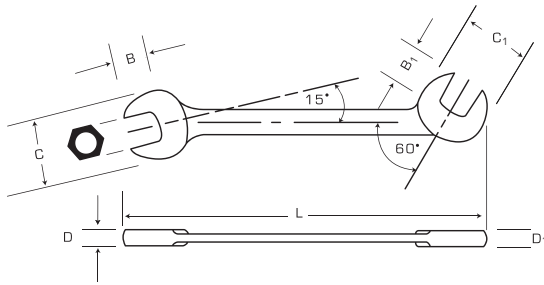

9 PIECE SHORT ANGLE OPEN END WRENCH SET

Product #: **J3300A**

Contents	Size (in)	Overall Length (in)
J3314	7/32	3
J3315	15/64	3
J3316	1/4	3
J3318	9/32	3-1/2
J3320	5/16	3-1/2
J3322	11/32	3-3/4
J3324	3/8	3-3/4
J3328	7/16	4-7/16
J3332	1/2	4-7/16
J25TR26C	Tool Roll	

- › Satin finish.
- › 15° and 75° angle heads.
- › Compact shank design and short length for access in confined spaces.
- › Standard open end configuration.
- › Weight (lbs): 0.46



SHORT SATIN ANGLE OPEN END WRENCHES

- › Satin finish provides corrosion resistance and a slip-resistant grip.
- › 15° and 75° angle heads allow wrench to be used in four different turning angles for greater access in tight work spaces.
- › Compact shank design and short length for access in confined spaces.
- › Standard open end configuration.



Product #	Size (in)	Throat Depth (in) (B)	Outside Head Width (in) (C)	Head Thickness (in) (D)	Throat Depth (in) (B1)	Outside Head Width (in) (C1)	Head Thickness (in) (D1)	Overall Length (in)	Weight (lbs)
J3314	7/32	11/64	1/2	7/64	11/64	1/2	7/64	3	0.03
J3315	15/64	11/64	1/2	7/64	11/64	1/2	7/64	3	0.03
J3316	1/4	11/64	1/2	7/64	11/64	1/2	7/64	3	0.03
J3318	9/32	3/16	19/32	5/32	3/16	19/32	5/32	3-1/2	0.04
J3320	5/16	3/16	19/32	5/32	3/16	19/32	5/32	3-1/2	0.04
J3322	11/32	1/4	3/4	5/32	1/4	3/4	5/32	3-3/4	0.05
J3324	3/8	1/4	3/4	5/32	1/4	3/4	5/32	3-3/4	0.05
J3328	7/16	11/32	1	11/64	11/32	1	11/64	4-7/16	0.08
J3332	1/2	11/32	1	11/64	11/32	1	11/64	4-7/16	0.08
J3336	9/16	13/32	1-5/32	3/16	13/32	1-5/32	3/16	5-3/4	0.10
J3340	5/8	13/32	1-5/32	3/16	13/32	1-5/32	3/16	5-3/4	0.10



ASME B107.100



FACOM® SHORT SATIN METRIC ANGLE OPEN END WRENCHES

- › Satin finish provides corrosion resistance and slip-resistant grip.
- › 15° and 75° angled heads for fasteners out of standard tool reach.
- › Short shanks and slim heads.
- › Standard open end configuration.



Product #	Size (mm)	Outside Head Width (in) (C)	Head Thickness (in) (D)	Outside Head Width (in) (C1)	Head Thickness (in) (D1)	Overall Length (in)	Weight (lbs)
FM-34.3.2	3.2	25/64	3/32	25/64	3/32	2-3/4	0.01
FM-34.4	4	25/64	3/32	25/64	3/32	2-3/4	0.01
FM-34.5	5	33/64	3/32	33/64	3/32	2-61/64	0.02
FM-34.5.5	5.5	33/64	7/64	33/64	7/64	2-61/64	0.02
FM-34.6	6	19/32	7/64	19/32	7/64	3-5/32	0.02
FM-34.7	7	19/32	1/8	19/32	1/8	3-5/32	0.02
FM-34.8	8	47/64	1/8	47/64	1/8	3-35/64	0.04
FM-34.9	9	47/64	1/8	47/64	1/8	3-35/64	0.04
FM-34.10	10	55/64	1/8	55/64	1/8	3-15/16	0.05
FM-34.11	11	55/64	1/8	55/64	1/8	3-15/16	0.05
FM-34.12	12	1-1/16	9/64	1-1/16	9/64	3-15/16	0.08
FM-34.13	13	1-1/16	9/64	1-1/16	9/64	4-23/32	0.08
FM-34.14	14	1-1/16	9/64	1-1/16	9/64	4-23/32	0.08
FM-34.15	15	1-19/64	11/64	1-19/64	11/64	5-33/64	0.15
FM-34.16	16	1-19/64	11/64	1-19/64	11/64	5-33/64	0.14
FM-34.17	17	1-19/64	11/64	1-19/64	11/64	5-33/64	0.14

6 PIECE FACOM® METRIC TAPPET WRENCH SET



Product #: **FM-31.JE6T**

- › Satin finish provides corrosion resistance and a slip-resistant grip.
- › Used to tighten collars, lock nut rings and help seal packing nuts on hydraulic cylinders.
- › Ultra thin profile for use in close quarters.
- › Openings designed to cover tappets, screws and lock nuts with excessive overhang which helps improve access.
- › For use in low torque applications.
- › Standard open end configuration.
- › Weight (lbs): 1.63



Contents	Size (mm)	Overall Length (in)
FM-31.8X9	8 x 9	6-57/64
FM-31.10X11	10 x 11	6-57/64
FM-31.12X13	12 x 13	8-17/64
FM-31.14X15	14 x 15	8-17/64
FM-31.16X17	16 x 17	9-27/32
FM-31.18X19	18 x 19	9-27/32

FACOM® SATIN METRIC TAPPET OPEN END WRENCHES



- › Satin finish provides corrosion resistance and a slip-resistant grip.
- › Used to tighten collars, lock nut rings and help seal packing nuts on hydraulic cylinders.
- › Ultra thin profile for use in close quarters.
- › Openings designed to cover tappets, screws and lock nuts with excessive overhang which helps improve access.
- › For use in low torque applications.
- › Standard open end configuration.



Product #	Size (mm)	Outside Head Width (in) (C)	Head Thickness (in) (D)	Outside Head Width (in) (C1)	Head Thickness (in) (D1)	Overall Length (in)	Weight (lbs)
FM-31.6X7	6 x 7	5/8	5/8	3/4	5/8	5-53/64	0.06
FM-31.8X9	8 x 9	25/32	25/32	31/32	25/32	6-57/64	0.08
FM-31.10X11	10 x 11	25/32	13/16	63/64	13/16	6-57/64	0.08
FM-31.12X13	12 x 13	1-7/64	1-3/32	1-19/64	1-3/32	8-17/64	0.17
FM-31.14X15	14 x 15	1-9/64	1-5/32	1-19/64	1-5/32	8-17/64	0.17
FM-31.16X17	16 x 17	1-33/64	1-17/32	1-11/16	1-17/32	9-27/32	0.31
FM-31.18X19	18 x 19	1-33/64	1-17/32	1-11/16	1-17/32	9-27/32	0.30



13 PIECE IGNITION SET

Product #: **J3200C**

Contents	Size (in)	Overall Length (in)
J3210	13/64 x 15/64	3
J3211	15/64 x 13/64	3
J3215	7/32 x 1/4	3
J3216	1/4 x 7/32	3
J3220	9/32 x 5/16	3-1/2
J3221	5/16 x 9/32	3-1/2
J3225	11/32 x 3/8	3-3/4
J3226	3/8 x 11/32	3-3/4
J000D	Ignition Feeler Gauge Set	
J235	Ignition Pliers	
J2302	Ignition Point File	
J9853	Screw Start	
66-101	Pocket Screwdriver	
J25TR10C	Tool Roll	

- › Satin finish provides corrosion resistance and a slip-resistant grip.
- › 15° and 60° angle heads combined with the same opening size on both ends allows the wrench to be used in four different turning angles.
- › Standard open end wrench configuration.
- › Weight (lbs): 0.67



9 PIECE IGNITION SET

Product #: **J3200D**

Contents	Size (in)	Overall Length (in)
J3210	13/64 x 15/64	3
J3211	15/64 x 13/64	3
J3215	7/32 x 1/4	3
J3216	1/4 x 7/32	3
J3220	9/32 x 5/16	3-1/2
J3221	5/16 x 9/32	3-1/2
J3225	11/32 x 3/8	3-3/4
J3226	3/8 x 11/32	3-3/4
J235	Ignition Pliers	
J25TR09C	Tool Roll	

- › Satin finish provides corrosion resistance and a slip-resistant grip.
- › 15° and 60° angle heads combined with the same opening size on both ends allow the wrench to be used in four different turning angles.
- › Standard open end wrench configuration.
- › Weight (lbs): 0.47

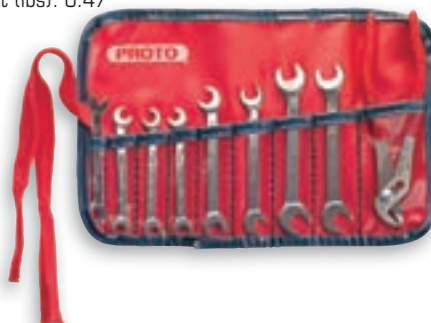

IGNITION WRENCHES

- › Satin finish provides corrosion resistance and a slip-resistant grip.
- › 15° and 60° angle heads combined with the same opening size on both ends allow the wrench to be used in four different turning angles.
- › Standard open end configuration.



Product #	Size (in)	Throat Depth (in) (B)	Outside Head Width (in) (C)	Head Thickness (in) (D)	Throat Depth (in) (B1)	Outside Head Width (in) (C1)	Head Thickness (in) (D1)	Overall Length (in)	Weight (lbs)
J3210	13/64 x 15/64	15/64	1/2	7/64	15/64	1/2	7/64	3	0.02
J3211	15/64 x 13/64	15/64	1/2	7/64	15/64	1/2	7/64	3	0.02
J3215	7/32 x 1/4	15/64	1/2	7/64	15/64	1/2	7/64	3	0.02
J3216	1/4 x 7/32	15/64	1/2	7/64	15/64	1/2	7/64	3	0.02
J3220	9/32 x 5/16	5/16	19/32	5/32	5/16	19/32	5/32	3-1/2	0.03
J3221	5/16 x 9/32	5/16	19/32	5/32	5/16	19/32	5/32	3-1/2	0.03
J3225	11/32 x 3/8	3/8	3/4	5/32	3/8	47/64	5/32	3-3/4	0.05
J3226	3/8 x 11/32	3/8	3/4	5/32	3/8	3/4	5/32	3-3/4	0.05

BLACK OXIDE CHECK NUT WRENCHES

- › Use check nut wrenches to tighten jam nuts, check nuts or lock nuts.
- › In confined spaces, the 15° head allows for a full 30° rotation by flipping wrench over.
- › Ultra thin profile improves access in close quarters.
- › Non-reflective black oxide finish for use where non-plated products are required.



Product #	Size (in)	Outside Head Width (in) (C)	Head Thickness (in) (D)	Overall Length (in)	Weight (lbs)
JKE14	7/16	1	7/32	4	0.05
JKE16	1/2	1	7/32	4	0.05
JKE18	9/16	1-9/32	7/32	4-1/2	0.11
JKE19	19/32	1-9/32	7/32	4-1/2	0.11
JKE20	5/8	1-1/2	7/32	5-1/8	0.13
JKE22	11/16	1-1/2	7/32	5-1/8	0.13
JKE24	3/4	1-23/32	9/32	6-1/8	0.19
JKE26	13/16	2	9/32	6-5/8	0.28
JKE28	7/8	1-25/32	9/32	6-5/8	0.28
JKE30	15/16	2	9/32	7-1/2	0.36
JKE32	1	2	9/32	7-1/2	0.35
JKE34	1-1/16	2-13/32	9/32	8-1/2	0.66
JKE36	1-1/8	2-13/32	9/32	8-1/2	0.65
JKE40	1-1/4	2-23/32	13/32	10	1.12
JKE42	1-5/16	2-23/32	13/32	10	1.12
JKE48	1-1/2	3-7/32	13/32	11-3/8	1.50
JKE52	1-5/8	3-1/2	13/32	13	2.30
JKE54	1-11/16	3-7/16	1/2	13	2.20



THE STORY BEHIND CHECK NUT WRENCHES



The Check Nut Wrench tightens fasteners (sometimes called Lock Nuts or Jam Nuts) that lock other fasteners in place. The thin profile is used to squeeze into a tight space, or to rotate a fastener without moving the one next to it.

Check Nut Wrenches approach the fastener almost straight-on. The slight angle makes it easier for both left- and right-handed work.

SATIN SERVICE WRENCHES

- › Satin finish provides corrosion resistance and a slip-resistant grip.
- › 30° angle head allows access to difficult to reach fasteners.
- › Thin pattern for use on jam nuts, check nuts or lock nuts.
- › Short shank allows for use in confined spaces.



Product #	Size (in)	Throat Depth (in) (B)	Outside Head Width (in) (C)	Head Thickness (in) (D)	Overall Length (in)	Weight (lbs)
J3524	3/4	7/32	1-11/16	1/4	6-1/4	0.22
J3526	13/16	7/32	1-11/16	1/4	6-1/4	0.22
J3528	7/8	7/32	1-11/16	1/4	6-1/4	0.22
J3530	15/16	1/4	1-7/8	1/4	6-7/8	0.25
J3532	1	1/4	1-7/8	1/4	6-7/8	0.25
J3534	1-1/16	1/4	1-7/8	1/4	6-7/8	0.25
J3536	1-1/8	5/16	2-1/16	1/4	7	0.31
J3538	1-3/16	5/16	2-1/16	1/4	7	0.31
J3540	1-1/4	19/64	2-1/16	1/4	7	0.45
J3542	1-5/16	29/64	2-1/2	9/32	7-5/8	0.44
J3544	1-3/8	7/16	2-1/2	9/32	7-5/8	0.43
J3546	1-7/16	7/16	2-1/2	9/32	7-5/8	0.42
J3548	1-1/2	27/64	2-1/2	9/32	7-5/8	0.43
J3550	1-9/16	7/16	2-5/8	9/32	7-5/8	0.43
J3552	1-5/8	7/16	2-5/8	9/32	7-5/8	0.42
J3554	1-11/16	27/64	2-5/8	9/32	7-5/8	0.7
J3556	1-3/4	45/64	3-1/8	5/16	8-1/2	0.69
J3558	1-13/16	11/16	3-1/8	5/16	8-1/2	0.69
J3560	1-7/8	11/16	3-1/8	5/16	8-1/2	0.68
J3562	1-15/16	11/16	3-1/8	5/16	8-1/2	0.68
J3564	2	21/32	3-1/2	5/16	8-1/2	0.66
J3568	2-1/8	21/32	3-1/2	5/16	8-1/2	0.65
J3572	2-1/4	39/64	3-1/2	5/16	8-1/2	0.61
J3576	2-3/8	39/64	3-1/2	5/16	8-1/2	0.61
J3580	2-1/2	19/32	3-1/2	5/16	8-1/2	0.59
J3582	2-9/16	9/16	3-1/2	5/16	8-1/2	0.57



THE STORY BEHIND SERVICE WRENCHES

Service, Check Nut and Tappet wrenches look similar, but they serve different purposes. Used in low-torque situations, they tighten fasteners in automotive or plumbing applications where access is frequently tight and travel is part of the job.

The Service Wrench provides an extra-large head on a short, tapered shank. The 30° angle on the handle allows for double rotation in tight spots by just flipping the wrench.

These wrenches are designed as a small, but strong set of hand wrenches ideal for traveling to various job sites.

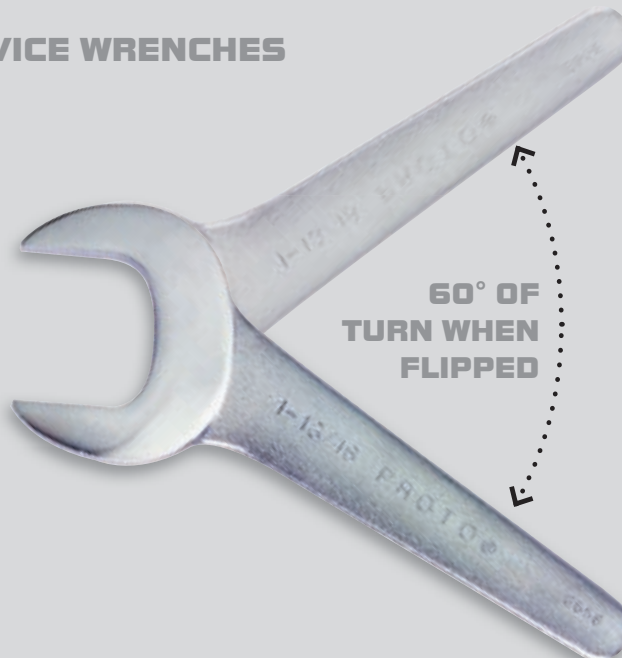

60° OF
TURN WHEN
FLIPPED

SATIN METRIC SERVICE WRENCHES

METRIC

- › Satin finish provides corrosion resistance and a slip-resistant grip.
- › 30° angle head allows access to difficult to reach fasteners.
- › Thin pattern for use on jam nuts, check nuts or lock nuts.
- › Short shank allows for use in confined spaces.



Product #	Size (mm)	Outside Head Width (in) (C)	Head Thickness (in) (D)	Overall Length (in)	Weight (lbs)
J3519M	19	1-11/16	1/4	6-1/4	0.22
J3521M	21	1-11/16	1/4	6-1/4	0.22
J3522M	22	1-11/16	1/4	6-1/4	0.22
J3524M	24	1-7/8	1/4	6-7/8	0.25
J3527M	27	1-7/8	1/4	6-7/8	0.25
J3530M	30	2-1/16	1/4	7	0.31
J3532M	32	2-1/16	1/4	7	0.30
J3536M	36	2-1/2	1/4	7-5/8	0.45
J3537M	37	2-1/2	9/32	7-5/8	0.43
J3538M	38	2-1/2	9/32	7-5/8	0.42
J3540M	40	2-5/8	9/32	7-5/8	0.43
J3541M	41	2-5/8	9/32	7-5/8	0.43
J3542M	42	2-5/8	9/32	7-5/8	0.43
J3544M	44	2-5/8	9/32	7-5/8	0.43
J3546M	46	3-1/8	9/32	7-5/8	0.70
J3548M	48	3-1/8	5/16	8-1/2	0.70
J3550M	50	3-1/8	5/16	8-1/2	0.68
J3552M	52	3-1/2	5/16	8-1/2	0.66
J3555M	55	3-1/2	5/16	8-1/2	0.66
J3560M	60	3-1/2	5/16	8-1/2	0.61
J3565M	65	3-1/2	5/16	8-1/2	0.57



FACOM® INSULATED VSE METRIC OPEN END WRENCHES

- › 2 color warning handle insulation - color changes from orange to yellow if insulation integrity compromised.
- › Specific heat treatment and oiled quenching achieve core hardness without embrittlement or distortion.
- › Size tolerances applied by Facom® exceed standard specifications.

FACOM®

METRIC



Product #	Size (mm)	Outside Head Width (in) (C)	Head Thickness (in) (D)	Overall Length (in)	Weight (lbs)
FM-46.8AVSE	8	55/64	5/16	4-23/32	0.07
FM-46.9AVSE	9	15/16	23/64	4-29/32	0.09
FM-46.10AVSE	10	63/64	23/64	5-1/8	0.11
FM-46.11AVSE	11	1-9/64	25/64	5-5/16	0.12
FM-46.12AVSE	12	1-3/16	25/64	5-5/16	0.14
FM-46.13AVSE	13	1-17/64	7/16	5-29/32	0.17
FM-46.14AVSE	14	1-11/32	7/16	6-5/16	0.20
FM-46.15AVSE	15	1-27/64	7/16	6-5/16	0.20
FM-46.16AVSE	16	1-1/2	15/32	6-11/16	0.26
FM-46.17AVSE	17	1-39/64	15/32	7-3/32	0.29
FM-46.18AVSE	18	1-21/32	15/32	7-3/32	0.33
FM-46.19AVSE	19	1-49/64	15/32	7-11/16	0.34
FM-46.21AVSE	21	1-31/32	35/64	7-9/32	0.40

6 PIECE 1/4" DRIVE CROWFOOT WRENCH SET

Product #: J47000CF

- › Crowfoot wrenches are used in hard to reach, restricted access situations where a standard wrench or ratchet cannot reach.
- › Anti-Slip Design open end (ASD).
- › The arched surfaces are designed to spread the contact forces over a greater area and they keep the loads off the corners of the fastener which helps prevent fastener rounding.
- › Broad size range ensures the right tool for the application will be available.
- › Typically used in lower torque applications.
- › Full Polish finish provides corrosion resistance and easy to clean surfaces.
- › Use with locking extensions to reach into spaces too small for a mechanic's arm or where the fastener is out of site.
- › Weight (lbs): 0.41



Contents	Size (in)	Overall Length (in)
J4708CF	1/4	15/16
J4710CF	5/16	1
J4712CF	3/8	1-1/16
J4714CF	7/16	1-5/32
J4716CF	1/2	1-3/16
J4718CF	9/16	1-9/32

 ASME B107.21

8 PIECE 1/4" DRIVE CROWFOOT WRENCH SET WITH LOCKING EXTENSIONS

Product #: **J47000CFL**

- › Crowfoot wrenches are used in hard to reach, restricted access situations where a standard wrench or ratchet cannot reach
- › Anti-Slip Design open end (ASD).
- › The arched surfaces are designed to spread the contact forces over a greater area and they keep the loads off the corners of the fastener which helps prevent fastener rounding.
- › Broad size range ensures the right tool for the application will be available.
- › Typically used in lower torque applications.
- › Full Polish finish provides corrosion resistance and easy to clean surfaces.
- › Use with locking extensions to reach into spaces too small for a mechanic's arm or where the fastener is out of site.
- › Weight (lbs): 0.63

Contents	Size (in)	Overall Length (in)
J4708CF	1/4	15/16
J4710CF	5/16	1
J4712CF	3/8	1-1/16
J4714CF	7/16	1-5/32
J4716CF	1/2	1-3/16
J4718CF	9/16	1-9/32
J4761L	Locking Extension	6
J4759L	Locking Extension	2



ASME B107.21



7 PIECE 1/4" DRIVE METRIC CROWFOOT WRENCH SET

METRIC

Product #: **J47000MCF**

- › Crowfoot wrenches are used in hard to reach, restricted access situations where a standard wrench or ratchet cannot reach.
- › Anti-Slip Design open end (ASD).
- › The arched surfaces are designed to spread the contact forces over a greater area and they keep the loads off the corners of the fastener which helps prevent fastener rounding.
- › Broad size range ensures the right tool for the application will be available.
- › Typically used in lower torque applications.
- › Full Polish finish provides corrosion resistance and easy to clean surfaces.
- › Use with locking extensions to reach into spaces too small for a mechanic's arm or where the fastener is out of site.
- › Weight (lbs): 0.47

Contents	Size (mm)	Overall Length (in)
J4707MCF	7	15/16
J4708MCF	8	31/32
J4710MCF	10	1-1/16
J4711MCF	11	1-1/8
J4712MCF	12	1-5/32
J4713MCF	13	1-3/16
J4714MCF	14	1-1/4



ASME B107.21



53 PIECE 3/8" DRIVE CROWFOOT WRENCH SET

Product #: **J49000CFL**

Contents	Size (in)	Point Count	Overall Length (in)
J4912CF	3/8	-	1-13/64
J4914CF	7/16	-	1-3/16
J4916CF	1/2	-	1-5/16
J4918CF	9/16	-	1-9/32
J4920CF	5/8	-	1-1/2
J4922CF	11/16	-	1-31/64
J4924CF	3/4	-	1-41/64
J4926CF	13/16	-	1-5/8
J4928CF	7/8	-	1-19/32
J4930CF	15/16	-	1-5/8
J4932CF	1	-	1-49/64
J4934CF	1-1/16	-	2-3/16
J4936CF	1-1/8	-	2-7/32
J4938CF	1-3/16	-	2-9/32
J4940CF	1-1/4	-	2-5/32
J4942CF	1-5/16	-	2-1/2
J4944CF	1-3/8	-	2-1/2
J4946CF	1-7/16	-	2-5/8
J4948CF	1-1/2	-	2-11/16
J4950CF	1-9/16	-	2-3/4
J4952CF	1-5/8	-	2-13/16
J4954CF	1-11/16	-	2-15/16
J4956CF	1-3/4	-	2-15/16
J4958CF	1-13/16	-	3-1/16
J4960CF	1-7/8	-	3-1/8
J4962CF	1-15/16	-	3-1/4
J4964CF	2	-	3-3/8
J4966CF	2-1/16	-	3-7/16
J4968CF	2-1/8	-	3-7/16
J4970CF	2-3/16	-	3-5/8
J4972CF	2-1/4	-	3-11/16
J4974CF	2-5/16	-	3-3/4
J4976CF	2-3/8	-	3-15/16
J4978CF	2-7/16	-	4-1/4
J4980CF	2-1/2	-	4-1/4
J4982CF	2-9/16	-	4-5/16
J4984CF	2-5/8	-	4-1/2
J4986CF	2-11/16	-	4-9/16
J4988CF	2-3/4	-	4-11/16
J4990CF	2-13/16	-	4-13/16
J4992CF	2-7/8	-	4-15/16
J4994CF	2-15/16	-	4-15/16
J4996CF	3	-	5
J4920FL	5/8	12	-
J4922FL	11/16	12	-
J4924FL	3/4	12	-
J4926FL	13/16	12	-
J4928FL	7/8	12	-
J4930FL	15/16	12	-
J4932FL	1	12	-
J4934FL	1-1/16	12	-
J5262L	Locking Extension	-	12
J5260-06L	Locking Extension	-	6



ASME B107.21

- › Crowfoot wrenches are used in hard to reach, restricted access situations where a standard wrench or ratchet cannot reach.
- › Anti-Slip Design open end (ASD).
- › The arched surfaces are designed to spread the contact forces over a greater area and they keep the loads off the corners of the fastener which helps prevent fastener rounding.
- › Broad size range ensures the right tool for the application will be available.
- › Typically used in lower torque applications.
- › Full polish finish provides corrosion resistance and easy to clean surfaces.
- › Locking hole feature helps keep the crowfoot wrench engaged on the extension during use reducing downtime due to detachment of crowfoot in awkward spaces.
- › Use with locking extensions to reach into small spaces or where the fastener is out of sight.
- › Locking hole on 3/8" drive crowfoot wrenches available on fractional openings 1" and larger.
- › Weight (lbs): 26.14



43 PIECE 3/8" DRIVE CROWFOOT WRENCH SET

Product #: **J49001CF**

Contents	Size (in)	Overall Length (in)
J4912CF	3/8	1-13/64
J4914CF	7/16	1-3/16
J4916CF	1/2	1-5/16
J4918CF	9/16	1-9/32
J4920CF	5/8	1-1/2
J4922CF	11/16	1-31/64
J4924CF	3/4	1-41/64
J4926CF	13/16	1-5/8
J4928CF	7/8	1-19/32
J4930CF	15/16	1-5/8
J4932CF	1	1-49/64
J4934CF	1-1/16	2-3/16
J4936CF	1-1/8	2-7/32
J4938CF	1-3/16	2-9/32
J4940CF	1-1/4	2-5/32
J4942CF	1-5/16	2-1/2
J4944CF	1-3/8	2-1/2
J4946CF	1-7/16	2-5/8
J4948CF	1-1/2	2-11/16
J4950CF	1-9/16	2-3/4
J4952CF	1-5/8	2-13/16
J4954CF	1-11/16	2-15/16
J4956CF	1-3/4	2-15/16
J4958CF	1-13/16	3-1/16
J4960CF	1-7/8	3-1/8
J4962CF	1-15/16	3-1/4
J4964CF	2	3-3/8
J4966CF	2-1/16	3-7/16
J4968CF	2-1/8	3-7/16
J4970CF	2-3/16	3-5/8
J4972CF	2-1/4	3-11/16
J4974CF	2-5/16	3-3/4
J4976CF	2-3/8	3-15/16
J4978CF	2-7/16	4-1/4
J4980CF	2-1/2	4-1/4
J4982CF	2-9/16	4-5/16
J4984CF	2-5/8	4-1/2
J4986CF	2-11/16	4-9/16
J4988CF	2-3/4	4-11/16
J4990CF	2-13/16	4-13/16
J4992CF	2-7/8	4-15/16
J4994CF	2-15/16	4-15/16
J4996CF	3	5



ASME B107.21

- › Crowfoot wrenches are used in hard to reach, restricted access situations where a standard wrench or ratchet cannot reach.
- › Anti-Slip Design open end (ASD).
- › The arched surfaces are designed to spread the contact forces over a greater area and they keep the loads off the corners of the fastener which helps prevent fastener rounding.
- › Broad size range ensures the right tool for the application will be available.
- › Typically used in lower torque applications.
- › Full polish finish provides corrosion resistance and easy to clean surfaces.
- › Locking hole feature helps keep the crowfoot wrench engaged on the extension during use reducing downtime due to detachment of crowfoot in awkward spaces.
- › Use with locking extensions to reach into small spaces or where the fastener is out of sight.
- › Locking hole on 3/8" drive crowfoot wrenches available on fractional openings 1" and larger.
- › Weight (lbs): 23.92



27 PIECE 3/8" DRIVE CROWFOOT WRENCH SET

Product #: **J49002CF**

Contents	Size (in)	Overall Length (in)
J4912CF	3/8	1-13/64
J4914CF	7/16	1-3/16
J4916CF	1/2	1-5/16
J4918CF	9/16	1-9/32
J4920CF	5/8	1-1/2
J4922CF	11/16	1-31/64
J4924CF	3/4	1-41/64
J4926CF	13/16	1-5/8
J4928CF	7/8	1-19/32
J4930CF	15/16	1-5/8
J4932CF	1	1-49/64
J4934CF	1-1/16	2-3/16
J4936CF	1-1/8	2-7/32
J4938CF	1-3/16	2-9/32
J4940CF	1-1/4	2-5/32
J4942CF	1-5/16	2-1/2
J4944CF	1-3/8	2-1/2
J4946CF	1-7/16	2-5/8
J4948CF	1-1/2	2-11/16
J4950CF	1-9/16	2-3/4
J4952CF	1-5/8	2-13/16
J4954CF	1-11/16	2-15/16
J4956CF	1-3/4	2-15/16
J4958CF	1-13/16	3-1/16
J4960CF	1-7/8	3-1/8
J4962CF	1-15/16	3-1/4
J4964CF	2	3-3/8



ASME B107.21

- › Crowfoot wrenches are used in hard to reach, restricted access situations where a standard wrench or ratchet cannot reach.
- › Anti-Slip Design open end (ASD).
- › The arched surfaces are designed to spread the contact forces over a greater area and they keep the loads off the corners of the fastener which helps prevent fastener rounding.
- › Broad size range ensures the right tool for the application will be available.
- › Typically used in lower torque applications.
- › Full polish finish provides corrosion resistance and easy to clean surfaces.
- › Locking hole feature helps keep the crowfoot wrench engaged on the extension during use reducing downtime due to detachment of crowfoot in awkward spaces.
- › Use with locking extensions to reach into small spaces or where the fastener is out of sight.
- › Locking hole on 3/8" drive crowfoot wrenches available on fractional openings 1" and larger.
- › Weight (lbs): 6.74



16 PIECE 3/8" DRIVE METRIC CROWFOOT WRENCH SET**METRIC****Product #: J49000-MCF**

Contents	Size (mm)	Overall Length (in)
J4909MCF	9	1-5/6
J4910MCF	10	1-11/32
J4911MCF	11	1-3/8
J4912MCF	12	1-15/32
J4913MCF	13	1-1/2
J4914MCF	14	1-1/2
J4915MCF	15	1-5/8
J4916MCF	16	1-21/32
J4917MCF	17	1-23/32
J4918MCF	18	1-15/16
J4919MCF	19	1-15/16
J4920MCF	20	2-1/16
J4921MCF	21	2-3/32
J4922MCF	22	2-7/32
J4923MCF	23	2-11/32
J4924MCF	24	2-13/32



ASME B107.21

- › Crowfoot wrenches are used in hard to reach, restricted access situations where a standard wrench or ratchet cannot reach.
- › Anti-Slip Design open end (ASD).
- › The arched surfaces are designed to spread the contact forces over a greater area and they keep the loads off the corners of the fastener which helps prevent fastener rounding.
- › Broad size range ensures the right tool for the application will be available.
- › Typically used in lower torque applications.
- › Full polish finish provides corrosion resistance and easy to clean surfaces.
- › Weight (lbs): 2.59

**15 PIECE 3/8" DRIVE CROWFOOT WRENCH SET****Product #: J49003CF**

Contents	Size (in)	Overall Length (in)
J4912CF	3/8	1-13/64
J4914CF	7/16	1-3/16
J4916CF	1/2	1-5/16
J4918CF	9/16	1-9/32
J4920CF	5/8	1-1/2
J4922CF	11/16	1-31/64
J4924CF	3/4	1-41/64
J4926CF	13/16	1-5/8
J4928CF	7/8	1-19/32
J4930CF	15/16	1-5/8
J4932CF	1	1-49/64
J4934CF	1-1/16	2-3/16
J4936CF	1-1/8	2-7/32
J4938CF	1-3/16	2-9/32
J4940CF	1-1/4	2-5/32



ASME B107.21

- › Crowfoot wrenches are used in hard to reach, restricted access situations where a standard wrench or ratchet cannot reach.
- › Anti-Slip Design open end (ASD).
- › The arched surfaces are designed to spread the contact forces over a greater area and they keep the loads off the corners of the fastener which helps prevent fastener rounding.
- › Broad size range ensures the right tool for the application will be available.
- › Typically used in lower torque applications.
- › Full polish finish provides corrosion resistance and easy to clean surfaces.
- › Locking hole feature helps keep the crowfoot wrench engaged on the extension during use reducing downtime due to detachment of crowfoot in awkward spaces.
- › Use with locking extensions to reach into small spaces or where the fastener is out of sight.
- › Locking hole on 3/8" drive crowfoot wrenches available on fractional openings 1" and larger.
- › Weight (lbs): 2.07



9 PIECE 3/8" DRIVE CROWFOOT WRENCH SET

Product #: **J49004CF**

- › Crowfoot wrenches are used in hard to reach, restricted access situations where a standard wrench or ratchet cannot reach.
- › Anti-Slip Design open end (ASD).
- › The arched surfaces are designed to spread the contact forces over a greater area and they keep the loads off the corners of the fastener which helps prevent fastener rounding.
- › Broad size range ensures the right tool for the application will be available.
- › Typically used in lower torque applications.
- › Full polish finish provides corrosion resistance and easy to clean surfaces.
- › Locking hole feature helps keep the crowfoot wrench engaged on the extension during use reducing downtime due to detachment of crowfoot in awkward spaces.
- › Use with locking extensions to reach into small spaces or where the fastener is out of sight.
- › Locking hole on 3/8" drive crowfoot wrenches available on fractional openings 1" and larger.
- › Weight (lbs): 0.83

Contents	Size (in)	Overall Length (in)
J4912CF	3/8	1-13/64
J4914CF	7/16	1-3/16
J4916CF	1/2	1-5/16
J4918CF	9/16	1-9/32
J4920CF	5/8	1-1/2
J4922CF	11/16	1-31/64
J4924CF	3/4	1-41/64
J4926CF	13/16	1-5/8
J4928CF	7/8	1-19/32



ASME B107.21



22 PIECE 1/2" DRIVE CROWFOOT WRENCH SET

Product #: **J5300CF**

Contents	Size (in)	Overall Length (in)
J5330CF	15/16	2-13/16
J5332CF	1	2-13/16
J5334CF	1-1/16	2-7/8
J5336CF	1-1/8	3
J5338CF	1-3/16	3
J5340CF	1-1/4	3-5/16
J5342CF	1-5/16	3-5/16
J5344CF	1-3/8	3-3/8
J5346CF	1-7/16	3-3/8
J5348CF	1-1/2	3-7/16
J5350CF	1-9/16	3-1/2
J5352CF	1-5/8	3-1/2
J5354CF	1-11/16	3-13/16
J5356CF	1-3/4	3-13/16
J5358CF	1-13/16	3-7/8
J5360CF	1-7/8	3-7/8
J5364CF	2	3-15/16
J5368CF	2-1/8	4-1/16
J5372CF	2-1/4	4-3/8
J5376CF	2-3/8	4-7/16
J5378CF	2-7/16	4-7/16
J5380CF	2-1/2	4-1/2



ASME B107.21



- › Crowfoot wrenches are used in hard to reach, restricted access situations where a standard wrench or ratchet cannot reach.
- › Anti-Slip Design open end (ASD).
- › The arched surfaces are designed to spread the contact forces over a greater area and they keep the loads off the corners of the fastener which helps prevent fastener rounding.
- › Broad size range ensures the right tool for the application will be available.
- › Typically used in lower torque applications.
- › Full polish finish provides corrosion resistance and easy to clean surfaces.
- › Weight (lbs): 16.35

15 PIECE 1/2" DRIVE CROWFOOT WRENCH SET

Product #: **J53001CF**

Contents	Size (in)	Overall Length (in)
J5334CF	1-1/16	2-7/8
J5336CF	1-1/8	3
J5338CF	1-3/16	3
J5340CF	1-1/4	3-5/16
J5342CF	1-5/16	3-5/16
J5344CF	1-3/8	3-3/8
J5346CF	1-7/16	3-3/8
J5348CF	1-1/2	3-7/16
J5350CF	1-9/16	3-1/2
J5352CF	1-5/8	3-1/2
J5354CF	1-11/16	3-13/16
J5356CF	1-3/4	3-13/16
J5358CF	1-13/16	3-7/8
J5360CF	1-7/8	3-7/8
J5364CF	2	3-15/16



ASME B107.21

- › Crowfoot wrenches are used in hard to reach, restricted access situations where a standard wrench or ratchet cannot reach.
- › Anti-Slip Design open end (ASD).
- › The arched surfaces are designed to spread the contact forces over a greater area and they keep the loads off the corners of the fastener which helps prevent fastener rounding.
- › Broad size range ensures the right tool for the application will be available.
- › Typically used in lower torque applications.
- › Full polish finish provides corrosion resistance and easy to clean surfaces.
- › Weight (lbs): 9.88



1/4" DRIVE FULL POLISH CROWFOOT WRENCHES

- › Crowfoot wrenches are used in hard to reach, restricted access situations where a standard wrench or ratchet cannot reach.
- › Anti-Slip Design Open End (ASD).
- › The arched surfaces are designed to spread the contact forces over a greater area and they keep the loads off the corners of the fastener which helps prevent fastener rounding.
- › Broad size range ensures the right tool for the application will be available.
- › Typically used in lower torque applications.
- › Full Polish finish provides corrosion resistance and easy to clean surfaces.

Product #	Size (in)	Overall Length (in)	Weight (lbs)
J4708CF	1/4	15/16	0.02
J4710CF	5/16	1	0.03
J4712CF	3/8	1-1/16	0.03
J4714CF	7/16	1-5/32	0.04
J4716CF	1/2	1-3/16	0.05
J4718CF	9/16	1-9/32	0.05



ASME B107.21



1/4" DRIVE FULL POLISH METRIC CROWFOOT WRENCHES

METRIC

- › Crowfoot wrenches are used in hard to reach, restricted access situations where a standard wrench or ratchet cannot reach.
- › Anti-Slip Design Open End (ASD).
- › The arched surfaces are designed to spread the contact forces over a greater area and they keep the loads off the corners of the fastener which helps prevent fastener rounding.
- › Broad size range ensures the right tool for the application will be available.
- › Typically used in lower torque applications.
- › Full Polish finish provides corrosion resistance and easy to clean surfaces.

Product #	Size (mm)	Overall Length (in)	Weight (lbs)
J4707MCF	7	15/16	0.02
J4708MCF	8	31/32	0.02
J4710MCF	10	1-1/16	0.03
J4711MCF	11	1-1/8	0.04
J4712MCF	12	1-5/32	0.04
J4713MCF	13	1-3/16	0.05
J4714MCF	14	1-1/4	0.05



ASME B107.21



3/8" DRIVE FULL POLISH CROWFOOT WRENCHES

Product #	Size (in)	Overall Length (in)	Weight (lbs)
J4912CF	3/8	1-13/64	0.06
J4914CF	7/16	1-3/16	0.06
J4916CF	1/2	1-5/16	0.07
J4918CF	9/16	1-9/32	0.07
J4920CF	5/8	1-1/2	0.09
J4922CF	11/16	1-31/64	0.09
J4924CF	3/4	1-41/64	0.11
J4926CF	13/16	1-5/8	0.11
J4928CF	7/8	1-19/32	0.12
J4930CF	15/16	1-5/8	0.13
J4932CF	1	1-49/64	0.13
J4934CF	1-1/16	2-3/16	0.24
J4936CF	1-1/8	2-7/32	0.24
J4938CF	1-3/16	2-9/32	0.24
J4940CF	1-1/4	2-5/32	0.21
J4942CF	1-5/16	2-1/2	0.25
J4944CF	1-3/8	2-1/2	0.29
J4946CF	1-7/16	2-5/8	0.29
J4948CF	1-1/2	2-11/16	0.33
J4950CF	1-9/16	2-3/4	0.34
J4952CF	1-5/8	2-13/16	0.38
J4954CF	1-11/16	2-15/16	0.36
J4956CF	1-3/4	2-15/16	0.39
J4958CF	1-13/16	3-1/16	0.4
J4960CF	1-7/8	3-1/8	0.45
J4962CF	1-15/16	3-1/4	0.49
J4964CF	2	3-3/8	0.73
J4966CF	2-1/16	3-7/16	0.71
J4968CF	2-1/8	3-7/16	0.74
J4970CF	2-3/16	3-5/8	0.78
J4972CF	2-1/4	3-11/16	0.89
J4974CF	2-5/16	3-3/4	0.9
J4976CF	2-3/8	3-15/16	1.01
J4978CF	2-7/16	4-1/4	1.03
J4980CF	2-1/2	4-1/4	1.1
J4982CF	2-9/16	4-5/16	1.11
J4984CF	2-5/8	4-1/2	1.27
J4986CF	2-11/16	4-9/16	1.34
J4988CF	2-3/4	4-11/16	1.37
J4990CF	2-13/16	4-13/16	1.38
J4992CF	2-7/8	4-15/16	1.52
J4994CF	2-15/16	4-15/16	1.58
J4996CF	3	5	1.55



ASME B107.21

- › Crowfoot wrenches are used in hard to reach, restricted access situations where a standard wrench or ratchet cannot reach.
- › Anti-Slip Design Open End (ASD).
- › The arched surfaces are designed to spread the contact forces over a greater area and they keep the loads off the corners of the fastener which helps prevent fastener rounding.
- › Broad size range ensures the right tool for the application will be available.
- › Typically used in lower torque applications.
- › Full Polish finish provides corrosion resistance and easy to clean surfaces.
- › Locking hole on 3/8" drive crowfoot wrenches available on fractional openings 1" and larger.



FEATURES AND BENEFITS — ANTI-SLIP DESIGN (ASD)

The Anti-Slip Design consists of two features:

- › A notch to lock the fastener in place.
- › A curve for greater contact area against the fastener.

An ASD Wrench does not apply load to the corners of the fastener, so it helps to prevent rounding. Because of the greater surface contact, the wrench can also successfully apply greater torque without slipping.

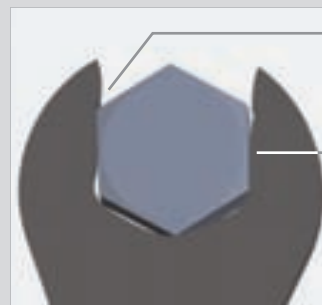

The groove locks the fastener in place.

The curved edge grips the flat of the bolt for a better grip and less rounding.

3/8" DRIVE FULL POLISH METRIC CROWFOOT WRENCHES**METRIC**

- › Crowfoot wrenches are used in hard to reach, restricted access situations where a standard wrench or ratchet cannot reach.
- › Anti-Slip Design Open End (ASD).
- › The arched surfaces are designed to spread the contact forces over a greater area and they keep the loads off the corners of the fastener which helps prevent fastener rounding.
- › Broad size range ensures the right tool for the application will be available.
- › Typically used in lower torque applications.
- › Full Polish finish provides corrosion resistance and easy to clean surfaces.
- › Locking hole feature helps keep the crowfoot wrench engaged on the extension during use reducing downtime due to detachment of crowfoot in awkward spaces.
- › Use with locking extensions to reach into spaces too small for a mechanic's arm or where the fastener is out of site.
- › Locking hole on 3/8" drive crowfoot wrenches available on fractional openings 1" and larger.

Product #	Size (mm)	Overall Length (in)	Weight (lbs)
J4909MCF	9	1-5/6	0.05
J4910MCF	10	1-11/32	0.05
J4911MCF	11	1-3/8	0.07
J4912MCF	12	1-15/32	0.07
J4913MCF	13	1-1/2	0.06
J4914MCF	14	1-1/2	0.07
J4915MCF	15	1-5/8	0.10
J4916MCF	16	1-21/32	0.09
J4917MCF	17	1-23/32	0.10
J4918MCF	18	1-15/16	0.13
J4919MCF	19	1-15/16	0.13
J4920MCF	20	2-1/16	0.13
J4921MCF	21	2-3/32	0.14
J4922MCF	22	2-7/32	0.15
J4923MCF	23	2-11/32	0.19
J4924MCF	24	2-13/32	0.19



ASME B107.21

**1/2" DRIVE FULL POLISH CROWFOOT WRENCHES**

Product #	Size (in)	Overall Length (in)	Weight (lbs)
J5330CF	15/16	2-13/16	0.47
J5332CF	1	2-13/16	0.46
J5334CF	1-1/16	2-7/8	0.51
J5336CF	1-1/8	3	0.54
J5338CF	1-3/16	3	0.58
J5340CF	1-1/4	3-5/16	0.66
J5342CF	1-5/16	3-5/16	0.66
J5344CF	1-3/8	3-3/8	0.72
J5346CF	1-7/16	3-3/8	0.75
J5348CF	1-1/2	3-7/16	0.77
J5350CF	1-9/16	3-1/2	0.80
J5352CF	1-5/8	3-1/2	0.83
J5354CF	1-11/16	3-13/16	0.95
J5356CF	1-3/4	3-13/16	0.98
J5358CF	1-13/16	3-7/8	1.01
J5360CF	1-7/8	3-7/8	1.05
J5364CF	2	3-15/16	1.10
J5368CF	2-1/8	4-1/16	1.09
J5372CF	2-1/4	4-3/8	1.27
J5376CF	2-3/8	4-7/16	1.29
J5378CF	2-7/16	4-7/16	1.28
J5380CF	2-1/2	4-1/2	1.25



ASME B107.21

- › Crowfoot wrenches are used in hard to reach, restricted access situations where a standard wrench or ratchet cannot reach.
- › Anti-Slip Design Open End (ASD).
- › The arched surfaces are designed to spread the contact forces over a greater area and they keep the loads off the corners of the fastener which helps prevent fastener rounding.
- › Broad size range ensures the right tool for the application will be available.
- › Typically used in lower torque applications.
- › Full Polish finish provides corrosion resistance and easy to clean surfaces.
- › Locking hole feature helps keep the crowfoot wrench engaged on the extension during use reducing downtime due to detachment of crowfoot in awkward spaces.
- › Use with locking extensions to reach into spaces too small for a mechanic's arm or where the fastener is out of site.



1/2" DRIVE FULL POLISH METRIC CROWFOOT WRENCHES

METRIC

Product #	Size (mm)	Overall Length (in)	Weight (lbs)
J5320MCF	20	2-19/32	0.43
J5321MCF	21	2-37/64	0.43
J5322MCF	22	2-13/16	0.45
J5323MCF	23	2-13/16	0.47
J5324MCF	24	2-51/64	0.47
J5325MCF	25	2-27/32	0.48
J5326MCF	26	2-29/32	0.49
J5327MCF	27	2-29/32	0.51
J5328MCF	28	3	0.54
J5329MCF	29	3-1/32	0.58
J5330MCF	30	3-1/32	0.66
J5332MCF	32	3-19/64	0.66
J5335MCF	35	3-23/64	0.72
J5336MCF	36	3-13/32	0.75
J5338MCF	38	3-7/16	0.77
J5341MCF	41	3-1/2	0.83
J5342MCF	42	3-51/64	0.95
J5346MCF	46	3-55/64	1.01



ASME B107.21

- › Crowfoot wrenches are used in hard to reach, restricted access situations where a standard wrench or ratchet cannot reach.
- › Anti-Slip Design Open End (ASD).
- › The arched surfaces are designed to spread the contact forces over a greater area and they keep the loads off the corners of the fastener which helps prevent fastener rounding.
- › Broad size range ensures the right tool for the application will be available.
- › Typically used in lower torque applications.
- › Full Polish finish provides corrosion resistance and easy to clean surfaces.
- › Locking hole feature helps keep the crowfoot wrench engaged on the extension during use reducing downtime due to detachment of crowfoot in awkward spaces.
- › Use with locking extensions to reach into spaces too small for a mechanic's arm or where the fastener is out of site.



WRENCHES



CROWFOOT

8 PIECE 3/8" DRIVE FLARE NUT CROWFOOT WRENCH SET

Product #: J4900CFFN

- › Crowfoot wrenches are used in hard to reach, restricted access situations where a standard wrench or ratchet cannot reach.
- › Broad size range ensures the right tool for the application will be available.
- › Typically used in lower torque applications.
- › Full polish finish provides corrosion resistance and easy to clean surfaces.
- › 12 point flare nut end allows for fine indexing, helping to improve speed and access. Fits 4, 6 and 12 point fasteners.
- › Weight (lbs): 1.15

Contents	Size (in)	Point Count
J4920FL	5/8	12
J4922FL	11/16	12
J4924FL	3/4	12
J4926FL	13/16	12
J4928FL	7/8	12
J4930FL	15/16	12
J4932FL	1	12
J4934FL	1-1/16	12



ASME B107.21



39 PIECE 1/2" DRIVE CROWFOOT WRENCH SET

Product #: **J53000CLFN**

Contents	Size (in)	Point Count	Overall Length (in)
J5330CF	15/16	–	2-13/16
J5332CF	1	–	2-13/16
J5334CF	1-1/16	–	2-7/8
J5336CF	1-1/8	–	3
J5338CF	1-3/16	–	3
J5340CF	1-1/4	–	3-5/16
J5342CF	1-5/16	–	3-5/16
J5344CF	1-3/8	–	3-3/8
J5346CF	1-7/16	–	3-3/8
J5348CF	1-1/2	–	3-7/16
J5350CF	1-9/16	–	3-1/2
J5352CF	1-5/8	–	3-1/2
J5354CF	1-11/16	–	3-13/16
J5356CF	1-3/4	–	3-13/16
J5358CF	1-13/16	–	3-7/8
J5360CF	1-7/8	–	3-7/8
J5364CF	2	–	3-15/16
J5368CF	2-1/8	–	4-1/16
J5372CF	2-1/4	–	4-3/8
J5376CF	2-3/8	–	4-7/16
J5378CF	2-7/16	–	4-7/16
J5380CF	2-1/2	–	4-1/2
J5336FL	1-1/8	12	2-13/16
J5338FL	1-3/16	12	2-7/8
J5340FL	1-1/4	12	3
J5342FL	1-5/16	12	3-1/16
J5344FL	1-3/8	12	3-5/16
J5346FL	1-7/16	12	3-3/8
J5348FL	1-1/2	12	3-7/16
J5350FL	1-9/16	12	3-9/16
J5352FL	1-5/8	12	3-3/4
J5354FL	1-11/16	12	3-13/16
J5356FL	1-3/4	12	3-7/8
J5358FL	1-13/16	12	4
J5360FL	1-7/8	12	4-1/4
J5362FL	1-15/16	12	4-5/16
J5364FL	2	12	4-7/16
J5461L	Locking Extension	–	5
J5463L	Locking Extension	–	10

 ASME B107.21

- › Crowfoot wrenches are used in hard to reach, restricted access situations where a standard wrench or ratchet cannot reach.
- › The arched surfaces are designed to spread the contact forces over a greater area and they keep the loads off the corners of the fastener which helps prevent fastener rounding.
- › 12 point allows for fine indexing, helping to improve speed and access.
- › Fits 4, 6 and 12 point fasteners.
- › Use with locking extensions to reach into small spaces or where the fastener is out of sight.
- › Locking hole feature helps keep the crowfoot wrench engaged on the extension during use, helping to reduce downtime due to the detachment of the crowfoot in an awkward space.
- › Broad size range ensures the right tool for the application will be available.
- › Typically used in lower torque applications.
- › Full polish finish provides corrosion resistance and easy to clean surfaces.
- › Weight (lbs): 23.80



15 PIECE 1/2" DR CROWFOOT FLARE NUT WRENCH SET

Product #: **J53000CFFN**

Contents	Size (in)	Point Count	Overall Length (in)
J5336FL	1-1/8	12	2-13/16
J5338FL	1-3/16	12	2-7/8
J5340FL	1-1/4	12	3
J5342FL	1-5/16	12	3-1/16
J5344FL	1-3/8	12	3-5/16
J5346FL	1-7/16	12	3-3/8
J5348FL	1-1/2	12	3-7/16
J5350FL	1-9/16	12	3-9/16
J5352FL	1-5/8	12	3-3/4
J5354FL	1-11/16	12	3-13/16
J5356FL	1-3/4	12	3-7/8
J5358FL	1-13/16	12	4
J5360FL	1-7/8	12	4-1/4
J5362FL	1-15/16	12	4-5/16
J5364FL	2	12	4-7/16



ASME B107.21

- › Crowfoot wrenches are used in hard to reach, restricted access situations where a standard wrench or ratchet cannot reach.
- › 12 point flare nut allows for fine indexing, helping to improve speed and access.
- › Fits 4, 6 and 12 point fasteners.
- › Broad size range ensures the right tool for the application will be available.
- › Typically used in lower torque applications.
- › Full polish finish provides corrosion resistance and easy to clean surfaces.
- › Weight (lbs): 5.86



3/8" DRIVE FULL POLISH FLARE NUT CROWFOOT WRENCHES - 12 POINT

- › Designed for speed and safety.
- › Special heat-treated alloy steel helps increase strength and durability.
- › 12 Point Box end allows for fine indexing, helping to improve speed and access. Fits 4, 6 and 12 point fasteners.
- › Full Polish finish provides corrosion resistance and easy to clean surfaces.
- › Locking hole helps hold crowfoot in place during use.
- › Use with a locking extension to help prevent tool loss in awkward locations.



Product #	Size (in)	Outside Head Width (in) (C)	Head Thickness (in) (D)	Offset Height (in) (E)	Weight (lbs)
J4920FL	5/8	63/64	11/16	3/4	0.09
J4922FL	11/16	1-3/64	11/16	51/64	0.10
J4924FL	3/4	1-11/64	23/32	27/32	0.12
J4926FL	13/16	1-1/16	23/32	57/64	0.12
J4928FL	7/8	1-11/32	3/4	63/64	0.16
J4930FL	15/16	1-27/64	3/4	61/64	0.17
J4932FL	1	1-1/2	25/32	1-1/32	0.18
J4934FL	1-1/16	1-37/64	25/32	1-1/16	0.20



ASME B107.21

3/8" DRIVE FULL POLISH FLARE NUT CROWFOOT WRENCHES - 6 POINT

- › Flare Nut Crowfoot wrenches are used in hard to reach or restricted access situations where a standard flare nut wrench cannot reach.
- › The flare nut slot opening is used to slide over hydraulic lines or other hoses which allows for easy access to hex connectors at ends.
- › Typically used in low torque applications.
- › Full polish finish provides corrosion resistance and easy to clean surfaces.
- › Locking hole feature helps keep the crowfoot engaged on the extension during use, helping to reduce downtime and improve working efficiency.
- › Use with locking extensions to reach into small spaces where the fastener is out of sight.

Product #	Size (in)	Overall Length (in)	Weight (lbs)
J4912HFL	3/8	1-13/16	0.07
J4914HFL	7/16	1-1/2	0.08
J4916HFL	1/2	1-5/8	0.10
J4918HFL	9/16	1-5/8	0.11
J4920HFL	5/8	1-3/4	0.13
J4922HFL	11/16	1-13/16	0.13
J4924HFL	3/4	1-15/16	0.16
J4926HFL	13/16	2	0.18



ASME B107.21



3/8" DRIVE FULL POLISH METRIC FLARE NUT CROWFOOT WRENCHES - 6 POINT

METRIC

- › Flare Nut Crowfoot wrenches are used in hard to reach or restricted access situations where a standard flare nut wrench cannot reach.
- › The flare nut slot opening is used to slide over hydraulic lines or other hoses which allows for easy access to hex connectors at ends.
- › Typically used in low torque applications.
- › Full polish finish provides corrosion resistance and easy to clean surfaces.
- › Locking hole feature helps keep the crowfoot engaged on the extension during use, helping to reduce downtime and improve working efficiency.
- › Use with locking extensions to reach into small spaces where the fastener is out of sight.

Product #	Size (mm)	Overall Length (in)	Weight (lbs)
J4909MHFL	9	1-5/16	0.07
J4910MHFL	10	1-3/8	0.07
J4911MHFL	11	1-1/2	0.08
J4912MHFL	12	1-1/2	0.08
J4913MHFL	13	1-9/16	0.09
J4914MHFL	14	1-5/8	0.11
J4915MHFL	15	1-11/16	0.11
J4916MHFL	16	1-3/4	0.12
J4917MHFL	17	1-3/4	0.13
J4918MHFL	18	1-13/16	0.14



ASME B107.21



1/2" DRIVE FULL POLISH FLARE NUT CROWFOOT WRENCHES - 12 POINT

Product #	Size (in)	Overall Length (in)	Weight (lbs)
J5336FL	1-1/8	2-13/16	0.19
J5338FL	1-3/16	2-7/8	0.19
J5340FL	1-1/4	3	0.19
J5342FL	1-5/16	3-1/16	0.19
J5344FL	1-3/8	3-5/16	0.25
J5346FL	1-7/16	3-3/8	0.25
J5348FL	1-1/2	3-7/16	0.25
J5350FL	1-9/16	3-9/16	0.31
J5352FL	1-5/8	3-3/4	0.31
J5354FL	1-11/16	3-13/16	0.31
J5356FL	1-3/4	3-7/8	0.38
J5358FL	1-13/16	4	0.38
J5360FL	1-7/8	4-1/4	0.45
J5362FL	1-15/16	4-5/16	0.5
J5364FL	2	4-7/16	0.5

 ASME B107.21

- › Designed for speed and safety.
- › Special heat-treated alloy steel helps increase strength and durability.
- › 12 Point Box end allows for fine indexing, helping to improve speed and access. Fits 4, 6 and 12 point fasteners.
- › Full Polish finish provides corrosion resistance and easy to clean surfaces.



7 PIECE COMBINATION FLARE NUT WRENCH SET - 6 POINT

Product #: J3700A

Contents	Size (in)	Point Count	Overall Length (in)
J3751	3/8	6	5-11/16
J3752	7/16	6	6-1/32
J3753	1/2	6	6-7/16
J3754	9/16	6	6-15/16
J3755	5/8	6	7-5/8
J3756	11/16	6	8-11/16
J3757	3/4	6	9-3/16
J25TR03C	Tool Roll		

 ASME B107.21

- › Satin finish provides corrosion resistance and a slip-resistant grip.
- › Flare nut box end incorporates the TorquePlus™ system.
- › Weight (lbs): 2.24



7 PIECE COMBINATION FLARE NUT WRENCH SET - 12 POINT

Product #: J3700AT

Contents	Size (in)	Point Count	Overall Length (in)
J3751T	3/8	12	5-11/16
J3752T	1/2	12	6-1/32
J3753T	7/16	12	6-7/16
J3754T	9/16	12	6-15/16
J3755T	5/8	12	7-5/8
J3756T	11/16	12	8-11/16
J3757T	3/4	12	9-3/16
J25TR03C	Tool Roll		

 ASME B107.21

- › Satin finish provides corrosion resistance and a slip-resistant grip.
- › 12 point flare nut box end allows for fine indexing, helping to improve speed and access.
- › Fits 4, 6 and 12 point fasteners.
- › Flare nut box end incorporates the TorquePlus™ system.
- › Weight (lbs): 2.24



SATIN COMBINATION FLARE NUT WRENCHES - 6 POINT

- › Satin finish provides corrosion resistance and a slip-resistant grip.
- › Flare nut box end incorporates the TorquePlus™ system.



Product #	Size (in) (A)	Throat Depth (in) (B)	Outside Head Width (in) (C)	Head Thickness (in) (D)	Throat Depth (in) (B1)	Outside Head Width (in) (C1)	Head Thickness (in) (D1)	Overall Length (in)	Weight (lbs)
J3751	3/8	7/16	25/32	11/32	19/64	51/64	23/65	5-11/16	0.12
J3752	7/16	33/64	7/8	3/8	23/64	59/64	13/32	6-1/32	0.16
J3753	1/2	19/32	31/32	3/8	25/64	1-1/32	13/32	6-7/16	0.21
J3754	9/16	43/64	1-3/64	7/16	26/64	1-11/64	15/32	6-15/16	0.34
J3755	5/8	47/64	1-3/32	7/16	33/64	1-9/64	15/32	7-5/8	0.45
J3756	11/16	51/64	1-3/16	1/2	9/16	1-13/32	17/32	8-11/16	0.45
J3757	3/4	57/64	1-7/32	1/2	9/16	1-9/16	17/32	9-3/16	0.49

ASME B107.100

SATIN COMBINATION FLARE NUT WRENCHES - 12 POINT

- › Satin finish provides corrosion resistance and a slip-resistant grip.
- › 12 point flare nut box end allows for fine indexing, helping to improve speed and access.
- › Fits 4, 6 and 12 point fasteners.
- › Flare nut box end incorporates the TorquePlus™ system.



Product #	Size (in) (A)	Throat Depth (in) (B)	Outside Head Width (in) (C)	Head Thickness (in) (D)	Throat Depth (in) (B1)	Outside Head Width (in) (C1)	Head Thickness (in) (D1)	Overall Length (in)	Weight (lbs)
J3751T	3/8	7/16	25/32	11/32	19/64	51/64	3/8	5-11/16	0.13
J3752T	1/2	33/64	7/8	3/8	23/64	29/32	13/32	6-1/32	0.18
J3753T	7/16	19/32	31/32	3/8	25/64	1-1/32	13/32	6-7/16	0.19
J3754T	9/16	43/64	1-3/64	7/16	29/64	1-3/64	15/32	6-15/16	0.25
J3755T	5/8	47/64	1-3/32	7/16	33/64	1-19/64	15/32	7-5/8	0.32
J3756T	11/16	51/64	1-3/16	1/2	9/16	1-13/32	17/32	8-11/16	0.42
J3757T	3/4	57/64	1-7/32	1/2	9/16	1-9/16	17/32	9-3/16	0.46

ASME B107.100

3 PIECE DOUBLE END FLARE NUT WRENCH SET - 6 POINT

Product #: J3760

- › Satin finish provides corrosion resistance and a slip-resistant grip.
- › Flare nut box ends incorporate the TorquePlus™ system.
- › Weight (lbs): 0.97



Contents	Size (in)	Point Count	Overall Length (in)
J3764	3/8 x 7/16	6	6-1/4
J3768	1/2 x 9/16	6	7-1/2
J3772	5/8 x 11/16	6	8-3/4
J25TR17C	Tool Roll		

ASME B107.100



5 PIECE METRIC DOUBLE END FLARE NUT WRENCH SET - 6 POINT

Product #: **J3700M**

METRIC

- › Satin finish provides corrosion resistance and a slip-resistant grip.
- › Flare nut box ends incorporates the TorquePlus™ system.
- › Weight (lbs): 1.25



Contents	Size (mm)	Point Count	Overall Length (in)
J3707M	7 x 8	6	5-11/16
J3709M	9 x 11	6	6-5/16
J3710M	10 x 12	6	6-15/16
J3713M	13 x 14	6	7-9/16
J3715M	15 x 17	6	7-63/64
J25TR06C	Tool Roll		

ASME B107.100



WRENCHES



3 PIECE DOUBLE END FLARE NUT WRENCH SET - 12 POINT

Product #: **J3760T**

- › Satin finish provides corrosion resistance and a slip-resistant grip.
- › 12 point flare nut box end allows for fine indexing, helping to improve speed and access.
- › Fits 4, 6 and 12 point fasteners.
- › Flare nut box ends incorporate the TorquePlus™ system.
- › Weight (lbs): 0.97



Contents	Size (in)	Point Count	Overall Length (in)
J3764T	3/8 x 7/16	12	6-1/4
J3768T	1/2 x 9/16	12	7-1/2
J3772T	5/8 x 11/16	12	8-3/4
J25TR17C	Tool Roll		

ASME B107.100



FLARE NUT

5 PIECE METRIC DOUBLE END FLARE NUT WRENCH SET - 12 POINT

Product #: **J3700MT**

METRIC

- › Satin finish provides corrosion resistance and a slip-resistant grip.
- › 12 point flare nut box end allows for fine indexing, helping to improve speed and access.
- › Fits 4, 6 and 12 point fasteners.
- › Flare nut ends incorporate the TorquePlus™ system.
- › Weight (lbs): 1.29



Contents	Size (in)	Point Count	Overall Length (in)
J3707MT	7 x 8	12	5-11/16
J3709MT	9 x 11	12	6-5/16
J3710MT	10 x 12	12	6-15/16
J3713MT	13 x 14	12	7-9/16
J3715MT	15 x 17	12	7-63/64
J25TR06C	Tool Roll		

ASME B107.100



SATIN DOUBLE END FLARE NUT WRENCHES - 6 POINT

- › Satin finish provides corrosion resistance and a slip-resistant grip.
- › Flare nut box ends incorporate the TorquePlus™ system.



Product #	Size (in)	Mouth Width (in) (A)	Outside Head Width (in) (C)	Head Thickness (in) (D)	Mouth Width (in) (A1)	Outside Head Width (in) (C1)	Head Thickness (in) (D1)	Overall Length (in)	Weight (lbs)
J3764	3/8 x 7/16	19/64	51/64	11/32	23/64	57/64	3/8	6-1/4	0.18
J3768	1/2 x 9/16	25/64	31/32	3/8	13/32	1-3/64	7/16	7-1/2	0.27
J3772	5/8 x 11/16	33/64	1-7/64	7/16	37/64	1-13/64	31/64	8-3/4	0.38

ASME B107.100

SATIN METRIC DOUBLE END FLARE NUT WRENCHES - 6 POINT

- › Satin finish provides corrosion resistance and a slip-resistant grip.
- › Flare nut box ends incorporate the TorquePlus™ system.



METRIC



Product #	Size (mm)	Mouth Width (in) (A)	Outside Head Width (in) (C)	Head Thickness (in) (D)	Mouth Width (in) (A1)	Outside Head Width (in) (C1)	Head Thickness (in) (D1)	Overall Length (in)	Weight (lbs)
J3707M	7 x 8	7/32	43/64	19/64	15/64	3/4	21/64	5-11/16	0.12
J3709M	9 x 11	9/32	13/16	23/64	11/32	29/32	25/64	6-5/16	0.17
J3710M	10 x 12	9/32	55/64	25/64	11/32	61/64	25/64	6-15/16	0.22
J3713M	13 x 14	3/8	1-1/64	25/64	7/16	1-3/32	29/64	7-9/16	0.26
J3715M	15 x 17	7/16	1-7/64	29/64	1/2	1-3/16	31/64	7-63/64	0.37
J3716M	16 x 18	1/2	1-9/64	29/64	37/64	1-15/64	33/64	8-13/16	0.39
J3719M	19 x 21	37/64	1-9/32	35/64	5/8	1-3/8	37/64	9-3/8	0.6

ASME B107.100

SATIN DOUBLE END FLARE NUT WRENCHES - 12 POINT

- › Satin finish provides corrosion resistance and a slip-resistant grip.
- › 12 point flare nut box end allows for fine indexing, helping to improve speed and access.
- › Fits 4, 6 and 12 point fasteners.
- › Flare nut box ends incorporate the TorquePlus™ system.



Product #	Size (in)	Mouth Width (in) (A)	Outside Head Width (in) (C)	Head Thickness (in) (D)	Mouth Width (in) (A1)	Outside Head Width (in) (C1)	Head Thickness (in) (D1)	Overall Length (in)	Weight (lbs)
J3764T	3/8 x 7/16	19/64	51/64	11/32	23/64	57/64	3/8	6-1/4	0.18
J3768T	1/2 x 9/16	25/64	31/32	3/8	13/32	1-1/16	7/16	7-1/2	0.27
J3772T	5/8 x 11/16	33/64	1-7/64	7/16	37/64	1-13/64	31/64	8-3/4	0.38

ASME B107.100



SATIN METRIC DOUBLE END FLARE NUT WRENCHES - 12 POINT

METRIC

- › Satin finish provides corrosion resistance and a slip-resistant grip.
- › Flare nut box ends incorporate the TorquePlus™ system.
- › 12 point flare nut box end allows for fine indexing, helping to improve speed and access.
- › Fits 4, 6 and 12 point fasteners.



Product #	Size (mm)	Mouth Width (in) (A)	Outside Head Width (in) (C)	Head Thickness (in) (D)	Mouth Width (in) (A1)	Outside Head Width (in) (C1)	Head Thickness (in) (D1)	Overall Length (in)	Weight (lbs)
J3707MT	7 x 8	7/32	43/64	19/64	15/64	3/4	21/64	5-11/16	0.11
J3709MT	9 x 11	9/32	13/16	23/64	11/32	29/32	25/64	6-5/16	0.16
J3710MT	10 x 12	9/32	55/64	25/64	11/32	61/64	25/64	6-15/16	0.21
J3713MT	13 x 14	3/8	1-1/64	25/64	7/16	1-3/32	29/64	7-9/16	0.24
J3715MT	15 x 17	7/16	1-7/64	29/64	1/2	1-3/16	31/64	7-63/64	0.33
J3716MT	16 x 18	1/2	1-9/64	29/64	37/64	1-15/64	33/64	8-13/16	0.36
J3719MT	19 x 21	37/64	1-9/32	35/64	5/8	1-3/8	37/64	9-7/16	0.39



ASME B107.100

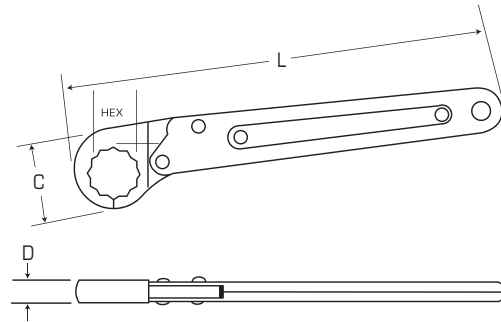
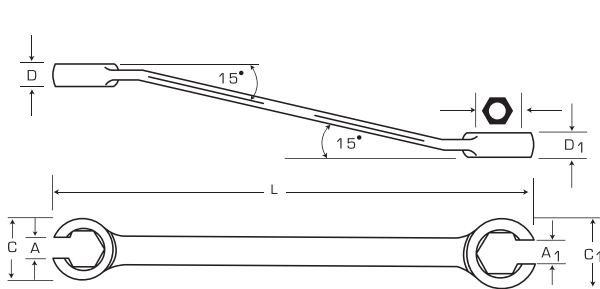

7 PIECE RATCHETING FLARE NUT WRENCH SET - 12 POINT

Product #: J3800A

- › Black oxide finish.
- › Non-reflective black oxide finish for use where non-plated products are required.
- › 12 Point flare nut box end allows for fine indexing, helping to improve speed and access.
- › Pivoting head allows user to place the wrench over the connected pipes to reach the fastener.
- › Weight (lbs): 1.93

Contents	Size (in)	Point Count	Overall Length (in)
J3812	3/8	12	5-7/16
J3814	7/16	12	5-7/16
J3816	1/2	12	5-7/16
J3818	9/16	12	7-1/4
J3820	5/8	12	7-1/4
J3822	11/16	12	7-1/4
J3824	3/4	12	7-1/4
J25TR03C	Tool Roll		



BLACK OXIDE RATCHETING FLARE NUT WRENCHES - 12 POINT

- › Black oxide finish.
- › Non-reflective black oxide finish for use where non-plated products are required.
- › 12 Point flare nut box end allows for fine indexing, helping to improve speed and access.
- › Pivoting head allows user to place the wrench over the connected pipes to reach the fastener.



Product #	Size (in)	Outside Head Width (in) (C)	Head Thickness (in) (D)	Overall Length (in)	Weight (lbs)
J3812	3/8	1	9/32	5-7/16	0.17
J3814	7/16	1	9/32	5-7/16	0.17
J3816	1/2	1	9/32	5-7/16	0.17
J3818	9/16	1-5/16	3/8	7-1/4	0.31
J3820	5/8	1-5/16	3/8	7-1/4	0.31
J3822	11/16	1-5/16	3/8	7-1/4	0.31
J3824	3/4	1-5/16	3/8	7-1/4	0.31
J3826	13/16	1-11/16	7/16	9-3/8	0.58
J3828	7/8	1-11/16	7/16	9-3/8	0.58
J3830	15/16	1-11/16	1/2	9-3/8	0.58
J3832	1	1-11/16	1/2	9-3/8	0.58

BLACK OXIDE BOX END SPUD WRENCHES - 12 POINT

- › Non-reflective black oxide finish for use where non-plated products are required.
- › Ideal for heavy construction and field service work.
- › High leverage handle and strong box end designed to turn stubborn nuts and bolts.
- › Tapered spud end aligns flange holes.
- › 12 point box end allows for fine indexing helping to improve speed and access. Fits 4, 6 and 12 point fasteners.



Product #	Size (in)	Outside Head Width (in) (C)	Head Thickness (in) (D)	Offset Height (in) (E)	Overall Length (in)	Weight (lbs)
J2613	13/16	1-11/32	5/8	1-3/32	12	0.87
J2614	7/8	1-11/32	5/8	1-3/32	14-1/2	0.85
J2615	15/16	1-11/32	5/8	1-3/32	13-1/2	1.25
J2616	1	1-9/16	11/16	1-5/16	1-1/2	1.22
J2617	1-1/16	1-19/32	11/16	1-5/16	15	1.57
J2618	1-1/8	1-45/64	13/16	1-1/16	15	1.50
J2620	1-1/4	1-25/32	13/16	1-1/16	17	2.38
J2621	1-5/16	2-1/8	15/16	1-3/8	17-3/32	2.19
J2623	1-7/16	2-1/8	15/16	1-3/8	21-5/16	3.10
J2624	1-1/2	2-3/16	1	1-1/2	21-3/16	3.05
J2626	1-5/8	2-15/32	1-1/8	1-1/2	22-3/32	4.70
J2627	1-11/16	2-15/32	1-1/8	1-1/2	22-5/16	4.91
J2629	1-13/16	2-29/32	1-3/16	1-9/16	23-5/16	5.84
J2630	1-7/8	2-29/32	1-3/16	1-9/16	23	5.99
J2632	2	3-5/32	1-7/16	1-21/32	24	7.04
J2635	2-3/16	3-15/32	1-9/16	1-7/8	26	8.93
J2638	2-3/8	3-23/32	1-1/2	2	28	9.96
J2641	2-9/16	4	1-1/2	2-1/4	29	11.24
J2644	2-3/4	4	1-1/2	2-1/4	30	14.34

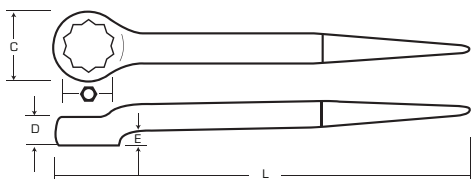

BLACK OXIDE OPEN END SPUD WRENCHES - OFFSET HEAD

- › Non-reflective black oxide finish for use where non-plated products are required.
- › Long offset handle provides greater leverage and clearance for knuckles and obstructions.
- › Hardened tapered handle aligns bolt and rivet holes.
- › Openings are precision broached for proper fit.



Product #	Size (in)	Outside Head Width (in) (C)	Head Thickness (in) (D)	Offset Height (in) (E)	Overall Length (in)	Weight (lbs)
JC901B	9/16	1-9/16	7/16	3/4	11-1/2	0.76
JC903A	5/8	1-9/16	7/16	3/4	12	0.76
JC903	11/16	1-9/16	7/16	3/4	11-13/16	0.77
JC904A	3/4	1-7/8	7/16	3/4	11-13/16	0.76
JC905A	13/16	2	9/16	7/8	14-1/2	1.29
JC905	7/8	2-3/16	9/16	7/8	14-1/2	1.23
JC906C	15/16	2-3/16	9/16	7/8	14-1/2	1.30
JC906B	1	2-3/16	9/16	7/8	14-3/16	1.29
JC907	1-1/16	2-7/16	21/32	1	17-3/16	1.88
JC907A	1-1/8	2-7/16	21/32	1	16-11/16	1.79
JC908	1-1/4	2-3/4	13/16	1-1/4	19	2.78
JC908A	1-5/16	2-3/4	13/16	1-1/4	19-3/32	2.79
JC909	1-7/16	3-1/8	13/16	1-1/4	20	3.54
JC909A	1-1/2	3-1/8	13/16	1-1/4	20	3.79
JC910	1-5/8	3-1/8	13/16	1-5/8	23	5.68
JC910A	1-11/16	3-5/8	13/16	1-5/8	22-13/16	5.41
JC911	1-13/16	4-1/8	13/16	1-5/8	24	7.35
JC911A	1-7/8	4-1/8	13/16	1-5/8	24	7.23
JC912	2	4-7/16	13/16	1-5/8	24	7.5

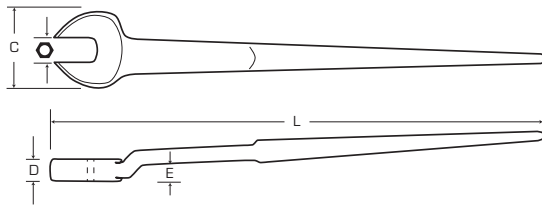

BLACK OXIDE ADJUSTABLE SPUD WRENCH

- › Non-Reflective black oxide finish for use where none plated products are required.
- › Large jaw opening fits all nuts and bolts up to 1-1/2 inches.
- › Square jaw opening provides strength and tight fit.
- › Eliminates the need for carrying several fixed size wrenches.
- › Hardened taper handle aligns bolt and rivet holes.



Product #	Max Opening Overall Length		Weight (lbs)
	(in)	(in)	
J712SC	1-1/2	16-3/32	2.45

BLACK OXIDE SPUD HANDLE 1/2" DRIVE PEAR HEAD RATCHET

- › Tapered handle for aligning bolt holes.
- › Spring-loaded pellet in male drive plug.
- › Black oxide finish.

Product #	Overall Length (in)	Weight (lbs)
J5449-14BL	14	2.03



ASME B107.500

BLACK OXIDE HEAVY-DUTY STRIKING WRENCHES - 6 POINT

- › Non-reflective black oxide finish for use where non-plated products are required.
- › Large striking surface for surer blow contact and more efficient transmittal of force to fastener.
- › Short handle permits use in close quarters.
- › Box opening designed to remain on fastener when wrench is struck.
- › For use where extreme force is necessary to loosen or set large fasteners.
- › Heavy box walls provide greater torque transmission.
- › Straight handle design helps prevent the wrench from cocking when struck.



Product #	Size (in)	Outside Head Width (in) (C)	Head Thickness (in) (D)	Overall Length (in)	Weight (lbs)
J2717SW	1-1/16	1-25/32	5/8	9-7/8	1.62
J2720SW	1-1/4	2	23/32	10-1/4	1.72
J2723SW	1-7/16	2-17/64	7/8	10-19/32	2.49
J2726SW	1-5/8	2-31/64	61/64	10-15/16	3.17
J2729SW	1-13/16	2-21/32	63/64	11-5/16	3.49
J2732SW	2	3-1/32	1-7/32	11-21/32	4.73
J2735SW	2-3/16	3-9/32	1-15/64	11-5/16	5.33
J2738SW	2-3/8	3-13/32	1-7/16	12-3/8	5.63
J2741SW	2-9/16	3-3/4	1-17/32	12-11/16	6.47
J2744SW	2-3/4	4-11/64	1-17/32	12-13/16	7.56
J2747SW	2-15/16	4-23/64	1-17/32	13-5/16	7.81
J2750SW	3-1/8	4-31/64	1-41/64	13-11/16	9.50
J2756SW	3-1/2	4-31/32	1-23/32	13-29/32	10.54
J2762SW	3-7/8	5-35/64	1-23/32	14-13/32	12.76

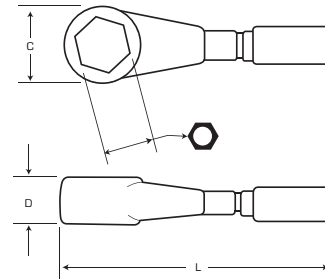
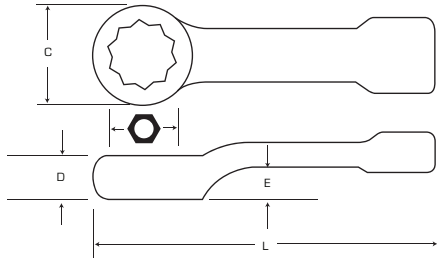

BLACK OXIDE HEAVY-DUTY STRIKING WRENCHES - 12 POINT

- › Non-reflective black oxide finish for use where non-plated products are required.
- › 12 point box end allows for fine indexing, helping improve speed and access.
- › Fits most 4, 6 and 12 point fasteners.
- › Large striking surface for surer blow contact and more efficient transmittal of force to fastener.
- › Short handle permits use in close quarters.
- › Box opening designed to remain on fastener when wrench is struck.
- › For use where extreme force is necessary to loosen or set large fasteners.
- › Heavy box walls provide greater torque transmission.
- › Straight handle design helps prevent the wrench from cocking when struck.



Product #	Size (in)	Outside Head Width (in) (C)	Head Thickness (in) (D)	Overall Length (in)	Weight (lbs)
JSN16	1	1-25/32	5/8	9-7/8	1.90
JSN17	1-1/16	1-25/32	5/8	9-7/8	1.90
JSN18	1-1/8	1-25/32	5/8	9-7/8	1.90
JSN19	1-3/16	2	3/4	10-1/4	2.10
JSN20	1-1/4	2	3/4	10-1/4	2.10

BLACK OXIDE HEAVY-DUTY OFFSET STRIKING WRENCHES - 12 POINT

- › Black oxide finish.
- › Large striking surface for surer blow contact and more efficient transmittal of force to fastener.
- › Short handle permits use in close quarters.
- › Box opening designed to remain on fastener when wrench is struck.
- › For use where extreme force is necessary to loosen or set large fasteners.
- › Heavy box walls provide greater torque transmission.
- › Offset handle clears obstructions.



Product #	Size (in)	Size (mm)	Outside Head Width (in) (C)	Head Thickness (in) (D)	Offset Height (in) (E)	Overall Length (in)	Weight (lbs)
J2616SW	1		1-25/32	5/8	15/16	8-1/2	1.84
J2617SW	1-1/16	27	1-11/16	5/8	15/16	8-1/2	1.84
J2618SW	1-1/8		1-11/16	5/8	15/16	11	1.79
J2619SW	1-3/16	30	2-1/16	13/16	13/16	10-3/4	2.55
J2620SW	1-1/4		1-7/8	13/16	13/16	10-3/4	2.58
J2621SW	1-5/16		1-7/8	13/16	13/16	11-1/2	2.59
J2622SW	1-3/8	35	2-25/64	1	1-1/2	12	3.40
J2623SW	1-7/16		2-3/16	1	1-1/2	12	3.29
J2624SW	1-1/2	38	2-3/16	1	1-1/2	12	3.35
J2625SW	1-9/16		2-21/32	1-1/8	1-7/16	12-1/4	3.89
J2626SW	1-5/8		2-13/32	1-1/8	1-1/2	12-1/4	4.00
J2627SW	1-11/16	43	2-13/32	1-1/8	1-1/2	13-7/16	3.88
J2628SW	1-3/4		2-19/32	1-3/16	1-9/16	13-7/16	3.90
J2629SW	1-13/16		2-21/32	1-3/16	1-9/16	13-7/16	5.30
J2630SW	1-7/8		2-27/32	1-1/4	1-21/32	13-7/16	5.24
J2631SW	1-15/16		2-27/32	1-1/4	1-7/8	13-7/16	5.20
J2632SW	2	51	2-27/32	1-1/4	1-21/32	13-7/16	5.16
J2633SW	2-1/16		3-1/8	1-1/4	2	13-1/2	6.82
J2634SW	2-1/8	54	3-1/8	1-1/2	2	13-7/8	6.71
J2635SW	2-3/16		3-3/8	1-1/2	2	13-1/2	6.78
J2636SW	2-1/4	57	3-3/8	1-1/2	2	13-1/2	6.30
J2637SW	2-5/16		3-3/8	1-1/2	2	13-1/2	7.94
J2638SW	2-3/8		3-3/8	1-1/2	2	13-1/2	7.86
J2639SW	2-7/16		3-13/16	1-1/2	2-1/4	13-1/2	7.67
J2640SW	2-1/2	64	4	1-1/2	2-1/4	13-1/2	7.62
J2641SW	2-9/16		4	1-1/2	2-1/4	13-1/2	13.43
J2642SW	2-5/8		4	1-1/2	2-1/4	13-1/2	10.42
J2643SW	2-11/16		4-7/32	1-1/2	2-1/4	13-1/2	10.25
J2644SW	2-3/4		4-7/32	1-1/2	2-1/4	13-1/2	10.18
J2646SW	2-7/8	73	4-25/32	1-7/8	2-5/8	16	13.84
J2647SW	2-15/16		4-7/16	1-7/8	2-5/8	16	13.60
J2648SW	3		4-7/16	1-7/8	2-5/8	16	13.44
J2649SW	3-1/16		4-25/32	1-7/8	2-5/8	16	13.37
J2650SW	3-1/8		4-7/16	1-7/8	2-5/8	16	13.18
J2654SW	3-3/8		6-1/4	2-3/8	3-5/8	18	26.88
J2656SW	3-1/2		6-1/4	2-3/8	3-5/8	18	26.37
J2660SW	3-3/4		6-1/4	2-3/8	3-5/8	18	25.03
J2662SW	3-7/8		6-1/4	2-3/8	3-5/8	18	24.58
J2666SW	4-1/8		6-1/4	2-3/8	3-5/8	18	23.47
J2668SW	4-1/4		6-1/4	2-3/8	3-5/8	18	22.75



BLACK OXIDE HEAVY-DUTY METRIC OFFSET STRIKING WRENCHES - 12 POINT

METRIC

- › Non-reflective black oxide finish for use where non-plated products are required.
- › 12 point box end allows for fine indexing, helping improve speed and access.
- › Fits most 4, 6 and 12 point fasteners.
- › Large striking surface for surer blow contact and more efficient transmittal of force to fastener.
- › Short handle permits use in close quarters.
- › Box opening designed to remain on fastener when wrench is struck.
- › For use where extreme force is necessary to loosen or set large fasteners.
- › Heavy box walls provide greater torque transmission.
- › Offset handle clears obstructions.



Product #	Size (mm)	Outside Head Width (in) (C)	Head Thickness (in) (D)	Offset Height (in) (E)	Overall Length (in)	Weight (lbs)
J2632SWM	32	1-57/64	53/64	1-3/16	10-3/4	0.88
J2636SWM	36	2-13/64	63/64	1-1/2	12-1/64	2.13
J2641SWM	41	2-13/32	1-7/64	1-1/2	12-1/4	2.37
J2646SWM	46	2-43/64	1-3/16	1-37/64	13-27/64	2.81
J2650SWM	50	2-53/64	1-17/64	1-21/32	13-27/64	6.36
J2655SWM	55	3-25/64	1-1/2	2-1/64	13-1/2	6.58
J2660SWM	60	3-25/64	1-1/2	2-1/64	13-1/2	9.19
J2665SWM	65	4-1/64	1-1/2	2-1/4	13-1/2	12.61
J2670SWM	70	4-1/64	1-1/2	2-1/4	13-1/2	12.11
J2675SWM	75	4-29/64	1-57/64	2-41/64	15-63/64	13.53
J2680SWM	80	4-29/64	1-57/64	2-41/64	15-63/64	13.16



BLACK OXIDE OFFSET STRIKING DUAL DIMENSION WRENCHES - 12 POINT

METRIC

- › Black oxide finish.
- › Large striking surface for surer blow contact and more efficient transmittal of force to fastener.
- › Short handle permits use in close quarters.
- › Box opening designed to remain on fastener when wrench is struck.
- › For use where extreme force is necessary to loosen or set large fasteners.
- › Heavy box walls provide greater torque transmission.
- › Offset handle clears obstructions.



Product #	Size (in)	Size (mm)	Outside Head Width (in) (C)	Head Thickness (in) (D)	Offset Height (in) (E)	Overall Length (in)	Weight (lbs)
J2617SW	1-1/16	27	1-11/16	5/8	15/16	8-1/2	1.84
J2619SW	1-3/16	30	2-1/16	13/16	13/16	10-3/4	2.55
J2622SW	1-3/8	35	2-25/64	1	1-1/2	12	3.40
J2624SW	1-1/2	38	2-3/16	1	1-1/2	12	3.35
J2627SW	1-11/16	43	2-13/32	1-1/8	1-1/2	13-7/16	3.88
J2632SW	2	51	2-27/32	1-1/4	1-21/32	13-7/16	5.16
J2634SW	2-1/8	54	3-1/8	1-1/2	2	13-7/8	6.71
J2636SW	2-1/4	57	3-3/8	1-1/2	2	13-1/2	6.30
J2640SW	2-1/2	64	4	1-1/2	2-1/4	13-1/2	7.62
J2646SW	2-7/8	73	4-25/32	1-7/8	2-5/8	16	13.84



BLACK OXIDE OFFSET SLUGGING WRENCHES SUPER HEAVY-DUTY - 12 POINT

- › Non-reflective black oxide finish for use where non-plated products are required.
- › 12 point box end allows for fine indexing, helping improve speed and access.
- › Designed for heavy use in close quarters where hammer or sledge is required to loosen frozen nuts or set large fasteners.
- › High strength rectangular design withstands heavy sledging; transmits power more effectively to fastener.
- › Box opening designed to remain in place on fastener when wrench is struck.
- › Heavy box walls provide greater transmission of torque to fastener.
- › Straighter handle design than striking wrenches resists springing, nut turns easier.



Product #	Size (in)	Outside Head Width (in) (C)	Head Thickness (in) (D)	Offset Height (in) (E)	Overall Length (in)	Weight (lbs)
JUSN321	1-5/16	2-3/8	7/8	11/16	8-3/8	2.03
JUSN322	1-3/8	2-3/8	7/8	11/16	8-3/8	2.00
JUSN323	1-7/16	2-3/8	7/8	11/16	8-3/8	1.95
JUSN324	1-1/2	2-3/4	1-1/8	1	10	3.54
JUSN326	1-5/8	2-3/4	1-1/8	1	10-1/8	3.41
JUSN327	1-11/16	2-3/4	1-1/8	1	10-1/8	3.31
JUSN328	1-3/4	2-3/4	1-1/8	1	10-1/8	3.36
JUSN329	1-13/16	2-3/4	1-1/8	1	10-1/8	3.20
JUSN330	1-7/8	3	1-1/4	1-1/8	10-3/4	3.92
JUSN332	2	3	1-5/16	1-1/8	10-13/16	3.71
JUSN333	2-1/16	3	1-5/16	1-1/8	11	4.21
JUSN334	2-1/8	3	1-5/16	1-1/8	11	4.74
JUSN335	2-3/16	3-9/16	1-3/8	1-1/4	11	5.11
JUSN336	2-1/4	3-9/16	1-3/8	1-1/4	11	4.86
JUSN338	2-3/8	4-1/8	1-5/8	1-1/2	14-1/2	8.75
JUSN339	2-7/16	4-1/8	1-5/8	1-1/2	14-1/2	8.86
JUSN340	2-1/2	4-1/8	1-5/8	1-1/2	14-13/32	8.46
JUSN341	2-9/16	4-1/8	1-5/8	1-1/2	14-1/2	8.37
JUSN342	2-5/8	4-1/8	1-5/8	1-1/2	14-13/32	8.35
JUSN344	2-3/4	4-1/8	1-5/8	1-1/2	14-1/2	7.80
JUSN345	2-13/16	4-5/8	1-7/8	1-3/4	15-13/16	9.06
JUSN347	2-15/16	4-5/8	1-7/8	1-3/4	15-1/2	12.17
JUSN348	3	4-5/8	1-7/8	1-3/4	15-1/2	12.14
JUSN350	3-1/8	4-5/8	1-7/8	1-7/8	15-19/32	11.29
JUSN354	3-3/8	5-1/4	2	1-7/8	17-1/2	15.41
JUSN356	3-1/2	5-1/4	2	1-7/8	17-13/32	15.79
JUSN360	3-3/4	5-1/2	2-1/2	1-7/8	18-3/16	22.74
JUSN362	3-7/8	5-1/2	2-1/2	1-7/8	18	22.11
JUSN366	4-1/8	6-1/8	2-7/8	1-7/8	18-3/16	27.92
JUSN368	4-1/4	6-1/8	2-7/8	1-7/8	18-3/16	26.83
JUSN372	4-1/2	6-5/8	3	1-7/8	20	32.06
JUSN374	4-5/8	6-5/8	3	1-7/8	20-3/16	30.54

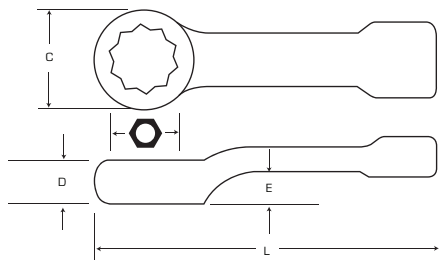

BLACK OXIDE METRIC OFFSET SLUGGING WRENCHES SUPER HEAVY-DUTY - 12 POINT



- › Non-reflective black oxide finish for use where non-plated products are required.
- › 12 point box end allows for fine indexing, helping improve speed and access.
- › Fits most 4, 6 and 12 point fasteners.
- › Designed for heavy use in close quarters where hammer or sledge is required to loosen frozen nuts or set large fasteners.
- › High strength rectangular design withstands heavy sledging.
- › Box opening designed to remain in place on fastener when wrench is struck.
- › Heavy box walls provide greater transmission of torque to fastener.
- › Straighter handle design than striking wrenches resists springing, nut turns easier.



Product #	Size (mm)	Outside Head Width (in) (C)	Head Thickness (in) (D)	Offset Height (in) (E)	Overall Length (in)	Weight (lbs)
JHD032M	32	2-23/64	55/64	43/64	8-25/64	1.27
JHD036M	36	2-23/64	55/64	43/64	8-25/64	1.27
JHD041M	41	2-3/4	1-9/64	63/64	10-1/8	1.36
JHD046M	46	2-3/4	1-9/64	63/64	10-1/8	1.31
JHD050M	50	2-63/64	1-17/64	1-7/64	10-3/4	1.80
JHD055M	55	3-37/64	1-3/8	1-17/64	10-63/64	2.27
JHD060M	60	4-9/64	1-39/64	1-1/2	14-31/64	3.63
JHD065M	65	4-9/64	1-39/64	1-1/2	14-31/64	3.50
JHD070M	70	4-9/64	1-39/64	1-1/2	14-31/64	3.36
JHD075M	75	4-41/64	1-57/64	1-47/64	15-3/4	12.15
JHD080M	80	5-15/64	2-1/64	1-27/32	17-23/64	11.35
JHD085M	85	5-15/64	2-1/64	1-27/32	17-23/64	16.96
JHD090M	90	5-33/64	2-33/64	1-57/64	17-3/4	15.16
JHD095M	95	5-33/64	2-33/64	1-57/64	17-3/4	22.75
JHD100M	100	5-63/64	2-7/8	1-31/32	17-63/64	28.51
JHD105M	105	5-63/64	2-7/8	1-31/32	17-63/64	27.26
JHD110M	110	6-1/2	2-63/64	2-3/64	17-63/64	33.22
JHD115M	115	6-1/2	2-63/64	2-3/64	19-49/64	31.89

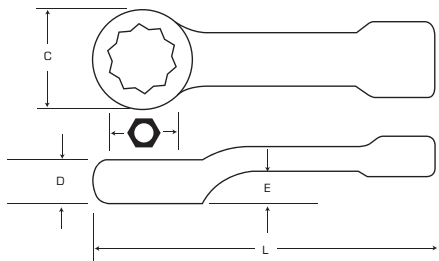

FACOM® BLACK OXIDE METRIC ENGINEER WRENCHES



- › Forged in carbon steel and hardened to high torque applications.
- › Hook eye.
- › Black oxide finish.
- › Long handle for extra leverage



Product #	Size (mm)	Outside Head Width (in) (C)	Head Thickness (in) (D)	Overall Length (in)	Weight (lbs)
FM-45.30	30	2-7/16	7/16	10-1/4	0.75
FM-45.32	32	2-19/32	15/32	11-7/32	0.92
FM-45.34	34	2-19/32	15/32	12-5/32	1.29
FM-45.36	36	2-29/32	1/2	12-13/32	1.28
FM-45.38	38	2-29/32	1/2	12-19/32	1.63
FM-45.41	41	3-23/64	17/32	13-3/8	1.93
FM-45.46	46	3-49/64	5/8	15-9/16	2.39
FM-45.50	50	4-1/64	5/8	16-23/32	3.05
FM-45.55	55	4-27/64	5/8	16-23/32	3.04
FM-45.60	60	4-53/64	23/32	18-1/2	5.45
FM-45.65	65	5-9/64	23/32	18-1/2	5.43
FM-45.70	70	5-5/8	25/32	19-11/16	7.51
FM-45.75	75	5-15/16	13/16	19-11/16	7.47



11 PIECE FACOM® METRIC LEVERAGE WRENCHES AND HANDLES



Product #: **FM-54.P9M**

- › Weight (lbs): 29.76

Contents	Size (mm)	Point Count	Overall Length (in)
FM-54A.24	24	12	7-3/32
FM-54A.30	30	12	8-9/32
FM-54A.32	32	12	9-7/16
FM-54A.36	36	12	9-27/32
FM-54A.41	41	12	10-5/8
FM-54A.46	46	12	11-1/32
FM-54A.50	50	12	11-5/8
FM-54A.55	55	12	11-11/16
FM-54.M1B	Handle		18
FM-54.M2B	Handle		23-1/2
FM-54.M3B	Handle		30

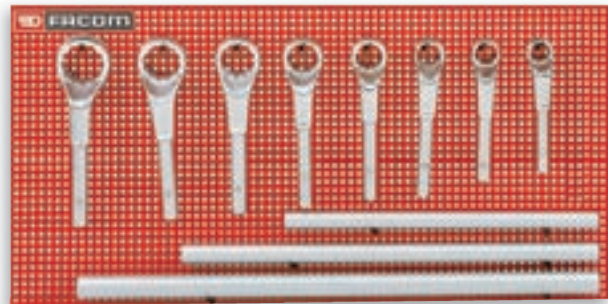

FACOM® SATIN METRIC LEVERAGE WRENCHES



- › Satin finish provides corrosion resistance and a slip-resistant grip.
- › Separate removable handle used when extra leverage is needed.
- › 12 point, box end allows for fine indexing, helping to improve speed and access.
- › 30° offset handle helps clear obstructions.



Product #	Size (mm)	Outside Head Width (in) (C)	Head Thickness (in) (D)	Overall Length (in)	Use Handle	Weight (lbs)
FM-54A.24	24	1-1/2	21/32	7-3/32	FM-54.M1B	0.89
FM-54A.30	30	1-57/64	23/32	8-9/32	FM-54.M1B	1.09
FM-54A.32	32	1-59/64	23/32	9-7/16	FM-54.M2B	1.60
FM-54A.36	36	2-1/8	25/32	9-27/32	FM-54.M2B	1.71
FM-54A.41	41	2-7/16	7/8	10-5/8	FM-54.M2B	2.05
FM-54A.46	46	2-23/32	29/32	11-1/32	FM-54.M3B	2.61
FM-54A.50	50	2-63/64	1	11-5/8	FM-54.M3B	3.11
FM-54A.55	55	3-3/16	1-1/8	11-11/16	FM-54.M3B	3.27
FM-54A.60	60	3-35/64	1-3/16	13-25/32	FM-54.M4B	4.95
FM-54A.65	65	3-55/64	1-5/16	14-3/8	FM-54.M4B	5.39
FM-54A.70	70	4-9/64	1-13/32	14-3/8	FM-54.M4B	6.05

FACOM® SATIN LEVERAGE WRENCH HANDLES



- › Removable handle
- › Satin finish provides corrosion resistance and a slip-resistant grip.

Product #	Overall Length (in)	Weight (lbs)
FM-54.M1B	18	1.35
FM-54.M2B	23-1/2	2.44
FM-54.M3B	30	4.73
FM-54.M4B	33-9/32	6.31



3 PIECE ADJUSTABLE WRENCH SET

Product #: J795

- › Satin finish provides corrosion resistance and a slip-resistant grip.
- › Extra wide jaw capacity.
- › Square jaw opening provides strength and tight fit.
- › Rugged I-beam style handle and reinforced stress areas; radius corner design.
- › Weight (lbs): 2.6

Contents	Max. Opening (in)	Overall Length (in)
J708	1-1/8	8
J710	1-5/16	10
J712	1-1/2	12
J25TR22C	Tool Roll	

ASME B107.100



3 PIECE CLIK-STOP® ADJUSTABLE WRENCH SET

Product #: J790

- › Clik-Stop® locking design holds the moving jaw of an adjustable wrench in place when the wrench is in use.
- › Satin finish provides corrosion resistance and a slip-resistant grip.
- › Extra wide jaw capacity.
- › Square jaw opening provides strength and tight fit.
- › Weight (lbs): 3.08

Contents	Max. Opening (in)	Overall Length (in)
J708L	1-1/8	8
J710L	1-5/16	10
J712L	1-1/2	12
J25TR22C	Tool Roll	

 ASME B107.100



SATIN CLIK-STOP® ADJUSTABLE WRENCHES

- › Satin finish provides corrosion resistance and a slip-resistant grip.
- › Extra wide jaw capacity.
- › Square jaw opening provides strength and tight fit.
- › Clik-Stop® locking design holds the moving jaw of an adjustable wrench in place when the wrench is in use.

Product #	Max Opening (in)	Overall Length (in)	Weight (lbs)
J704L	1/2	4	0.13
J706L	5/16	6	0.34
J708L	1-1/8	8	0.57
J710L	1-5/16	10	0.95
J712L	1-1/2	12	1.54
J715L	1-11/16	15	3.13
J718L	2-1/16	18	5.73
J724L	2-7/16	24	8.84

 ASME B107.100



BLACK OXIDE CLIK-STOP® ADJUSTABLE WRENCHES

- › Non-reflective black oxide finish for use where non-plated products are required.
- › Extra wide jaw capacity.
- › Square jaw opening provides strength and tight fit.
- › Clik-Stop® locking design holds the moving jaw of an adjustable wrench in place when the wrench is in use.

Product #	Max Opening (in)	Overall Length (in)	Weight (lbs)
J704SL	1/2	4	0.14
J706SL	5/16	6	0.28
J708SL	1-1/8	8	0.57
J710SL	1-15/16	10	1.06
J712SL	1-1/2	12	1.50
J715SL	1-11/16	15	3.07
J718SL	2-1/16	18	5.60

 ASME B107.100



CUSHION GRIP ADJUSTABLE WRENCHES

- › Soft cushion grip for additional comfort.
- › Extra wide jaw capacity.
- › Square jaw opening provides strength and tight fit.

Product #	Max Opening (in)	Overall Length (in)	Weight (lbs)
J704G	1/2	4	0.13
J706G	15/16	6	0.25
J708G	1-1/8	8	0.59
J710G	1-5/16	10	0.80
J712G	1-1/2	12	1.61

 ASME B107.100



SATIN ADJUSTABLE WRENCHES

- › Satin finish provides corrosion resistance and a slip-resistant grip.
- › Extra wide jaw capacity.
- › Square jaw opening provides strength and tight fit.
- › Rugged I-beam style handle and reinforced stress areas; radius corner design.

Product #	Max Opening (in)	Overall Length (in)	Weight (lbs)
J704	1/2	4	0.17
J706	15/16	6	0.28
J708	1-1/8	8	0.58
J710	1-5/16	10	0.90
J712	1-1/2	12	1.58
J715	1-11/16	15	3.00
J718	2-1/16	18	4.26
J724	2-7/16	24	6.41

 AS4984 ASME B107.100

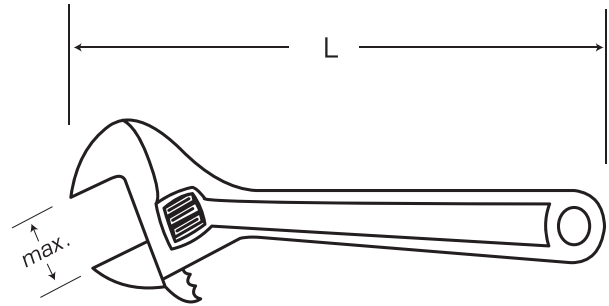

BLACK OXIDE ADJUSTABLE WRENCHES

- › Non-reflective black oxide finish for use where non-plated products are required.
- › Extra wide jaw capacity.
- › Square jaw opening provides strength and tight fit.

Product #	Max Opening (in)	Overall Length (in)	Weight (lbs)
J704S	1/2	4	0.17
J706S	15/16	6	0.28
J708S	1-1/8	8	0.58
J710S	1-5/16	10	0.90
J712S	1-1/2	12	1.58
J715S	1-11/16	15	3.00
J718S	2-1/16	18	4.26
J724S	2-7/16	24	6.41

 ASME B107.100



FACOM® INSULATED ADJUSTABLE WRENCHES



- › Finger stops help keep hands safe.
- › 2 color warning handle insulation - color changes from orange to yellow if insulation integrity is compromised.
- › Graduated head, 15° angle.
- › Burnished finish.
- › Thumbwheel rotates counterclockwise.

Product #	Max Opening (in)	Overall Length (in)	Weight (lbs)
FA-113.8TAVSE	1-1/16	8-15/32	0.83
FA-113.10TAVSE	1-3/16	10-7/16	1.37
FA-113.12TAVSE	1-11/32	12-19/32	1.93
FA-113.15TAVSE	1-47/64	15-9/16	3.12



WRENCHES



BLACK OXIDE SPUD HANDLE ADJUSTABLE WRENCH

- › Non-Reflective black oxide finish for use where none plated products are required.
- › Large jaw opening fits all nuts and bolts up to 1-1/2 inches.
- › Square jaw opening provides strength and tight fit.
- › Eliminates the need for carrying several fixed size wrenches.
- › Hardened taper handle aligns bolt and rivet holes.

Product #	Max Opening (in)	Overall Length (in)	Weight (lbs)
J712SC	1-1/2	16-3/32	2.45



ADJUSTABLE

FACOM® SATIN MONKEY WRENCHES



- › Satin finish provides corrosion resistance and a slip-resistant grip.
- › Sturdy, wide-opening tools for heavy-duty work on farms and building sites.
- › Fixed jaw/handle and worm gear made from hardened steel.
- › Smooth jaw faces help prevent marring of fastener surfaces.

Product #	Max Opening (in)	Jaw Depth (in)	Jaw Thickness (in)	Height (in)	Overall Length (in)	Weight (lbs)
FA-105.230	2-3/8	1-25/32	25/32	19/32	9-1/16	1.15
FA-105.280	2-3/4	1-11/32	21/32	25/32	11-1/32	1.79
FA-105.375	3-1/8	1-25/32	7/8	7/8	14-23/32	3.36

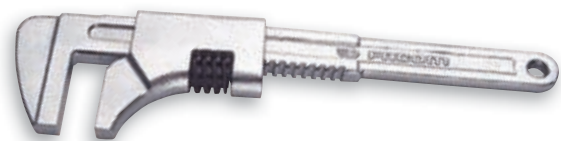

PROTO-GRIP™ CAST IRON PIPE WRENCHES

- › Gripping jaw teeth and spring-loaded hook jaw; allow one-hand operation or hands free option along with a ratcheting action for job speed.
- › Standard handle lengths with wide gripping surface for increased comfort on all jobs.
- › Forged steel jaw provides outstanding strength.
- › Heel Jaw designed to work in both directions.
- › Spring hook jaw provides a ratcheting function making threaded pipe fitting efficient.
- › Hanging hole for storage.
- › Field repairable by removing the rivet pin located on the bottom side of the jaw.
- › Replacement parts available.



Product #	Max Opening (in)	Overall Length (in)	Weight (lbs)
J810PG	1-1/2	10	1.98
J814PG	2	14	3.64

ALUMINUM PIPE WRENCHES

- › Light weight aluminum for less job fatigue.
- › Standard handle lengths with wide gripping surface for increased comfort and one-hand operation.
- › Forged steel jaw provides outstanding strength.
- › Large knurl and power threads provide fast, positive jaw adjustment.
- › Graduation markings on hook jaw show approximate opening for pipe sizes.
- › Riveted jaw pin for safety.
- › Hanging hole for storage.
- › Field repairable by removing the rivet pin located on the bottom side of the jaw.
- › Replacement parts available.

Product #	Max Opening (in)	Overall Length (in)	Weight (lbs)
J810A	1-1/2	10	1.10
J812A	2	12	1.72
J814A	2	14	2.15
J818A	3-1/2	18	3.60
J824A	4	24	5.65
J836A	5	36	10.60
J848A	6	48	17.00



HEAVY-DUTY CAST IRON PIPE WRENCHES

- › Forged steel jaw provides outstanding strength.
- › Full floating hook jaw, provides instant grip, easy release.
- › Large knurl and power threads provide fast, positive jaw adjustment.

Product #	Max Opening (in)	Overall Length (in)	Weight (lbs)
J806HD	3/4	6	0.45
J808HD	1	8	0.80
J810HD	1-1/2	10	1.76
J812HD	2	12	2.66
J814HD	2	14	3.76
J818HD	3-1/2	18	5.82
J824HD	4	24	9.58
J836HD	5	36	19.32
J848HD	6	48	35.36
J860HD	8	60	41.40

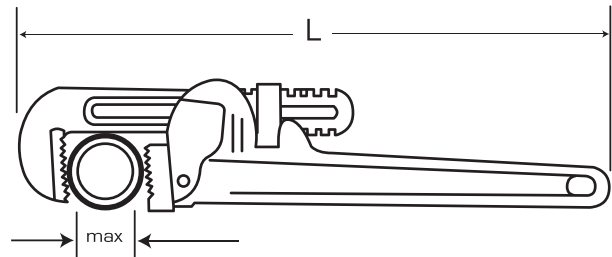

PIPE WRENCH REPLACEMENT PARTS

- › Replacement parts for heavy-duty pipe wrenches.

Parts For	Handle, Heel Jaw, and Pin Assemble	Weight (lbs)	Hook Jaw	Weight (lbs)	Heel Jaw and Pin	Weight (lbs)	Knurl	Weight (lbs)	Coil and Flat Spring	Weight (lbs)
J806HD	J806H	0.33	J806B	0.11	J806C	0.02	J806D	0.03	J806E	0.01
J808HD	J808H	0.61	J808B	0.23	J808C	0.04	J808D	0.03	J808E	0.01
J810HD	J810H	1.20	J810B	0.45	J810C	0.08	J810D	0.07	J810E	0.01
J812HD	J812H	1.97	J812B	0.68	J812C	0.15	J812D	0.09	J812E	0.02
J814HD	J814H	2.79	J814B	0.97	J814C	0.15	J814D	0.11	J814E	0.03
J818HD	J818H	4.09	J818B	1.57	J818C	0.23	J818D	0.18	J818E	0.04
J824HD	J824H	7.35	J824B	2.36	J824C	0.32	J824D	0.31	J824E	0.06
J836HD	J836H	14.40	J836B	4.37	J836C	0.58	J836D	0.47	J836E	0.07
J848HD	-	-	J848B	7.31	J848C	0.72	J848D	0.68	J848E	0.11
J860HD	-	-	J860B	12.50	J860C	1.50	J860D	0.85	J860E	0.08

Parts For	Hook Jaw	Weight (lbs)	Heel Jaw	Weight (lbs)	Pin	Weight (lbs)	Spring	Weight (lbs)
J810PG	J810PGB	0.60	J810PGC	0.31	J810PGD	0.04	J810PGE	0.01
J814PG	J814PGB	0.84	J814PGC	0.29	J814PGD	0.08	J814PGE	0.01

4 PIECE INTERNAL PIPE WRENCH SET

Product #: **J140SET**

- › Ideal for removing broken threaded pipe ends, plugs, and fittings.
- › Installation and removal without thread damage.
- › Eccentric cam action engages wrench against the walls of the pipe.
- › Hex body allows for use of adjustable wrench for added torque.
- › Made from hardened steel and plated to help prevent rust.
- › Weight (lbs): 1.95

Contents	Size (in)	Overall Length (in)
J140-38	3/8	3
J140-34	3/4	3
J140-12	1/2	3
J140-1	1	3



INTERNAL PIPE WRENCHES

- › Ideal for removing broken threaded pipe ends pipe plugs and fittings.
- › Installation and removal without thread damage.
- › Eccentric cam action engages wrench against the walls of the pipe.
- › Hex body allows for use of adjustable wrench for added torque.
- › Made from hardened steel and plated to help prevent rust.

Product #	Size (in)	Overall Length		Weight (lbs)
		(in)	(in)	
J140-38	3/8	3	0.21	
J140-34	3/4	3	0.49	
J140-12	1/2	3	0.32	
J140-1	1	3	0.85	



UNIVERSAL CHAIN WRENCH

- › Fits any shape pipe.
- › Forged steel handle has deep milled teeth.
- › Chain capacity rating: 6,200 lbs.

Product #	Capacity Range (in)	Overall Length (in)	Weight (lbs)
J801	7/8 to 4	16-1/2	2.33



UNIVERSAL CHAIN WRENCH REPAIR KIT

- › Fits any shape pipe.
- › Chain capacity rating: 6,200 lbs.



Product #	Overall Length (in)	Weight (lbs)
J801RK	6-1/5	0.73

BLACK OXIDE ADJUSTABLE FACE SPANNER WRENCHES

- › Non-reflective black oxide finish for use where non-plated products are required.
- › Precision machined pins provide engagement with holes or slots on the face of a bearing or nut.
- › Used to tighten collars, lock nut rings and seal/packing nuts on hydraulic cylinders.



Product #	Max Opening (in)	Pin Diameter (in)	Pin Length (in)	Overall Length (in)	Weight (lbs)
JC482	2	3/16	1/4	6-3/8	0.31
JC483	3	1/4	1/4	8-1/4	0.52
JC484	4	5/16	1/2	10-3/8	1.02



FACOM® SATIN FACE SPANNER - ROUND PIN



- › Satin finish provides corrosion resistance and a slip-resistant grip.
- › Precision machined pins provide engagement with round holes on the face of the nut.
- › Each double-ended, round interchangeable pin has two diameters for a variety of applications.



Product #	Max Opening (in)	Height (in)	Overall Length (in)	Weight (lbs)
FA-117.B	4	1-25/32	9-3/4	1.45

FACOM® SATIN METRIC PIN REPLACEMENTS - ROUND



Product #	Size (mm)	Pin Diameter (in)	Height (in)	Weight (lbs)
FA-117.E1	2.5 - 4	3/32 & 5/32	19/32	0.03
FA-117.E2	6 - 8	1/4 & 5/16	19/32	0.05
FA-117.E3	3 - 5	1/8 & 3/16	19/32	0.03
FA-117.E4	7 - 9	9/32 & 11/32	19/32	0.06



FACOM® SATIN FACE SPANNER - SQUARE PIN



- › Satin finish provides corrosion resistance and a slip-resistant grip.
- › Precision machined square pins provide engagement with square holes or slots on the face of the nut.
- › Interchangeable pins are easy to swap out.

Product #	Max Opening (in)	Height (in)	Overall Length (in)	Weight (lbs)
FA-118A	4	1-25/32	9-3/4	1.41



FACOM® SATIN METRIC PIN REPLACEMENTS - SQUARE



Product #	Size (mm)	Pin Diameter (in)	Height (in)	Weight (lbs)
FA-118.EC4	4	5/32	19/32	0.02
FA-118.EC5	5	6/32	3/8	0.02
FA-118.EC8	8	10/32	3/8	0.03



FACOM® METRIC HINGED HOOK SPANNER WRENCHES



Product #	Size (mm)	Max Opening (in)	Head Thickness (in) (D)	Hook Thickness (in)	Height (in)	Overall Length (in)	Weight (lbs)
FA-125A.35	15-35	1-1/2	13/64	1/8	5/16	6-39/64	0.17
FA-125A.50	35-50	1-31/32	15/64	5/32	7/16	7-61/64	0.37
FA-125A.80	50-80	3-5/32	5/16	13/64	7/16	11-1/32	0.83
FA-125A.120	80-120	4-23/32	23/64	7/32	15/32	13-37/64	1.54
FA-125A.180	120-180	7-3/32	7/16	19/64	15-15/16	19-3/8	3.26

FACOM® HEAVY-DUTY METRIC HOOK SPANNER WRENCHES



Product #	Size (mm)	Hook Thickness (in)	Overall Length (in)	Weight (lbs)
FA-119.3/8	120-224	3/8	24	6.96
FA-119.3/4	220-324	3/4	26	13.01

ADJUSTABLE HOOK SPANNER WRENCHES

- › Non-reflective black oxide finish for use where non-plated products are required.
- › Use to tighten side slot nuts on collars, lock nuts and bearings.



Product #	Capacity Range	Hook Thickness (in)	Hook Depth (in)	Overall Length (in)	Weight (lbs)
JC471	3/4 to 2	11/32	1/8	6-3/8	0.23
JC472	1-1/4 to 3	13/32	5/32	8-1/8	0.43
JC474	2 to 4-3/4	15/32	3/16	11-3/8	1.03
JC474A	4-1/2 to 6-1/4	15/32	1/4	12-1/8	1.07
JC474B	6-1/8 to 8-3/4	15/32	5/16	13-3/4	1.40

FACOM® ADJUSTABLE HEAVY-DUTY HOOK WRENCHES



- › Satin finish provides corrosion resistance and a slip-resistant grip.
- › Hook design is used to tighten side slots on collars, lock nuts and bearings.
- › Worm gear design allows for precision adjustments.



Product #	Size (in)	Max Opening (in)	Height (in)	Overall Length (in)	Weight (lbs)
FA-115A.50	1	1-31/32	31/32	20-7/8	0.83
FA-115A.100	3	3-15/16	25/32	8-15/32	1.96
FA-115A.200	7	7-7/8	25/32	14-3/8	4.57

ADJUSTABLE PIN SPANNER WRENCHES

- › Non-reflective black oxide finish for use where non-plated products are required.
- › Precision machined pins provide engagement with side holes or slots.
- › Used to tighten side slot nuts on collars, lock nuts and bearings.



Product #	Capacity Range	Pin Diameter (in)	Pin Length (in)	Hook Thickness (in)	Overall Length (in)	Weight (lbs)
JC491	3/4 to 2	1/8	1/8	11/32	6-3/8	0.23
JC492	3/4 to 2	3/16	5/32	11/32	6-3/8	0.23
JC494	1-1/4 to 3	3/16	3/16	13/32	8-1/8	0.42
JC495	1-1/4 to 3	1/4	7/32	13/32	8-1/8	0.42
JC497	2 to 4-3/4	1/4	1/4	15/32	11-3/8	0.99
JC499	4-1/2 to 6-1/4	3/8	1/4	15/32	12-1/8	1.08



FACOM® PRECISION ADJUSTABLE PIN SPANNER WRENCHES



- › Satin finish provides corrosion resistance and a slip-resistant grip.
- › Sliding jaw moves easily along the shank and is designed to be self-locking on to the nut.
- › Precision machined pins provide engagement with holes on the sides of collars and nuts.
- › Interchangeable pins are easy to swap out.



Product #	Size (in)	Max Opening (in)	Height (in)	Overall Length (in)	Weight (lbs)
FA-116.50	1	1-31/32	31/32	8-15/32	0.86
FA-116.100	3	3-15/16	31/32	14-1/4	1.99
FA-116.200	7	7-7/8	1-3/16	20-3/4	4.76



FACOM® PIN REPLACEMENTS FOR FA-116 SERIES



- › Replacement pins for Facom® FA-116.50, FA-116.100 and FA-116.200 Precision Adjustable Pin Spanner Wrenches.
- › Precision machined pins provide engagement with holes on the sides of collars and nuts.
- › Interchangeable pins are easy to swap out.

Product #	Pin Diameter (in)	Pin Height (in)	Overall Length (in)	Weight (lbs)
FA-116.50E1	3/32	3/8	25/32	0.01
FA-116.50E2	5/32	3/8	25/32	0.01
FA-116.100E1	5/32	19/32	31/32	0.03
FA-116.100E2	1/4	19/32	31/32	0.03
FA-116.200E1	1/4	19/32	1-3/16	0.08
FA-116.200E2	5/16	19/32	1-3/16	0.08



FACOM® METRIC HINGED PIN SPANNER WRENCHES



Product #	Size (mm)	Max Opening (in)	Pin Diameter (in)	Hook Thickness (in)	Height (in)	Overall Length (in)	Weight (lbs)
FA-126A.35	15-35	1-2/4	1/8	25/64	19/32	6-39/64	0.17
FA-126A.50	35-50	1-31/32	5/32	15/32	15/32	7-61/64	0.37
FA-126A.80	50-80	3-5/32	13/64	35/64	15/32	11-1/32	0.79
FA-126A.120	80-120	4-23/32	15/64	45/64	21/32	13-37/64	1.54
FA-126A.180	120-180	7-3/32	5/16	25/32	23/32	19-3/8	3.17

FACOM® PIN REPLACEMENTS FOR FA-126A SERIES



- › Replacement pins for Facom® FA-126A.35, FA-126A.50, FA-126A.80, FA-126A.120 and FA-126A.180 Hinged Pin Spanner Wrenches.

Product #	Pin Diameter (in)	Pin Height (in)	Weight (lbs)
FA-126.E35	4/32	3/8	0.01
FA-126.E50	5/32	3/8	0.01
FA-126.E80	6/32	3/8	0.01
FA-126.E120	8/32	19/32	0.04
FA-126.E180	10/32	25/32	0.07

