



QUALTOOL^{INC.}

The Leading U.S. Manufacturer of Quality Fastening Tools for Construction and Industry



QUALTOOL
PREMIUM
QUALITY FASTENING TOOLS

CRYPTONITETM
IMPACT
MADE IN USA BY: QUALTOOL INC.

QUALTOOL
INDUSTRIAL
HEAVY DUTY FASTENING TOOLS

THUNDER
BAY
FASTENING TOOLS OF
COLOR AND QUALITY





**Professionals' Choice
for Over 44 Years**



**Proprietary Manufacturing Process
for Today's Demanding
Power Tools**



**Exceeding our Customers'
Expectations with Each Order**



**Colored Parts for Ease of Identification
and 2-Piece Square Bits
for unmatched Fit.**



“We believe in providing our customers with the best product at the lowest possible price & delivering it on time.”

**LTC J.T. Standlee, USA, Ret.
President**

Table of Contents



Nutsetters	5
Phillips Bits—Insert and Power	6
Slotted Bits—Insert	6
Square Bits—Insert and Power	7
Star Bits—Insert and Power	7
App Kits	8
Merchandisers	8
Fishbowl Displays	9
Plan-a-Grams	9



Magnetic and Nonmagnetic Bit Holders	10,11
Quick Change Bit Holder	10
Locator Bit Holder	10
Yankee Bit Holder	11
Female Square Drive Bit Holder	11
Nutsetters—Short and Long	12,13
Phillips Bits—Insert and Power	14,15
Stainless Bits	14,21
Clutch Bits	15
PoziDriv® Bits—Insert and Power	16
Slotted Bits—Insert and Power	16,17
Slotted Bits—with Finder	18
Torq-Set—Insert and Power	19
Star Female Square Drive Bits	19
Star (Torx®) Bits—Insert and Power	20,21
Square Bits—Insert and Power	22
Square 2-Piece Bits—Insert and Power	22
Square Recess Bits—Insert and Power	23
Square-Phillips Combo Bits—Insert and Power	23
Socket Head Bits—Insert and Power	24,25
Socket Head L-Keys	26
Star (Torx®) L-Keys	26
Tri-Wing Bits—Insert and Power Bits	27
Spanner Bits	27
Star Square Drive	28
High Torque Sockets	28
Reversible Sockets and Shanks	28
Extensions	29
1/4" Square Drive Sockets	30
3/8" Square Drive Sockets	30
1/2" Square Drive Sockets	30
1/4" Square Drive Sockets—Metric	31
3/8" Square Drive Sockets—Metric	31
1/2" Square Drive Sockets—Metric	31

Table of Contents Cont. on Page 4

This catalog contains bits and sockets for driving these heads.



PHILLIPS



POZIDRIV®



PHILLIPS TAMPER RESISTANT



SPANNER



STAR



STAR TAMPER RESISTANT



HEXAGON



SQUARE



SLOTTED



CLUTCH



TORQ-SET®



TRI-WING®



HEX SOCKET



HEX SOCKET TAMPER RESISTANT



SQUARE PHILLIPS



SQUARE RECESS

Safety

Users of any tool should always use the tool in a safe manner, and in the manner to which it is intended. Users should always wear safety glasses, inspect tools for damage, replace damaged tools immediately, never modify a tool, and never use a tool beyond its useful life.

Table of Contents Cont.

	<u>PAGE</u>
Double Ended Bits—Insert and Power	32
Screwdrivers, Hand, “Hammer Head” Driver	32,33,34,35
Hanging “Tom Dooley” Pak	35
Kits	36,37,38
Fishbowls	38
Merchandisers	39,40
Concrete Lead Anchor Drive	40
Drill Adaptor	41
Lag Driver	41
Wing Nut Driver—Power Driver and Hand Driver	41



Triple Square Bits—Insert	42
Socket Head Bits—Power	42
Phillips Bits—Power	42
Star (Torx®) Bits—Insert and Power	42,43
Star (Torx®) Bits—Power w/Finder	43
Universal Adaptors	43
Sockets	44
Hand Driver	44
L-Keys	44
Female Square Drive Bit Holders	44
Female Square Drive Quick Change Bit Holder	45
Hex Drive Extensions	45
Female Square Drive Extensions	45



Nutsetters	46
Phillips Bits—Insert and Power	46
Square Bits—Insert and Power	47
Counter Merchandisers	48



Specialty Magnets	49
Magnetic Sweepers	50
Forklift Magnets	50
Safety Glasses	51
Note Pages	52,53
Sample Request Page	54
Blanket Order Page	55

This catalog contains bits and sockets for driving these heads.



PHILLIPS



POZIDRIV®



PHILLIPS TAMPER RESISTANT



SPANNER



STAR



STAR TAMPER RESISTANT



HEXAGON



SQUARE



SLOTTED



CLUTCH



TORQ-SET®



TRI-WING®



HEX SOCKET



HEX SOCKET TAMPER RESISTANT



SQUARE PHILLIPS



SQUARE RECESS

Safety

Users of any tool should always use the tool in a safe manner, and in the manner to which it is intended. Users should always wear safety glasses, inspect tools for damage, replace damaged tools immediately, never modify a tool, and never use a tool beyond its useful life.



1/4" HEX DRIVE POWER MAGNETIC NUTSETTERS



Broached Hex	Overall Length	Part Number	Feature
3/16"	1-5/8"	KL-MSH 3/16	Lobular
1/4"	1-5/8"	KL-MSH 1/4	Lobular
5/16"	1-5/8"	KL-MSH 5/16	Lobular
3/8"	1-3/4"	KL-MSH 3/8	Lobular
7/16"	1-3/4"	KL-MSH 7/16	Lobular

1/4" HEX DRIVE POWER MAGNETIC NUTSETTERS



Broached Hex	Overall Length	Part Number	Feature
3/16"	2-9/16"	KL-MSHL 3/16	Lobular
1/4"	2-9/16"	KL-MSHL 1/4	Lobular
5/16"	2-9/16"	KL-MSHL 5/16	Lobular
3/8"	2-9/16"	KL-MSHL 3/8	Lobular
7/16"	2-9/16"	KL-MSHL 7/16	Lobular

1/4" HEX DRIVE POWER MAGNETIC NUTSETTERS



Broached Hex	Overall Length	Part Number	Feature
1/4"	4"	KL-MSHL 1/4-4	Lobular
5/16"	4"	KL-MSHL 5/16-4	Lobular
3/8"	4"	KL-MSHL 3/8-4	Lobular

1/4" HEX DRIVE POWER MAGNETIC NUTSETTERS



Broached Hex	Overall Length	Part Number	Feature
1/4"	6"	KL-MSHL 1/4-6	Lobular
5/16"	6"	KL-MSHL 5/16-6	Lobular
3/8"	6"	KL-MSHL 3/8-6	Lobular

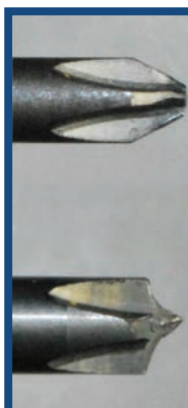

Twisting, Wearing and Chipping become enemies to cost, productivity and protecting fasteners.

Qryptonite combines a cost effective production process with an engineered "balance" of hardness and a hard protective plating.

What They're Saying about



"You've taken fastening tools to a whole new level." - Ohio Distributor

"They like 'em really good, they're coming back for more." - South Florida Distributor



PHILLIPS INSERT BITS—1/4" HEX



Point Size	Overall Length	Part Number	Feature
#1	1"	K250PB1	Pozidrive
#2	1"	K250PB2	
#2 Reduced	1"	K250PBR2	
#3	1"	K250PB3	
#2	1"	K250PZ2	



PHILLIPS POWER BITS—1/4" HEX



Point Size	Overall Length	Part Number	Feature
#1	1-15/16"	K30-1P	Pozidrive
#2	1-15/16"	K30-2P	
#3	1-15/16"	K30-3P	
#2	2-3/4"	K32-2P	
#3	2-3/4"	K32-3P	
#2	3-1/2"	K34-2P	
#3	3-1/2"	K34-3P	
#2	6"	K36-2P	
#3	6"	K36-3P	
#2	1-15/16"	K30-2PZ	



SLOTTED INSERT BITS—1/4" HEX



Screw Size	Blade Width	Blade Thickness	Overall Length	Part Number
#6	.250	.040	1"	K250SS6
#8	.281	.046	1"	K250SS8



The FASTENER is the FOCUS

with all Qryptonite testing and factory evaluations. Results demonstrated between 200% to 2000% increase in the usable life of the fastening tool over the competition.



STAR (TORX®) INSERT BITS—1/4" HEX



Overall Length	Point Size	Part Number
1"	10	K60-T10
1"	15	K60-T15
1"	20	K60-T20
1"	25	K60-T25
1"	27	K60-T27
1"	30	K60-T30
1"	40	K60-T40



STAR (TORX®) POWER BITS—1/4" HEX



Overall Length	Point Size	Part Number
1-15/16"	10	K62-T10
1-15/16"	15	K62-T15
1-15/16"	20	K62-T20
1-15/16"	25	K62-T25
1-15/16"	27	K62-T27
1-15/16"	30	K62-T30
1-15/16"	40	K62-T40



SQUARE INSERT BITS—1/4" HEX



Overall Length	Point Size	Part Number
1"	1	K250R1
1"	2	K250R2
1"	3	K250R3



SQUARE POWER BITS—1/4" HEX



Overall Length	Point Size	Part Number
1-15/16"	1	K80-1R
1-15/16"	2	K80-2R
1-15/16"	3	K80-3R
2-3/4"	2	K82-2R
2-3/4"	3	K82-3R
3"	2	K84-2R
3"	3	K84-3R
3-1/2"	2	K86-2R
3-1/2"	3	K86-3R

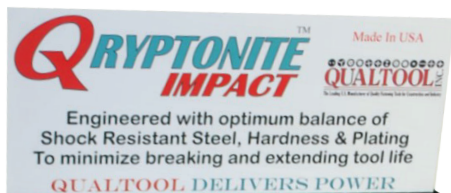

Part No. K2055—Merchandiser w/ Parts
 Part No. 2048-B—Black Metal Display Only

Part Number	Quantity	Part Number	Quantity
K30-1P	20	K60-T40	10
K30-2P	30	K250PB2	100
K30-3P	20	K250PBR2	250
K32-2P	20	K250PB3	30
K32-3P	10	KL-MSH 1/4	8
K34-2P	25	KL-MSH 5/16	8
K36-2P	25	KL-MSH 3/8	8
K80-1R	10	KL-MSHL 1/4	5
K80-2R	20	KL-MSHL 5/16	15
K80-3R	20	KL-MSHL 3/8	10
K84-2R	15	MBH 1/4	10
K60-T25	20	MBH 1/4-QC	4
K60-T30	20	MBHM 1/4	4



QRYPTONITE APP KITS are packaged in a professional quality reusable pocket case. The case may also be used as a hand driver.

KIT NAME Feature Bit	APP KIT - 1 Assortment	APP KIT - 2 #2 Phillips	APP KIT - 3 #2 Square	APP KIT - 4 #2 Phillips Reduced
Applications	GENERAL ELECTRICAL CONSTRUCTION FACTORY	GENERAL DECKS CONSTRUCTION FACTORY	DECKS CABINETS CONSTRUCTION FACTORY	DRYWALL
Part No	KK 1201	KK 1202	KK 1203	KK 1204
K250 PB1	1	1		1
K250 PB2	1	4	1	1
K250 PBR2				4
K250 PB3	1	1	1	1
K60-T20	1	1	1	1
K250 R1	1			
K250 R2	1	1	4	
K250 R3	1		1	
K250 SS6	1			
MBHZ 1/4	1	1	1	1



*Feature Bit Denoted in RED



KP-5016—16 SKU



Part Number	KP-5016 16 SKU	KP-5012A 12 SKU	KP-5012B 12 SKU	KP-5008A 8 SKU	KP-5008B 8 SKU
KK-1100	2	2			
K30-2P-5PK	4	4	4	4	
K34-2P-3PK	2	2	2	2	
K36-2P-2PK	2	2		2	
K30-3P-5PK	2	2	2	2	
K34-3P-3PK	2	2	2	2	
K250PB2-5PK	4	4	4	4	
K250PBR2-5PK	4	4	4	4	
K250PB3-5PK	2	2	2	2	
K80-2R-5PK	2	2			
K80-3R-5PK	2				
KL-MSH SET-3PK	2	2	2		2
KL-MSH 1/4-2PK					2
KL-MSH 5/16-2PK					2
KL-MSH 3/8-2PK					2
KL-MSHL SET-3PK	2	2	2		2
KL-MSHL 1/4-2PK	2		2		2
KL-MSHL 5/16-2PK	2		2		2
KL-MSHL 3/8-2PK	2		2		2



Part Number	Quantity
FB-KL-MSHL 5/16	75 PCS.
FB-KL-MSHL 1/4	75 PCS.
FB-KL-MSHL 3/8	50 PCS.
FB-KL-MSH 1/4	100 PCS.
FB-KL-MSH 5/16	100 PCS.

Nutsetters



Part Number	Quantity
FB-K250PB1	500 PCS.
FB-K250PB2	500 PCS.
FB-K250PB3	500 PCS.
FB-K250PBR2	500 PCS.
FB-K250R2	500 PCS.

Insert Bits



Part Number	Quantity
FB-K30-1P	250 PCS.
FB-K30-2P	250 PCS.
FB-K30-3P	250 PCS.
FB-K80-1R	250 PCS.
FB-K80-3R	250 PCS.

Power Bits







*Other parts available in Fish Bowls upon request.
*Fish Bowl Part No. FB-2 Pictured

Bit Holders

For 1/4" Hex Insert Bits

For use in all Drywall Drivers.









ALL BIT HOLDERS ARE MANUFACTURED OF INDUSTRIAL QUALITY STAINLESS STEEL

		NON-MAGNETIC		MAGNETIC	
		OVERALL LENGTH	PART NO.	OVERALL LENGTH	PART NO.
1/4" HEX DRIVE-NO RING RETAINER					
	3/8" BODY	1-7/8"	BHE 1/4	1-7/8"	MBHE 1/4
1/4" HEX DRIVE-WITH RING RETAINER					
	7/16" BODY	3" 2-5/16" 2-1/8"	BH1/4 BHW1/4 BHZ1/4	3" 2-5/16" 2-1/8"	MBH1/4 MBHW1/4 MBHZ1/4
	3/8" BODY, 7/16" NOSE	2-1/4" 3"	BHC1/4 BHT1/4	2-1/4" 3"	MBHC1/4 MBHT1/4†
	3/8" BODY	2-7/8" 4" 6" 8" 10" 12"	BHR1/4 BHR1/4-4 BHR1/4-6 BHR1/4-8 BHR1/4-10 BHR1/4-12	2-7/8" 4" 6" 8" 10" 12"	MBHR1/4 MBHR1/4-4 MBHR1/4-6 MBHR1/4-8 MBHR1/4-10 MBHR1/4-12
1/4" HEX DRIVE – QUICK CHANGE		—	—	2-3/8"	MBH1/4-QC
					
1/4" HEX DRIVE -SCREW ON CAP WITH O-RING					
	7/16" BODY	3-1/8" 4" 6" 8" 10" 12" 2-7/8" 2-3/8"	BHM1/4 BHM1/4-4 BHM1/4-6 BHM1/4-8 BHM1/4-10 BHM1/4-12 BHN1/4 BHO1/4	3-1/8" 4" 6" 8" 10" 12" 2-7/8" 2-3/8"	MBHM1/4 MBHM1/4-4 MBHM1/4-6 MBHM1/4-8 MBHM1/4-10 MBHM1/4-12 MBHN1/4 MBHO1/4
1/4" HEX DRIVE LOCATOR - DRIVER - BIT HOLDER					
Magnetic driver keeps screws straight while driving. Uses insert bit.		—	—	4-3/4"	LBH1/4
					

† Replacement part for MBHS1/4

1/4" Hex Drive Nutsetters



Magnetic and Non-Magnetic For driving Hex Head Self Drilling Fasteners & Sheet Metal Screws.

	BROACHED HEX	OVERALL LENGTH	NON-MAG. PART NO.	MAGNETIC PART NO.
1/4" HEX INSERT DRIVE NUTSETTERS				
 <p style="text-align: right;">Complete Set (5)</p>	3/16"	1-5/32"	SHS 3/16	MSHS 3/16
	1/4"	1-5/32"	SHS 1/4	MSHS 1/4
	5/16"	1-5/32"	SHS 5/16	MSHS 5/16
	3/8"	1-5/32"	SHS 3/8	MSHS 3/8
	7/16"	1-1/4"	SHS 7/16	MSHS 7/16
			SHS-SET	MSHS-SET
1/4" HEX DRIVE POWER NUTSETTERS — SHORT				
 <p style="text-align: right;">THIN WALL*</p>	3/16"	1-5/8"	SH 3/16	MSH 3/16
	1/4"	1-5/8"	SH 1/4	MSH 1/4
	5/16"	1-5/8"	SH 5/16	MSH 5/16
	3/8"	1-3/4"	SH 3/8	MSH 3/8
	7/16"	1-3/4"	SH 7/16	MSH 7/16
	1/4"	2"	SH 1/4-2	-
	1/2"	1-3/4"	SH 1/2	MSH 1/2
 <p style="text-align: right;">TAPERED Complete Set (6)</p>	1/4"	1-5/8"	SHT 1/4	MSHT 1/4
	1/4"	2"	SHB 1/4 SH-SET	MSHB 1/4 MSH-SET
1/4" HEX POWER DRIVE NUTSETTERS — LONG				
 <p style="text-align: right;">Complete Set (6)</p>	3/16"	2-9/16"	SHL 3/16	MSHL 3/16
	1/4"	2-9/16"	SHL 1/4	MSHL 1/4
	5/16"	2-9/16"	SHL 5/16	MSHL 5/16
	3/8"	2-9/16"	SHL 3/8	MSHL 3/8
	7/16"	2-9/16"	SHL 7/16	MSHL 7/16
	1/2"	2-9/16"	SHL 1/2	MSHL 1/2
		SHL-SET	MSHL-SET	
1/4" HEX DRIVE POWER NUTSETTERS — EXTRA LONG				
	1/4"	4"	SHL 1/4-4	MSHL 1/4-4
		6"	SHL 1/4-6	MSHL 1/4-6
		8"	SHL 1/4-8	MSHL 1/4-8
		10"	SHL 1/4-10	MSHL 1/4-10
		12"	SHL 1/4-12	MSHL 1/4-12
	5/16"	4"	SHL 5/16-4	MSHL 5/16-4
		6"	SHL 5/16-6	MSHL 5/16-6
		8"	SHL 5/16-8	MSHL 5/16-8
		10"	SHL 5/16-10	MSHL 5/16-10
		12"	SHL 5/16-12	MSHL 5/16-12
	3/8"	4"	SHL 3/8-4	MSHL 3/8-4
		6"	SHL 3/8-6	MSHL 3/8-6
		8"	SHL 3/8-8	MSHL 3/8-8
		10"	SHL 3/8-10	MSHL 3/8-10
		12"	SHL 3/8-12	MSHL 3/8-12
		7/16"		MSHL 7/16-6
1/4" HEX DRIVE POWER NUTSETTERS — IMPACT LOBULAR				
<p>Lobular design engages sides of screws, reduces "rounding off" ideal for use with impact tools.</p>   <p style="text-align: right;">Complete Set (5)</p>	3/16"	1-5/8"		L-MSH 3/16
	1/4"	1-5/8"		L-MSH 1/4
	5/16"	1-5/8"		L-MSH 5/16
	3/8"	1-3/4"		L-MSH 3/8
	7/16"	1-3/4"		L-MSH 7/16
			L-MSH-SET	
1/4" HEX DRIVE POWER NUTSETTERS — IMPACT LOBULAR				
<p>Lobular design engages sides of screws, reduces "rounding off" ideal for use with impact tools.</p>   <p style="text-align: right;">Complete Set (5)</p>	3/16"	2-9/16"		L-MSHL 3/16
	1/4"	2-9/16"		L-MSHL 1/4
	5/16"	2-9/16"		L-MSHL 5/16
	3/8"	2-9/16"		L-MSHL 3/8
	7/16"	2-9/16"		L-MSHL 7/16
			L-MSHL-SET	

* Extra thin for shutter installation

1/4" Hex Drive Nutsetters

Metric

	BROACHED HEX	OVERALL LENGTH	NON-MAG. PART NO.	MAGNETIC PART NO.
1/4" HEX DRIVE INSERT NUTSETTERS — METRIC				
 Complete Set (5)	5mm	1-1/8"	SHS 5M	MSHS 5M
	6mm	1-1/8"	SHS 6M	MSHS 6M
	7mm	1-1/8"	SHS 7M	MSHS 7M
	8mm	1-1/8"	SHS 8M	MSHS 8M
	10mm	1-1/8"	SHS 10M SHSM-SET	MSHS 10M MSHSM-SET
1/4" HEX DRIVE POWER NUTSETTERS — METRIC				
 Complete Set, Short (6)	5mm	1-5/8"	SH 5M	MSH 5M
	5.5mm	1-5/8"	SH 5.5M	MSH 5.5M
	6mm	1-5/8"	SH 6M	MSH 6M
	7mm	1-5/8"	SH 7M	MSH 7M
	8mm	1-5/8"	SH 8M	MSH 8M
 Complete Set, Long (10)	10mm	1-3/4"	SH 10M SHM-SET	MSH 10M MSHM-SET
	4mm	2-9/16"	SHL 4M	MSHL 4M
	5mm	2-9/16"	SHL 5M	MSHL 5M
	5.5mm	2-9/16"	SHL 5.5M	MSHL 5.5M
	6mm	2-9/16"	SHL 6M	MSHL 6M
	7mm	2-9/16"	SHL 7M	MSHL 7M
	8mm	2-9/16"	SHL 8M	MSHL 8M
	9mm	2-9/16"	SHL 9M	MSHL 9M
	10mm	2-9/16"	SHL 10M	MSHL 10M
	12mm	2-9/16"	SHL 12M	MSHL 12M
	13mm	2-9/16"	SHL 13M SHLM-SET	MSHL 13M MSHLM-SET

*Other metric sizes available upon request.

1/4" Hex Power Drive Nutsetters

Special Non-Magnetic*



BROACHED HEX	OVERALL LENGTH	NON-MAG. PART NO.
1/4"	2-9/16"	CSHL 1/4
5/16"	2-9/16"	CSHL 5/16
3/8"	2-9/16"	CSHL 3/8
7/16"	2-9/16"	CSHL 7/16
1/2"	2-9/16"	CSHL 1/2

*For non-ferrous (non-magnetic) screws (plastic, nylon, stainless, etc.). Screw held by steel C-ring.

1/4" Hex Drive Nutsetters

Non-Magnetic Insert

Replacement Parts for Nutsetter Kit 2010
for use in Battery Drills and Drivers



Complete Set (7)

BROACHED HEX	OVERALL LENGTH	NON-MAG. PART NO.
3/16"	1-1/4"	2011
1/4"	1-1/4"	2012
9/32"	1-1/4"	2013
5/16"	1-1/4"	2014
11/32"	1-1/4"	2015
3/8"	1-1/4"	2016
7/16"	1-3/8"	2017
		2010







Phillips Bit Chart

This brief chart will help you match the screw size to the proper Phillips point.

POINT #0 – FOR SCREWS #0 & #1
POINT #1 – FOR SCREWS #2 THRU #4
POINT #2 – FOR SCREWS #5 THRU #10
POINT #3 – FOR SCREWS #12 THRU #16 AND 1/4
POINT #4 – FOR SCREWS 5/16 OR 18 AND LARGER



Phillips Insert Bits

		POINT SIZE	OVERALL LENGTH	PART NO.
1/4" HEX SHANK INSERT BITS				
 A STYLE		1	1"	250PB1-A
		2	1"	250PB2-A
		3	1"	250PB3-A
 STANDARD STYLE		0	1"	250PB0
		1	1"	250PB1
		2	1"	250PB2
		3	1"	250PB3
		2	1-1/2"	250PB2-1.5
		1	2"	250PB1-2
		2	2"	250PB2-2
		3	2"	250PB3-2
		2	2-1/2"	250PB2-2.5
		2	3"	250PB2-3
Complete Set (10)				250PB-SET
		0	1"	*250PBR0
		1	1"	*250PBR1
		2	1"	*250PBR2
		2	2"	*250PBR2-2
 ACR® ANTI-CAM OUT BITS		1	1"	250PB1-CR
		2	1"	250PB2-CR
		3	1"	250PB3-CR
		2	1"	*250PBR2-CR
 TYPE 440 STAINLESS STEEL		1	1"	250PB1SS
		2	1"	250PB2SS
		3	1"	250PB3SS
	Complete Set (3)			
5/16" HEX SHANK INSERT BITS				
		1	1-1/4"	312PB1
		2	1-1/4"	312PB2
		3	1-1/4"	312PB3
		4	1-1/4"	312PB4

*Reduced diameter bit

Threaded Shank Power Bits







	THREAD SIZE	OVERALL LENGTH	POINT SIZE	BODY DIAMETER	PART NO.
	1/4"-24	1-1/2"	2	1/4"	15-2P
	10-32	1-1/2"	2	1/4"	16-2P

Phillips Drywall Driver

	OVERALL LENGTH	POINT SIZE	PART NO.
	1"	1	PB1-DD
	1"	2	PB2-DD
	1"	3	PB3-DD



Phillips Power Bits

	OVERALL LENGTH	POINT SIZE	BODY DIAMETER	PART NO.
1/4" HEX SHANK POWER BITS				
	1-15/16"	0	5/32"	30-0P
	1-15/16"	1	3/16"	30-1P
	1-15/16"	2	1/4"	30-2P
	1-15/16"	3	1/4"	30-3P
	1-15/16"	3	5/16"	30-3PA
	2-3/4"	1	3/16"	32-1P
	2-3/4"	2	1/4"	32-2P
	2-3/4"	3	1/4"	32-3P
	2-3/4"	3	5/16"	32-3PA
	3-1/2"	1	3/16"	34-1P
	3-1/2"	2	1/4"	34-2P
	3-1/2"	3	1/4"	34-3P
	3-1/2"	3	5/16"	34-3PA
	6"	1	3/16"	36-1P
	6"	2	1/4"	36-2P
	6"	3	1/4"	36-3P
	6"	3	5/16"	36-3PA
ARC® ANTI-CAM OUT BITS — 1/4" HEX SHANK POWER BITS				
	1-15/16"	1	3/16"	30-1CR
	1-15/16"	2	1/4"	30-2CR
	1-15/16"	3	1/4"	30-3CR
7/16" HEX SHANK POWER BITS				
	3-1/2"	2	1/4"	78-2P
	3-1/2"	3	5/16"	78-3P
	3-1/2"	4	3/8"	78-4P

Phillips Power Bits with Finder

Other lengths available upon request.



POINT SIZE	OVERALL LENGTH	PART NO.
1	3-1/2"	34-1PBF
2	3-1/2"	34-2PBF
3	3-1/2"	34-3PBF

1/4" HEX SHANK INSERT BITS — TAMPER RESISTANT	OVERALL LEN.	POINT SIZE	BODY DIA.	PART NO.
	1"	2	1/4"	250PB2-TR
	1"	3	1/4"	250PB3-TR



Clutch Insert Bits



	POINT SIZE	OVERALL LENGTH	PART NO.
1/4" HEX SHANK INSERT BITS			
	1/8"	1"	250CG2
	5/32"	1"	250CG3
	3/16"	1"	250CG4
	1/4"	1"	250CG5
	Complete Set (4)		



Series "G"







Pozidriv® Insert & Power Bits

	POINT SIZE	BODY DIAMETER	OVERALL LENGTH	PART NO.
1/4" HEX SHANK INSERT BITS 	1	1/4"	1"	250PZ1
	2	1/4"	1"	250PZ2
	3	1/4"	1"	250PZ3
5/16" HEX SHANK INSERT BITS 	1	5/16"	1-1/4"	312PZ1
	2	5/16"	1-1/4"	312PZ2
	3	5/16"	1-1/4"	312PZ3
	4	5/16"	1-1/4"	312PZ4
1/4" HEX SHANK POWER BITS 	1PZ	3/16"	1-15/16"	30-1PZ
	2PZ	1/4"	1-15/16"	30-2PZ
	3PZ	1/4"	1-15/16"	30-3PZ
	1PZ	3/16"	2-3/4"	32-1PZ
	2PZ	1/4"	2-3/4"	32-2PZ
	3PZ	1/4"	2-3/4"	32-3PZ
	1PZ	3/16"	3-1/2"	34-1PZ
	2PZ	1/4"	3-1/2"	34-2PZ
	3PZ	1/4"	3-1/2"	34-3PZ
	1PZ	3/16"	6"	36-1PZ
	2PZ	1/4"	6"	36-2PZ
	3PZ	1/4"	6"	36-3PZ







Slotted Insert Bits

	SCREW SIZE	BLADE WIDTH	BLADE THICKNESS	OVERALL LENGTH	PART NO.
1/4" HEX SHANK (SHORT LENGTH) 	No.1	.109	.024	1"	250SS1
	No.2	.125	.026	1"	250SS2
	No.3	.140	.028	1"	250SS3
	No.4	.156	.032	1"	250SS4
	No.5	.218	.036	1"	250SS5
	No.6	.250	.040	1"	250SS6
	No.8	.281	.046	1"	250SS8
	No.10	.281	.050	1"	250SS10
	No.12	.355	.056	1"	250SS12
	Complete Set (9)				
1/4" HEX SHANK (SHORT LENGTH)  TYPE 440 STAINLESS STEEL	No.2	.125	.026	1"	250SS2SS
	No.4	.156	.032	1"	250SS4SS
	No.6	.250	.040	1"	250SS6SS
	No.8	.281	.046	1"	250SS8SS
Complete Set (4)					250SS-SET-SS
1/4" HEX SHANK (STANDARD LENGTH) 	4F-5R	.187	.034	1-1/2"	250SB1
	6F-8R	.250	.040	1-1/2"	250SB2
	8F-10R	.281	.042	1-1/2"	250SB3
	10F-12R	.281	.046	1-1/2"	250SB4
	12F-14R	.281	.050	1-1/2"	250SB5
	14F-16R	.359	.055	1-1/2"	250SB6
Complete Set (6)					250SB-SET
5/16" HEX SHANK INSERT BITS 	4F-5R	.187	.034	1-1/2"	312SB1
	6F-8R	.250	.040	1-1/2"	312SB2
	8F-10R	.281	.042	1-1/2"	312SB3
	10F-12R	.281	.046	1-1/2"	312SB4
	12F-14R	.312	.050	1-1/2"	312SB5
	14F-16R	.359	.055	1-1/2"	312SB6
Complete Set (6)					312SB-SET



Slotted Power Bits

	OVERALL LENGTH	SCREW SIZE	BLADE THICKNESS	BODY DIAMETER	PART NO.
1/4" HEX DRIVE SHANK					
	1-15/16"	1F-2R	.026	.122	20-1S
		2F-3R	.028	.134	20-2S
		3F-4R	.032	.154	20-3S
		4F-5R	.034	.187	20-4S
		5F-6R	.036	.215	20-5S
		5F-6R	.036	.250	20-6S
		6F-7R	.038	.250	20-7S
		8F-10R	.042	.275	20-8S
		10F-12R	.046	.312	20-9S
		12F-14R	.050	.350	20-10S
	3"	1F-2R	.026	.122	23-1S
		2F-3R	.028	.134	23-2S
		3F-4R	.032	.154	23-3S
		4F-5R	.034	.187	23-4S
		5F-6R	.036	.215	23-5S
		6F-7R	.038	.250	23-6S
		8F-10R	.042	.275	23-8S
		10F-12R	.046	.312	23-9S
		12F-14R	.050	.350	23-10S
		14F-16R	.055	.350	23-12S
	3-1/2"	1F-2R	.026	.122	27-1S
		2F-3R	.028	.134	27-2S
		3F-4R	.032	.154	27-3S
		4F-5R	.034	.187	27-4S
		5F-6R	.036	.215	27-5S
		5F-6R	.036	.250	27-6S
		6F-7R	.038	.250	27-7S
		8F-10R	.042	.275	27-8S
		10F-12R	.046	.312	27-9S
		12F-14R	.050	.350	27-10S
14F-16R	.055	.350	27-12S		
	6"	1F-2R	.026	.122	28-1S
		2F-3R	.028	.134	28-2S
		3F-4R	.032	.154	28-3S
		4F-5R	.034	.187	28-4S
		5F-6R	.036	.215	28-5S
		5F-6R	.036	.250	28-6S
		6F-8R	.040	.250	28-7S
		8F-10R	.042	.275	28-8S
		10F-12R	.046	.312	28-9S
		12F-14R	.050	.350	28-10S
14F-16R	.055	.350	28-12S		



Power Bits With Finders for Slotted Screws

1/4" Hex Drive — Standard Length



PART NO.	SCREW SIZE	BLADE THICKNESS	BIT DIAMETER	OVERALL LENGTH	SHANK PART NO.
40-2BF	4F-6R	.036	.193	3-3/4"	40-2
40-3BF	6F-8R	.040	.241	3-3/4"	40-3
40-4BF	8F-10R	.042	.290	3-3/4"	40-4
40-5BF	10F-12R	.046	.350	3-3/4"	40-5
40-6BF	12F-14R	.050	.395	3-7/8"	40-6
40-7BF	14F-16R	.055	.457	4-1/8"	40-7

7/16" Hex Drive



PART NO.	SCREW SIZE	BLADE THICKNESS	BIT DIAMETER	OVERALL LENGTH	SHANK PART NO.
46-5BF	14F-16R	.055	.457	4-1/8"	46-5
46-6BF	16F-20R	.060	.503	4-1/8"	46-6
46-7BF	20F-22R	.062	.545	4-1/8"	46-7
46-8BF	24F-24R	.065	.595	4-1/8"	46-8

1/4" Hex Drive for Sidewalk Bolts



PART NO.	SCREW SIZE	BLADE THICKNESS	BIT DIAMETER	OVERALL LENGTH	SHANK PART NO.
46-8BF-1/4	24F-24R	.065	.595	4-1/8"	46-8-1/4



Torq-set Insert Bits



	OVERALL LENGTH	SCREW SIZE	PART NO.
1/4" HEX SHANK INSERT BITS			
 Complete Set (9)	1"	0"	90-TS0
	1"	1"	90-TS1
	1"	2"	90-TS2
	1"	3"	90-TS3
	1"	4"	90-TS4
	1"	5"	90-TS5
	1"	6"	90-TS6
	1"	8"	90-TS8
	1"	10"	90-TS10
			90TS-SET

Torq-set® Power Bits



	OVERALL LENGTH	SCREW SIZE	PART NO.
1/4" HEX SHANK POWER BITS			
 Complete Set (9)	1-1/4"	0	92-TS0
	1-1/4"	1	92-TS1
	1-1/4"	2	92-TS2
	1-1/4"	3	92-TS3
	1-1/4"	4	92-TS4
	1-1/4"	5	92-TS5
	1-1/4"	6	92-TS6
	1-1/4"	8	92-TS8
	1-1/4"	10	92-TS10
			92TS-SET
7/16" HEX SHANK POWER BITS			
	1-1/4"	1/4	97-TS1/4
	1-1/4"	5/16	97-TS5/16



STAR Female Square Drive Bits







	POINT SIZE	SQ. DRIVE	PART NO.
 Complete Set (12)	10	1/4"	101-T10
	15	1/4"	101-T15
	20	1/4"	101-T20
	25	1/4"	101-T25
	27	1/4"	101-T27
	30	1/4"	101-T30
	40	3/8"	101-T40
	45	3/8"	101-T45
	47	3/8"	101-T47
	50	3/8"	101-T50
	55	3/8"	101-T55



STAR Insert & Power Bits

	OVERALL LENGTH	POINT SIZE	BODY DIAMETER	PART NO.
1/4" HEX SHANK INSERT BITS	1"	5	1/4" HEX	60-T5
	1"	6		60-T6
	1"	7		60-T7
	1"	8		60-T8
	1"	9		60-T9
	1"	10		60-T10
	1"	15		60-T15
	1"	20		60-T20
	1"	25		60-T25
	1"	27		60-T27
	1"	30		60-T30
	1"	40		60-T40
	1"	45		60-T45
	1"	50		60-T50
	1"	55		60-T55
	Complete Set (15)			60T-SET
5/16" HEX SHANK INSERT BITS	1-1/4"	30	5/16" HEX	61-T30
	1-1/4"	40		61-T40
	1-1/4"	45		61-T45
	1-1/4"	47		61-T47
	1-1/4"	50		61-T50
	1-1/4"	55		61-T55
	Complete Set (6)			61T-SET



	OVERALL LENGTH	POINT SIZE	BODY DIAMETER	PART NO.
1/4" HEX SHANK POWER BITS	1-15/16"	7	.125	62-T7
	1-15/16"	8	.125	62-T8
	1-15/16"	9	.125	62-T9
	1-15/16"	10	.156	62-T10
	1-15/16"	15	.156	62-T15
	1-15/16"	20	.187	62-T20
	1-15/16"	25	.187	62-T25
	1-15/16"	27	.250	62-T27
	1-15/16"	30	.250	62-T30
	1-15/16"	40	.281	62-T40*
		2-3/4"	8	.125
2-3/4"		9	.138	64-T9
2-3/4"		10	.156	64-T10
2-3/4"		15	.156	64-T15
2-3/4"		20	.187	64-T20
2-3/4"		25	.187	64-T25
2-3/4"		27	.250	64-T27
2-3/4"		30	.250	64-T30
2-3/4"		40	.281	64-T40*
		3-1/2"	8	.125
	3-1/2"	9	.138	66-T9
	3-1/2"	10	.156	66-T10
	3-1/2"	15	.156	66-T15
	3-1/2"	20	.187	66-T20
	3-1/2"	25	.187	66-T25
	3-1/2"	27	.250	66-T27
	3-1/2"	30	.250	66-T30
3-1/2"	40	.281	66-T40*	
	6"	8	.125	68-T8
	6"	9	.138	68-T9
	6"	10	.156	68-T10
	6"	15	.156	68-T15
	6"	20	.187	68-T20
	6"	25	.187	68-T25
	6"	27	.250	68-T27
	6"	30	.250	68-T30
6"	40	.281	68-T40*	

*Denotes full body hex.





STAR Tamper Resistant Insert Bits

STAR Tamper Resistant Insert Bits

	OVERALL LENGTH	SCREW SIZE	PART NO.
1/4" HEX SHANK INSERT BITS			
 Complete Set (10)	1"	7	60-TR7
	1"	8	60-TR8
	1"	9	60-TR9
	1"	10	60-TR10
	1"	15	60-TR15
	1"	20	60-TR20
	1"	25	60-TR25
	1"	27	60-TR27
	1"	30	60-TR30
	1"	40	60-TR40
			60-TR-SET
5/16" HEX SHANK INSERT BITS			
 Complete Set (5)	1-1/4"	30	61-TR30
	1-1/4"	40	61-TR40
	1-1/4"	45	61-TR45
	1-1/4"	50	61-TR50
	1-1/4"	55	61-TR55
			61-TR-SET

Stainless Steel Insert Bits

	POINT SIZE	OVERALL LENGTH	PART NO.
1/4" HEX SHANK PHILLIPS			
 TYPE 440 STAINLESS STEEL Complete Set (3)	1	1"	250PB1SS
	2	1"	250PB2SS
	3	1"	250PB3SS
			250PBSS-SET
1/4" HEX SHANK SQUARE			
 TYPE 440 STAINLESS STEEL Complete Set (4)	1	1"	250R1SS
	2	1"	250R2SS
	3	1"	250R3SS
	4	1"	250R4SS
			250RSS-SET
1/4" HEX SHANK SLOTTED			
 TYPE 440 STAINLESS STEEL Complete Set (4)	2	1"	250SS2SS
	4	1"	250SS4SS
	6	1"	250SS6SS
	8	1"	250SS8SS
			250SS-SET-SS





Square Bit Chart

This brief chart will help you match the screw size to the proper Square point.

POINT #0 – FOR SCREWS #3 & #4
POINT #1 – FOR SCREWS #5 THRU #7
POINT #2 – FOR SCREWS #8 THRU #10
POINT #3 – FOR SCREWS #12 THRU #14 AND 1/4





Square Insert & Power Bits

	OVERALL LENGTH	POINT SIZE	PART NO.
1/4" HEX SHANK INSERT BITS			
 Complete Set (4)	1"	0	250R0
	1"	1	250R1
	1"	2	250R2
	1"	3	250R3
			250R-SET
 TYPE 440 STAINLESS STEEL Complete Set (4)	1"	1	250R1SS
	1"	2	250R2SS
	1"	3	250R3SS
	1"	4	250R4SS
			250RSS-SET
1/4" HEX SHANK POWER BITS*			
 	1-15/16"	0	80-0R
	1-15/16"	1	80-1R
	1-15/16"	2	80-2R
	1-15/16"	3	80-3R
	2-3/4"	1	82-1R
	2-3/4"	2	82-2R
	2-3/4"	3	82-3R
	3"	1	84-1R
	3"	2	84-2R
	3"	3	84-3R
	3-1/2"	1	86-1R
	3-1/2"	2	86-2R
	3-1/2"	3	86-3R
	6"	1	88-1R
	6"	2	88-2R
	6"	3	88-3R

*Turned down body style available upon request. Signify by adding an "S" to part number.







Square 2-Piece Insert & Power Bits

	OVERALL LENGTH	POINT SIZE	PART NO.
1/4" HEX INSERT 2 PIECE SQUARE BITS			
	1"	1	2501R2
	1"	2	2502R2
	1"	3	2503R2
1/4" HEX SHANK POWER BITS 2 PIECE SQUARE			
 	1-15/16"	1	80-1R2
	1-15/16"	2	80-2R2
	1-15/16"	3	80-3R2
	2-3/4"	1	82-1R2
	2-3/4"	2	82-2R2
	2-3/4"	3	82-3R2
	3"	1	84-1R2
	3"	2	84-2R2
	3"	3	84-3R2
	3-1/2"	1	86-1R2
	3-1/2"	2	86-2R2
	3-1/2"	3	86-3R2
	6"	1	88-1R2
	6"	2	88-2R2
	6"	3	88-3R2





Square Recess Bits



	OVERALL LENGTH	POINT SIZE	PART NO.
1/4" HEX SHANK INSERT BITS			
	1"	2	250-2RE
1/4" HEX SHANK POWER BITS			
	1-15/16"	2	80-2RE
	3-1/2"	2	86-2RE
	6"	2	88-2RE

Combo Square – Phillips Insert and Power Bits





	OVERALL LENGTH	POINT SIZE	PART NO.
1/4" HEX SHANK INSERT BIT			
	1"	2	250SP2
1/4" HEX SHANK POWER BITS			
	1-15/16"	2	30-2SP
	3-1/2"	2	34-2SP
	6"	2	36-2SP



Socket Head Hex Insert Bits

Standard

	CAP SCREW SIZE	SET SCREW SIZE	OVERALL LENGTH	HEX SIZE	PART NO.
1/4" HEX SHANK INSERT BITS FOR SOCKET HEAD SCREWS					
	0	3	1"	.050	250H0
	1	5 & 6	1"	1/16	250H1
	2-3	8	1"	5/64	250H2
	4-5	10	1"	3/32	250H3
	6	-	1"	7/64	250H4
	-	1/4	1"	1/8	250H5
	8	-	1"	9/64	250H6
	10	5/16	1"	5/32	250H7
	1/4	3/8	1"	3/16	250H8
	-	7/16	1"	7/32	250H9
	5/16	1/2	1"	1/4	250H10
	3/8	5/8	1"	5/16	250H11
	7/16, 1/2	3/4	1"	3/8	250H12
Complete Set (13)					250H-SET
5/16" HEX SHANK INSERT BITS FOR SOCKET HEAD SCREWS					
	10	5/16	1-1/8"	5/32	72-7
	1/4	3/8	1-1/8"	3/16	72-8
	-	7/16	1-1/8"	7/32	72-9
	5/16	1/2	1-1/8"	1/4	72-10
	3/8	5/8	1-1/8"	5/16	72-11
	7/16, 1/2	3/4	1-1/4"	3/8	72-12
Complete Set (6)					72-SET

Metric

	CAP SCREW SIZE	SET SCREW SIZE	OVERALL LENGTH	HEX SIZE	PART NO.
1/4" HEX SHANK INSERT BITS FOR METRIC SOCKET HEAD SCREWS					
	-	-	1"	2mm	74-2
	-	-	1"	2.5mm	74-2.5
	-	-	1"	3mm	74-3
	-	-	1"	4mm	74-4
	-	-	1"	5mm	74-5
	-	-	1"	6mm	74-6
	-	-	1"	7mm	74-7
	-	-	1"	8mm	74-8
Complete Set (8)					74-SET



Socket Head Hex Power Bits

Standard

	CAP SCREW SIZE	SET SCREW SIZE	OVERALL LENGTH	HEX SIZE	PART NO.
1/4" HEX SHANK POWER BITS					
	1	5 & 6	1-15/16"	1/16"	70-H1
	2-3	8	1-15/16"	5/64"	70-H2
	4-5	10	1-15/16"	3/32"	70-H3
	6	-	1-15/16"	7/64"	70-H4
	-	1/4	1-15/16"	1/8"	70-H5
	8	-	1-15/16"	9/64"	70-H6
	10	5/16	1-15/16"	5/32"	70-H7
	1/4	3/8	1-15/16"	3/16"	70-H8
	-	7/16	1-15/16"	7/32"	70-H9
	5/16	1/2	1-15/16"	1/4"	70-H10

Metric

	CAP SCREW SIZE	SET SCREW SIZE	OVERALL LENGTH	HEX SIZE	PART NO.
1/4" HEX SHANK POWER BITS – METRIC					
	2mm	-	1-15/16"	2mm	71-2
	2.5mm	-	1-15/16"	2.5mm	71-2.5
	3mm	-	1-15/16"	3mm	71-3
	4mm	-	1-15/16"	4mm	71-4
	5mm	-	1-15/16"	5mm	71-5
	6mm	-	1-15/16"	6mm	71-6
	7mm	-	1-15/16"	7mm	71-7
	8mm	-	1-15/16"	8mm	71-8
	12mm	-	1-15/16"	12mm	71-12
	14mm	-	1-15/16"	14mm	71-14

Socket Head Hex Tamper Resistant Insert Bits



	CAP SCREW SIZE	SET SCREW SIZE	OVERALL LENGTH	HEX SIZE	PART NO.
1/4" HEX SHANK INSERT BITS					
	4-5	10	1"	3/32"	73-TR3
	6	-	1"	7/64"	73-TR4
	-	1/4	1"	1/8"	73-TR5
	8	-	1"	9/64"	73-TR6
	0	5/16	1"	5/32"	73-TR7
	1/4	3/8	1"	3/16"	73-TR8
	5/16	7/16	1"	7/32"	73-TR9
	-	1/2	1"	1/4"	73-TR10
	-	-	1"	5/16"	73-TR11
	Complete Set (9)				



Socket Head Hex L Keys



Complete Set (12)

CAP SCREW SIZE	SET SCREW SIZE	HEX SIZE	PART NO.
0	3	.050	LK-H0
1	5 & 6	1/16	LK-H1
2-3	8	5/64	LK-H2
4-5	10	3/32	LK-H3
6	-	7/64	LK-H4
-	1/4	1/8	LK-H5
10	5/16	5/32	LK-H7
1/4	3/8	3/16	LK-H8
-	7/16	7/32	LK-H9
5/16	1/2	1/4	LK-H10
3/8	5/8	5/16	LK-H11
7/16, 1/2	3/4	3/8	LK-H12
			LK-H-SET



Socket Head Hex Tamper Resistant L Keys



Complete Set (10)

CAP SCREW SIZE	SET SCREW SIZE	HEX SIZE	PART NO.
2-3	8	5/64	LK-H2-TR
4-5	10	3/32	LK-H3-TR
6	-	7/64	LK-H4-TR
-	1/4	1/8	LK-H5-TR
10	5/16	5/32	LK-H7-TR
1/4	3/8	3/16	LK-H8-TR
-	7/16	7/32	LK-H9-TR
5/16	1/2	1/4	LK-H10-TR
3/8	5/8	5/16	LK-H11-TR
7/16, 1/2	3/4	3/8	LK-H12-TR
			LK-HTR-SET



STAR Individual L-Keys



Complete Set (14)

POINT SIZE	PART NO.	POINT SIZE	PART NO.
6	69-T6	25	69-T25
7	69-T7	27	69-T27
8	69-T8	30	69-T30
9	69-T9	40	69-T40
10	69-T10	45	69-T45
15	69-T15	50	69-T50
20	69-T20	55	69-T55
			69-T-SET



STAR Tamper Resistant L-Keys



Complete Set (11)

POINT SIZE	PART NO.
6	69-TR6
7	69-TR7
8	69-TR8
9	69-TR9
10	69-TR10
15	69-TR15
20	69-TR20
25	69-TR25
27	69-TR27
30	69-TR30
40	69-TR40
	69-TR-SET



Tri-Wing Insert and Power Bits





Select the right size Bit for the Screw you are driving.

SCREW THREAD SIZE TENSION HEAD	SHEAR HEAD	POINT
0-80	-	0
2-56	4-40	1
4-40	6-32	2
6-32	8-32	3
8-32	10-32	4
10-32	1/4-28	5

Tri-Wing Insert Bits

	OVERALL LENGTH	POINT SIZE	PART NO.
1/4" HEX SHANK INSERT BITS			
  BULL NOSE* Complete Set (8)	1"	0	93-TW0
	1"	1	93-TW1
	1"	2	93-TW2
	1"	3	93-TW3
	1"	4	93-TW4
	1"	5	93-TW5
	1"	6	93-TW6
	1"	6	93-TW6B* 93-TW-SET



Tri-Wing Power Bits

	OVERALL LENGTH	POINT SIZE	PART NO.
1/4" HEX SHANK POWER BITS			
  BULL NOSE* Complete Set (8)	1-1/4"	0	94-TW0
	1-1/4"	1	94-TW1
	1-1/4"	2	94-TW2
	1-1/4"	3	94-TW3
	1-1/4"	4	94-TW4
	1-1/4"	5	94-TW5
	1-1/4"	6	94-TW6
	1-1/4"	6	94-TW6B* 94-TW-SET

Spanner Insert Bits

Used for Security Purposes. The point size of the Bit will be the same as the Screw size.



	OVERALL LENGTH	POINT SIZE	PART NO.
1/4" HEX SHANK SPANNER BITS			
 Complete Set (6)	1"	4	115-4
	1"	6	115-6
	1"	8	115-8
	1"	10	115-10
	1"	12	115-12
	1"	1/4"	115-1/4 115-SET
5/16" HEX SHANK SPANNER BITS			
 Complete Set (6)	1-1/2"	4	116-4
	1-1/2"	6	116-6
	1-1/2"	8	116-8
	1-1/2"	10	116-10
	1-1/2"	12	116-12
	1-1/2"	1/4"	116-1/4 116-SET

1/4" STAR Square Drive Sockets

1/4" STAR Square Drive — use with extensions on page 24.



Complete Set (6)

SIZE	LENGTH	TYPE	BODY DIA.	NOSE DIA.	NON-MAG. PART NO.
E-4	1"	Shoulder	1/2"	1/4"	250E4
E-5	1"	Shoulder	1/2"	9/32"	250E5
E-6	1"	Shoulder	1/2"	5/16"	250E6
E-7	1"	Shoulder	1/2"	23/64"	250E7
E-8	1"	Shoulder	1/2"	25/64"	250E8
E-10	1"	Straight	1/2"	1/2"	250E10 250E-SET

1/4" Square Drive High Torque Sockets/Bits



PART NO.	RECESS	OAL	BODY DIA.	BLADE THICKNESS	BLADE LENGTH
HTS-1	1	1	1/2"	.050	.274
HTS-2	2	1	1/2"	.059	.295
HTS-3	3	1	1/2"	.059	.377
HTS-4	4	1	1/2"	.073	.502

Reversible Sockets and Shanks

	HEX SIZE	OUTSIDE DIAMETER	OVERALL LENGTH	MAGNETIC PART NO.
REVERSIBLE SOCKETS				
	5/16"	1/2"	1"	MRS 5/16
	1/4"	3/8"	1"	MRSR 1/4
	1/4"	7/16"	1"	MRST 1/4
	1/4"	1/2"	1"	MRST 5/16



	OVERALL LENGTH	HEX SIZE	SHANK PART NO.
SHANKS FOR REVERSIBLE SOCKETS			
	2"	1/4"	2SH 1/4-2
	4"	1/4"	2SH 1/4-4



1/4" Hex Drive Shank Extensions

Will fit all 1/4" Square Drive Sockets. All Shank Extensions equipped with Durable Pin Lock except where noted.



PART NO.	MALE SQUARE	LENGTH
SHA 1/4 INSERT TYPE	1/4" W/BALL	1"
250 SH 1/4	1/4"	1-3/8"
250 SH 1/4-B	1/4" W/BALL	1-3/8"
250 SH 1/4-2	1/4"	2"
250 SH 1/4-2B	1/4" W/BALL	2"
250 SH 1/4-3	1/4"	3"
250 SH 1/4-4	1/4"	4"
250 SH 1/4-5	1/4"	5"
250 SH 1/4-6	1/4"	6"
250 SH 1/4-8	1/4"	8"
250 SH 1/4-10	1/4"	10"
250 SH 1/4-12	1/4"	12"
250 SH 1/2-2B	1/2" W/BALL	2"

1/4" and 7/16" Hex Drive Shank Extensions

Will fit all 3/8" Square Drive Sockets. All Shank Extensions equipped with Durable Pin Lock.



1/4" HEX DRIVE FOR 3/8" SQUARE DRIVE SOCKETS

PART NO.	LENGTH
250 SH 3/8	1-5/8"
250 SH 3/8-2	2"
250 SH 3/8-2B	2" W/BALL
250 SH 3/8-3	3"
250 SH 3/8-4	4"
250 SH 3/8-6	6"
250 SH 3/8-8	8"



7/16" HEX DRIVE FOR 3/8" SQUARE DRIVE SOCKETS

PART NO.	LENGTH
437 SH 3/8-2	2"
437 SH 3/8-3	3"
437 SH 3/8-4	4"
437 SH 3/8-5	5"
437 SH 3/8-6	6"

7/16" Hex Drive Shank Extensions

Will fit all 1/2" Square Drive Sockets. All Shank Extensions equipped with Durable Pin Lock.



PART NO.	LENGTH
437 SH 1/2	2-1/8"
437 SH 1/2-3	3"
437 SH 1/2-4	4"

1/4" Square Drive Sockets

Magnetic and Non-Magnetic For driving Hex Head Sheet Metal and Self Drilling Fasteners



TAPERED STYLE — T



STRAIGHT STYLE — S

STYLE	HEXSIZE	LENGTH	NOSE DIA.	BODY DIA.	NON-MAG. PART NO.	MAGNETIC PART NO.
T	3/16"	7/8"	5/16"	1/2"	250 ST 3/16	250 MST 3/16
T	1/4"	7/8"	3/8"	1/2"	250 ST 1/4	250 MST 1/4
S	1/4"	7/8"	7/16"	7/16"	250 SW 1/4	250 MSW 1/4†
S	1/4"	7/8"	1/2"	1/2"	250 S 1/4	250 MS 1/4
T	5/16"	7/8"	7/16"	1/2"	250 ST 5/16	250 MST 5/16
S	5/16"	7/8"	1/2"	1/2"	250 S 5/16	250 MS 5/16
S	3/8"	1"	9/16"	9/16"	250 S 3/8	250 MS 3/8
S	7/16"	1"	5/8"	5/8"	250 S 7/16	250 MS 7/16
S	1/2"	1"	3/4"	3/4"	250 S 1/2	250 MS 1/2
S	9/16"	1-1/2"	15/16"	15/16"	250 S 9/16	250 MS 9/16

†Thin Wall

3/8" Square Drive Sockets

Magnetic and Non-Magnetic For driving Hex Head Sheet Metal and Self Drilling Fasteners



TAPERED STYLE — T



STRAIGHT STYLE — S

STYLE	HEX SIZE	LENGTH	NOSE DIA.	BODY DIA.	NON-MAG. PART NO.	MAGNETIC PART NO.
T	1/4"	1-1/4"	3/8"	3/4"	375 ST 1/4	375 MST 1/4
T	5/16"	1-1/4"	1/2"	3/4"	375 ST 5/16	375 MST 5/16
T	3/8"	1-1/4"	5/8"	3/4"	375 ST 3/8	375 MST 3/8
S	7/16"	1-1/4"	3/4"	3/4"	375 S 7/16	375 MS 7/16
S	1/2"	1-1/4"	3/4"	3/4"	375 S 1/2	375 MS 1/2
S	9/16"	1-1/4"	15/16"	15/16"	375 S 9/16	375 MS 9/16

1/2" Square Drive Sockets

Magnetic and Non-Magnetic For driving Hex Head Sheet Metal and Self Drilling Fasteners



TAPERED STYLE — T

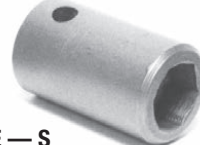

STRAIGHT STYLE — S

STYLE	HEX SIZE	LENGTH	NOSE DIA.	BODY DIA.	NON-MAG. PART NO.	MAGNETIC PART NO.
T	1/4"	1-1/2"	7/16"	15/16"	500 ST 1/4	500 MST 1/4
T	5/16"	1-1/2"	1/2"	15/16"	500 ST 5/16	500 MST 5/16
T	3/8"	1-1/2"	5/8"	15/16"	500 ST 3/8	500 MST 3/8
T	7/16"	1-1/2"	11/16"	15/16"	500 ST 7/16	500 MST 7/16
T	1/2"	1-1/2"	3/4"	15/16"	500 ST 1/2	500 MST 1/2
S	9/16"	1-1/2"	15/16"	15/16"	500 S 9/16	500 MS 9/16

1/4", 3/8" & 1/2" Square Drive Metric Sockets

Magnetic and Non-Magnetic

1/4" Square Drive — use with Extensions on page 28.



T



S

METRIC SIZE mm	TYPE	OVERALL LENGTH mm	NOSE END	BODY DIA.	PART NO. NON-MAG.	PART NO. MAGNETIC
4	T	22.2	7.2	12.7	824-4	M824-4
4.5	T	22.2	7.9	12.7	824-4.5	M824-4.5
5	T	22.2	8.7	12.7	824-5	M824-5
5.5	T	22.2	9.1	12.7	824-5.5	M824-5.5
6	T	22.2	9.1	12.7	824-6	M824-6
7	T	22.2	10.2	12.7	824-7	M824-7
7	S	22.2	12.7	12.7	820-7	M820-7
8	S	22.2	12.7	12.7	820-8	M820-8
9	S	25.4	14.3	14.3	820-9	M820-9
10	S	25.4	15.9	15.9	820-10	M820-10

3/8" Square Drive — use with extensions on page 23.



T



S

METRIC SIZE mm	TYPE	OVERALL LENGTH mm	NOSE END	BODY DIA.	PART NO. NON-MAG.	PART NO. MAGNETIC
8	T	31.7	11.9	15.9	845-8	M845-8
10	T	31.7	14.3	19.1	845-10	M845-10
11	T	31.7	17.5	19.1	845-11	M845-11
12	S	31.7	19.1	19.1	840-12	M840-12
13	S	31.7	19.1	19.1	840-13	M840-13

1/2" Square Drive — use with extensions on page 23.







S

METRIC SIZE mm	TYPE	OVERALL LENGTH mm	NOSE END	BODY DIA.	PART NO. NON-MAG.	PART NO. MAGNETIC
13	S	38.1	22.2	23.7	867-13	M867-13

Other metric sizes available by special order.

Double End Insert & Power Bits

	OVERALL LENGTH	POINT SIZE	PART NO.
1/4" HEX SHANK PHILLIPS – SLOTTED BITS			
	1-1/2"	1-6	19-PS2
(Use with No. 717 hand screwdriver)	1-1/2"	2-4	19-PS3
	1-1/2"	3-10	19-PS4
1/4" HEX SHANK – SQUARE BITS			
	1-1/2"	1-2	19-SR2
(Use with No. 717 hand screwdriver)			
1/4" HEX SHANK – STAR BITS			
	1-1/2"	15-20	19-TS2
(Use with No. 717 hand screwdriver)	1-1/2"	25-30	19-TS3
1/4" HEX SHANK – PHILLIPS BITS			
	1-1/2"	1-2	29-2DP
(Use with No. 717 hand screwdriver)			
	1-3/4"	2-2	30-2DP
(DO NOT use with No. 717 hand screwdriver)	2-1/2"	2-2	31-2DP

Bit Holder for Double Ended Bits

1/4" Hex Drive — Non-Magnetic



OVERALL LENGTH	PART NO.
2-1/4"	BHDE 1/4

Storage Handle Driver, Double End Bit Set

1/4" Hex Drive — Non-Magnetic

OVERALL LENGTH	PART NO. W/BITS	PART NO. W/O BITS
8"	717	726

(Bits included: Phillips 1, 2, 3; Slotted 4-6, 6-8, 8-10)

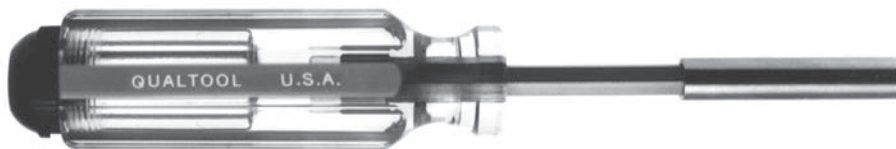

Non-Magnetic Hand Drivers

4 in 1 Quick Change Screwdrivers

Part No. 700

6 in 1 Quick Change Screwdrivers

Part No. 700-6



PART NO.	Each of the below contain 2 Double End Bits:
700	#1 & #2 PHILLIPS and 3/16 & 5/16 SLOTTED
700-6	#1 & #2 PHILLIPS and 3/16 & 5/16 SLOTTED plus 5/16 and 1/4 NUTSETTER

HEX	PART NO.	REPLACEMENT DOUBLE ENDED BITS
5/16	700 A	PHILLIPS #1 & #2
5/16	700 B	SLOTTED 3/16 & 5/16
5/16	702 A	#1 & #2 SQUARE
1/4*	700-C	PHILLIPS #1 & #2

4 in 1 or 6 in 1 Quick Change Screwdriver Displays

Attractive heavy duty cardboard display is FREE with purchase of 12 screwdrivers.

QUANTITY	DESCRIPTION	PART NO.
12	4 IN 1	690
24	4 IN 1	708
12	6 IN 1	690-6
24	6 IN 1	708-6



Order 24 screwdrivers of the same part number and your name will be imprinted free.

Non-Magnetic Hand Drivers

Slotted Hand Drivers

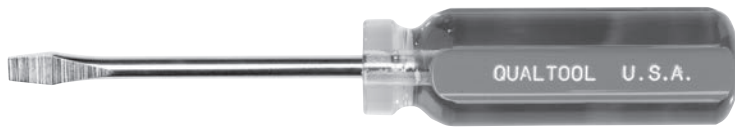

PART NO.	BLADE SIZE	OVERALL LENGTH
770	4"	8"
771	6"	9-1/2"
773	8"	12-3/4"
774	10"	14"

Phillips Hand Drivers



PART NO.	POINT SIZE	BLADE SIZE	OVERALL LENGTH
761	1	3"	6-1/4"
761S	1	1-1/8"	4"
762	2	4"	6-1/4"
763	3	6"	10-1/4"

Square Recess Hand Drivers



PART NO.	POINT SIZE	BLADE SIZE	OVERALL LENGTH
79-1R	1	4"	7-5/8"
79-2R	2	4"	7-5/8"

Magnetic Hand Drivers



	OVERALL LENGTH	SLEEVE TYPE	HANDLE TYPE	PART NO. W/O BITS	PART NO. W/BITS
FOR 1/4" HEX INSERT BITS					
Bits included are #1 & #2 Phillips and #4 & #6 Slotted	7-1/2"	STAINLESS	STORAGE	710	711
	7-1/2"	STAINLESS	SOLID	712	-
	12"	STAINLESS	SOLID	730	-
	12"	STAINLESS	STORAGE	731	732
FOR 5/16" HEX INSERT BITS					
Bits included are #3 Phillips and #10 Slotted	8"	STAINLESS	SOLID	718	-
	8"	STAINLESS	STORAGE	719	721

Magnetic Ratcheting Hand Driver





	OVERALL LENGTH	SLEEVE TYPE	HANDLE TYPE	PART NO. W/BITS
FOR 1/4" HEX INSERT BITS				
Bits included are #1 & #2 Phillips, #1 & #2 Square, and #4 & #6 Slotted	8"	CRV	STORAGE w/CUSHION GRIP	710 RAT

Order 24 Screwdrivers of the SAME PART NUMBER and QUALTOOL will imprint the handle with your name at no additional cost. 21 letters and spaces maximum. Not available on 710 Rat.

STAR Hand Drivers



TAMPER RESISTANT PART NO. 	STANDARD PART NO. 	POINT SIZE	HANDLE SIZE	OVERALL LENGTH
720-TR7	720-T7	7	3/4" X 2-5/8"	5-7/8"
720-TR8	720-T8	8	3/4" X 2-5/8"	5-7/8"
720-TR9	720-T9	9	3/4" X 2-5/8"	5-7/8"
720-TR10	720-T10	10	3/4" X 2-5/8"	5-7/8"
720-TR15	720-T15	15	1" X 3-1/2"	6-7/8"
720-TR20	720-T20	20	1" X 3-1/2"	6-7/8"
720-TR25	720-T25	25	1-1/8" X 4"	7-3/4"
720-TR27	720-T27	27	1-1/8" X 4"	8"
720-TR30	720-T30	30	1-1/8" X 4"	8-1/2"
720-TR40	720-T40	40	1-1/8" X 4"	8-1/2"

Qualtool "HAMMER HEAD" Drivers

Stainless steel strike head makes quick work of rusted or over tightened screws. Available in Phillips or slotted styles. Heat-treated shank suitable for prying or moving heavy objects. Finally a screwdriver that you can "Wack."

PART NO.	BLADE SIZE	OVERALL LENGTH
770HH	1/4"	8"
771HH	1/4"	9-1/2"
772HH	5/16"	9-1/2"
773HH	3/8"	10-1/2"
774HH	3/8"	12"
775HH	3/8"	14"

Slotted Hand Drivers

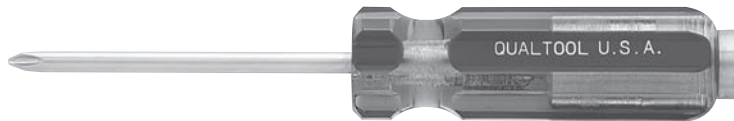

Phillips Hand Drivers



PART NO.	POINT SIZE	OVERALL LENGTH
762HH	2	8"
763HH	3	10"

Hanging "Tom Dooley" Pak

"Tom Dooley's Daddy" available for all 2 3/4" and 3 1/2" long power bits.



Special contractor size
"Tom Dooley"
hanging pak
of (20) 1" insert bits
or (10) 1-15/16"
power bits.
Available in all of our
most popular sizes.

PART NO.	DESCRIPTION	BITS/PAK
Insert Bits		
TD- 250-PB1	#1 Phillips Insert Bit	20
TD- 250-PB2	#2 Phillips Insert Bit	20
TD- 250-PB3	#3 Phillips Insert Bit	20
TD- 250-PBR2	#2 Reduced Phillips Insert Bit	20
TD- 250-R1	#1 Square Insert Bit	20
TD- 250-R2	#2 Square Insert Bit	20
TD- 250-R3	#3 Square Insert Bit	20
TD- 250-SS4	#4 Slotted Insert Bit	20
TD- 250-SS6	#6 Slotted Insert Bit	20
TD- 250-SS8	#8 Slotted Insert Bit	20
TD- 60-T30	#30 Star Insert Bit	20
TD- 60-T40	#40 Star Insert Bit	20
Power Bits		
TD- 30-1P	#1 Phillips Power Bit	10
TD- 30-2P	#2 Phillips Power Bit	10
TD- 30-3P	#3 Phillips Power Bit	10
TD- 20-8S	#8 Slotted Power Bit	10
TD- 80-2R	#2 Square Power Bit	10

• Other size bits are available upon request. 1" insert bits are packed 20 per pak and 1-15/16" power bits are packed 10 per pak.

Bit Kits and Nutsetter Kits

The Nutsetter Kits



3 Piece Magnetic Nutsetter Set
Part No. 2020

Set Includes the following sizes:
1/4", 5/16", 3/8"

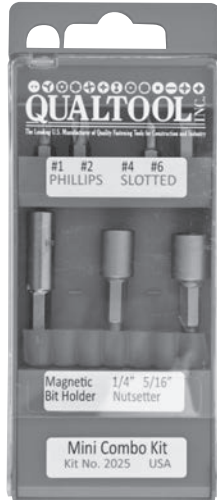

Mini Combo Kit
Part No. 2025

Set Includes:
Magnetic Bit Holder
Magnetic Nutsetters 1/4" & 5/16"
Phillips Bits #1 & #2
Slotted Bits #4 & #6

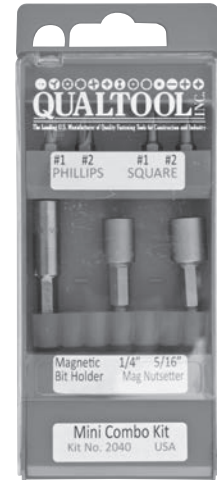

7 Piece Mini-Combo Kit
Part No. 2040

Set Includes:
Magnetic Bit Holder
Magnetic Nutsetters 1/4" & 5/16"
Phillips Bits #1 & #2
Square Bits #1 & #2

Pocket Bit Kit

Pocket Sized 10 Piece Set with Magnetic Bit Holder in a Hard Plastic Case
Part No. 2001

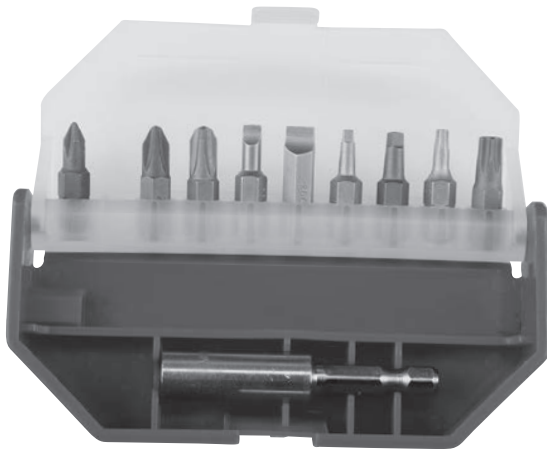

POCKET BIT KIT INCLUDES:
MAGNETIC BIT HOLDER, NO. 1, 2, & 3 PHILLIPS BITS,
NO. 4 & 6 SLOTTED BITS, NO. 1 & 2 SQUARE BITS
NO. 15 & 30 STAR BITS

7 Piece Non-Magnetic Nutsetter Set

Part No. 2010
Set Includes the following sizes:
3/16", 1/4", 9/32", 5/16"
11/32", 3/8", 7/16"



Dial-a-Bit Kit
Many assortments available upon request, please call for availability.



case no. 2200-red

SPECIALTY KITS CAN BE MADE TO YOUR REQUIREMENTS

Bit Kits

Masonry "Drill & Drive" Tool Kit

For installation of concrete screws

Kit No. 625



REPLACEMENT PART NO.	DESCRIPTION
626	DRIVE TUBE
627	1/4" DRIVE NUTSETTER
628	5/16" DRIVE NUTSETTER
629	HOLDER FOR PHILLIPS BITS
630	DRILL HOLDER
631	L-HEX KEY
632	HEAVY DUTY PLASTIC CASE
250PB2	#2 PHILLIPS BIT
250PB3	#3 PHILLIPS BIT

The Bit Kit

31 Piece Set in Heavy Duty Plastic Case.

Part No. 2000



DESCRIPTION	OVERALL LENGTH	BIT SIZE
Phillips Bits	1"	1, 2, 3
Slotted Bits	1"	4, 5, 6, 8, 10
Hex Socket Bits	1"	2, 3, 4, 5, 6, 7, 8
Square Bits	1"	1, 2, 3
Star Bits	1"	T10, T15, T20 T25, T30, T40
Pozidriv® Bits	1"	1, 2
Clutch Bits	1"	2, 3
Socket Adapter	1"	for 1/4" Square Drive Sockets
Magnetic Bit Holder	1-3/4"	for 1/4" Hex Insert Bits
Magnetic Hand Driver	7-1/2"	with Solid Handle

The Security Bit Kit

31 Piece Set in Heavy Duty Plastic Case.

Part No. 2100



DESCRIPTION	OVERALL LENGTH	BIT SIZE
Star Bits 60-TR Series	1"	TR7, TR8, TR9, TR10, TR15, TR20, TR25, TR27, TR30, TR40
Socket Head Bits 73-TR Series	1"	TR3/32, TR7/64, TR1/8, TR9/64, TR5/32, TR3/16, TR7/32, TR1/4
Spanner Bits 115 Series	1"	4, 6, 8, 10
Phillips Security Bits 250PB-TR	1"	2, 3
Square Bits 250R1, R2	1"	1, 2
Phillips Bit 250PB	1"	1
Slotted Bit 250SS8	1"	8
Socket Adapter	1"	for 1/4" Square Drive Sockets
Magnetic Bit Holder	1-3/4"	for 1/4" Hex Shank Insert Bits
Magnetic Hand Driver	7-1/2"	with Solid Handle

Order 24 Kits and Qualtool will imprint the handle with your name at no additional cost.

Qualtool Fishbowl Displays



Nutsetters

PART NO.	PIECES/FB
FB-MSHL 5/16	75 PCS.
FB-MSHL 1/4	75 PCS.
FB-MSHL 3/8	50 PCS.
FB-MSH 1/4	100 PCS.
FB-MSH 5/16	100 PCS.

Bit Holders

PART NO.	PIECES/FB
FB-MBH 1/4	50 PCS.
FB-MBHM 1/4	50 PCS.
FB-MBHR 1/4	50 PCS.
FB-MBHT 1/4	50 PCS.

Bits

PART NO.	PIECES/FB
FB-250PB2	500 PCS.
FB-250PB3	500 PCS.
FB-250PBR2	500 PCS.
FB-250R1	500 PCS.
FB-250R2	500 PCS.
FB-30-2P	250 PCS.

Fishbowl Display only — Part No. FB-2

Other FB nutsetters, bit holders and bits are available upon request.

Qualtool Contractor Kits

- Heavy duty case keeps parts organized for quick use.
- Case is 2" x 9" x 13" with up to 16 compartments.
- Each assortment contains our most popular parts.
- Custom assortments available upon request, call for quote

Part No. 2062, Contractor Kit consisting of 175 pieces

Part No. 2061, Mini Contractor Kit Consisting of 88 pieces

Part No. 2060, Bit Kit Consisting of 101 pieces



	PART NO.				PART NO.		
	2060	2061	2062		2060	2061	2062
MSH 1/4		5	10	250SS4	8		
MSHL 1/4		5	10	250SS6	8		
MSH 5/16		5	10	250SS8	8		
MSHL 5/16		5	10	250SS10	8		
MSH 3/8		5	10	250R1	8		
MSHL 3/8		5	10	250R2	8		
MBH 1/4	1			250R3	8		
MBHT 1/4		1	2	250H3	8		
MBH 1/4QC		1	2	250H10	8		
905		1	1	250PB2TR	2		
250PB-1	8	10	20	250PB3TR	2		
250PB-2	8	25	50	30-2P		10	20
250PB-3	8	10	20				

Qualtool Counter Merchandisers

- High Quality Steel Construction.
- Clear acrylic lid allows customers to see all parts without handling.
- Key Locking Lid.
- Includes Display & Standard Screwdriver Assortment.
- Display Dimensions:
Height (without header) – 8”
Depth – 15-3/4”
Width – 12-1/2”



Part No. 2048 – Metal Display Only

**Part No. 2050 – Contractor Assortment
Consisting of 1030 Pieces**

**Part No. 2052 – Lumber Yard Assortment
Consisting of 915 Pieces**

**Part No. 2053 – Electrical Assortment
Consisting of 805 Pieces**

	PART NO.				PART NO.		
	2050	2052	2053		2050	2052	2053
250PB0		20	30	250R0		30	
250PB1	50	50	50	250R1	50	50	50
250PB2	150	100	100	250R2	50	65	70
250PB3	50	75	50	80-2R	25	75	75
250PBR2	75	100	50	80-3R	25		
30-1P	50	20	20	60-T15	40		
30-2P	50	50	50	60-T30	40		
30-3P	50	20	20	19PS3		30	
32-2P	25	20		MBH1/4		10	10
34-2P	30			MBHR1/4	20	5	5
36-2P		20	30	MSH1/4	20	10	10
250SS1		25	25	MSH5/16	20	10	10
250SS4	50	25	25	MSH3/8	10	10	10
250SS6	50			MSH7/16		10	10
250SS8	50	25	25	MSHL1/4	20		5
20-4S		30	30	MSHL5/16	20		5
20-7S		30	30	MSHL3/8	10		5
				MSHL7/16			5
TOTAL PTS	680	610	535		350	305	270

Qualtool Pegboard / Counter Merchandiser

- 15 Styles of our most popular bits.
- Packaged in re-usable zip-lock bags.
- 5 parts per bag equals increased sales.
- Made to sit on counter or hang from pegboard.

Part No. 2060HR consisting of 755 bits as follows:



PART NO.	DESCRIPTION	QUANTITY	PART NO.	DESCRIPTION	QUANTITY
250SS4PK	#4 SLOTTED INSERT (5/BAG)	50	250PB1PK	#1 PHILLIPS INSERT (5/BAG)	50
250SS6PK	#6 SLOTTED INSERT (5/BAG)	50	250PB2PK	#2 PHILLIPS INSERT (5/BAG)	50
250SS8PK	#8 SLOTTED INSERT (5/BAG)	50	250PB3PK	#3 PHILLIPS INSERT (5/BAG)	50
30-1PPK	#1 PHILLIPS POWER BIT 2" (5/BAG)	50	250PBR2PK	#2 PHILLIPS REDUCED (5/BAG)	50
30-2PPK	#2 PHILLIPS POWER BIT 2" (5/BAG)	50	80-2RPK	#2 SQUARE POWER BIT 2" (5/BAG)	50
30-3PPK	#3 PHILLIPS POWER BIT 2" (5/BAG)	50	80-3RPK	#3 SQUARE POWER BIT 2" (5/BAG)	50
32-2PPK	#2 PHILLIPS POWER BIT 2-3/4" (5/BAG)	50	250R1PK	#1 SQUARE INSERT (5/BAG)	50
MBHR 1/4PK	MAGNETIC BIT HOLDER (1/BAG)	5	250R2PK	#2 SQUARE INSERT (5/BAG)	50

Concrete Lead Anchor Drive Tool

Features:

- Cushioned Handles.
- One Hand Operation.
- Sets Anchors perfectly every time.
- Available in the most popular sizes.

Part No. AD1/4 for 1/4" Anchors

Part No AD3/8 for 3/8" Anchors

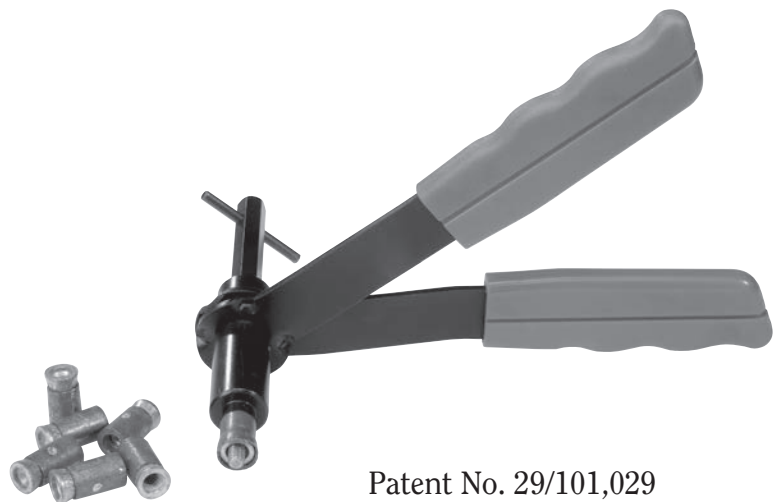

Patent No. 29/101,029

Drill Adaptor

Convert your 3/8" speed control drill to a 1/4" "Quick Change" power screwgun. This will also allow "Quick Change" of 1/4" hex power bits in single speed drills.

Part No. 905

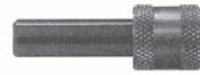

Locator - Driver - Bit Holder

1/4" Hex Shank, 4 3/4" OAL.

Magnetic driver keeps screws straight while driving.

Part No. LBH 1/4



Acoustical Eye Lag Driver

1/4" Hex drive for quick installation of eye lag hanger bolts.

Part No. 1900



Lag Stud Driver

1/4" Hex drive for 3/8" threaded rod.

Part No. LSD 3/8

Also available for 1/4" threaded rod.

Part No. LSD 1/4

Also available for 5/16" threaded rod.

Part No. LSD 5/16



Power and Hand Wing Nut Driver

New patented design which tightens wing nuts for shutter installation.

Part No. W001 – Power Driver

Part No. W002 – Hand Driver, 7" OAL

Part No. W003 – Hand Driver, 6" OAL



Patent No 379,420

INDUSTRIAL

BY **QUALTOOL** INC.
The Leading U.S. Manufacturer of Quality Fastening Tools for Construction and Industry

TRIPLE SQUARE INSERT BITS



Part Number	Hex Size	Point Size	Overall Length
312-6X-28MM-RIL	5/16	6MM	28MM
312-8X-28MM-RIL	5/16	8MM	28MM
312-8X-52MM-RIL	5/16	8MM	52MM
312-10X-35MM-RIL	5/16	10MM	35MM
312-10X-70MM-RIL	5/16	10MM	70MM
312-10X-90MM-RIL	5/16	10MM	90MM
312-12X-35MM-RIL	5/16	12MM	35MM
312-14X-35MM-RIL	5/16	14MM	35MM
250-5X-28MM-RIL	1/4	5MM	28MM

HEX (SOCKET HEAD) POWER BITS

1/4" HEX SHANK



Part Number	Hex Size	Overall Length
70-H5-4	1/8	4"
70-H7-4	5/32	4"
71-1.5	1.5MM	4"
71-2	2MM	4"
71-2.5	2.5MM	4"
71-3	3MM	4"
71-4	4MM	4"
71-5	5MM	4"
71-6	6MM	4"
74-8HA	8MM	1-1/8"

PHILLIPS POWER BITS

1/4" HEX SHANK



Part Number	Point Size	Overall Length	Point Features
34-2P-CRX	2	3-1/2"	ACR Ribs

STAR (TORX®) INSERT BITS

1/4" HEX SHANK



Part Number	Point Size	Description	Overall Length
60-TP201X	201P	Torx Plus	1"

HEAVY DUTY FASTENING TOOLS

INDUSTRIAL

BY **QUALTOOL** INC.
The Leading U.S. Manufacturer of Quality Fastening Tools for Construction and Industry

STAR (TORX®) POWER BITS 1/4" HEX SHANK



Part Number	Point Size	Overall Length
62-T45	45	1-15/16"

STAR (TORX®) POWER BITS W/ FINDER



Part Number	Point Size	Overall Length
66-T20-BF	T20	3-1/2"
66-T25-BF	T25	3-1/2"

LARGE STAR (TORX®) INSERT BITS 5/8" HEX SHANK



Part Number	Point Size	Overall Length	Feature
625TX70-3	T70	3"	Through Hole

SPECIALTY PARTS

UNIVERSAL ADAPTORS

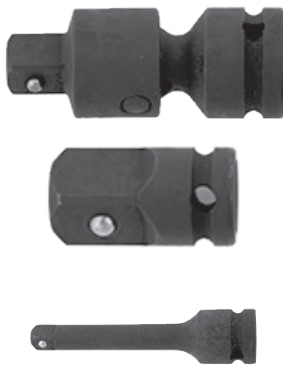

Part Number	Male Square	Female Square	Lock	Overall Length
MF-50H	1/2"	1/2"	Pin	3"
751-ADP	3/4"	1/2"	Ball	1-7/8"
500SQADPT	3/8"	1/2"	Ball	1-7/8"

HEAVY DUTY FASTENING TOOLS

SPECIALTY PARTS CONT.



SOCKETS

Part Number	Male Drive	Hex Socket	Overall Length
500ST-937S	1/2"	1/2"	1-3/4"



HAND DRIVER

Part Number	Hex Size	Overall Length
NS 1/4-IVF	1/4"	6"



L-KEYS

Part Number	Torx ® Number	Overall Length
69-T20-IVF	T20	4"
69-T25-IVF	T25	4"



3/8" FEMALE SQUARE DRIVE BIT HOLDERS

Part Number	Hex Insert Bit Size	Overall Length
375BH 5/16-RIL	5/16"	1-3/16"
375BH 437	7/16"	1-3/8"

INDUSTRIAL

BY **QUALTOOL** INC.
The Leading U.S. Manufacturer of Quality Fastening Tools for Construction and Industry

SPECIALTY PARTS CONT.

FEMALE SQUARE DRIVE QUICK CHANGE BIT HOLDER



Part Number	Square Size	Bit Size	Overall Length
QR-250BH 1/4	1/4"	7/16"	2"
QR-437BH 3/8	3/8"	7/16"	2"
QB-MBH 1/2-H	1/2"	7/16"	2-1/8"
QR-BH308-H	3/8"	1/4"	1-3/4"

HEX DRIVE EXTENSIONS



Part Number	Drive Size	Male Square	Overall Length
250SH 3/8-B4-H	1/4"	7/16"	4" W/BALL
250SH 3/8-12	1/4"	7/16"	12"
250SH 3/8-18-H	3/8"	7/16"	18"
375SH 1/2-H	3/8"	1/2"	1-1/2"

FEMALE SQUARE DRIVE EXTENSIONS



Part Number	Drive Size	Female Square	Overall Length
500SH 1/2-2-H	1/2"	1/2"	2"
500SH 1/2-6B-H	1/2"	1/2"	6" W/BALL
500SH 1/2-8	1/2"	1/2"	8"
500SH 1/2-10-H	1/2"	1/2"	10"
SH 1/4-3/8-6-H	1/4"	3/8"	6"
SH 1/4-4B-H	1/4"	1/4"	4" W/BALL
SH 1/4-10-H	1/4"	1/4"	10"

HEAVY DUTY FASTENING TOOLS

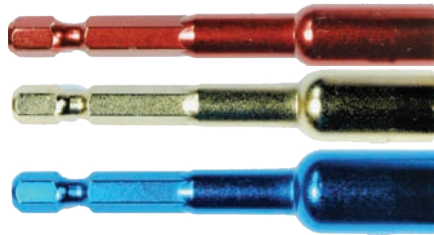

1/4" HEX DRIVE POWER MAGNETIC NUTSETTERS

Hex Size	Overall Length	Color	Part Number
1/4"	2-9/16"	Red	TBMSHL 1/4
5/16"	2-9/16"	Gold	TBMSHL 5/16
3/8"	2-9/16"	Blue	TBMSHL 3/8

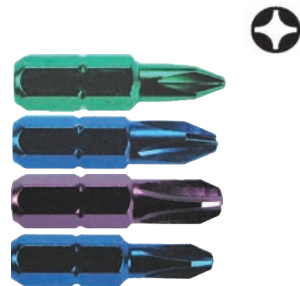

PHILLIPS INSERT BITS—1/4" HEX

Point Size	Overall Length	Color	Part Number
1	1"	Green	TB250PB1
2	1"	Blue	TB250PB2
3	1"	Purple	TB250PB3
2-Reduced	1"	Blue	TB250PBR2

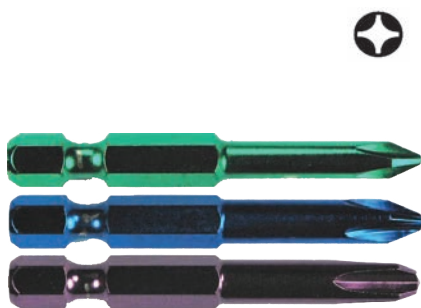

PHILLIPS POWER BITS—1/4" HEX

Point Size	Overall Length	Color	Part Number
1	1-15/16"	Green	TB30-1P
2	1-15/16"	Blue	TB30-2P
3	1-15/16"	Purple	TB30-3P
2	3-1/2"	Blue	TB34-2P
3	3-1/2"	Purple	TB34-3P
2	6"	Blue	TB36-2P
3	6"	Purple	TB36-3P

Sets
(PART NUMBER)

Fishbowls
(PART NUMBER + FB)

Hanging Paks
(PART NUMBER + PK)

3 Ways
to Order:





SQUARE 2-PIECE INSERT BITS — 1/4" HEX

Point Size	Overall Length	Color	Part Number
1	1"	Green	TB250-1R2
2	1"	Red	TB250-2R2
3	1"	Black	TB250-3R2



SQUARE 2-PIECE POWER BITS — 1/4" HEX

Point Size	Overall Length	Color	Part Number
1	1-15/16"	Green	TB80-1R2
2	1-15/16"	Red	TB80-2R2
3	1-15/16"	Black	TB80-3R2
1	3-1/2"	Green	TB86-1R2
2	3-1/2"	Red	TB86-2R2
3	3-1/2"	Black	TB86-3R2
2	6"	Red	TB88-2R2
3	6"	Black	TB88-3R2

QUALTOOL Quality,
Service and Quick
Delivery

Brilliant Color Finish
Packed in Convenient
Sets

Fastener Friendly
Balanced Hardness for
Durability



Part Number—TB5501

SET QTY	PART NO.	DESCRIPTION
5	TB 80-1R	#1 Square, 1-15/16" L
5	TB 80-2R	#2 Square, 1-15/16" L
5	TB 80-3R	#3 Square, 1-15/16" L
5	TB 86-1R	#1 Square, 3-1/2" L
5	TB 86-2R	#2 Square, 3-1/2" L
5	TB 86-3R	#3 Square, 3-1/2" L
5	TB 88-2R	#2 Square, 6" L
5	TB 88-3R	#3 Square, 6" L
5	TB 250-1R2	#1 Square, 1" L
5	TB 250-2R2	#2 Square, 1" L
5	TB 250-3R2	#3 Square, 1" L



Part Number—TB5502

SET QTY	PART NO.	DESCRIPTION
5	TB 30-1P	#1 Phillips, 1-15/16" L
5	TB 30-2P	#2 Phillips, 1-15/16" L
5	TB 30-3P	#3 Phillips, 1-15/16" L
5	TB 34-2P	#2 Phillips, 3-1/2" L
5	TB 34-3P	#3 Phillips, 3-1/2" L
5	TB 36-2P	#2 Phillips, 6" L
5	TB 36-3P	#3 Phillips, 6" L
5	TB 250PB1	#1 Phillips, 1" L
5	TB 250PB2	#2 Phillips, 1" L
5	TB 250PBR2	#2 Phillips Reduced, 1" L
5	TB 250PB3	#3 Phillips, 1" L
5	TB MSHL 1/4	1/4" Hex Shank Magnetic Nutsetter, 2-9/16" L
5	TB MSHL 5/16	1/4" Hex Shank Magnetic Nutsetter, 2-9/16" L
5	TB MSHL 3/8	1/4" Hex Shank Magnetic Nutsetter, 2-9/16" L

Cast Alnico® Magnets and Specialty Magnets

Cast Alnico® Magnets

We can supply a full range of circular magnets from 1/8" to 1/2" diameter.

Call for prices for your specifications.

Neodymium magnets also are available from 1/8" to 1/2" diameter.

Round Cast Alnico Bars

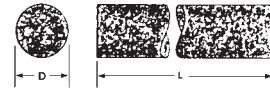

Industrial Grade Holding Magnets

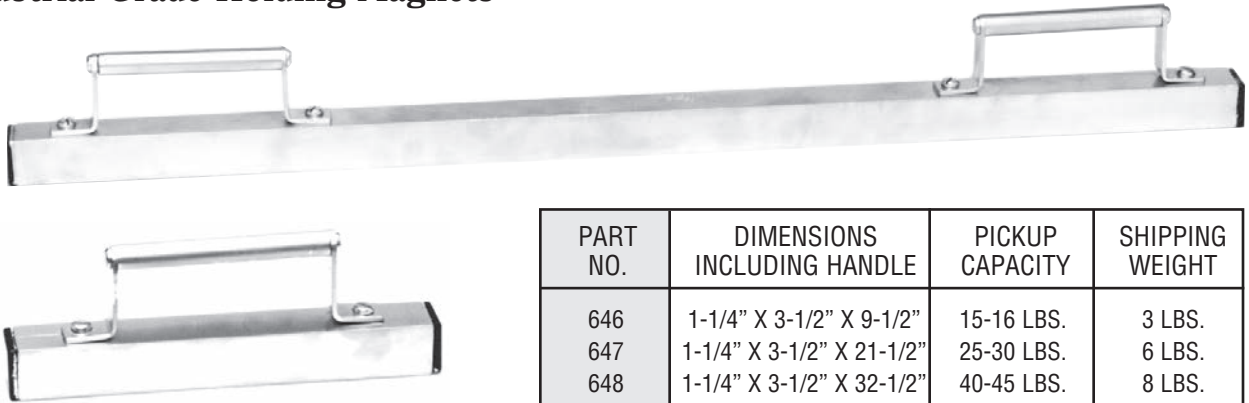

PART NO.	DIMENSIONS INCLUDING HANDLE	PICKUP CAPACITY	SHIPPING WEIGHT
646	1-1/4" X 3-1/2" X 9-1/2"	15-16 LBS.	3 LBS.
647	1-1/4" X 3-1/2" X 21-1/2"	25-30 LBS.	6 LBS.
648	1-1/4" X 3-1/2" X 32-1/2"	40-45 LBS.	8 LBS.

Key Chain Magnet

3/8" diameter · 2-1/4" long

Part No. 614



Pocket Pick-Up Magnet

5" length with pocket clip.

Part No. 615



Magnetic Rack

18" length for heavy duty holding power.

Part No. 616



Please call for quotes on custom magnets

Magnetic Sweepers and Pickup Tools

Magnetic Sweeper w/o Quick Release

Part No. 600
Part No. 601



Magnetic Sweeper w/Quick Release

Part No. 618

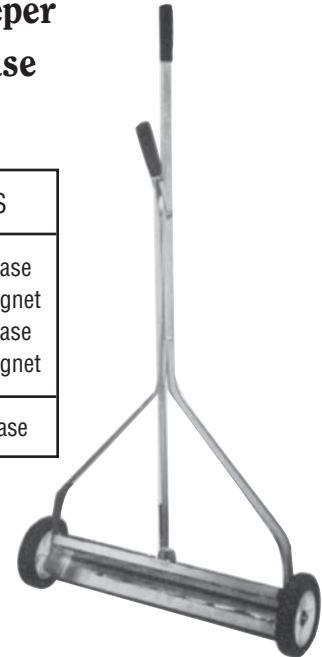

PART NO.	WIDTH	SHIPPING WEIGHT	COMMENTS
600	24"	9 LBS.	W/O Quick Release
602	24"	-	Replacement Magnet
601	36"	13 LBS.	W/O Quick Release
603	36"	-	Replacement Magnet
618	24"	27 LBS.	with Quick Release

• CUSTOM WIDTHS MADE ON REQUEST •

Magnetic T-Bar Sweeper

Part No. 604
Part No. 610
Part No. 611

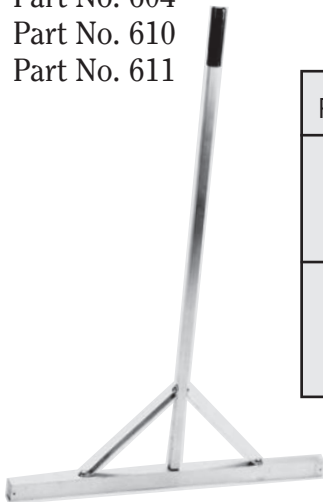

Hand Release Magnets

Part No. 641



PART NO.	WIDTH	SHIPPING WEIGHT	COMMENTS
604	14"	6 LBS.	Magnetic T-Bar
610	24"	8 LBS.	
611	36"	11 LBS.	
641	3" DIA.	4 LBS.	12" High 6-8 LBS. Pickup Capacity

Forklift Magnets

- Easily installs under any front bumper or lift truck using eye hooks supplied and two short lengths of chain.
- Constructed of highest quality materials and permanent magnets that are guaranteed for life.

STANDARD DUTY

PART NUMBER	SIZE	APPROXIMATE WEIGHT
82007	2 x 4 x 36	45 LBS.
82008	2 x 4 x 48	60 LBS.
82009	2 x 4 x 60	75 LBS.
82010	2 x 4 x 72	90 LBS.

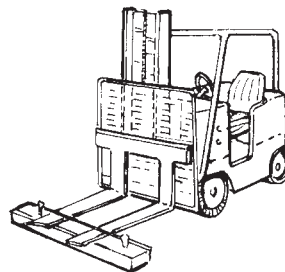





HEAVY DUTY

PART NUMBER	SIZE	APPROXIMATE WEIGHT
82011	2 x 6 x 36	60 LBS.
82012	2 x 6 x 48	80 LBS.
82013	2 x 6 x 60	100 LBS.
82014	2 x 6 x 72	120 LBS.

Safety Glasses

Glasses meet the applicable ANSI Z 87 Standards.
Available in boxes of 12 only.

	FRAME COLOR	LENS COLOR	PART NO.
TOMAHAWK			
	Black	Clear	TK110
	Black	Gray	TK112
STORM			
	Black	Clear	ST110
	Black	Gray	ST112



Safety Glasses Display Case

Displays 12 pairs of glasses.
Part No. ED12
Other displays available.

Safety

Users of any tool should always use the tool in a safe manner, and in the manner to which it is intended. Users should always wear safety glasses, inspect tools for damage, replace damaged tools immediately, never modify a tool, and never use a tool beyond its useful life.

Warehouses Located in the Following Areas:

Dallas
Denver
Detroit
Houston

Indianapolis
Kansas City
Portland
Salt Lake City

Saskatoon
Toronto

Notes:

Notes:



Sample Request Form

Account Name: _____

Purchase Order # : _____

Contact Name : _____

Ship To Address : _____

<u>Part Number</u>	<u>Quantity</u>

For more information on samples, please contact your Customer Service Team at Qualtool, Inc.
 P: 352.343.8100 - 800.327.7187
 E-mail: sales@qualtool.com

COPY TO USE AS ORDER SHEET

BLANKET ORDER

OUR MOST POPULAR METHOD of ORDERING

- Guaranteed Pricing For One Year
- Priority Shipping
- Cost Based On The \$ Value Of The Entire Order
- Consistent Supply Of Quality Parts
- Call For Additional Details

PART NO.	DESCRIPTION	QUANTITY	JAN	FEB	MAR	APR	MAY	JUN	JUL	AUG	SEP	OCT	NOV	DEC
MBH1/4	Mag Bit Holder													
KL-MSH1/4	Mag Nutsetter 1-5/8"													
KL-MSH3/8	Mag Nutsetter 1-5/8"													
KL-MSH5/16	Mag Nutsetter 1-5/8"													
KL-MSHL1/4	Mag Nutsetter 2-9/16"													
KL-MSHL3/8	Mag Nutsetter 2-9/16"													
KL-MSHL5/16	Mag Nutsetter 2-9/16"													
K30-2P	#2 Phillips 1-15/16 x 1/4													
K30-3P	#3 Phillips 1-15/16 x 1/4													
K32-2P	#2 Phillips 2-3/4 x 1/4													
K32-3P	#3 Phillips 2-3/4 x 1/4													
K34-2P	#2 Phillips 3-1/2 x 1/4													
K36-2P	#2 Phillips 6 x 1/4													
K250PB2	#2 Phillips Insert Bit 1"													
K250PB3	#3 Phillips Insert Bit 1"													
K250PBR2	Reduced #2 Phillips 1"													
K250R2	#2 Square Insert Bit 1 x 1/4													
625	Masonry "Drill & Drive" Kit													
2000	31 Piece Bit Kit													
2100	31 Piece Security Bit Kit													
641	Hand Release Magnet													
618	Magnetic Sweeper													
*														
*														
*														
*														
*														

*Add items of your choice

QUALTOOL^{INC.}

The Leading U.S. Manufacturer of Quality Fastening Tools for Construction and Industry



Made in the USA
January 2015

28415 Lake Industrial Boulevard, Tavares, FL 32778
Phone: 352.343.8100 or 800.327.7187 Fax: 352.343.8123
www.qualtool.com E-mail: sales@qualtool.com