

POWER TOOLS

Sioux Tools have been designed and manufactured in the USA for over 100 years. Sioux passionately serves the manufacturing and service industries with world-class pneumatic power tools made in Murphy, NC. From raw materials to final assembly, the Murphy facility manufactures pneumatic drills, screwdrivers, impacts, grinders, sanders and many specialty tools. This is the same award-winning facility that makes many Snap-on Power Tools.

Sioux Tools

Drills	660
Assembly	670
Abrasive	686
Finishing	699
Percussive	709
Specialty	715

Sioux Force Tools

Drills	730
Assembly	733
Abrasive	740
Finishing	743
Percussive	746
Specialty	749
General Accessories	751

DRILLS



Performance, Serviceability, Ergonomics and Value...

POWER TOOLS

DRILLS



Light weight aluminum housing



Ergonomic, handle with soft textured grip



Available in 1 hp and .6 hp motor



3 planet gear system for increased life and load capacity



Teasing throttle, conveniently located reverse

INDUSTRY LEADER

Regarded as the Number 1 choice in the industry, Sioux Tools' pneumatic drills are known around the world for their exceptional engineering and construction. A wide range of configurations, speeds, and options ensure a perfect match for any application. Through next generation ergonomics and the continued focus on productivity and operator safety comes the development of the Sioux Tools Signature Series Drill line.

Signature Series Drills are used in applications ranging from manufactured housing and wood working to light assembly. With free speeds from 300 to 16,000 rpm we have the right drill for any application, for use with any type of material. The powerful five vane motor makes these drills great for drilling applications that contain ferrous and non-ferrous metals, wood and composite materials. The Signature Series Drills offer great value with a 3 planet gear system for increased life and load capacity. The Sioux tools Signature Series Drill line reduces operator fatigue by offering a low sound level and low vibration solution! Operator comfort is achieved through the implementation of a light weight aluminum housing and a comfort grip. Drills are available in both reverse and non-reverse models and are available in pistol grip, straight, Z-handle and D and T-handles, and offer a variety of chuck and collet size.

INNOVATIVE DESIGN

Our exclusive Z-handle models are often the only drills that will get you into those tough, hard to reach spaces, and our miniature aircraft angle drills are designed with small, compact 45° and 90° heads and internal threaded spindles that accept a variety of aircraft precision drill bits.

360° ROTATION

The SDR10S40N360 has a unique 360° rotating head for applications in hard to reach places or difficult angles.

T-HANDLES

Our exceptional T-handle drills help reduce stress on the operators back and arms while making short work of any decking application.

ERGONOMICS

All Sioux Drills offer ergonomic features to provide maximum comfort during operation. Many models include comfortable insulating grips to reduce cold and vibration. We also offer optional support handles for most models.

Drill Maintenance



- 1 Tipper valve and valve seat is easily accessible for service
- 2 Slip fit of front end plate bearing allows easy service of the air motor without disturbing the rotor spacing
- 3 Drop in motor. No alignment necessary (applies to non-reversing drills only)
- 4 Rotor pinion is case hardened to resist wear
- 5 Grease zerk makes it easy to grease the gears without disassembly
- 6 Planetary reduction can be serviced without removing the chuck
- 7 Planet gear pins are slip fit for ease of assembly and disassembly
- 8 Ring gear is machined into the motor retainer for ease of assembly and disassembly
- 9 Interchangeable rotor, cylinder, bearings and end plates. This reduces the number of spare parts tool cribs need to stock





ACCESSORIES

Sioux carries an extensive selection of drill accessories, including hole saws and wire brushes.

See the drill accessory section in this catalog for a comprehensive listing.

DRILL SAFETY

Chips can cause eye injury.

Drilling creates chips. Proper eye protection must be worn at all times by tool user and bystanders.

Broken drill bits can cause eye injury.

Proper eye protection must be worn at all times by tool user and bystanders.

Sudden and unexpected tool movement can cause injury.

Be sure your body position allows you to have control of the tool at all times. Make sure your footing is secure.

Tools starting unexpectedly can cause injury.

Always remove tool from air supply and activate trigger to bleed air line before making any adjustments, changing accessories, or doing any maintenance or service on the tool.

DRILL PRINCIPLES OF OPERATION

An air motor and reduction gearing are used to drive a spindle/drill chuck, which holds accessories for drilling, reaming, tapping, and hole sawing. Motor size (horsepower), gear ratio, handle style and drive spindle determine the type of tool needed to handle an application.

DRILL SPEED GUIDE

Material	Surface Ft/Min	Size of Hole to be Drilled							
		1/16 in 1.5 mm	1/8 in 3.0 mm	3/16 in 5.0	1/4 in 6.0 mm	5/16 in 8.0 mm	3/8 in 9.5 mm	7/16 in 11.0 mm	1/2 in 13.0 mm
Recommended Cutting Speed Range (rpm)									
Steel Alloy, 300-400 Brinell	20-30	1250-1800	600-900	400-600	300-450	250-350	200-300	175-250	150-225
Stainless Steel, Cast Iron, Hard	30-40	1800-2500	900-1200	600-800	450-600	350-500	300-400	250-350	225-300
Steel Forgings	40-50	2500-3100	1200-1500	800-1000	600-750	500-600	400-500	350-425	300-400
Steel, Tool Annealed, .90-1.20 Carbon	50-60	3100-3700	1500-1800	100-1200	750-900	600-700	500-600	425-525	400-450
Steel, .40-.50 Carbon	70-80	4300-5000	2100-2500	1400-1600	1000-1200	850-1000	700-800	600-700	500-600
Cast Iron, Medium Hard	70-100	4300-6000	2100-3000	1400-2000	1000-1500	850-1200	700-1000	600-900	500-800
Bronze, High Tensile Strength	70-150	4300-9000	2100-4500	1400-3000	1000-2300	850-1200	700-1530	600-1300	500-1200
Malleable Iron	80-90	5000-5500	2500-2800	1600-1800	1200-1400	950-1100	800-900	700-800	600-700
Steel, Mild .20-.30 Carbon	80-110	5000-6700	2500-3400	1600-2300	1200-1700	950-1350	800-1150	700-1000	600-850
Cast Iron, Soft Plastic	100-150	6000-9000	3000-4500	2000-3000	1500-2300	1200-1800	1000-1530	900-1300	800-1200
Aluminum, Brass, Bronze	200-300	12,000-18,000	6000-9000	4000-6000	3000-4500	2400-3700	2000-3000	1700-2600	1500-2300
Magnesium	250-400	15,500-25,000	7500-12,000	5000-8200	3800-6100	3000-4900	2500-4000	2200-3500	1900-3000
Fiberglass, Wood	300-400	18,000-25,000	9000-12,000	6000-8200	4600-6100	3700-4900	3000-4000	2600-3500	2300-3000

Actual drilling or cutting RPM will be approximately 80% of rated spindle speed of tool. Surface Feet Per Minute = .26 x RPM x Drill Diameter in Inches.

DRILL USES

Pneumatic drills may first be thought of for drilling holes in wood, metal, or plastic. Drills are used in a wide variety of applications. Each of these applications require the proper tool with the proper horsepower and speed to get the best results. Drilling – cutting a hole in material using a fluted bit. Reaming – opening up or sizing a previously drilled hole or aligning offset holes. Tapping – cutting threads in a drilled hole to accept threaded fasteners.

WHERE USED

- Continuous-duty production drilling
- For initial tap operations and thread chasing
- Wire brushing and deburring
- Screwdriving
- Hole sawing
- General Maintenance

CONSIDERATIONS FOR SELECTING DRILLS

- What type of material is being drilled?
- What size of hole will need to be drilled?
- What are your horsepower requirements?
- What speed requirements do you have?



1410



SDR10P26N3



3P1640



SDR10P26NK3

**PERFORMANCE:**

Power: 0.33 hp (0.25 kW) – 1 hp (0.75 kW)
 Speed Range: 360 rpm – 21,000 rpm
 Chuck Capacity: 1/4" (6 mm) – 1/2" (13 mm)

FEATURES:

Reversible and Non-Reversible
 Trigger Start
 Rotatable Exhaust (0.33 hp models)
 Rubber Grip

PISTOL GRIP DRILLS

Model Number	Chuck Capacity		Free Speed rpm	Weight		Length		Side To Center		Maximum Air Consumption		Sound Level dB(A)	Spindle Thread
	in	mm		lb	kg	in	mm	in	mm	cfm	l/s		
0.33 hp (0.25 kW) – Non-reversible													
1410	1/4	6	2600	1.3	0.60	6.3	160	0.6	15	12	6	75	3/8"-24
DR1412	1/4	6	3600	1.3	0.60	6.3	160	0.6	15	12	6	75	3/8"-24
DR1414	1/4	6	4300	1.3	0.60	6.3	160	0.6	15	12	6	75	3/8"-24
DR1416	1/4	6	6000	1.3	0.60	6.3	160	0.6	15	12	6	75	3/8"-24
1 hp (0.75 kW) – Non-reversible													
SDR10P4N3	3/8	10	400	2.9	1.30	8	205	0.8	20	30	14	80	1/2"-20
SDR10P4N4	1/2	13	400	3.3	1.50	8.5	215	0.8	20	30	14	80	1/2"-20
SDR10P7N3	3/8	10	700	2.9	1.30	8	205	0.8	20	30	14	80	1/2"-20
SDR10P7N4	1/2	13	700	3.3	1.50	8.5	215	0.8	20	30	14	80	1/2"-20
SDR10P12N3	3/8	10	1200	2.9	1.30	8	205	0.8	20	30	14	80	1/2"-20
SDR10P12N4	1/2	13	1200	3.3	1.50	8.5	215	0.8	20	30	1/4	80	1/2"-20
SDR10P16N3	3/8	10	1600	2.9	1.30	8	205	0.8	20	30	14	80	1/2"-20
SDR10P16N4	1/2	13	1600	3.3	1.50	8.5	215	0.8	20	30	1/4	80	1/2"-20
SDR10P26N2	1/4	6	2600	2.3	1.05	6.5	165	0.8	20	30	14	80	3/8"-24
SDR10P26N3	3/8	10	2600	2.5	1.10	7	180	0.8	20	30	14	80	3/8"-24
SDR10P26N4	1/2	13	2600	2.9	1.30	7.5	190	0.8	20	30	14	80	1/2"-20
SDR10P40N2	1/4	6	4000	2.3	1.05	6.5	165	0.8	20	30	14	80	3/8"-24
SDR10P40N3	3/8	10	4000	2.5	1.10	7	180	0.8	20	30	14	80	3/8"-24
SDR10P60N2	1/4	6	6000	2.3	1.05	6.5	165	0.8	20	30	14	80	3/8"-24
SDR10P60N3	3/8	10	6000	2.5	1.10	7	180	0.8	20	30	14	80	3/8"-24
SDR10P180N2	1/4	6	18000	1.85	0.84	5.5	140	0.8	20	30	14	80	3/8"-24
SDR10P210N2	1/4	6	21000	1.85	0.84	5.5	140	0.8	20	30	14	80	3/8"-24
1 hp (0.75 kW) – Non-reversible With Keyless Chuck													
SDR10P4NK4	1/2	13	400	3.1	1.40	7.8	200	0.8	20	25	12	80	1/2"-20
SDR10P7NK4	1/2	13	700	3.1	1.40	7.8	200	0.8	20	25	12	80	1/2"-20
SDR10P12NK3	3/8	10	1200	2.7	1.20	7.3	185	0.8	20	25	12	80	3/8"-24
SDR10P26NK3	3/8	10	2600	2.3	1.00	6.3	160	0.8	20	25	12	80	3/8"-24
SDR10P26NK4	1/2	13	2600	2.7	1.20	6.6	170	0.8	20	25	12	80	1/2"-20
SDR10P40NK3	3/8	10	4000	2.3	1.05	8.3	210	0.8	19	30	14	78	3/8"-24
SDR10P60NK3	3/8	10	6000	2.5	1.10	7	180	0.8	20	30	14	80	3/8"-24
1 hp (0.75 kW) – Non-reversible													
3P1140 ¹	1/2	13	360	5	2.30	8.8	224	1 1/32	26	33	15	80	1/2"-20
3P1240 ¹	1/2	13	650	5	2.30	8.8	224	1 1/32	26	33	15	80	1/2"-20
3P1340 ¹	1/2	13	1000	5	2.30	8.8	224	1 1/32	26	33	15	80	1/2"-20
3P1430 ¹	3/8	10	1400	5	2.30	8.8	224	1 1/32	26	33	15	80	1/2"-20
3P1530 ¹	3/8	10	2150	4.3	2.00	7.5	190	1 1/32	26	33	15	80	1/2"-20
3P1540 ¹	1/2	13	2150	4.3	2.00	7.5	190	1 1/32	26	33	15	80	1/2"-20
3P1640 ¹	1/2	13	2650	4.3	2.00	7.5	190	1 1/32	26	33	15	80	1/2"-20

¹ Not CE Compliant

General: Air Inlet Size: 1/4" NPT • Recommended Hose Size: 3/8" (10 mm) • Performance rated @ 90 psig (6.2 bar) air pressure

Standard Equipment: Parts List • Safety and Instruction Manual • 3-jaw Chuck and Key • Comfort Grip

Accessories: Drill Accessories, see page 669



PERFORMANCE:

Power: 0.20 hp (0.15 kW) – 1 hp (0.75 kW)
 Speed Range: 300 rpm – 6000 rpm
 Chuck Capacity: 1/4" (6 mm) – 1/2" (13 mm)

FEATURES:

Reversible and Non-Reversible
 Trigger Start
 Rotatable Exhaust (1410 series models)
 Rubber Grip

PISTOL GRIP DRILLS

Model Number	Chuck Capacity		Free Speed rpm	Weight		Length		Side To Center		Maximum Air Consumption		Sound Level dB(A)	Spindle Thread
	in	mm		lb	kg	in	mm	in	mm	cfm	l/s		
0.20 hp (0.15 kW) – Reversible													
1410R	1/4	6	2000	1.3	0.60	6.3	160	0.6	15	10	5	75	3/8"-24
1412R	1/4	6	2600	1.3	0.60	6.3	160	0.6	15	10	5	75	3/8"-24
0.60 hp (0.45 kW) – Non-Reversible													
SDR6P4N3	3/8	10	400	2.7	1.20	7.3	185	0.8	20	25	12	80	1/2"-20
SDR6P4N4	1/2	13	400	3.1	1.40	7.8	200	0.8	20	25	12	80	1/2"-20
SDR6P7N3	3/8	10	700	2.7	1.20	7.3	185	0.8	20	25	12	80	1/2"-20
SDR6P7N4	1/2	13	700	3.1	1.40	7.8	200	0.8	20	25	12	80	1/2"-20
SDR6P12N3	3/8	10	1200	2.7	1.20	7.3	185	0.8	20	25	12	80	1/2"-20
SDR6P26N2	1/4	6	2600	2.1	0.95	5.8	145	0.8	20	25	12	80	3/8"-24
SDR6P26N3	3/8	10	2600	2.3	1.00	6.3	160	0.8	20	25	12	80	3/8"-24
SDR6P26N4	1/2	13	2600	2.7	1.20	6.6	170	0.8	20	25	12	80	1/2"-20
SDR6P40N2	1/4	6	4000	2.1	0.95	5.8	145	0.8	20	25	12	80	3/8"-24
SDR6P40N3	3/8	10	4000	2.3	1.00	6.3	160	0.8	20	25	12	80	3/8"-24
SDR6P60N2	1/4	6	6000	2.1	0.95	5.8	145	0.8	20	25	12	80	3/8"-24
SDR6P60N3	3/8	10	6000	2.3	1.00	6.3	160	0.8	20	25	12	80	3/8"-24
0.60 hp (0.45 kW) – Non-Reversible With Keyless Chuck													
SDR6P26NK3	3/8	10	2600	2.3	1.00	6.3	160	0.8	20	25	12	80	3/8"-24
SDR6P40NK3	3/8	10	4000	2.3	1.00	6.3	160	0.8	20	25	12	80	3/8"-24
SDR6P60NK3	3/8	10	6000	2.3	1.00	6.3	160	0.8	20	25	12	80	3/8"-24
1 hp (0.75 kW) – Reversible With Keyless Chuck													
SDR10P7RK4	1/2	13	700	3.5	1.60	9.5	241	0.8	20	30	14	80	1/2"-20
SDR10P20RK3	3/8	10	2000	2.7	1.20	8	203	0.8	20	30	14	80	3/8"-24
1 hp (0.75 kW) – Reversible													
SDR10P3R3	3/8	10	300	3.1	1.40	8.6	220	0.8	20	30	14	80	1/2"-20
SDR10P3R4	1/2	13	300	3.6	1.60	9.1	230	0.8	20	30	14	80	1/2"-20
SDR10P5R3	3/8	10	500	3.1	1.40	8.6	220	0.8	20	30	14	80	1/2"-20
SDR10P5R4	1/2	13	500	3.6	1.60	9.1	230	0.8	20	30	14	80	1/2"-20
SDR10P7R3	3/8	10	700	3.1	1.40	8.6	220	0.8	20	30	14	80	1/2"-20
SDR10P7R4	1/2	13	700	3.6	1.60	9.1	230	0.8	20	30	14	80	1/2"-20
SDR10P12R3	3/8	10	1200	3.1	1.40	8.6	220	0.8	20	30	14	80	1/2"-20
SDR10P12R4	1/2	13	1200	3.6	1.60	9.1	230	0.8	20	30	14	80	1/2"-20
SDR10P20R2	1/4	6	2000	2.4	1.10	7.1	180	0.8	20	30	14	80	3/8"-24
SDR10P20R3	3/8	10	2000	2.6	1.15	7.6	195	0.8	20	30	14	80	3/8"-24
SDR10P20R4	1/2	13	2000	3	1.35	7.9	200	0.8	20	30	14	80	1/2"-20
SDR10P25R2	1/4	6	2500	2.4	1.10	7.1	180	0.8	20	30	14	80	3/8"-24
SDR10P25R3	3/8	10	2500	2.6	1.15	7.6	195	0.8	20	30	14	80	3/8"-24
SDR10P40R2	1/4	6	4000	2.4	1.10	7.1	180	0.8	20	30	14	80	3/8"-24
SDR10P40R3	3/8	10	4000	2.6	1.15	7.6	195	0.8	20	30	14	80	3/8"-24
0.60 hp (0.45 kW) – Rapid Reverse													
SDR6P20R3RR	3/8	10	2000	2.3	1.00	6.3	160	0.8	20	25	12	80	3/8"-24
SDR6P25R3RR	3/8	10	2500	2.3	1.00	6.3	160	0.8	20	25	12	80	3/8"-24
SDR6P20RK3RR	3/8	10	2000	2.4	1.25	7.9	200	0.8	20	25	12	80	3/8"-24
SDR6P20RK4RR	1/2	13	2000	2.7	1.20	8.3	210	0.8	20	25	12	80	1/2"-20
SDR6P25RK3RR	3/8	10	2500	2.4	1.25	7.9	200	0.8	20	25	12	80	3/8"-24
SDR6P25RK4RR	1/2	13	2500	2.7	1.20	8.3	210	0.8	20	25	12	80	1/2"-20

POWER TOOLS

DRILLS: PISTOL GRIP DRILLS



1 hp (0.75 kW) – Rapid Reverse

SDR10P20R3RR	3/8"	10	2000	2.6	1.15	7.6	195	0.8	20	30	14	80	3/8"-24
SDR10P25R3RR	3/8"	10	2500	2.6	1.15	7.6	195	0.8	20	30	14	80	3/8"-24

0.80 hp (0.60 kW) – Reversible

3P2140 ¹	1/2"	13	300	5	2.30	8.8	224	1 1/32"	26	33	15	81	1/2"-20
DR3P2240 ¹	1/2"	13	550	5	2.30	8.8	224	1 1/32"	26	33	15	81	1/2"-20
3P2340 ¹	1/2"	13	850	5	2.30	8.8	224	1 1/32"	26	33	15	81	1/2"-20

¹ Not CE Compliant

General: Air Inlet Size: 1/4" NPT • Recommended Hose Size: 3/8" (10 mm) • Performance rated @ 90 psig (6.2 bar) air pressure

Standard Equipment: Parts List • Safety and Instruction Manual • 3-jaw Chuck and Key • Comfort Grip

Accessories: Drill Accessories, see page 669

PERFORMANCE:

Power: 0.33 hp (0.25 kW) – 1 hp (0.75 kW)
 Speed Range: 300 rpm – 21,000 rpm
 Chuck Capacity: 1/4" (6 mm) – 1/2" (13 mm)

FEATURES:

Reversible and Non-Reversible
 Lever Start
 Rubber Grip (1420, 1422)

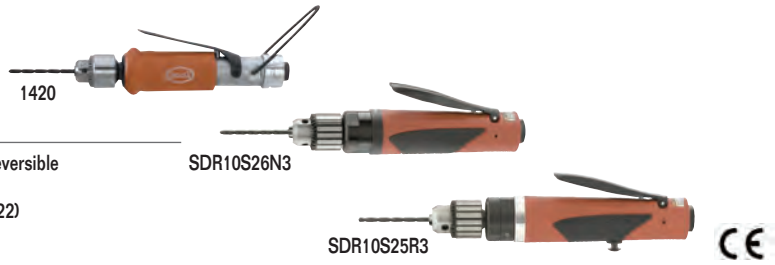

STRAIGHT DRILLS

Model Number	Chuck Capacity		Free Speed rpm	Weight		Length		Side To Center		Maximum Air Consumption		Sound Level dB(A)	Spindle Thread
	in	mm		lb	kg	in	mm	in	mm	cfm	l/s		
0.33 hp (0.25 kW) – Non-reversible													
1420	1/4	6	2600	1.2	0.54	8	203	0.6	15	12	6	75	3/8"-24
DR1422	1/4	6	3600	1.2	0.54	8	203	0.6	15	12	6	75	3/8"-24
1 hp (0.75 kW) – Non-reversible													
SDR10S4N3	3/8	10	400	2.8	1.25	9.3	236	0.8	20	30	14	78	1/2"-20
SDR10S4N4	1/2	13	400	2.8	1.25	9.3	236	0.8	20	30	14	78	1/2"-20
SDR10S7N3	3/8	10	700	2.8	1.25	9.3	236	0.8	20	30	14	78	1/2"-20
SDR10S12N3	3/8	10	1200	2.8	1.25	9.3	236	0.8	20	30	14	78	1/2"-20
SDR10S16N3	3/8	10	1600	2.8	1.25	9.3	236	0.8	20	30	14	78	1/2"-20
SDR10S26N2	1/4	6	2600	2.3	1.05	8.3	211	0.8	20	30	14	78	3/8"-24
SDR10S26N3	3/8	10	2600	2.3	1.05	8.3	211	0.8	20	30	14	78	3/8"-24
SDR10S40N2	1/4	6	4000	2.3	1.05	8.3	211	0.8	20	30	14	78	3/8"-24
SDR10S40N3	3/8	10	4000	2.3	1.05	8.3	211	0.8	20	30	14	78	3/8"-24
SDR10S60N2	1/4	6	6000	2.3	1.05	8.3	211	0.8	20	30	14	78	3/8"-24
SDR10S60N3	3/8	10	6000	2.3	1.05	8.3	211	0.8	20	30	14	78	3/8"-24
SDR10S180N2	1/4	6	18,000	1.85	0.84	7.3	185	0.8	20	30	14	78	3/8"-24
SDR10S210N2	1/4	6	21,000	1.85	0.84	7.3	185	0.8	20	30	14	78	3/8"-24
1 hp (0.75 kW) – Reversible													
SDR10S3R3	3/8	10	300	2.8	1.25	10.8	273	0.8	20	30	14	78	1/2"-20
SDR10S3R4	1/2	13	300	3.2	1.45	11.3	285	0.8	20	30	14	78	1/2"-20
SDR10S5R3	3/8	10	500	2.8	1.25	10.8	273	0.8	20	30	14	78	1/2"-20
SDR10S5R4	1/2	13	500	3.2	1.45	11.3	285	0.8	20	30	14	78	1/2"-20
SDR10S7R3	3/8	10	700	2.8	1.25	10.8	273	0.8	20	30	14	78	1/2"-20
SDR10S7R4	1/2	13	700	3.2	1.45	11.3	285	0.8	20	30	14	78	1/2"-20
SDR10S12R3	3/8	10	1200	2.8	1.25	10.8	273	0.8	20	30	14	78	1/2"-20
SDR10S12R4	1/2	13	1200	3.2	1.45	11.3	285	0.8	20	30	14	78	1/2"-20
SDR10S20R2	1/4	6	2000	2.2	1.00	9.3	235	0.8	20	30	14	78	3/8"-24
SDR10S20R3	3/8	10	2000	2.3	1.05	9.8	248	0.8	20	30	14	78	3/8"-24
SDR10S20R4	1/2	10	2000	2.8	1.25	10.3	260	0.8	20	30	14	78	1/2"-20
SDR10S25R2	1/4	6	2500	2.2	1.00	9.3	235	0.8	20	30	14	78	3/8"-24
SDR10S25R3	3/8	10	2500	2.3	1.05	9.8	248	0.8	20	30	14	78	3/8"-24
SDR10S40R2	1/4	6	4000	2.2	1.00	9.3	235	0.8	20	30	14	78	3/8"-24
SDR10S40R3	3/8	10	4000	2.3	1.05	9.8	243	0.8	20	30	14	78	3/8"-24

General: Air Inlet Size: 1/4" NPT • Recommended Hose Size: 3/8" • Performance rated @ 90 psig (6.2 bar) air pressure

Standard Equipment: Parts List • Safety and Instruction Manual • Suspension Bail • 3-jaw Chuck and Key • Comfort Grip

Accessories: Drill Accessories, see page 669



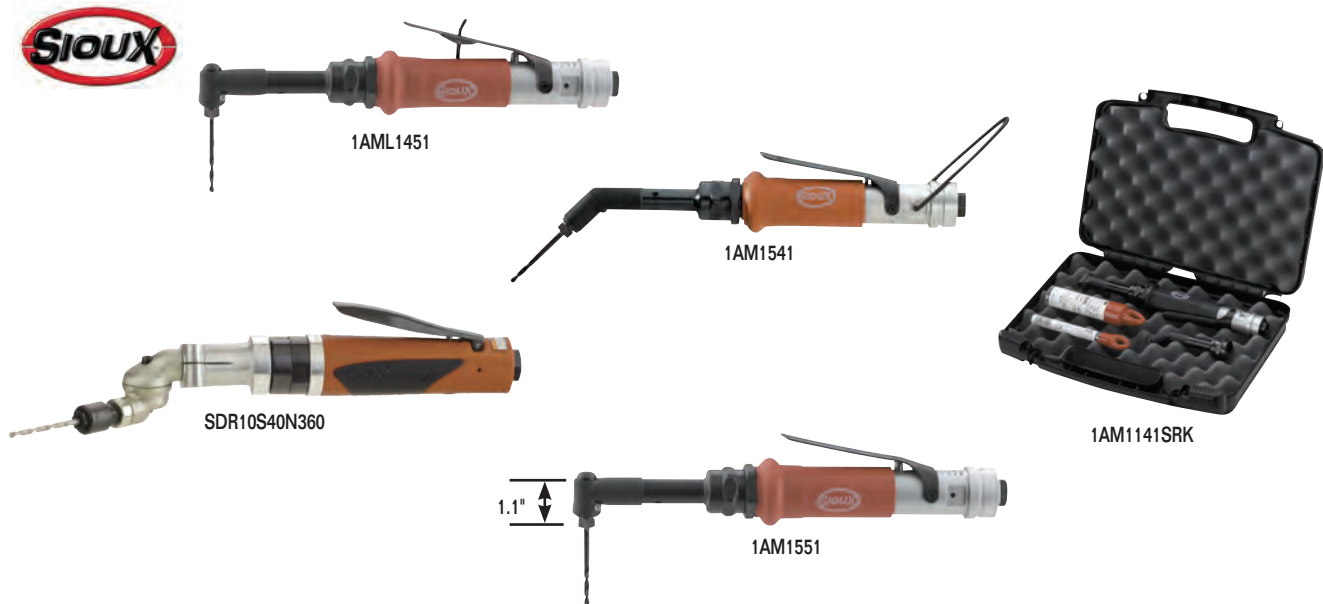

PERFORMANCE:

Power: 0.33 hp (0.25 kW) – 0.75 hp (0.56 kW)
 Speed Range: 540 rpm – 4000 rpm

FEATURES:

Non-Reversible
 Lever Start
 45° or 90° Miniature Angle Heads (except SDR10S40N360)
 180° Adjustable Rotating Head (SDR10S40N360)



MINIATURE ANGLE DRILLS

Model Number	Free Speed		Weight		Length		Side To Center		Maximum Air Consumption		Sound Level
	rpm		lb	kg	in	mm	in	mm	cfm	l/s	dB(A)
45° Angle Head – 0.33 hp (0.25 kW) – 1/4"-28 Internal Thread Spindle											
1AM1441	2200		1.5	0.7	10.2	259	0.3	8	12	6	75
1AM1541	2800		1.5	0.7	10.2	259	0.3	8	12	6	75
1AML1541 (with Lever Lock)	2800		1.5	0.7	10.2	259	0.3	8	12	6	75
90° Angle Head – 0.33 hp (0.25 kW) – 1/4"-28 Internal Thread Spindle											
1AM1451	2200		1.5	0.7	9.7	246	0.3	8	12	6	75
1AML1451 (with Lever Lock)	2200		1.5	0.7	9.7	246	0.3	8	12	6	75
1AM1551	2800		1.5	0.7	9.7	246	0.3	8	12	6	75
1AML1551 (with Lever Lock)	2800		1.5	0.7	9.7	246	0.3	8	12	6	75
SDR10AH35	3500		TBD	TBD	TBD	TBD	0.8	20	30	14	TBD
90° Angle Head – 0.33 hp (0.25 kW) – 9/32"-40 Internal Thread Spindle											
1AM1452	2200		1.5	0.7	9.7	246	0.3	8	12	6	75
1AM1552	2800		1.5	0.7	9.7	246	0.3	8	12	6	75
180° Rotating Head – 0.75 hp (0.56 kW) – Chuck Capacity: #70 thru 1/4"											
SDR10S40N360	4000		2.7	1.3	12.5	318	0.8	20	30	14	80
Sealant Removal Tool Kit											
1AM1141/51K	800		1.8	0.80	11.5	292	0.3	8	12	6	75
Includes 1AM1151 (90° Angle Drill) and 65213 (45° Angle Drill Head Assembly)											
1AM1141SRK	800		1.8	0.80	11.5	292	0.3	8	12	6	75
Includes 1AM1141 (45° Angle Drill)											
1AM1151SRK	800		1.8	0.80	11.5	292	0.3	8	12	6	75
Includes 1AM1151 (90° Angle Drill)											

General: Air Inlet Size: 1/4" NPT • Recommended Hose Size: 3/8" (10 mm) • Performance rated @ 90 psig (6.2 bar) air pressure

Standard Equipment: Parts List • Safety and Instruction Manual

Accessories: Drill Accessories, see page 669



PERFORMANCE:

Power: 0.80 hp (0.60 kW) – 1 hp (0.75 kW)
 Speed Range: 300 rpm – 2200 rpm
 Chuck Capacity: 1/4" (6 mm) – 1/2" (13 mm)

FEATURES:

Reversible and Non-Reversible
 Lever Start
 Heads can be rotated 360°
 Rear or Side Exhaust

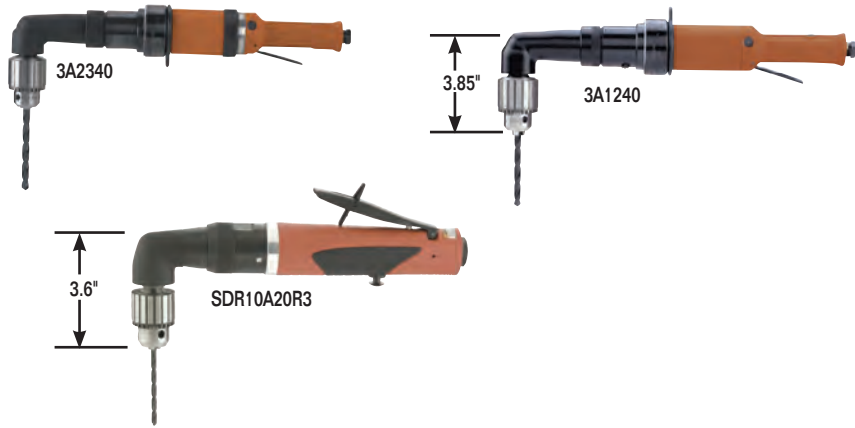

RIGHT ANGLE DRILLS



Model Number	Chuck Capacity		Free Speed rpm	Weight		Length		Side To Center		Maximum Air Consumption		Sound Level dB(A)	Spindle Thread
	in	mm		lb	kg	in	mm	in	mm	cfm	l/s		
0.80 hp (0.60 kW) – Reversible – Side Exhaust¹													
3A2140 ¹	1/2	13	300	6.9	3.10	15.5	394	0.8	19	33	16	81	1/2"-20
3A2240 ¹	1/2	13	480	6.9	3.10	15.5	394	0.8	19	33	16	81	1/2"-20
3A2340 ¹	1/2	13	700	6.9	3.10	15.5	394	0.8	19	33	16	81	1/2"-20
3A2430 ¹	3/8	10	1000	6.3	2.90	15.4	391	0.8	19	33	16	81	1/2"-20
1 hp (0.75 kW) – Reversible													
SDR10A3R3	3/8	10	300	3.3	1.50	12	305	0.8	19	30	14	78	3/8"-24
SDR10A3R4	1/2	13	300	3.7	1.65	12	305	0.8	19	30	14	78	3/8"-24
SDR10A6R3	3/8	10	600	3.3	1.50	12	305	0.8	19	30	14	78	3/8"-24
SDR10A6R4	1/2	13	600	3.7	1.65	12	305	0.8	19	30	14	78	3/8"-24
SDR10A10R3	3/8	10	1000	3.3	1.50	12	305	0.8	19	30	14	78	3/8"-24
SDR10A10R4	1/2	13	1000	3.7	1.65	12	305	0.8	19	30	14	78	3/8"-24
SDR10A16R2	1/4	6	1600	3.2	1.40	12	305	0.8	19	30	14	78	3/8"-24
SDR10A16R3	3/8	10	1600	3.3	1.50	12	305	0.8	19	30	14	78	3/8"-24
SDR10A20R2	1/4	6	2000	2.9	1.30	11	280	0.8	19	30	14	78	3/8"-24
SDR10A20R3	3/8	10	2000	3	1.35	11	280	0.8	19	30	14	78	3/8"-24
1 hp (0.75 kW) – Non-Reversible													
SDR10A4N3	3/8	10	400	3.3	1.50	11.2	285	0.8	19	30	14	78	3/8"-24
SDR10A4N4	1/2	13	400	3.7	1.65	11.2	285	0.8	19	30	14	78	3/8"-24
SDR10A10N3	3/8	10	1000	3.3	1.50	11.2	285	0.8	19	30	14	78	3/8"-24
SDR10A10N4	1/2	13	1000	3.7	1.65	11.2	285	0.8	19	30	14	78	3/8"-24
SDR10A13N2	1/4	6	1300	3.2	1.40	11.2	285	0.8	19	30	14	78	3/8"-24
SDR10A13N3	3/8	10	1300	3.3	1.50	11.2	285	0.8	19	30	14	78	3/8"-24
SDR10A22N2	1/4	6	2200	2.9	1.30	10.2	260	0.8	19	30	14	78	3/8"-24
SDR10A22N3	3/8	10	2200	3	1.35	10.2	260	0.8	19	30	14	78	3/8"-24
SDR10A30N2	1/4	6	3000	2.9	1.30	10.2	260	0.8	19	30	14	78	3/8"-24
1 hp (0.75 kW) – Non-reversible – Side Exhaust¹													
3A1140 ¹	1/2	13	360	6.5	2.90	15.1	384	0.8	19	33	16	80	1/2"-20
3A1240 ¹	1/2	13	600	6.5	2.90	15.1	384	0.8	19	33	16	80	1/2"-20
3A1530	3/8	10	1800	6.5	2.90	15.1	384	0.8	19	33	16	80	1/2"-20

¹ Not CE Certified

General: Air Inlet Size: 1/4" NPT • Recommended Hose Size: 3/8" (10 mm) • Performance rated @ 90 psig (6.2 bar) air pressure

Standard Equipment: Parts List • Safety and Instruction Manual • 3-jaw Chuck and Key

Accessories: Drill Accessories, see page 669





1465

PERFORMANCE:

Power: 1 hp (0.75 kW)
 Speed Range: 375 rpm – 2,000 rpm
 Chuck Capacity: 3/8" (10 mm) – 1/2" (13 mm)

FEATURES:

Non-Reversible
 Trigger Start
 Side Exhaust
 Support Handle Included
 Swivel Air Inlet

D-HANDLE DRILLS

Model Number	Chuck Capacity		Free Speed rpm	Weight		Length		Side To Center		Maximum Air Consumption		Sound Level dB(A)	Spindle Thread
	in	mm		lb	kg	in	mm	in	mm	cfm	l/s		
"D" Handle Drill – 1 hp (0.75 kW) – Non-Reversible													
DR1467	1/2	13	375	6.6	3	13.4	340	1	25	30	14	76	1/2"-20
1466	1/2	13	550	6.6	3	13.4	340	1	25	30	14	76	1/2"-20
1465-1/2	1/2	13	1000	6.6	3	13.4	340	1	25	30	14	76	1/2"-20
1464	1/2	13	2000	6.6	3	13.4	340	1	25	30	14	76	1/2"-20
1465	3/8	10	1000	6.6	3	13.3	338	1	25	30	14	76	1/2"-20

General: Air Inlet Size: 1/4" NPT • Recommended Hose Size: 3/8" (10 mm) • Performance rated @ 90 psig (6.2 bar) air pressure

Standard Equipment: Parts List • Safety and Instruction Manual • 3-jaw Chuck and Key • Swivel Air Inlet

Accessories: Drill Accessories, see page 669

POWER TOOLS

DRILLS: D-HANDLE DRILLS/T-HANDLE DRILLS

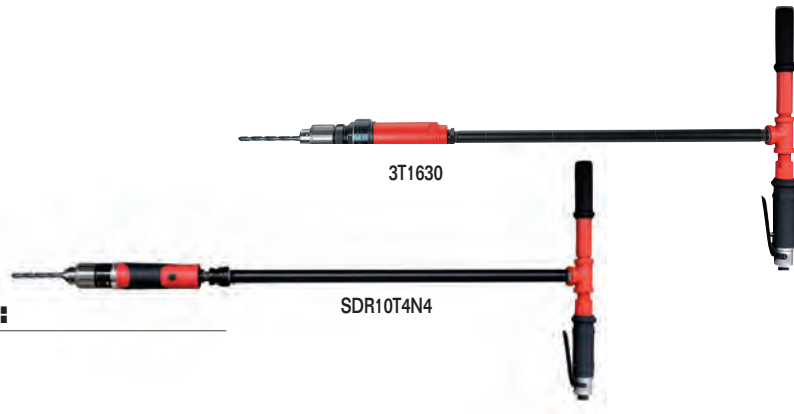

3T1630

SDR10T4N4

PERFORMANCE:

Power: 1 hp (0.75 kW)
 Speed Range: 360 rpm – 4000 rpm
 Chuck Capacity: 3/8" (10 mm) – 1/2" (13 mm)

FEATURES:

Non-Reversible
 Lever Start
 Handle Grips

T-HANDLE DRILLS

Model Number	Chuck Capacity		Free Speed rpm	Weight		Length		Side To Center		Maximum Air Consumption		Sound Level dB(A)	Spindle Thread
	in	mm		lb	kg	in	mm	in	mm	cfm	l/s		
Signature Series – 1 hp (0.75 kW) – Non-reversible													
SDR10T4N4	1/2	13	400	6.3	2.9	36	914	0.85	21.6	35	17	80	1/2"-20
SDR10T7N4	1/2	13	700	6.3	2.9	36	914	0.85	21.6	35	17	80	1/2"-20
SDR10T12N4	1/2	13	1200	6.3	2.9	36	914	0.85	21.6	35	17	80	1/2"-20
SDR10T16N4	1/2	13	1600	6.3	2.9	36	914	0.85	21.6	35	17	80	1/2"-20
SDR10T26N3	3/8	10	2600	5.6	2.5	36	914	0.85	21.6	35	17	80	3/8"-24
SDR10T26N4	1/2	13	2600	5.9	2.7	36	914	0.85	21.6	35	17	80	1/2"-20
SDR10T40N3	3/8	10	4000	5.6	2.5	36	914	0.85	21.6	35	17	80	3/8"-20
3 - Series – 1 hp (0.75 kW) – Non-reversible													
3T1140	v	13	360	7.6	3.5	35	889	1	25	35	17	80	1/2"-20
3T1340	1/2	13	1000	7.6	3.5	35	889	1	25	35	17	80	1/2"-20
3T1530	3/8	10	2150	7.3	3.3	35	889	1	25	35	17	80	1/2"-20
3T1630	3/8	10	2650	7.3	3.3	35	889	1	25	35	17	80	1/2"-20
3T1640	1/2	13	2650	7.4	3.4	35	889	1	25	35	17	80	1/2"-20

General: Air Inlet Size: 1/4" NPT • Recommended Hose Size: 3/8" (10 mm) • Performance rated @ 90 psig (6.2 bar) air pressure

Standard Equipment: Parts List • Safety and Instruction Manual • 3-jaw Chuck and Key • Comfort Grip

Accessories: Drill Accessories, see page 19



2S1310



2S2130

PERFORMANCE:

Power: 0.33 hp (0.25 kW) – 0.50 hp (0.37 kW)
 Speed Range: 1000 rpm – 2200 rpm
 Chuck Capacity: 1/4" (6 mm) – 3/8" (10 mm)

FEATURES:

Reversible and Non-Reversible
 Lever Start
 Rear Exhaust
 Suspension Bail



Z-HANDLE DRILLS

Model Number	Chuck Capacity		Free Speed rpm	Weight		Length		Side To Center		Maximum Air Consumption		Sound Level dB(A)	Spindle Thread
	in	mm		lb	kg	in	mm	in	mm	cfm	l/s		
Non-reversible – 0.50 hp (0.37 kW)													
2S1310	1/4	6	2200	2.6	1.2	3.5	89	1	25	18	8	75	3/8"-24
2S1330	3/8	10	2200	2.7	1.2	3.8	97	1	25	18	8	75	3/8"-24
Reversible – 0.33 hp (0.25 kW)													
2S2110	1/4	6	1000	2.6	1.2	3.5	89	1	25	16	8	75	3/8"-24
2S2130	3/8	10	1000	2.7	1.2	3.8	97	1	25	16	8	75	3/8"-24
2S2230	3/8	10	1600	2.7	1.2	3.8	97	1	25	16	8	75	3/8"-24
2S2310	1/4	6	2200	2.6	1.2	3.5	89	1	25	16	8	75	3/8"-24
2S2330	3/8	10	2200	2.7	1.2	3.8	97	1	25	16	8	75	3/8"-24

General: Air Inlet Size: 1/4" NPT • Recommended Hose Size: 3/8" (10 mm) • Performance rated @ 90 psig (6.2 bar) air pressure

Standard Equipment: Parts List • Safety and Instruction Manual • 3-jaw Chuck and Key • Suspension Bail

Accessories: Drill Accessories, see page 669





DRILL CHUCKS & KEYS

Adapts arbor with 1/2"-20 thread to hole saw with 5/8"-18 thread



Chuck Capacity	Thread Size	Chuck Part No	Key Part No	Key Holder No
0 - 1/4"	3/8"-24	21077	30000	
0 - 1/4"	3/8"-24	21019B	30000	
0 - 3/8"	1/2"-20	21002	30011	14273
0 - 3/8"	3/8"-24	21085	30231	14273
0 - 3/8"	3/8"-24	69005		
0 - 1/2"	1/2"-20	69006		
1/16" - 3/8"	1/2"-20	21131	30002	
1/16" - 3/8"	3/8"-24	21133	30002	14273
5/64" - 1/2"	3/8"-24	21132	30429	
5/64" - 1/2"	1/2"-20	21137	30011	14273

¹Keyless Chuck • Keyed chucks include key

QUICK CHANGE CHUCK

Part No 2352

Adapts 3/8"-24 threaded spindles to 1/4" hex quick change



Non-Reversing Only

SR CUTTERS



SR40



SR83

Sioux Part Number	Description
SR40	#3 (0.40") SR Cutter
SR83	#8 (0.83") SR Cutter

Sold in case of 40

SUPPORT HANDLE

Part No 2355B

For use on ES, 2L, 3P series drills



SIGNATURE SERIES SUPPORT HANDLE

Part No SPSDR-14A

For use on Signature Series Drills



Part No 77067A

Heavy Duty Support Handle for Signature Series Drills

COMFORT GRIPS

For use on 1SM & 1ST series drills



66124

For use on 10M & 10T series drills



For use on Signature series drills

68340



SDR6PNBOOT / SDR10PNBOOT

ASSEMBLY



Combining Efficiency, Reliability and Value...

PUTTING IT ALL TOGETHER

To keep up with the rapidly growing demands of modern assembly applications, Sioux Tools remains on the cutting edge of engineering design. We continue to be innovative in creating new tools to provide faster rundown speeds with exceptional accuracy and consistent torque delivery, combined with ergonomic design for operator comfort and safety.

We build every tool to help assembly operators become more productive. We believe they deserve tools that will help improve their quality of performance and maximize the skills they bring to the job.

EXCLUSIVE DESIGNS

Sioux Tools is the exclusive manufacturer of the Z-handle. This unique feature allows access to tight, hard to reach angles.

IMPACT WRENCHES

Suitable for general assembly, repair jobs, etc. When you require a powerful, lightweight tool, with little reaction force and moderate accuracy. This is the best choice for loosening joints.

SCREWDRIVERS

Sioux Tools offers a wide range of screwdrivers designed to meet today's fast paced, high output assembly and manufacturing applications.

NUTRUNNERS

Sioux offers nutrunners that are designed for high volume industrial production. You can choose from free speeds of up to 2200 rpm, and a torque range of up to 600 in lb (68 Nm). These are outstanding tools for fast, accurate assembly.



An Easy Drive Home

Sioux Tools offers a wide range of screwdrivers and nutrunners designed to meet today's fast paced, high output assembly and manufacturing applications. Sioux Tools is able to provide a perfect match for any job requirement. As industries strive to reduce fastener requirements, we work to meet the demand for greater accuracy and precision in fastening performance. The productivity demands for quality and speed, as well as user comfort, convenience and safety make Sioux Tools your number one choice.

CONFIGURATIONS

Sioux screwdrivers are available in pistol grip, inline, right angle and our exclusive Z-handle configurations. Most screwdriver models offer your choice of Quick Change or Locking Internal Hex spindles. The spring-loaded chuck on the Quick Change allows for fast, easy bit changes without the need for additional tools or hardware. The slimmer

ASSEMBLY SAFETY

Broken sockets, bits and adapters can cause injury.

Proper eye protection must be worn at all times by tool user and bystanders. Use only sockets, bits and adapters made for power tools and that are in good condition. Use only bits and adapters that are in good condition. Keep hands away from sockets, bits and adapters.

Sudden and unexpected tool movement can cause injury.

Be sure your body position allows you to have control of the tool at all times. Make sure your footing is secure. Consult manufacturer for proper reaction bar if movement is excessive.

Tools starting unexpectedly can cause injury.

Always remove the tool from air supply and activate trigger to bleed air line before making any adjustments, changing accessories, or doing any maintenance or service on the tool.

Falling tools can cause injury.

If the tool is used with a balancer or other suspension device, be sure the tool is firmly attached to the device.

ASSEMBLY PRINCIPLES OF OPERATION

An air motor and planetary reduction gearing are used to drive a clutch spindle, producing torque in a fastener.

The action of the torque creates clamp-load in the assembly.

Motor size (horsepower), gear ratio, and type of clutch determine performance, and are key factors in selecting the appropriate tool for a given application.

Generally equipped with a 1/4" female hexagon spindle that allows inserting a screwdriver bit.



design of the Locking Internal Hex ensures that the bit stays firmly in place until you choose to remove it with the aid of a vise or pliers.

REDUCING PHYSICAL LOAD

We design all our screwdrivers with ergonomics in mind. We help you get the job done with a minimum amount of effort and wear and tear on the operator. By reducing the physical load on the operator, which includes noise and oil mist, productivity will be improved. Sioux Tools offers many benefits including high torque accuracy, low sound levels and ergonomic grips. Fast clutch shutoff reduces reaction force, while the shape reduces the amount of gripping and trigger force required.



CLUTCH SELECTION

Positive Clutch – Spindle will not turn with motor until operator exerts forward pressure on spindle engaging the clutch. The clutch ratchets when torque resistance from the fastener overcomes the forward pressure and the jaws begin to cam apart. Torque output of the tool is determined by forward pressure from operator and by the cam angle of the clutch jaws. For wood, sheet metal, and machine screws and lag bolts.

Sioux Tools is the exclusive manufacturer of three different positive clutches; Low, Mid and High torque output. Your choice of clutch allows you to more precisely control the amount of torque exerted on the fastener.







Stall Drive – Spindle is coupled directly with the output of the motor. Final torque is reached when resistance of the fastener overcomes the torque output of the motor. Final torque can be influenced by air pressure and/or operator twisting the tool. For prevailing torque or soft pull applications involving machine, wood, or self-tapping screws.

Adjustable Clutch – Spindle will not turn with motor until operator exerts forward pressure on spindle engaging the clutch. When fastener is tight, clutch will ratchet. Adjusting spring pressure will effect final output torque. Offers consistent torque control with little operator reaction.

Torque Control – Motor shuts off automatically when fastener is tight. Adjusting spring pressure changes final output torque for critical torque requirements. Perfect for applications with little or no prevailing torque where final torque is substantially higher than rundown torque.

Direct Clutch – Spindle will not turn with motor until operator exerts forward pressure on spindle engaging the clutch. Final torque is reached when resistance of the fastener overcomes the torque output of the motor. Excellent stall type tool when tightening group of fasteners without turning off motor.

CLUTCH SELECTION GUIDE

Type of Job	Clutch Performance			
	Torque Control	Adjustable	Direct/Stall Drive	Positive Clutch
<p>1. Free-Running – Sudden Stop</p>  <p>Turns easily until screw head or nut seats against a solid stop. Resistance then builds up suddenly.</p>	Excellent for all size screws.	Good for all size screws. Close torque control is not required.	Good for large or medium nuts or cap screws only.	Fair for all size screws where close torque accuracy is not required.
<p>2. Soft Pull-Up</p>  <p>Turns easily until screw head or nut seats, then resistance builds up gradually through one or more turns as resilient material compressed.</p>	Excellent for all size screws.	Good for most screws. Close torque control is not required. Slow on large screws with long pull-up.	Good for large and medium size screws. Must be adjusted to run rather slowly for small screws.	Good for small to medium size screws. Requires considerable operator pressure on large screws.
<p>3. Self-Tapping in Thick Material</p>  <p>Increasing heavy resistance through entire travel until screw head seats. Then either (A) gradual, or (B) sudden final build-up resistance.</p>	Excellent for all size screws. Not suitable if tapping torque exceeds stripping torque.	Good for most screws. With proper operator technique, can be used where tapping torque exceeds stripping torque. Slow on large screws.	Not recommended unless stripping torque is considerably higher than tapping torque.	Good for most size screws where stripping torque is considerably higher than tapping torque. Excellent in non-uniform or misaligned material.
<p>4. Sheet Metal Screws</p>  <p>Resistance increases rapidly at first, then eases slightly. At the end, it usually builds up suddenly when screw head seats.</p>	Good for all size screws. Not suitable if tapping torque exceeds stripping torque.	Good for most screws. With proper operator technique, can be used where tapping torque exceeds stripping torque.	Not recommended unless stripping torque is considerably higher than tapping torque.	Good for all size screws where stripping torque is considerably higher than tapping torque. Excellent when sheets are frequently misaligned.
<p>5. Lock Nuts</p>  <p>Starts with heavy resistance that lasts through entire travel until screw or nut seats. Then either (A) gradual, or (B) sudden further build-up resistance.</p>	Excellent for all size screws.	Good for most screws. Close torque control is not required.	Good for large and medium screws. Must be adjusted to run rather slowly for small screws.	Fair for all size screws.
<p>6. Wood Screws</p>  <p>Starts with small resistance that steadily increases through entire travel with additional resistance as screw head seats.</p>	Fair for all size screws.	Good for all size screws.	Excellent for large and medium screws. Must be adjusted to run rather slowly for small screws.	Excellent for all size screws.

Tool Selection Guide



CONSIDERATIONS FOR SELECTING SCREWDRIVERS

This should be done in a systematic way to ensure no details are overlooked that could have an adverse affect on job function or results. The following are variables that must be considered to ensure proper tool selection.

What is being assembled?	What is the production rate?
What material is involved?	Are there clearance problems?
What type of screw or nut is being driven? What head type?	What handle style is required (straight or pistol)?
What screw size (standard or metric)?	Is the tool to be hand held or fixtured?
What U.S. grade or metric class?	What type of clutch?
What torque (inch pounds or Newton meters)?	Speed required?
What torque tolerance (accuracy)?	Is there a need for a reversible tool?
What is the run-down torque vs. seating torque?	What type of drive (square, 1/4" hex, quick change)?
What type of joint pull-up (hard, medium, soft)?	How is the application being done now?
What pull-up conditions (free run-down, sheet metal, wood, or plastic)?	Special consideration?

WHAT IS THE SIZE AND TYPE OF SCREW OR FASTENER ON WHICH THE TOOL WILL BE USED?

No 1 Series Tools – 2 to 50 in lb of torque. (Fasteners up to 1/4")

.6 & 1 HP Signature Series Tools – 5 to 400 in lbs of torque. (Fasteners up to 3/8")

No 3 Series Tools – 5 to 50 ft lbs of torque. (Fasteners up to 1/2")

WHAT KIND OF APPLICATION AND MATERIAL WILL THE FASTENER BE USED ON?

The type of material helps to determine which type of clutch is needed.

APPLICATION & MATERIAL GUIDE

Screw Size	Clutch	Free Run Down	Soft Pull-Up	Prevailing Torque
No 8 and Smaller	Adjustable	Excellent	Excellent	Excellent
	Stall	Excellent	Good	Excellent
	Direct	Good	Good	Good
	Positive	Fair	Fair	Good
No 10 and Larger	Adjustable	Good	Fair	Fair
	Stall	Good	Excellent	Excellent
	Direct	Good	Excellent	Excellent
	Positive "P"	Good	Excellent	Excellent
	Positive "PS"	Good	Excellent	Excellent

WHAT ARE THE TORQUE REQUIREMENTS?

Most air tools share the quality: as the speed increases, the torque decreases. This applies to tools within the same horsepower rating.

- Stall or direct clutch gives the most torque.
- Positive clutch tools are operator influenced.
- Adjustable torque clutches are available on most Sioux fastening tools.
- Torque control is available on No 1 series

AT WHAT ANGLE OR POSITION WILL THE TOOL BE USED?

This will determine the style of tool best suited from an ergonomics point of view.

- If the fastener is in a vertical position, a straight or lever style tool will be best.
- If the fastener is in a horizontal position a pistol style tool will be best.
- If the fastener is in a tight or constricted area the "2S" series works well in this application.

IS REVERSING NECESSARY?

Most fastening applications are going to require a reversible tool. Keep in mind that in most cases a non-reversing tool will have more torque than a reversible tool.

IS THE APPLICATION OPERATOR INFLUENCED OR RESTRICTED?

- Is the operator male or female? This can be a factor in determining the size of the power tool (weight for example).
- Does the application lend itself to an auto start tool, as in the No 1 series?

AN EXAMPLE OF APPLYING THESE QUESTIONS TO AN APPLICATION WOULD BE:

Driving a 2" long wood screw into hardwood with a pilot hole. The fastener is in a horizontal position during assembly. A test with a hand torque wrench indicates a prevailing torque of 80 in lbs, and a failing torque of 120 in lbs.

- 2" long wood screw
- Hard Wood use positive clutch
- SSD10P20PS – 100 in lbs
- Pistol will work best
- Need reversing
- Mostly male workers



Screwdriver Maintenance



Adjustable Clutch Screwdrivers

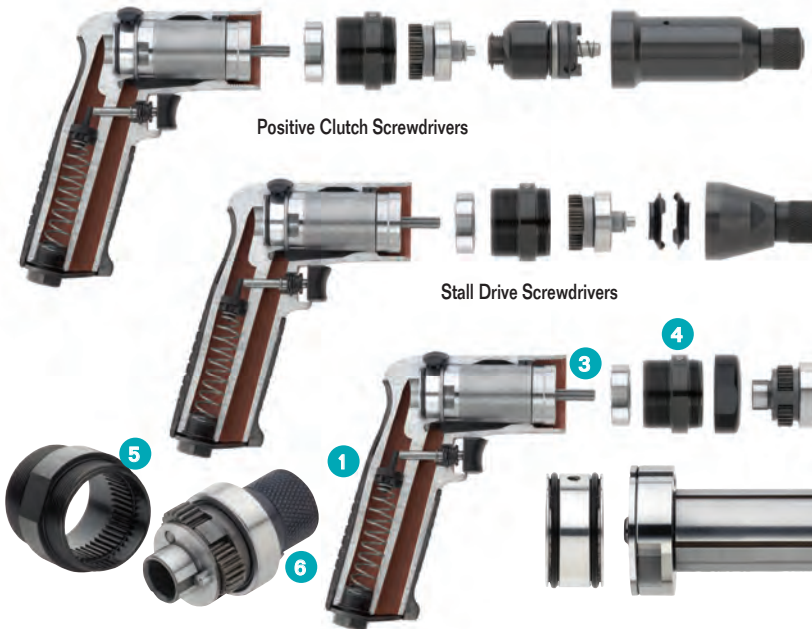

- 1 Tipper valve and valve seat is easily accessible for service
- 2 Slip fit of front end plate bearing allows easy service of the air motor without disturbing the rotor spacing
- 3 Rotor pinion is case hardened to resist wear
- 4 Grease zerk makes it easy to grease the gears without disassembly
- 5 Ring gear is machined into the motor retainer for ease of assembly and disassembly
- 6 Planet gear pins are slip fit for ease of assembly and disassembly
- 7 Interchangeable rotor, cylinder, bearings and end plates. This reduces the number of spare parts tool cribs need to stock

POWER TOOLS

ASSEMBLY

GUIDE TO FASTENERS

Screw Type

Standard Nosepieces Available For All Fasteners Shown Below

Wood Screws



Machine Screws

* Standard or Special, depending on the washer diameter.



Tapping or Sheet Metal Screws



Drive Systems

* Special bits required for Clutch and Torx internal and external. Call factory.

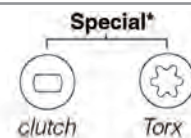
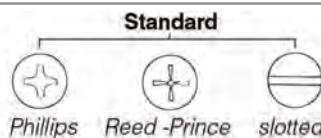



SSD6P20P



SSD10P20PRR



3T2303



1OM2403



SSD10P20PS

POWER TOOLS

ASSEMBLY: SCREWDRIVERS

PERFORMANCE:

Torque: 24 in lb (2.7 Nm) – 216 in lb (24.4 Nm)
Speed: 725 rpm – 2500 rpm

FEATURES:

Reversible and Non-reversible
Trigger Start
Trigger or Shuttle Reverse
Comfort Grip
Rotatable Exhaust (1OM series)

POSITIVE CLUTCH PISTOL GRIP & T-HANDLE SCREWDRIVERS



Model Number	Max Torque ¹ (Soft Joint)		Free Speed rpm	Weight		Length		Side To Center		Air Consumption		Sound Level dB(A)
	in lb	Nm		lb	kg	in	mm	in	mm	cfm	l/s	
1 Series – Rapid Reverse – 1/4" Quick Change												
1OM2103	55	6.2	725	1.8	0.80	7.7	196	0.7	17	8	4	75
1OM2203	40	4.5	1000	1.8	0.80	7.7	196	0.7	17	8	4	75
1OM2303	30	3.4	1400	1.8	0.80	7.7	196	0.7	17	8	4	75
1OM2403	24	2.7	2000	1.6	0.70	6.7	170	0.7	17	8	4	75
0.6 hp (0.45 kW) Medium Clutch Screwdrivers – 1/4" Quick Change												
SSD6P12P	100	11.3	1200	2.6	1.18	8.6	218	0.8	20	25	12	80
SSD6P20P	55	6.2	2000	2.2	0.98	6.8	171	0.8	20	25	12	80
SSD6P20PSRR	55	6.2	2000	2.2	0.98	6.8	171	0.8	20	25	12	80
SSD6P25P	40	4.5	2500	2.2	0.98	6.8	171	0.8	20	25	12	80
SSD6P25PSRR	40	4.5	2500	2.2	0.98	6.8	171	0.8	20	25	12	80
1 hp (0.75 kW) Medium Torque Clutch Screwdrivers – 1/4" Quick Change												
SSD10P12P	135	15.3	1200	2.8	1.30	9.1	231	0.8	20	30	14	80
SSD10P20P	70	7.9	2000	2.4	1.07	7.3	185	0.8	20	30	14	80
SSD10P25P	50	5.7	2500	2.4	1.07	7.3	185	0.8	20	30	14	80
1 hp (0.75 kW) High Torque Clutch Screwdrivers – 1/4" Quick Change												
SSD10P12PS	145	16.4	1200	2.8	1.30	9.1	231	0.8	20	30	14	80
SSD10P20PS	80	9	2000	2.4	1.07	7.3	185	0.8	20	30	14	80
SSD10P25PS	58	6.5	2500	2.4	1.07	7.3	185	0.8	20	30	14	80
1 hp (0.75 kW) – Medium Torque Positive Clutch Rapid Reverse Screwdriver												
SSD10P20PRR	70	7.9	2000	2.4	1.07	7.3	185	0.8	20	30	14	80
SSD10P25PRR	50	5.7	2500	2.4	1.07	7.3	185	0.8	20	30	14	80
3 Series T-Handle – 3/16" Quick Change												
3T2303 ¹	216	24.4	850	6.7	3	33	840	1	25	33	16	81

¹ Torque output varies with force exerted by operator

General: Air Inlet Size: 1/4" NPT • Recommended Hose Size: 1/4" (6 mm) (1OM series) • Performance rated @ 90 psig (6.2 bar) air pressure

Standard Equipment: Parts List • Safety and Instruction Manual • Comfort Grip (1OM series)

Accessories: Screwdriver Accessories, Screwdriver Bits and Finders see page 685



WARNING



Safety Precaution: Read and follow all safety and operation instructions.
Warning: Face & eye protection must be worn while operating power tools, per ANSI B186.1.



PERFORMANCE:

Torque: 55 in lb (6.2 Nm)
Speed: 800 rpm

FEATURES:

Reversible
Lever Start
Rear Exhaust



1SM2103



POWER TOOLS

ASSEMBLY: SCREWDRIVERS

POSITIVE CLUTCH INLINE SCREWDRIVERS

Model Number	Max Torque ¹ (Soft Joint)		Free Speed rpm	Weight		Length		Side To Center		Air Consumption		Sound Level dB(A)
	in lb	Nm		lb	kg	in	mm	in	mm	cfm	l/s	
1/4" Quick Change												
Inline												
1SM2103	55	6.2	800	1.4	0.6	9.1	231	0.6	15	8	4	75

¹ Torque output varies with force exerted by operator

General: Air Inlet Size: 1/4" NPT • Recommended Hose Size: 1/4" (6 mm) (1SM series) • Performance rated @ 90 psig (6.2 bar) air pressure

Standard Equipment: Parts List • Safety and Instruction Manual • Comfort Grip (1SM series)

Accessories: Screwdriver Accessories, Screwdriver Bits and Finders see page 685

PERFORMANCE:

Torque: 18 in lb (2 Nm) – 400 in lb (45.2 Nm)
Speed: 300 rpm – 2600 rpm

FEATURES:

Reversible
Trigger Start
Rapid or Shuttle Reverse
Comfort Grip
1/4" Quick Change



1OM2407

SSD6P20S

SSD10P20S

SSD10P20SRR



STALL PISTOL GRIP SCREWDRIVERS

Model Number	Max Torque (Soft Joint)		Free Speed rpm	Weight		Length		Side To Center		Air Consumption		Sound Level dB(A)
	in lb	Nm		lb	kg	in	mm	in	mm	cfm	l/s	
Trigger Start - Trigger Reverse												
1OM2107	55	6.2	725	1.8	0.80	7.7	196	0.7	18	8	4	75
1OM2207	40	4.5	1000	1.8	0.80	7.7	196	0.7	18	8	4	75
1OM2307	30	3.4	1400	1.8	0.80	7.7	196	0.7	18	8	4	75
1OM2407	24	2.7	2000	1.6	0.70	6.7	170	0.7	18	8	4	75
1OM2507	18	2	2600	1.6	0.70	6.7	170	0.7	18	8	4	75
0.6 hp (0.45 kW) Trigger Start - Shuttle Reverse												
SSD6P7S	155	17.8	700	2.4	1.10	6.8	171	0.8	20	25	12	80
SSD6P12S	100	11.3	1200	2.4	1.10	6.8	171	0.8	20	25	12	80
SSD6P20S	55	6.2	2000	2	0.90	5.8	146	0.8	20	25	12	80
SSD6P25S	40	4.5	2500	2	0.90	5.8	146	0.8	20	25	12	80
0.6 hp (0.45 kW) Trigger Start - Rapid Reverse												
SSD6P20SRR	55	6.2	2000	2	0.90	5.8	146	0.8	20	25	12	80
1 hp (0.75 kW) Trigger Start - Shuttle Reverse												
SSD10P3S	400	45.2	300	2.6	1.17	7.5	191	0.8	20	30	14	80
SSD10P5S	325	36.7	500	2.6	1.17	7.5	191	0.8	20	30	14	80
SSD10P7S	220	24.9	700	2.6	1.17	7.5	191	0.8	20	30	14	80
SSD10P12S	145	16.4	1200	2.6	1.17	7.5	191	0.8	20	30	14	80
SSD10P20S	80	9	2000	2.2	0.98	6.5	165	0.8	20	30	14	80
SSD10P25S	58	6.6	2500	2.2	0.98	6.5	165	0.8	20	30	14	80
1 hp (0.75 kW) - Stall Rapid Reverse												
SSD10P20SRR	80	9	2000	2.2	0.98	6.5	165	0.8	20	30	14	80

General: Air Inlet Size: 1/4" NPT • Recommended Hose Size: 1/4" (6 mm) (1OM series); 3/8" (10 mm) • Performance rated @ 90 psig (6.2 bar) air pressure

Standard Equipment: Parts List • Safety and Instruction Manual • Comfort Grip

Accessories: Screwdriver Accessories, Screwdriver Bits and Finders see pages 685

**PERFORMANCE:**

Torque: 24 in lb (2.7 Nm) – 400 in lb (45.2 Nm)
Speed: 300 rpm – 2500 rpm

FEATURES:

Reversible
Lever Start
Rear Exhaust
Suspension Bail
1/4" Quick Change

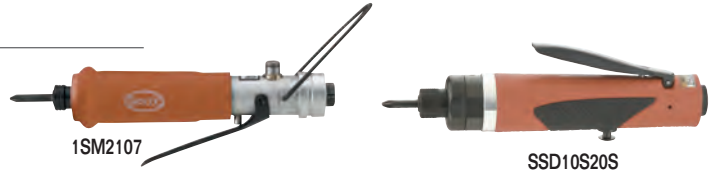
**STALL INLINE SCREWDRIVERS**

Model Number	Max Torque (Soft Joint)		Free Speed rpm	Weight		Length		Side To Center		Air Consumption		Sound Level dB(A)
	in lb	Nm		lb	kg	in	mm	in	mm	cfm	l/s	
Inline – Reversible – 1/4" Quick Change Drive												
1SM2107	55	6.2	800	1.4	0.60	9.1	231	0.6	15	8	4	75
1SM2407	24	2.7	2200	1.3	0.60	8.1	206	0.6	15	8	4	75
Inline – Stall Clutch												
SSD10S3S	400	45.2	300	2.2	1.00	9.5	240	0.8	20	30	14	80
SSD10S5S	325	36.7	500	2.2	1.00	9.5	240	0.8	20	30	14	80
SSD10S7S	220	24.9	700	2.2	1.00	9.5	240	0.8	20	30	14	80
SSD10S12S	145	16.4	1200	2.2	1.00	9.5	240	0.8	20	30	14	80
SSD10S20S	80	9	2000	1.9	0.85	8.4	215	0.8	20	30	14	80
SSD10S25S	58	6.6	2500	1.9	0.85	8.4	215	0.8	20	30	14	80

General: Air Inlet Size: 1/4" NPT • Recommended Hose Size: 1/4" (6 mm) (1SM series); 3/8" (10 mm) (SSD series) • Performance rated @ 90 psig (6.2 bar) air pressure

Standard Equipment: Parts List • Safety and Instruction Manual • Comfort Grip (1SM series) • Suspension Bail

Accessories: Screwdriver Accessories, Screwdriver Bits and Finders see page 685

PERFORMANCE:

Torque: 20 in lb (2.3 Nm) – 140 in lb (15.8 Nm)
Speed: 300 rpm – 2500 rpm

FEATURES:

Reversible
Trigger Start
Rapid or Shuttle Reverse
Comfort Grip

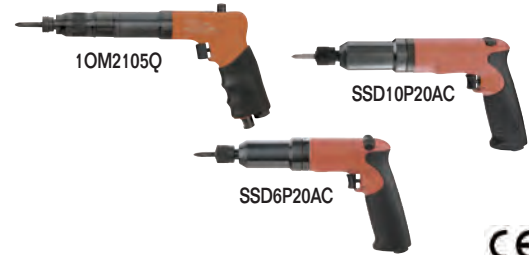
**ADJUSTABLE CLUTCH PISTOL GRIP SCREWDRIVERS**

Model Number	Max Torque (Soft Joint)		Free Speed rpm	Weight		Length		Side To Center		Air Consumption		Sound Level dB(A)
	in lb	Nm		lb	kg	in	mm	in	mm	cfm	l/s	
Trigger Start – Rapid Reverse												
1OM2105Q	50	5.7	725	2.1	0.95	8.8	224	0.7	17	8	4	75
1OM2205Q	35	4	1000	2.1	0.95	8.8	224	0.7	17	8	4	75
1OM2305Q	25	2.8	1400	2.1	0.95	8.8	224	0.7	17	8	4	75
1OM2405Q	20	2.3	2000	1.9	0.86	7.8	198	0.7	17	8	4	75
0.6 hp (0.45 kW) Trigger Start – Shuttle Reverse												
SSD6P7AC	140	15.8	700	3	1.36	10.3	262	0.8	20	25	12	80
SSD6P12AC	100	11.3	1200	3	1.36	10.3	262	0.8	20	25	12	80
SSD6P20AC	55	6.2	2000	2.6	1.16	8.5	216	0.8	20	25	12	80
SSD6P25AC	40	4.5	2500	2.6	1.16	8.5	216	0.8	20	25	12	80
1 hp (0.75 kW) Trigger Start – Shuttle Reverse												
SSD10P3AC	140	15.8	300	3.2	1.45	10.2	259	0.8	20	30	14	80
SSD10P5AC	140	15.8	500	3.2	1.45	10.2	259	0.8	20	30	14	80
SSD10P7AC	140	15.8	700	3.2	1.45	10.2	259	0.8	20	30	14	80
SSD10P12AC	120	13.5	1200	3.2	1.45	10.2	259	0.8	20	30	14	80
SSD10P20AC	80	9	2000	2.8	1.25	8.4	213	0.8	20	30	14	80
SSD10P25AC	60	6.8	2500	2.8	1.25	8.4	213	0.8	20	30	14	80

General: Air Inlet Size: 1/4" NPT • Recommended Hose Size: 1/4" (6 mm) (1OM series); 3/8" (10 mm) • Performance rated @ 90 psig (6.2 bar) air pressure

Standard Equipment: Parts List • Safety and Instruction Manual • Comfort Grip • Clutch Adjustment Wrench

Accessories: Screwdriver Accessories, Screwdriver Bits and Finders see page 685





PERFORMANCE:

Torque: 20 in lb (2.3 Nm) – 140 in lb (15.8 Nm)
Speed: 300 rpm – 2500 rpm

FEATURES:

Reversible
Rear Exhaust
External Clutch Adjustment

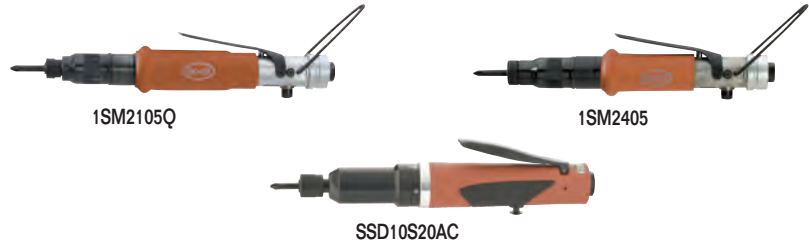

ADJUSTABLE CLUTCH INLINE SCREWDRIVERS



Model Number		Max Torque (Soft Joint)		Free Speed	Weight		Length		Side To Center		Air Consumption		Sound Level
1/4" Quick Change	1/4" Internal Hex	in lb	Nm	rpm	lb	kg	in	mm	in	mm	cfm	l/s	dB(A)
Inline – Lever Start													
		50	5.7	800	1.6	0.70	10.3	262	0.6	15	8	4	75
		35	4	1100	1.6	0.70	10.3	262	0.6	15	8	4	75
		25	2.8	1500	1.6	0.70	10.3	262	0.6	15	8	4	75
	1SM2405	20	2.3	2200	1.4	0.60	9.3	236	0.6	15	8	4	75
Inline – Lever Start													
		140	15.8	300	2.8	1.25	12.3	315	0.8	20	30	14	80
		140	15.8	500	2.8	1.25	12.3	315	0.8	20	30	14	80
		140	15.8	700	2.8	1.25	12.3	315	0.8	20	30	14	80
		120	13.5	1200	2.8	1.25	12.3	315	0.8	20	30	14	80
		80	9	2000	2.5	1.15	11.2	285	0.8	20	30	14	80
		60	6.8	2500	2.5	1.15	11.2	285	0.8	20	30	14	80

General: Air Inlet Size: 1/4" NPT • Recommended Hose Size: 1/4" (6 mm) (1SM series); 3/8" (10 mm) (SSD series) • Performance rated @ 90 psig (6.2 bar) air pressure

Standard Equipment: Parts List • Safety and Instruction Manual • Comfort Grip (1SM series) • Suspension Bail • Clutch Adjustment Wrench

Accessories: Screwdriver Accessories, Screwdriver Bits and Finders see page 685

PERFORMANCE:

Torque: 5 in lb (0.6 Nm) – 50 in lb (5.5 Nm)
Speed: 300 rpm – 2800 rpm

FEATURES:

Push-to-Start
Reversible
Locking Button Reverse
External Clutch Adjustment



TORQUE CONTROL SCREWDRIVERS



Model Number		Max Torque (Soft Joint)		Free Speed	Weight		Length		Side To Center		Air Consumption		Sound Level
1/4" Quick Change		in lb	Nm	rpm	lb	kg	in	mm	in	mm	cfm	l/s	dB(A)
Inline – Push To Start													
		5-50	0.6-5.5	800	1.6	0.7	9.3	236	0.6	15	8	4	75
		5-35	0.6-4	1100	1.6	0.7	9.3	236	0.6	15	8	4	75
		5-25	0.6-3	1500	1.6	0.7	9.3	236	0.6	15	8	4	75
		5-14	0.6-1.5	2800	1.4	0.6	8.3	211	0.6	15	8	4	75
Pistol Grip – Push To Start													
		5-50	0.6-5.5	725	2.1	1.0	8.8	225	0.7	17	10	5	75
		5-35	0.6-4	1000	2.1	1.0	8.8	225	0.7	17	10	5	75
		5-25	0.6-3	1400	2.1	1.0	8.8	225	0.7	17	10	5	75
		5-14	0.6-1.5	2600	1.9	0.9	7.8	200	0.7	17	10	5	75

General: Air Inlet Size: 1/4" NPT • Recommended Hose Size: 1/4" (6 mm) (1OT, 1ST series) • Performance rated @ 90 psig (6.2 bar) air pressure

Standard Equipment: Parts List • Safety and Instruction Manual • Comfort Grip (1OT, 1ST series) • Suspension Bail (Inline models)

Accessories: Screwdriver Accessories, Screwdriver Bits and Finders see page 685



PERFORMANCE:

Torque: 36 in lb (4.1 Nm) –
70 in lb (7.9 Nm)
Speed: 1000 rpm – 2200 rpm

FEATURES:

Lever Start
Rear Exhaust

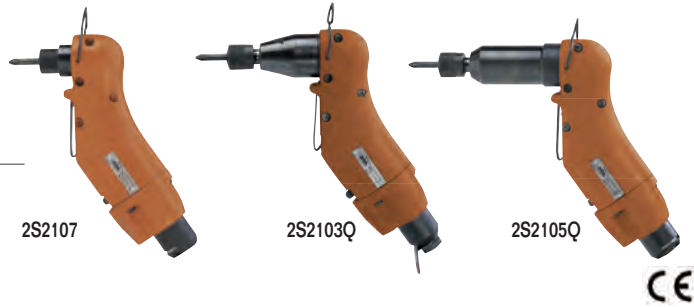

Z-HANDLE SCREWDRIVERS

Model Number	Max Torque ¹ (Soft Joint)		Free Speed	Weight		Length		Side To Center		Air Consumption		Sound Level	
	1/4" Quick Change	in lb		Nm	lb	kg	in	mm	in	mm	cfm		l/s
Z-Handle – Stall													
2S2107		70	7.9	1000	2.3	1	2.9	74	0.9	23	16	8	75
2S2207		50	5.7	1600	2.3	1	2.9	74	0.9	23	16	8	75
2S2307		36	4.1	2200	2.3	1	2.9	74	0.9	23	16	8	75
Z-Handle – Low Torque Clutch¹													
2S2103Q		60	6.8	1000	2.6	1.2	4.3	109	0.9	23	16	8	75
Z-Handle – Mid-Torque Clutch¹													
2S2103AQ		60	6.8	1000	2.6	1.2	4.3	109	0.9	23	16	8	75
2S2203AQ		46	5.2	1600	2.6	1.2	4.3	109	0.9	23	16	8	75
2S2303AQ		30	3.4	2200	2.6	1.2	4.3	109	0.9	23	16	8	75
Z-Handle – Lever Start – Adjustable Clutch													
2S2105Q		60	6.8	1000	2.9	1.3	5.8	147	0.9	23	16	8	75
2S2305Q		30	3.4	2200	2.9	1.3	5.8	147	0.9	23	16	8	75

¹ Torque output varies with force exerted by operator

General: Air Inlet Size: 1/4" NPT • Recommended Hose Size: 3/8" (10 mm) • Performance rated @ 90 psig (6.2 bar) air pressure

Standard Equipment: Parts List • Safety and Instruction Manual • Suspension Bail

Accessories: Screwdriver Accessories, Screwdriver Bits and Finders see page 685



1AM2105



SSD10A10S

PERFORMANCE:

Torque: 35 in lb (4 Nm) –
400 in lb (45.2 Nm)
Speed: 300 rpm – 2000 rpm

FEATURES:

Stall Drive & Adjustable Clutch
Button Reverse
Lever Start
Rear Exhaust

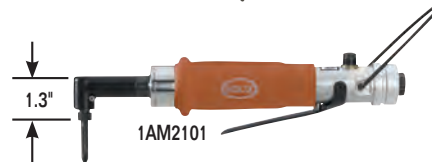

1AM2101

RIGHT ANGLE SCREWDRIVERS

Model Number	Max Torque (Soft Joint)	Free Speed	Weight		Length		Side To Center		Air Consumption		Sound Level	
			in lb	Nm	lb	kg	in	mm	in	mm		cfm
1/4" Quick Change												
1/4" Internal Hex												
Stall Drive												
1AM2101	50	5.7	800	1.5	0.70	10	254	0.3	8	8	4	75
1AM2201	35	4	1100	1.5	0.70	10	254	0.3	8	8	4	75
Stall Drive												
SSD10A3S	400	45.2	300	3.4	1.50	12	305	0.8	20	30	14	80
SSD10A5S	325	36.7	500	3.4	1.50	12	305	0.8	20	30	14	80
SSD10A6S	220	24.9	600	3.4	1.50	12	305	0.8	20	30	14	80
SSD10A10S	145	16.4	1000	3.4	1.50	12	305	0.8	20	30	14	80
SSD10A16S	80	9	1600	3	1.35	11	280	0.8	20	30	14	80
SSD10A20S	58	6.6	2000	3	1.35	11	280	0.8	20	30	14	80
Adjustable Clutch												
1AM2105	50	5.7	800	1.9	0.90	11.8	300	0.3	8	8	4	75
1AM2205	35	4	1100	1.9	0.90	11.8	300	0.3	8	8	4	75

General: Air Inlet Size: 1/4" NPT • Recommended Hose Size: 1/4" (6 mm) (1AM series); 3/8" (10 mm) (SSD series) • Performance rated @ 90 psig (6.2 bar) air pressure

Standard Equipment: Comfort Grip (1AM series)

Accessories: Screwdriver Accessories, Screwdriver Bits and Finders see page 685



WARNING



Safety Precaution: Read and follow all safety and operation instructions.
Warning: Face & eye protection must be worn while operating power tools, per ANSI B186.1.



3A2104



SNR10A10S



1AM2106

PERFORMANCE:

Torque: 20 in lb (2.3 Nm) – 600 in lb (68 Nm)
Speed: 300 rpm – 2000 rpm

FEATURES:

Reversible
Lever Start
Rear and Side Exhaust



POWER TOOLS

ASSEMBLY: NUTRUNNERS

RIGHT ANGLE NUTRUNNERS

Model Number	Bolt Capacity ²		Max Torque (Soft Joint)		Free Speed rpm	Weight		Length		Side To Center		Sound Level dB(A)	Drive Size	
	in	mm	in lb	Nm		lb	kg	in	mm	in	mm		in	mm
Torque Control Clutch														
3A2108 ¹	3/8	M10	360	41	300	7.4	3.40	18.3	465	0.8	20	81	1/2	13
3A2208 ¹	3/8	M10	294	33	480	7.4	3.40	18.3	465	0.8	20	81	1/2	13
Adjustable Clutch														
1AM2106	#10	M4.5	50	5.7	800	1.9	0.90	11.6	295	0.3	8	75	1/4	6
Stall Drive														
1AM2102	#10	M4.5	50	5.7	800	1.5	0.70	11.5	292	0.3	8	75	1/4	6
Stall Drive														
3A2104 ¹	7/16	M11	600	68	300	5.5	2.50	15.5	394	0.8	20	81	1/2	13
Stall Drive														
SNR10A3S	3/8	M10	400	45.2	300	2.9	1.30	12	305	0.8	20	80	3/8	10
SNR10A5S	3/8	M10	325	36.7	500	2.9	1.30	12	305	0.8	20	80	3/8	10
SNR10A6S	3/8	M10	220	24.9	600	2.9	1.30	12	305	0.8	20	80	3/8	10
SNR10A10S	5/16	M8	145	16.4	1000	2.9	1.30	12	305	0.8	20	80	3/8	10
SNR10A16S	1/4	M6	80	9	1600	2.6	1.15	11	280	0.8	20	80	3/8	10
SNR10A20S	#10	M4.5	58	6.6	2000	2.6	1.15	11	280	0.8	20	80	1/4	6

¹ Not CE Certified

² Bolt capacities are based on suggested assembly torques applied to SAE Grade 5 and metric Class 9.8 fasteners under slightly lubricated conditions.

General: Air Inlet Size: 1/4" NPT • Recommended Hose Size: 1/4" (6 mm) (1AM series); 3/8" (10 mm) (SNR, 3A series) • Performance rated @ 90 psig (6.2 bar) air pressure

Standard Equipment: Parts List • Safety and Instruction Manual • Comfort Grip (1AM series) • Clutch Adjustment Wrench

Accessories: Nutrunner Accessories, see page 685



PERFORMANCE:

Power: 0.3 hp (0.25 kW)
Torque: 35 ft lb (47 Nm)

FEATURES:

Lever Start
Teasing Throttle
Comfort Grip



SRW03S-25

RATCHET WRENCHES

Model Number	Drive Size		Torque		Free Speed rpm	Weight		Length		Side to Center		Sound Level dB(A)	Air Consumption		Exhaust
	in	mm	ft lb	Nm		lb	kg	in	mm	in	mm		cfm	l/s	
0.3 hp (0.25 kW)															
SRW03S-25	1/4"	6	35	47	235	1.4	0.6	7.7	197	1.1	28	85.9	1.4	0.66	Rear
SRW03S-38	3/8"	10	35	47	235	1.4	0.6	7.7	197	1.1	28	85.9	1.4	0.66	Rear
SRW03S-38Q	3/8"	10	35	47	235	1.4	0.6	7.7	197	1.1	28	85.9	1.4	0.66	Rear

General: Air Inlet Size: 1/4" NPT • Recommended Hose Size: 3/8" (10 mm) • Performance rated @ 90 psig (6.2 bar) air pressure

Standard Equipment: Parts List • Safety and Instruction Manual

Accessories: Ratchet Accessories, see page 685



SRW07-38

PERFORMANCE:

Power: 0.7 hp (0.52 kW)
Torque: 65 ft lb (88 Nm)

RATCHET WRENCHES

Model Number	Drive Size		Torque		Free Speed rpm	Weight		Length		Side to Center		Sound Level dB(A)	Air Consumption		Exhaust
	in	mm	ft lb	Nm		lb	kg	in	mm	in	mm		cfm	l/s	
0.7 hp (0.52 kW)															
SRW07-38	3/8"	10	65	88	260	3	1.3	11.8	300	1	25	90	2.7	1.27	Front
SRW07-50	1/2"	13	65	88	260	3	1.3	11.8	300	1	25	90	2.7	1.27	Front

General: Air Inlet Size: 1/4" NPT • Recommended Hose Size: 3/8" (10 mm) • Performance rated @ 90 psig (6.2 bar) air pressure

Standard Equipment: Parts List • Safety and Instruction Manual

Accessories: Ratchet Accessories, see page 685





ASSEMBLY

We're Making A Big Impact

Impact wrenches are the true workhorses of industrial power tools. These incredibly powerful tools make easy work of any job in a variety of applications. Before the creation of impact tools, workers had to manually strike a hammer against a hand wrench in order to loosen or tighten nuts or bolts. They could only manage a few blows per minute. But today's impact wrenches can exert more powerful blows, and some can produce over 2000 blows per minute. This is accomplished by using the energy of compressed air and converting the motor's torque into a rapid series of powerful rotary impacts.

CHOICE OF CONFIGURATION

Sioux Tools offers Industrial and Force Impact Wrenches and Impact Drivers in a wide variety of configurations to meet your specific applications. In order to select the correct impact tool for your job requirements, you must take into account several factors including fastener size and grade, required torque output, and accessibility. Choosing the right mix of features such as handle configuration, type of retainer, torque output, anvil length, and drive size will make operators more productive, with less risk of discomfort and/or injury.

INDUSTRIAL IMPACT TOOLS

Built to a higher level of quality, Sioux Industrial Impact Wrenches and Impact Drivers are built a step above the standard. Manufactured from the highest quality materials, and utilizing the most advanced motor and clutch designs, these tools are constructed to hold up under continuous use in the toughest working environments.

Our extensive lineup of impact tools includes a wide selection of important features including:

- Ball & Cam or Twin Hammer impact mechanisms
- Inline, pistol grip, or D-handle configurations
- Pin, friction ring, quick change, or thru hole socket retainers
- Standard or extended anvils

In addition, Sioux offers a wide range of performance levels and characteristics to ensure a perfect match to your application. With drive sizes ranging from 1/4" (6 mm) to 1-1/2" (38 mm), and torque outputs up to 2500 ft lb (3390 Nm), finding the tool to meet your performance requirements will be simple.

IMPACT WRENCH PRINCIPLES OF OPERATION

An impact wrench delivers a series of rotary blows to a fastener, producing torque.

The action of the torque creates clamp force in an assembly.

Interaction of the motor, clutch and drive-end determine the type of application an impact wrench can handle.

The advantages of impact wrenches are a high power-to weight ratio, fast rundown, and no torque reaction to operator.

CLASS OF SERVICE

High production – automobile assembly plants, farm and construction equipment, etc.

Low production – large machinery assembly

Maintenance or repair work

JOB CONDITIONS

Hard pull-up – rigid joint

Soft pull-up – spring joint

Run-down – free running, or prevailing torque (lock nut, self threading screw)

MATERIAL

Metal-to-metal

Metal/gasket

Rubber or plastic

ASSEMBLY METHOD

General tightening – operator judgment

Turn-of-the-nut – permanent assemblies (steel erection and construction equipment)

Note: If it takes five seconds or longer to reach final tightness, a larger wrench should be used.



IW38TBP-3P



IW38HAP-3P



IW50HAP-4P



IW500MP-4R

PERFORMANCE:

Working Torque: 10 ft lb (13 Nm) – 450 ft lb (610 Nm)
 Drive Size: 3/8" (10 mm) – 1/2" (13 mm) square drive
 Bolt Capacity: 1/4" (6 mm) – 5/8" (16 mm)

FEATURES:

Pistol Grip
 Steel Anvil Housing
 Suspension Bail

3/8" (10 MM) & 1/2" (13 MM) IMPACT WRENCHES

Model Number	Drive Size		Bolt Cap Grade 5	Working Torque Range ¹		Maximum Torque		Blows Per Minute	Free Speed	Weight		Length		Side To Center		Avg Air Consumption	Socket Retainer Style		
	in	mm		in	mm	ft lb	Nm			ft lb	Nm	rpm	lb	kg	in			mm	in
IW50HAP-4F	1/2	13	5/8	16	100-450	135-610	550	745	1140	7000	4.3	1.9	7.6	192	1.3	33	4	2	Ring
IW50HAP-4P	1/2	13	5/8	16	100-450	135-610	550	745	1140	7000	4.3	1.9	7.6	192	1.3	33	4	2	Pin
IW38TBP-3P	3/8	10	1/4	6	10-70	13-95	70	95	2000	8000	2.1	1.0	6.3	160	0.9	22	2	1	Pin
IW38HAP-3F	3/8	10	3/8	10	60-200	80-270	250	340	1380	10000	3.3	1.5	6.7	170	1.1	28	2	1	Ring
IW38HAP-3P	3/8	10	3/8	10	60-200	80-270	250	340	1380	10000	3.3	1.5	6.7	170	1.1	28	2	1	Pin
IW38HAP-4F	1/2	13	3/8	10	60-200	80-270	250	340	1380	10000	3.3	1.5	6.7	170	1.1	28	2	1	Ring
IW38HAP-4P	1/2	13	3/8	10	60-200	80-270	250	340	1380	10000	3.3	1.5	6.7	170	1.1	28	2	1	Pin
IW500MP-4R	1/2	13	5/8	10	100-624	135-845	780	1058	1200	9400	4.2	1.9	7	178	1.5	38	4	2	Ring
IW500MP-4P	1/2	13	5/8	10	100-624	135-845	780	1058	1200	9400	4.2	1.9	7	178	1.5	38	4	2	Pin

¹ Maximum working torque determined by 5 second rundown on appropriate Skidmore-Wilhelm Torque-Tension Tester.

General: Air Inlet Size: 1/4" NPT • Recommended Hose Size: 3/8" (10 mm) • Performance rated @ 90 psig (6.2 bar) air pressure

Standard Equipment: Parts List • Safety and Instruction Manual • Suspension Bail

Accessories: Impact Wrench Accessories, see page 685

KEY FEATURES:

High power to weight ratio
 High impact rate of 5,000 blows per minute
 Working torque range up to 95 ft/lbs
 Extended life through bearing design
 Smooth Impacting that creates minimal torque reaction
 Includes rubber boot for hammer case

APPLICATIONS:

Wood Screws
 Self-tapping screws
 Lag bolts
 High prevailing torque applications



IW375AP-3P

3/8" Pinned Anvil

3/8" Friction Ring Anvil

**3/8" (10 MM) IMPACT WRENCH**

Model Number	Drive Size		Working Torque Range ¹		Maximum Torque		Blows Per Minute	Free Speed	Weight		Length		Side To Center		Socket Retainer Style	
	in	mm	ft lb	Nm	ft lb	Nm			rpm	lb	kg	in	mm	in		mm
Pistol Grip																
IW375AP-3P	3/8	10	10-95	13-130	100	135	5000	4000	2.5	1.1	8.5	216	0.85	21	Pin	
IW375AP-3F	3/8	10	10-95	13-130	100	135	5000	4000	2.5	1.1	8.5	216	0.85	21	Ring	

¹ Maximum working torque determined by 5 second rundown on appropriate Skidmore-Wilhelm Torque-Tension Tester.

General: Air Inlet Size: 1/4" NPT • Recommended Hose Size: 3/8" (10 mm) • Performance rated @ 90 psig (6.2 bar) air pressure

Standard Equipment: Parts List • Safety and Instruction Manual

Accessories: Impact Wrench Accessories, see page 685

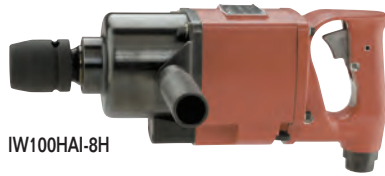

IW100HAI-8H



IW1000MP-8H



IW75BP-6H

POWER TOOLS

ASSEMBLY: IMPACT WRENCHES

PERFORMANCE:

Working Torque: 800 ft lb (1085 Nm) – 2500 ft lb (3390 Nm)
 Drive Size: 3/4" (19 mm) – 1-1/2" (38 mm)
 Bolt Capacity: 3/4" (19 mm) – 2" (50 mm)

FEATURES:

Pistol Grip and D-Handle
 Inside and Outside Trigger (D-Handle Models)
 Steel Anvil Housing



3/4" [19 MM], 1" [25 MM], 1-1/2" [38 MM] IMPACT WRENCHES

Model Number	Drive Size		Bolt Cap Grade 5		Maximum Working Torque ¹		Maximum Torque		Blows Per Minute	Free Speed rpm	Weight		Length		Side To Center		Avg Air Consumption		Socket Retainer Style	
	in	mm	in	mm	ft lb	Nm	ft lb	Nm			lb	kg	in	mm	in	mm	cfm	l/s		
Pistol Grip																				
IW75BP-6H	3/4	19	3/4	19	800	1085	1000	1356	1000	5700	11.6	5.3	7.6	193	1.75	45	15	7	Hole	
IW75BP-8H	1	25	3/4	19	825	1119	1100	1492	1000	5700	11.7	5.3	7.6	193	1.75	45	15	7	Hole	
D-Handle - Inside Trigger																				
IW1000MP-8H	1	25	1 1/4	32	1200	1630	1700	2300	825	6500	18.2	8.3	14.8	376	1.85	47	34	16	Hole/Ring	
IW1000MP-8H5	1	25	1 1/4	32	1200	1630	1700	2300	825	6500	19.7	8.9	19.3	490	1.85	47	34	16	Hole/Ring	
IW100HAI-8H	1	25	1 3/8	35	1600	2170	2000	2710	850	5000	22	10	12.4	315	2	51	38	18	Hole	
IW100HAI-8H6	1	25	1 3/8	35	1600	2170	2000	2710	850	5000	26.2	11.8	18.4	467	2	51	38	18	Hole	
IW100HAI-5S	#5 Spline	1 3/8	35	1600	2170	2000	2710	850	5000	22	10	12.4	315	2	51	38	18	18	Hole	
IW100HAI-5S6	#5 Spline	1 3/8	35	1600	2170	2000	2710	850	5000	26.2	11.8	18.4	467	2	51	38	18	18	Hole	
IW150HAI-5S	#5 Spline	2	50	2500	3390	3000	4070	650	3750	33	15	14.5	368	2.5	65	60	28	28	Hole	
IW150HAI-12H	1 1/2	38	2	50	2500	3390	3000	4070	650	3750	33.1	15	14.5	368	2.5	65	60	28	28	Hole
D-Handle - Outside Trigger																				
IW100HAO-8H	1	25	1 3/8	35	1600	2170	2000	2710	850	5000	22	10	12.4	315	2	51	38	18	18	Hole
IW100HAO-8H6	1	25	1 3/8	35	1600	2170	2000	2710	850	5000	26.2	11.8	18.4	467	2	51	38	18	18	Hole
IW100HAO-5S	#5 Spline	1 3/8	35	1600	2170	2000	2710	850	5000	22	10	12.4	315	2	51	38	18	18	18	Hole
IW100HAO-5S6	#5 Spline	1 3/8	35	1600	2170	2000	2710	850	5000	26.2	11.8	18.4	467	2	51	38	18	18	18	Hole
IW150HAO-5S	#5 Spline	2	50	2500	3390	3000	4070	650	3750	33	15	14.5	368	2.5	65	60	28	28	28	Hole
IW150HAO-12H	1 1/2	38	2	50	2500	3390	3000	4070	650	3750	33	15	14.5	368	2.5	65	60	28	28	Hole

¹ Maximum working torque determined by 5 second rundown on appropriate Skidmore-Wilhelm Torque-Tension Tester.

General: Air Inlet Size: 3/8" NPT (IW75 series) • Air Inlet Size: 1/2" NPT (IW100 & IW150 series) • Recommended Hose Size: 1/2" (30 mm) • Performance rated @ 90 psig (6.2 bar) air pressure

Standard Equipment: Parts List • Safety and Instruction Manual • Suspension Bail (IW75 models) • Support handle (D-Handle models)

Accessories: Impact Wrench Accessories, see page 685

PERFORMANCE:

Maximum Torque: 1050 ft lb (1423 Nm)
 Drive Size: 3/4" (19 mm)

FEATURES:

Light weight composite housing with aluminum nose
 Increased power through motor & impact mechanism designs
 Grease Clutch
 Reverse biased
 One hand Forward / Reverse operation
 Through Hole Retainer
 Pinned Anvil Retainer
 Friction Ring Retainer



IW750MP-6P



HEAVY DUTY IMPACT WRENCHES

Model Number	Drive Size		Maximum Torque		Blows Per Minute	Free Speed rpm	Weight		Length		Air Consumption (Free Speed)		Socket Retainer Style
	in	mm	ft lb	Nm			lb	kg	in	mm	cfm	l/min	
Pistol Grip 3/4" Impact Wrench													
IW750MP-6P	3/4	19	1050	1423	1050	6700	7.5	3.44	8.5	215	5.6	159	Pin
IW750MP-6H	3/4	19	1050	1423	1050	6700	7.5	3.44	8.5	215	5.6	159	Hole
IW750MP-6R	3/4	19	1050	1423	1050	6700	7.5	3.44	8.5	215	5.6	159	Friction Ring

¹ Maximum working torque determined by 5 second rundown on appropriate Skidmore-Wilhelm Torque-Tension Tester.

General: 3/4" Anvil: Air Inlet Size: 3/8"-18 NPT • Recommended Hose Size: 3/8" (10 mm) • Performance rated @ 90 psig (6.2 bar) air pressure

Accessories: Impact Wrench Accessories, see page 685



IW38TBP-2Q



IW38HAP-7Q

PERFORMANCE:

Torque: 10 ft lb (13 Nm) – 200 ft lb (270 Nm)
 Drive Size: 1/4" (6 mm) hex – 7/16" (11 mm) hex
 Bolt Capacity: 1/4" (6 mm) – 3/8" (10 mm)

FEATURES:

Pistol Grip
 Steel Anvil Housing
 Suspension Bail
 Quick Change Bit Retainer



IMPACT DRIVERS

Model Number	Drive Size		Bolt Cap Grade 5		Working Torque Range ¹		Maximum Torque		Blows Per Minute	Free Speed rpm	Weight		Length		Side To Center		Avg Air Consumption		Socket Retainer Style
	in	mm	in	mm	ft lb	Nm	ft lb	Nm			lb	kg	in	mm	in	mm	cfm	l/s	
Pistol Grip – Trigger Start																			
IW38HAP-7Q	7/16	11	3/8	10	60-200	80-270	250	340	1380	10,000	3.3	1.5	6.7	170	1.1	28	2	1	QC
IW38TBP-2Q	1/4	6	1/4	6	10-70	13-95	70	95	2000	8000	2.1	1	6.3	160	0.9	22	2	1	QC

¹ Maximum working torque determined by 5 second rundown on appropriate Skidmore-Wilhelm Torque-Tension Tester

General: Air Inlet Size: 1/4" NPT • Recommended Hose Size: 3/8" (10 mm) • Performance rated @ 90 psig (6.2 bar) air pressure

Standard Equipment: Parts List • Safety and Instruction Manual • Suspension Bail

Accessories: Impact Driver Accessories, see page 685



ID375AP-2Q



ID375AP-2QRR

KEY FEATURES:

High power to weight ratio
 High impact rate of 5,000 blows per minute
 Working torque range up to 95 ft/lbs
 Extended life through bearing design
 Smooth Impacting that creates minimal torque reaction
 includes rubber boot for hammer case

APPLICATIONS:

Wood Screws
 Self-tapping screws
 Lag bolts
 High prevailing torque applications



1/4" Quick Change

1/4" (6 MM) IMPACT DRIVER

Model Number	Drive Size		Working Torque Range ¹		Maximum Torque		Blows Per Minute	Free Speed rpm	Weight		Length		Side To Center		Socket Retainer Style
	in	mm	ft lb	Nm	ft lb	Nm			lb	kg	in	mm	in	mm	
ID375AP-2Q	1/4	6	10-55	13-75	60	80	5000	4000	2.5	1.1	8.5	216	085	21	Quick Change
ID375AP-2QRR	1/4	6	10-55	13-75	60	80	5000	4000	2.5	1.1	8.5	216	085	21	Quick Change

¹ Maximum working torque determined by 5 second rundown on appropriate Skidmore-Wilhelm Torque-Tension Tester.

General: Air Inlet Size: 1/4" NPT • Recommended Hose Size: 3/8" (10 mm) • Performance rated @ 90 psig (6.2 bar) air pressure

Standard Equipment: Parts List • Safety and Instruction Manual

Accessories: Impact Wrench Accessories, see page 685





CLUTCH SPRINGS

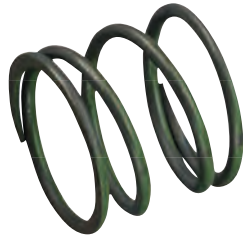

41284

Part Number	Color	Torque Range	
		in lb	Nm
SSD, SD9A, 2 Series Adjustable Clutch			
41284	Green	<25	<2.8
21427	N/A	>25	>2.8
1 Series Adjustable Clutch			
66048	Silver	30-50	3.4-5.7
66049	Blue	15-35	1.7-4
66050	Green	2-20	0.22-2.3
2 Series Torque Control Clutch			
65048	Silver	60-280	6.8-32
65049	Blue	36-180	4.1-20
65050	Green	30-120	3.4-14



66193

COMFORT GRIPS

Part Number	For Use On
66124	1 Series inline (except 2800 rpm)
66193	1 Series inline (2800 rpm)
68340	1 Series pistol grip



IW500-3



74994A

TETHER PLATE KITS

Part Number	For Use On
IW500-3	IW500MP
74994A	IW750MP

ABRASIVE



Make Easy Work Out Of A Daily Grind

As manufacturing materials advance, so do the requirements for the tools to work on them. This means new speeds and attachments to handle the demands of increased precision and waste reduction.

THE RIGHT TOOL FOR THE JOB

When selecting a grinder and accessories for your application, be sure to choose one with enough horsepower to drive the abrasive wheel you are using. This will allow the grinder's speed to work for you. When the operator bears down on an under-powered tool, it slows the rpm output and reduces overall efficiency.



INDUSTRIAL GRINDERS

Sioux has a great selection of inline and right angle grinders with collet sizes from 1/4" to 1/2" & 3 mm – 8 mm for a variety of applications. Speeds range up to 25,000 rpm to get the job done quickly and efficiently. Some models offer a choice of throttle control that is most convenient and comfortable for the operator. We also have extended models that fit into tight, hard to reach places.

ABRASIVE GRINDERS PRINCIPLES OF OPERATION

When wheels, pads or other accessories are attached to the spindle, the tool can be used to remove metal or composites in a variety of ways.

ABRASIVE SAFETY

Grinders can cause flying particles. Proper eye protection must be worn at all times by tools user and bystanders.

Under improper use and wear, Air grinders can cause serious injury and death. The following instructions are important and should be followed explicitly but cannot cover all contingencies. Good judgment is always required.

Using a grinder without a guard can cause injury. The grinder is to be operated with an appropriate guard at all times when a grinding wheel is used. Replace a damaged guard. The guard is to be the proper one for the wheel being used.

Damaged grinding wheels can explode. Check the wheel for damage before mounting, such as chips and cracks. Handle wheels carefully to avoid dropping or bumping. Protect wheels from extremes of temperature and humidity. Check wheels immediately after any unusual occurrence that may damage wheels.



Over speeding wheels can explode. Check the speed rating of the accessory or the speed printed on the wheel. This speed must be greater than the name plate speed of the grinder/sander and the actual speed of the grinder/sander as measured with a tachometer.

Unsecured work can move violently when grinding. Secure work; use clamps or vise to hold work.

Grinders may coast for a short time after the trigger is released. Be sure tool has come to a complete stop before setting it aside.

Grinding wheels that malfunction or spin off can cause injury. Be certain that all wheel, flanges, nuts and related equipment are in good shape, the proper ones for the type and size of wheel being used, and are securely fastened.

Exploding wheels can cause injury or death. If the normal sound of the grinder changes, or if it vibrates excessively, shut it off immediately, remove the wheel, and check speed with tachometer.

Unexpected starts can cause injury. Be sure actuator is off before hooking up air.

Breathing grinding dust can cause injury. Do not breathe grinding dust. Use approved mask.

Explosions and fire can cause injury. Only grind metals if the area is free of combustible or explosive materials or vapors.

Contact with rotating grinding wheels can cause injury. Keep hands and other body parts away from grinding wheels and sanding pads and disks to prevent cutting or pinching. Wear protective clothing and gloves to protect hands.

Tools starting unexpectedly can cause injury. Always remove tool from air supply and activate trigger to bleed air line before making any adjustments, changing accessories, or doing any maintenance or service on the tool.

Flying grinding wheels or accessories can cause injury. Tighten collet securely. Match wheel or accessory shaft diameter to chuck or collet.

Exploding or flying parts can cause injury. Do not use cut off wheels or router bits with die grinders.





Double Ball Bearing Support On Output Spindle

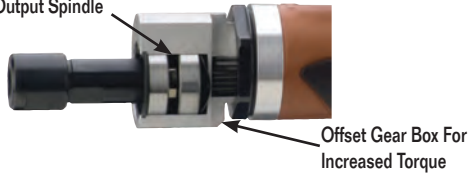

Offset Gear Box For Increased Torque



SDG10SHT12

SDG10SHT08



POWER TOOLS

ABRASIVE: GRINDERS

HIGH TORQUE DIE GRINDERS

Model Number	Free Speed	Weight		Length		Sound Level dB(A)	Air Consumption		Collet Size	Exhaust
	rpm	lb	kg	in	mm		cfm	l/s		
1 hp (0.75 kW) – Lever Throttle – High Torque										
SDG10SHT08	8000	2	0.90	9.5	240	85.1	35	16.5	1/4"	Rear
SDG10SHT08M6	8000	2	0.90	9.5	240	85.6	35	16.5	6 mm	Rear
SDG10SHT12	12,000	2	0.90	9.5	240	81.8	35	16.5	1/4"	Rear
SDG10SHT12M6	12,000	2	0.90	9.5	240	84	35	16.5	6 mm	Rear

General: Air Inlet Size: 1/4" NPT • Recommended Hose Size: 3/8" (10 mm) • Performance rated @ 90 psig (6.2 bar) air pressure

Standard Equipment: Parts List • Safety and Instruction Manual • Collet & Wrenches

Accessories: Grinder Accessories, see page 698



RT1985

PERFORMANCE:

Power: 1.5 hp (1.1 kW)
Speed: 20,000 rpm
Collet Size: 1/4" – 1/2" & 6 mm

FEATURES:

Twist Throttle
Side Exhaust
Built-in Speed Control

STRAIGHT DIE GRINDERS



Model Number	Free Speed	Weight		Length		Sound Level dB(A)	Air Consumption		Collet Size	Exhaust
	rpm	lb	kg	in	mm		cfm	l/s		
1.5 hp (1.1 kW) – Twist Throttle										
RT1985 ¹	20,000	4.3	2	7.6	193	84	38	18	1/4"	Side
1985-1/2	20,000	4.3	2	7.6	193	84	38	18	1/2"	Side
1985A	20,000	4.3	2	7.6	193	84	38	18	3/8"	Side

¹Not CE Certified

General: Air Inlet Size: 1/4" NPT • Recommended Hose Size: 3/8" (10 mm) • Performance rated @ 90 psig (6.2 bar) air pressure

Standard Equipment: Parts List • Safety and Instruction Manual • Collet & Wrenches • Collet Guard (1DS series)

Accessories: Grinder Accessories, see page 698



SDG03S25



SDG05S23



SDG7S25F



SDG10S25F

PERFORMANCE:

Power: 0.3 hp (0.2 kW) – 1 hp (0.75 kW)
 Speed: 12,000 rpm – 25,000 rpm
 Collet Size: 1/4" & 6 mm

FEATURES:

Lockoff Lever
 Front or Rear Exhaust
 Built-in Speed Control



STRAIGHT DIE GRINDERS

Model Number	Free Speed	Weight		Length		Sound Level dB(A)	Air Consumption		Collet Size	Exhaust
	rpm	lb	kg	in	mm		cfm	l/s		
0.3 hp (0.22 kW) – Lever Throttle – 200 Series Collet										
SDG03S25	25,000	1	0.45	6.25	160	84.3	11	5.2	1/4"	Rear
SDG03S25M6	25,000	1	0.45	6.25	160	83.3	11	5.2	6 mm	Rear
0.3 hp (0.22 kW) – Lever Throttle – 300 Series Collet										
SDG03S25S	25,000	1	0.45	6.25	160	83.3	11	5.2	1/4"	Rear
SDG03S25M6S	25,000	1	0.45	6.25	160	83.3	11	5.2	6mm	Rear
0.5 hp (0.37 kW) – Lever Throttle – 200 Series Collet										
SDG05S18	18,000	1.2	0.54	7	180	82.4	23	10.9	1/4"	Rear
SDG05S18M6	18,000	1.2	0.54	7	180	87.4	23	10.9	6 mm	Rear
SDG05S23	23,000	1.2	0.54	7	180	87.7	23	10.9	1/4"	Rear
SDG05S23M6	23,000	1.2	0.54	7	180	85.1	23	10.9	6 mm	Rear
0.5 hp (0.37 kW) – Lever Throttle – 300 Series Collet										
SDG05S18S	18,000	1.2	0.54	7	180	87.4	23	10.9	1/4"	Rear
SDG05S18M6S	18,000	1.2	0.54	7	180	87.4	23	10.9	6mm	Rear
SDG05S23S	23,000	1.2	0.54	7	180	85.1	23	10.9	1/4"	Rear
SDG05S23M6S	23,000	1.2	0.54	7	180	85.1	23	10.9	6mm	Rear
0.7 hp (0.52 kW) – Lever Throttle – 200 Series Collet										
SDG7S18F	18,000	1.2	0.6	6	150	85	25	12	1/4"	Front
SDG7S18M6F	18,000	1.2	0.6	6	150	82	25	12	6 mm	Front
SDG7S25F	25,000	1.2	0.6	6	150	82.3	25	12	1/4"	Front
SDG7S25FS	25,000	1.2	0.6	6	150	82	25	12	1/4"	Front
SDG7S25M6F	25,000	1.2	0.6	6	150	82	25	12	6 mm	Front
1 hp (0.75 kW) – Lever Throttle – 200 Series Collet										
SDG10S12F	12,000	1.7	0.8	7.5	190	85.1	30	14	1/4"	Front
SDG10S12M6F	12,000	1.7	0.8	7.5	190	78	30	14	6 mm	Front
SDG10S12R	12,000	1.7	0.8	7.5	190	84.4	30	14	1/4"	Rear
SDG10S12M6R	12,000	1.7	0.8	7.5	190	78	30	14	6 mm	Rear
SDG10S18F	18,000	1.7	0.8	7.5	190	81.5	30	14	1/4"	Front
SDG10S18M6F	18,000	1.7	0.8	7.5	190	78	30	14	6 mm	Front
SDG10S18R	18,000	1.7	0.8	7.5	190	81.1	30	14	1/4"	Rear
SDG10S18M6R	18,000	1.7	0.8	7.5	190	78	30	14	6 mm	Rear
SDG10S25F	25,000	1.7	0.8	7.5	190	86.8	30	14	1/4"	Front
SDG10S25M6F	25,000	1.7	0.8	7.5	190	78	30	14	6 mm	Front
SDG10S25R	25,000	1.7	0.8	7.5	190	83.2	30	14	1/4"	Rear
SDG10S25M6R	25,000	1.7	0.8	7.5	190	78	30	14	6 mm	Rear

General: Air Inlet Size: 1/4" NPT • Recommended Hose Size: 3/8" (10 mm) • Performance rated @ 90 psig (6.2 bar) air pressure
Standard Equipment: Parts List • Safety and Instruction Manual • Collet & Wrenches • Collet Guard (1DS series)
Accessories: Grinder Accessories, see page 698





SDGS1S18



SDGS1S18G

PERFORMANCE:

Power: 1 hp (0.75 kW)
 Speed: 12,000 rpm – 25,000 rpm
 Collet Size: 1/4" & 6 mm

FEATURES:

Lockoff Lever
 Front or Rear Exhaust
 Built-in Speed Control

POWER TOOLS

ABRASIVE: GRINDERS



STRAIGHT METAL BODY DIE GRINDERS

Model Number	Free Speed		Weight		Length		Sound Level		Air Consumption		Collet Size	Exhaust
	rpm		lb	kg	in	mm	dB(A)	cfm	l/s			
1 hp (0.75 kW) – Lever Throttle – Aluminum Housing												
SDGA1S12	12,000		1.5	0.7	6.9	175	90.9	30	14		1/4"	Front
SDGA1S12M6	12,000		1.5	0.7	6.9	175	91	30	14		6 mm	Front
SDGA1S18	18,000		1.5	0.7	6.9	175	87.4	30	14		1/4"	Front
SDGA1S18M6	18,000		1.5	0.7	6.9	175	87	30	14		6 mm	Front
SDGA1S25	25,000		1.5	0.7	6.9	175	86.2	30	14		1/4"	Front
SDGA1S25M6	25,000		1.5	0.7	6.9	175	86	30	14		6 mm	Front
1 hp (0.75 kW) – Lever Throttle – Aluminum Housing with Grip												
SDGA1S12G	12,000		1.4	0.6	6.9	175	91.3	30	14		1/4"	Front
SDGA1S12M6G	12,000		1.4	0.6	6.9	175	91	30	14		6 mm	Front
SDGA1S18G	18,000		1.4	0.6	6.9	175	86.8	30	14		1/4"	Front
SDGA1S18M6G	18,000		1.4	0.6	6.9	175	86	30	14		6 mm	Front
SDGA1S25G	25,000		1.4	0.6	6.9	175	85.4	30	14		1/4"	Front
SDGA1S25M6G	25,000		1.4	0.6	6.9	175	85	30	14		6 mm	Front
1 hp (0.75 kW) – Lever Throttle – Steel Housing												
SDGS1S12	12,000		2.2	1	6.9	175	90.4	30	14		1/4"	Front
SDGS1S12M6	12,000		2.2	1	6.9	175	90	30	14		6 mm	Front
SDGS1S18	18,000		2.2	1	6.9	175	85.8	30	14		1/4"	Front
SDGS1S18M6	18,000		2.2	1	6.9	175	85	30	14		6 mm	Front
SDGS1S25	25,000		2.2	1	6.9	175	85.1	30	14		1/4"	Front
SDGS1S25M6	25,000		2.2	1	6.9	175	85	30	14		6 mm	Front
1 hp (0.75 kW) – Lever Throttle – Steel Housing with Grip												
SDGS1S12G	12,000		1.8	0.8	6.9	175	92.8	30	14		1/4"	Front
SDGS1S12M6G	12,000		1.8	0.8	6.9	175	92	30	14		6 mm	Front
SDGS1S18G	18,000		1.8	0.8	6.9	175	86.5	30	14		1/4"	Front
SDGS1S18M6G	18,000		1.8	0.8	6.9	175	86	30	14		6 mm	Front
SDGS1S25G	25,000		1.8	0.8	6.9	175	85.4	30	14		1/4"	Front
SDGS1S25M6G	25,000		1.8	0.8	6.9	175	82	30	14		6 mm	Front

General: Air Inlet Size: 1/4" NPT • Recommended Hose Size: 3/8" (10 mm) • Performance rated @ 90 psig (6.2 bar) air pressure

Standard Equipment: Parts List • Safety and Instruction Manual • Collet & Wrenches

Accessories: Grinder Accessories, see page 698



SXG05S23



STXG10S23

PERFORMANCE:

Power: 0.5 hp (0.37 kW) – 1 hp (0.75 kW)
 Speed: 12,000 rpm – 23,000 rpm
 Collet Size: 1/4" (6 mm)

FEATURES:

Heavy duty double tapered collet
 Ergonomic comfort grip
 Teasing throttle for maximum control
 Lever throttle with lock-off
 Ball bearing construction
 Adjustable speed control

POWER TOOLS

ABRASIVE: GRINDERS

EXTENDED DIE GRINDERS



Model Number	Free Speed		Weight		Length		Sound Level dB(A)	Air Consumption		Collet Size	Exhaust
	rpm		lb	kg	in	mm		cfm	l/s		
0.5 hp (0.37 kW) – Lever Throttle – Extended – 200 Series Collet											
SXG05S18	18,000		2.1	0.95	11	280	85.8	23	10.9	1/4"	Rear
SXG05S18M6	18,000		2.1	0.95	11	280	86.7	23	10.9	6 mm	Rear
SXG05S23	23,000		2.1	0.95	11	280	89.8	23	10.9	1/4"	Rear
SXG05S23M6	23,000		2.1	0.95	11	280	85.9	23	10.9	6 mm	Rear
0.5 hp (0.37 kW) – Extended Die Grinder Lever Throttle – 300 Series Collet											
SXG05S18S	18,000		2.1	0.95	11	280	86.7	23	10.9	1/4"	Rear
SXG05S18M6S	18,000		2.1	0.95	11	280	86.7	23	10.9	6mm	Rear
SXG05S23S	23,000		2.1	0.95	11	280	85.9	23	10.9	1/4"	Rear
SXG05S23M6S	23,000		2.1	0.95	11	280	85.9	23	10.9	6mm	Rear
1 hp (0.75 kW) – Lever Throttle – Extended – 200 Series Collet											
STXG10S12	12,000		2.2	1	12.1	308	84.5	30	14	1/4"	Rear
STXG10S12M6	12,000		2.2	1	12.1	308	78	30	14	6 mm	Rear
STXG10S18	18,000		2.2	1	12.1	308	82	30	14	1/4"	Rear
STXG10S18M6	18,000		2.2	1	12.1	308	78	30	14	6 mm	Rear
STXG10S23	23,000		2.2	1	12.1	308	78	30	14	1/4"	Rear
STXG10S23M6	23,000		2.2	1	12.1	308	81.6	30	14	6 mm	Rear
1 hp (0.75 kW) – Lever Throttle – Extended – Cone Wheel											
STXG10S18CW	18,000		2.2	1	12.2	310	82	30	14	N/A	Rear

General: Air Inlet Size: 1/4" NPT • Recommended Hose Size: 3/8" (10 mm) • Performance rated @ 90 psig (6.2 bar) air pressure

Standard Equipment: Parts List • Safety and Instruction Manual • Collet & Wrenches • Collet Guard (1DS series)

Accessories: Grinder Accessories, see page 698





SAG03S20



SAG03S12S



SAG05S23



SAG7S15



SAG10S18

POWER TOOLS

ABRASIVE: GRINDERS

PERFORMANCE:

Power: 0.33 hp (0.25 kW) – 1 hp (0.75 kW)
 Speed: 12,000 rpm – 20,000 rpm
 Collet Size: 1/4" & 6 mm

FEATURES:

Lockoff Lever
 Rear Exhaust
 Built-in Speed Control

RIGHT ANGLE DIE GRINDERS



Model Number	Free Speed		Weight		Length		Sound Level		Air Consumption		Collet Size	Exhaust
	rpm		lb	kg	in	mm	dB(A)		cfm	l/s		
0.3 hp (0.22 kW) – Lever Throttle – 200 Series Collet												
SAG03S12	12,000		1.2	0.55	5.625	140	81.5		11	5.2	1/4"	Rear
SAG03S12M6	12,000		1.2	0.55	5.625	140	82.3		11	5.2	6 mm	Rear
SAG03S20	20,000		1.2	0.55	5.625	140	86.4		11	5.2	1/4"	Rear
SAG03S20M6	20,000		1.2	0.55	5.625	140	85.9		11	5.2	6 mm	Rear
0.3 hp (0.22 kW) – Lever Throttle – 300 Series Collet												
SAG03S12S	12,000		1.15	0.52	5.625	143	82.3		11	5.2	1/4"	Rear
SAG03S12M6S	12,000		1.15	0.52	5.625	143	82.3		11	5.2	6mm	Rear
SAG03S20S	20,000		1.15	0.52	5.625	143	85.9		11	5.2	1/4"	Rear
SAG03S20M6S	20,000		1.15	0.52	5.625	143	85.9		11	5.2	6mm	Rear
0.5 hp (0.37 kW) – Lever Throttle – 200 Series Collet												
SAG05S23	23,000		1.4	0.64	6.375	160	86		23	10.8	1/4"	Rear
SAG05S23M6	23,000		1.4	0.64	6.375	160	86		23	10.8	6 mm	Rear
0.5 hp (0.37 kW) – Lever Throttle – 300 Series Collet												
SAG05S23S	23,000		1.35	0.61	6.375	162	89.1		23	10.8	1/4"	Rear
SAG05S23M6S	23,000		1.35	0.61	6.375	162	86		23	10.8	6mm	Rear
0.70 hp (0.52 kW) – Lever Throttle – 200 Series Collet												
SAG7S12	12,000		2	0.90	6.500	165	84.3		25	12	1/4"	Front
SAG7S12M6	12,000		2	0.90	6.500	165	84.3		25	12	6mm	Front
SAG7S15	15,000		2	0.90	6.500	165	85.3		25	12	1/4"	Front
SAG7S15M6	15,000		2	0.90	6.500	165	85.3		25	12	6mm	Front
SAG7S18	18,000		2	0.90	6.500	165	85		25	12	1/4"	Front
SAG7S18M6	18,000		2	0.90	6.500	165	85		25	12	6mm	Front
1 hp (0.75 kW) – Lever Throttle – 200 Series Collet												
SAG10S12	12,000		2.7	1.2	9	230	87.4		30	14	1/4"	Rear
SAG10S12M6	12,000		2.7	1.2	9	230	78		30	14	6 mm	Rear
SAG10S15	15,000		2.7	1.2	9	230	84.2		30	14	1/4"	Rear
SAG10S15M6	15,000		2.7	1.2	9	230	78		30	14	6 mm	Rear
SAG10S18	18,000		2.7	1.2	9	230	83.2		30	14	1/4"	Rear
SAG10S18M6	18,000		2.7	1.2	9	230	78		30	14	6 mm	Rear

General: Air Inlet Size: 1/4" NPT • Recommended Hose Size: 3/8" (10 mm) • Performance rated @ 90 psig (6.2 bar) air pressure

Standard Equipment: Parts List • Safety and Instruction Manual • Collet, Support Handle (1 HP only) & Wrenches

Accessories: Grinder Accessories, see page 698



PERFORMANCE:

Power: 0.7 hp (0.52 kW) – 1 hp (0.75 kW)
 Speed: 12,000 rpm – 18,000 rpm
 Collet Size: 1/4" & 6 mm

FEATURES:

Heavy duty double tapered collet
 Teasing throttle
 Lock-off lever
 Heavy Duty spiral bevel gearing for durability and smooth operation
 Compact angle head allows access into tight spaces
 Adjustable speed control
 Grease zerk in gear case



SAG10AX12



SAG7AX20



RIGHT ANGLE EXTENDED DIE GRINDERS

Model Number	Free Speed		Weight		Length		Sound Level dB(A)	Air Consumption		Collet Size	Exhaust
	rpm		lb	kg	in	mm		cfm	l/s		
1 hp (0.75 kW) – Lever Throttle – 200 Series Collet											
SAG10AX12	12,000		3.20	1.45	11.25	286	81.6	30	14.2	1/4"	Rear
SAG10AX12M6	12,000		3.20	1.45	11.25	286	79.5	30	14.2	6mm	Rear
SAG10AX15	15,000		3.20	1.45	11.25	286	81.6	30	14.2	1/4"	Rear
SAG10AX15M6	15,000		3.20	1.45	11.25	286	84	30	14.2	6mm	Rear
SAG10AX18	18,000		3.20	1.45	11.25	286	83.7	30	14.2	1/4"	Rear
SAG10AX18M6	18,000		3.20	1.45	11.25	286	80.5	30	14.2	6mm	Rear
0.7 hp (0.52 kW) – Lever Throttle											
SAG7AX13	13,000		2.9	1.3	10	254	85	25	12	1/4"	Front
SAG7AX13M6	13,000		2.9	1.3	10	254	85	25	12	6 mm	Front
SAG7AX16	16,000		2.9	1.3	10	254	89.8	25	12	1/4"	Front
SAG7AX16M6	16,000		2.9	1.3	10	254	89.8	25	12	6 mm	Front
SAG7AX20	20,000		2.9	1.3	10	254	89.8	25	12	1/4"	Front
SAG7AX20M6	20,000		2.9	1.3	10	254	89.8	25	12	6 mm	Front

General: Air Inlet Size: 1/4" NPT • Recommended Hose Size: 3/8" (10 mm) • Performance rated @ 90 psig (6.2 bar) air pressure

Standard Equipment: Parts List • Safety and Instruction Manual • Collet, Support Handle (1 HP only) & Wrenches

Accessories: Grinder Accessories, see page 698





SAGA1AX12G



SAGA1AX12

POWER TOOLS

PERFORMANCE:

Power: 1 hp (0.75 kW)
 Speed: 12,000 rpm – 18,000 rpm
 Collet Size: 1/4" & 6 mm

FEATURES:

Lockoff Lever
 Robust Steel or Durable Aluminum Housing Available With
 Comfort Grip
 Head Height 2.28"

RIGHT ANGLE EXTENDED METAL BODY DIE GRINDERS



ABRASIVE: GRINDERS

Model Number	Free Speed		Weight		Length		Sound Level dB(A)	Air Consumption		Collet Size	Exhaust
	rpm		lb	kg	in	mm		cfm	l/s		
1 hp (0.75 kW) – Lever Throttle – Aluminum Housing											
SAGA1AX12	12,000		3.2	1.5	10.5	267	87.4	30	14.2	1/4"	Front
SAGA1AX12M6	12,000		3.2	1.5	10.5	267	87	30	14.2	6mm	Front
SAGA1AX15	15,000		3.2	1.5	10.5	267	87	30	14.2	1/4"	Front
SAGA1AX15M6	15,000		3.2	1.5	10.5	267	87	30	14.2	6mm	Front
SAGA1AX18	18,000		3.2	1.5	10.5	267	87	30	14.2	1/4"	Front
SAGA1AX18M6	18,000		3.2	1.5	10.5	267	87	30	14.2	6mm	Front
1 hp (0.75 kW) – Lever Throttle – Aluminum Housing with Grip											
SAGA1AX12G	12,000		2.9	1.3	10.5	267	87	30	14.2	1/4"	Front
SAGA1AX12M6G	12,000		2.9	1.3	10.5	267	87	30	14.2	6mm	Front
SAGA1AX15G	15,000		2.9	1.3	10.5	267	87	30	14.2	1/4"	Front
SAGA1AX15M6G	15,000		2.9	1.3	10.5	267	87	30	14.2	6mm	Front
SAGA1AX18G	18,000		2.9	1.3	10.5	267	87	30	14.2	1/4"	Front
SAGA1AX18M6G	18,000		2.9	1.3	10.5	267	87	30	14.2	6mm	Front
1 hp (0.75 kW) – Lever Throttle – Steel Housing											
SAGS1AX12	12,000		3.8	1.7	10.5	267	86.9	30	14.2	1/4"	Front
SAGS1AX12M6	12,000		3.8	1.7	10.5	267	87	30	14.2	6mm	Front
SAGS1AX15	15,000		3.8	1.7	10.5	267	87	30	14.2	1/4"	Front
SAGS1AX15M6	15,000		3.8	1.7	10.5	267	87	30	14.2	6mm	Front
SAGS1AX18	18,000		3.8	1.7	10.5	267	87	30	14.2	1/4"	Front
SAGS1AX18M6	18,000		3.8	1.7	10.5	267	87	30	14.2	6mm	Front
1 hp (0.75 kW) – Lever Throttle – Steel Housing with Grip											
SAGS1AX12G	12,000		3.4	1.5	10.5	267	87	30	14.2	1/4"	Front
SAGS1AX12M6G	12,000		3.4	1.5	10.5	267	87	30	14.2	6mm	Front
SAGS1AX15G	15,000		3.4	1.5	10.5	267	87	30	14.2	1/4"	Front
SAGS1AX15M6G	15,000		3.4	1.5	10.5	267	87	30	14.2	6mm	Front
SAGS1AX18G	18,000		3.4	1.5	10.5	267	87	30	14.2	1/4"	Front
SAGS1AX18M6G	18,000		3.4	1.5	10.5	267	87	30	14.2	6mm	Front

General: Air Inlet Size: 1/4" NPT • Recommended Hose Size: 3/8" (10 mm) • Performance rated @ 90 psig (6.2 bar) air pressure

Standard Equipment: Parts List • Safety and Instruction Manual • Collet, Support Handle & Wrenches

Accessories: Grinder Accessories, see page 698



PERFORMANCE:

Power: 0.7 hp (0.52 kW) – 1 hp (0.75 kW)
 Speed: 12,000 rpm – 18,000 rpm
 Wheel Capacity: 3" (75 mm) – 5" (127 mm)

FEATURES:

Non-Governed
 Lockoff Lever
 Adjustable Guard



RIGHT ANGLE TYPE 27 EXTENDED WHEEL GRINDERS

Model Number	Free Speed		Wheel Capacity		Weight		Length		Sound Level dB(A)	Air Consumption Free Speed		Spindle Thread	Exhaust
	rpm		In	mm	lb	kg	in	mm		cfm	l/s		
1 hp (0.75 kW) – Lockoff Lever Throttle													
SWG10AX124	12,000		4	100	3.6	1.63	11.25	285	91	35	17	3/8" - 24	Rear
SWG10AXL124	12,000		4	100	3.5	1.59	11.25	285	83.7	35	17	3/8" - 24	Rear
SWG10AX1245	12,000		4.5	115	3.7	1.68	11.25	285	86	35	17	5/8" - 11	Rear
SWG10AX125	12,000		5	127	3.8	1.72	11.25	285	83.7	35	17	5/8" - 11	Rear
0.7 hp (0.52 kW) – Lever Throttle													
SWG7AX134	13,300		4	100	3.5	1.6	10	254	87.4	25	12	3/8" - 24	Front
SWG7AX1345	13,300		4.5	115	3.5	1.6	10	254	88	25	12	5/8" - 11	Front
SWG7AX203	20,000		3	75	3.5	1.6	10	254	TBD	25	12	3/8" - 24	Front

General: 1 HP models: Air Inlet Size: 3/8" NPT • Recommended Hose Size: 3/8" (10 mm) • Performance rated @ 90 psig (6.2 bar) air pressure
 0.7 HP models: Air Inlet Size: 1/4" NPT • Recommended Hose Size: 3/8" (10 mm) • Performance rated @ 90 psig (6.2 bar) air pressure
Standard Equipment: Parts List • Safety and Instruction Manual • Spindle Wrenches • Wheel Guard • Support Handle • Mounting Flange & Nut
Accessories: Grinder Accessories, see page 698



PERFORMANCE:

Power: 1 hp (0.75 kW)
 Speed: 12,000 rpm
 Wheel Capacity: 4" (100 mm) – 4.5" (115 mm)

FEATURES:

Non-Governed
 Lockoff Lever
 Adjustable Guard
 Robust Steel or Durable Aluminum Housing Available With Comfort Grip
 Head Height 2.28"



RIGHT ANGLE TYPE 27 EXTENDED WHEEL GRINDERS

Model Number	Free Speed		Wheel Capacity		Weight		Length		Sound Level dB(A)	Air Consumption Free Speed		Spindle Thread	Exhaust
	rpm		In	mm	lb	kg	in	mm		cfm	l/s		
1 hp (0.75 kW) – Lever Throttle – Aluminum Housing													
SWGA1AX124	12,000		4	100	3.3	1.5	10.5	267	88	35	17	3/8" - 24	Front
SWGA1AX1245	12,000		4.5	115	3.4	1.5	10.5	267	88	35	17	5/8" - 11	Front
1 hp (0.75 kW) – Lever Throttle – Aluminum Housing with Grip													
SWGA1AX124G	12,000		4	100	3.2	1.5	10.5	267	86	35	17	3/8" - 24	Front
SWGA1AX1245G	12,000		4.5	115	3.3	1.5	10.5	267	86	35	17	5/8" - 11	Front
1 hp (0.75 kW) – Lever Throttle – Steel Housing													
SWGS1AX124	12,000		4	100	3.9	1.8	10.5	267	86	35	17	3/8" - 24	Front
SWGS1AX1245	12,000		4.5	115	4	1.8	10.5	267	86	35	17	5/8" - 11	Front
1 hp (0.75 kW) – Lever Throttle – Steel Housing with Grip													
SWGS1AX124G	12,000		4	100	3.7	1.7	10.5	267	87	35	17	3/8" - 24	Front
SWGS1AX1245G	12,000		4.5	115	3.8	1.7	10.5	267	87	35	17	5/8" - 11	Front

General: 1 HP models: Air Inlet Size: 3/8" NPT • Recommended Hose Size: 3/8" (10 mm) • Performance rated @ 90 psig (6.2 bar) air pressure
Standard Equipment: Parts List • Safety and Instruction Manual • Spindle Wrenches • Wheel Guard • Support Handle • Mounting Flange & Nut
Accessories: Grinder Accessories, see page 698





SWG10A1245



1285L



SWG10S183



SWG10S1245

POWER TOOLS

ABRASIVE: GRINDERS

PERFORMANCE:

Power: 1 hp (0.75 kW)
 Speed: 6000 rpm – 18,000 rpm
 Wheel Capacity: 3" (75 mm) – 7" (175 mm) diameter

FEATURES:

Governed & Non-Governed
 Lockoff Lever Throttle
 Side Exhaust: 1285L
 Rear Exhaust: SWG Series

RIGHT ANGLE TYPE 27 WHEEL GRINDERS



Model Number	Free Speed	Wheel Capacity		Weight		Length		Sound Level dB(A)	Air Consumption Under Load		Air Consumption Free Speed		Spindle Thread	
	rpm	in	mm	lb	kg	in	mm		cfm	l/s	cfm	l/s		
0.7 hp (0.52 kW)														
SWG7S183	18,000	3	75	2.1	0.95	6.4	163	TBD	N/A	N/A	25	12	3/8"-24	
1 hp (0.75 kW) – Lockoff Lever Throttle														
SWG10S124	12,000	4	100	3	1.6	8.3	210	77	N/A	N/A	35	17	3/8"-24	
SWG10S1245	12,000	4.5	115	3	1.6	8.3	210	77	N/A	N/A	35	17	5/8"-11	
SWG10S125	12,000	5	127	3.1	1.6	8.3	210	TBD	N/A	N/A	35	17	5/8"-11	
SWG10S183	18,000	3	75	2.5	1.1	7.5	190	77	N/A	N/A	35	17	3/8"-24	
1 hp (0.75 kW) – Lockoff Lever Throttle														
SWG10A124	12,000	4	100	2.5	1.1	7.75	195	86.4	N/A	N/A	35	17	3/8" - 24	
SWG10A1245	12,000	4.5	115	2.6	1.17	7.75	195	84.9	N/A	N/A	35	17	5/8"-11	
SWG10A125	12,000	5	127	2.7	1.22	7.75	195	83.7	N/A	N/A	35	17	5/8" - 11	
1 hp (0.75 kW) – Governed Speed – Lockoff Lever Throttle														
1285L ¹	6000	7	175	5.9	2.7	12.4	315	85	35	17	18	8	5/8"-11	

¹Not CE Certified

General: Air Inlet Size: 1/4" NPT • Recommended Hose Size: 3/8" (10 mm) • Performance rated @ 90 psig (6.2 bar) air pressure

Standard Equipment: Parts List • Safety and Instruction Manual • Spindle Wrenches • Wheel Guard • Support Handle • Mounting Flange & Nut

Accessories: Grinder Accessories, see page 698



PERFORMANCE:

Power: 1 hp (0.75 kW) – 3 hp (2.2 kW)
 Speed: 4500 rpm – 6000 rpm
 Wheel Capacity: 7" (175 mm) – 9" (230 mm) diameter

FEATURES:

Governed & Non-Governed
 Lockoff Lever & Thumb Throttle
 Side Exhaust



VG20AL-60D7



1291



VERTICAL TYPE 27 WHEEL GRINDERS

Model Number	Free Speed		Wheel Capacity		Weight		Length		Sound Level dB(A)	Air Consumption Under Load		Air Consumption Free Speed		Spindle Thread
	rpm		in	mm	lb	kg	in	mm		cfm	l/s	cfm	l/s	
1 hp (0.75 kW) – Non-Governor Speed – Thumb Throttle														
1291L	6000		7	175	5	2.3	7.2	183	80	30	14	38	18	5/8"-11
1 hp (0.75 kW) – Non-Governor Speed – Thumb Throttle														
1291	6000		7	175	5	2.3	7.2	183	80	30	14	38	18	5/8"-11
2 hp (1.5 kW) – Class Vertical Grinders – Governed Speed – Lever Throttle														
VG20AL-45D9	4500		9	230	7.4	3.3	5.5	145	85	75	35	26	12	5/8"-11
VG20AL-60D7	6000		7	175	7.4	3.3	5.5	145	85	75	35	26	12	5/8"-11
VG20AL-60D9	6000		9	230	7.4	3.3	5.5	145	85	75	35	26	12	5/8"-11
3 hp (2.2 kW) – Class Vertical Grinders – Governed Speed – Lever Throttle														
VG30AL-45D7	4500		7	175	9.5	4.3	6.4	165	84	90	42	39	18	5/8"-11
VG30AL-45D9	4500		9	230	9.5	4.3	6.4	165	84	90	42	39	18	5/8"-11
VG30AL-60D7	6000		7	175	9.5	4.3	6.4	165	84	90	42	39	18	5/8"-11
VG30AL-60D9	6000		9	230	9.5	4.3	6.4	165	84	90	42	39	18	5/8"-11

General: Air Inlet Size: 1/4" NPT (1290 series); 1/2" NPT (V series) • Recommended Hose Size: 3/8" (10 mm) (1290 series); 1/2" (13 mm) (V series)
 Performance rated @ 90 psig (6.2 bar) air pressure
Standard Equipment: Parts List • Safety and Instruction Manual • Spindle Wrenches • Wheel Guard • Mounting Flange & Nut
Accessories: Grinder Accessories, see page 698

PERFORMANCE:

Power: 2 hp (1.5 kW) – 3 hp (2.2 kW)
 Speed: 6000 rpm
 Wheel Capacity: 6" (150 mm)

FEATURES:

Governed Speed
 Lockoff Lever
 Side Exhaust



VG30AL-60C6



VERTICAL TYPE 6 & 11 WHEEL GRINDERS

Model Number	Free Speed		Wheel Capacity		Weight		Length		Sound Level dB(A)	Air Consumption Under Load		Air Consumption Free Speed		Spindle Thread
	rpm		in	mm	lb	kg	in	mm		cfm	l/s	cfm	l/s	
2 hp (1.5 kW) – Class Vertical Grinders – Governed Speed – Lever Throttle														
VG20AL-60C6	6000		6	150	7.4	3.3	5.5	145	85	75	35	26	12	5/8"-11
3 hp (2.2 kW) – Class Vertical Grinders – Governed Speed – Lever Throttle														
VG30AL-60C6	6000		6	150	9.5	4.3	6.4	165	84	90	42	39	18	5/8"-11

General: Air Inlet Size: 1/2" NPT • Recommended Hose Size: 1/2" (13 mm) • Performance rated @ 90 psig (6.2 bar) air pressure
Standard Equipment: Parts List • Safety and Instruction Manual • Spindle Wrenches • Wheel Guard • Mounting Flange & Nut
Accessories: Grinder Accessories, see page 698





HG30AL-60S6



HG20AL-80P3



POWER TOOLS

ABRASIVE: GRINDERS

PERFORMANCE:

Power: 2 hp (1.5 kW) – 3 hp (2.2 kW)
 Speed: 4500 rpm – 8000 rpm
 Wheel Capacity: 3" (75 mm) – 8" (200 mm)

FEATURES:

Governed Speed
 Lever Throttle
 Side Exhaust

HORIZONTAL WHEEL GRINDERS

Model Number	Free Speed		Wheel Capacity		Weight		Length		Sound Level dB(A)	Air Consumption Under Load		Air Consumption Free Speed		Spindle Thread
	rpm		in	mm	lb	kg	in	mm		cfm	l/s	cfm	l/s	
2 hp (1.5 kW) – Class Horizontal Grinders – Governed Speed – Lever Throttle														
HG20AL-45S8	4500		8	200	10.5	4.8	20.8	530	85	75	35	26	12	5/8"-11
HG20AL-60S6	6000		6	150	10.5	4.8	20.8	530	85	75	35	26	12	5/8"-11
HG20AL-80P3	8000		3	75	10.5	4.8	20.8	530	85	75	35	26	12	5/8"-11
3 hp (2.2 kW) – Class Horizontal Grinders – Governed Speed – Lever Throttle														
HG30AL-45S8	4500		8	200	12.5	5.6	21.8	550	84	90	42	39	18	5/8"-11
HG30AL-60S6	6000		6	150	12.5	5.6	21.8	550	84	90	42	39	18	5/8"-11
HG30AL-80P3	8000		3	75	12.5	5.6	21.8	550	84	90	42	39	18	5/8"-11

General: Air Inlet Size: 1/2" NPT • Recommended Hose Size: 1/2" (13 mm) • Performance rated @ 90 psig (6.2 bar) air pressure
Standard Equipment: Parts List • Safety and Instruction Manual • Spindle Wrenches • Wheel Guard • Mounting Flange & Nut
Accessories: Grinder Accessories, see page 698

PERFORMANCE:

Power: 0.5 hp (0.37 kW)
 Speed: 35000 rpm

FEATURES:

Removable Support Handle
 Lockoff Lever
 Planetary Gear for Increased Torque

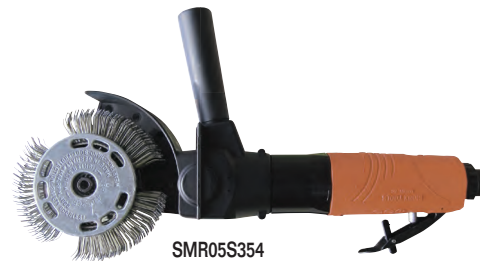

SMR05S354



MATERIAL REMOVAL TOOL

Model Number	Free Speed	Weight		Length		Sound Level dB(A)	Air Consumption		Exhaust
	rpm	lb	kg	in	mm		cfm	l/s	
SMR05S354	3500	2.4	1.08	12	304.8	85	28	132	Rear

General: Air Inlet Size: 1/4" NPT • Recommended Hose Size: 3/8" (10 mm) • Performance rated @ 90 psig (6.2 bar) air pressure
Standard Equipment: Parts List • Safety and Instruction Manual • Fine Belt (68813) • Coarse Belt (68814) • Eraser (68815) • Support Handle
Accessories: Material Removal Tool Accessories, see page 698



BELTS AND ERASERS



Hub Set 68918



Eraser 68815



Course Wire Belt 68814



Fine Wire Belt 68813



Medium Stainless Steel Wire Belt 68917



Fine Stainless Steel Wire Belt 68915

Part Number	Description
68918	11mm Hub Set
68815	Rubber Eraser
68814	Course Wire Belt, 23 mm Wide
68910	Course Wire Belt, 11 mm Wide
68911	Medium Wire Belt, 23 mm Wide
68912	Medium Wire Belt, 11 mm Wide
68813	Fine Wire Belt, 23 mm Wide
68913	Fine Wire Belt, 11 mm Wide
68916	Medium Stainless Steel Wire Belt, 23 mm Wide
68917	Medium Stainless Steel Wire Belt, 11 mm Wide
68914	Fine Stainless Steel Wire Belt, 23 mm Wide
68915	Fine Stainless Steel Wire Belt, 11 mm Wide

COLLETS



21126



44440

Style	Capacity	Part Number	For Use On
Sioux	1/8"	44522	2S1940
	3/16"	44523	
	1/4"	44440	
	3 mm	66037	
	6 mm	66038	
100 Series	1/4"	21126B	1985
	3/8"	21125	
	1/2"	21124	

WHEEL GUARDS



2336

Part Number	Wheel Type	Wheel Diameter		For Use On
		in	mm	
2321	27	7	180	1285, 1285L
2336	27	7	180	1291, 1921L

MOUNTING ACCESSORIES

7" and 9" Type 27 Depressed Center Wheel
For use on 5/8" - 1 1/2" threaded spindles

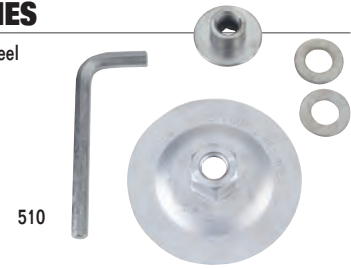

510

Part Number	Description
510	Flange Adapter Kit
512	1 1/4" x 2 1/32" x 3/32" Washers Flange Nut 3/8" Hex Wrench

SIGNATURE SERIES COLLETS

200 SERIES

Heavy Duty Double Tapered Collet



Part Number	Description
74071	Collet Nut
74072	Collet (1/8")
74073	Collet (3/16")
74074	Collet (1/4")
68030	Collet (3/8")
74075	Collet (3 mm)
74076	Collet (6 mm)
68056	Collet (8 mm)
77057	Collet Body SDG Series
74070	Collet Body (1 HP)

300 SERIES

Heavy Duty Double Tapered Collet



Part Number	Description
74128	Collet Nut
74124	Collet (3/32")
74121	Collet (1/8")
74120	Collet (1/4")
74122	Collet (3 mm)
74123	Collet (6 mm)
77505	Collet Body SAS Series
74125	Collet Body SDG Series



WARNING



Safety Precaution: Read and follow all safety and operation instructions.
Warning: Face & eye protection must be worn while operating power tools, per ANSI B186.1.

FINISHING

The Best Way To A Great Finish



POWER TOOLS

FINISHING

Today's manufacturing techniques are constantly changing and improving. This has increased the demands for sanders, polishers and buffers, making them a key segment of the process. Improvements in the industry now result in less waste on castings and molded parts, which shifts the emphasis from material removal to surface finishing. Sioux Tools offers a complete line of state-of-the-art orbital sanders, polishers and buffers that will produce the quality finish you require on your final product.

Sioux sanders are engineered to cover the full range of applications in metal, composite, and wood finishing. Our innovative, lightweight designs ensure they perform to the highest standards while still being comfortable to operate. Each delivers unsurpassed power and performance, resulting in the perfect finish.

FIT TO YOUR APPLICATION

Different applications require different finishing tools. That's why Sioux Tools offers a variety of sanders and polishers with a wide range of configurations.

The RO2512 Series Random Orbital Sanders come with an orbit diameter of either 3/8" (10 mm), 3/16" (5 mm) or 3/32" (3 mm) and a choice of non-vacuum, self-contained Venturi vacuum or remote vacuum ready.

VARIETY TO CHOOSE FROM

We also offer pistol grip, right angle, vertical, and straight sanders and polishers. Many of these come with your choice of throttle controls that allow the operator to work the way that's most comfortable.

FINISHING SAFETY

Flying particles can cause eye injury. Proper eye protection must be worn at all times by tools user and bystanders.

A grinding wheel that bursts can cause injury or death. Never mount a grinding wheel or a cutoff wheel on a sander or polisher.

Breathing grinding dust can cause injury. Do not breathe grinding dust. Use approved mask.

Sanders and polishers that do not come to a complete stop before setting aside can cause injury. Be sure the tool has come to a complete stop before setting it aside.

Explosions and fires can cause injury. Only sand metal if the area is free of combustible or explosive materials or vapors.

Contact with sanding disks can cause injury. Wear protective clothing and gloves to protect hands. Keep hands and other body parts away from sanding pads and disks to prevent cutting or pinching.

Sanding or polishing pads, disks or accessories that burst can cause injury. Make sure disks or accessories have a higher speed rating than the tool. Do not exceed rated air pressure.

Prolonged exposure to vibration or an excessive exposed portion of the edge of a disk can cause injury. When using self adhesive sanding disks, make sure to mount them concentrically on the pad.

Tools starting unexpectedly can cause injury. Always remove tool from air supply and activate trigger to bleed air line before making any adjustments, changing accessories, or doing any maintenance or service on tool.

Tools that perform unpredictably can cause injury. Use only sanding and polishing pads, disks and accessories provided or specified by Sioux Tools.





RO2512-50SNP



RO2512-50SRP



RO2512-50FVP

PERFORMANCE:

Power: 0.25 hp (0.19 kW)
Speed: 12,000 rpm

FEATURES:

3/32" (3 mm), 3/16" (5 mm) & 3/8" (10 mm) Orbit Diameters
Built-in Speed Control
Ergonomic 24-Position Indexable Grip
Non-Vacuum, Venturi Vacuum & Remote Vacuum



RO2512 SERIES RANDOM ORBITAL SANDERS

Model Number	Free Speed	Pad Size	Orbit Diameter	Weight	Height	Air Consumption	Sound Level						
PSA Pad	H & L Pad	rpm	in	mm	in	mm	lb	kg	in	mm	cfm	l/s	dB(A)
0.25 hp (0.19 kW) - 5/16"-24 Spindle Thread - Non-Vacuum													
RO2512-30FNP	RO2512-30FNH	12,000	3	75	3/32	3	1.5	0.7	3.3	83	13	6	81
RO2512-30SNP	RO2512-30SNH	12,000	3	75	3/16	5	1.5	0.7	3.3	83	13	6	81
RO2512-35FNP	RO2512-35FNH	12,000	3.5	90	3/32	3	1.5	0.7	3.3	83	13	6	81
RO2512-35SNP	RO2512-35SNH	12,000	3.5	90	3/16	5	1.5	0.7	3.3	83	13	6	81
RO2512-50FNP	RO2512-50FNH	12,000	5	125	3/32	3	1.5	0.7	3.3	83	13	6	81
RO2512-50SNP	RO2512-50SNH	12,000	5	125	3/16	5	1.5	0.7	3.3	83	13	6	81
RO2512-50CNP	RO2512-50CNH	12,000	5	125	3/8	10	1.5	0.7	3.3	83	13	6	81
RO2512-60FNP	RO2512-60FNH	12,000	6	150	3/32	3	1.5	0.7	3.3	83	13	6	81
RO2512-60SNP	RO2512-60SNH	12,000	6	150	3/16	5	1.5	0.7	3.3	83	13	6	81
RO2512-60CNP	RO2512-60CNH	12,000	6	150	3/8	10	1.5	0.7	3.3	83	13	6	81
0.25 hp (0.19 kW) - 5/16"-24 Spindle Thread - Remote Vacuum Ready													
RO2512-30FRP	RO2512-30FRH	12,000	3	75	3/32	3	1.5	0.7	3.3	83	13	6	81
RO2512-30SRP	RO2512-30SRH	12,000	3	75	3/16	5	1.5	0.7	3.3	83	13	6	81
RO2512-35FRP	RO2512-35FRH	12,000	3.5	90	3/32	3	1.5	0.7	3.3	83	13	6	81
RO2512-35SRP	RO2512-35SRH	12,000	3.5	90	3/16	5	1.5	0.7	3.3	83	13	6	81
RO2512-50FRP	RO2512-50FRH	12,000	5	125	3/32	3	1.5	0.7	3.3	83	13	6	81
RO2512-50SRP	RO2512-50SRH	12,000	5	125	3/16	5	1.5	0.7	3.3	83	13	6	81
RO2512-50CRP	RO2512-50CRH	12,000	5	125	3/8	10	1.5	0.7	3.3	83	13	6	81
RO2512-60FRP	RO2512-60FRH	12,000	6	150	3/32	3	1.5	0.7	3.3	83	13	6	81
RO2512-60SRP	RO2512-60SRH	12,000	6	150	3/16	5	1.5	0.7	3.3	83	13	6	81
RO2512-60CRP	RO2512-60CRH	12,000	6	150	3/8	10	1.5	0.7	3.3	83	13	6	81
0.25 hp (0.19 kW) - 5/16"-24 Spindle Thread - Self-contained Venturi Vacuum													
RO2512-30FVP	RO2512-30FVH	12,000	3	75	3/32	3	1.5	0.7	3.3	83	13	6	81
RO2512-30SVP	RO2512-30SVH	12,000	3	75	3/16	5	1.5	0.7	3.3	83	13	6	81
RO2512-35FVP	RO2512-35FVH	12,000	3.5	90	3/32	3	1.5	0.7	3.3	83	13	6	81
RO2512-35SVP	RO2512-35SVH	12,000	3.5	90	3/16	5	1.5	0.7	3.3	83	13	6	81
RO2512-50FVP	RO2512-50FVH	12,000	5	125	3/32	3	1.5	0.7	3.3	83	13	6	81
RO2512-50SVP	RO2512-50SVH	12,000	5	125	3/16	5	1.5	0.7	3.3	83	13	6	81
RO2512-50CVP	RO2512-50CVH	12,000	5	125	3/8	10	1.5	0.7	3.3	83	13	6	81
RO2512-60FVP	RO2512-60FVH	12,000	6	150	3/32	3	1.5	0.7	3.3	83	13	6	81
RO2512-60SVP	RO2512-60SVH	12,000	6	150	3/16	5	1.5	0.7	3.3	83	13	6	81
RO2512-60CVP	RO2512-60CVH	12,000	6	150	3/8	10	1.5	0.7	3.3	83	13	6	81

General: Air Inlet Size: 1/4" NPT • Recommended Hose Size: 3/8" (10 mm) • Performance rated @ 90 psig (6.2 bar) air pressure
Standard Equipment: Parts List • Safety and Instruction Manual • Comfort Grip • Backing Pad & Wrench
Accessories: Sander Accessories, see pages 706-708





RO2510-44FNC

PERFORMANCE:

Power: 0.25 hp (0.19 kW)
Speed: 10,000 rpm

FEATURES:

Built-in Speed Control
Ergonomic 24-Position Indexable Grip

ORBITAL JITTERBUG SANDERS



Model Number	Paper Size		Orbit Diameter		Weight		Height		Air Consumption Free Speed		Sound Level dB(A)
	in	mm	in	mm	lb	kg	in	mm	cfm	l/s	
0.25 hp (0.19 kW)											
RO2510-44FNC	3 3/4 x 4 1/4	95 x 105	3/32	3	1.8	0.8	3.5	90	13	6	81

General: Air Inlet Size: 1/4" NPT • Recommended Hose Size: 3/8" (10 mm) • Performance rated @ 90 psig (6.2 bar) air pressure

Standard Equipment: Parts List • Safety and Instruction Manual

Accessories: Sander Accessories, see pages 706-708



GO459-60SNP



GO459-80SRP

PERFORMANCE:

Power: 0.45 hp (0.34 kW)
Speed: 900 rpm

FEATURES:

3/16" (5 mm) Orbit Diameter
Built-in Speed Control
Lever Throttle
Vacuum & Remote Vacuum
Ergonomic 24-Position Indexable Grip

GEARED ORBITAL SANDERS



Model Number	PSA Pad	H & L Pad	Free Speed rpm	Pad Size		Weight		Height		Air Consumption		Sound Level dB(A)
				in	mm	lb	kg	in	mm	cfm	l/s	
0.45 hp (0.34 kW) Non-Vacuum												
GO459-60SNP		GO459-60SNH	900	6	150	4.4	2	5	127	15	7	82
GO459-80SNP		GO459-80SNH	900	8	200	4.4	2	5	127	15	7	82
0.45 hp (0.34 kW) Remote Vacuum												
GO459-60SRP		GO459-60SRH	900	6	150	4.4	2	5	127	15	7	82
GO459-80SRP		GO459-80SRH	900	8	200	4.4	2	5	127	15	7	82

General: Air Inlet Size: 1/4" NPT • Recommended Hose Size: 3/8" (10 mm) • Performance rated @ 90 psig (6.2 bar) air pressure

Standard Equipment: Parts List • Safety and Instruction Manual

Accessories: Sander Accessories, see pages 706-708

POWER TOOLS

FINISHING: SANDERS



PERFORMANCE:

Power: 0.40 hp (0.30 kW)
Speed: 10,000 rpm

FEATURES:

3/16" (5 mm) Orbit Diameter
Built-in Speed Control
Aluminum Housing
Palm & Lever Throttle



658

600 SERIES RANDOM ORBITAL SANDERS

Model Number		Free Speed	Pad Size		Orbit Diameter		Weight		Height		Air Consumption		Sound Level
PSA Pad	H & L Pad	rpm	in	mm	in	mm	lb	kg	in	mm	cfm	l/s	dB(A)
0.40 hp (0.30 kW) – Palm Throttle													
PS690 ¹		10,000	5	125	3/16	5	2.9	1.3	4.2	107	20	9	85
697 ¹		10,000	6	150	3/16	5	2.9	1.3	4.2	107	20	9	85
0.40 hp (0.30 kW) – Dual Action – Lever Throttle													
658 ¹		10,000	5	125	3/16	5	3.2	1.5	4.2	107	20	9	85

¹For remote vacuum ready add suffix V

¹Not CE Certified **General:** Air Inlet Size: 1/4" NPT • Recommended Hose Size: 3/8" (10 mm) • Performance rated @ 90 psig (6.2 bar) air pressure

Standard Equipment: Parts List • Safety and Instruction Manual • Backing Pad & Wrench

Accessories: Sander Accessories, see pages 706-708



SPS10P18



SDG10P18

PERFORMANCE:

Power: 1 hp (0.75 kW)
Speed: 6000 rpm – 21,000 rpm

FEATURES:

Trigger Start
Down-Handle Exhaust
Comfort Grip



PISTOL GRIP SANDERS

Model Number	Free Speed	Weight		Height		Air Consumption		Sound Level
	rpm	lb	kg	in	mm	cfm	l/s	
1 hp (0.75 kW) – 5" (125 mm) Diameter Backing Pad								
SPS10P6	6000	1.7	0.8	4.5	115	35	17	80
SPS10P18	18,000	1.7	0.8	4.5	115	35	17	80
1 hp (0.75 kW) – 1/4" Collet								
SDG10P18	18,000	1.7	0.8	5.8	145	35	17	86.2
SDG10P21	21,000	1.7	0.8	5.8	145	35	17	86.3

General: Air Inlet Size: 1/4" NPT • Recommended Hose Size: 3/8" (10 mm) • Performance rated @ 90 psig (6.2 bar) air pressure

Standard Equipment: Parts List • Safety and Instruction Manual • Comfort Grip

Accessories: Sander Accessories, see pages 706-708



WARNING



Safety Precaution: Read and follow all safety and operation instructions.
Warning: Face & eye protection must be worn while operating power tools, per ANSI B186.1.



SAS03S122-20



SAS05S232-20



SAS10A182-20



77016 Threaded Arbor



300 Series Collet

POWER TOOLS

FINISHING: SANDERS

PERFORMANCE:

Power: 0.33 hp (0.25 kW) – 1 hp (0.75 kW)
Speed: 12,000 rpm – 23,000 rpm

FEATURES:

Lockoff Lever Throttle
Front, Rear, and Vacuum Exhaust
Comfort Grip

RIGHT ANGLE DISC SANDERS



Model Number	Free Speed	Weight		Length		Air Consumption		Sound Level	Spindle Thread
	rpm	lb	kg	in	mm	cfm	l/s	dB(A)	
0.3 hp (0.22 kW) – Lever Throttle									
SAS03S122-20	12,000	1.1	0.5	5.625	143	11	5.2	82.2	1/4"-20
SAS03S202-20	20,000	1.1	0.5	5.625	143	11	5.2	82.9	1/4"-20
0.5 hp (0.37 kW) – Lever Throttle									
SAS05S232-20	23,000	1.3	0.59	5.625	143	23	10.3	88.6	1/4"-20
1 hp (0.75 kW) – Lever Throttle									
SAS10A122-20	12,000	2.15	0.98	7.5	190	30	14	84.6	1/4"-20
SAS10A152-20	15,000	2.15	0.98	7.5	190	30	14	TBD	1/4"-20
SAS10A182-20	18,000	2.15	0.98	7.5	190	30	14	83.4	1/4"-20
SAS10A324	3200	TBD	TBD	TBD	TBD	35	17	TBD	3/8"-24

General: Air Inlet Size: 1/4" NPT • Recommended Hose Size: 3/8" (10 mm) • Performance rated @ 90 psig (6.2 bar) air pressure

Standard Equipment: Parts List • Safety and Instruction Manual • Support Handle (1 hp Models) • Spindle Wrenches, 300 Series Collet, 1/4"-20 Threaded Arbor

Accessories: Sander Accessories, see pages 706-708



SAS10S125



SAS10A125



SAS10AX125



1287L

PERFORMANCE:

Power: 1 hp (0.75 kW)
Speed: 6000 rpm – 12,000 rpm

FEATURES:

Governed & Non-Governed
Lockoff Lever Throttle
Rear Exhaust on SAS Series

**RIGHT ANGLE SANDERS**

Model Number	Free Speed		Pad Diameter		Weight		Length		Air Consumption Under Load		Air Consumption Free Speed		Sound Level	Spindle Thread
	rpm		in	mm	lb	kg	in	mm	cfm	l/s	cfm	l/s	dB(A)	
1 hp (0.75 kW) – Lockoff Lever Throttle – Rear Exhaust														
SAS10S125	12,000		5	125	3.5	1.6	8.3	210	N/A	N/A	35	17	77	5/8"-11
SAS10A125	12,000		5	125	2.2	1	7.75	134	N/A	N/A	35	17	84.1	5/8"-11
SAS10AX125	12,000		5	125	3.2	1.45	11.25	285	N/A	N/A	35	17	83.2	5/8"-11
1 hp (0.75 kW) – Governed Speed Control – Lockoff Lever Throttle														
1287L ¹	6000		7	175	5.9	2.7	11.3	287	35	17	18	8	85	5/8"-11

¹Not CE certified.

General: Air Inlet Size: 1/4" NPT • Recommended Hose Size: 3/8" (10 mm) • Performance rated @ 90 psig (6.2 bar) air pressure

Standard Equipment: Parts List • Safety and Instruction Manual • Support Handle • Spindle Wrenches • Backing Pad & Nut

Accessories: Sander Accessories, see pages 706-708



1290



1290L



VS20AL-727

PERFORMANCE:

Power: 1 hp (0.75 kW) – 2 hp (1.5 kW)
Speed: 6000 rpm – 7200 rpm

FEATURES:

Governed & Non-Governed
Lever & Thumb Throttle
Side Exhaust
Overspeed Shutoff Protection (V Series)

**VERTICAL SANDERS**

Model Number	Free Speed	Pad Diameter		Weight		Length		Air Consumption Under Load		Air Consumption Free Speed		Sound Level	Spindle Thread
	rpm	in	mm	lb	kg	in	mm	cfm	l/s	cfm	l/s	dB(A)	
1 hp (0.75 kW) – Thumb Throttle													
1290	5000	7	175	4.1	1.9	7.2	183	30	14	38	18	80	5/8"-11
1 hp (0.75 kW) – Lever Throttle													
1290L	6000	7	175	4.1	1.9	7.2	183	30	14	38	18	80	5/8"-11
2 hp (1.5 kW) Class Vertical Sanders – Governed Speed Control – Lockoff Lever Throttle													
VS20AL-609	6000	9	230	7.4	3.3	5.5	145	75	35	26	12	85	5/8"-11
VS20AL-727	7200	7	175	7.4	3.3	5.5	145	75	35	26	12	85	5/8"-11

General: Air Inlet Size: 1/4" NPT • Recommended Hose Size: 3/8" (10 mm) • Performance rated @ 90 psig (6.2 bar) air pressure

Standard Equipment: Parts List • Safety and Instruction Manual • Spindle Wrenches • Backing Pad & Nut

Accessories: Sander Accessories, see pages 706-708





PERFORMANCE:

Power: 1 hp (0.75 kW)
Speed: 3000 rpm

FEATURES:

Governed Speed Control
Lockoff Lever Throttle
Spindle Lock
Remote Exhaust



POWER TOOLS

RIGHT ANGLE POLISHERS

Model Number	Free Speed		Pad Diameter		Weight ¹		Length		Air Consumption Under Load		Air Consumption Free Speed		Sound Level	Spindle Thread
	rpm		in	mm	lb	kg	in	mm	cfm	l/s	cfm	l/s	dB(A)	
1 hp (0.75 kW) – Lockoff Lever Throttle														
1238L	3000		8	200	7.9	3.6	11.3	287	33	16	16	8	75	5/8"-11

¹ Weight includes pad & holder.

General: Air Inlet Size: 1/4" NPT • Recommended Hose Size: 3/8" (10 mm) • Performance rated @ 90 psig (6.2 bar) air pressure

Standard Equipment: Parts List • Safety and Instruction Manual • Remote Exhaust • Support Handle • Backing Pad & Nut • Wool Polishing Pad

Accessories: Polisher Accessories, see pages 706-708

FINISHING: POLISHERS

PERFORMANCE:

Power: 1 hp (0.75 kW)
Speed: 2000 rpm – 3000 rpm

FEATURES:

Lever & Thumb Throttle
Side Exhaust
Comfort Grips



VERTICAL POLISHERS

Model Number	Free Speed		Pad Diameter		Weight ¹		Length		Air Consumption Under Load		Air Consumption Free Speed		Sound Level	Spindle Thread
	rpm		in	mm	lb	kg	in	mm	cfm	l/s	cfm	l/s	dB(A)	
1 hp (0.75 kW) – Thumb Throttle														
1296	2000		8	200	4.1	1.9	7.1	180	30	14	38	18	80	5/8"-11
1292	3000		8	200	4.1	1.9	7.1	180	30	14	38	18	80	5/8"-11
1 hp (0.75 kW) – Lever Throttle														
1292L	3000		8	200	4.1	1.9	7.1	180	30	14	38	18	80	5/8"-11

¹ Weight includes pad & holder.

General: Air Inlet Size: 1/4" NPT • Recommended Hose Size: 3/8" (10 mm) • Performance rated @ 90 psig (6.2 bar) air pressure

Standard Equipment: Parts List • Safety and Instruction Manual • Spindle Wrenches • Backing Pad & Nut • Polishing Pad

Accessories: Polisher Accessories, see pages 706-708



COMFORT GRIPS



Part Number	Description	For Use On
66667	Cushion Grip	690 series

FIBRE BACKING DISCS

Part No 586
 For use on SPS10P series sanders
 Packaged in cartons of 6
 Qty 3 – 3" (75 mm)
 Qty 3 – 4-1/2" (110 mm)



SUPPORT HANDLE

Part No 2362
 For use on 2L series straight sanders



BACKING PADS

For use on SPS10P series sanders



Part Number	Thread	Diameter	
		in	mm
2344*	(3/8-24)	5	125
2364*	(5/8-11)	5	125

* Includes disc nut 563

SPEED-LOK BACKING PADS

For use on 1DA series sanders

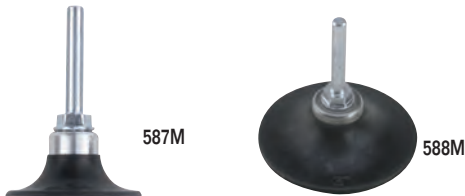

Part Number	Diameter		Hex Size
	in	mm	
587M	2	50	1/4"
588M	3	75	1/4"

7" (175 MM) OR 9" (230 MM) SANDING KITS

For use on 1287, 1287L, 1290, 1290L & VS20 Series



Part Number	Description
545 Standard Kit	
544	Disc holder
548	Backing disc
542	Retainer
524	Retaining nut
545H Heavy-Duty Kit	
544	Disc holder
548H	Heavy-duty backing disc
542	Retainer
524	Retaining nut





ORBITAL SANDER BACKING PADS

Sioux random orbital backing pads are medium density, urethane pads rated for speeds up to 13,000 rpm. The 5" pads are a 3/8" thick with low profile design, while the 6" pads are 5/8" thick with tapered profile for fine feathering in corners or around edges.

5/16" - 24 Spindle Thread

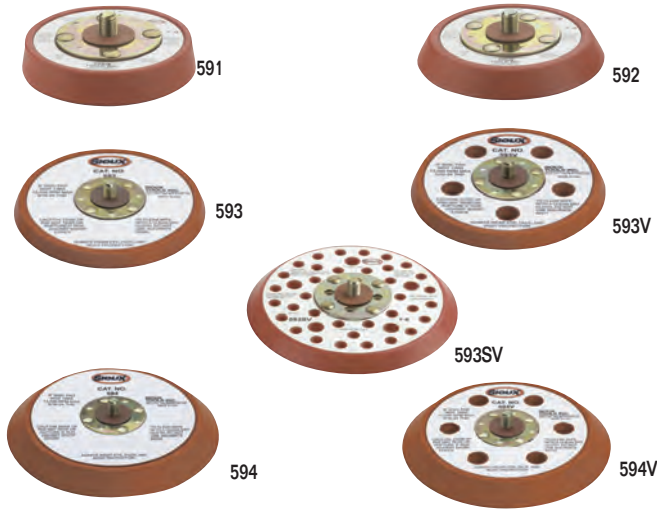

Part Number	Diameter		Backing	Profile	Style
	in	mm			
591	3	75	PSA ¹	Low	Vac/Non-Vac
591J	3	75	H & L ²	Low	Vac/Non-Vac
592	3.5	90	PSA ¹	Tapered	Vac/Non-Vac
592J	3.5	90	H & L ²	Tapered	Vac/Non-Vac
593	5	125	PSA ¹	Low	Non-Vac
593V	5	125	PSA ¹	Low	Vacuum
593J	5	125	H & L ²	Low	Non-Vac
593JV	5	125	H & L ¹	Low	Vacuum
593SV	5	125	PSA ¹	Low	Screen Vac
594	6	150	PSA ¹	Tapered	Non-Vac
594V	6	150	PSA ¹	Tapered	Vacuum
594J	6	150	H & L ²	Tapered	Non-Vac
594JV	6	150	H & L ²	Tapered	Vacuum
594SV	6	125	PSA ¹	Low	Screen Vac

¹ PSA - Vinyl face for pressure sensitive adhesive sanding discs

² H & L - Hook and loop face

POLISHING ACCESSORIES



Part Number	Grit	Grit
846C*	Backing pad (Includes 524)	
1211B*	Wool polishing pad	
524*	Retaining nut	
847	Hook & loop backing pad	1238, 1238L
1220	Hook & loop polishing pad	1292, 1292L
843	Tie-on wool bonnet (pkg 10)	

* Standard equipment on polishers

VACUUM CONVERSION KITS



Part Number	For Use On
665	658, 690, 758, 790

POWER TOOLS

FINISHING ACCESSORIES



DUSTLESS WET/DRY VACUUMS

DUSTLESS WET/DRY VACUUM

Sioux Model DVS-5

- Outperforms Traditional Shop Vacs
- Two Layers Of Filtration For A Dust-Free Environment
- Powerful 23,000 RPM, 11.5 Amp Electric Motor
- 16 Gallon Capacity
- Does Not Cough Dust When Vacuum Is Turned On
- Convenient Tool Storage Onboard Vacuum
- Filtration Down To .5 Microns
- Quiet Operation Only 81 dB(A)



DUSTLESS HEPA VACUUM

Sioux Model DVH-3

- HEPA Certified
- Filtration Down To .3 Microns
- 16 Gallon Capacity
- Designed For Extra Fine Dust
- Quiet Operation Only 81 dB(A)
- Great For Hexavalent Chromium Applications

DUSTLESS VACUUM SHROUDS

RANDOM ORBITAL SANDER VACUUM SHROUD

Sioux Models RO25VS-5 and RO25VS-6

- Fit RO25 Series Random Orbital Sanders
- Available For 5" Or 6" Sanders
- Captures 99% Of Airborne Dust
- Protects Workers From Harmful Airborne Dust
- Flexible And Transparent For Better Visibility
- Includes 6 Ft. Vacuum Hose



Part Number	Description
RO25VS-5	5" Vacuum Shroud
RO25VS-6	6" Vacuum Shroud

DRILL AND RIVET SHAVER VACUUM SHROUD

Sioux Model DRVS150

- Can Be Used With Any Drill Or Rivet Shaver
- Suction Holds The Shroud In Place
- Great For Tight Spaces
- Can Be Used For Drilling Holes Up To 1 3/8" Diameter
- Captures 99% Of Airborne Dust
- Protects Workers From Harmful Airborne Dust
- Transparent For Better Visibility
- Includes 6 Ft. Vacuum Hose



HOSE CUFF ADAPTER SET

- Adapts 1-1/2" hose to 1-1/4" hose
- Connector for 1-1/2" vacuum hose



MV-49

PNEUMATIC TOOL REMOTE START ADAPTER

- Lets You Start And Stop Your Pneumatic Tool And Vacuum In Synchronization
- Works With Any Pneumatic Tool
- Wireless Radio Operated
- Quick And Easy To Set Up



DVRS-PA

ELECTRIC TOOL REMOTE START ADAPTER

- Works With Any Electric Power Tool
- Works With Any Vacuum
- Recognizes Up To 16 Tool/Tool Pods
- Wireless Radio Operated
- Quick And Easy To Set Up
- Reduces Trip Hazard (Fewer Cords)



DVRS-EA

VACUUM REMOTE START ADAPTER

- Allows the use of multiple tools off the same vacuum
- Can be used with any pneumatic tool or electric power tool



DVRS-VA

HEPA FILTER

- Certified To Meet OSHA, EPA, & NIOSH Guidelines
- Captures Dust Down To .3 Microns
- Large Circumference For Increased Life
- Large Loose Plates For Increased Air Flow



MV-21

MICRO PRE-FILTER BAG

- Disposable
- Eliminates The Need To Clean Filters
- Retains Strength When Wet
- Holds More Than 40 lbs of Dust And Debris
- Captures Extra Fine Dust Down To .5 Microns
- Extends The Life Of HEPA Filters
- Large Surface Area For Maximum Airflow



MV-52

FABRIC FILTER SET

- 2 Stage Inner And Outer Filter
- Machine Washable
- Stays Dry At All Times
- Clean Outer Filter Without Opening the Canister
- No Need To Change Filters When Changing From Wet To Dry Vacuuming
- Large Surface Area For Maximum Flow



MV-51



PERCUSSIVE



Hammering Home A Point

Percussive tools, such as hammers, chippers and scalers are commonly used in very abusive environments found in industries such as foundry and construction. Sioux Tools offers a variety of sizes, capacities and accessories built durable to ensure long life under tough operating conditions. We build them to work hard on the job, but not on you!

INDUSTRIAL TOOLS

Sioux offers powerful hammers that deliver up to 2,500 blows per minute (bpm), with steel rivet capacities of 5/32" (4 mm) to 1/4" (6.4 mm) and stroke lengths from 2" (50 mm) to 4" (100 mm).

PERCUSSIVE SAFETY

Never operate a hammer without proper retainer in place. Always disconnect air line before changing chisels. Face and eye protection must be worn while operating tools. All chisels, rivet sets and other accessories should be checked for cracks, excessive wear, or other physical damage before each use. Accessories that show damage should be replaced immediately.



POWER TOOLS

PERCUSSIVE





SC41011AL-C



SC41011AU-N5

PERFORMANCE:

Stroke: 1.1" (28 mm)
 Bore: 1" (25 mm)
 Blows per Minute: 4600

FEATURES:

Lever and Push/Pull Start
 Quick Release Retainer
 Adjustable Needle Length

SC4 series scalers accept notched, square shank chisels and accessories. Each can be quickly converted between chisel and needle styles.



Square Shank



SQUARE SHANK SCALERS

Model Number	Stroke Length		Bore Diameter		Blows per Minute	Weight		Length		Side To Center		Air Consumption	
	in	mm	in	mm		lb	kg	in	mm	in	mm	cfm	l/s
Chisel Scaler – Lever Throttle													
SC41011AL-C	1.1	28	1	25	4600	4.6	2.1	10.5	263	0.9	23	12	6
Chisel Scaler – Push/Pull Throttle													
SC41011AU-C	1.1	28	1	25	4600	4.6	2.1	12	300	0.9	23	12	6
Needle Scaler – Lever Throttle													
SC41011AL-N5	1.1	28	1	25	4600	6.3	2.9	15.3	383	1	25	12	6
Needle Scaler – Push/Pull Throttle													
SC41011AU-N5	1.1	28	1	25	4600	6.3	2.9	16.8	420	1	25	12	6

General: Air Inlet Size: 1/4" NPT • Recommended Hose Size: 3/8" (10 mm) • Performance rated @ 90 psig (6.2 bar) air pressure
Standard Equipment: Parts List • Safety and Instruction Manual • 7" flat chisel (chisel scalers) • 5" scaler needles (needle scalers)
Accessories: Scaler Accessories, see pages 712-714



SC80910AL-C



SC80910AL-N5

PERFORMANCE:

Stroke: 1" (25 mm)
 Bore: 15/16" (23 mm)
 Blows per Minute: 4300

FEATURES:

Lever Throttle
 Quick Release Retainer
 Adjustable Needle Length

SC8 series scalers accept notched, octagon shank chisels and accessories. Each can be quickly converted between chisel and needle styles.



Octagon Shank



OCTAGON SHANK SCALERS

Model Number	Stroke Length		Bore Diameter		Blows per Minute	Weight		Length		Side To Center		Air Consumption	
	in	mm	in	mm		lb	kg	in	mm	in	mm	cfm	l/s
Chisel Scaler – Octagon Shank – Lever Throttle													
SC80910AL-C	1	25	15/16	23	4300	4	1.7	15	375	0.8	20	12	6
Needle Scaler – Octagon Shank – Lever Throttle													
SC80910AL-N5	1	25	15/16	23	4300	6.2	2.7	17	425	0.9	23	12	6

General: Air Inlet Size: 1/4" NPT • Recommended Hose Size: 3/8" (10 mm) • Performance rated @ 90 psig (6.2 bar) air pressure
Standard Equipment: Parts List • Safety and Instruction Manual • 7" flat chisel (chisel scalers) • 5" scaler needles (needle scalers)
Accessories: Scaler Accessories, see pages 712-714

SC4 SCALER KIT

Part No. SC41011AL-K

- SC4 Lever Needle Scaler
- Additional Set of Needles
- 3/4" x 7" Flat Chisel
- 1-3/8" x 7" Flat Chisel
- 1-3/8" x 7" Spoon Chisel
- Custom Carrying Case



SC8 SCALER KIT

Part No. SC80910AL-K

- SC8 Needle Scaler
- Additional Set of Needles
- 3/4" x 7" Flat Chisel
- 1-3/8" x 7" Flat Chisel
- 1-3/8" x 7" Spoon Chisel
- Custom Carrying Case





PERFORMANCE:

Stroke: 13/16" (21 mm)
 Bore: 1" (25 mm)
 Blows per Minute: 4000 – 5200

FEATURES:

Removable Side Handle (SC3 series)
 Lever Operated Handle
 Rugged Steel Body



PISTON SCALERS

Model Number	Stroke Length		Bore Diameter		Blows per Minute	Weight		Length		Side to Center		Air Consumption Free Speed		Piston Type
	in	mm	in	mm		lb	kg	in	mm	in	mm	cfm	l/s	
Triple Piston Scaler														
SC3PA	13/16	21	1	25	5200	8.3	3.8	11	280	7/8	22	15	7	Steel
SC3PA-C	13/16	21	1	25	5200	8.3	3.8	11	280	7/8	22	15	7	Carbide Tipped

General: Air Inlet Size: 1/4" NPT • Recommended Hose Size: 3/8" (10 mm) • Performance rated @ 90 psig (6.2 bar) air pressure

Standard Equipment: Parts List • Safety and Instruction Manual

Accessories: Scaler Accessories, see pages 712-714

REPLACEMENT PISTONS

Part Number	Description
2387	Standard Steel Piston
2388	Standard Steel Piston (2" Longer Than Standard)
2390	Carbide Tipped Piston (Star Point)
2391	Solid Carbide Piston (Chisel Point)

PERFORMANCE:

Rivet Capacity: 5/32" (4.0 mm) – 1/4" (6.4 mm)
 Stroke: 2" (50 mm) – 4" (100 mm)
 Bore: 0.6" (15 mm)

FEATURES:

Pistol Grip
 Teasing Throttle Trigger Start
 Accepts .401 Parker Taper Rivet Sets and Chisels



HAMMERS

Model Number	Steel Rivet Capacity		Stroke Length		Bore Diameter		Blows per Minute	Weight		Length		Side To Center		Air Consumption	
	in	mm	in	mm	in	mm		lb	kg	in	mm	in	mm	cfm	l/s
270A-2	5/32	4	2	50	0.6	15	2500	3	1.4	5.8	147	1.1	28	8	4
270A	3/16	4.8	3	75	0.6	15	2000	3.2	1.5	6.8	173	1.1	28	8	4
270A-4	1/4	6.4	4	100	0.6	15	1700	3.5	1.6	7.8	198	1.1	28	8	4

General: Air Inlet Size: 1/4" NPT • Recommended Hose Size: 3/8" (10 mm) • Performance rated @ 90 psig (6.2 bar) air pressure

Standard Equipment: Parts List • Safety and Instruction Manual • Beehive Retainer

Accessories: Hammer Accessories, see pages 712-714

PERFORMANCE:

Stroke: 2" (50 mm) – 4" (100 mm)
 Bore: 1-1/8" (29 mm)

FEATURES:

Round Front End Bushing
 or Hex Front End Bushing



FOUR BOLT CHIPPING HAMMERS

Model Number	Bore		Stroke		Blows per Minute	Weight		Length		Side To Center		Air Consumption	
	in	mm	in	mm		lb	kg	in	mm	in	mm	cfm	l/s
Four Bolt Chipping Hammer – Round Front End Bushing													
CH42A-R	1 1/8	29	2	50	2100	18	8	16	405	1 5/8	41	33	15.6
CH43A-R	1 1/8	29	3	75	1650	19	8.6	17	430	1 5/8	41	34	16
CH44A-R	1 1/8	29	4	100	1375	20	9	18	455	1 5/8	41	35	16.5
Four Bolt Chipping Hammer – Hex Front End Bushing													
CH42A-H	1 1/8	29	2	50	2100	18	8	16	405	1 5/8	41	33	15.6
CH43A-H	1 1/8	29	3	75	1650	19	8.6	17	430	1 5/8	41	34	16
CH44A-H	1 1/8	29	4	100	1375	20	9	18	455	1 5/8	41	35	16.5

General: Air Inlet Size: 7/8"-24 NPT • Recommended Hose Size: 3/8" (10 mm) • Performance rated @ 90 psig (6.2 bar) air pressure

Standard Equipment: Parts List • Safety and Instruction Manual

Accessories: Four Bolt Chipping Accessories, see pages 712-714



FOUR BOLT CHIPPER ACCESSORIES

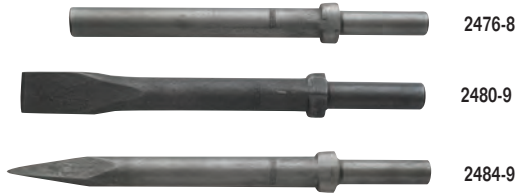

Part Number	For Use On
2476-8	Blank, 8", Oval Collar, Rd Shank
2477-8	Blank, 8", Oval Collar, Hex Shank
2478-8	Blank, 8", Rd Collar, Rd Shank
2479-8	Blank, 8", Rd Collar, Hex Shank
2476-11B	Blank, 11", Oval Collar, Rd Shank
2477-11	Blank, 11", Oval Collar, Hex Shank
2478-11	Blank, 11", Rd Collar, Rd Shank
2479-11	Blank, 11", Rd Collar, Hex Shank
2480-9	Chisel, 9", Oval Collar, Rd Shank
2481-9	Chisel, 9", Oval Collar, Hex Shank
2482-9	Chisel, 9", Rd Collar, Rd Shank
2483-9	Chisel, 9", Rd Collar, Hex Shank
2480-12	Chisel, 12", Oval Collar, Rd Shank
2481-12	Chisel, 12", Oval Collar, Hex Shank
2482-12	Chisel, 12", Rd Collar, Rd Shank
2483-12	Chisel, 12", Rd Collar, Hex Shank
2480-18	Chisel, 18", Oval Collar, Rd Shank
2481-18	Chisel, 18", Oval Collar, Hex Shank
2482-18	Chisel, 18", Rd Collar, Rd Shank
2483-18	Chisel, 18", Rd Collar, Hex Shank
2480-24	Chisel, 24", Oval Collar, Rd Shank
2481-24	Chisel, 24", Oval Collar, Hex Shank
2484-9	Moil Point, 9", Oval Collar, Rd Shank
2485-9B	Moil Point, 9", Oval Collar, Hex Shank
2486-9	Moil Point, 9", Rd Collar, Rd Shank
2487-9	Moil Point, 9", Rd Collar, Hex Shank
2484-12	Moil Point, 12", Oval Collar, Rd Shank
2485-12	Moil Point, 12", Oval Collar, Hex Shank
2486-12	Moil Point, 12", Rd Collar, Rd Shank
2487-12	Moil Point, 12", Rd Collar, Hex Shank
2484-18	Moil Point, 18", Oval Collar, Rd Shank
2485-18	Moil Point, 18", Oval Collar, Hex Shank
2486-18	Moil Point, 18", Rd Collar, Rd Shank
2487-18	Moil Point, 18", Rd Collar, Hex Shank
2484-24B	Moil Point, 24", Oval Collar, Rd Shank
2485-24	Moil Point, 24", Oval Collar, Hex Shank
2486-24	Moil Point, 24", Rd Collar, Rd Shank

FOUR BOLT CHIPPER ACCESSORIES



Part Number	For Use On
2488-9	Chisel, 1 1/2" x 9", Oval Collar, Rd Shank
2489-9	Chisel, 1 1/2" x 9", Oval Collar, Hex Shank
2490-9	Chisel, 1 1/2" x 9", Rd Collar, Rd Shank
2491-9	Chisel, 1 1/2" x 9", Rd Collar, Hex Shank
2488-12	Chisel, 1 1/2" x 12", Oval Collar, Rd Shank
2489-12	Chisel, 1 1/2" x 12", Oval Collar, Hex Shank
2490-12	Chisel, 1 1/2" x 12", Rd Collar, Rd Shank
2491-12	Chisel, 1 1/2" x 12", Rd Collar, Hex Shank
2488-18	Chisel, 1 1/2" x 18", Oval Collar, Rd Shank
2489-18	Chisel, 1 1/2" x 18", Oval Collar, Hex Shank
2490-18	Chisel, 1 1/2" x 18", Rd Collar, Rd Shank
2491-18	Chisel, 1 1/2" x 18", Rd Collar, Hex Shank
2492-9	Chisel, 2" x 9", Oval Collar, Rd Shank
2493-9	Chisel, 2" x 9", Oval Collar, Hex Shank
2494-9	Chisel, 2" x 9", Rd Collar, Rd Shank
2495-9B	Chisel, 2" x 9", Rd Collar, Hex Shank
2492-12	Chisel, 2" x 12", Oval Collar, Rd Shank
2493-12	Chisel, 2" x 12", Oval Collar, Hex Shank
2494-12	Chisel, 2" x 12", Rd Collar, Rd Shank
2495-12	Chisel, 2" x 12", Rd Collar, Hex Shank
2492-18	Chisel, 2" x 18", Oval Collar, Rd Shank
2493-18	Chisel, 2" x 18", Oval Collar, Hex Shank
2494-18	Chisel, 2" x 18", Rd Collar, Rd Shank
2495-18	Chisel, 2" x 18", Rd Collar, Hex Shank
2496-9	Bushing Tool, Oval Collar, Rd Shank
2497-9	Bushing Tool, Oval Collar, Hex Shank
2498-9	Bushing Tool, Rd Collar, Rd Shank
2499-9	Bushing Tool, Rd Collar, Hex Shank
2470	Quick Change Retainer

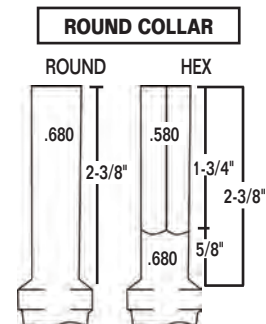
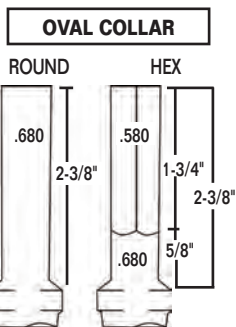



SCALER ACCESSORIES

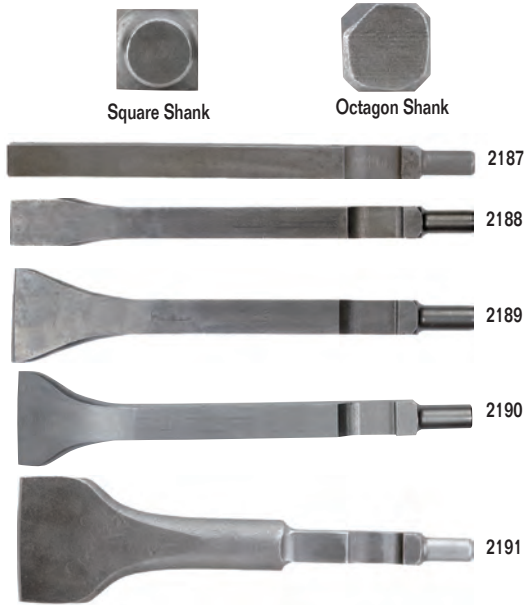

SC4 Chisels	SC8 Chisels	Description	Length		Width	
			in	mm	in	mm
2187	2287	Hardened Blank	7	175	5/8	16
2188	2288	Flat Chisel	7	175	3/4	19
2189	2289	Flat Chisel	7	175	1 3/8	35
2190	2290	Spoon Chisel	7	175	1 3/8	35
2191	2291	Flat Chisel	7	175	2	50
2192	2292	Flat Chisel	12	300	5/8	16
2193	2293	Flat Chisel	12	300	1 3/8	35
2194	2294	Spoon Chisel	12	300	1 3/8	35
2195	2295	Flat Chisel	12	300	2	50
2196	2296	Flat Chisel	18	450	5/8	16
2197	2297	Flat Chisel	18	450	1 3/8	35
2198	2298	Spoon Chisel	18	450	1 3/8	35
2199	2299B	Flat Chisel	18	450	2	50

SCALER KITS



SC4 SCALER KIT

Part No. SC41011AL-K

- SC4 Lever Needle Scaler
- Additional Set of Needles
- 3/4" x 7" Flat Chisel
- 1-3/8" x 7" Flat Chisel
- 1-3/8" x 7" Spoon Chisel
- Custom Carrying Case

SC8 SCALER KIT

Part No. SC80910AL-K

- SC8 Needle Scaler
- Additional Set of Needles
- 3/4" x 7" Flat Chisel
- 1-3/8" x 7" Flat Chisel
- 1-3/8" x 7" Spoon Chisel
- Custom Carrying Case

HAMMER ACCESSORIES

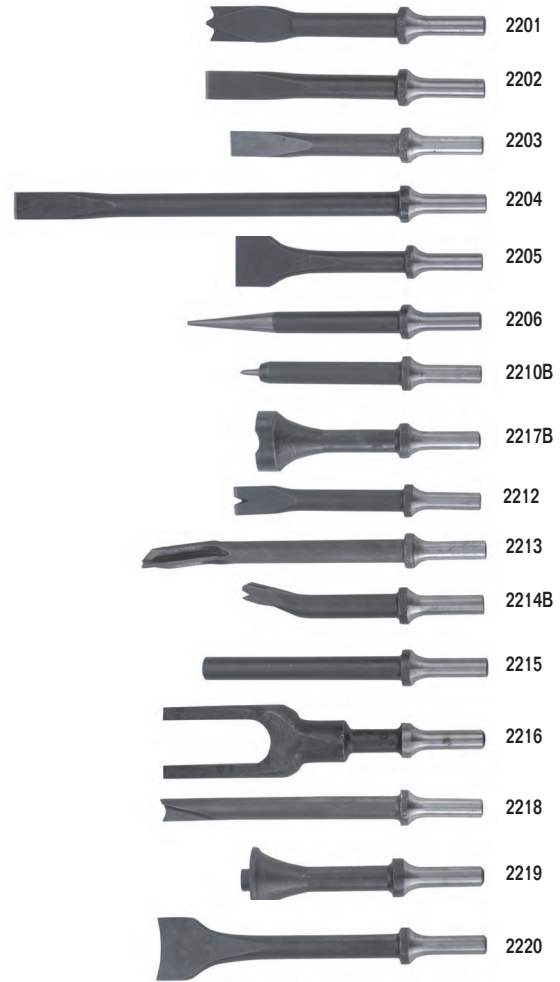

SC4 Chisels	Description	Width		Length	
		in	mm	in	mm
2201B	Cutter	5/8	16	6	150
2202B	Chisel	5/8	16	6	150
2203	Rivet Buster	5/8	16	5 1/2	140
2204	Expansion Chisel	5/8	16	11	280
2205	Scraper	1 1/4	30	6	150
2206	Punch			7	175
2210B	Punch			5	127
2217B	Rust Breaker			5 1/4	135
2212	Spot Weld Breaker			6	150
2213	Splitter			8	200
2214B	Edging Chisel			5	140
2215	Blank Chisel			6	150
2216	Fork Chisel			6 7/8	175
2218	Bushing Cutter			7	175
2219	Bushing Driver			4 1/2	115
2220	Bushing Chisel	1 5/8	40	7	175

SCALING NEEDLES

Part Number	Diameter	Length	Quantity	Used On
2260B	0.12"	5"	19	SC4, SC8 Scalers
2262	0.12"	7"	19	SC4, SC8 Scalers



BEEHIVE SPRING RETAINERS



Part Number	Description
2207	Chisel Retainer Spring
2208	Special Spring, use in place of 2207 with 2201, 2205, 2716, 2217, 2219 and 2220 Must use 2208 with 2239, 2244, 2245, 2246 and 2247

270 RIVET SETS

.401 Parker Taper Shank



Rivet Head Cupping	Rivet Diameter Size				
	3/32"	1/8"	5/32"	3/16"	1/4"
	Part No	Part No	Part No	Part No	Part No
Button Head	N/A	2229	2230B	2231	2244
Round Head	2232	2233	2234B	2235	2245
Brazier Head	2236	2237B	2238	2239	2246
Universal Head	2240	2241B	2242B	2243B	2247

3-1/2" (90 mm) overall length

RIVET SET PROFILES

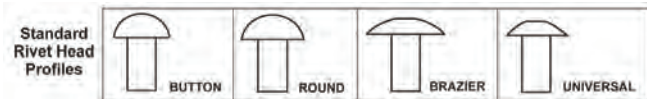

SPECIALTY



Special Applications Require Special Tools

Sioux Tools has a superb selection of specialty tools designed for very specific applications, and as always, we manufacture the finest tools in the industry.

ROUTERS

Sioux offers a selection of routers and laminate trimmers in 1.0 hp (0.75 kw) or 1.5 hp (1.1 kw) configurations. They feature lockoff lever, twist or finger throttles and come with a selection of different bases.

TAPPERS

Choose from pistol grip or inline configurations. The pistol grip offers chuck capacity from No. 10 thru 1/2" size.

METAL WORKING TOOLS NIBBLER AND SHEAR

Our 1.0 hp (0.75 kw) nibbler and shear has the power for use on cold rolled sheet steel up to 18 gauge.



POWER TOOLS

SPECIALTY

SHEARS

This versatile tool cuts 18 gauge steel and plastics up to 3/32" thick. It also makes straight or curve cuts clean and smooth.

AIRCRAFT SPECIALTY TOOLS

Sioux Tools offers several specialized tools for the aircraft industry such as Skin Clamp Runners, which are available in pistol grip or our exclusive Z-handle design. Rivet Shavers come in both pistol grip and inline configurations, with speeds up to 21,000 rpm.

CLINCH NUT TOOLS

As manufacturing trends continue to evolve manufacturers are finding more and more uses for thin wall assembly applications. Sioux Tools has a selection of Clinch Nut tools that handle these unique fasteners with precision and ease, and our Rapid Reverse feature makes them the best Clinch Nut tool on the market today.

AIR POWERED SAWS

Sioux Tools offers an outstanding and powerful Reciprocating Saw, offering variable speed control for precise cutting action in any application.





SRT10S25N



SRT10S25B



SRT10S25BB



SRT10S25LT

PERFORMANCE:

Power: 1 hp (0.75 kW)
Speed: 18,000 rpm – 25,000 rpm
Collet Size: 1/4" (6 mm)

FEATURES:

Lockoff Lever Throttle
Front Exhaust
Interchangeable Base
Built-in Speed Control

1 HP (0.75 KW) ROUTERS

Model Number	Collet Size	Free Speed		Weight		Height		Maximum Air Consumption		Sound Level
		rpm		lb	kg	in	mm	cfm	l/s	dB(A)
Template Nose										
SRT10S18N	1/4"	18,000		2.1	0.95	9	230	30	14	78
SRT10S18M6N	6 mm	18,000		2.1	0.95	9	230	30	14	78
SRT10S25N	1/4"	25,000		2.1	0.95	9	230	30	14	78
SRT10S25M6N	6 mm	25,000		2.1	0.95	9	230	30	14	78
3" Base										
SRT10S18B	1/4"	18,000		2.1	0.95	9	230	30	14	78
SRT10S18M6B	6 mm	18,000		2.1	0.95	9	230	30	14	78
SRT10S18BB	1/4"	18,000		2.6	1.15	8.3	210	30	14	78
SRT10S25B	1/4"	25,000		2.1	0.95	9	230	30	14	78
SRT10S25M6B	6 mm	25,000		2.1	0.95	9	230	30	14	78
SRT10S25BB	1/4"	25,000		2.6	1.15	8.3	210	30	14	78
Laminate Trimmer										
SRT10S18LT	1/4"	18,000		2.9	1.30	9.3	235	30	14	78
SRT10S25LT	1/4"	25,000		2.9	1.30	9.3	235	30	14	78

Template guides must be ordered separately

General: Air Inlet Size: 1/4" NPT • Recommended Hose Size: 3/8" (10 mm) • Performance rated @ 90 psig (6.2 bar) air pressure

Standard Equipment: Parts List • Safety and Instruction Manual • Base/Head Assembly, Collet, Collet Wrenches

Accessories: Router Accessories, see pages 726-727

PERFORMANCE:

Power: 1.5 hp (1.2 kW)
Speed: 20,000 rpm
Collet Size: 1/4" – 1/2"

FEATURES:

Twist and Finger Throttle
4" (102 mm) or 6" (152 mm)
Diameter Base
Side Exhaust



1981F



1980



RT1983

1.5 HP (1.2 KW) ROUTERS

Model Number	Collet Size	Free Speed		Weight		Height		Base Diameter		Maximum Air Consumption		Sound Level
		rpm		lb	kg	in	mm	in	mm	cfm	l/s	dB(A)
Finger Throttle												
1981F	1/2"	20,000		6	2.7	9.8	248	4	102	38	18	85
Twist Throttle												
1980A	1/4"	20,000		4.5	2	7.6	193	4	102	38	18	85
1980	3/8"	20,000		4.5	2	7.6	193	4	102	38	18	85
RT1981	1/2"	20,000		4.5	2	7.6	193	4	102	38	18	85
1982A	1/4"	20,000		7.5	3.4	8.3	211	6	152	38	18	85
RT1982	3/8"	20,000		7.5	3.4	8.3	211	6	152	38	18	85
RT1983	1/2"	20,000		4.8	2.2	8.3	211	6	152	38	18	85

General: Air Inlet Size: 1/4" NPT • Recommended Hose Size: 3/8" (10 mm) • Performance rated @ 90 psig (6.2 bar) air pressure

Standard Equipment: Parts List • Safety and Instruction Manual • Base & Collet Wrenches

Accessories: Router Accessories, see pages 726-727



SPECIALTY



The Fastest Way Out of a Clinch

Sioux Tool's new rapid reverse Clinch Nut Tools are meeting the demand of today's manufacturing marketplace with versatility and simplicity. Clinch nuts, also known as captive nuts, provide a reliable means of securing assembly components in thin wall applications. These unique fasteners are inserted into predrilled holes in thin materials such as sheet metal, and with the aid of a Sioux Clinch Nut Tool, compress and expand to clamp the material. This process creates a strong, secure base with a male or female thread for assembling additional components.

INSTALLING CLINCH NUT FASTENERS

When installing clinch nut fasteners, the key to achieving high productivity with accurate, repeatable results is matching the right tool and fastener to your application. The right combination of rundown speed and stall torque in conjunction with a quick reverse method for disengaging the tool, will provide the best results. The Sioux SCN series tools offer higher torque in a wide range of speeds so you can match the right tool to your application. Our powerful tools allow you to use faster rundown speeds while maintaining high torque output, plus our exclusive Rapid Reverse feature makes short work of direction changes ensuring fast disengagement from the fastener.

REDUCING PHYSICAL LOAD

The ergonomic pistol housing with comfort rubber grip ensures operator comfort while maintaining superb balance and control. The powerful, precision motor ensures fast and consistent installation of fasteners in a variety of applications, and the wide selection of speeds and threads in both English and metric sizes make Sioux Tools your choice for all your clinch nut applications.

CLINCH NUT INSTALLATION PROCEDURE

Step 1 - Pre-drill hole for fastener.



Step 2 - Insert fastener.

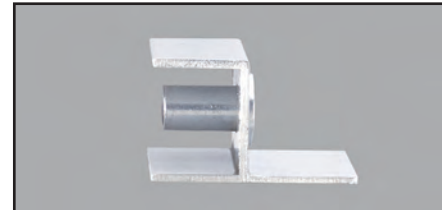

Step 3 - Thread tool into fastener.



**Step 4 - Run tool to collapse fastener.
Reverse tool to release.**

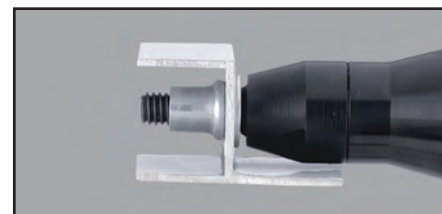

Step 5 - Assemble.



POWER TOOLS

SPECIALTY

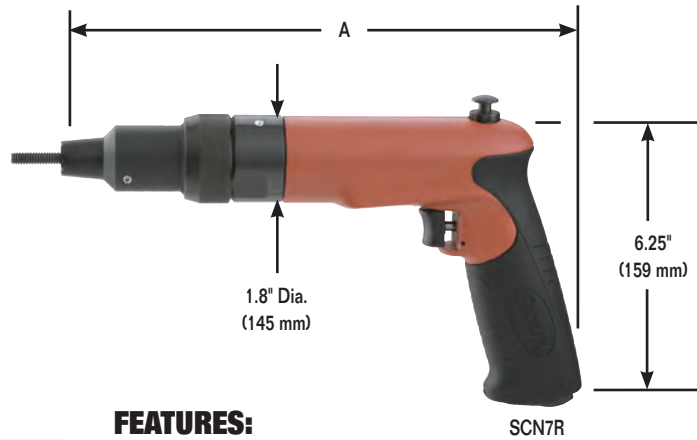

SCN7R

PERFORMANCE:

Torque: 60 in. lb (6.5 Nm) – 400 in. lb (45 Nm)
 Speed: 300 rpm – 2500 rpm

FEATURES:

Reversible
 Pistol Grip

POWER TOOLS

SPECIALTY: CLINCH NUT TOOLS

1 HP (0.75 KW) CLINCH NUT TOOLS



Model Number	Free Speed		Maximum Torque		Weight		"A" Dimension		Side To Center		Maximum Air Consumption		Sound Level
	rpm		in lb	Nm	lb	kg	in	mm	in	mm	cfm	l/s	dB(A)
Pistol Grip – Rapid Reverse – Power Units Specifications													
SCN3R	300		400	45.2	3.2	1.5	11	279	0.9	20	30	14	80
SCN5R	500		325	36.7	3.2	1.5	11	279	0.9	20	30	14	80
SCN7R	700		220	24.8	3.2	1.5	11	279	0.9	20	30	14	80
SCN12R	1200		145	16.4	3.2	1.5	11	279	0.9	20	30	14	80
SCN20R	2000		80	9	2.8	1.3	10	254	0.9	20	30	14	80
SCN25R	2500		60	6.5	2.8	1.3	10	254	0.9	20	30	14	80

Power units can be ordered separately using part number above. For ordering complete tools select the appropriate power unit from the chart above and head assembly from the chart below and combine their part numbers as shown in the following example: SCN3R420.

General: Air Inlet Size: 1/4" NPT • Recommended Hose Size: 3/8" (10 mm) • Performance rated @ 90 psig (6.2 bar) air pressure

Standard Equipment: Parts List • Safety and Instruction Manual • Comfort Grip

Accessories: Clinch Nut Accessories, see pages 726-727



CLINCH NUT (FEMALE)

Thread Size	Order Number Suffix	
	Serrated Nose	Smooth Nose
#4-40	440	440S
M3 x 0.5	M305	M305S
#6-32	632	632S
#8-32	832	832S
M4 x 0.7	M407	M407S
#10-24	1024	1024S
#10-32	1032	1032S
M5 x 0.8	M508	M508S
1/4-20	420	420S
M6 x 1.0	M610	M610S
5/16-18	518	518S
M8 x 1.25	M8125	M8125S
3/8-16	616	616S
M10 x 1.5	M1015	M1015S



CLINCH STUD (MALE)

Thread Size	Order Number Suffix	
	Serrated Nose	Smooth Nose
#4-40	440F	440SF
M3 x 0.5	M305F	M305SF
#6-32	632F	632SF
#8-32	832F	832SF
M4 x 0.7	M407F	M407SF
#10-24	1024F	1024SF
#10-32	1032F	1032SF
M5 x 0.8	M508F	M508SF
1/4-20	420F	420SF
M6 x 1.0	M610F	M610SF
5/16-18	518F	518SF
M8 x 1.25	M8125F	M8125SF
3/8-16	616F	616SF
M10 x 1.5	M1015F	M1015SF

Head assemblies can be ordered separately by adding the prefix SCN to the above part number (example SCN-420).



Safety Precaution: Read and follow all safety and operation instructions.
 Warning: Face & eye protection must be worn while operating power tools, per ANSI B186.1.



PERFORMANCE:

Power: 1 hp (0.75 kW)
 Torque: 145 in. lb (16 Nm) –
 400 in. lb (45 Nm)
 Speed: 300 rpm – 1200 rpm

FEATURES:

Pistol Grip Handle
 Rapid Reverse

CAPACITY:

1/4" in Steel
 5/16" in Aluminum

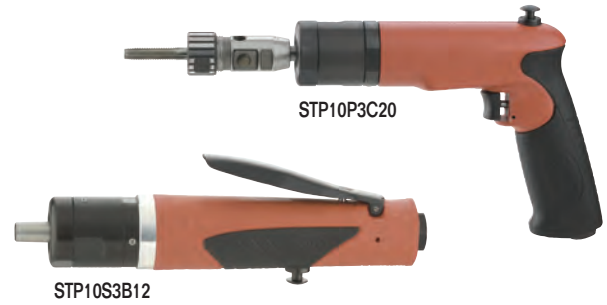

STP10P3C20

STP10S3B12



TAPPERS

Model Number	Chuck Capacity		Maximum Torque		Free Speed rpm	Weight		Length		Air Consumption		Sound Level dB(A)
	in	mm	in lb	Nm		lb	kg	in	mm	cfm	l/s	
1 hp (0.75 kW) – Pistol Grip – Trigger Start												
STP10P3C20	#10-5/16	5-8	400	45	300	2.9	1.3	7.3	185	30	14	80
STP10P3C32	1/4-1/2	6-13	400	45	300	2.9	1.3	7.3	185	30	14	80
1 hp (0.75 kW) – Inline – B12 Taper Spindle												
STP10S12B12			145	16	1200	2.5	1.2	9.5	240	30	14	78
STP10S7B12			220	25	700	2.5	1.2	9.5	240	30	14	78
STP10S5B12			325	37	500	2.5	1.2	9.5	240	30	14	78
STP10S3B12			400	45	300	2.5	1.2	9.5	240	30	14	78

General: Air Inlet Size: 1/4" NPT • Recommended Hose Size: 3/8" (10 mm) • Performance rated @ 90 psig (6.2 bar) air pressure

Standard Equipment: Parts List • Safety and Instruction Manual • Comfort Grip • Tapping Chuck (model STP10P3C series)

Accessories: Tapper Accessories, see pages 726-727

PERFORMANCE:

Power: 0.6 hp (0.45 kW) - 1 hp (0.75 kW)
 Speed: 21,000 rpm

FEATURES:

Pistol Grip & Inline



SRS6P21-8

SRS10P21-8

SRS10S21-8



RIVET SHAVERS

Model Number	Cutter Diameter		Free Speed rpm	Weight		Length		Side to Center		Maximum Air Consumption		Sound Level dB(A)
	in	mm		lb	kg	in	mm	in	mm	cfm	l/s	
0.6 hp (0.45 kW) – Pistol Grip – 1/4"-28 Internal Thread												
SRS6P21-5	5/16	8	21,000	2	0.9	6.5	165	0.8	21	25	12	84
SRS6P21-6	3/8	10	21,000	2	0.9	6.5	165	0.8	21	25	12	84
SRS6P21-7	7/16	11	21,000	2	0.9	6.5	165	0.8	21	25	12	84
SRS6P21-8	1/2	13	21,000	2	0.9	6.5	165	0.8	21	25	12	84
SRS6P21-9	9/16	14	21,000	2	0.9	6.5	165	0.8	21	25	12	84
SRS6P21-10	5/8	16	21,000	2	0.9	6.5	165	0.8	21	25	12	84
SRS6P21-9W	9/16	14	21,000	2	0.9	6.5	165	0.8	21	25	12	84
1 hp (0.75 kW) – Pistol Grip – 1/4"-28 Internal Thread												
SRS10P21-5	5/16	8	21,000	2.7	1.2	8	205	0.9	23	25	12	80
SRS10P21-6	3/8	10	21,000	2.7	1.2	8	205	0.9	23	25	12	80
SRS10P21-7	7/16	11	21,000	2.7	1.2	8	205	0.9	23	25	12	80
SRS10P21-8	1/2	13	21,000	2.7	1.2	8	205	0.9	23	25	12	80
SRS10P21-9	9/16	14	21,000	2.7	1.2	8	205	0.9	23	25	12	80
SRS10P21-10	5/8	16	21,000	2.7	1.2	8	205	0.9	23	25	12	80
1 hp (0.75 kW) – Inline – 1/4"-28 Internal Thread												
SRS10S21-8	1/2	13	21,000	2.5	1.1	10	255	0.9	23	30	14	78

General: Air Inlet Size: 1/4" NPT • Recommended Hose Size: 3/8" (10 mm) • Performance rated @ 90 psig (6.2 bar) air pressure

Standard Equipment: Parts List • Safety and Instruction Manual • Skirt • Comfort Grip (Pistol Grip models)

Accessories: Rivet Shaver Accessories, see pages 726-727



PERFORMANCE:

Speed: 2200 rpm - 2500 rpm

FEATURES:

Pistol Grip and Z-Handle
1/2-12 Point Internal, 9/16-6 Point External Hex



SKIN CLAMP RUNNERS

Model Number	Free Speed		Weight		Length		Side to Center		Air Consumption Free Speed		Sound Level dB(A)
	rpm		lb	kg	in	mm	in	mm	cfm	l/s	
Z-Handle 2S2300SR	2200		2.6	1.2	5.7	145	0.9	23	16	8	75
Pistol Grip SSR6P25	2500		2.7	1.2	9.2	234	0.9	23	30	14	78

General: Air Inlet Size: 1/4" NPT • Recommended Hose Size: 3/8" (10 mm) • Performance rated @ 90 psig (6.2 bar) air pressure

Standard Equipment: Parts List • Safety and Instruction Manual • Comfort Grip (Pistol Grip models)

Accessories: Skin Clamp Runner Accessories, see pages 726-727

PERFORMANCE:

Power: 1 hp (0.75 kW)
Strokes per Minute: 1800
Stroke Length: 0.6" (15 mm)

FEATURES:

Lockoff Trigger Start
Variable Speed
Swivel Air Inlet



RECIPROCATING SAW

Model Number	Stroke Length		Strokes per Minute	Power		Weight		Length		Air Consumption		Sound Level dB(A)
	in	mm		hp	kW	lb	kg	in	mm	cfm	l/s	
1300	0.6	15	1800	1	0.7	7.8	3.5	17.2	437	35	17	86

General: Air Inlet Size: 1/4" NPT • Recommended Hose Size: 3/8" (10 mm) • Performance rated @ 90 psig (6.2 bar) air pressure

Standard Equipment: Parts List • Safety and Instruction Manual • Swivel Air Inlet • 2 Blades • Protective Boot

Accessories: Reciprocating Saw Accessories, see pages 726-727

PERFORMANCE:

Free Speed: 10,000 rpm
Stroke Length: 0.375" (10 mm)
Cuts up to 1/8" (3 mm) mild steel

FEATURES:

Lock-off lever start
Low vibration
360° Adjustable Exhaust Deflector
Dual chuck accepts: 0.035" standard
air saw blades AND 6" long reciprocating saw blades



RECIPROCATING SAW

Model Number	Stroke Length		Strokes per Minute	Weight		Length		Air Consumption		Sound Level dB(A)
	in	mm		lb	kg	in	mm	cfm	l/s	
RS10K	0.375	10	10,000	1.53	0.69	9.4	238.76	1	0.5	87.1

General: Air Inlet Size: 1/4" NPT • Recommended Hose Size: 3/8" (10 mm) • Performance rated @ 90 psig (6.2 bar) air pressure

Standard Equipment: Parts List • Safety and Instruction Manual • Swivel Air Inlet • 2 Blades • Protective Boot

Accessories: Reciprocating Saw Accessories, see pages 726-727





PERFORMANCE:

Power: 1 hp (0.75 kW)
Free Speed: 18,000 rpm – 25,000 rpm

FEATURES:

Inline
Lockoff Lever Start
Front or Rear Exhaust



SCO10S253F



POWER TOOLS

CUTOFF TOOL

Model Number	Blade Diameter		Depth of Cut		Free Speed rpm	Weight		Length		Air Consumption		Sound Level dB(A)	Exhaust
	in	mm	in	mm		lb	kg	in	mm	cfm	l/s		
1 hp (0.75 kW) – Cutoff Tool – Inline – Lockoff lever Start													
SCO10S184F	4	100	1.1	28	18,000	2	0.9	8.3	210	30	14	89.1	Front
SCO10S184R	4	100	1.1	28	18,000	2	0.9	8.3	210	30	14	87.8	Rear
SCO10S204F	4	100	1.1	28	20,000	2	0.9	8.3	210	30	14	90.3	Front
SCO10S204R	4	100	1.1	28	20,000	2	0.9	8.3	210	30	14	91.6	Rear
SCO10S253F	3	76	1	25	25,000	2	0.9	8.3	210	30	14	89	Front
SCO10S253R	3	76	1	25	25,000	2	0.9	8.3	210	30	14	87.8	Rear

General: Air Inlet Size: 1/4" NPT • Recommended Hose Size: 3/8" (10 mm) • Performance rated @ 90 psig (6.2 bar) air pressure
Standard Equipment: Parts List • Safety and Instruction Manual • 1 Blade • Spindle Wrenches & Guard
Accessories: Panel and Cutoff Saw Accessories, see pages 726-727

FEATURES:

Heavy duty spiral bevel gearing for durability and smooth operation

4 position indexable angle head
360 degree rotatable guard
Grease zerk in gear case



SCO10A106



SPECIALTY: CUTOFF TOOLS

ANGLE CUTOFF TOOL

Model Number	Blade Diameter		Depth of Cut		Free Speed rpm	Weight		Length		Air Consumption		Sound Level dB(A)	Spindle Thread	Exhaust
	in	mm	in	mm		lb	kg	in	mm	cfm	l/s			
SCO7A184	4	100	1.2	30	18,000	2.5	1.4	6.4	163	25	12	TBD	3/8"-24	Front
SCO10A106	6	150	2	51	10,000	3.7	1.7	8.75	220	35	16.5	91.2	3/8"-11	Rear
SCO10A125	5	125	1.5	38	12,000	3.5	1.6	8.75	220	35	16.5	87.3	5/8"-11	Rear
SCO10A184	4	100	1.2	30	18,000	2.5	1.4	7.75	195	35	16.5	TBD	3/8"-24	Rear
SCO10AXL124	4	100	1	25	12,000	3.6	1.6	11.25	285	35	17	83.7	3/8"-24	Rear

General: Air Inlet Size: 1/4" NPT • Recommended Hose Size: 3/8" (10 mm) • Performance rated @ 90 psig (6.2 bar) air pressure
Standard Equipment: Parts List • Safety and Instruction Manual • 1 Blade • Spindle Wrenches & Guard
Accessories: Angle Cutoff Tool Accessories, see page 726-727



SCO1AX124



SCO1AX124G



ANGLE METAL BODY EXTENDED CUTOFF TOOL

Model Number	Blade Diameter		Depth of Cut		Free Speed rpm	Weight		Length		Air Consumption		Sound Level dB(A)	Spindle Thread	Exhaust
	in	mm	in	mm		lb	kg	in	mm	cfm	l/s			
1 hp (0.75 kW) – Lever Throttle – Aluminum Housing														
SCO1AX124	4	100	1	25	12,000	3.9	1.8	10.5	267	35	16.5	88	3/8" - 24	Front
1 hp (0.75 kW) – Lever Throttle – Aluminum Housing with Grip														
SCO1AX124G	4	100	1	25	12,000	3.6	1.6	10.5	267	35	16.5	88	3/8" - 24	Front
1 hp (0.75 kW) – Lever Throttle – Steel Housing														
SCOS1AX124	4	100	1	25	12,000	4.5	2	10.5	267	35	16.5	89	3/8" - 24	Front
1 hp (0.75 kW) – Lever Throttle – Steel Housing with Grip														
SCOS1AX124G	4	100	1	25	12,000	4.1	1.9	10.5	267	35	16.5	87	3/8" - 24	Front

General: Air Inlet Size: 1/4" NPT • Recommended Hose Size: 3/8" (10 mm) • Performance rated @ 90 psig (6.2 bar) air pressure
Standard Equipment: Parts List • Safety and Instruction Manual • 1 Blade • Spindle Wrenches & Guard
Accessories: Angle Cutoff Tool Accessories, see page 726-727



PERFORMANCE:

Power: 1 hp (0.75 kW)
Capacity: 18 Gauge Cold Rolled Steel



SNH10S18

NIBBLER

Model Number	Capacity (Cold Rolled Steel)		Power		Weight		Length		Side to Center		Maximum Air Consumption		Sound Level dB(A)
	in		hp	kW	lb	kg	in	mm	in	mm	cfm	l/s	
Nibbler													
SNH10S18 ¹	18 Ga		1	0.75	2.65	1.2	8.5	215	0.9	32	30	14	82.4

¹ Not CE Certified

General: Air Inlet Size: 1/4" NPT • Recommended Hose Size: 3/8" (10 mm) • Performance rated @ 90 psig (6.2 bar) air pressure

Standard Equipment: Parts List • Safety and Instruction Manual

Accessories: Nibbler Accessories, see pages 726-727

PERFORMANCE:

Power: 1 hp (0.75 kW)
Capacity: 18 Gauge Cold Rolled Steel



SSH10S18



SSH10P18

SHEARS

Model Number	Capacity (Cold Rolled Steel)		Power		Weight		Length		Side to Center		Maximum Air Consumption		Sound Level dB(A)
	in		hp	kW	lb	kg	in	mm	in	mm	cfm	l/s	
Shears													
SSH10S18 ¹	18 Ga		1	0.75	2.75	1.25	11	280	0.9	32	30	14	79.4
SSH10P18	18 Ga		1	0.75	2.9	1.3	10	255	0.9	22	30	14	85.1

¹ Not CE Certified

General: Air Inlet Size: 1/4" NPT • Recommended Hose Size: 3/8" (10 mm) • Performance rated @ 90 psig (6.2 bar) air pressure

Standard Equipment: Parts List • Safety and Instruction Manual • Comfort Grip (SSH10P18)

Accessories: Shears Accessories, see pages 726-727



SPECIALTY

Compression Riveters



POWER TOOLS

SPECIALTY

PRINCIPLES OF OPERATION

Air powered compression riveters deliver a squeezing action, which drives the rivet by "flowing" the rivet metal with compressed forces. Squeezing action is obtained by coupling an air cylinder and piston to a wedge or cam, thus multiplying the original force to extreme ratios. High compressive forces are obtained from a relatively compact unit having small diameter cylinders and using very little compressed air.

The advantage of squeeze riveting is simple sounds of air exhaust and forward piston movement developing tremendous pressures being exerted at the work point.

Optimum control may be obtained in compression riveting. The rivet head is formed by a steady, uniform squeeze action. The set plunger and dolly are an integral part of the squeezer itself.

Length of the return stroke may be adjusted that the plunger itself does not have to travel its full length.

Consistently applied pressure makes for a better appearance of the finished product as well as giving the ultimate in structural efficiency.

CLASSIFICATION OF SQUEEZERS:

Alligator: The squeezing action of the jaws are similar to the movement of an Alligators jaws.

'C' Type: The rivet is squeezed between the two ends of the 'C'.

Type of Rivet:

- Rivet material.
- Rivet body diameter.
- Rivet length before and after compression.
- Force required to compress rivet.

Riveter Selection Guide:

- What material is the rivet made from?
- What size is the rivet?
- What is the form of the head?
- What components are being assembled?

- Are there any clearance problems?
- Is Alligator or 'C' type yoke required?
- How is the application being done now?
- Are there any special considerations?

COMPRESSION RIVETERS

For maximum power the combined length of the two rivet sets must be of the correct length.

Determine the correct lengths as follows:

1) When two cupped rivet sets are used:

The length of the body dimensions of the two rivet sets (A1, A2) should equal the closed height dimension of the yoke (H) minus the total thickness of material being riveted together.

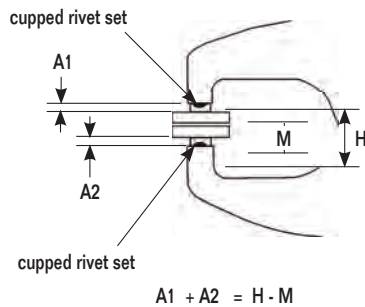

3) When two flush sets are used:

The length of the body dimensions of the two rivet sets (A1, A2) should equal the closed height dimension of the yoke (H) minus the overall length of the rivet (M) after it is compressed.

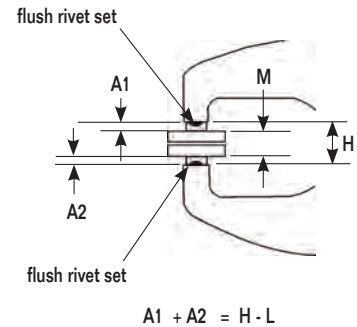

2) When one cupped set and one flush set are used:

The length of the body dimensions of the two rivet sets (A1, A2) should equal the closed height dimension of the yoke H minus the total thickness of material being riveted (M) and the height of the finished rivet head (Z) compressed by the flush set (A).

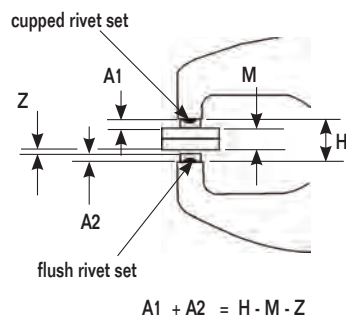

If necessary, select rivet sets a little short and shim to the correct length using spacer shims.

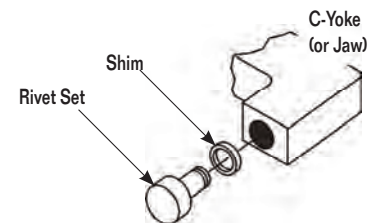



FEATURES:

- Single, Tandem, and Triple Cylinder Options
- Riveting Capacity:
 - 1/8" (3 mm) (Single Cylinder)
 - 3/16" (5 mm) (Tandem Cylinder)
 - 1/4" (6 mm) (Triple Cylinder)
- Safety Throttle



SZE5030



SZE7030



SZE9030

COMPRESSION RIVETERS

Model Number	Rivet Set Shank Diameter		Cap Cold Rivet Diameter				Standard Alligator Yoke Dimension				Max Force at 90 psi		Moving Jaw				Net Weight w/Yoke		Overall Length	
			Steel		Alum		Reach		Closed Ht				Max Travel		Stroke at Max Force					
			in	mm	in	mm	in	mm	in	mm			in	mm	in	mm				
CR-1 - Single Cylinder																				
SZE5000	NA	NA	3/32	2	1/8	3	NA	NA	NA	NA	3000	13.4	5/8	16	final 1/16	2	2 1/4	1	7 1/16	195
SZE5015	3/16	5	3/32	2	1/8	3	1 1/2	38	7/8	22	3000	13.4	5/8	16	final 1/16	2	3.75	1.7	9 3/16	233
SZE5022	3/16	5	3/32	2	3/32	2	2 1/4	57	7/8	22	2200	9.8	7/8	22	final 3/32	2	4.25	1.9	10 1/8	257
SZE5030	3/16	5	3/32	2	3/32	2	3	76	7/8	22	1800	8	1 1/4	32	final 1/8	3	4.75	2.2	10 7/8	276
CR-1 - Tandem Cylinder																				
SZE7000	NA	NA	5/32	4	3/16	5	NA	NA	NA	NA	6000	26.7	5/8	16	final 1/16	2	4	1.8	10 1/2	267
SZE7015	3/16	5	5/32	4	3/16	5	1 1/2	38	7/8	22	6000	26.7	5/8	16	final 1/16	2	5.5	2.5	12	305
SZE7022	3/16	5	1/8	3	3/32	4	2 1/4	57	7/8	22	4300	19.1	7/8	22	final 3/32	2	6	2.7	13	330
SZE7030	3/16	5	3/32	2	1/8	3	3	76	7/8	22	3400	15.1	1 1/4	32	final 1/8	3	6.25	2.8	13.75	349
CR-1 - Triple Cylinder																				
SZE9000	NA	NA	3/16	5	1/4	6	NA	NA	NA	NA	9000	40.1	5/8	16	final 1/16	2	5.5	2.5	14.5	368
SZE9015	3/16	5	3/16	5	1/4	6	1 1/2	38	7/8	22	9000	40.1	5/8	16	final 1/16	2	7	3.2	16	406
SZE9022	3/16	5	5/32	4	3/16	5	2 1/4	57	7/8	22	7000	31.2	7/8	22	final 3/32	2	7.5	93.4	16.75	426
SZE9030	3/16	5	5/32	4	3/16	5	3	76	7/8	22	5200	23.1	1 1/4	32	final 1/8	3	8	3.6	17.5	445

General: Air Inlet Size: 1/4" NPT • Recommended Hose Size: 3/8" (10 mm) • Performance rated @ 90 psig (6.2 bar) air pressure
Standard Equipment: Parts List • Safety and Instruction Manual • Safety throttle action

ALLIGATOR YOKE NOMENCLATURE

- A** Reach
- B** Closed Height
- C** Total
- E** Gap
- H** Lowest Offset
- N** Depth from centerline to Stationary Jaw Gap
- P** Depth from centerline to Stationary Jaw set hole surface

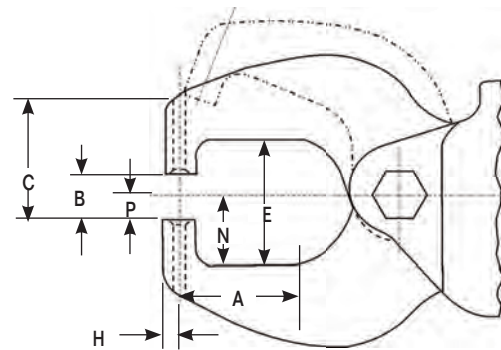

A		B		C		E		H		N		P	
in	mm	in	mm	in	mm	in	mm	in	mm	in	mm	in	mm
1 1/2	38	7/8	22	1 1/2	38	1 5/8	41	7/32	6	1.0	1	5/8	16
2 1/4	57	7/8	22	1 7/8	48	2 1/8	54	7/32	6	1 1/4	32	5/8	16
3	76	7/8	22	2 1/8	54	2 1/8	54	7/32	6	1 1/4	32	5/8	16





FEATURES:

- Single, Tandem, and Triple Cylinder Options
- Riveting Capacity:
 - 1/8" (3 mm) (Single Cylinder)
 - 3/16" (5 mm) (Tandem Cylinder)
 - 1/4" (6 mm) (Triple Cylinder)
- Safety Throttle



COMPRESSION RIVETERS

Model Number	Rivet Set Shank Diameter		Cap Cold Rivet Diameter				Standard "C" Yoke Dimension				Closed Height		Max Travel		Max Force at 90 psi		Stroke at Max Force		Net Weight w/Yoke		Overall Length	
	in	mm	Steel	Alum	in	mm	Reach	Gap	in	mm	in	mm	in	mm	lb	kN	in	mm	lb	kg	in	mm
CR-1 - Single Cylinder																						
SZE3000	N/A	N/A	3/32	2	1/8	3	N/A	N/A	N/A	N/A	N/A	N/A	1/16	14	3000	13.4	f-1/16	2	3 1/2	1.6	8 1/2	216
SZE3015	3/16	5	3/32	2	1/8	3	1 1/2	38	1 1/4	32	1 1/16	78	1/16	14	3000	13.4	f-1/16	2	4 1/2	2	10 1/4	262
CR-1 - Tandem Cylinder																						
SZE6000	N/A	N/A	5/32	4	3/16	5	N/A	N/A	N/A	N/A	N/A	N/A	1/16	14	6000	26.7	f-1/16	2	4 1/2	2	11 1/4	287
SZE6015	3/16	5	5/32	4	3/16	5	1 1/2	38	1 1/4	32	1 1/16	78	1/16	14	6000	26.7	f-1/16	2	5 1/2	2.5	14	356
CR-1 - Triple Cylinder																						
SZE8000	N/A	N/A	5/32	4	1/4	6	N/A	N/A	N/A	N/A	N/A	N/A	1/16	14	9000	40.1	f-1/16	2	7 1/2	3.4	16	406
SZE8015	3/16	5	3/16	5	1/4	6	1 1/2	38	1 1/4	32	1 1/16	78	1/16	14	9000	40.1	f-1/16	2	8 1/2	3.9	18 3/4	476

Due to a variety of jobs and applications, Squeeze Riveters are not supplied with rivet sets. Please contact Sioux Tools, Inc. or your local distributor for rivet set information.
General: Air Inlet Size: 1/4" NPT • Recommended Hose Size: 3/8" (10 mm) • Performance rated @ 90 psig (6.2 bar) air pressure
Standard Equipment: Parts List • Safety and Instruction Manual • Safety throttle action

C-YOKE NOMENCLATURE

- A** Reach
- B** Gap
- C** Height from yoke hole to center to top of yoke gap
- D** Bottom set hole diameter CR-1 or CR-2
- E** Top set hole diameter CR-1 or CR-2
- F** Width of yoke set hole center to top of yoke
- G** Thickness of yoke
- H** Height of yoke from bolt hole center to top of yoke
- I** Radius from set hole center

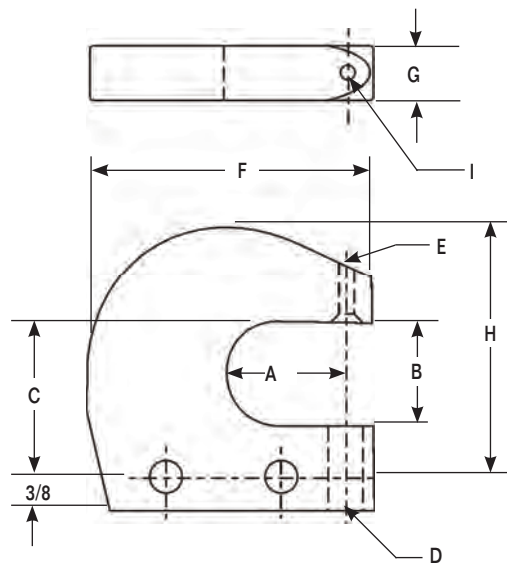

A		B		C		D		E		F		G		H		I	
in	mm	in	mm	in	mm	in	mm	in	mm	in	mm	in	mm	in	mm	in	mm
1 1/2	38	1 1/4	32	1 7/8	48	3/8	10	3/16	5	2 7/8	73	1/16	14	3	76	1/4	6
						7/16	11	1/4	6								

POWER TOOLS

SPECIALTY: RIVETERS



RIVET SHAVER SKIRTS



3/4-16 Thread

2925-8B

Part Number	Cutter Diameter	
	in	mm
2925-5	5/16	8
2925-6	3/8	10
2925-7	7/16	11
2925-8B	1/2	13
2925-9	9/16	14
2925-9W	9/16	14
2925-10	5/8	16

STABILIZER

Part Number	For Use On
7427A	SRS6P21 series



74274A

COLLETS



44440



21126B

Collet Type	Part Number	Capacity	For Use On
Sioux	44440	1/4"	1971HP series
Sioux	66038	6 mm	1971HP series
100 Series	21126B	1/4"	1980A, 1982A, RT1985
100 Series	21125	3/8"	1980, RT1982, 1985A
100 Series	21124	1/2"	1981F, RT1981, RT1983, 1985-1/2



21095

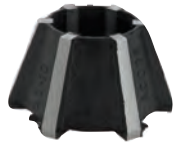

21139

Collet Type	Collets
21095	#10 - 9/16"
21139	1/4" - 1/2"

SUPPORT HANDLE

Part No. 2355B



SIGNATURE SERIES SUPPORT HANDLE

Part No. SPSDR-14A



COLLET CHUCK ASSEMBLIES

Sioux Style Collets

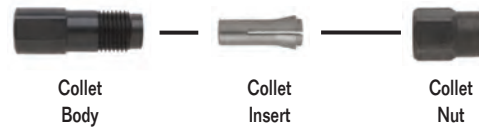

Collet Chuck Assemblies	Sioux Collet Chuck				
	1/8"	3 mm	3/16"	1/4"	6 mm
Chuck Assembly	43342	68617	43341	43340	68618
Collet Body	21096	21096	21096	21096	21096
Collet Insert	44522	66037	44523	44440	66038
Collet Nose	N/A	N/A	N/A	N/A	N/A
Collet Nut	21097	21097	21097	21097	21097

200 Series Heavy Duty Double Tapered Collet



Part Number	Description
74071	Collet Nut
74072	Collet (1/8")
74073	Collet (3/16")
74074	Collet (1/4")
77400	Collet (1/4") Heavy Duty
68030	Collet (3/8")
74075	Collet (3 mm)
74076	Collet (6 mm)
68056	Collet (8 mm)
77057	Collet Body SDG Series
74070	Collet Body (1 hp)

300 Series Heavy Duty Double Tapered Collet



Part Number	Description
74128	Collet Nut
74124	Collet (3/32")
74121	Collet (1/8")
74120	Collet (1/4")
74122	Collet (3 mm)
74123	Collet (6 mm)
77505	Collet Body SAS Series
74125	Collet Body SDG Series





ROUTER BASE ASSEMBLY



Part Number	Used On
1992	SRT10S25BB
1993	1971HP / SRT10S25BB
1994	1971HPC / SRT10S25BB

LAMINATE BASE TRIMMER

Part No. 1991

For use on SRT10S25LT series routers



RECIPROCATING SAW BLADES

Packaged in Cartons of 5



1815



1816

Part Number	Length		Teeth Per Inch
	in	mm	
For Use on Model 1300			
1815	6	150	10
1810	6	150	14
1813	4	100	14
1811	6	150	18
1812	4	100	18
1814	6	150	24
1816	6	150	6
1819	12	300	6

TEMPLATE GUIDE CHART

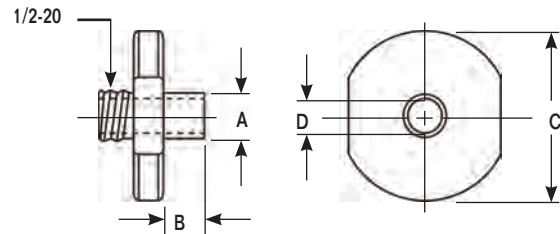

Part Number	Dimensions in Inches			
	A Pilot OD	B Pilot Length	C Flange OD	D Pilot ID
68613-12	3/8	1/4	3/4	9/32
68613-14	3/8	3/8	3/4	9/32
68613-16	3/8	1/2	3/4	9/32
68613-22	3/8	1/8	1 1/2	9/32
68613-24	3/8	1/4	1 1/2	9/32
68613-26	3/8	3/8	1 1/2	9/32
68613-40	7/16	1/4	3/4	21/64
68613-42	7/16	3/8	3/4	21/64
68613-44	7/16	1/2	1 1/2	21/64
68613-48	7/16	1/4	1 1/2	21/64
68613-50	7/16	3/8	1 1/2	21/64
68613-52	7/16	1/2	1 1/2	21/64
68613-62	1/2	1/4	1 1/2	11/32
68613-64	1/2	3/8	1 1/2	11/32
68613-66	1/2	1/2	1 1/2	11/32
68613-72	1/2	1/2	2 1/2	11/32

POWER TOOLS

SPECIALTY ACCESSORIES



FILTER, REGULATOR, LUBRICATOR ASSEMBLY

Part No. 1660B

1/2" NPT fittings
Air Flow: 30 – 75 cfm



Part Number	Description
1660B	Complete Air Control Unit, 1/2" PT
1661	Lubricator Only, 1/2" PT
1662A	Regulator with Gauge, 1/2" PT
1663	Manual Flex Drain Filter, 1/2" PT
1667	Automatic Drain - Optional

FILTER, REGULATOR, LUBRICATOR ASSEMBLY

Part No. 1651MA

3/4" NPT air fittings
Air Flow: Over 75 cfm



Part Number	Description
1651MA	Complete Automatic Air Control Unit, 3/4" PT, larger capacity and float type filter for automatic drain
1652M	Lubricator only, 3/4" PT, 1 quart capacity
1654B	Regulator with Gauge, 3/4" PT
1653MA	Automatic Air Filter, 3/4" PT, automatic float drain empties when full

AIR REGULATOR

Part No. 1335B

- 1/4" NPT Male/Female
- Mounts inline with air inlet
- Allows fine adjustment of air flow



HI-CAPACITY QUICK CHANGE COUPLERS



1316



1391



1395

Part Number	Description	Thread
1316	Male Coupler Nipple	1/4" NPT
1317	Male Coupler Nipple	3/8" NPT
1318	Male Coupler Nipple	1/2" NPT
1391B	Quick Change Coupler	1/4" NPT
1392B	Quick Change Coupler	3/8" NPT
1393	Quick Change Coupler	1/2" NPT
1395	Female Coupler Nipple	1/4" NPT
1396	Female Coupler Nipple	3/8" NPT

NYLON RECOIL AIR HOSE



1326

Part Number	ID		Length		Fittings
	in	mm	ft	m	
1326B	1/4	6	25	7.6	1/4" NPT
1327B	3/8	10	25	7.6	1/4" NPT

SIoux-PER SWIVEL

Allows the air hose to rotate 360° on 2 axes.



1338-25



1338FC-25

Part Number	Description
1338-25	1/4" non-regulated air swivel connector with safety pin
1338-38	3/8" non-regulated air swivel connector with safety pin
1338-50	1/2" non-regulated air swivel connector with safety pin
1338FC-25	1/4" regulated air swivel connector with safety pin

BALANCERS



2300-4B

Part Number	Capacity		Cable Length	
	lb	kg	ft	m
2300-4B	2 - 4	0.9 - 1.8	5.2	1.6
2300-6	4 - 6	1.8 - 2.7	6.7	2
2300-8B	6 - 8	2.7 - 3.6	6.7	2





GREASE GUN

Part No. 439

Use with impact wrenches and multi-assembly angle tools.
For use with grease tube 1232A-04.



GREASE NOZZLE

Part No. 469A

Used with No. 468A grease gun.



GREASE

Part Number	Description
289A	1 Quart
289A-1	2 Pounds
289A-2	6 Pounds
1198	6 Ounces
1198-1	2 Pounds
1198-2	6 Pounds
1232A-04	4 Ounces
1232A-1	1 Quart

AIR MOTOR OIL FOR AIR TOOLS

Part No. 288

1/2 Pint

Part No. 288-1

1 Quart

Part No. 288-2

2 Liter



POWER TOOLS

GENERAL ACCESSORIES



We Take On Any Job... Bit By Bit

INDUSTRY LEADER

Regarded as the Number 1 choice in the industry, Sioux Tools' pneumatic drills are known around the world for their exceptional engineering and construction. A wide range of configurations, speeds, and options ensure a perfect match for any application. Choose from pistol grip, inline and right angle designs that will help you get the job done fast and efficiently. Sioux also offers a complete line of accessories including a huge section of hole saws.

DESIGNED TO WORK

Sioux Tools offers one of the widest selections of drills on the market today. With free speeds from 550 to 2,500 rpm we have the right drill for any application, for use with any type material. The gears are designed and built tough to handle demanding jobs, yet even under load, operate quietly and efficiently. Sioux drills come in both reverse and non-reverse models.

ERGONOMICS

All Sioux Drills offer ergonomic features to provide maximum comfort during operation. Many models include comfortable insulating grips to reduce cold and vibration. Due to the high torque output, model 5450R includes a auxiliary support handle for more control.

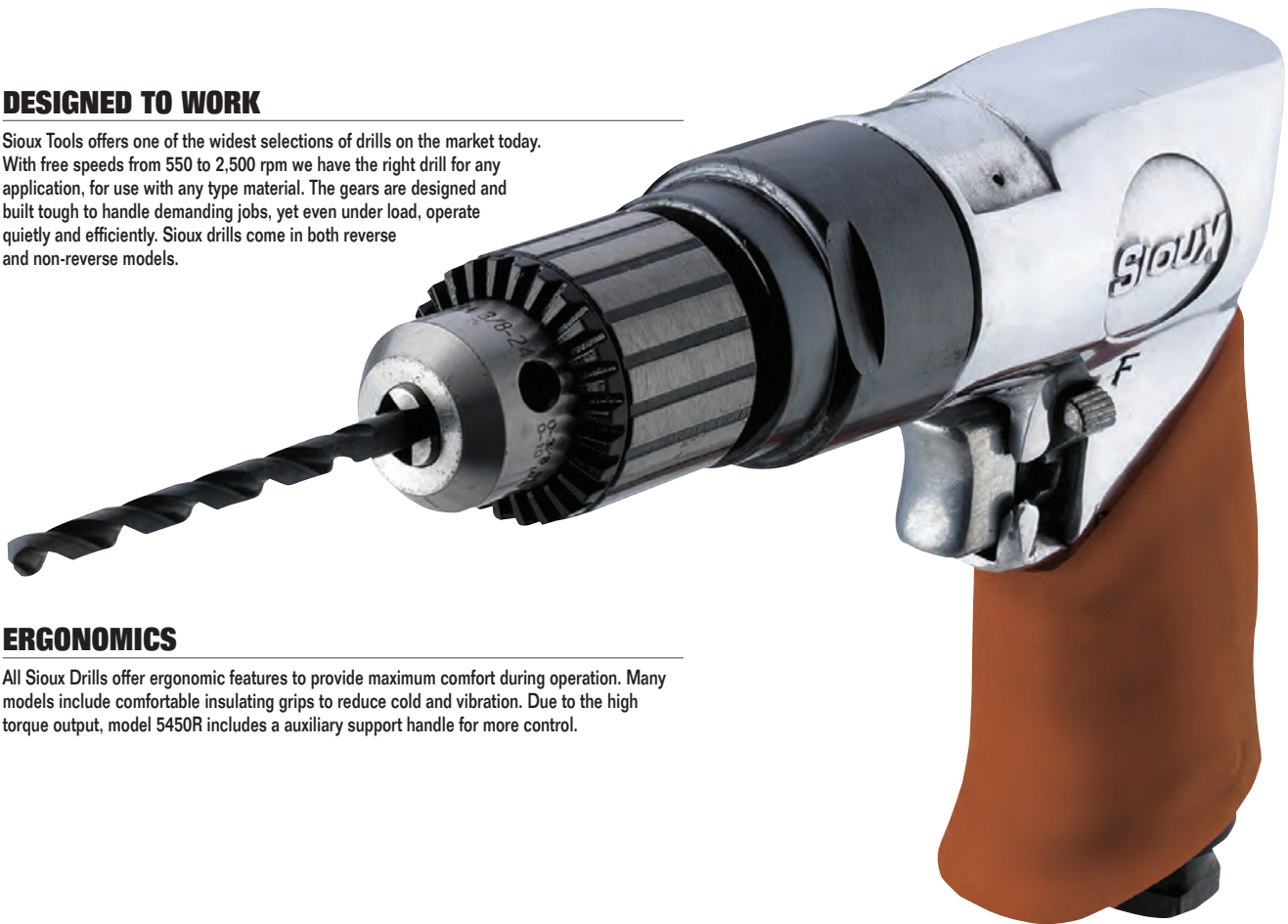



3/8" (10 MM) DRILL

Model No. FDR5440

- Keyed chuck
- Non-reversible
- Aluminum housing
- Chuck capacity: 3/8" (10 mm)
- Free speed: 2300 rpm
- Weight: 2.1 lb (1.0 kg)
- Length: 7.9" (190 mm)
- Air inlet size: 1/4" NPT
- Recommended hose size: 3/8" (10 mm)
- 3/8" - 24 Spindle thread

CE



3/8" (10 MM) DRILL

Model No. 5440KL

- Keyless chuck
- Non-reversible
- Aluminum housing
- Chuck capacity: 3/8" (10 mm)
- Free speed: 2300 rpm
- Weight: 2.1 lb (1.0 kg)
- Length: 7.5" (190 mm)
- Air inlet size: 1/4" NPT
- Recommended hose size: 3/8" (10 mm)
- 3/8" - 24 Spindle thread

CE

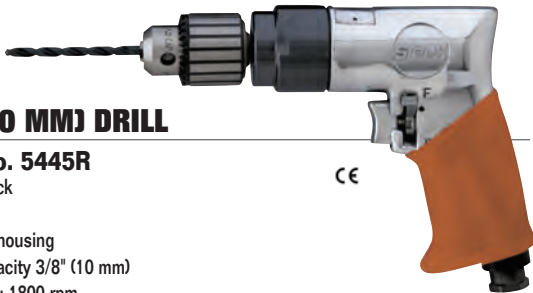

3/8" (10 MM) DRILL

Model No. 5445R

- Keyed chuck
- Reversible
- Aluminum housing
- Chuck capacity 3/8" (10 mm)
- Free speed: 1800 rpm
- Weight: 3 lb (1.4 kg)
- Length: 8" (200 mm)
- Air inlet size: 1/4" NPT
- Recommended hose size: 3/8" (10 mm)
- 3/8" - 24 Spindle thread

CE



3/8" (10 MM) DRILL

Model No. 5445RKL

- Keyless chuck
- Reversible
- Aluminum housing
- Chuck capacity 3/8" (10 mm)
- Free speed: 1800 rpm
- Weight: 3 lb (1.4 kg)
- Length: 8" (200 mm)
- Air inlet size: 1/4" NPT
- Recommended hose size: 3/8" (10 mm)
- 3/8" - 24 Spindle thread

CE



1/2" (13 MM) DRILL

Model No. 5450R

- Keyed chuck
- Reversible
- Aluminum housing
- Support handle
- Free speed: 550 rpm
- Chuck capacity: 1/2" (13 mm)
- Weight: 4.3 lb (1.95 kg)
- Length: 9.25" (235 mm)
- Air inlet size: 1/4" NPT
- Recommended hose size: 3/8" (10 mm)
- 1/2" - 20 Spindle thread

CE



1/2" (13 MM) DRILL

Model No. 5450RKL

- Keyless chuck
- Reversible
- Aluminum housing
- Support handle
- Free speed: 550 rpm
- Chuck capacity: 1/2" (13 mm)
- Weight: 4.3 lb (1.95 kg)
- Length: 9.25" (235 mm)
- Air inlet size: 1/4" NPT
- Recommended hose size: 3/8" (10 mm)
- 1/2" - 20 Spindle thread

CE



3/8" (10 MM) INLINE AIR DRILL

Model No. 5434KL

- Keyless Chuck
- Non-Reversible
- Aluminum housing
- Lockoff level throttle
- Rear exhaust
- Built-in speed regulator
- Chuck capacity: 3/8" (10 mm)
- Free speed: 2500 rpm
- Weight: 2 lb (0.9 kg)
- Length: 8" (200 mm)
- Air inlet size: 1/4" NPT
- Recommended hose size: 3/8" (10 mm)
- 3/8" - 24 Spindle thread

CE



3/8" (10 MM) INLINE AIR DRILL

Model No. 5434

- Keyed Chuck
- Non-Reversible
- Aluminum housing
- Lockoff level throttle
- Rear exhaust
- Built-in speed regulator
- Free speed: 2500 rpm
- Chuck capacity: 3/8" (10 mm)
- Weight: 2 lb (0.9 kg)
- Length: 8" (200 mm)
- Air inlet size: 1/4" NPT
- Recommended hose size: 3/8" (10 mm)
- 3/8" - 24 Spindle thread

CE



3/8" (10 MM) RIGHT ANGLE DRILL

Model No. FDR5430

- Keyed chuck
- Reversible
- Aluminum housing
- Rear exhaust
- Built-in speed regulator
- Free speed: 1200 rpm
- Chuck capacity: 3/8" (10 mm)
- Weight: 2.5 lb (1.1 kg)
- Length: 8" (200 mm)
- Air inlet size: 1/4" NPT
- Recommended hose size: 3/8" (10 mm)
- 3/8" - 24 Spindle thread

CE



3/8" (10 MM) RIGHT ANGLE DRILL

Model No. 5430KL

- Keyless chuck
- Reversible
- Aluminum housing
- Rear exhaust
- Built-in speed regulator
- Free speed: 1200 rpm
- Chuck capacity: 3/8" (10 mm)
- Weight: 2.5 lb (1.1 kg)
- Length: 8" (200 mm)
- Air inlet size: 1/4" NPT
- Recommended hose size: 3/8" (10 mm)
- 3/8" - 24 Spindle thread

CE



2352

QUICK CHANGE CHUCK: PART NO. 2352

Adapts 3/8"-24 threaded spindles to 1/4" hex quick change



21137



65562

DRILL CHUCKS & KEYS

Adapts arbor with 1/2"-20 thread to hole saw with 5/8"-18 thread

Chuck Capacity	Thread Size	Chuck Part No	Key Part No	Key Holder No
0 - 1/4"	3/8" - 24	21077	30000	
0 - 1/4"	3/8" - 24	21019A	30202	
0 - 3/8"	1/2" - 20	21002	30011	14273
0 - 3/8"	3/8" - 24	21085	30231	14273
1/16" - 3/8"	1/2" - 20	21131	30002	
1/16" - 3/8"	3/8" - 24	21133	30002	14273
1/16" - 3/8"	3/8" - 24	65562		
5/64" - 1/2"	3/8" - 24	21132	30429	
5/64" - 1/2"	1/2" - 20	21137	30011	14273
5/64" - 1/2"	1/2" - 20	506209		

¹Keyless Chuck • Keyed chucks include key



506156 / 506155

SIDE HANDLE

Part Number	Description	Used On
506155	Clamp Ring	5450R
506156	Handle	5450R





POWER TOOLS

ASSEMBLY

We're Making A Big Impact

Impact wrenches are the true workhorses of industrial power tools. These incredibly powerful tools make easy work of any job in a variety of applications. Before the creation of impact tools, workers had to manually strike a hammer against a hand wrench in order to loosen or tighten nuts or bolts. They could only manage a few blows per minute. But today's impact wrenches can exert more powerful blows, and some can produce up to 1,200 blows per minute. This is accomplished by using the energy of compressed air and converting the motor's torque into a rapid series of powerful rotary impacts.

CHOICE OF CONFIGURATION

Sioux Tools offers Force Impact Wrenches and Impact Drivers in a wide variety of configurations to meet your specific needs. Choosing the right mix of features such as handle configuration, type of retainer, torque output, anvil length, and drive size will make operators more productive, with less risk of discomfort and/or injury.



BUILT TOUGH

Built to a higher level of quality, Force Impact Wrenches and Impact Drivers are built a step above the standard. Manufactured from high quality materials, and utilizing the most advanced motor and clutch designs, these tools are constructed to hold in the toughest working environments.

HIGH QUALITY

Force Impact Wrenches and Impact Drivers provide a high quality, cost-effective choice for your impact requirements. Featuring one of the widest selections of impact tools for general industry, Sioux Force impacts reach all aspects of the maintenance and repair market and beyond to manufacturing applications. With drive sizes ranging from, 1/4" (6 mm) to 1" (25 mm), including hex quick change drives, and torque outputs up to 2700 ft lb (3661 Nm), finding the tool to meet your performance requirements will be simple.

Our extensive lineup of impact tools includes a wide selection of important features including:

- Twin Hammer, Pin or Roller Cam impact mechanisms
- Inline, pistol grip, or D handle configurations
- Pin, friction ring, quick change, or thru hole socket retainers
- Standard or extended anvils



CE

3/8" (10 MM) RATCHET WRENCH

Model No. 5007

- Steel angle head
- Aluminum housing
- Ergonomic Composite Grip
- Grade 5 bolt capacity: 5/16" (8 mm)
- Drive size: 3/8" (10 mm)
- Maximum torque: 20 ft lb (27 Nm)
- Free speed: 265 rpm
- Weight: 1.3 lb (0.55 kg)
- Length: 6.6" (168 mm)
- Air inlet size: 1/4" NPT
- Recommended hose size: 3/8" (10 mm)
- Air Consumption: 1.4 cfm (37 l/s) avg. – 5.2 cfm (147 l/s) max.



CE

1/4" (6 MM) RATCHET WRENCH

Model No. 5009

- Steel angle head
- Aluminum housing
- Ergonomic Composite Grip
- Grade 5 bolt capacity: 5/16" (8 mm)
- Drive size: 1/4" (6 mm)
- Maximum torque: 20 ft lb (27 Nm)
- Free speed: 265 rpm
- Weight: 1.5 lb (0.5 kg)
- Length: 6.6" (168 mm)
- Air inlet size: 1/4" NPT
- Recommended hose size: 3/8" (10 mm)
- Air Consumption: 1.2 cfm (37 l/s) avg. – 5.2 cfm (147 l/s) max.



CE

3/8" (10 MM) RATCHET WRENCH

Model No. 5011

- Steel angle head
- Aluminum housing
- Ergonomic Composite Grip
- Grade 5 bolt capacity: 7/16" (11 mm)
- Drive size: 3/8" (10 mm)
- Maximum torque: 50 ft lb (68 Nm)
- Free speed: 185 rpm
- Weight: 2.6 lb (1.2 kg)
- Length: 10.8" (274 mm)
- Air inlet size: 1/4" NPT
- Recommended hose size: 3/8" (10 mm)
- Air Consumption: 3 cfm (85 l/s) avg. – 12 cfm (340 l/s) max.



CE

1/2" (13 MM) RATCHET WRENCH

Model No. 5013

- Steel angle head
- Aluminum housing
- Ergonomic Composite Grip
- Grade 5 bolt capacity: 7/16" (11 mm)
- Drive size: 1/2" (13 mm)
- Maximum torque: 50 ft lb (68 Nm)
- Free speed: 185 rpm
- Weight: 2.6 lb (1.2 kg)
- Length: 10.8" (274 mm)
- Air inlet size: 1/4" NPT
- Recommended hose size: 3/8" (10 mm)
- Air Consumption: 3 cfm (85 l/s) avg. – 12 cfm (340 l/s) max.





3/8" (10 MM) INLINE IMPACT WRENCH

Model No. 5035

- Lever start
- Suspension Bail
- Steel anvil housing
- Twin Hammer Impact mechanism
- Built-in power regulator
- Friction Ring Socket Retainer
- Grade 5 bolt capacity: 3/8" (10 mm)
- Drive size: 3/8" (10 mm)
- Working torque range: 5-60 ft lb (7-81 Nm)
- Max. torque: 80 ft lb (108 Nm)
- Free speed: 7000 rpm
- Blows per minute: 1200
- Weight: 2.7 lb (1.2 kg)
- Length: 8.6" (218 mm)
- Air inlet size: 1/4" NPT
- Recommended hose size: 3/8" (10 mm)
- Air Consumption: 3.6 cfm (102 l/s) avg. – 14.5 cfm (410 l/s) max



3/8" (10 MM) BUTTERFLY IMPACT WRENCH

Model No. 5045

- Built-in power regulator
- Swivel air inlet bushing
- Friction ring socket retainer
- Grade 5 bolt capacity: 3/8" (10 mm)
- Drive size: 3/8" (10 mm)
- Working torque range: 15-160 ft lb (20-217 Nm)
- Max. torque: 175 ft lb (237 Nm)
- Free speed: 9500 rpm
- Blows per minute: 1850
- Weight: 2.5 lb (1.1 kg)
- Length: 7.6" (193 mm)
- Air inlet size: 1/4" NPT
- Recommended hose size: 3/8" (10 mm)
- Air Consumption: 2.5 cfm (1.2 l/s) avg.

3/8" (10 MM) IMPACT WRENCH

Model No. 5038B

- Reverse bias power
- Pin style impact mechanism
- Oil bath lubrication
- Built-in power regulator
- Molded comfort grip
- Friction ring socket retainer
- Grade 5 bolt capacity: 3/8" (10 mm)
- Drive size: 3/8" (10 mm)
- Working torque range: 50-160 ft lb (68-217 Nm)
- Max. torque: 185 ft lb (251 Nm)
- Free speed: 8500 rpm
- Blows per minute: 1160
- Weight: 3.7 lb (1.7 kg)
- Length: 6.3" (160 mm)
- Air inlet size: 1/4" NPT
- Recommended hose size: 3/8" (10 mm)
- Air Consumption: 3.5 cfm (100 l/s) avg. – 14.0 cfm (395 l/s) max



3/8" (10 MM) INLINE IMPACT WRENCH

Model No. 5035P

- Lever start
- Suspension Bail
- Steel anvil housing
- Twin Hammer Impact mechanism
- Built-in power regulator
- Pin Socket Retainer
- Grade 5 bolt capacity: 3/8" (10 mm)
- Drive size: 3/8" (10 mm)
- Working torque range: 5-60 ft lb (7-81 Nm)
- Max. torque: 80 ft lb (108 Nm)
- Free speed: 7000 rpm
- Blows per minute: 1200
- Weight: 2.7 lb (1.2 kg)
- Length: 8.6" (218 mm)
- Air inlet size: 1/4" NPT
- Recommended hose size: 3/8" (10 mm)
- Air Consumption: 3.6 cfm (102 l/s) avg. – 14.5 cfm (410 l/s) max



3/8" (10 MM) BUTTERFLY IMPACT WRENCH

Model No. 5045P

- Built-in power regulator
- Swivel air inlet bushing
- Pin socket retainer
- Grade 5 bolt capacity: 3/8" (10 mm)
- Drive size: 3/8" (10 mm)
- Working torque range: 15-160 ft lb (20-217 Nm)
- Max. torque: 175 ft lb (237 Nm)
- Free speed: 9500 rpm
- Blows per minute: 1850
- Weight: 2.5 lb (1.1 kg)
- Length: 7.6" (193 mm)
- Air inlet size: 1/4" NPT
- Recommended hose size: 3/8" (10 mm)
- Air Consumption: 2.5 cfm (1.2 l/s) avg.

3/8" (10 MM) IMPACT WRENCH

Model No. 5039B

- Reverse bias power
- Pin style impact mechanism
- Oil bath lubrication
- Molded comfort grip
- Built-in power regulator
- Pin socket retainer
- Grade 5 bolt capacity: 3/8" (10 mm)
- Drive size: 3/8" (10 mm)
- Working torque range: 50-160 ft lb (68-217 Nm)
- Max. torque: 185 ft lb (251 Nm)
- Free speed: 8500 rpm
- Blows per minute: 1,160
- Weight: 3.7 lb (1.7 kg)
- Length: 6.3" (160 mm)
- Recommended hose size: 3/8" (10 mm)
- Air Consumption: 3.4 cfm (100 l/s) avg. – 14.0 cfm (395 l/s) max





3/8" (10 MM) QUIET COMPOSITE IMPACT

Model No. 5338A

- Friction Ring Socket Retainer
- Reverse bias motor
- Twin hammer impact mechanism
- Three Level power control
- Lightweight composite housing
- Contoured trigger for comfort and control
- Grade 5 bolt capacity: 3/8" (10 mm)
- Drive Size: 3/8"
- Working torque: 100 - 180 ft/lbs (135 - 245 Nm)
- Max. torque: 250 ft/lbs (339 Nm)
- Free speed: 9000 RPM
- Blows per minute: 900
- Weight: 2.7 lbs (1.21 kg)
- Length: 6.5" (165 mm)
- Air inlet size: 1/4" NPT
- Low sound level 85 dB (A)
- Recommended hose size: 3/8" (10 mm)
- Average Air consumption: 2.8 cfm (1.3 l/s)



CE

3/8" (10 MM) QUIET COMPOSITE IMPACT

Model No. 5338AP

- Pin Socket Retainer
- Reverse bias motor
- Twin hammer impact mechanism
- Three Level power control
- Lightweight composite housing
- Contoured trigger for comfort and control
- Grade 5 bolt capacity: 3/8" (10 mm)
- Drive Size: 3/8"
- Working torque: 100 - 180 ft/lbs (135 - 245 Nm)
- Max. torque: 250 ft/lbs (339 Nm)
- Free speed: 9000 RPM
- Blows per minute: 900
- Weight: 2.7 lbs (1.21 kg)
- Length: 6.5" (165 mm)
- Air inlet size : 1/4" NPT
- Low sound level 85 dB (A)
- Recommended hose size: 3/8" (10 mm)
- Average Air consumption: 2.8 cfm (1.3 l/s)



CE

1/2" (13 MM) IMPACT WRENCH

Model No. 5000A

- Twin hammer impact mechanism
- Front exhaust
- Built-in power regulator
- Friction ring socket retainer
- Grade 5 bolt capacity: 5/8" (16 mm)
- Drive size: 1/2" (13 mm)
- Working torque: 25-300 ft lb (34-407 Nm)
- Max. torque: 425 ft lb (576 Nm)
- Free speed: 8000 rpm
- Blows per minute: 1,200
- Weight: 5.6 lb (2.5 kg)
- Length: 7.4" (188 mm)
- Air inlet size: 1/4" NPT
- Recommended hose size: 3/8" (10 mm)
- Air Consumption: 4.2 cfm (120 l/s) avg. - 16.8 cfm (475 l/s) max.

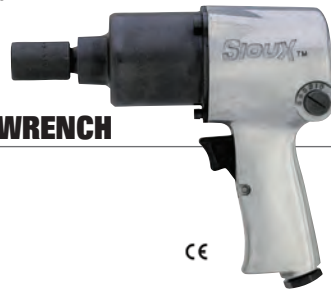

CE

1/2" (13 MM) IMPACT WRENCH

Model No. 5000AL

- Twin hammer impact mechanism
- 2" Extended Anvil
- Front exhaust
- Built-in power regulator
- Friction ring socket retainer
- Grade 5 bolt capacity: 5/8" (16 mm)
- Drive size: 1/2" (13 mm)
- Working torque: 25-300 ft lb (34-407 Nm)
- Max. torque: 425 ft lb (576 Nm)
- Free speed: 8000 rpm
- Blows per minute: 1,200
- Weight: 5.6 lb (2.5 kg)
- Length: 9.4" (240 mm)
- Air inlet size: 1/4" NPT
- Recommended hose size: 3/8" (10 mm)
- Air Consumption: 4.2 cfm (120 l/s) avg. - 16.8 cfm (475 l/s) max.

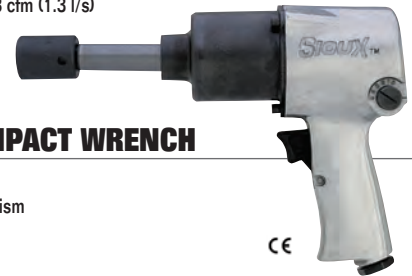

CE

1/2" (13 MM) IMPACT WRENCH

Model No. 5050A

- Reverse bias power
- Twin hammer impact mechanism
- Built-in power regulator
- Down handle exhaust
- Steel anvil housing
- Friction ring socket retainer
- Grade 5 bolt capacity: 5/8" (16 mm)
- Drive size: 1/2" (13 mm)
- Working torque: 50-350 ft lb (68-474 Nm)
- Max. torque: 475 ft lb (644 Nm)
- Free speed: 8,000 rpm
- Blows per minute: 1100
- Weight: 5.6 lb (2.5 kg)
- Length: 7.4" (188 mm)
- Air inlet size: 1/4" NPT
- Recommended hose size: 3/8" (10 mm)
- Air Consumption: 3.6 cfm (102 l/s) avg. - 14.5 cfm (410 l/s) max.



CE

1/2" (13 MM) IMPACT WRENCH

Model No. 5051A

- Reverse bias power
- Twin hammer impact mechanism
- Built-in power regulator
- Down handle exhaust
- Steel anvil housing
- Pin socket retainer
- Grade 5 bolt capacity: 1/2" (13 mm)
- Drive size: 1/2" (13 mm)
- Working torque: 50-350 ft lb (68-474 Nm)
- Max. torque: 475 ft lb (644 Nm)
- Free speed: 8000 rpm
- Blows per minute: 1,100
- Weight: 5.6 lb (2.5 kg)
- Length: 7.4" (188 mm)
- Recommended hose size: 3/8" (10 mm)
- Air Consumption: 3.5 cfm (100 l/s) avg. - 14 cfm (395 l/s) max.



CE



1/2" (13 MM) QUIET COMPOSITE IMPACT

Model No. 5350A

- Friction Ring Socket Retainer
- Reverse bias motor
- Twin hammer impact mechanism
- Three Level power control
- Lightweight composite housing
- Contoured trigger for comfort and control
- Grade 5 bolt capacity: 5/8" (16 mm)
- Drive Size: 1/2"
- Working torque: 100 - 450 ft./lbs. (135 - 610 Nm)
- Max. torque: 520 ft.lbs. (705 Nm)
- Free speed: 6300 RPM
- Blows per minute: 1200
- Weight: 4.6 lbs. (2.07 kg)
- Length: 6.7" (170 mm)
- Air inlet size: 1/4" NPT
- Low sound level 82 dB (A)
- Recommended hose size: 3/8" (10 mm)
- Average Air consumption: 3.9 cfm (1.8 l/s)

CE



1/2" (13 MM) QUIET COMPOSITE IMPACT

Model No. 5350AP

- Pin Socket Retainer
- Reverse bias motor
- Twin hammer impact mechanism
- Three Level power control
- Lightweight composite housing
- Contoured trigger for comfort and control
- Grade 5 bolt capacity: 5/8" (16 mm)
- Drive Size: 1/2"
- Working torque: 100 - 450 ft./lbs. (135 - 610 Nm)
- Max. torque: 520 ft.lbs. (705 Nm)
- Free speed: 6300 RPM
- Blows per minute: 1200
- Weight: 4.6 lbs. (2.07 kg)
- Length: 6.7" (170 mm)
- Air inlet size: 1/4" NPT
- Low sound level 82 dB (A)
- Recommended hose size: 3/8" (10 mm)
- Average Air consumption: 3.9 cfm (1.8 l/s)

CE



1/2" (13 MM) QUIET COMPOSITE IMPACT

Model No. 5350AL

- Pin Socket Retainer
- Reverse bias motor
- Twin hammer impact mechanism
- 2" extended anvil
- Three Level power control
- Lightweight composite housing
- Contoured trigger for comfort and control
- Grade 5 bolt capacity: 5/8" (16 mm)
- Drive Size: 1/2"
- Working torque: 100 - 450 ft./lbs. (135 - 610 Nm)
- Max. torque: 520 ft.lbs. (705 Nm)
- Free speed: 6300 RPM
- Blows per minute: 1200
- Weight: 4.8 lbs. (2.17 kg)
- Length: 8.7" (220 mm)
- Air inlet size: 1/4" NPT
- Low sound level 82 dB (A)
- Recommended hose size: 3/8" (10 mm)
- Average Air consumption: 3.9 cfm (1.8 l/s)

CE



1/2" (13 MM) IMPACT WRENCH

Model No. 5250A

- Reverse bias power
- Pin style impact mechanism
- Oil bath lubrication
- Built-in power regulator
- Molded comfort grip
- Friction ring socket retainer
- Grade 5 bolt capacity: 5/8" (16 mm)
- Drive size: 1/2" (13 mm)
- Working torque: 50-375 ft lb (68-508 Nm)
- Max. torque: 525 ft lb (712 Nm)
- Free speed: 7000 rpm
- Blows per minute: 985
- Weight: 6 lb (2.7 kg)
- Length: 7.7" (196 mm)
- Recommended hose size: 3/8" (10 mm)
- Air Consumption: 3.5 cfm (100 l/s) avg. - 14 cfm (395 l/s) max.

CE



3/4" (19 MM) QUIET COMPOSITE IMPACT

Model No. 5375A

- Friction Ring Socket Retainer
- Reverse bias motor
- Twin hammer impact mechanism
- Three Level power control
- Lightweight composite housing
- Contoured trigger for comfort and control
- Grade 5 bolt capacity: 3/4" (19 mm)
- Drive Size: 3/4"
- Working torque: 300 - 800 ft/lbs. (407 - 1085 Nm)
- Max. torque: 1000 ft/lbs. (1356 Nm)
- Free speed: 4000 RPM
- Blows per minute: 300
- Weight: 8.5 lbs. (3.8 kg)
- Length: 9.5" (240 mm)
- Air inlet size: 3/8" NPT
- Low sound level 82 dB (A)
- Recommended hose size: 1/2" (13 mm)
- Average Air consumption: 5.6 cfm (2.6 l/s)



CE

3/4" (19 MM) QUIET COMPOSITE IMPACT

Model No. 5375AP

- Thru Hole Socket Retainer
- Reverse bias motor
- Twin hammer impact mechanism
- Three Level power control
- Lightweight composite housing
- Contoured trigger for comfort and control
- Grade 5 bolt capacity: 3/4" (19 mm)
- Drive Size: 3/4"
- Working torque: 300 - 800 ft/lbs. (407 - 1085 Nm)
- Max. torque: 1000 ft/lbs. (1356 Nm)
- Free speed: 4000 RPM
- Blows per minute: 300
- Weight: 8.5 lbs. (3.8 kg)
- Length: 9.5" (240 mm)
- Air inlet size: 3/8" NPT
- Low sound level 82 dB (A)
- Recommended hose size: 1/2" (13 mm)
- Average Air consumption: 5.6 cfm (2.6 l/s)



CE

3/4" (19 MM) IMPACT WRENCH

Model No. 5075A

- Aluminum housing
- Steel anvil housing
- Roller cam impact mechanism
- Built-in power regulator
- Friction ring and thru hole socket retainer
- Grade 5 bolt capacity: 3/4" (19 mm)
- Drive size: 3/4" (19 mm)
- Working torque: 300-800 ft lb (34-1084 Nm)
- Max. torque: 1200 ft lb (1627 Nm)
- Free speed: 4500 rpm
- Blows per minute: 870
- Weight: 12.6 lb (5.7 kg)
- Length: 10.2" (259 mm)
- Recommended hose size: 1/2" (13 mm)
- Air Consumption: 5.8 cfm (164 l/s) avg. - 23.2 cfm (655 l/s) max.



CE

3/4" (19 MM) IMPACT WRENCH

Model No. 5075AL

- Roller cam impact mechanism
- 6" (152 mm) extended anvil
- Oil bath lubrication
- Molded comfort grip
- Built-in power regulator
- Friction ring and thru hole socket retainer
- Grade 5 bolt capacity: 3/4" (19 mm)
- Drive size: 3/4" (19 mm)
- Working torque: 300-800 ft lb (34-1084 Nm)
- Max. torque: 1200 ft lb (1627 Nm)
- Free speed: 4500 rpm
- Blows per minute: 870
- Weight: 15.7 lb (7.1 kg)
- Length: 16.2" (411 mm)
- Recommended hose size: 1/2" (13 mm)
- Air Consumption: 5.8 cfm (164 l/s) avg. - 23.2 cfm (655 l/s) max.

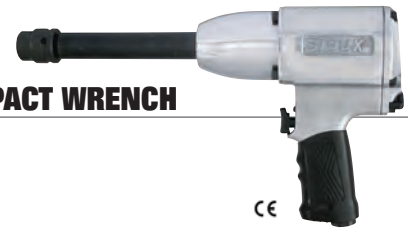

CE

1" (25 MM) HIGH TORQUE IMPACT WRENCH

Catalog No. 5092

- Pin impact mechanism
- Oil bath lubrication
- Support handle
- Friction Ring and Thru hole socket retainer
- Grade 5 bolt capacity: 1-1/2" (38 mm)
- Drive size: 1" (25 mm)
- Working torque: 600-1400 ft lb (813-1898 Nm)
- Max. torque: 2800 ft lb (3797 Nm)
- Free speed: 4000 rpm
- Blows per minute: 500
- Weight: 24.9 lb (11.3 kg)
- Length: 11.9" (302 mm)
- Recommended hose size: 1/2" (13 mm)
- Air Consumption: 8.3 cfm (235 l/s) avg. - 33.2 cfm (938 l/s) max.



CE

1" (25 MM) HIGH TORQUE EXTENDED ANVIL IMPACT WRENCH

Catalog No. 5092L

- Pin impact mechanism
- Oil bath lubrication
- 6" extended anvil
- Support handle
- Friction Ring and Thru hole socket retainer
- Grade 5 bolt capacity: 1-1/2" (38 mm)
- Drive size: 1" (25 mm)
- Working torque: 500-1300 ft lb (675-1762 Nm)
- Max. torque: 2500 ft lb (3390 Nm)
- Free speed: 4000 rpm
- Blows per minute: 500
- Weight: 27.3 lb (12.4 kg)
- Length: 16.9" (429 mm)
- Recommended hose size: 1/2" (13 mm)
- Air Consumption: 8.3 cfm (235 l/s) avg. - 33.2 cfm (938 l/s) max.

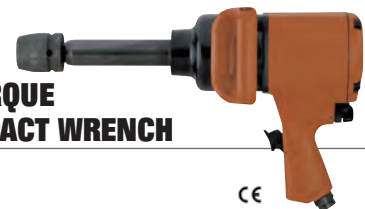

CE



1" (25 MM) HIGH TORQUE IMPACT WRENCH

Catalog No. 5093

- Pin impact mechanism
- Oil bath lubrication
- Support handle
- Friction Ring and Thru hole socket retainer
- Grade 5 bolt capacity: 1-1/2" (38 mm)
- Drive size: 1" (25 mm)
- Working torque: 600-1400 ft lb (813-1898 Nm)
- Max. torque: 3000 ft lb (4068 Nm)
- Free speed: 4000 rpm
- Blows per minute: 500
- Weight: 25.6 lb (11.6 kg)
- Length: 15.1" (384 mm)
- Recommended hose size: 1/2" (13 mm)
- Air Consumption: 8.3 cfm (235 l/s) avg. - 33.2cfm (938 l/s) max.

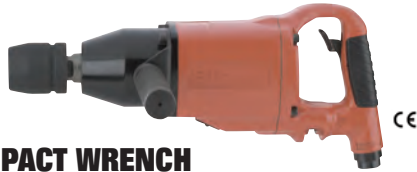

1" (25 MM) IMPACT WRENCH

Model No. 5095

- Friction ring and thru hole socket retainer
- Reverse bias motor
- Twin hammer impact mechanism
- Steel hammer case
- Three piece housing
- Support handle included
- Grade 5 bolt capacity: 1-1/4" (32 mm)
- Drive Size: 1"
- Working torque: 500 - 1200 ft/lbs. (675 - 1625 Nm)
- Max. torque: 1400 ft/lbs. (1900 Nm)
- Free speed: 5000 RPM
- Blows per minute: 900
- Weight: 16.8 lbs. (7.6 kg)
- Length: 14.5" (370 mm)
- Air inlet size: 1/2" NPT
- Recommended hose size: 1/2" (13 mm)
- Average Air consumption: 15 cfm (7 l/s)



SOCKET RETAINING PINS WITH "O" RINGS

Retaining Pin	"O" Ring	For Use On
34911	14318	3/4" Dr. Sockets 6620-6638
34664	14317	3/4" Dr. Sockets 6640-6654
34665	14319	Adaptor 2568, All 1" Dr. Sockets



1" (25 MM) HIGH TORQUE IMPACT WRENCH

Catalog No. 5093L

- Pin impact mechanism
- 6" extended anvil
- Oil bath lubrication
- Support handle
- Friction Ring and Thru hole socket retainer
- Grade 5 bolt capacity: 1-1/2" (38 mm)
- Drive size: 1" (25 mm)
- Working torque: 500-1300 ft lb (675-1762 Nm)
- Max. torque: 2700 ft lb (3661 Nm)
- Free speed: 4000 rpm
- Blows per minute: 500
- Weight: 28 lb (12.7 kg)
- Length: 21.1" (536 mm)
- Recommended hose size: 1/2" (13 mm)
- Air Consumption: 8.3 cfm (235 l/s) avg. - 33.2cfm (938 l/s) max.



1" (25 MM) IMPACT WRENCH

Model No. 5095L

- Friction ring and thru hole socket retainer
- Reverse bias motor
- Twin hammer impact mechanism
- Steel hammer case
- Three piece housing
- Support handle included
- Grade 5 bolt capacity: 1-1/4" (32 mm)
- Drive Size: 1"
- Working torque: 500 - 1200 ft/lbs. (675 - 1625 Nm)
- Max. torque: 1400 ft/lbs. (1900 Nm)
- Free speed: 5000 RPM
- Blows per minute: 900
- Weight: 18.2 lbs. (8.2 kg)
- Length: 18.25" (465 mm)
- Air inlet size: 1/2" NPT
- Recommended hose size: 1/2" (13 mm)
- Average Air consumption: 15 cfm (7 l/s)



QUICK CHANGE CHUCK

Adapts male square drive to female hex quick change

Part Number	Drive Size		Color
	Input (Square Drive)	Output (Hex)	
2530	3/8"	1/4"	1 13/16"
2520	1/2"	7/16"	

ERGONOMIC HANDLE GRIP

Part No. 5002

Fits most Sioux Pistol Grip Air Tools and Impacts, etc.





Make Easy Work Out Of A Daily Grind

Force grinders are ready to take on any application with the power to make the job fast and easy. This means new speeds and attachments to handle increased precision with ergonomic comfort.

FORCE GRINDERS

Our line-up of Force Grinders continues to be among the most popular in the industry. The choice of light, medium and heavy-duty performance allow you to own the right tool for the right job that remains cost-effective. We have both straight and right angle models to fit any application

Our Pencil Die Grinders are lightweight powerhouses with a choice of either 50,000 rpm or an incredible 70,000 rpm for exceptional performance.

SAFETY

When operating any grinding tool be sure to follow all safety requirements and always wear eye and face protection. Doing so will protect both the operator and the tool.





PENCIL DIE GRINDER

Model No. 5978A

- Twist throttle
- Remote exhaust
- Built-in speed regulator
- Power: 0.1 hp (0.07 kw)
- Free speed: 54,000 rpm
- Collet size: 1/8"
- Weight: 0.25 lb (0.11 kg)
- Length: 5.3" (135 mm)
- 60" (1,524 mm) hose with hose protector included
- Air Consumption: 4.2 cfm (118 l/s) avg. – 16.8 cfm (474 l/s) max



PENCIL DIE GRINDER

Model No. 5979A

- Twist throttle
- Remote exhaust
- Built-in speed regulator
- Power: 0.1 hp (0.07 kw)
- Free speed: 70,000 rpm
- Collet size: 1/8"
- Weight: 0.25 lb (0.11 kg)
- Length: 5.3" (135 mm)
- 60" (1,524 mm) hose with hose protector included
- Air Consumption: 5.3 cfm (150 l/s) avg. – 21.2 cfm (598 l/s) max



PENCIL DIE GRINDER

Model No. 5977

- Twist throttle
- Remote exhaust
- Built in speed control
- Textured grip
- Free speed: 70,000 RPM
- Collet size: 1/8"
- Weight: 0.45 lb (0.20 kg)
- Length: 6" (152 mm)
- 60" (1,524 mm) leader hose with protector included
- Air Consumption: 0.42 cfm (0.20 l/s)



LIGHT DUTY DIE GRINDER

Model No. 5053A

- Lockoff lever throttle
- Comfort Grip
- Front exhaust
- Built-in speed regulator
- Aluminum housing
- Power: 0.3 hp (0.2 kw)
- Free speed: 26,000 rpm
- Collet size: 1/4"
- Weight: 0.8 lb (0.4 kg)
- Length: 5.3" (135 mm)
- Air inlet size: 1/4" NPT
- Recommended hose size: 3/8" (10 mm)
- Air Consumption: 4 cfm (113 l/s) avg. – 16 cfm (452 l/s) max.



MEDIUM DUTY DIE GRINDER

Model No. 5054A

- Lockoff lever throttle
- Comfort Grip
- Rear exhaust
- Built-in speed regulator
- Aluminum housing
- Power: 0.5 hp (0.4 kw)
- Free speed: 22,000 rpm
- Collet size: 1/4"
- Weight: 1.3 lb (0.6 kg)
- Length: 6.5" (165 mm)
- Air inlet size: 1/4" NPT
- Recommended hose size: 3/8" (10 mm)
- Air Consumption: 4 cfm (113 l/s) avg. – 16 cfm (452 l/s) max.



HEAVY DUTY RIGHT ANGLE DIE GRINDER

Model No. 5055A

- Lockoff lever throttle
- Comfort Grip
- Aluminum housing
- Built-in speed regulator
- Power: 0.3 hp (0.2 kw)
- Free speed: 20,000 rpm
- Collet size: 1/4"
- Weight: 1.1 lb (0.5 kg)
- Length: 5.5" (140 mm)
- Head Height: 2.9" (74 mm)
- Air inlet size: 1/4" NPT
- Recommended hose size: 3/8" (10 mm)
- Air Consumption: 4 cfm (113 l/s) avg. – 16 cfm (452 l/s) max.



RIGHT ANGLE LIGHT DUTY DIE GRINDER

Model No. 5056

- Lockoff lever throttle
- Comfort Grip
- Rear Exhaust
- Built-in speed regulator
- Power: 0.5 hp (0.4 kw)
- Free speed: 16,000 rpm
- Collet size: 1/4"
- Weight: 2 lb (0.9 kg)
- Length: 7.5" (190 mm)
- Head Height: 3" (76 mm)
- Air inlet size: 1/4" NPT
- Recommended hose size: 3/8" (10 mm)
- Air Consumption: 4.5 cfm (127 l/s) avg. – 18 cfm (508 l/s) max.



4 1/2" (115 MM) RIGHT ANGLE HEAVY DUTY GRINDER

Model No. 5268

- Aluminum housing
- Lockoff lever throttle
- Built-in speed regulator
- Free speed: 12,000 rpm
- Spindle size: 5/8" - 11
- Weight: 3.9 lb (1.7 kg)
- Length: 10" (254 mm)
- Head Height: 3.5" (90 mm)
- Air inlet size: 1/4" NPT
- Recommended hose size: 3/8" (10 mm)
- Air Consumption: 3.3 cfm (94 l/s) avg. – 13.2 cfm (373 l/s) max.



5" (127 MM) RIGHT ANGLE HEAVY DUTY GRINDER

Model No. 5285

- Aluminum housing
- Lockoff lever throttle
- Built-in speed regulator
- Free speed: 12,000 rpm
- Spindle size: 5/8" - 11
- Weight: 3.9 lb (1.7 kg)
- Length: 10" (254 mm)
- Head Height: 3.5" (90 mm)
- Air inlet size: 1/4" NPT
- Recommended hose size: 3/8" (10 mm)
- Air Consumption: 3.3 cfm (94 l/s) avg. – 13.2 cfm (373 l/s) max.



POWER TOOLS

FINISHING

The Best Way To A Great Finish

If you're in the market for tough tools that will deliver the performance you demand, then you've found what you need with Force sanders, polishers and buffers. These exceptional tools take on any application from repair and maintenance to manufacturing. With state-of-the-art orbital sanders, polishers and buffers you will get your work done faster and more efficiently than ever.

Sioux sanders are engineered to cover the full range of applications in metal, composite, and wood finishing. Our innovative, lightweight designs ensure they perform to the highest standards while still being comfortable to operate. Each delivers unsurpassed power and performance, resulting in the perfect finish.

FIT TO YOUR APPLICATION

Different applications require different finishing tools. That's why Sioux Tools offers a variety of sanders and polishers with a wide range of configurations.

VARIETY TO CHOOSE FROM

We also offer pistol grip, right angle, vertical, and inline sanders and polishers. Many of these come with your choice of throttle controls that allow the operator to work the way that's most comfortable.





PISTOL GRIP SANDER

Model No. 5540

- Aluminum housing
- Built-in speed regulator
- Free Speed: 14,000 rpm
- Weight: 2.2 lb. (1 kg)
- Length: 4.3" (109 mm)
- Air inlet size: 1/4" NPT
- Spindle thread: 7/16"-20
- Recommended hose size: 3/8" (10 mm)
- 3" (75 mm) and 4-1/2" (115 mm) backing pads included
- Air Consumption: 12 cfm (340 l/s) avg. – 30 cfm (847 l/s) max.



CE



CE

5" (125 MM) RIGHT ANGLE AIR SANDER

Model No. 5265

- Lockoff lever throttle
- Safety lever throttle
- Removable auxiliary handle and wrenches
- Built-in speed regulator
- Rear exhaust
- Backing pad for 5" (125 mm) abrasives included
- Free Speed: 7000 rpm
- Weight: 2.9 lb. (1.32 kg)
- Length: 9.4" (240 mm)
- Spindle thread: 5/8" - 11
- Air inlet size: 1/4" NPT
- Recommended hose size: 3/8" (10 mm)
- Air Consumption: 4.5 cfm (127 l/s) avg. – 18 cfm (508 l/s) max.



CE

RIGHT ANGLE SANDER

Model No. 5287A

- Lockoff lever throttle
- Support handle can be mounted on either side
- Rear exhaust
- Backing pad for 7" (180 mm) abrasives included
- Free Speed: 6000 rpm
- Pad diameter: 7" (180 mm)
- Weight: 4.4 lb. (2 kg)
- Length: 12.6" (320 mm)
- Air inlet size: 1/4" NPT
- Recommended hose size: 3/8" (10 mm)
- Spindle thread: 5/8"-11
- Air Consumption: 4.8 cfm (135 l/s) avg. – 19.2 cfm (542 l/s) max.

DUAL ACTION SANDER

Model No. 5558A

- Built-in speed regulator
- Dual action sanding
- Vinyl grip and head cover
- Free speed: 10,000 rpm
- Weight: 4.3 lb. (2 kg)
- Height: 5.4" (137 mm)
- Air inlet size: 1/4" NPT
- Recommended hose size: 3/8" (10 mm)
- Sound level: 79 dB(A)
- 6" (150 mm) backing pad included
- Air Consumption: 5 cfm (142 l/s) avg. – 10 cfm (282 l/s) max.
- 3/8" (10 mm) Orbit Diameter



DUAL PISTON INLINE SANDER

Model No. 5560

- Dual handles
- Positive lock paper clamps
- 2500 spm (strokes per minute)
- Paper size: 2-3/4" x 17-1/2" (70 x 445 mm)
- Weight: 6.8 lb. (3.1 kg)
- Length: 16" (406 mm)
- Air inlet size: 1/4" NPT
- Recommended hose size: 3/8" (10 mm)
- Air Consumption: 3 cfm (85 l/s) avg. – 12 cfm (340 l/s) max.

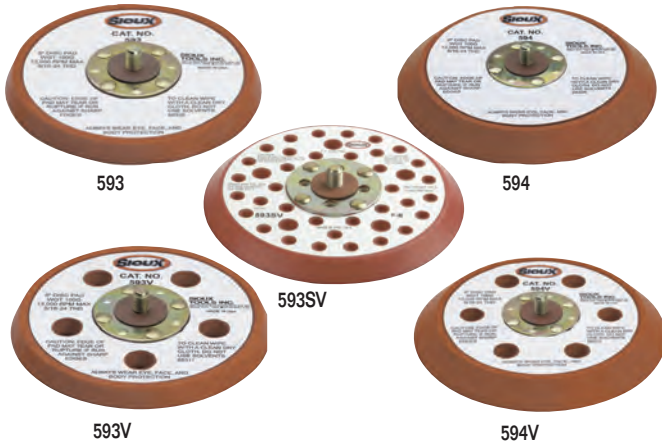

ORBITAL SANDER BACKING PADS

Sioux random orbital backing pads are medium density, urethane pads rated for speeds up to 13,000 rpm. The 5" pads are a 3/8" thick with low profile design, while the 6" pads are 5/8" thick with tapered profile for fine feathering in corners or around edges.

Part Number	Diameter		Backing	Profile	Style
	in	mm			
593	5	125	PSA ¹	Low	Non-Vac
593V	5	125	PSA ¹	Low	Vacuum
593J	5	125	H&L ²	Low	Non-Vac
593JV	5	125	H&L ²	Low	Vacuum
593SV	5	125	PSA ¹	Low	Screen Vac
594	6	150	PSA ¹	Tapered	Non-Vac
594V	6	150	PSA ¹	Tapered	Vacuum
594J	6	150	H&L ²	Tapered	Non-Vac
594JV	6	150	H&L ²	Tapered	Vacuum
594SV	5	125	PSA ¹	Low	Screen Vac

¹ PSA - Vinyl face for pressure sensitive adhesive sanding discs

² H&L - Hook and loop face



SPEED-LOK BACKING PADS

For use on tools with 1/4" collets

Part Number	Diameter		Hex Size
	in	mm	
587M	2	50	1/4"
588M	3	75	1/4"

FIBRE BACKING DISCS

Part No. 586

For use on 5540 series sander

Packaged in cartons of 6

Qty 3 - 3" (75 mm)

Qty 3 - 4-1/2" (110 mm)

Both have 7/8" (22 mm) arbor hole



587-120

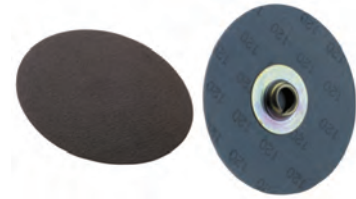

SPEED-LOK ABRASIVE DISCS

For use on Speed-Lok Backing Pads (Above)

Part Number	Diameter		Grit
	in	mm	
587-60	2	50	60
587-120	2	50	120
587-240	2	50	240
588-60	3	75	60
588-120	3	75	120
588-240	3	75	240



581, 2344, 2364

BACKING PADS

For use on tools with 1/4" collets

Part Number	Diameter		For Use On
	in	mm	
581*	5	125	7/16"-20 spindle thread
2344*	5	125	3/8"-24 spindle thread
2364*	5	125	5/8"-11 spindle thread

*includes disc nut 563



5205



5207

Part Number	Diameter		For Use On
	in	mm	
5205+	5	125	5265
5207*	7	180	5287A

*includes disc nut No. 67630

+does not include disc nut No. 67630 (order separately)



505079

Part Number	Diameter		For Use On
	in	mm	
505079	2.75 x 17.5	70 x 445	5560



Hammering Home A Point

Percussive tools, such as hammers, chippers and scalers, are commonly used in very abusive environments found in industries such as Foundry and Construction. Sioux Tools offers a variety of sizes, capacities and accessories built durable to ensure long life under tough operating conditions. We build them to work hard on the job, but not on you!

FORCE TOOLS

Our Force line-up of hammers deliver up to 4,800 blows per minute with stroke lengths from 1.8" (46 mm) to 3.8" (97 mm) and accept a .401 Parker Taper shank. Our lineup of Force scalers includes a weld flux scaler and mini-needle scaler that delivers 4,000 blows per minute with a 2" (50 mm) stroke.

We also feature a pistol grip needle scaler with a 3" (75 mm) stroke that delivers 3,000 blows per minute. You'll find a complete list of accessories for all Sioux percussive tools in the accessory section of this catalog.



POWER TOOLS

PERCUSSIVE



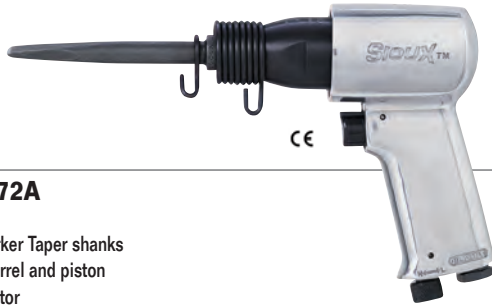

HAMMER

Model No. 5272A

- Spring retainer
- Accepts 0.401 Parker Taper shanks
- Hardened steel barrel and piston
- Built-in Air Regulator
- Aluminum housing
- Stroke length: 1.6" (41 mm)
- Bore diameter: 0.8" (20 mm)
- Blows per minute: 4800
- Weight 3 lb (1.4 kg)
- Length: 5.8" (147 mm)
- Air inlet size: 1/4" NPT
- Recommended hose size: 3/8" (10 mm)

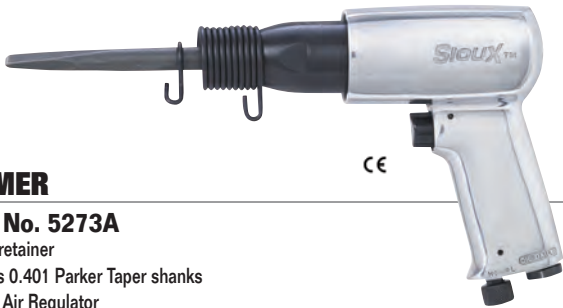

HAMMER

Model No. 5273A

- Spring retainer
- Accepts 0.401 Parker Taper shanks
- Built-in Air Regulator
- Hardened steel barrel and piston
- Aluminum housing
- Stroke length: 2.6" (66 mm)
- Bore diameter: 0.8" (20 mm)
- Blows per minute: 3200
- Weight 3.8 lb (1.7 kg)
- Length: 7.1" (180 mm)
- Air inlet size: 1/4" NPT
- Recommended hose size: 3/8" (10 mm)

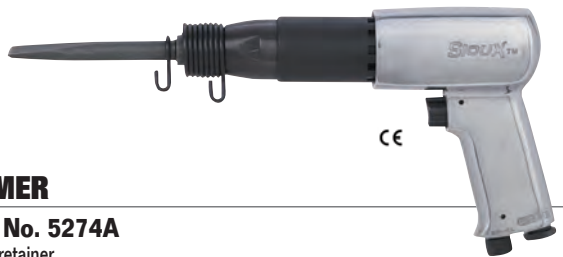

HAMMER

Model No. 5274A

- Spring retainer
- Accepts 0.401 Parker Taper shanks
- Built-in Air Regulator
- Hardened steel barrel and piston
- Aluminum pistol-grip housing
- Stroke length: 3.8" (97 mm)
- Bore diameter: 0.8" (20 mm)
- Blows per minute: 2200
- Weight 4.7 lb (2.1 kg)
- Length: 9.3" (236 mm)
- Air inlet size: 1/4" NPT
- Recommended hose size: 3/8" (10 mm)



PISTOL GRIP NEEDLE SCALER

Model No. 5262

- Comfort Grip
- Hardened steel barrel and piston
- Stroke length: 3" (75 mm)
- Bore diameter: 0.9" (23 mm)
- Blows per minute: 3000
- Weight 5.7 lb (2.6 kg)
- Length: 13.5" (340 mm)
- Air inlet size: 1/4" NPT
- Recommended hose size: 3/8" (10 mm)
- 19 — 0.12" (3 mm) Dia. x 7" (180 mm) long needles included



MINI NEEDLE SCALER

Model No. 5263

- Steel housing
- Hardened steel barrel and piston
- Stroke length: 2" (51 mm)
- Bore diameter: 0.7" (18 mm)
- Blows per minute: 4000
- Weight 2.6 lb (1.2 kg)
- Length: 11.4" (290 mm)
- Air inlet size: 1/4" NPT
- Recommended hose size: 3/8" (10 mm)
- 19 — 0.12" (3 mm) Dia. x 5" (125 mm) long needles included



NEEDLE SCALER

Model No. 5266

- Steel housing
- Hardened steel barrel and piston
- Stroke length: 2" (51 mm)
- Bore diameter: 1" (25 mm)
- Blows per minute: 4000
- Weight 5.7 lb (2.6 kg)
- Length: 16.1" (409 mm)
- Air inlet size: 1/4" NPT
- Recommended hose size: 3/8" (10 mm)
- 19 — 0.12" (3 mm) Dia. x 7" (180 mm) long needles included



BEEHIVE SPRING RETAINERS

Part Number	Description
2207	Chisel Retainer Spring
2208	Special Spring, use in place of 2207 with 2201, 2205, 2716, 2217, 2219 and 2220



270 RIVET SETS

3-1/2" Overall Length

Rivet Head Cupping	Rivet Diameter Size				
	3/32"	1/8"	5/32"	3/16"	1/4"
	Part No	Part No	Part No	Part No	Part No
Button Head	2228B	2229	2230B	2231	2244
Round Head	2232	2233	2234B	2235	2245
Brazier Head	2236	2237B	2238	2239	2246
Universal Head	2240	2241B	2242B	2243	2247



HAMMER CHUCK

Part Number	Description	For Use ON
2270	Quick change air hammer chuck	5272A, 5273A, 5274A



SCALING NEEDLES

Part Number	Diameter	Length	Quantity	Used On
2260B	0.12"	5"	19	Scalers
2262	0.12"	7"	19	Scalers

HAMMER ACCESSORIES

.401 Parker Taper Shank

Part Number	Description	Width		Length	
		in	mm	in	mm
2201	Cutter	5/8	16	6	150
2202	Chisel	5/8	16	6	150
2203	Rivet Buster	5/8	16	5 1/2	140
2204	Expansion Chisel	5/8	16	11	280
2205	Scraper	1 1/4	30	6	150
2206	Punch			7	175
2210B	Punch			5	127
2217B	Rust Breaker			5 1/4	135
2212	Spot Weld Breaker			6	150
2213	Splitter			8	200
2214B	Edging Chisel			5	140
2215	Blank Chisel			6	150
2216	Fork Chisel			6 7/8	175
2218	Bushing Cutter			7	175
2219	Bushing Driver			4 1/2	115
2220	Bushing Chisel	1 5/8	40	7	175

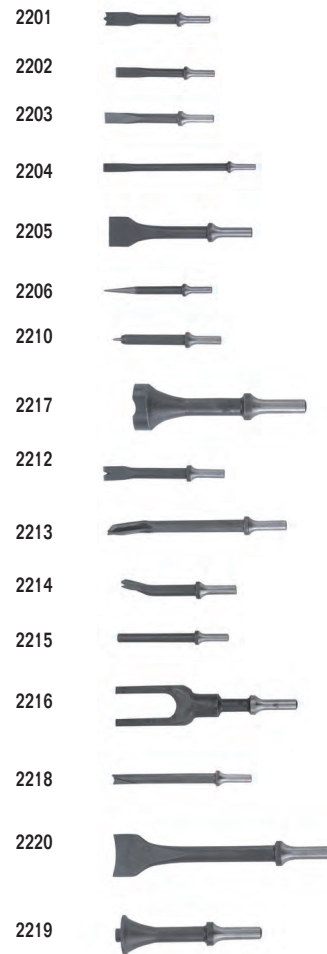



Special Applications Require Special Tools

Sioux Tools has a history of designing specialty tools for very specific applications, and as always, we manufacture the finest tools in the industry. These tools will live up to your expectations in both power and ergonomics.

RECIPROCATING SAW

Operating at 10,000 strokes per minute, this powerful saw features an adjustable blade guard, lock-off lever throttle and a built-in speed regulator.

CUT-OFF TOOL

We designed our cut-off tool to operate with a free speed of 21,000 and a lock-off lever throttle. The lightweight aluminum housing and rear exhaust make it very comfortable to operate.



SELECTION

If your application requires routers, tappers or metalworking tools like nibblers, check out the extensive line of Sioux Industrial Tools for a complete listing.

POWER TOOLS

SPECIALTY



RECIPROCATING AIR SAW

Model No. 5300A

- Comfort Grip Handle
- 10,000 strokes per minute
- Adjustable Blade Guard
- Lockoff lever throttle
- Built-in speed regulator
- Weight 1.8 lbs. (0.8 kg)
- Length: 9.2" (235 mm)
- Air inlet size: 1/4" NPT
- Recommended hose size: 5/16" (8 mm)

1823



1824B



1825



BI-METAL SAW BLADE (5 PACK)

Part Number	Description	Length
1823	Bi-Metal Blade - 18 TPI	4" (100mm)
1824B	Bi-Metal Blade - 24 TPI	4" (100mm)
1825	Bi-Metal Blade - 32 TPI	4" (100mm)



CUT-OFF TOOL

Model No. 5564A

- Rear exhaust
- Comfort Grip
- Lockoff lever throttle
- Aluminum housing
- Free speed: 21,000 rpm
- Blade Diameter: 3" (76 mm)
- Weight: 1.8 lb (0.08 kg)
- Length: 8" (203 mm)
- Air inlet size: 1/4" NPT
- Recommended hose size: 3/8" (10 mm)
- 3/8" Arbor



AIR ENGRAVING PEN

Model No. 5980

- 13,000 cycles per minute
- Replaceable carbide tipped points
- Twist throttle
- 59" (1500 mm) hose
- 1/4" NPT air fitting
- High quality stainless steel housing
- Replaceable engraving points
 - 506246 - 45° (STD)
 - 506245 - 30°
 - 506244 - 15°





DUSTLESS WET/DRY VACUUM

- Outperforms Traditional Shop Vacs
- Two Layers Of Filtration For A Dust-Free Environment
- Powerful 23,000 RPM, 11.5 Amp Electric Motor
- 16 Gallon Capacity
- Does Not Cough Dust When Vacuum Is Turned On
- Convenient Tool Storage Onboard Vacuum
- Filtration Down To 0.5 Microns
- Quiet Operation Only 81 dB(A)



DVS-5

DUSTLESS HEPA VACUUM

- HEPA Certified
- Filtration Down To 0.3 Microns
- 16 Gallon Capacity
- Designed For Extra Fine Dust
- Quiet Operation Only 81 dB(A)
- Great For Hexavalent Chromium Applications



DVH-3

DRILL AND RIVET SHAVER VACUUM SHROUD

- Can Be Used With Any Drill Or Rivet Shaver
- Suction Holds The Shroud In Place
- Great For Tight Spaces
- Can Be Used For Drilling Holes Up To 1-3/8" Diameter
- Captures 99% Of Airborne Dust
- Protects Workers From Harmful Airborne Dust
- Transparent For Better Visibility
- Includes 6 ft. Vacuum Hose



DRVS150

HEPA FILTER

- Certified To Meet OSHA, EPA, & NIOSH Guidelines
- Captures Dust Down To 0.3 Microns
- Large Circumference For Increased Life
- Large Loose Plates For Increased Air Flow



MV-21

MICRO PRE-FILTER BAG

- Disposable
- Eliminates The Need To Clean Filters
- Retains Strength When Wet
- Holds More Than 40 lbs. Of Dust And Debris
- Captures Extra Fine Dust Down To .5 Microns
- Extends The Life Of HEPA Filters
- Large Surface Area For Maximum Airflow



MV-52

FABRIC FILTER SET

- 2 Stage Inner And Outer Filter
- Machine Washable
- Stays Dry At All Times
- Clean Outer Filter Without Opening the Canister
- No Need To Change Filters When Changing From Wet To Dry Vacuuming
- Large Surface Area For Maximum Flow



MV-51

HOSE CUFF ADAPTER SET

- Adapts 1-1/2" hose to 1-1/4" hose
- Connector for 1-1/2" vacuum hose

MV-49



PNEUMATIC TOOL REMOTE START ADAPTER

- Lets You Start And Stop Your Pneumatic Tool And Vacuum In Synchronization
- Works With Any Pneumatic Tool
- Wireless Radio Operated
- Quick And Easy To Set Up

DVRS-PA



ELECTRIC TOOL REMOTE START ADAPTER

- Works With Any Electric Power Tool
- Works With Any Vacuum
- Recognizes Up To 16 Tool / Tool Pods
- Wireless Radio Operated
- Quick And Easy To Set Up
- Reduces Trip Hazard (Fewer Cords)

DVRS-EA



VACUUM REMOTE START ADAPTER

- Allows the use of multiple tools off the same vacuum
- Can be used with any pneumatic tool or electric power tool

DVRS-VA

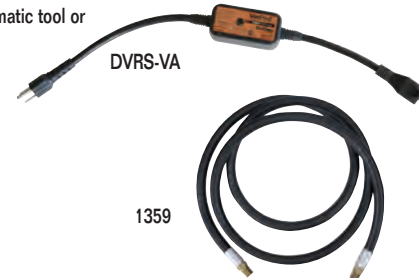

1359

AIR HOSES

Part Number	ID		Length		Fittings
	in	mm	ft	m	
1376	3/8	10	6	2.7	1/4" NPT
1377	3/8	10	25	11	1/4" NPT
1361	1	25	4	1.8	None



1326

NYLON RECOIL AIR HOSE

Part Number	ID		Length		Fittings
	in	mm	ft	m	
1326B	1/4	6	25	11	1/4" NPT
1327B	3/8	10	25	11	1/4" NPT

2300-4



BALANCERS

Part Number	Capacity		Cable Length	
	lb	mm	in	m
2300-4B	2 - 4	0.9 - 1.8	5.2	1.6
2300-6	4 - 6	1.8 - 2.7	6.7	2
2300-8B	6 - 8	2.7 - 3.6	6.7	2



HIGH-CAPACITY QUICK CHANGE COUPLERS

Part Number	Description	Thread
1316	Male Coupler Nipple	1/4" NPT
1317	Male Coupler Nipple	3/8" NPT
1318	Male Coupler Nipple	1/2" NPT
1391B	Quick Change Coupler	1/4" NPT
1392B	Quick Change Coupler	3/8" NPT
1393	Quick Change Coupler	1/2" NPT
1395	Female Coupler Nipple	1/4" NPT
1396	Female Coupler Nipple	3/8" NPT
1397	Female Coupler Nipple	1/2" NPT



SIoux-PER SWIVEL

Allows the air hose to rotate 360° on 2 axes

Part No. 1338-25

1/4" non-regulated air swivel connector with safety pin design

Part No. 1338-38

3/8" non-regulated air swivel connector with safety pin design

Part No. 1338-50

1/2" non-regulated air swivel connector with safety pin design

Part No. 1338FC-25

1/4" regulated air swivel connector with safety pin design

AIR MOTOR OIL FOR AIR TOOLS

Part No. 288

1/2 Pint

Part No. 288-1

1 Quart

Part No. 288-2

2 Liter



GREASE

Part Number	Size
289A	1 Quart
289A-1	2 Pounds
289A-2	6 Pounds
1198	6 Ounces
1198-1	2 Pounds
1198-2	6 Pounds
1232A	3 Ounces
1232A-02	1 1/2 Ounces
1232A-04	4 Ounces
1232A-1	1 Quart
1232A-2	1 Gallon

GREASE GUN

Part No. 442

Used on Impacts and Tools with greaseable gears

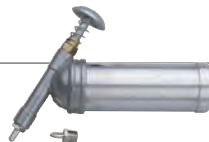

FILTER, REGULATOR, LUBRICATOR ASSEMBLY

Part No. 1660

1/2" NPT fittings

Air flow: 30 - 75 cfm

Part Number	Description
1660B	Complete Air Control Unit, 1/2"PT
1661	Lubricator Only, 1/2"PT
1662A	Regulator with Gauge, 1/2"PT
1663	Manual Flex Drain Filter, 1/2"PT
1664	Manifold Block
1665	Connecting End Blocks
1666	Modular Sleeve ("O" Ring included)
1667	Automatic Drain - Optional
1668	Sleeve Wall Mounting Bracket



FILTER, REGULATOR, LUBRICATOR ASSEMBLY

Part No. 1651MA

3/4" NPT air fittings

Air flow: over 75 cfm

Part Number	Description
1651MA	Complete Automatic Air Control Unit, 3/4" PT, larger capacity and float type filter for automatic drain
1652M	Lubricator only, 3/4" PT, 1 quart capacity
1654B	Regulator with Gauge, 3/4" PT
1653MA	Automatic Air Filter, 3/4" PT, automatic float drain empties when full

AIR REGULATOR

Part No. 1335B

1/4" NPT Male / Female



GREASE GUN

Part No. 439

Used with impact wrenches and multi-assembly angle tools.

For use with grease tube 1232A-04

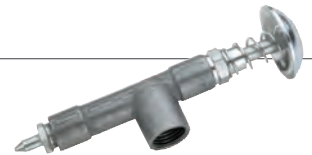

GREASE NOZZLE

Part No. 469A

Used with No. 468A grease gun



SERVICE



Factory Authorized Service

Sioux Tools has Authorized Service Distributors conveniently located throughout the U.S., Canada and internationally to provide you with service virtually anywhere, anytime. Each is staffed with professional tool repair technicians who know Sioux tools, inside and out, and are able to provide complete and comprehensive repairs.

Each location features the newest in testing and inspection equipment to ensure your tool is repaired and serviced properly... the first time. Every tool that is serviced or repaired is calibrated and tested to the latest standards guaranteeing you the best performance possible.

Contact customer service for a complete listing of Authorized Service Distributors.

TRAINING

Committed to your Success

To ensure your personnel are knowledgeable about not only Sioux products, but all air tools and products, Sioux Tools conducts training seminars that cover all aspects of the tools we sell. We offer introductory training seminars to help you understand our entire line of tools and their basic operation. Advanced training is tailored to individual needs to help build the skill of an experienced student. In addition, hands-on training is available with particular focus on troubleshooting and repairing.

Contact customer service for a additional information on Sioux Tools training seminars.