

OPER

TOOLS

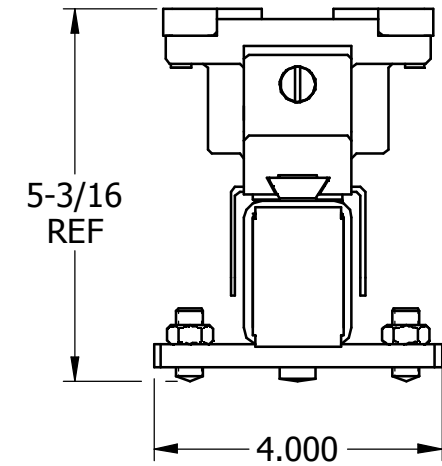
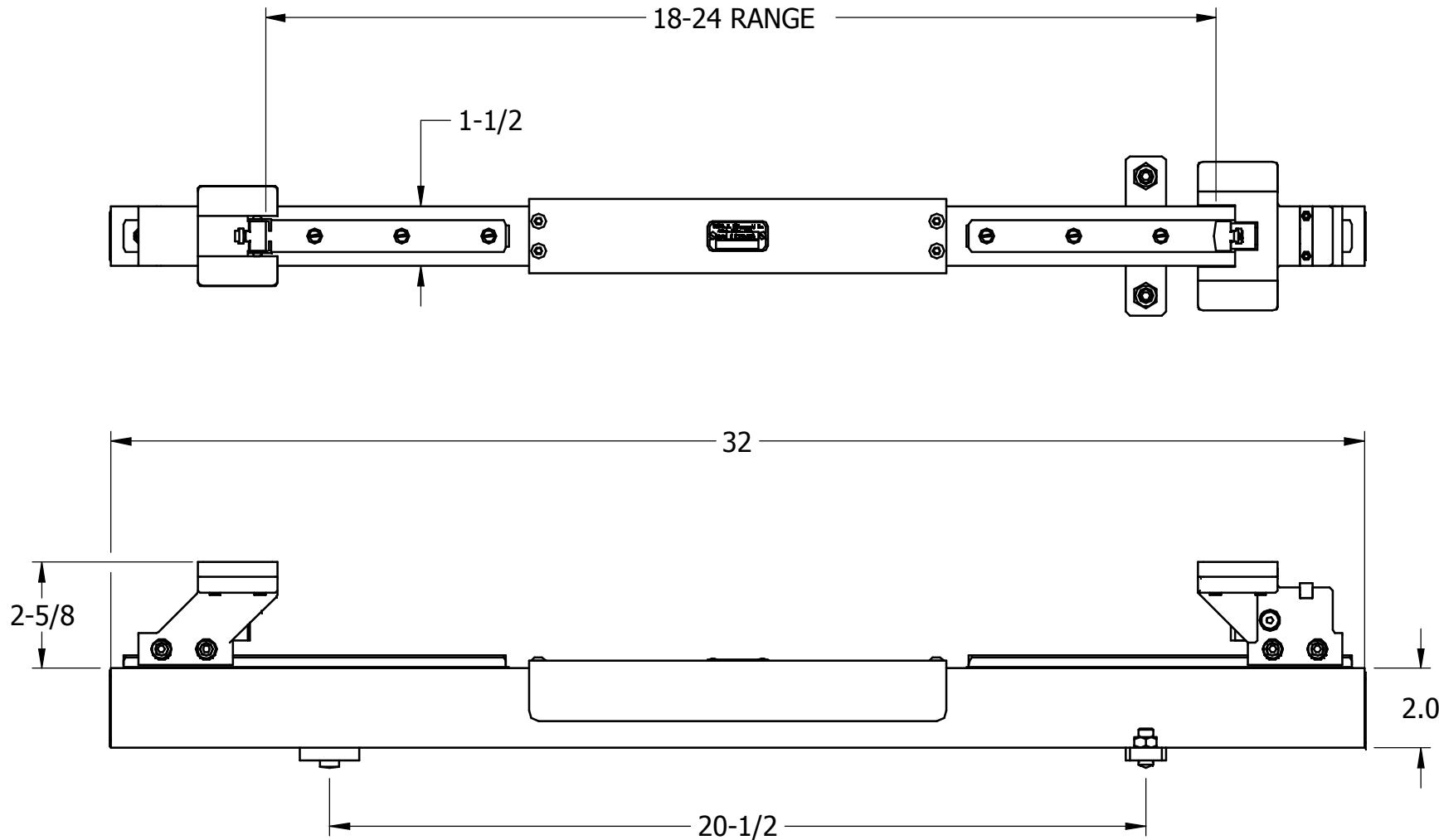

REV	DESCRIPTION	DATE	BY
DR	WEN	CHK	DATE

**INTERNAL-EXTERNAL  
SETTING MASTER  
RANGE 18" - 24"**

**THE L.S. STARRETT CO.  
ATHOL, MASS.**

FRACTIONAL TOLERANCE +- 1/64 UNLESS OTHERWISE NOTED