

OPER

TOOLS

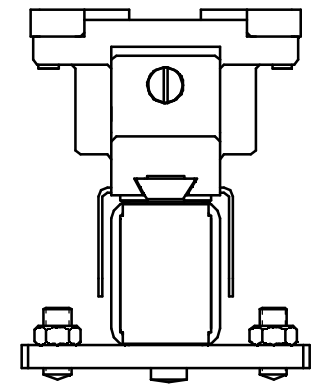
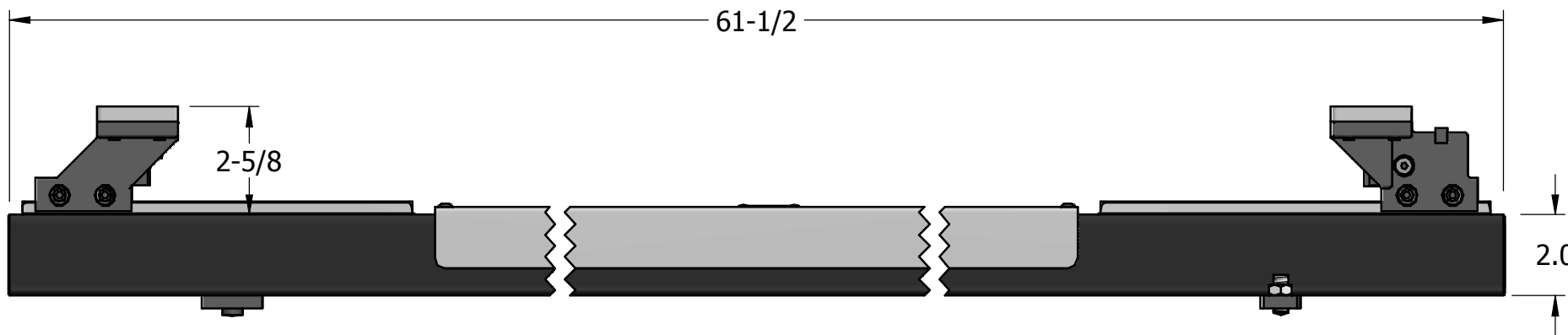
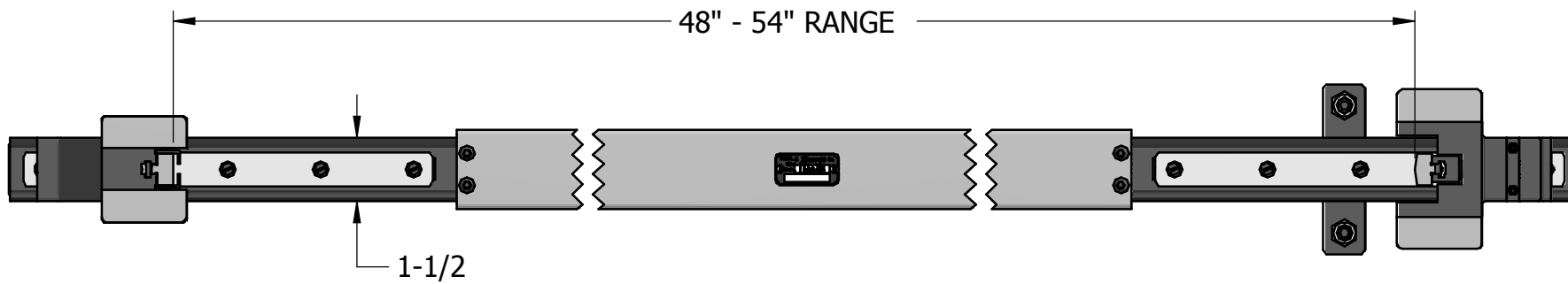

REV	DESCRIPTION	DATE	BY
DR	WEN	CHK	DATE

**INTERNAL - EXTERNAL
SETTING MASTER
RANGE 48" - 54"**

**THE L.S. STARRETT CO.
ATHOL, MASS.**

FRACTIONAL TOLERANCE $\pm 1/64$ UNLESS OTHERWISE NOTED