

SH. 1  
OF 1

CAT NO

C404R-48

CUSTOMER DIMENSIONS

DO NOT  
SEPARATE  
PRINT FROM  
WORK

LOT NO

OPER

109

TOOLS

N/C PROGRAM

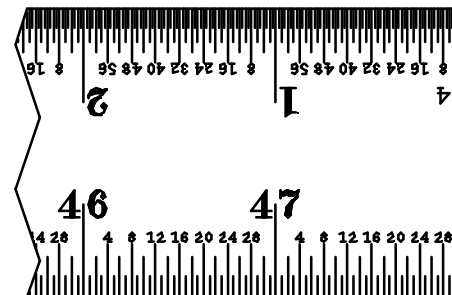
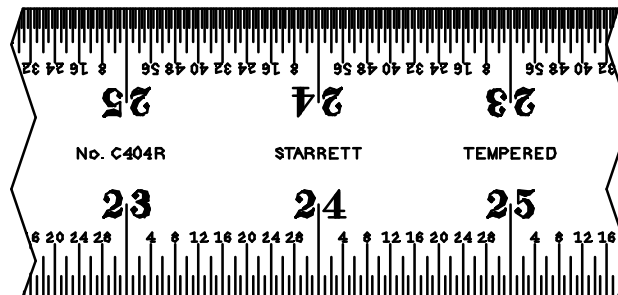
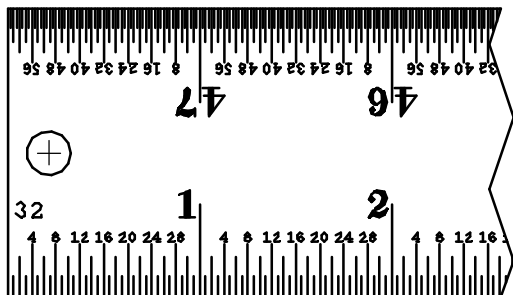

1-1/2  
(38.1)

48  
(1219.2)

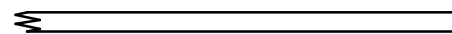
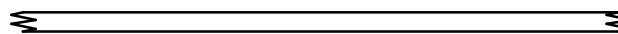
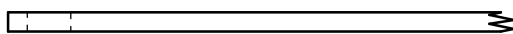

.100  
(2.54)

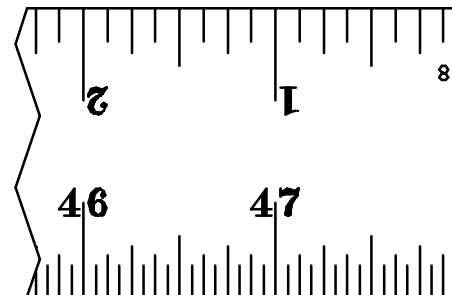
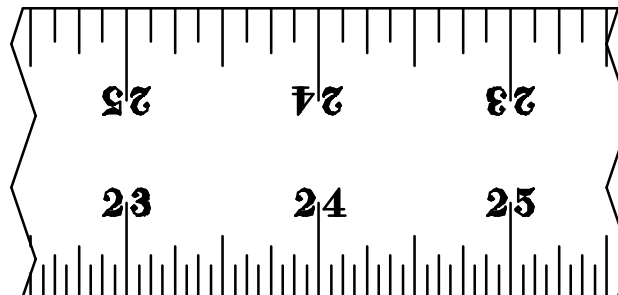
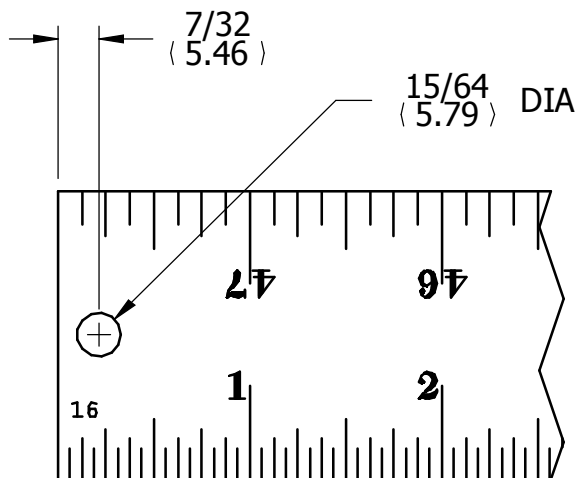

REV	DESCRIPTION	DATE	BY
DR	JAC	CHK	DATE

**HEAVY SPRING TEMPERED  
STEEL RULE**

FRACTIONAL TOLERANCE +- 1/64 UNLESS OTHERWISE NOTED

THE L.S. STARRETT CO.  
ATHOL, MASS.