

TRU-FLATE®

Air Line Accessories and Tire Hardware



Standard & Safety Blowguns ■ Filters/Regulators/Lubricators
Couplers & Plugs ■ Tire Gauges & Air Chucks ■ Amflo® Air Line Hoses

 **Camel.** Tire Repair Products

Table of Contents / Displays

Displays/Merchandisers	2-3
Design Identification	4
Plug & Coupler Features	5
Plugs & Couplers	6-9
Tire Gauges	9-11
Air Chucks, Inflator Gauges & Components	12-13
Air Line Chuck Service Parts / Standard Blowguns	14
Standard & Safety Blowguns	14-16
Blowgun Accessories & Water Valves	16
Hose Fittings, Pipe Couplings & Adapters	17-18
Air Line Hoses	19
Air Line Hook-Up Hints	20-21
Air Line Filters, Regulators & Lubricators	22-23
Dessicants, Oil Removal Filters & Pressure Gauges	24
F.R.L. Replacement Parts & Accessories	25
In-Line Tool Oilers, Regulators & Filters	26
Driveway Signals	27
Camel® Tire Repair Products	27-39
Amflo® Hoses	40-41
Amflo® Hose Reels	42

Merchandisers

Tru-Flate® packaging combines color, eye-catching graphics and essential “how to use” information for added value to customers. Tru-Flate displays are versatile, with interchangeable headers, moveable hooks and pre-printed back-up cards.

4-Panel Display

96-650 Tru-Flate's most popular air line accessories and tire hardware conveniently mounted on 4 display panels. Free standing display swivels for space efficiency, easy product selection and restocking. Display includes Coupler Test Bar for easy in-store identification of coupler and plug design style.

Couplers & Plugs

96-650-10 (Panel 1)

96-901		Couplers & Plugs				
13-201	13-225	13-235	13-775	13-537		
12-229	12-239	12-225	12-235	12-527		
13-101	13-125	13-135	13-611	13-613		
12-127	12-125	12-135	12-603	12-605		
12-137	13-511	13-335	12-325	12-335		
13-713	12-705	13-435	12-425	12-435		

Blowguns & Tire Hardware

96-650-11 (Panel 2)

Blowguns & Tire Hardware				
17-509	17-519	17-521	17-525	17-545
17-527	17-529	18-247		
17-539	17-551	18-203	18-207	
41-125	41-135	18-233	18-237	18-603

Chucks, Fittings & Gauges

96-650-12 (Panel 3)

Chucks, Fittings & Gauges				
17-351	17-353	17-383	17-395	17-850
17-369	41-101			
21-123	21-133	21-143	21-147	
21-323	21-423	21-467	21-505	23-403
21-515	21-535	21-557	41-300	
21-605	21-707	22-123		

Tire Maintenance Center

96-650-13 (Panel 4)

Tire Maintenance Center				
38-505	38-600-4	38-712-4	38-772-4	38-790-4
38-900	38-324-4	38-325-4	38-326-4	38-315-4
30-413-2	30-414-2	30-415-2	30-418-2	30-445
30-316-4	12-077	14-130	15-165	15-169
41-067				
14-134	17-236	40-395	41-466	15-162

Tire Maintenance Center				
12-077	14-134	14-130	14-132	15-164
15-162	15-163	15-165	15-169	15-172
17-295	17-244	15-224	17-235	17-236

BASKET CONTAINS:

13-103	13-320	14-154	14-404
13-105	14-137	14-401	14-409
13-310	14-153	14-403	15-179

15-184	12-085	12-086	12-089	12-090	12-092
--------	--------	--------	--------	--------	--------

Camel® Tire Repair Display

96-213 All of the most popular Camel tire repair products in one display. Includes all you need of the top selling patches, repair tools and cements.

96-213-01 Merchandise only.

Air Accessories				
13-225	13-225	12-225	12-225	13-201
13-235	13-235	12-235	12-235	13-201
13-125	12-125	18-207	41-300	17-509
13-135	12-135			
21-505	21-515	21-535	24-343	23-403
21-123	21-143	17-351		
21-467	21-557	21-707	24-444	

Air Accessory Display

96-640 A one panel display that includes many of the top moving skus in the Tru-Flate® line including 25' and 50' Amflo® PVC hoses.

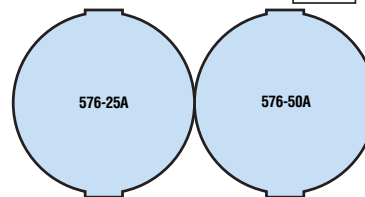

2-Panel Displays

Purchase both panels for the widest, most complete range of tire hardware, air accessories couplers, plugs, chucks, fittings and gauges – or order a single panel for key products.

96-610 Includes 96-610-02 and 96-610-03.

Tire Maintenance Center				
17-509	17-515	17-519	17-525	17-545
14-134	14-130	17-527	17-551	
15-165	15-169	38-505	386004	387124
		303184	387904	41-067
383244	383254	383264	383144	383154

Tire Maintenance Center

Includes tire gauges, tire patching materials and the most popular tire extensions, caps, cores and sleeves.

96-610-02
Display & Merchandise.

96-610-12
Merchandise Only.

Air Accessories				
13-101	12-125	13-135	12-325	13-335
13-201	12-225	13-235	12-425	13-435
17-351	21-123	21-143	21-423	22-123
23-403				
	18-233	18-203	18-601	18-603
	41-101	41-300	17-383	

Air Accessories

Covers all four common pneumatic coupler and plug designs, popular brass fittings and air line chucks, blowguns and coiled air hose.

96-610-03
Display & Merchandise.

96-610-13
Merchandise Only.

96-630 Includes 96-630-02 and 96-630-03.

Couplers & Plugs				
13-101	13-125	13-135	12-125	12-135
13-201	13-225	13-235	12-225	12-235
13-301	13-325	13-335	12-325	12-335
13-401	13-425	13-435	12-425	12-435
13-611	13-613	12-603	12-605	12-705
13-713	13-755	13-537	12-527	13-511

Couplers & Plugs

96-630-02
Most popular sizes of Tru-Flate, Lincoln, I/M, and Aro couplers/plugs.

Blowguns, Chucks & Fittings				
21-123	21-133	21-143	21-147	17-850
21-323	21-423	21-467	21-505	
21-515	21-535	21-605	17-351	
17-353	17-383	18-603	41-125	17-373
17-361				23-403
18-203	18-233	18-207	17-385	

Blowguns, Chucks & Fittings

96-630-03
Most popular air hose fittings, chucks, blowguns.

Design Identification

How to Identify Interchange Designs

Interchangeability of pneumatic couplings is determined by PLUG DESIGN. Learn to identify the basic plug types, and coupler and plug interchange will become easy. There are SEVEN different designs currently used in the automotive market. Four of these seven cover more than 97% of all quick couplings used today. Tru-Flate® provides complete interchange to the four primary designs. The three designs NOT covered are shown at the bottom of the page.

TRU-FLATE DESIGN

12/13-100 Series

This design is easily recognized because it has the shortest plug pilot in the industry; however, it has the widest metal section between the ball groove and the pilot. In addition, the sealing surface on the end of the plug is wider than other “interchange” designs. This design provides better sealing characteristics and longer seal life.

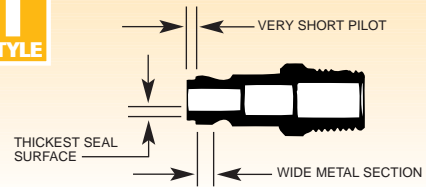

INDUSTRIAL/MILTON DESIGN

12/13-200 Series

This design has been adopted by many coupler manufacturers, including Milton, Hansen, Aro, Lincoln and Schrader. It will work with either “sleeve” type or “push” type couplers. No matter what the coupler looks like, if it mates with this plug, it is an “Industrial/Milton Interchange” design. It can be identified by its 3/16” pilot and its flat-bottomed “V”-shaped ball groove. Conforms to ANSI (NFPA) T3.20.14-1990 dimensions.

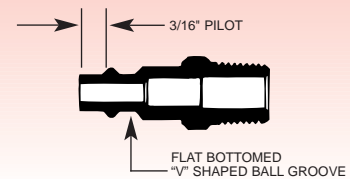

ARO DESIGN

12/13-300 Series

This design is characteristic of the Aro-210 series, and requires a coupler of proper matching design. Although similar in appearance to the “Industrial/Milton Interchange” design, it can be easily distinguished because its pilot is 1/8” longer and its ball groove is nearly round.

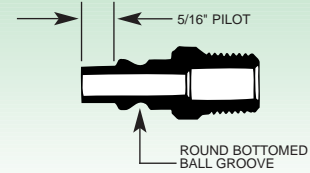

LINCOLN DESIGN

12/13-400 Series

The “Lincoln Long-Stem” design is the most easily identified design. The long 3/4” pilot is so distinctive it cannot be confused with other designs. It will only mate with couplers of matching design and size.

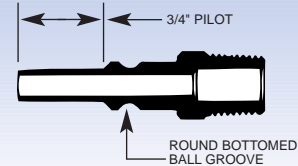

OTHER DESIGNS

SCHRADER STANDARD

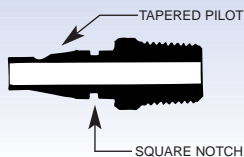

DIAMOND “U”

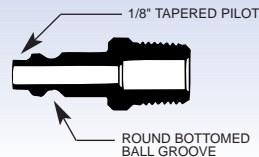

GRACO

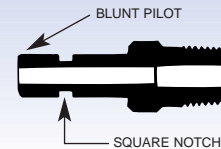

How to Interchange Couplers and Plugs

DESIGN SELECTION

Similar name designs, whether manufactured by Tru-Flate or competitor, are interchangeable. NOTE: Designs are **not interchangeable** with other designs.

SIZE SELECTION

There are three BODY SERIES sizes – Standard 1/4” and Heavy Duty 3/8” and 1/2”. To interchange, the coupler and plug must have the same body size.

Plug & Coupler Features

Tru-Flate® Couplers and Plugs

100% RELIABLE

Unique Performance Features Makes Tru-Flate Couplings Work Better and Last Longer.

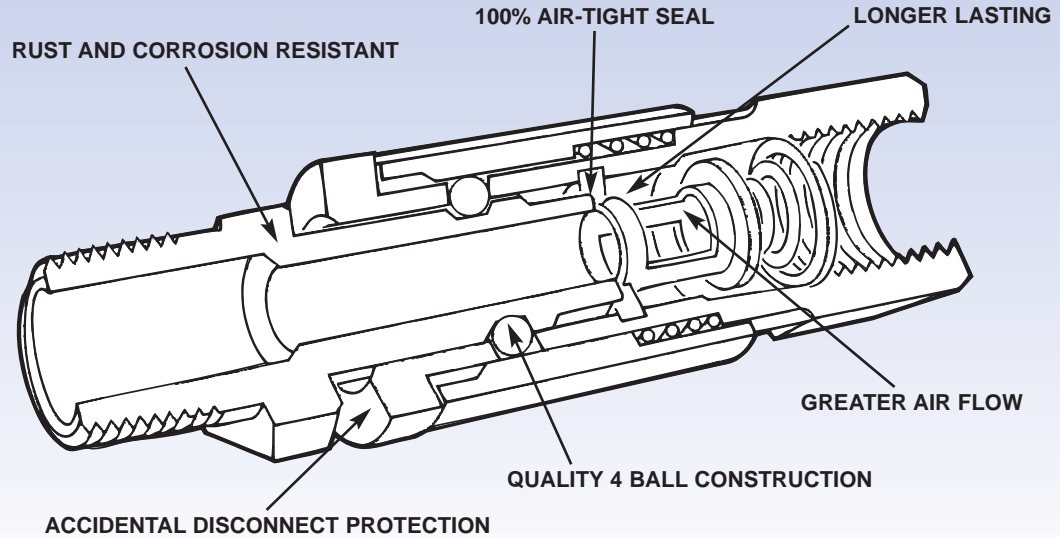

Tru-Flate Coupler and Plug Advantages

- **Greater Air Flow...** Tru-Flate's tubular valve construction passes more air at lower pressure drops than competitive blade or knife type valve designs.
- **100% Air-Tight Seal...** Our spring-loaded, air-assisted valve design strengthens coupler seal as line pressure is increased. Extra locking carbon steel ball bearings provide a tighter fit and accurate alignment for superior performance.
- **Accidental Disconnect Protection...** Tru-Flate's sleeve guard reduces the potential for accidental disconnect and protects the sleeve under the toughest working conditions.
- **Lasts Longer...** Prolonged seal life due to the tubular valve support, thus preventing the seal from moving into the air flow path. Eliminates the wear and damage that occurs with competitive blade or knife type valves.

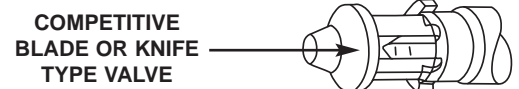
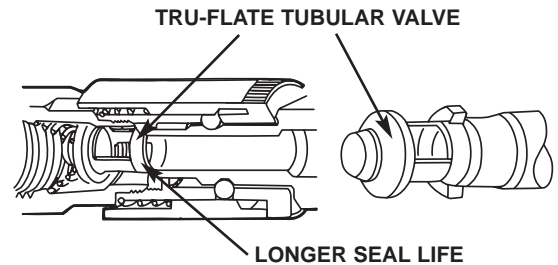

Coupler Test Bar

96-901 Makes coupler and plug sales easy. Gives counter men a "surefire" way to quickly and accurately identify the proper 1/4" series plug for their coupler. Metal bar has each of four basic design plugs permanently fastened to the bar. Color coded plugs on bar match correct coupler and plug package. Each design name is stamped in bar. Complete with handy hanger strap. For positive identification, simply try the coupler on each plug until: 1) coupler engages the plug fully, and the sleeve returns to its full locked position, 2) the coupler swivels freely on the plug, and 3) you can blow through the coupler and plug while they are engaged.

96-902 Plug test bar. 1/bag.

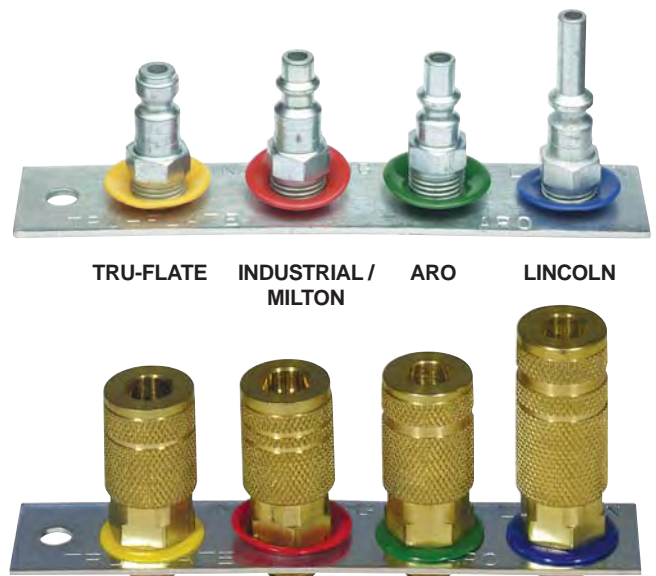



Plugs & Couplers

Tru-Flate® Design Plugs and Couplers (One Narrow Band on Coupler Body)

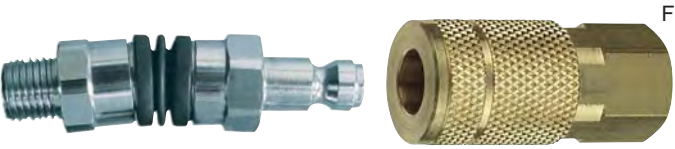
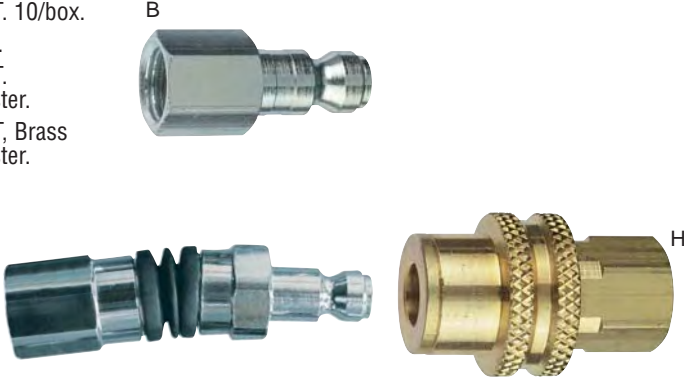

The Tru-Flate Design Plug is recognized by the extremely short pilot; however, it has the widest metal section between the groove and the pilot. The sealing surface on the end of the plug is wider than other interchanges, resulting in better sealing and longer seal life. The Tru-Flate Design Coupler utilizes the tubular valve which supports the seal and allows more air flow at lower pressure drops than most competitive couplers. The protective collar guards against accidental disconnect.

Plugs	1/4" BODY SERIES	Couplers
<p>12-124 1/4" Male NPT. 10/box. 12-124-07 Bulk. 250/box. 12-125 1/4" Male NPT. Carded. 10/master. 12-125B 1/4" Male NPT, Brass Carded. 10/master.</p>	 <p>A E</p>	<p>13-124 1/4" Male NPT. 10/box. 13-124-07 Bulk. 100/box. 13-125 1/4" Male NPT. Carded. 10/master.</p>
<p>12-127 1/4" Swivel Male NPT. Carded. 5/master.</p>	 <p>B F</p>	<p>13-134 1/4" Female NPT. 10/box. 13-134-07 Bulk. 100/box. 13-135 1/4" Female NPT. Carded. 10/master. 13-138 3/8" Female NPT. 10/box.</p>
<p>12-134 1/4" Female NPT. 10/box. 12-134-07 Bulk. 250/box. 12-135 1/4" Female NPT. Carded. 10/master. 12-135B 1/4" Female NPT, Brass Carded. 10/master.</p>	 <p>C H</p>	<p>13-137 1/4" Female NPT with raised collar. Carded. 5/master.</p>
<p>12-137 1/4" Swivel Female NPT. Carded. 5/master.</p>		<p>Coupler/Plug Set With one each 1/4" Female NPT Coupler (13-135) and 1/4" Male NPT Plug (12-125). 13-101 Carded. 10/master.</p>
<p>12-117 1/4" ID Hose Barb. Carded. 10/master.</p>	 <p>C</p>	

Plugs	3/8" BODY SERIES	Couplers
<p>12-602 1/4" Male NPT (see style A above). 10/box. 12-603 1/4" Male NPT (see style A above). Carded. 10/master. 12-604 3/8" Male NPT (see style A above). 10/box. 12-605 3/8" Male NPT (see style A above). Carded. 10/master. 12-610 1/4" Female NPT (see style B above). 10/box. 12-612 3/8" Female NPT (see style B above). 10/box.</p>		<p>13-602 1/4" Male NPT (see style E above). 5/box. 13-604 3/8" Male NPT (see style E above). 5/box. 13-610 1/4" Female NPT (see style F above). 5/box. 13-611 1/4" Female NPT (see style F above). Carded. 5/master. 13-612 3/8" Female NPT (see style F above). 5/box. 13-613 3/8" Female NPT (see style F above). Carded. 5/master.</p>

Plugs	1/2" BODY SERIES	Couplers
<p>12-702 3/8" Male NPT (see style A above). 10/box. 12-704 1/2" Male NPT (see style A above). 10/box. 12-704-07 Bulk. 125/box. 12-705 1/2" Male NPT (see style A above). Carded. 10/master. 12-712 1/2" Female NPT (see style B above). 10/box. 12-713 1/2" Female NPT (see style B above). Carded. 5/master.</p>		<p>13-705 1/2" Male NPT (see style F above). Carded. 5/master. 13-712 1/2" Female NPT (see style F above). 5/box. 13-713 1/2" Female NPT (see style F above). Carded. 5/box.</p>

WARNING: Due to their large size, these couplers should not be connected or disconnected if the line pressure exceeds 40 PSI.
WARNING: Couplers and plugs are intended for use on compressed air lines only. All have maximum rated working pressure of 300 PSI.

Plugs & Couplers



Industrial/Milton Design Plugs and Couplers (Two Narrow Bands on Coupler Body)

This plug design has been adopted by most coupler manufacturers. For this reason it is considered the industrial standard. It can be identified by the 3/16" pilot and flat bottom "V"-shaped ball groove. Conforms to ANSI (NFPA) T3.20.14-1990 dimensions. Couplers are available in both standard and push-to-connect style sleeve.

Plugs	1/4" BODY SERIES		Couplers
<p>12-224 1/4" Male NPT. 10/box. 12-224-07 Bulk. 250/box. 12-225 1/4" Male NPT. Carded. 10/master. 12-226 3/8" Male NPT. 10/box.</p>	A 	D 	<p>13-224 1/4" Male NPT. 10/box. 13-224-07 Bulk. 100/box. 13-225 1/4" Male NPT. Carded. 10/master. 13-226 3/8" Male NPT. 10/box.</p>
<p>12-229 1/4" Swivel Male NPT. Carded. 5/master.</p>		E 	<p>13-234 1/4" Female NPT. 10/box. 13-234-07 Bulk. 100/box. 13-235 1/4" Female NPT. Carded. 10/master. 13-236 3/8" Female NPT. 10/box. 13-236-07 Bulk. 100/box.</p>
<p>12-234 1/4" Female NPT. 10/box. 12-234-07 Bulk. 250/box. 12-235 1/4" Female NPT. Carded. 10/master. 12-236 3/8" Female NPT. 10/box. 12-236-07 Bulk. 250/box.</p>	B 	F 	<p>13-264 1/4" ID Hose Barb. 10/box. 13-264L 1/4" ID Hose Barb. Individually Bar Coded 10/box. 13-266 3/8" ID Hose Barb. 10/box.</p>
<p>12-239 1/4" Swivel Female NPT. Carded. 5/master.</p>		G 	<p>13-753 Push Coupler 1/4" Female NPT. 5/box. 13-755 Push Coupler 1/4" Female NPT. Carded. 10/master.</p>
<p>12-264 1/4" ID Hose Barb. 10/box. 12-264-07 Bulk. 250/box. 12-264L 1/4" ID Hose Barb. Individually Bar Coded. 10/box. 12-266 3/8" ID Hose Barb. 10/box. 12-266-07 Bulk. 250/box.</p>	C 	H 	<p>13-754 Push Coupler 1/4" Male NPT. 5/box. 13-756 Push Coupler 1/4" Male NPT. Carded. 10/master.</p>
<p>Coupler/Plug Set With one each 1/4" Female NPT Coupler (13-235) and 1/4" Male NPT Plug (12-225). 13-201 Carded. 10/master.</p>			<p>1/4" Coupler Kit With one each 1/4" Female NPT Coupler (13-235), 1/4" Male NPT Coupling (21-505), 1/4" Male NPT Plug (12-225) and 1/4" Female NPT Plug (12-235). 13-203 Carded. 5/master.</p>

Plugs	3/8" BODY SERIES	Couplers
<p>12-525 1/4" Male NPT (see style A above). 5/box. 12-526 3/8" Male NPT (see style A above). 5/box. 12-527 3/8" Male NPT (see style A above). Carded. 5/master. 12-535 1/4" Female NPT (see style B above). 5/box. 12-536 3/8" Female NPT (see style B above). 5/box. 12-537 3/8" Female NPT (see style B above). Carded. 5/master.</p>		<p>13-525L 1/4" Male NPT Individually Bar Coded. (see style D above). 10/box. 13-526 3/8" Male NPT (see style D above). 5/box. 13-527 3/8" Male NPT (see style D above). Carded. 5/master. 13-536 3/8" Female NPT (see style E above). 5/box. 13-537 3/8" Female NPT (see style E above). Carded. 5/master.</p>

Plugs	1/2" BODY SERIES	Couplers
<p>12-752 1/2" Male NPT (see style A above). 10/box. 12-762 1/2" Female NPT (see style B above). 10/box. 12-762-07 Bulk. 250/box.</p>		<p>13-705 1/2" Male NPT (see style D above). Carded. 5/master. 13-712 1/2" Female NPT (see style E above). 5/box. 13-713 1/2" Female NPT (see style E above). Carded. 5/master.</p>

WARNING: Due to their large size, these couplers should not be connected or disconnected if the line pressure exceeds 40 PSI.
WARNING: Couplers and plugs are intended for use on compressed air lines only. All have maximum rated working pressure of 300 PSI.

Plugs & Couplers

ARO Design Plugs and Couplers (One Wide Band on Coupler Body)



This design is identified by a 5/16" pilot and ball groove which is nearly round. It is similar in appearance to the Industrial Interchange and care must be taken to correctly identify. Couplers are available in both standard and push to connect style sleeve.

Plugs	1/4" BODY SERIES	Couplers
-------	------------------	----------

- 12-324** 1/4" Male NPT. 10/box.
- 12-324-07** Bulk. 250/box.
- 12-325** 1/4" Male NPT. Carded. 10/master.



- 13-324** 1/4" Male NPT. 10/box.
- 13-325** 1/4" Male NPT. Carded. 10/master.

- 12-334** 1/4" Female NPT. 10/box.
- 12-335** 1/4" Female NPT. Carded. 10/master.

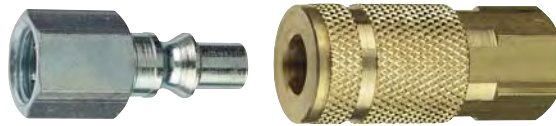

- 13-334** 1/4" Female NPT. 10/box.
- 13-334-07** Bulk. 100/box.
- 13-335** 1/4" Female NPT. Carded. 10/master.

Coupler/Plug Set

With one each 1/4" Female NPT Coupler (13-335) and 1/4" Male NPT Plug (12-325).
13-301 Carded. 10/master.



- 13-774** Push Coupler 1/4" Female NPT. 10/box.
- 13-775** Push Coupler 1/4" Female NPT. Carded. 10/master.

Lincoln Design Plugs and Couplers (One Wide and One Narrow Band On Coupler Body)



This plug is the most easily recognized design. The long 3/4" pilot is so distinctive it cannot be confused with any other designs. Couplers are available in sleeve type only.

Plugs	1/4" BODY SERIES	Couplers
-------	------------------	----------

- 12-424** 1/4" Male NPT. 10/box.
- 12-424-07** Bulk. 250/box.
- 12-425** 1/4" Male NPT. Carded. 10/master.



- 13-424** 1/4" Male NPT. 10/box.
- 13-424-07** Bulk. 100/box.
- 13-425** 1/4" Male NPT. Carded. 10/master.

- 12-434** 1/4" Female NPT. 10/box.
- 12-434-07** Bulk. 250/box.
- 12-435** 1/4" Female NPT. Carded. 10/master.

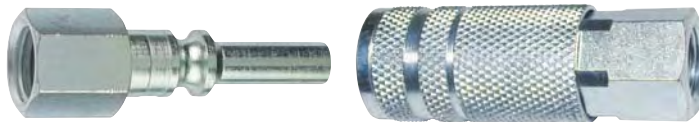

- 13-434** 1/4" Female NPT. 10/box.
- 13-434-07** Bulk. 100/box.
- 13-435** 1/4" Female NPT. Carded. 10/master.

Coupler/Plug Set

With one each 1/4" Female NPT Coupler (13-435) and 1/4" Male NPT Plug (12-425).
13-401 Carded. 10/master.

WARNING: Due to their large size, these couplers should not be connected or disconnected if the line pressure exceeds 40 PSI.

WARNING: Couplers and plugs are intended for use on compressed air lines only. All have maximum rated working pressure of 300 PSI.

Plugs, Couplers & Tire Gauges

Universal Couplers



Now one coupler fits the three most popular air line plugs. This coupler can be used with Tru-Flate®, Industrial/Milton and Aro Design 1/4" plugs. It eliminates confusion among designs. Quality, deluxe "push to connect" style makes coupling quick and easy. Heavy duty brass construction means longer life. Unique tubular valve construction allows greater air flow.

13-508 1/4" Male NPT. 10/box.

13-509 1/4" Male NPT. Carded. 10/master.

13-510 1/4" Female NPT. 10/box.

13-511 1/4" Female NPT. Carded. 10/master.

All-U-Need Air Tool Kit

Complete kit with all the air tool accessories you need – oil, couplers and plugs. Kit contains: 1 - LubriMatic® 4 oz. air tool oil (11715), 4 - 1/4" male plugs (12-125), 2 - 1/4" female plugs (12-135) and 2 - 1/4" female couplers (13-135).

13-103CC 5/Case-Cut Box.

WARNING: Due to their large size, these couplers should not be connected or disconnected if the line pressure exceeds 40 PSI.

WARNING: Couplers and plugs are intended for use on compressed air lines only. All have maximum rated working pressure of 300 PSI.

Tire Pressure Gauges

TRU-FLATE® HIGH QUALITY TIRE GAUGES are precision manufactured, providing the long life, accuracy and performance to surpass the requirements of the most demanding applications.

Standard Tire Gauge (10-50 lbs.)

17-509 Use for passenger cars, vans and light trucks. Calibrated 2 sides, 10-50 PSI in 1 lb. units and 70-350 kPa in 10 kPa units. Carded 10/master.

Radial Tire Gauge (12-48 lbs.)

17-515 Designed specifically to gauge pressure in radial tires to obtain maximum tire life, economy and safety. For passenger cars, vans and light trucks. Calibrated 2 sides 12-48 PSI in 1 lb. units numbered every 4 lbs., and 2 sides 70-350 kPa in 10 kPa units. Carded. 10/master.

Tractor Tire Gauge (5-45 lbs.)

17-517 For air and liquid filled tires. Includes special oiling and cleaning features to clean out corrosive fluids. For tractors, heavy equipment, farm and construction vehicles. Calibrated 5-45 PSI in 1 lb. units. Carded. 10/master.

17-517-07 Bulk. 100/Box

Truck Tire Gauge (20-120 lbs.)

17-519 Ideal for all higher pressure applications on lightweight trucks (1/2 to 2 1/2 tons), step vans, pickup and air shocks. Calibrated 2 sides 20-120 PSI in 2 lb. units and 2 sides 160-880 kPa in 20 kPa units. Carded. 10/master.

Low Pressure Tire Gauge (1-20 lbs.)

17-521 Low pressure readings at their best. Perfect for home garden tractors, golf carts, air springs, and ATVs. Calibrated 1-20 PSI in 1/2 lb. units. Carded. 10/master.

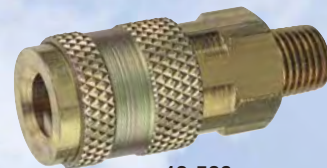

13-508
13-509

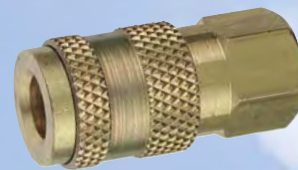

13-510
13-511



13-103CC

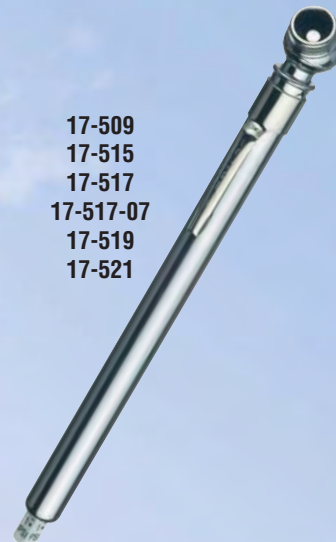

17-509
17-515
17-517
17-517-07
17-519
17-521

Tire Gauges

17-523
17-533



17-527



17-537



17-539



17-550-29



96-520

96-525



Tire Pressure Gauges (cont'd)

Easy Reach Tire Gauge (10-50 lbs.)

17-523 A must for testing pressure on tires with wheel covers. "Straight-On" type head makes hard to get at valves easy. Calibrated 10-50 PSI in 1 lb. units. Carded. 10/master.

Bicycle Tire Gauge (20-120 lbs.)

17-527 Custom designed for high pressure tires on bicycles, motorcycles, mini-bikes, scooters and other cycles. Calibrated 2 sides 20-120 PSI in 2 lb. units and 2 sides 160-880 kPa in 20 kPa units. Carded. 10/master.

Straight-On Truck Tire Gauge (20-120 lbs.)

17-533 Straight "push-on" head for truck tires! Ideal for high pressure tires on large trucks with Budd wheels, step vans, pickups, air shocks and any difficult-to-reach high pressure (20-120 PSI) reading. Perfect for inner wheels on duals, this gauge is pocket-sized with dual PSI/kPa calibrations in large, easy-to-read numbers. Carded. 10/master.

Digital Tire Gauge (5-99 lbs.)

17-537 With the Tru-Flate Digital Tire Gauge, all you have to do is place the nozzle on the tire valve, wait a moment for the reading to lock into the display, remove the gauge, and read the digital results. Gauge shuts off automatically upon removal. Carded. 5/master.

Digital Tire Gauge (5-150 lbs.)

17-539 Easy to use and easy to read, even at night. Calibrated in 1/2 lb. units. Carded. 6/master

Dial Tire Gauge Countertop Display

17-550-29 Contains 29 rugged 1 3/4" diameter dial gauges. Each gauge is individually bar coded. Place by countertops or by check-outs. Calibrated 0-60 PSI and 0-400 kPa. 29/Display.

Tire Gauge Displays

These eye catching displays include Tru-Flate's standard tire gauges (17-509) in 5 vibrant metallic colors – red, blue, black, chrome and green. Designed to accommodate peg hook or counter top display, wherever your store traffic is heaviest. The gauges are calibrated 2 sides 10-50 PSI in 1 lb. units and 70-350 kPa in 10 kPa units.

96-520 10 piece gauge display.

96-525 20 piece gauge display.

Personalized Tire Gauge Imprinting

Company name and/or logo can be permanently imprinted on tire gauges. Ideal premium gift, certain to be popular. Choice of colors: red, blue, green, black, gold, silver, grey and orange. Contact your Tru-Flate representative for pricing.

Economy Tire Gauges

Introducing two low-cost, high-quality tire gauges. Same high quality as the rest of the tire gauge line.

Passenger Car Tire Gauge (10-50 lbs.)

17-529 Easy to use for passenger cars, vans and light trucks. Calibrated 2 sides 10-50 PSI in 1 lb. units and 2 sides 70-350 kPa in 10 kPa units. Carded. 10/master.

Truck Tire Gauge (20-120 lbs.)

17-531 For accurate readings on high pressure tires for step vans, pickups, lightweight trucks (1/2 to 2 1/2 tons) and air shocks. Calibrated 2 sides 20-120 PSI in 2 lb. units and 2 sides 160-880 kPa in 20 kPa units. Carded. 10/master.

Dual Foot and Dial Gauges

Dual Foot Truck Gauge (20-120 lbs.)

17-525 For use on dual wheels and other difficult-to-reach valves. Short enough to fit in your pocket yet has a wide enough range to handle both cars and trucks. Calibrated 20-120 PSI in 2 lb. units and from 160-880 kPa in 20 kPa units. Carded. 10/master.

Dual Foot Service Tire Gauge (10-150 lbs.)

17-545 Designed for heavy-duty use required at the service level. Ideal for dual wheels and other difficult to reach valves on pickups, recreational vehicles (RV), heavy trucks and off-road equipment. Chrome plated brass with a die cast chuck. Calibrated 10-150 PSI in 2 lb. increments and from 100-1,040 kPa in 20 kPa increments. Complete with handy hang-up hook. Carded. 10/master.

Digital Straight-On Dual Foot Service Tire Gauge (10-150 lbs.)

17-547 Same design and function as our standard Straight-On service gauge, but now with the convenience of an easy to read back-lit digital display. Reads in PSI, Bar, kPa and kgf/cm². Swivel head design enables tire valves to be reached from all directions.

Straight-On Dual Foot Service Tire Gauge (10-150 lbs.)

17-565 Designed for the difficult-to-reach inner dual. Straight-On chuck for inside wheel and 30° reverse angle for outside wheel. Calibrated 10-150 PSI in 2 lb. units. Carded. 5/master.

Professional High Pressure Dial Gauge (0-60 lbs.)

17-549 Professional straight-on dial gauge complete with a protective rubber casing and locking sleeve design. Calibrated 0-60 PSI in 2 lb. increments and 0-400 kPa in 20 kPa units. Carded. 5/master.

Dial Tire Gauge (10-60 lbs.)

17-551 Professional type dial in a drawn steel casing with a nickel plated brass chuck. Easy-to-read dial calibrated 10-60 PSI in 1 lb. increments. Automatic reset. Pressure release valve. Use for passenger cars, vans and light trucks. Carded. 10/master.

Economy Dial Tire Gauge (1-50 lbs.)

17-553 Low cost dial tire gauge calibrated in both PSI and kPa in 1 lb. increments.

Dial Truck Tire Gauge (10-160 lbs.)

17-555 Easy-to-read dial gauge complete with a rugged protective rubber casing. Pressure holding gauge has an automatic reset/release valve. Includes a 12" flexible hose and chrome plated zinc dual foot chuck. Calibrated 10-160 PSI in 5 lb. increments. Carded. 5/master.

WARNING: To avoid serious eye injury, eye protection must be worn when using these tools.



Air Chucks, Inflator Gauges & Components

Deluxe Inflator Gauges

Rugged zinc casting, with rubber bumper guard to protect against damage if dropped, and easy to read recessed sight glass. Replaceable valve assembly and gauging cartridge. Calibrated 10-120 PSI in 2 lb. steps.

17-850 With 12" Hose and Dual Foot Chuck. Carded. 10/master.

17-850-07 Bulk. 30/box.

17-851 With 12" Hose and Straight-On Chuck. Carded. 10/master.

17-853 With 24" Hose and "Grip-Tite" Chuck. 1/box.

17-855 With 24" Hose and "Clip-On" Chuck. 1/box.

17-856 With 12" Hose and Single Foot Chuck. 1/box.

Deluxe Straight-On Inflator Gauges *With Bleeder Valve*

Same high quality inflator gauge but with a convenient bleeder valve to enable the operator to "zero" the gauge and release pressure during filling. The 17-870 with bleeder and locking chuck allows the operator to stand away from the tire being inflated and thus meets OSHA regulation No. 1910.177 on inflation. **Because of the internal construction of the Straight-On Dual Foot Chucks, they can only be installed on Tru-Flate® inflator gauges with bleeder valves.**

17-860 With 36" Hose and Straight-On Dual Foot Chuck. 1/box.

17-870 With 72" Hose and Locking Straight-On Dual Foot Chuck. Has deep threaded well to lock onto valve when tilted. 1/box.

17-875 With 144" Hose and Locking Straight-On Dual Foot Chuck. 1/box.

Bayonet Style Inflator Gauges

Features 12" hose and chrome plated castings with brass internal parts for long life. Solid brass bar is calibrated 10-90 PSI in 2 PSI increments.

17-865 Straight-On Tapered Chuck. Carded. 5/master.

17-862 Straight-On Tapered Chuck. 1/box.

17-863 Swivel Dual Foot Chuck. 1/box.

Air Chucks without Shut-off *For Inflator Gauges Only*

Do not use on direct air lines where a shut-off valve is required in the chuck head.

17-355 Snap-On Chuck Clip. Converts any single foot chuck to a clip-on chuck. Carded. 10/master

17-355-07 Bulk. 500/box.

17-365 Mini Lock-On Air Chuck. Newer "Mini-style" is standard equipment on Rim Clamp (RC) tire changers. Carded. 10/box.

17-722 Single Foot Chuck. 1/4" FNPT. 10/box.

17-724 Dual Foot Chuck. 1/4" FNPT. 10/box.

17-726 "Grip Tite" Chuck. 1/4" FNPT. Straight-on air line chuck. Snaps onto standard tire valve and stays put until disconnected. 1/bag.

17-729 Straight-On Chuck. 1/4" FNPT, with universal adapter. Carded. 10/master.

17-730 Clip-On Chuck. 1/4" Female NPT, with universal adapter. 10/box.

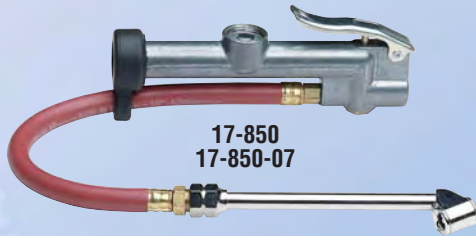

17-850
17-850-07



17-851



17-853

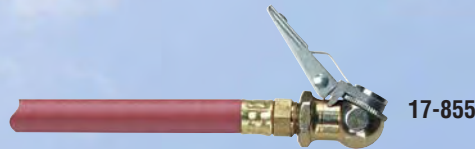

17-855



17-856

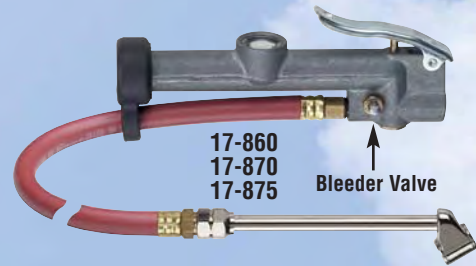

17-860
17-870
17-875

Bleeder Valve

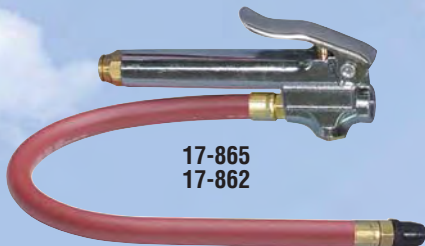

17-865
17-862



17-722



17-863



17-355
17-355-07



17-365



17-726



17-729



17-730



17-724

Air Chucks, Inflator Gauges & Components

Inflator Gauge Components

Hose Assemblies with Chucks include two adapters to convert 3/8-24 thread hose to 1/4-18 NPT and 1/8-27 NPT.

17-708 12" Hose with Straight-On Chuck, no adapters. 1/box.

17-712 12" Hose with Dual Foot Chuck and Adapters. 1/box.

Hose Assembly without Chuck includes two adapters to convert 3/8-24 thread hose to 1/4-18 NPT and 1/8-27 NPT.

17-720 Universal 12" Hose with two adapters. 1/box.

Direct Air Line Chucks with Shut-off

Direct Air Line Chucks have a built-in shut-off valve and therefore cannot be used on inflator gauges. Use when air supply lines come directly from the compressor with no other valve in the line. (For Inflator Gauge Chucks, see page 12). 1/4" Female NPT. 150 PSI maximum air line pressure.

Ball Foot Chucks (for direct air lines only)

17-351 1/4" Female NPT. Carded. 10/master.

17-350 Bulk. 10/box.

17-353 Combination 17-350 Chuck with 17-355 Chuck Clip. Carded. 10/box.

17-361 Combination 17-350 Chuck with 1/4" ID Hose Barb. Carded. 10/box.

17-369 1/4" Male NPT. Carded. 10/master.

17-355 Snap-On Chuck Clip. Converts any single foot chuck to a clip-on chuck. Carded. 10/box.

17-355-07 Bulk. 500/box.

17-373 Grip-Tite Chuck. 1/4" Female NPT. Works like a "quick coupler." Snaps onto any standard tire valve and stays put until released. Carded. 10/box.

17-375 Straight-On Chuck. 1/4" Female NPT. Smaller design for use on those hard to reach tire valves. Carded. 10/box.

17-383 Dual Foot Chuck. 1/4" Female NPT. Standard dual foot extension for valves on tractors, trucks or buses. Carded. 10/box.

17-382 Bulk. 10/box.

17-385 Straight-On Dual Foot Chuck. For hard-to-reach inner duals. New design makes for easy inflation. Carded. 10/box.

17-384 Bulk. 10/box.

17-395 Locking Straight-On Dual Foot Chuck. Comes with threaded deep well lock nut which locks on valve when tilted. Carded. 10/box.

17-396 Bulk. 10/box.

17-398 Same as 17-395, but 12" long. 5/box.

17-392 Large Bore Clip-On Air Chuck. Snaps on the large bore valve when sleeve is moved forward and releases when sleeve is pulled back. 1/4" NPT. 1/bag.

17-394 Large Bore Chuck. Easily grips bore valve when cocked on threads. 1/box.

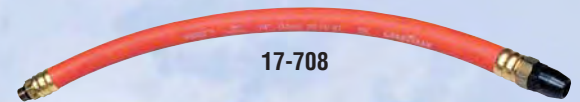

17-350
17-351



17-353



17-369



17-361



17-355
17-355-07



17-373



17-382
17-383

17-384
17-385
17-395
17-396
17-398



17-375



17-392



17-394

Air Line Chuck Service Parts / Standard Blowguns

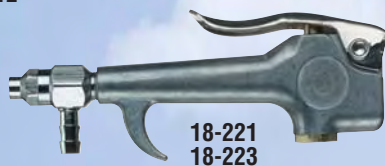
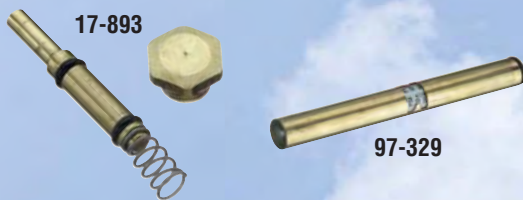
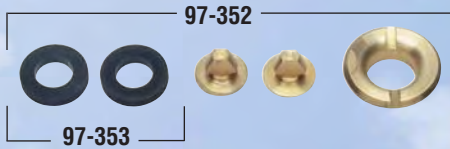

Air Line Chuck Service Parts

For Direct Air Line Chucks Only

97-350 Repair Kit for Single Ball Foot Chucks. 1/bag.

97-351 Washer only, for Single Foot Chucks. 10/bag.

97-352 Repair Kit for 17-383 Dual Foot Chucks. 1/bag.

97-353 Washer only, for 17-383 Chuck. 10/bag.

For Inflator Gauges and Chucks

17-707 Inflator Gauge. Body with cartridge and control valve. 1/box.

17-707-07 Bulk. 30/box.

17-893 Valve Assembly. 1/bag.

97-331 Replacement sight glass (not shown). 5/bag.

97-329 Standard Gauging Cartridge. Calibrated 10-120 PSI. 1/bag.

97-312 Repair Kit for 17-724 Chuck (not shown). 1/bag.

97-351 Washer only, for 17-722 Chuck. 10/bag.

97-353 Washer only, for 17-724 Chuck. 10/bag.

Standard Blowguns

All have 1/4" Female NPT inlet. Allows full line pressure to be used.

IMPORTANT: To comply with OSHA regulations, Standard Blowguns must be used on a regulated air line with a pressure setting not to exceed 30 PSI.

Lever Type

Comfortable thumb lever valve control with hang-up hook. New, compact one piece nozzle.

18-203 Carded. 5/master.

18-202 Bulk. 1/box.

18-202-07 Bulk. 125/box.

Standard Blowgun with Rubber Tip

Oil resistant, soft replaceable rubber tip. Will not mar delicate surfaces.

Gives a leakproof seal against oil passages, fuel lines, etc., when air pressure is needed for cleaning.

18-207 Carded. 5/master.

99-005 Replacement Tip for 18-207 Blowgun. 1/bag.

Flex-Tipped Blowgun

18-212 No handles, levers or buttons. Simply flex rubber nozzle to open.

Release, and air shuts off automatically. 10/box.

Siphon Spray Blowgun

Combination of a Standard Blowgun and the Siphon Spray Nozzle.

Barbed siphon inlet fits 1/4" ID hose or tubing. Use for spray-cleaning engines, applying protective coatings, etc.

18-221 Carded. 5/master.

18-223 With 8' hose. Carded. 5/master.

Pistol-Grip Spray Cleaner

Air-operated siphon cleaning gun handles most cleaning fluids. Ideal for mixing water or soap solutions for pressure cleaning of parts, engines, machinery, floors and walls. Lightweight, easy to handle. Dual air inlet makes for a handy connection from overhead or underbench floor air use. 1/4" Female NPT threads. Must be used on regulated air line with a pressure setting not to exceed 30 PSI. Includes 8' of clear vinyl tubing with a weighted strainer screen and fluid control valve. 10" length spray nozzle.

18-225 Carded. 5/master.

Standard & Safety Blowguns

Standard Blowguns *(cont'd)*

Deluxe Blowgun Kit

Complete, all purpose blowgun with four interchangeable nozzles for cleaning and inflating. Perfect for blowing sawdust and grass clippings, drying surfaces or inflating balls, rafts and air mattresses. Complete with Standard Nozzle, Rubber Tip Nozzle, Tapered Inflator Nozzle and Ball Inflator Needle. All nozzles packed for storage in a convenient see-thru plastic case.

18-241 Carded. 5/master.

18-241-07 Gun only. No tips. Bulk. 100/box.

Palm Style Blow Gun Kit

18-247 Lightweight ergonomic design blow gun fits comfortably in the palm of your hand. Kit includes 6 interchangeable nozzles, 1/4" air plug and a 12" hose and air chuck assembly. Clamshelled. 5/master.

Pistol-Grip Blowgun

18-325 Lightweight plastic pistol grip blowgun with ergonomic design reduces user fatigue. Brass valving and bushing ensure long life. Carded. 5/master.

Safety Blowguns

New improved nozzle gives greatly increased performance and yet still meets OSHA regulation 100-1 for 30 PSI "dead head" pressure. Features vented nozzle to relieve the compressed air should the nozzle become plugged or accidentally obstructed. Heavy duty die cast body. Complete with hang-up hook and 1/4" NPT female inlet.

Button Type

18-231 Inlet Pressure 150 PSI. Carded. 5/master.

Lever Type

18-232 Inlet Pressure 150 PSI. 1/box.

18-233 Inlet Pressure 150 PSI. Carded. 5/master.

18-237 Tamper proof. Safety nozzle cannot be removed from end of blow gun. Carded. 5/master.

97-412 Replacement Safety Tip for 18-230 series blow guns. 20/box.

Pocket Size Lever Type

18-319 Inlet Pressure 150 PSI. Carded. 5/master.

Pocket Size with Vented Extensions

18-302 Inlet Pressure 150 PSI. With 4" extension. Carded. 10/master.

Clip-On Safety Blowgun

Chuck style. Converts standard ball foot air chuck into a blowgun. Convenient and easy to use.

18-143 8-1/2" Clip-On. 10/box.

High Volume "Venturi" Action

Delivers more air to speed cleaning and drying while using less compressed air. Special venturi nozzle increases air flow to part, yet meets OSHA regulation 100-1. Convenient hang hole, comfortable lever and 1/4" NPT female inlet. 150 PSI inlet pressure.

18-208 1/box.



Blowguns & Accessories / Water Valves

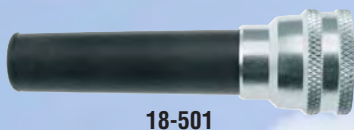
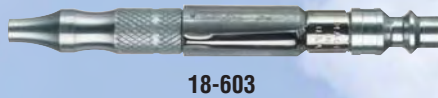
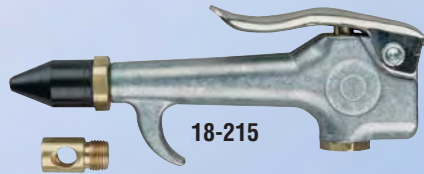

Safety Blowguns (cont'd)

Safety Blowgun with Rubber & Safety Nozzle

Oil resistant, soft rubber tip seals tight and won't mar finishes. Ideal for cleaning fuel lines, air passages and carburetors. With safety nozzle connected, limits air pressure to 30 PSI, meeting OSHA safety standards. Convenient hang hole, comfortable lever and 1/4" NPT female inlet. 150 PSI inlet pressure.

18-215 Carded. 5/master.

Blowgun Accessories

Siphon Spray Nozzle

For use on the 18-221 Blowgun. A spray nozzle and siphon head for spraying a combination of fluids and air. Fits any blowgun with 1/8" male pipe thread. Barbed fitting for use with 1/4" ID hose.

18-405 Carded. 10/master.

Adjustable Safety Pocket Blowguns

The handiest personal blowguns on the market today. A must for home, shop or garage use. They're quick and easy to use. Just twist knurled nozzle. Adjust from a whisper of air to a full volume flow. Nozzle meets OSHA regulation 100-1. Knurled nozzle makes handling easy. Complete with handy pocket clip. Attach to air line coupler.

Tru-Flate® Design Adjustable Blowgun

18-601 Fits all Tru-Flate Design 1/4" coupler bodies. Carded. 10/master.

Industrial/Milton Design Adjustable Blowgun

18-603 Fits all Industrial/Milton Design 1/4" coupler bodies. Carded. 10/master.

Aro Design Adjustable Blowgun

18-605 Fits all Aro Design 1/4" coupler bodies. Carded. 10/master.

Water Nozzle

Corrosion resistant valve. Alkali, heat, oil and weather resistant. Valve opens by flexing the spout. Positive shut-off when released. 3/4" -11 Pitch Female Garden Bibb thread.

18-501 Carded. 5/master.

Radiator Fillers

Cast zinc, alkali-resisting body, with oil and weather resistant rubber spout for long service life. Thumb lever water valve delivers maximum water flow without annoying pressure splash or after-drip.

18-504 3/4" Female Garden Bibb. 1/box.

18-506 1/4" Female NPT. 1/box.

WARNING: To avoid serious eye injury, eye protection must be worn when using these tools.

Hose Fittings, Pipe Couplings & Adapters

Barb Type Hose Fittings

All brass construction resists rust and will not corrode as easily as other materials. Precision machined to high quality standards. Use with hose clamp or ferrules.

Male Hose End

- 21-122 1/4" Hose ID x 1/4" Male NPT. 10/box.
- 21-123 1/4" Hose ID x 1/4" Male NPT. Carded 10/master.
- 21-132 5/16" Hose ID x 1/4" Male NPT. 10/box.
- 21-133 5/16" Hose ID x 1/4" Male NPT. Carded. 10/master.
- 21-142 3/8" Hose ID x 1/4" Male NPT. 10/box.
- 21-143 3/8" Hose ID x 1/4" Male NPT. Carded. 10/master.
- 21-147 3/8" Hose ID x 3/8" Male NPT. Carded. 10/master.

Female Hose End

- 21-222 1/4" Hose ID x 1/4" Female NPT. 10/box.
- 21-242 3/8" Hose ID x 1/4" Female NPT. 10/box.
- 21-262 3/8" Hose ID x 3/8" Female NPT. 10/box.

Female Swivel Hose End

- 21-322 1/4" Hose ID x 1/4" Female NPS. 10/box.
- 21-323 1/4" Hose ID x 1/4" Female NPS. Carded. 10/master.

Hose Splicer

- 21-422 1/4" Hose ID. 10/box.
- 21-423 1/4" Hose ID. Carded. 10/master.
- 21-432 5/16" Hose ID. 10/box.
- 21-433 5/16" Hose ID. Carded. 10/master.
- 21-466 3/8" Hose ID. 10/box.
- 21-467 3/8" Hose ID. Carded. 10/master.
- 21-488 1/2" Hose ID. 10/box.

Pipe Couplings and Adapters

All brass, corrosion resistant material. This complete line of pipe couplings, thread adapters and bushings allows user to adjust thread sizes from 1/8" NPT through 1/2" NPT with either male or female ends.

Male Coupling

- 21-505 1/4" Male NPT x 1/4" Male NPT. Carded. 5/master.

Female Coupling

- 21-515 1/4" Female NPT x 1/4" Female NPT. Carded. 5/master.

Male Reducer

- 21-524 1/4" Male NPT x 3/8" Male NPT. 10/box.

Female Bushings

- 21-535 1/4" Female NPT x 3/8" Male NPT. Carded. 5/master.
- 21-536 3/8" Female NPT x 1/2" Male NPT. 10/box.

Reducer Adapter

- 21-544 3/8" Female NPT x 1/4" Male NPT. 10/box.

Ball-End Adapter

- 21-595 1/4" Male NPT x 1/4" Male NPS with Ball Socket. Carded. 5/master.
- 21-597 1/4" Male NPT with Ball Socket x 1/4" Male NPS with Ball Socket. Carded. 10/master.

Drain Cocks

- 21-555 1/8" Drain Cock. Carded. 10/master.
- 21-557 1/4" Drain Cock. Carded. 10/master.

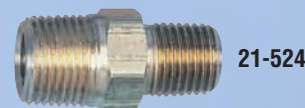
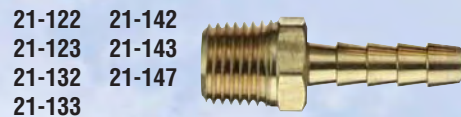

Hose Fittings



21-601



21-603



21-605



21-607



21-651

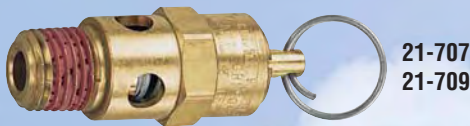

21-707
21-709



22-123 22-162
22-133 22-163
22-172



22-433

Air Line Swivel Fittings

Eliminates kinked and twisted air line hose by swiveling a full 360°. Use on air lines, tools, and compressor connections to increase flexibility and convenience. Barb type and male/female connections. 150 PSI maximum working pressure.

21-601 1/4" NPT male fitting x 1/4" ID hose barb. Full 360° swivel. Connect to hose with a clamp or crimped on ferrule. Carded. 10/master.

21-603 1/4" NPT male fitting x 3/8" ID hose barb. Full 360° swivel. Connect with hose clamp or crimped on ferrule. Carded. 10/master.

21-605 1/4" NPT male fitting x 1/4" NPT female fitting. Full 360° swivel. Perfect for the compressor to air line connection. Carded. 10/master.

21-607 1/4" NPT male fitting x 1/4" female fitting. Full 360° swivel. Carded. 10/master.

Garden Hose Coupler / Plug Sets

Constructed of heavy duty, corrosion resistant brass and stainless steel. Durable 3-ball locking mechanism and nitrile seals for secure, leak-free connection. Use on a variety of equipment for quick and easy connections without threading. Use anywhere water hoses are connected and disconnected frequently.

21-651 3/4" Garden Hose Coupler/Plug Set. Carded. 10/master.

Safety Valves

Constructed to ASME standards. Interchangeable with all other ASME valves of the same size and pressure.

21-707 1/4" Safety Valve 125 PSI. Carded. 5/master.

21-709 1/4" Safety Valve 150 PSI. Carded. 5/master.

Reusable Hose Fittings

Eliminates the need for hose clamps or ferrules. Heavy duty construction. Designed for fast, easy, yet permanent air-tight connections. All male and female ends have 1/4" NPT. See price sheet for packaging.

Male Hose End

PART NO.	THREAD SIZE	HOSE ID	HOSE OD	PACKAGED
22-123	1/4" NPT	1/4"	19/32"	Carded
22-133	1/4" NPT	1/4"	5/8"	Carded
22-162	1/4" NPT	3/8"	11/16"	Bulk
22-163	1/4" NPT	3/8"	11/16"	Carded
22-172	1/4" NPT	3/8"	3/4"	Bulk

Hose Splicer

PART NO.	THREAD SIZE	HOSE ID	HOSE OD	PACKAGED
22-433	1/4" NPT	1/4"	5/8"	Carded

Leader Hose

Essential to absorb the intermittent shock loads produced by air powered tools to the air hose coupler. Shock loads transmitted directly to the coupler and plug damage the locking balls of the coupler. Use Tru-Flate's® Leader Hose to eliminate premature failure of the coupler. Maximum working pressure 200 PSI. All packaged 1/box.

PART NO.	LENGTH	THREAD	HOSE OD
23-105	18"	1/4"	1/2"
23-106	36"	1/4"	1/2"

Leader Hose with Swivel Fittings

Leader hose is essential to absorb the intermittent shock loads to the air coupler produced by air-powered tools. Use Tru-Flate leader hoses to eliminate premature failure of the air line coupler. Extremely flexible hose with an abrasion resistant cover and swivel fittings makes these leader hoses easy to work with and convenient to use. Full 360° swivel. 150 PSI maximum working pressure. Male swivel fitting on one end, female standard fitting on the other end.

1/4" Leader Hose with Swivel

24" length 1/4" ID hose has 1/4" NPT male swivel fitting on one end and 1/4" NPT female fitting on the other end.

23-115 Carded. 5/master.

3/8" Leader Hose with Swivel

30" length 3/8" ID hose has 1/4" NPT male swivel fitting on one end and 1/4" NPT female fitting on the other end.

23-155 1/box.

Fast-Stor Nylon Self-Retracting Air Hose

Manufactured of tough, abrasive resistant nylon. Bright yellow color for safety. Use with all air-powered equipment in garages, plants, service stations, etc. Compact for storage, yet opens more than 25 times in use. Available in two lengths with spring guards and swivel fittings.

1/4" ID Hose

PART NO.	DESCRIPTION	PART NO.	DESCRIPTION
23-403	25' Hose w/Fitting	23-413	25' Hose w/Fitting
23-404	50' Hose w/Fitting	23-414	50' Hose w/Fitting

3/8" ID Hose

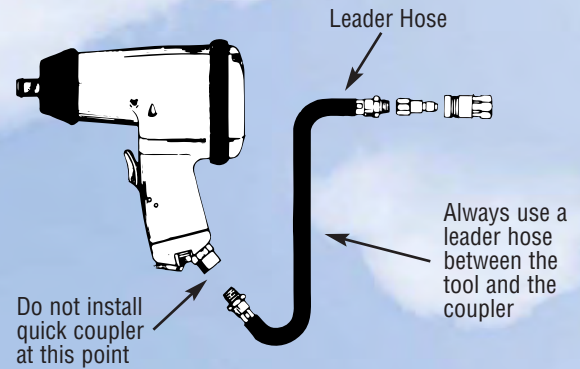
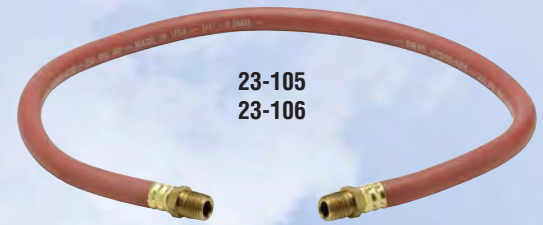

- Easy to Install
- Compact Space Saver
- Safer, More Efficient
- Abrasive Resistant
- Working Pressures up to 200 PSI

23-403
23-404
23-413
23-414

Air Line Hook-Up Hints

Proper usage of compressed air power calls for filters to clean the air, regulators to control pressure, gauges to show pressure and lubricators to protect power tools. Air line systems also need hose and tubing to provide flexibility at the points of use. Couplers, plugs and fittings are the components that complete the systems for quick, easy, secure fastening to paint spray guns, blowguns, inflator gauges, chucks, power tools and pneumatic tire repair stands. Tru-Flate® components offer reliable, low-cost, readily available, proven ways to hook up your air line system.



LEADER HOSE

A short length of leader hose is recommended on a paint spray gun to keep the coupler and plug from scratching a painted surface.

SAFETY BLOWGUNS

To comply with OSHA requirements, blowguns used on UN-REGULATED air lines must be capable of restricting nozzle pressure to 30 PSI or less.



DIRECT AIR LINE CHUCKS



AIR HOSE

INFLATOR GAUGES

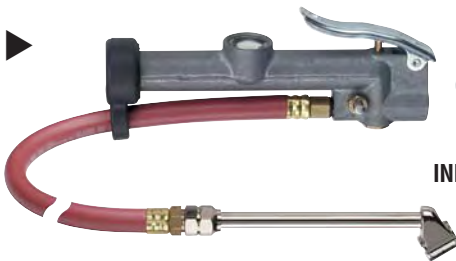

INLINE TOOL FILTER

TIRE HARDWARE

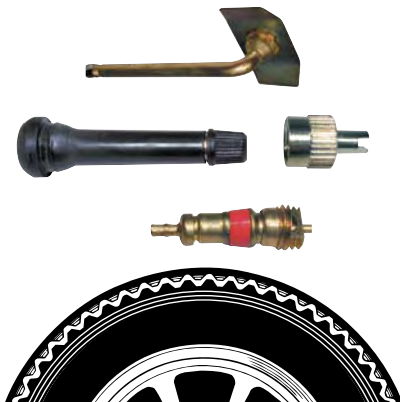

DESICCANT AIR DRYERS

Delivers extremely clean, dry air to pneumatic system components. The use of desiccants will optimize the quality of compressed air to improve performance of air tools and ensure oil-free, dry air to auto paint spray equipment.



AIR LINE FILTERS

ALWAYS LOCATE YOUR FILTER AS FAR FROM THE COMPRESSOR AS POSSIBLE IN ORDER TO TRAP AS MUCH CONDENSATION AS POSSIBLE.

Tru-Flate two stage filters remove liquids, oil, water and large dust particles by centrifugal force; small dust particles down to 40 microns by a porous element filter. Air line filters are vital to protect expensive air-powered tools to keep them operating longer with greater efficiency.



PRESSURE GAUGES

TANK VALVES

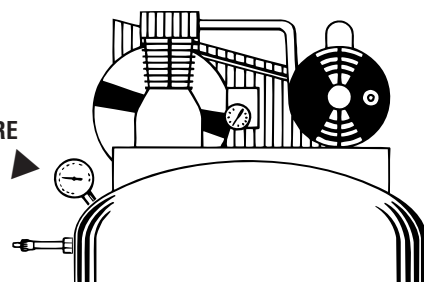

Air Line Hook-Up Hints

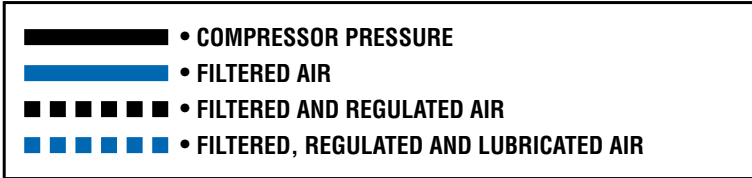

PRESSURE REGULATORS

Pressure regulators reduce line pressure to a usable range, a lower pressure than the compressor is set to deliver. Regulators maintain a steady flow of air regardless of the fluctuations that may take place in line pressure.

Pressure regulators should be used on air lines which feed impact wrenches in order to control tightening torque AND ON ALL AIR LINES THAT FEED STANDARD BLOWGUNS TO COMPLY WITH OSHA REGULATIONS. Regulators must be set at 30 PSI or less.

AIR LINE LUBRICATORS

MODERN AIR POWERED TOOLS NEED LUBRICATION!

Lubricators protect expensive power tools. Ultrasonic generator delivers oil in a fine mist form. Lubricators are simple to adjust. Loading bowl can be filled from either side.

ALWAYS LOCATE LUBRICATOR AS CLOSE TO THE TOOL AS POSSIBLE.

NEVER LOCATE A LUBRICATOR BETWEEN COMPRESSOR AND FILTER REGULATOR, OR ON AN AIR SUPPLY LINE TO PAINT A GUN.

RECOMMENDED AIR-POWERED TOOL HOOK-UP

Air-powered tools such as impact wrenches and panel cutters generate intermittent shock loads to make them work. If a coupler and plug are installed directly to the tool this can cause **PREMATURE FAILURE** of the coupler.

ALWAYS USE A SHORT LENGTH OF LEADER HOSE BETWEEN THE TOOL AND THE COUPLER AND PLUG TO ABSORB AS MUCH OF THE SHOCK AS POSSIBLE.

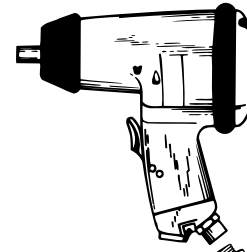

LEADER HOSE

FOR ANY APPLICATION USE SLEEVE-TYPE COUPLER

FOR WALL MOUNT ONLY USE PUSH-TYPE COUPLER

COUPLERS AND PLUGS

BARB-TYPE HOSE FITTINGS

HOSE FITTINGS

AIR-POWERED TIRE BUFFER

AIR LINE FILTERS



COMBINATION FILTER/REGULATORS

This unit is equipped with an automatic drain; the unit provides the user with a clean, moisture-free air supply, and saves money too!

The large filter surface area minimizes pressure drop, and is RE-CLEANABLE. The regulator portion of the unit is extremely stable in low-flow applications, and balanced valve design prevents secondary pressure changes with fluctuating primary pressures.

This unit should always be located as far away from the compressor as possible.



BRASS THREAD ADAPTERS



FAST STOR HOSE

Self-retracting nylon air hose is ideal for hook-up to portable air powered tools. By recoiling, it keeps "out from underfoot" by itself.



STANDARD BLOWGUNS

Must be used on PRESSURE REGULATED lines in order to comply with OSHA requirements. Set regulator at 30 PSI OR LESS!

Air Line Filters & Regulators



Filter/Regulator Combinations (Piggyback)

The features of accurate pressure regulation with maximum water and dirt separation are provided in a single, compact unit. The filter significantly increases the life of expensive equipment, such as air tools, air valves, air cylinders and air motors. The regulator employs a solid piston. Unlike diaphragms, the solid piston resists rupture, cracking or tearing under pressure or high cycle rates. Tru-Flate® Regulators have fast flow capabilities. Maximum operating pressures are: 150 PSI at 125° F primary, 2 to 125 PSI secondary with polycarbonate bowls; and 250 PSI at 175° F primary, 5 to 250 PSI secondary with metal bowls. Operating temperatures range from -10° F to +175° F. Combination Filter/Regulators have two gauge ports and come complete with filter element and pressure gauge.

PART NO.	SERIES	PORT SIZE	GAUGE INCLUDED	SCFM† TYPE	DRAIN TYPE	ELEMENT MICRONS	BOWL CAPACITY	BOWL TYPE	ADJUSTMENT TYPE	OVERALL HEIGHT (INCHES)
• 24-243	Mini	1/4" NPTF	Y	13	Manual	5	1 oz.	Polycarbonate	Locking Knob	5.7
24-244	Mini	1/4" NPTF	Y	13	Automatic Pulse	5	1 oz.	Polycarbonate	Locking Knob	6.1
24-201	Compact	1/4" NPTF	Y	55	Manual	40	5 oz.	Polycarbonate	Locking Knob	10.4
24-202	Compact	1/4" NPTF	Y	55	Automatic Float	40	5 oz.	Polycarbonate	Locking Knob	10.4
24-211	Compact	3/8" NPTF	Y	65	Manual	40	5 oz.	Polycarbonate	Locking Knob	10.4
24-212	Compact	3/8" NPTF	Y	65	Automatic Float	40	5 oz.	Polycarbonate	Locking Knob	10.4
24-221	Standard	1/2" NPTF	Y	105	Manual	40	8 oz.	Polycarbonate	Locking Knob	12.1
24-222	Standard	1/2" NPTF	Y	105	Automatic Float	40	8 oz.	Polycarbonate	Locking Knob	12.1
24-231	Standard	3/4" NPTF	Y	110	Manual	40	8 oz.	Polycarbonate	Locking Knob	12.1
24-232	Standard	3/4" NPTF	Y	110	Automatic Float	40	8 oz.	Polycarbonate	Locking Knob	12.1

†Standard cubic feet per minute with 100 PSI inlet pressure, 80 PSI no flow secondary setting and 10 PSI pressure drop.



Air Line Filters

Tru-Flate Air Line Filters are used for all air line applications where efficient filtration is required. Filtration removes airborne solid contaminants, pipe scale, rust, condensate, etc., which may cause wear or failure of pneumatic components. Large filter element surface gives low pressure drop and long element life. The Mini Series of air line filters offers a higher degree of filtration. All filters are complete with filter element and either manual or automatic drains. Maximum operating pressure is 150 PSI at 125° F with polycarbonate bowl and 250 PSI at 175° F with metal bowl. Operating temperatures range from -10° F to +175° F.

PART NO.	SERIES	PORT SIZE	SCFM† TYPE	DRAIN TYPE	ELEMENT (MICRONS)	BOWL CAPACITY	BOWL TYPE	OVERALL HEIGHT (INCHES)
• 24-343	Mini	1/4" NPTF	20	Manual	5	1 oz.	Polycarbonate	3.7
• 24-301	Compact	1/4" NPTF	50	Manual	40	5 oz.	Polycarbonate	6.1
24-302	Compact	1/4" NPTF	50	Automatic Float	40	5 oz.	Polycarbonate	6.4
• 24-304	Compact	1/4" NPTF	50	Automatic Float	40	5 oz.	Metal	6.4
• 24-311	Compact	3/8" NPTF	75	Manual	40	5 oz.	Polycarbonate	6.1
24-312	Compact	3/8" NPTF	75	Automatic Float	40	5 oz.	Polycarbonate	6.4
24-321	Standard	1/2" NPTF	110	Manual	40	8 oz.	Polycarbonate	7.7
24-322	Standard	1/2" NPTF	110	Automatic Float	40	8 oz.	Polycarbonate	7.7
24-331	Standard	3/4" NPTF	125	Manual	40	8 oz.	Polycarbonate	7.7
24-332	Standard	3/4" NPTF	125	Automatic Float	40	8 oz.	Polycarbonate	7.7
24-351	Hi-Flow	1" NPTF	300	Manual	40	18 oz.	Metal	10.95
24-352	Hi-Flow	1" NPTF	300	Automatic Float	40	18 oz.	Metal	10.95

†Standard cubic feet per minute with 100 PSI inlet pressure with 5 PSI pressure drop.

Air Line Regulators & Lubricators

Air Line Regulators

Tru-Flate® Air Line Regulators employ a solid piston and balanced poppet for excellent performance and longer life. The solid piston design is reliable for a broad range of demanding applications and is impervious to a wide range of lubricating oils and greases. Unlike diaphragms, the solid piston resists rupture, cracking or tearing under pressure, constant flexing or high cycle rates. It is impervious to most chemicals, provides accurate control, and assures smooth, uninterrupted operation. Tru-Flate Air Line Regulators have fast reverse flow capabilities. This allows for installation where dual pressures are required. Two gauge ports and a pressure gauge are provided. Maximum operating pressures are 250 PSI primary and 2 to 125 PSI secondary.



Mini



Compact



Standard

PART NO.	SERIES	PORT SIZE	GAUGE INCLUDED	SCFM†	ADJUSTMENT TYPE	OVERALL HEIGHT (INCHES)
• 24-444	Mini	1/4" NPTF	Y	13	Non-Rising, Locking Knob	2.9
• 24-404	Compact	1/4" NPTF	Y	55	Non-Rising, Locking Knob	6.4
• 24-414	Compact	3/8" NPTF	Y	70	Non-Rising, Locking Knob	6.4
24-424	Standard	1/2" NPTF	Y	110	Non-Rising, Locking Knob	7.3
24-434	Standard	3/4" NPTF	Y	130	Non-Rising, Locking Knob	7.3
24-454	Hi-Flow	1" NPTF	Y	300	Non-Rising, Locking Knob	8.46

†Standard cubic feet per minute with 100 PSI inlet pressure, 80 PSI no flow secondary pressure and 10 PSI pressure drop.



Hi-Flow

Air Line Lubricators

Tru-Flate Air Line Lubricators are designed to provide proportional delivery of lubricating oil over a wide range of air flows. Ideal for most general applications. Externally adjustable with transparent sight dome for 360° visibility. Lubricator should be mounted as close as possible to application to ensure most effective distribution of oil to pneumatic components. Suggested lubricant: Petroleum-based oil of 100 to 200 SSU viscosity at 100° F and an aniline point greater than 200° F.

Except for the Mini Series, Tru-Flate Air Line Lubricators may be filled while the system is under pressure. Maximum operating pressure is: 150 PSI at 125° F with polycarbonate bowl. Operating temperature range is -10° F to +175° F. For pressures up to 250 PSI at 175° F (max), a metal replacement bowl must be ordered and installed separately. Metal bowls with sight glass are standard for the Hi-Flow Series.

WARNING: Oils with adhesives, compounded oils containing solvents, graphite, detergents or synthetic oils must not be used.



Mini



Compact



Standard

PART NO.	SERIES	PORT SIZE	RATED FLOW SCFM†	MIN. FLOW REQ. (SCFM†)	BOWL CAPACITY	BOWL TYPE	OVERALL HEIGHT (INCHES)
24-542	Mini	1/4" NPTF	11	0.8	1 oz.	Polycarbonate	5.2
24-501	Compact	1/4" NPTF	20	1	5 oz.	Polycarbonate	7.4
24-511	Compact	3/8" NPTF	35	1	5 oz.	Polycarbonate	7.4
24-521	Standard	1/2" NPTF	85	2	8 oz.	Polycarbonate	8.9
24-531	Standard	3/4" NPTF	90	2	8 oz.	Polycarbonate	8.9
24-551	Hi-Flow	1" NPTF	260	8	18 oz.	Metal	11.81

†Standard cubic feet per minute at 10 PSI with 5 PSI pressure drop.



Hi-Flow

Desiccants, Oil Removal Filters & Pressure Gauges



56-081



56-082



24-603



24-801
24-803
24-804
24-805



24-806
24-807
24-811

Desiccant Dryer

Our Desiccant dryer is engineered to deliver extremely dry compressed air to protect pneumatically operated equipment from the adverse effects of moisture. **Maximum working pressure is 300 PSI.** Maximum rated operating conditions – Metal bowl with sight glass: 250 PSIG (17.2 Bar); 120°F (48°C).

PART NO.	PORT SIZE	BOWL SIZE	FLOW RATE in SCFM†	FLUID
----------	-----------	-----------	--------------------	-------

56-081 1/2" 1 qt. 10 Compressed Air Only

56-082 Replacement Beads. 1 qt.

WARNING: These dryers are intended for use in compressed air systems only. Do not use where pressure or temperature may exceed maximum rated operating conditions. These units are not to be used on life support systems or breathing air systems. Failure to follow the recommendations contained in this warning may result in personal injury and/or property damage.

Coalescing Oil Removal Filter

Removes more than 99.9% of liquid aerosols – oil or water – from pneumatic systems. Removes submicron – 0.3 micron – contaminants. For all critical applications where oil-free air is required. Liquids gravitate to bottom of element and re-entry into pneumatic system is prevented. A Tru-Flate® Air Line Filter located upstream from the Oil Removal Filter to act as a pre-filter will increase the life of the coalescing element and is recommended. Maximum operating pressure is 150 PSI at 125° F.

PART NO.	PORT SERIES	SIZE	ELEMENT SCFM†	REPLACEMENT ELEMENT PART NO.	HEIGHT CAPACITY	OVERALL HEIGHT (INCHES)
----------	-------------	------	---------------	------------------------------	-----------------	-------------------------

24-603 Standard 1/2" NPTF 20 24-943 8 oz. 7.9

Air Line Pressure Gauges

PART NO.	THREAD SIZE	CALIBRATION RANGE	MOUNTING
----------	-------------	-------------------	----------

24-801 (Mini)	1/8" NPT	0-200 PSI 0-14 kg/cm ²	Back
24-803	1/4" NPT	0-160 PSI 0-11 kg/cm ²	Back
24-804	1/4" NPT	0-300 PSI 0-20 kg/cm ²	Back
24-805	1/8" NPT	0-60 PSI	Back
24-806	1/4" NPT	0-60 PSI 0-400 kPa	Bottom
24-807	1/4" NPT	0-160 PSI 0-1100 kPa	Bottom
24-811	1/4" NPT	0-300 PSI 0-20 kg/cm ²	Bottom

†Standard cubic feet per minute at 100 PSI with 5 PSI pressure drop.

F.R.L. Replacement Parts & Accessories

Replacement Parts and Accessories (individually boxed)

PRODUCT	MINI SERIES	COMPACT SERIES	STANDARD SERIES	HI-FLOW SERIES
Filter Element Kits Includes one element and all necessary O-ring seals.				
5 Micron	24-934	—	—	—
40 Micron	—	24-932	24-939	24-930
5 SCFM (rated)	—	24-940	—	—
10 SCFM (rated)	—	—	—	—
20 SCFM (rated)	—	—	24-943	—
Polycarbonate Bowls				
	—	24-901	24-902	—
Metal Bowls				
	—	24-903	24-910	—
Polyethylene Bowl Guard Kit For applications where polycarbonate bowls may be subjected to impact or rougher than normal usages.				
	—	24-911	24-912	—
Automatic Float Drain Kit				
	—	24-920	24-920	24-920
Air Pressure Gauges				
0-160 PSI with 0-11 kg/cm ²	—	24-803	24-803	24-803
0-200 PSI with 0-14 kg/cm ²	24-801	—	—	—
0-300 PSI with 0-20 kg/cm ²	—	24-804	24-804	24-804
0-300 PSI, Bottom Mount	—	24-811	24-811	24-811
Mounting Brackets Kits are designed to permit wall mounting of Compact, Standard and Hi-Flow Series Filters and Regulators.				
Lubricators & Filters	24-950	24-956	24-957	24-958
Regulators & Piggyback	24-950	24-954	24-955	24-958



Filter Element Kit



Polycarbonate Bowls



Metal Bowls



Mounting Brackets



Automatic Float Drains



Bowl Guards

In-Line Tool Oilers, Regulators & Filters



41-101

In-Line Tool Oiler

A compact oiler that fastens directly to the air tool. Precisely meters proper amount of oil to the tool only when the tool is in use. No adjustments necessary. 1/4" male NPT outlet, 1/4" female NPT inlet. Use on all air impact guns, air wrenches, body shop air tools and pneumatic hammers requiring 1/4" air lines. Note: Never use motor oil in pneumatic tool. **Prevents "burn-out" of expensive pneumatic tools, stops rust and increases torque up to 25%.**

41-101 Carded. 10/master.



41-125

Three-In-One Air Line Manifold

Supply three air tools from one source! Use on air hose end or as permanently fixed bench outlet. No need to disconnect/connect to use different tools. Three 1/4" NPT outlets and single 1/4" NPT inlet make this a useful shop or bench accessory.

41-125 Carded. 5/master.



41-135

In-Line Air Flow Regulator

Controls in-line air pressure for paint spray guns or other pneumatic tools. Helps keep air flow at exact operating pressures. Use where precise air flow is desired. Compact, light weight design with gauge, allows for easy "on the tool" air adjustment.

41-135 Carded. 5/master.



41-150



97-652

In-Line Tool Filter

A compact and extremely effective accessory for all air-operated shop tools and equipment, such as inflator gauges, impact wrenches, spray guns, air powered sanders, etc. Protects them against rust, pipe scale and dirt. 1/4" female NPT inlet, 1/4" male NPT outlet. Sintered bronze filter element. Maximum working pressure 500 PSI. **Reduces down time, prevents expensive repairs and prolongs the life of pneumatic tools.**

41-150 Carded. 10/box.

97-652 Replacement Filter Element. 1/bag.



41-175

Compressor Accessory Kit

41-175 Perfect for the do-it-yourselfer! 19 piece kit contains all accessories needed to connect and use a tank-mounted air compressor. Carded. 5/master.

Accessories include:

- Couplers/Plugs for air line hose and air tool connections
- Air line chuck for filling tire valves
- Tire gauge, to check air pressure
- Blowgun kit with multiple nozzles for general cleaning, drying, and clearing
- Ball and tapered inflator nozzles for inflating toys and recreational equipment

21-122



21-422



Hose Repair Kit

41-300 Contains all parts necessary to repair a direct air line hose assembly. Carded. 5/master.

Each kit contains:

- 1 - 17-350 Single Foot Air Chuck, 1/4" Female NPT
- 1 - 21-122 Male Hose End 1/4" ID hose x 1/4" NPT
- 1 - 21-422 Hose Splicer, 1/4" ID hose
- 3 - Band Style Hose Clamps, fits 3/8" ID hose

41-300



17-350



Driveway Signals / Camel® Tire Repair Products

Driveway Signal and Components

6" Driveway Signal Bell

Dependable, loud bell sounds each time a customer drives up for service. Self-contained unit for ease of installation. Operates on 110V AC outlet. Includes 6" bell, mounting plate, coil striker, control switch and 3' wire grounding cord.

41-850 1/box.

Components:

Hose Anchor and Plug

For 3/8" ID Signal Hose. Heavy cast iron anchor keeps hose in place.

41-861 1/box.

Hose "Y"

Allows two hoses to be used.

41-862 1/bag.

Driveway Hose (not shown)

50', 3/8" Driveway Hose.

41-864 1/box.

Indoor Control Switch

110 volt. All-purpose replacement unit for most makes of signals.

Includes mounting bracket and outside wiring.

41-866 1/box.

Outdoor Control Switch (not shown)

Weatherproof control switch enclosed by a protective electrical box. Includes mounting bracket. 110 volt.

41-868 1/box.

Cold Patches

Bicycle Tube Foil-Back Repair Kit

Handy kit contains foil backed patches, .25 oz. cement, buffer and directions.

11-004 Carded. 10/master.

Chembond® Tube and Bias Patches

These world famous patches are available in two shapes and six sizes. Pure rubber flows into the injury. May be applied with Universal Cement or an electric vulcanizer.

Tube Tire Repair Kit

14-130 Contains patches, .30 fl. oz. cement and buffer. Carded. 5/master.

14-131 Chembond Refill Kit. Contains 5 each of 14-152 and 14-153.

Carded. 5/master.

PART NO.	QUANTITY	TYPE	SIZE
14-152	40	Sm. Round	1-5/8"
14-153	30	Med. Round	2-1/4"
14-163	1000 (bulk)	Med. Round	2-1/4"
14-154	20	Lg. Round	3-1/8"
14-157	30	Sm. Oval	1-1/2" x 2-1/2"
14-158	20	Med. Oval	1-7/8" x 3-7/8"
14-159	20	Lg. Oval	2-5/8" x 5-3/4"



41-850



41-861

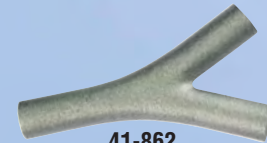

41-862

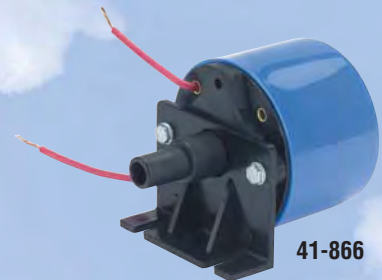

41-866

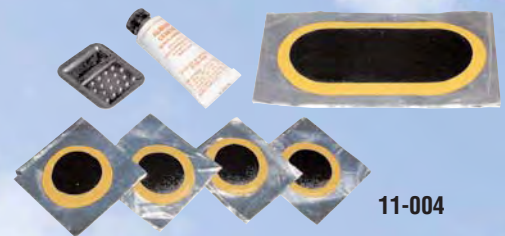

11-004



14-130

Camel® Tire Repair Products

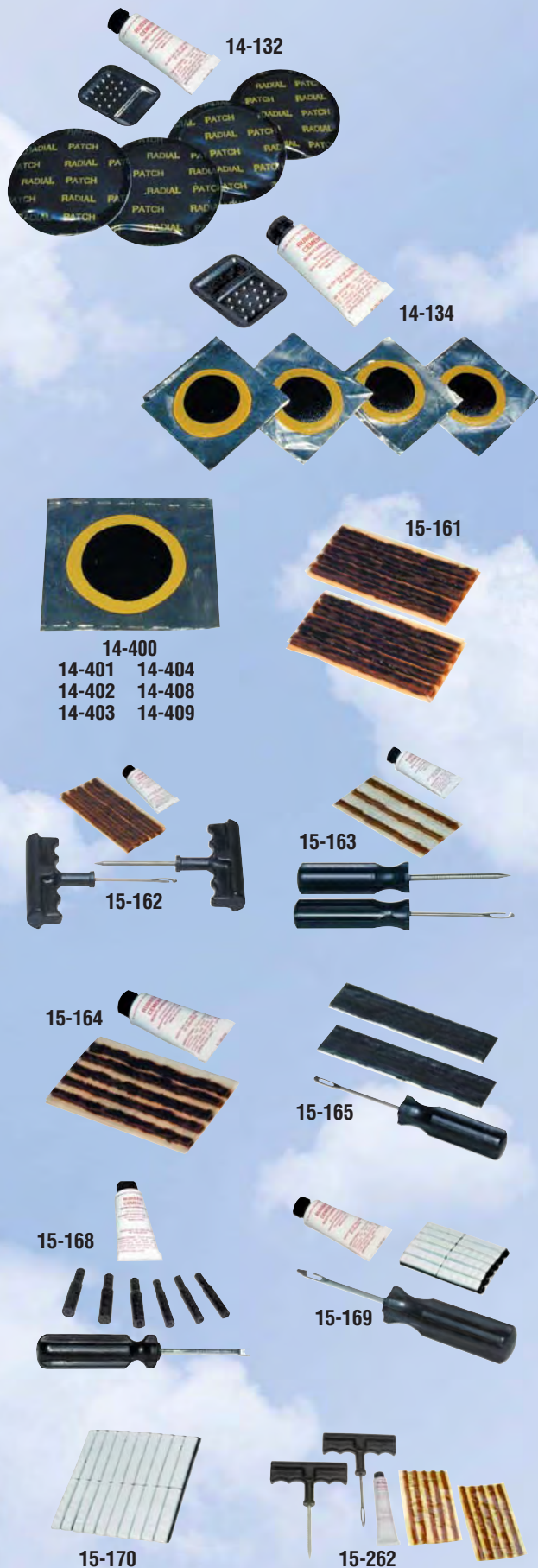

Radial Patches

Tire Repair Kit

14-132 For D-I-Y radial repairs. Contains patches, .30 fl. oz. cement and buffer. Carded. 5/master.

PART NO.	QUANTITY	TYPE	SIZE
14-137	30	Sm. Round	2-1/4"
14-139	20	Med. Round	3-1/4"
14-140	10	Lg. Round	4-1/8"

Foil-Back Repair Units

Foil-Back Repair Kit

14-134 Contains (4) 14-400 patches, (1) .30 fl. oz. cement and (1) thumb buffer. Carded. 5/master.

Used for repairing tubes and tires where fabric reinforcement is not required. Repair units feature a foil backing that keeps the repair fresh. Conveniently packed. For best results use with Camel-Cure® Cement.

PART NO.	QUANTITY	TYPE	SIZE
14-400	50	Round	1-1/4"
14-401	30	Round	1-1/2"
14-402	30	Round	1-3/4"
14-403	30	Round	2-1/8"
14-404	30	Round	3-1/8"
14-408	10	Oval	4" x 1-7/8"
14-409	10	Oval	6" x 2-7/8"

Tire Repair Kits

Super-Grip Emergency Tire Repair Kit

15-162 Contains our most popular Super-Grip probe, open-eye tool, .30 fl. oz. Universal Cement and 5 radial inserts. For all bias ply and non-speed rated radial tires. Carded. 5/master.

15-161 Refill Kit for 15-162. 10 strings. Carded. 5/master.

Emergency Repair Kit

15-163 Very popular. Contains 15-172 (open eye needle) and 15-174 (probe) screwdriver type tools. For all bias ply and non-speed rated radial tires. Carded. 5/master.

15-164 Refill Kit for 15-163. Contains 5 refill strips and .30 fl. oz. Universal Cement. Carded. 5/master.

Emergency Repair Radial Tire Kit

15-165 This handy kit easily fits in the glove box of any car. Contains 10 repair strings and a closed-eye needle. Not for speed rated radial tires. Carded. 5/master.

Tubeless Tire Repair Kit

15-166 Contains 6 assorted straight plugs, .30 fl. oz. Universal Cement and an open-eye needle. Not for use on radial tires. Carded. 5/master.

Perma-Strip Patch

15-169 Emergency repair kit for bias ply and non-steel belted radial tires. Six strips, cement and an open-eye needle included. Carded. 5/master.

15-170 Patch Refill Kit for the 15-169. Contains 12 strips, .30 fl. oz. Universal Cement. Carded. 10/master.

Emergency Off-Road Tire Repair Kit

15-262 Comes in handy tool pouch. Contains (10) 15-280 string repairs, (1) 15-224 Open-eye needle, (1) 15-225 Super grip rasp and (1) 12-965 .59 fl. oz. cement.

Camel® Tire Repair Products

Tire Repair Kits (cont'd)

Heavy-Duty Truck Tire Emergency Repair Kit

15-282 Contains everything needed for emergency repairs on the largest truck tires. Contains heavy-duty all steel split-eye T-handle tools with Sheffield steel shaft. 8" spiral cement tool, 2 oz. tube of Universal Cement and 15 heavy-duty inserts. All packed in a heavy reclosable vinyl pouch.

Perma-Strip Patch Kit

15-178 This kit is an excellent kit for off-road tires such as ATVs and farm tires. Contains 50 repair strips, 12-086 Universal Cement, one 15-172 open-eye needle and one 15-174 probe. 1/box.

Dealer Kit

15-189 Contains our most popular T-handle tools. 1/4 pint of Universal Cement and two boxes of 15-184 radial repairs. Box keeps tools organized, with reclosable lid. 1/box.

Inserts & String Repair

Perma Strip Patch

15-179 1/4" x 2. For bias ply and non-steel belted radial tire repairs. Box of 50.

4" Radial Inserts

15-184 For most auto and light truck radial tire emergency repairs. Box of 20.

7" String Repairs

15-206 For bias ply and tubeless tire emergency repairs. Box of 50.

7-1/2" Heavy-Duty String Type Repairs

15-207 For bias ply and radial tire nail hole emergency repairs. Box of 50.

4" Steel Belted Radial Inserts (not shown)

15-280 Our best selling inserts for radial tire emergency repair. Box of 60.

7" Steel Belted Radial Truck Insert

15-281 Heavy-Duty inserts are excellent for emergency repairs of nail holes in truck tires. Contains one sealed bag of 30 inserts.

Plug-N-Patch for Radial and Bias Ply Tires

For nail and screw hole injuries on autos and/or trucks. Round molded rubber. Designed with molded-in straight pin.

15-295 Small. Box of 48.

15-296 Medium. Box of 20.

15-297 Large. Box of 15.

15-298 Contains (1) 15-295, (1) 15-296 and (1) .30 fl. oz. cement. Carded. 5/master

15-290 Small. Reinforced. For up to 1/8" crown puncture. Box of 15.

15-291 Medium. Reinforced. For up to 1/4" crown puncture. Box of 10.

Non-Flammable Cements

Universal Cement

12-077 2 fl. oz. tube. Carded. 5/master.

12-085 1/4 pint (4 fl. oz.) can. 24/master.

12-086 1/2 pint (8 fl. oz.) can. 6/master.

12-089 1 quart. 12/master.



Camel® Tire Repair Products



12-087



12-287



12-072



12-078



12-090



12-092



12-093



12-097



12-095



12-096

Non-Flammable Cements *(cont'd)*

Cam-Cure® Heavy-Duty Nonflammable Cement

12-087 For use on heavy-duty applications. Must be Cam-Cure® Repair Units to ensure a permanent bond. 1/2 pint (8 fl. oz.) can. 6/master.

Flammable Cement

Cam-Cure Flammable Cement

12-287 For professional use. 1/2 pint (8 fl. oz.) can. 24/master.

Chemicals and Sealants

Camel Seal Tire Sealant

12-072 The solution to bead leaks, small tire punctures and slow leaks. Will not dry out, separate, damage the wheel or freeze to 32°F. Seal small leaks up to 1/8" in diameter. Great for farm or industrial tractors, construction equipment and off-road tires. One gallon bottle with pump. 4/master.

Tire Sealant

12-078 Perfect size for small trailers, wheelbarrows and other small tire vehicles. Convenient 8 fl. oz. squeeze bottle. 12/master.

Tire Sealant

12-079 The 16 fl. oz. squeeze bottle is just the right amount for lawn tractors, golf carts, trailers and ATVs. (not shown). 12/master.

Bead Sealer

12-090 Prevents bead leaks and eases tire installation. Quart can with brush in cap. 12/master.

Nonflammable Liquid Buffer/Cleaner

Used to clean rubber so patches will adhere properly. Use prior to all power buffing.

12-092 Quart can with "squirt top." 12/master.

12-093 16 oz. Aerosol can. 12/master.

"Stuf" Concentrated Tire Mounting Lubricant with Rust Inhibitor

12-095 Stops rubber squeaks, easy to use and safe. 8 lb. pail makes five gallons when mixed with warm water. 4/master.

12-096 40 lb. pail. 1/master.

Rubber Lubricant

12-097 Cleans and preserves tires, rubber parts, floor mats and vinyl tops. One gallon bottle. 4/master.

Reinforced Unitized Boots

Right angle cord construction uses high tensile cords for strength. Won't dry out or self-cure. May be used with cement or a spotter. **Not for use on tubeless tires.**

PART NO.	QUANTITY	TYPE	SIZE	PLIES
13-102	20	Nail Hole	3-1/4"	2
13-103	10	Small	4-1/2"	2
13-105	10	Medium	6"	2
13-106	10	Med. Lg.	7-3/8"	3
13-107	10	Large	8-3/4"	4
13-108	6	Truck	10-3/4"	5

Camel® Tire Repair Products

Reinforced Unitized Boots (cont'd)

Boots Packed in Hang-Up Printed Poly Bags

PART NO.	QUANTITY	TYPE	SIZE	PLIES
13-123	2/bag	Nail Hole	3-3/16" x 3-3/16"	
13-126	1/bag	Small	4-1/2" x 4-1/2"	
13-127	1/bag	Medium	6" x 6"	
13-128	1/bag	Med. Lg.	7-3/8" x 7-3/8"	

Bias Ply Repair Units

For bias ply tires only. Bead arrow is clearly marked. Has four centering lines.

PART NO.	QUANTITY	SIZE	PLY
13-251	30	2-1/2"	1
13-252	20	3-1/4"	1
13-253	10	4"	2
13-254	10	5"	2
13-255	10	6-1/2"	4

Radial Repair Units

For radial tires only.

PART NO.	QUANTITY	SIZE	PLY
13-310	20	2-1/4" x 3"	1
13-312	20	2-3/4" x 4-1/2"	2
13-320	10	3" x 4-1/8"	2
13-322	10	3" x 6-3/4"	2
13-340	5	4" x 7-1/2"	3

Universal Repair Units

Features square woven fabric construction and may be used for radial and bias ply tire repairs when used with Cam-Cure® cement.

13-230 Contains (2) 13-452 patches and (1) .30 fl. oz. cement. Carded. 5/master.

PART NO.	QUANTITY	SIZE	PLY
13-451	30	2-1/2"	1
13-452	20	3-1/4"	1

Tire Repair Hand Tools

15-172 **Open-Eye Repair Needle.** Carded. 10/master.

15-174 **Probe for Tire Repair.** Carded. 10/master.

15-224 **Super-Grip Open-Eye Needle.** Carded. 6/master.

15-944 **Super-Grip Open-Eye Needle.** Bulk. 175/carton.

15-225 **Super-Grip Tire Probe.** Carded. 6/master.

15-227 **Super-Grip Split-Eye Needle.** Carded. 12/master.

15-231 **Heavy-Duty Truck Needle.** Carded. 6/master.

15-230 **Replacement Shaft for 15-231.** 1/box.



13-102 13-108
13-103 13-123
13-105 13-126
13-106 13-127
13-107 13-128



13-251
13-252

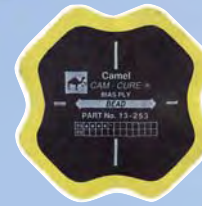

13-253
13-254
13-255



13-310
13-312
13-320
13-322
13-340



13-451
13-452

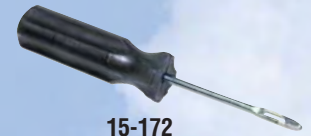

15-172

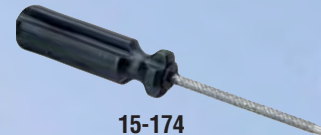

15-174



15-224
15-944



15-225



15-227



15-231

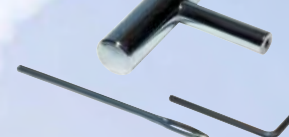

15-230

Camel® Tire Repair Products



Tire Repair Hand Tools *(cont'd)*

15-232 Spiral-Grip Cement Needle. 12/box.

15-249 Open-Eye 8" Truck Tire Needle. 12/box.

17-274 Tire Probe Awl. Used to inspect injuries in tire and remove small stones and debris. 1/box.

17-276 Professional Tire Reamer. Corrugated style with screw tip. 3/16" diameter. 1/box.

Tire Marking Crayons

Tire Lettering Stick

Restores the white on hollow and raised letters on tires.

17-235 Carded. 5/master.

Yellow Tire Marking Crayon

17-236 Carded. 5/master.

17-253 Shop pack of 12 boxes with 12 yellow crayons per box (144 crayons).

Cotton Applicator Swab

17-295 Carded. 12/master.

Professional Stitchers

Ball Bearing Stitcher

With hardened steel wheel and varnished wooden handle. 1/16" face x 1-1/2" diameter.

17-244 Carded. 6/master.

17-245 1/8" face x 1-1/2" diameter. 1/box.

17-246 1/4" face x 2" diameter. 1/box.

Combination Buffer/Stitcher

17-237 Carded. 10/master.

Tire Service Tools

Knife

17-248 Taper point knife. Sturdy wooden handle. 1/box.

Buffing Cones

Heavy Duty Automotive Buffing Cone

18-259 2-1/2" diameter. Maximum speed 25,000 RPM. Carded.

Standard Automotive Buffing Cone

18-260 2" diameter. Maximum speed 25,000 RPM. Carded.

Chucks & Adapters

Threaded Adapter

18-141 1-7/8" long, with washer and nut for mounting tools on 3/8" -26 FPT arbor hole. 1/bag.

Adapter

18-146 1-11/16" x 3/8" -26 FPT. Contains two washers and one nut for tools with 3/8" arbor hole. 1/bag.

Professional Air Buffers

Supreme High Speed Air Buffer

Light-duty buffer for automotive tires and tubes. 0-10,000 RPM.

18-264 1/box.

Vane Repair Kit

18-263 For Supreme Buffer 18-264. 1/bag.

High Speed Air Buffer

18-266 Heavy-duty buffer for truck and tractor tire repairs. 0-16,000 RPM. 1/box.

Chrome Sleeve Snap-In Valves

Used for .453" diameter rim holes. Do not use on tires that exceed 65 PSI or on rims that exceed .156" thickness.

TR 413 1-1/4" Effective length.

30-136 4 Pack. Carded. 10/master.

30-136-50 50/box.

TR 418 2" Effective length.

30-186 4 Pack. Carded. 10/master.

Chrome Sleeve and Nut Dress-Up Kits

Used to dress up rubber snap-in valves. Includes 4 sleeves and 4 chrome nuts.

30-316-4 4 Pack. (Fits TR413). Carded. 5/master.

30-318-4 4 Pack. (Fits TR418). Carded. 5/master.

Snap-In Valves for .453 Rim Holes

Fits smaller wheel sizes like hand trucks, wheelbarrows, golf carts and other specialty vehicles with .453" diameter rim hole. Maximum inflation pressure 60 PSI.

TR 412 7/8" Effective length.

30-412-2 2 Pack. Carded. 10/master.

30-412-50 50/box.

30-412-500 500/box.

TR 413 1-1/4" Effective length.

30-413-2 2 Pack. Carded. 5/master.

30-413-10 10/box.

30-413-50 50/box.

30-413-500 500/box.

TR 414 1-1/2" Effective length.

30-414-2 2 Pack. Carded. 5/master.

30-414-10 10/box.

30-414-50 50/box.

30-414-500 500/box.

TR 418 2" Effective length.

30-418-2 2 Pack. Carded. 5/master.

30-418-10 10/box.

30-418-50 50/box.

30-418-500 500/box.

TR 423 2-1/2" Effective length.

30-423-4 4 Pack. Carded. 5/master.

30-423-10 10/box.

30-423-50 50/box.

30-423-500 500/box.



18-264



30-136



30-186



30-316
30-318

30-412



30-413

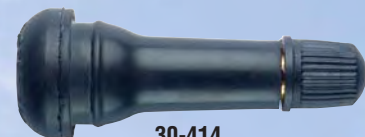

30-414



30-418



30-423

Camel® Tire Repair Products



30-415



30-425



30-600
30-602



30-801

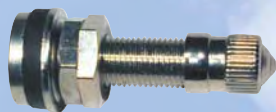

30-430-10



30-445



30-463 30-463-500
30-463-50 30-461-50



31-013-5
31-013-100
31-015-5



30-472-5

Snap-In Valves for .625 Rim Holes

TR 415 1-1/4" Effective length.

30-415-2 2 Pack. Carded. 5/master.

30-415-10 10/box.

30-415-50 50/box.

30-415-500 500/box.

TR 425 2" Effective length.

30-425-4 4 Pack. Carded. 5/master.

30-425-10 10/box.

30-425-50 50/box.

30-425-500 500/box.

High Pressure Snap-In Valves

TR600HP

Rated to 80 PSI. Includes core and cap. Fits .453" rim holes. Not for rims over .205" thick Effective length 1.27".

30-600-10 10/box.

30-600-50 50/box.

30-600-500 500/box.

TR602HP

Effective length 2".

30-602-50 50/box.

TR801HP

Rated to 100 PSI. Fits .625" rim holes. Effective length 1.31".

30-801-500 500/box.

Tire Valves

TR 430 Tubeless Clamp-In Motorcycle Valve

Fully threaded stem for use on many rim thicknesses. "O" ring seal. Effective length 1-3/16", fits .327" valve hole.

30-430-10 10/box.

599IB High Performance Tire Valve

Chrome plated clamp-in valves are easily installed in all types of passenger car wheels with .453" or .625" valve holes.

30-445 Carded. 5/master.

TR 416 Clamp-In Tubeless Tire Valves

Nickel plated metal valves can be installed in all passenger cars, light trucks and industrial rims with .453" or .625" valve holes. Rubber grommet forms a seal when valve is clamped to rim by tightening hex nut. Maximum inflation pressure is 130 PSI. Includes 2 rubber grommets. Effective length 1-1/4".

30-463 Carded. 10/master.

30-463-50 50/box.

30-463-500 500/box.

TR 416 Clamp-In Tubeless Tire Valve

Effective length 2".

30-461-50 50/box.

TR 417 Clamp-In Valve for Front Wheel Drive

Use on Cadillac El Dorado and Oldsmobile Toronado through 1978.

30-472-5 5/box.

Tube Type Passenger Valves

Special compound cushion gum base allows bonding of valve to the tube using hot or cold (chemical bond). 5/box.

31-013-5 TR 13, .406 Shank diameter. 1-3/8".

31-013-100 100/box.

31-015-5 TR 15, .651 Shank diameter. 1-3/8".

Tire Valves (cont'd)

Rim Hose Bushing

Used to reduce the size of large rim holes so TR-13 valves fit more snugly.

31-336-100 100/box..

Straight Clamp-In Valve

For use in one-piece drop center rims with 5/8" diameter side-mount valve holes. 10/box.

32-200-10 TR 500, effective length 2".

32-200-100 100/box.

32-201-10 TR 570, effective length 3-1/8".

32-201-100 100/box.

32-201-250 250/box.

32-202-10 TR 571, effective length 3-3/8".

32-202-100 100/box.

32-202-250 250/box.

32-203-10 TR 572, effective length 3-3/4".

32-203-100 100/box.

32-203-250 250/box.

32-203-250NC TR 572, effective length 3-3/4" - NO CAP. 250/box.

32-204-10 TR 573, effective length 4-3/8".

32-204-100 100/box.

32-204-250 250/box.

32-205-10 TR 501, effective length 1-1/2".

32-207-10 TR 575, effective length 1-1/8".

32-208-50 TR 574, effective length 5".

32-208-250 250/box.

32-985-10 Replacement grommet. TR RG-15 for use on TR570 series valves. 10/bag.

Tubeless Single Bend Clamp-In Valve

For one piece drop center aluminum disc wheels with 5/8" rim holes.

Has 90 degree bend

32-309-10 TR 509. 10/box.

32-946-10 Replacement grommet. TR RG-46 for use on . TR509 and TR510 valves. 10/bag.

Truck Tubeless Valves

Designed for use with 9.7cm (.328") rim holes. Rubber o-ring forms a seal when valve is clamped to rim by tightening hex nut. Designed specifically for use in aluminum.

32-543-10 TR 543D, effective length 2.31". 60 degree bend.

32-547-10 TR 545D, effective length 3.5". 60 degree bend.

Import Truck Tubeless Valves (ETRO)

Used on Volvo, Mac and Iveco imported trucks. Fits .382" diameter (9.7mm) rim holes. Includes O-ring, nut, core and cap.

32-608-10 ETRO No. V3-20-4, 27 degree bend. 10/box.

Standard Tube Convertible Valve

Valves can be bent as needed. May be applied with heat vulcanization or Universal Cement.

33-306-5 TR78A. 5/box.

Rear Wheel Valves

Features removable core housing that permits rapid filling of tire with ballast when removed. Complete with core housing, rim nut, core and cap.

34-218-5 TR 218A, effective length 1-5/8". 5/box.

Tractor Front Wheel Valve

Low profile tubeless valve offers minimum protrusion above rim hole. Brass finish. Fits .625" rim hole. Effective length 9/16".

34-017-10 10/box.

31-336-100

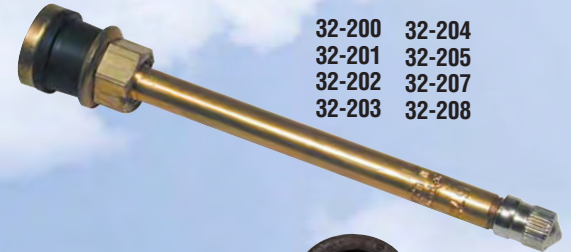

32-200 **32-204**
32-201 **32-205**
32-202 **32-207**
32-203 **32-208**

32-985-10
32-946-10



32-309-10



32-543-10
32-547-10



32-608-10



33-306



34-218-5



34-017-10

Camel® Tire Repair Products



34-221-5



34-963-10



34-955



34-282-25



37-080

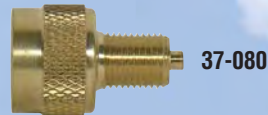

37-096



38-313-50
38-313-250
38-313-500
38-313-1000



38-314-4
38-314-50
38-315-4
38-315-50



38-324-4
38-325-4
38-326-4

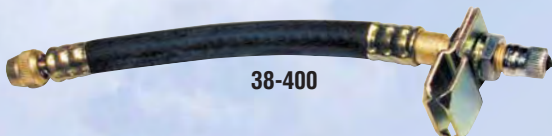

38-400

Tire Valves (cont'd)

Tubeless Tractor Valve

Has removable core housing. Complete with core housing, valve core, cap, hex nut, washer and rubber grommet. TR 618A, 1-7/8" length.

34-221-5 5/box.

Air-Liquid Core Housing

Screws into air-liquid valves and extensions and features O-ring seal.

34-963-10 TR-CH-3. 10/box.

Plastic Rim Nut

34-282-25 Used with air/liquid tire valves. 25/box.

Fluid Adapter for Ballast

Screws onto .482"-26 threads of all air/liquid valves. Has a bushing to fit .305"-32 valve cap threads of standard tire valves. Includes an additional bushing to fit .406"-26 threads of old style air liquid valves.

34-955 1/bag.

Valve Adapter

Converts large bore to standard bore. Uses outer valve threads.

37-080 5/box.

Valve Adapter

Converts large bore to standard bore. Uses inner valve threads.

37-096 5/box.

Valve Extensions

Double Sealing Extensions

38-313-50 Valves have two O-rings for high pressure applications. 50/box.

38-313-250 250/box.

38-313-500 500/box.

38-313-1000 1000/box.

Chrome Plated Brass 3/4" Extensions

38-314-4 Long lasting chrome finish. 4 Pack. Carded. 5/master.

38-314-50 50/box.

Chrome Plated Brass 1-1/4" Extensions

38-315-4 Long lasting chrome finish. 4 Pack. Carded. 5/master.

38-315-50 50/box.

Black Nylon 3/4" Extensions

38-324-4 4 Pack. Carded. 5/master.

38-324-10 10/box.

38-324-50 50/box.

Black Nylon 1-1/4" Extensions

38-325-4 4 Pack. Carded. 5/master.

38-325-10 10/box.

38-325-50 50/box.

Black Plastic 1-1/2" Extensions

38-326-4 4 Pack. Carded. 5/master.

38-326-50 50/box.

Dual Wheel Valve Extensions

These rubber 6.3" flexible extensions provide easy access to inner dual wheels on motor homes and other vehicles with small dual wheels. Includes clamp to secure hose to wheel. Installs with simple hand tools in minutes.

38-400 Effective length 7". Display pack of 2. Carded 2/master.

38-400-10 Effective length 7". 10/box.

Valve Extensions *(cont'd)*

Standard Truck Extensions

Screws onto standard .305"-32 valve cap threads to make valve mouth more accessible for air service.

- 38-430-10** Length 3-1/16". 10/box.
- 38-432-10** Length 6-1/16". 10/box.
- 38-436-10** Length 5-1/16". 10/box.
- 38-472-10** Length 1-3/8". 10/box.
- 38-474-10** Length 4-7/16". 10/box.
- 38-475-10** Length 1-13/32". 10/box.
- 38-476-10** Length 2-7/32". 10/box.
- 38-477-10** Length 3-1/8". 10/box.
- 38-478-10** Length 4-1/8". 10/box.

Bent Metal Extensions

- 38-481-10** Length 1-3/8". 45 degree angle. 10/box.
- 38-483-10** Length 1-1/2". 95 degree angle. 10/box.

Valve Caps

Plastic Caps VC8

Black flexible plastic cap (has no sealing unit).

- 38-505** 4 Pack. Carded. 5/master.
- 38-505-100** 100/box.
- 38-505-500** 500/box.

Screwdriver Caps VC2

Fit .305" -32 threads on standard type valves. All purpose cap with screwdriver top for removing and inserting valve cores. Has guide on skirt for easy application to valve threads.

- 38-600-4** 4 Pack. Carded. 5/master.
- 38-600-100** 100/box.

Standard Valve Caps VC3

Dome-shaped top and guide on skirt for easy application to valve threads.

- 38-772-4** 4 Pack. Carded. 5/master.
- 38-772-100** 100/box.
- 38-772B-1000** Same as 38-772 but with black finish. 1000/box.

Heavy Duty Caps

Heat resistant. For use on chrome sleeve and high performance valves.

- 38-712-4** 4 Pack. Carded. 5/master.
- 38-712-100** 100/box.

Made from hexagon rod for wrench application. Conforms to military spec. MIL-C-5000 and MS-20813. 0-5,000 PSI. -65 to +160 degrees. VC 5.

- 38-714-100** 100/box.

Heavy duty cap with special heat resistant rubber washer. Has guide on skirt for easy application to valve threads. 0-250 PSI. -40-200 degree operating temperature. Nickel plated

- 38-750-100** 100/box.

Tire Indicating Valve Caps

Tell at a glance if your tire has lost pressure. Fits standard valve stems on cars, motorcycles and light trucks.

- 38-705-4** 32 PSI. 4/card. 5/master.
- 38-710-4** 36 PSI. 4/card. 5/master.

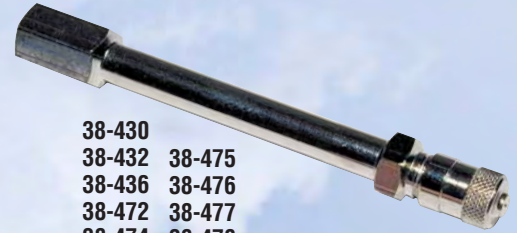

38-430
38-432 38-475
38-436 38-476
38-472 38-477
38-474 38-478



38-481-10
38-483-10

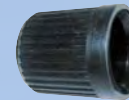

38-505
38-505-100
38-505-500

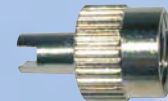

38-600-4
38-600-100



38-772-4
38-772-100



38-712-4
38-712-100

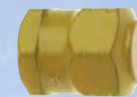

38-714-100



38-750-100



38-705-4
38-710-4

Camel® Tire Repair Products



38-790-4
38-790-100
38-790-1000
38-805-100
38-810-100
38-830-100
38-825-100



37-828-10



38-900
38-900-10



38-904-10
38-908-10



38-906-10



41-067



40-395



41-444



41-068

Valve Cores

These valve cores all have .206"-36 threads and are compatible with existing U.S.A. and E.T.R.T.O. housing standards as well as I.S.O. standards. General purpose valve use. Meets specifications ZZ-V-25 and TR-C-1.

38-790-4 4 Pack. Carded. 5/master.

38-790-100 100/box.

38-790-1000 1,000/box.

Aircraft shock strut and hydraulic accumulator use. Meets specifications AN-809-1 and MIL -C-5499. 0-2,000 PSI. 0-165 degree operating temperature. 100 PSI opening pressure.

38-805-100 100/box.

Hydraulic accumulator use valve core. Meets specifications AN-809-1 and MIL -C-5499. 0-2,000 PSI. 0-165 degree operating temperature. 70 PSI opening pressure.

38-810-100 100/box.

1.0-200 PSI. -40-225 degree operating temperature. 60 PSI opening pressure.

38-830-100 100/box.

General purpose high-pressure, heat-resisting applications. Meets specifications MIL-V-27317 and TRC-4. 0-400 PSI. -65-350 degree operating temperature. 70 PSI opening pressure.

38-825-100 100/box.

Large Bore Core

This valve core has .305" - 32" threads and is compatible with existing USA standards for large bore valve housings. Meets spec. TR-C-2. 0-200 PSI.

37-828-10 10/box.

Use with compressed air tanks for rapid filling or deflation of air tanks and air lines. Maximum pressure 200 PSI. Includes cap and core.

38-900 1/8" NPT. Effective length 29/32". Carded. 5/master.

38-900-10 1/8" NPT. Effective length 29/32". 10/box.

Tank Valves

For air tanks, steel barrels, compressors and other pneumatic containers where dependable automatic air valves are needed. Valves are equipped with standard valve core and sealing caps for operating pressures to 200 PSI. These valves have NPT male threads and allow for external length variations by use of short core only or internal protrusion of core housing into container.

38-904-10 1/4" NPT with bent extension. 1/bag. 10/master

38-906-10 1/8" NPT. Effective length 17/32". 10/box.

38-908-10 1/8" NPT with bent extension. 1/bag.

Tire Service Tools

Tread Depth Gauge

Steel indicator bar. Calibrated from 0 to 1" in 1/32". With pocket clip.

40-395 Carded. 5/master.

40-395-100 100/box.

4-Way Tire Valve Repair Tool

Repairs core and stem threads. Has core screwdriver and broken core extractor.

41-067 Carded. 5/master.

41-067-20 20/box..

Double Use Tool

For deflating tires tubes and core removal.

41-068 Carded. 10/master.

Tire Service Tools *(cont'd)*

Valve Core Extractor With Plastic Handle (shown on pg. 38)
Simplifies removal of old cores that are difficult to unscrew.
41-444 Carded. 10/master.

Tube Deflating Aspirator
Removes air quickly by creating a vacuum effect when air is applied to threaded chuck.
41-460 Carded. 10/master.

Valve Fishing Tool
Centers valve in rim hole while mounting tires. For use on .453" and .625" rim holes.
41-466 Carded. 5/master.

Valve Core Extracting Tool
All metal construction
41-469 Carded. 10/master.

Tubeless Tire Inserting Tool
Used for installation and removal of rubber snap-in valves.
41-506 Carded. 5/master.
41-506-5 5/box.

Air Line Accessories

54-515 Replacement Dial Gauge for 54-510 air tank. 1/box.
54-516 Replacement Hose and Fittings for 54-510 air tank. 1/box.
54-517 Replacement Manifold for 54-510 air tank. 1/box.
41-903 1/2" Compressor Tank Check Valve. Carded. 10/master.

Air Tank Conversion Kit
Comes complete with one each of 54-515, 54-616 and 54-517.
41-907 Carded. 5/master.



41-460



54-515



41-466



41-506



41-469



54-517



41-903



54-516

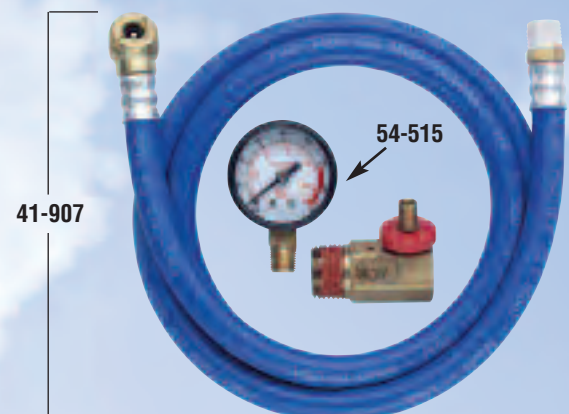

41-907

54-515



24-10
24-20-RET
24-30
24-50E-RET

4-12D
4-25-RET
4-25E-RET
4-50E-RET



25L-24BD
25L-60BD
37L-30B-RET
37L-72BD



552-50AE



12-25E
12-50E
12-100E



552-50AK



552-50AK-5

Nylon Recoil Hose

Amflo Yellow Nylon recoil hose can be used with all air-powered equipment in garages, plants, service stations, etc. All hoses come with swivel fittings on each end and have a rated working pressure of 200 PSI. All 1/bag.

PART NO.	DESCRIPTION
4-12D	1/4" x 12', 1/4" swivel fittings
4-25-RET	1/4" x 25', 1/4" swivel fittings
4-25E-RET	1/4" x 25' Economy, 1/4" swivel fittings
4-50E-RET	1/4" x 50' Economy, 1/4" swivel fittings

Polyurethane Recoil Hose

Amflo Yellow Polyurethane recoil hose with pigtails. All 1/bag.

24-10	1/4" x 10', 1/4" male solid fittings
24-20-RET	1/4" x 20', 1/4" male solid fittings
24-30	1/4" x 30', 1/4" male solid fittings
24-50E-RET	1/4" x 50'

Lead-In Hose

Lead-In hose is essential to absorb the shock loads produced by air powered tools to the air hose coupler. Shock loads transmitted directly to the coupler and plug damage the locking balls of the coupler leading to premature failure. Maximum working pressure 300 PSI.

PART NO.	DESCRIPTION
25L-24BD	1/4" x 24"
25L-60BD	1/4" x 60"
37L-30B-RET	3/8" x 30', 1/4" ball swivel
37L-72BD	3/8" x 72', 1/4" ball swivel

Polyurethane Air Hose

Quality polyurethane air hose for home and many other uses.

PART NO.	DESCRIPTION	PSI	Color
12-25E	1/4" x 25', 1/4" swivel fittings	300	Blue
12-50E	1/4" x 50', 1/4" swivel fittings	300	Blue
12-100E	1/4" x 100', 1/4" swivel fittings	300	Blue
* 13-50AE	3/8" x 50', 1/4" swivel fittings	300	Blue
* 13-50E	3/8" x 50', 3/8" swivel fittings	300	Blue
* 13-100AE	3/8" x 100', 1/4" swivel fittings	300	Blue
* 13-100E	3/8" x 100', 3/8" swivel fittings	300	Blue

* Not Shown.

Rubber Air Hose

Quality rubber air hose for garage, shop, industry, home and many other uses.

PART NO.	DESCRIPTION	PSI	Color
512-25E	1/4" x 25', 1/4" fittings	300	Red
512-50E	1/4" x 50', 1/4" fittings	300	Red
* 514-500	3/8" x 500', bulk	300	Red
* 551-25AE	3/8" x 25', 1/4" fittings	200	Red
* 551-50AE	3/8" x 50', 1/4" fittings	200	Red
* 552-25AE	3/8" x 25', 1/4" fittings	300	Red
• 552-50AE	3/8" x 50', 1/4" fittings	300	Red
• 552-50AK	3/8" x 50', mini pallet	300	Red
• 552-50AK-5	3/8" x 50'	300	Red

PVC Hose

Quality PVC multi-purpose air hose. Light weight, flexible, kink-resistant design.

PART NO.	DESCRIPTION	PSI	Color
522-100	1/4" x 100', 1/4" fittings	250	Yellow
554-25A	3/8" x 25', 1/4" fittings	300	Blue
554-50A	3/8" x 50', 1/4" fittings	300	Blue
554-100A	3/8" x 100', 1/4" fittings	300	Blue
576-25A	3/8" x 25', 1/4" fittings	300	Day Glo Orange
576-50A	3/8" x 50', 1/4" fittings	300	Day Glo Orange
576-100A	3/8" x 100', 1/4" fittings	300	Day Glo Orange

Brass Ferrules

For use with hose barb fittings. Make sure ferrule closely matches hose O.D. 50/box.

AMFLO NO.	FERRULE I.D.
7323-50	.527"
7325-50	.562"
7326-50	.593"
7327-50	.625"
7328-50	.656"
7329-50	.687"
7330-50	.718"
7331-50	.750"

* Not Shown.
• Shown on previous page



**512-25E
512-50E**



522-100



**554-25A
554-50A
554-100A**



**576-25A
576-50A
576-100A**



**7323-50 7325-50
7326-50 7327-50
7328-50 7329-50
7330-50 7331-50**

Amflo® Hose Reels



501HR-RET
502HR-RET

505HR-RET
510HR-RET
515HR-RET

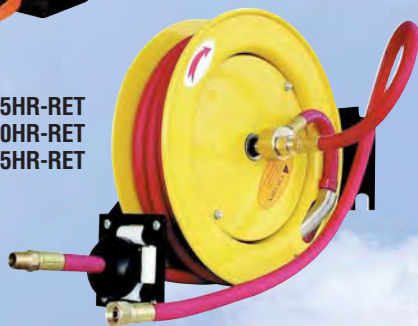

522HR-RET
525HR-RET



530HR-RET
535HR-RET



550HR-RET



Hose Reels

501HR-RET Reel with 3/8" X 50' PVC Hose, 1/4" fittings.

502HR-RET Reel only.

505HR-RET Retractable reel with 3/8" X 50' rubber hose, 3/8" fittings.

510HR-RET Retractable reel with 3/8" X 25' rubber hose, 3/8" fittings.

515HR-RET Retractable reel with 1/2" X 50' rubber hose, 1/2" fittings.

522HR-RET Enclosed retractable reel with 1/4" X 30' PVC hose, 1/4" fittings.

525HR-RET Enclosed retractable reel with 3/8" X 50' PVC hose, 3/8" fittings.

530HR-RET Enclosed retractable reel with 1/4" X 50' polyurethane hose with 1/4" fittings.

535HR-RET Enclosed retractable reel with 3/8" X 50' polyurethane hose with 3/8" fittings.

550HR-RET Enclosed retractable garden hose reel with 65' of garden hose.

Tomkins

Industrial and Automotive

AirAware™

Amflo®

EDELMANN®

IDEAL™

PLEWS™
LubriMatic

SCHRADER

TRIDON®

TRU-FLATE®

AirAware:

Tire Pressure Monitoring Systems

Amflo:

Air Line Accessories

Pneumatic Hoses

Edelmann:

Power Steering Hose Assemblies

Automotive Fittings

Brake Lines

Transmission Oil Cooler Lines & Fittings

Engine Oil Cooler Lines

Unicoil™ Hose Benders

Ideal:

Hose Clamps

T-Bolts

Plews/LubriMatic:

Oils, Greases & Spray Lubricants

Lubrication Equipment

Schrader-Bridgeport:

SchraderAir™ Air Compressors
& Pressure Washers

Tire Valves (Passenger & Truck)

Tridon:

Hose Clamps

Tru-Flate:

Air Line Accessories

Tire Gauges & Hardware

Camel® Tire Hardware & Repair

TRU-FLATE®

Telephone (800) 770-4639

Fax (815) 288-3388

Website www.plews-edelmann.com

Route 38, Airport Industrial Park
Dixon, IL 61021