

FEATURING THE LATEST PRODUCTS FROM WIDIA™ AND HANITA™

ADVANCES

METRIC | 2021



WIDIA 

 **HANITA**

INTRODUCING...

NEW PRODUCTS

TDMX

pages 54–60



WGC

pages 62–65

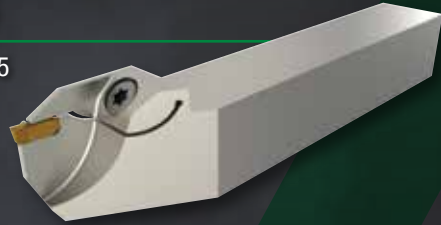

AL Inserts

pages 72–79

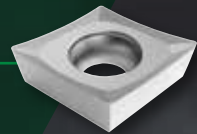

RU Geometry

pages 66–70



Railway Tools

pages 80–91

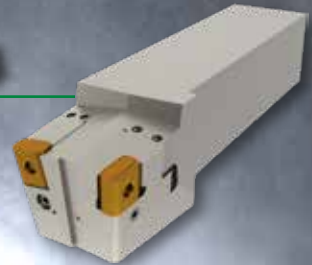

M8065

pages 30–36



M1200

pages 38–44



M1600

pages 46–52



WIDIA 

HANITA

SOLID END MILLING

4–25

VariMill™ XTREME™
ALUFLASH™

WIDIA

INDEXABLE MILLING

30–52

M8065
M1200
M1600

HOLEMAKING

54–60

TDMX

TURNING

62–91

WGC
Railway Tools

ORDERING INFORMATION

92–95

Informational Icons Guide
CAS
Material Overview

VariMill™ XTREME™

pages 4–13



ALUFLASH™

pages 14–25





HANITA™



PRODUCTIVITY

Solid end mills in the Hanita portfolio achieve exceptional levels of productivity in complex operations at increased cutting parameters.



DURABILITY

End mills in the Hanita portfolio feature optimized geometries capable of peak performance in high-demand machining strategies.



INNOVATION

Hanita is a brand for innovation enthusiasts who are searching for precision-engineered solid carbide end mill solutions.

Hanita **high-performance solid carbide end mill solutions** are developed for customers who have a passion for performance.

Offering a comprehensive range of standard and custom end mills spanning a broad range of diameters and lengths, all boasting **unparalleled metal removal rates** through **innovative geometries**. Hanita delivers not only the tool for the job but **the experience** to develop a solution for the customer.

Hanita solutions are available through WIDIA channel partners.

VariMill™

XTREME™

*High-Performance
Solid End Milling*

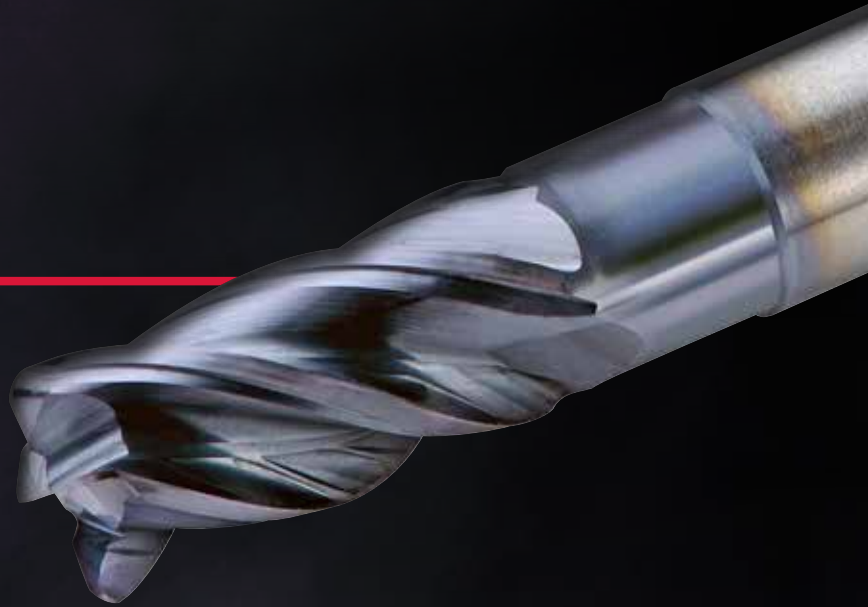

Materials



Applications



Slotting



Side Milling/
Shoulder Milling



Ramping



Helical
Interpolation



Plunge Milling



Trochoidal Milling



Drilling

WS15PE Grade

4-flute solid carbide end mill, sharp edges,
chamfers and corner radii designs available.



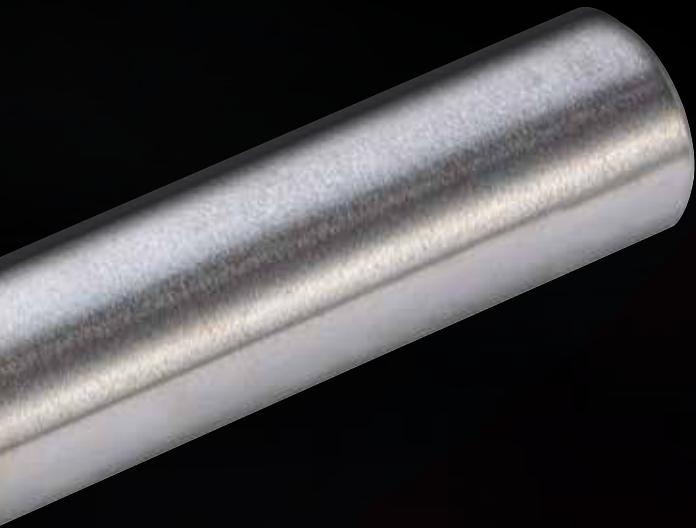

Built-in features to enable aggressive versatility.

Twisted End Face to improve edge stability, which enables aggressive ramping angles and helical capability.

Non-Linear Chip Gashes for improved chip evacuation, enabling the ramping function and z-axis machining.

Four Asymmetrical Divided Flutes with Variable Helix Angle to reduce vibrations.

Parabolic Core for increased tool stability and reduced deflection.

wear resistance ← → toughness

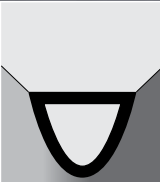
Coating	Grade Description	Grade Description									
			05	10	15	20	25	30	35	40	45
WS15PE 	PVD-coated carbide grade with optimized chemistry and process for increased wear resistance. State-of-the-art, post-coat treatment reduces friction and helps manage heat when cutting super alloys.	P									
		M									
		K									
		S									
		H									

VARIMILL™ XTREME™



Solid Carbide End Mills

SERIES 4X0E • CHAMFERED • 4 FLUTES • CYLINDRICAL SHANK • METRIC

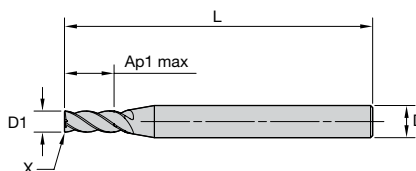
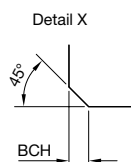

grade WS15PE
AlTiN

order #	catalogue #	D1	D	length of cut Ap1 max	length L	BCH
6829315	4X0EM04002CST	4,0	6	8,00	57	0,10
6829320	4X0EM05002CST	5,0	6	10,00	57	0,10
6829695	4X0EM06002CST	6,0	6	12,00	57	0,10
6829881	4X0EM08003CAT	8,0	8	16,00	63	0,20
6829888	4X0EM10004CAT	10,0	10	20,00	72	0,20
6830075	4X0EM12005CCT	12,0	12	24,00	83	0,30

SERIES 4X0E • RADIUSSED • 4 FLUTES • CYLINDRICAL SHANK • METRIC

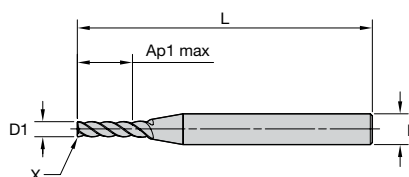
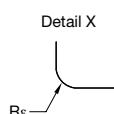

grade WS15PE
AlTiN

order #	catalogue #	D1	D	length of cut Ap1 max	length L	Re
6829314	4X0EM03002RAT	3,0	6	9,50	57	0,20
6830480	4X0EM25008RKT	25,0	25	50,00	121	1,50
6830671	4X0EM25008RPT	25,0	25	50,00	121	3,00



SERIES 4XNE • CHAMFERED • 4 FLUTES • NECKED • WELDON® SHANK • METRIC



grade WS15PE
AlTiN

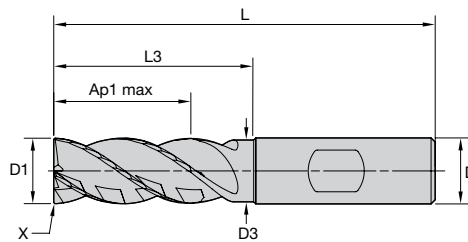
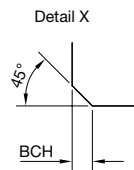

order #	catalogue #	D1	D	D3	length of cut Ap1 max	L3	length L	BCH
6829319	4XNEM04002CSW	4,0	6	3,76	12,00	16,00	57	0,10
6829694	4XNEM05002CSW	5,0	6	4,70	13,00	18,00	57	0,10
6829700	4XNEM06002CSW	6,0	6	5,64	13,00	21,00	57	0,10
6829887	4XNEM08003CAW	8,0	8	7,52	16,00	27,00	63	0,20
6830074	4XNEM10004CAW	10,0	10	9,40	22,00	32,00	72	0,20
6830282	4XNEM12005CCW	12,0	12	11,28	26,00	36,00	83	0,30
6830285	4XNEM16006CCW	16,0	16	15,04	32,00	48,00	92	0,30
6830473	4XNEM20007CCW	20,0	20	18,80	40,00	60,00	115	0,30

SERIES 4XNE • CHAMFERED • 4 FLUTES • CYLINDRICAL SHANK • METRIC



grade WS15PE
AlTiN

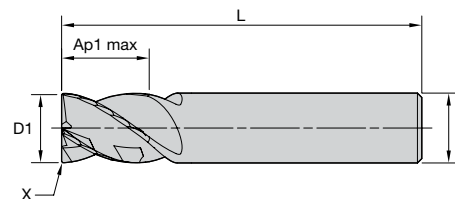
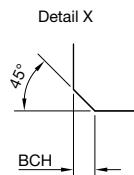

order #	catalogue #	D1	D	length of cut Ap1 max	length L	BCH
6830283	4X0EM16006CCT	16,0	16	18,00	82	0,30

VARIMILL™ XTREME™



Solid Carbide End Mills

SERIES 4XNE • RADIUSED • 4 FLUTES • NECKED • CYLINDRICAL SHANK • METRIC

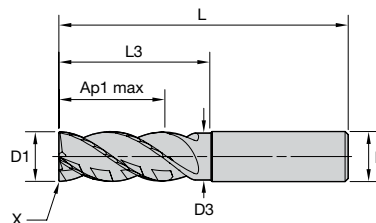
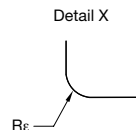

grade WS15PE
AlTiN

order #	catalogue #	D1	D	D3	length of cut Ap1 max	L3	length L	Re
6829317	4XNEM04002RAT	4,0	6	3,76	8,00	12,00	57	0,20
6829318	4XNEM04002RET	4,0	6	3,76	8,00	12,00	57	0,50
6829692	4XNEM05002RAT	5,0	6	4,70	10,00	15,00	57	0,20
6829693	4XNEM05002RET	5,0	6	4,70	10,00	15,00	57	0,50
6829697	4XNEM06002RAT	6,0	6	5,64	12,00	18,00	57	0,20
6829698	4XNEM06002RET	6,0	6	5,64	12,00	18,00	57	0,50
6829699	4XNEM06002RJT	6,0	6	5,64	12,00	18,00	57	1,00
6829883	4XNEM08003RAT	8,0	8	7,52	16,00	24,00	63	0,20
6829884	4XNEM08003RET	8,0	8	7,52	16,00	24,00	63	0,50
6829885	4XNEM08003RJT	8,0	8	7,52	16,00	24,00	63	1,00
6829886	4XNEM08003RKT	8,0	8	7,52	16,00	24,00	63	1,50
6829890	4XNEM10004RCT	10,0	10	9,40	20,00	30,00	72	0,30
6830071	4XNEM10004RET	10,0	10	9,40	20,00	30,00	72	0,50
6830072	4XNEM10004RJT	10,0	10	9,40	20,00	30,00	72	1,00
6830073	4XNEM10004RKT	10,0	10	9,40	20,00	30,00	72	1,50
6830077	4XNEM12005RET	12,0	12	11,28	24,00	36,00	83	0,50
6830079	4XNEM12005RKT	12,0	12	11,28	24,00	36,00	83	1,50
6830080	4XNEM12005RMT	12,0	12	11,28	24,00	36,00	83	2,00
6830281	4XNEM12005RPT	12,0	12	11,28	24,00	36,00	83	3,00
6830286	4XNEM16006RET	16,0	16	15,04	32,00	48,00	92	0,50
6830288	4XNEM16006RKT	16,0	16	15,04	32,00	48,00	92	1,50
6830289	4XNEM16006RPT	16,0	16	15,04	32,00	48,00	92	3,00
6830471	4XNEM16006RQT	16,0	16	15,04	32,00	48,00	92	4,00
6830474	4XNEM20007RET	20,0	20	18,80	40,00	60,00	115	0,50
6830476	4XNEM20007RKT	20,0	20	18,80	40,00	60,00	115	1,50
6830477	4XNEM20007RPT	20,0	20	18,80	40,00	60,00	115	3,00
6830478	4XNEM20007RRT	20,0	20	18,80	40,00	60,00	115	5,00



SERIES 4XNE • RADIUS • 4 FLUTES • NECKED • SAFE-LOCK™ SHANK • METRIC

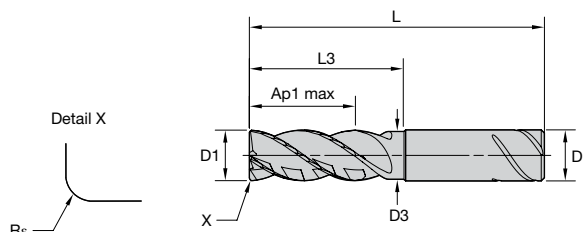

grade WS15PE
AITiN

order #	catalogue #	D1	D	D3	length of cut Ap1 max	L3	length L	Rε
6830078	4XNEM12005RJV	12,0	12	11,28	24,00	36,00	83	1,00
6830287	4XNEM16006RJV	16,0	16	15,04	32,00	48,00	92	1,00
6830475	4XNEM20007RJV	20,0	20	18,80	40,00	60,00	115	1,00

SERIES 4X0E • RADIUS • 4 FLUTES • SAFE-LOCK SHANK • METRIC

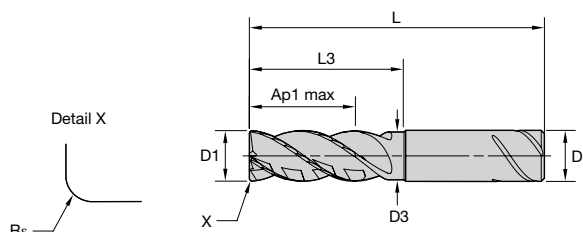

grade WS15PE
AITiN

order #	catalogue #	D1	D	length of cut Ap1 max	length L	Rε
6830479	4X0EM25018RJV	25,0	25	50,00	135	1,00

VARIMILL™ XTREME™



Solid Carbide End Mills

SERIES 4XNE • SQUARE END • 4 FLUTES • NECKED • CYLINDRICAL SHANK • METRIC

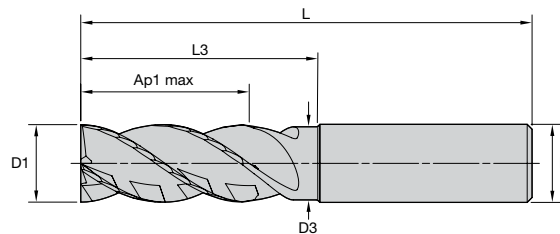

grade WS15PE
AlTiN

order #	catalogue #	D1	D	D3	length of cut Ap1 max	L3	length L
6829316	4XNEM04002SZT	4,0	6	3,76	8,00	12,00	57
6829691	4XNEM05002SZT	5,0	6	4,70	10,00	15,00	57
6829696	4XNEM06002SZT	6,0	6	5,64	12,00	18,00	57
6829882	4XNEM08003SZT	8,0	8	7,52	16,00	24,00	63
6829889	4XNEM10004SZT	10,0	10	9,40	20,00	30,00	72
6830076	4XNEM12005SZT	12,0	12	11,28	24,00	36,00	83
6830284	4XNEM16006SZT	16,0	16	15,04	32,00	48,00	92
6830472	4XNEM20007SZT	20,0	20	18,80	40,00	60,00	115



VARIMILL™ XTREME™ • SIDE MILLING AND SLOTTING • APPLICATION DATA • METRIC

Material Group																				
	Side Milling (A) and Slotting (B)			Recommended feed per tooth (fz = mm/th) for side milling (A). For slotting (B), reduce fz by 20%.																
	A		B	WS15PE Cutting Speed – vc m/min			D1 – Diameter													
	ap	ae	ap	min	Start	max	mm	3,0	4,0	5,0	6,0	8,0	10,0	12,0	14,0	16,0	18,0	20,0	25,0	
P	0	1,5 x D1	0,5 x D1	1,25 x D1	150	175	200	fz	0,023	0,031	0,040	0,048	0,066	0,079	0,091	0,102	0,111	0,119	0,125	0,136
	1	1,5 x D1	0,5 x D1	1,25 x D1	150	175	200	fz	0,023	0,031	0,040	0,048	0,066	0,079	0,091	0,102	0,111	0,119	0,125	0,136
	2	1,5 x D1	0,5 x D1	1,25 x D1	140	165	190	fz	0,023	0,031	0,040	0,048	0,066	0,079	0,091	0,102	0,111	0,119	0,125	0,136
	3	1,5 x D1	0,5 x D1	1,25 x D1	120	140	160	fz	0,019	0,026	0,033	0,040	0,055	0,067	0,077	0,087	0,096	0,104	0,111	0,125
	4	1,5 x D1	0,5 x D1	1,25 x D1	90	120	150	fz	0,018	0,024	0,030	0,036	0,049	0,059	0,069	0,077	0,084	0,091	0,097	0,107
	5	1,5 x D1	0,5 x D1	1,25 x D1	60	80	100	fz	0,016	0,021	0,027	0,032	0,044	0,053	0,062	0,070	0,077	0,083	0,089	0,100
6	1,5 x D1	0,5 x D1	1,25 x D1	50	65	75	fz	0,013	0,018	0,022	0,027	0,037	0,044	0,051	0,057	0,063	0,067	0,071	0,078	
M	1	1,5 x D1	0,5 x D1	1,25 x D1	90	100	115	fz	0,019	0,026	0,033	0,040	0,055	0,067	0,077	0,087	0,096	0,104	0,111	0,125
	2	1,5 x D1	0,5 x D1	1,25 x D1	60	70	80	fz	0,016	0,021	0,027	0,032	0,044	0,053	0,062	0,070	0,077	0,083	0,089	0,100
	3	1,5 x D1	0,5 x D1	1,0 x D1	60	65	70	fz	0,013	0,018	0,022	0,027	0,037	0,044	0,051	0,057	0,063	0,067	0,071	0,078
K	1	1,5 x D1	0,5 x D1	1,0 x D1	120	135	150	fz	0,023	0,031	0,040	0,048	0,066	0,079	0,091	0,102	0,111	0,119	0,125	0,136
	2	1,5 x D1	0,5 x D1	1,0 x D1	110	125	140	fz	0,019	0,026	0,033	0,040	0,055	0,067	0,077	0,087	0,096	0,104	0,111	0,125
	3	1,5 x D1	0,5 x D1	1,0 x D1	110	120	130	fz	0,016	0,021	0,027	0,032	0,044	0,053	0,062	0,070	0,077	0,083	0,089	0,100
S	1	1,5 x D1	0,5 x D1	0,75 x D1	50	70	90	fz	0,019	0,026	0,033	0,040	0,055	0,067	0,077	0,087	0,096	0,104	0,111	0,125
	2	1,5 x D1	0,5 x D1	0,75 x D1	50	65	80	fz	0,016	0,021	0,027	0,032	0,044	0,053	0,062	0,070	0,077	0,083	0,089	0,100
	3	1,5 x D1	0,5 x D1	0,5 x D1	25	30	40	fz	0,010	0,014	0,018	0,021	0,029	0,035	0,041	0,046	0,051	0,055	0,059	0,067
	4	1,5 x D1	0,5 x D1	1,25 x D1	50	55	60	fz	0,013	0,017	0,023	0,028	0,040	0,049	0,057	0,064	0,071	0,076	0,082	0,092
H	1	1,5 x D1	0,5 x D1	1,0 x D1	80	110	140	fz	0,018	0,024	0,030	0,036	0,049	0,059	0,069	0,077	0,084	0,091	0,097	0,107
	2	1,5 x D1	0,5 x D1	1,0 x D1	70	90	120	fz	0,013	0,018	0,022	0,027	0,037	0,044	0,051	0,057	0,063	0,067	0,071	0,078

NOTE: See page 11 for more information on VARIMILL™ XTREME™ adjustment factors for feed calculations.

VARIMILL™ XTREME™ • RAMPING • APPLICATION DATA • METRIC



Material Group	Helical Interpolation/Ramping 0°–15°																		
		WS15PE Cutting Speed – vc m/min			Recommended feed per tooth (fz = mm/z) for Helical Interpolation and Ramping – fz x 2														
		Max Depth	min	Start	max	Diameter – D1 [Ømin – Ømax]													
						mm min-max	3,5–5,7	4,6–7,6	5,8–9,5	6,9–11,4	9,2–15,2	11,5–19,0	13,8–22,8	16,1–26,6	18,4–30,4	20,7–34,2	23,0–38,0	28,8–47,5	
P	0	1,25 x D1	150	175	200	fz	0,023	0,031	0,040	0,048	0,066	0,079	0,091	0,102	0,111	0,119	0,125	0,136	
	1	1,25 x D1	150	175	200	fz	0,023	0,031	0,040	0,048	0,066	0,079	0,091	0,102	0,111	0,119	0,125	0,136	
	2	1,25 x D1	140	165	190	fz	0,023	0,031	0,040	0,048	0,066	0,079	0,091	0,102	0,111	0,119	0,125	0,136	
	3	1,25 x D1	120	140	160	fz	0,019	0,026	0,033	0,040	0,055	0,067	0,077	0,087	0,096	0,104	0,111	0,125	
	4	1,25 x D1	90	120	150	fz	0,018	0,024	0,030	0,036	0,049	0,059	0,069	0,077	0,084	0,091	0,097	0,107	
	5	1,25 x D1	60	80	100	fz	0,016	0,021	0,027	0,032	0,044	0,053	0,062	0,070	0,077	0,083	0,089	0,100	
6	1,25 x D1	50	65	75	fz	0,013	0,018	0,022	0,027	0,037	0,044	0,051	0,057	0,063	0,067	0,071	0,078		
M	1	1,25 x D1	90	100	115	fz	0,019	0,026	0,033	0,040	0,055	0,067	0,077	0,087	0,096	0,104	0,111	0,125	
	2	1,25 x D1	60	70	80	fz	0,016	0,021	0,027	0,032	0,044	0,053	0,062	0,070	0,077	0,083	0,089	0,100	
	3	1,0 x D1	60	65	70	fz	0,013	0,018	0,022	0,027	0,037	0,044	0,051	0,057	0,063	0,067	0,071	0,078	
K	1	1,0 x D1	120	135	150	fz	0,023	0,031	0,040	0,048	0,066	0,079	0,091	0,102	0,111	0,119	0,125	0,136	
	2	1,0 x D1	110	125	140	fz	0,019	0,026	0,033	0,040	0,055	0,067	0,077	0,087	0,096	0,104	0,111	0,125	
	3	1,0 x D1	110	120	130	fz	0,016	0,021	0,027	0,032	0,044	0,053	0,062	0,070	0,077	0,083	0,089	0,100	
S	1	0,75 x D1	50	70	90	fz	0,019	0,026	0,033	0,040	0,055	0,067	0,077	0,087	0,096	0,104	0,111	0,125	
	2	0,75 x D1	50	65	80	fz	0,016	0,021	0,027	0,032	0,044	0,053	0,062	0,070	0,077	0,083	0,089	0,100	
	3	0,5 x D1	25	30	40	fz	0,010	0,014	0,018	0,021	0,029	0,035	0,041	0,046	0,051	0,055	0,059	0,067	
	4	1,25 x D1	50	55	60	fz	0,013	0,017	0,023	0,028	0,040	0,049	0,057	0,064	0,071	0,076	0,082	0,092	
H	1	1,0 x D1	80	110	140	fz	0,018	0,024	0,030	0,036	0,049	0,059	0,069	0,077	0,084	0,091	0,097	0,107	
	2	1,0 x D1	70	90	120	fz	0,013	0,018	0,022	0,027	0,037	0,044	0,051	0,057	0,063	0,067	0,071	0,078	

VARIMILL™ XTREME™ • RAMPING • APPLICATION DATA • METRIC

Material Group	Max Depth	Helical Interpolation/Ramping		WS15PE		mm min-max	Recommended feed per tooth (fz = mm/z) for Helical Interpolation and Ramping — fz x 2														
		15°-30°		Cutting Speed — vc m/min			Diameter — D1 [Ømin – Ømax]														
		min	Start	min	max		3,0	4,0	5,0	6,0	8,0	10,0	12,0	14,0	16,0	18,0	20,0	25,0			
							3,5-5,7	4,6-7,6	5,8-9,5	6,9-11,4	9,2-15,2	11,5-19,0	13,8-22,8	16,1-26,6	18,4-30,4	20,7-34,2	23,0-38,0	28,8-47,5			
P	0	1,25 x D1	150	165	175	fz	0,017	0,023	0,030	0,036	0,050	0,059	0,068	0,076	0,083	0,089	0,094	0,102			
	1	1,25 x D1	150	165	175	fz	0,017	0,023	0,030	0,036	0,050	0,059	0,068	0,076	0,083	0,089	0,094	0,102			
	2	1,25 x D1	140	155	165	fz	0,017	0,023	0,030	0,036	0,050	0,059	0,068	0,076	0,083	0,089	0,094	0,102			
	3	1,25 x D1	120	130	140	fz	0,014	0,019	0,025	0,030	0,041	0,050	0,058	0,065	0,072	0,078	0,083	0,094			
	4	1,25 x D1	90	105	120	fz	0,013	0,018	0,022	0,027	0,037	0,045	0,051	0,058	0,063	0,068	0,073	0,080			
	5	1,25 x D1	60	70	80	fz	0,012	0,016	0,020	0,024	0,033	0,040	0,046	0,052	0,058	0,062	0,067	0,075			
M	1	1,25 x D1	90	95	100	fz	0,014	0,019	0,025	0,030	0,041	0,050	0,058	0,065	0,072	0,078	0,083	0,094			
	2	1,25 x D1	60	65	70	fz	0,012	0,016	0,020	0,024	0,033	0,040	0,046	0,052	0,058	0,062	0,067	0,075			
	3	1,0 x D1	60	62	65	fz	0,010	0,013	0,017	0,020	0,028	0,033	0,038	0,043	0,047	0,050	0,053	0,059			
K	1	1,0 x D1	120	130	135	fz	0,017	0,023	0,030	0,036	0,050	0,059	0,068	0,076	0,083	0,089	0,094	0,102			
	2	1,0 x D1	110	120	125	fz	0,014	0,019	0,025	0,030	0,041	0,050	0,058	0,065	0,072	0,078	0,083	0,094			
	3	1,0 x D1	110	115	120	fz	0,012	0,016	0,020	0,024	0,033	0,040	0,046	0,052	0,058	0,062	0,067	0,075			
S	1	0,75 x D1	50	60	70	fz	0,014	0,019	0,025	0,030	0,041	0,050	0,058	0,065	0,072	0,078	0,083	0,094			
	2	0,75 x D1	50	55	65	fz	0,012	0,016	0,020	0,024	0,033	0,040	0,046	0,052	0,058	0,062	0,067	0,075			
	3	0,5 x D1	25	27	30	fz	0,008	0,010	0,013	0,016	0,022	0,026	0,031	0,035	0,038	0,042	0,045	0,051			
	4	1,25 x D1	50	52	55	fz	0,009	0,013	0,017	0,021	0,030	0,037	0,043	0,048	0,053	0,057	0,061	0,069			
H	1	1,0 x D1	80	95	110	fz	0,013	0,018	0,022	0,027	0,037	0,045	0,051	0,058	0,063	0,068	0,073	0,080			
	2	1,0 x D1	70	80	90	fz	0,010	0,013	0,017	0,020	0,028	0,033	0,038	0,043	0,047	0,050	0,053	0,059			

Material Group	Max Depth	Helical Interpolation/Ramping		WS15PE		mm min-max	Recommended feed per tooth (fz = mm/z) for Helical Interpolation and Ramping — fz x 2														
		30°-45°		Cutting Speed — vc m/min			Diameter — D1 [Ømin – Ømax]														
		min	Start	min	max		3,0	4,0	5,0	6,0	8,0	10,0	12,0	14,0	16,0	18,0	20,0	25,0			
							3,5-5,7	4,6-7,6	5,8-9,5	6,9-11,4	9,2-15,2	11,5-19,0	13,8-22,8	16,1-26,6	18,4-30,4	20,7-34,2	23,0-38,0	28,8-47,5			
P	0	1,25 x D1	140	150	165	fz	0,014	0,019	0,024	0,029	0,040	0,048	0,055	0,061	0,067	0,071	0,075	0,082			
	1	1,25 x D1	140	150	165	fz	0,014	0,019	0,024	0,029	0,040	0,048	0,055	0,061	0,067	0,071	0,075	0,082			
	2	1,25 x D1	140	150	165	fz	0,014	0,019	0,024	0,029	0,040	0,048	0,055	0,061	0,067	0,071	0,075	0,082			
	3	1,25 x D1	105	115	120	fz	0,011	0,015	0,020	0,024	0,033	0,040	0,046	0,052	0,058	0,062	0,067	0,075			
	4	1,25 x D1	90	100	110	fz	0,011	0,014	0,018	0,022	0,030	0,036	0,041	0,046	0,051	0,055	0,058	0,064			
	5	1,25 x D1	70	75	80	fz	0,009	0,013	0,016	0,019	0,026	0,032	0,037	0,042	0,046	0,050	0,053	0,060			
M	1	1,25 x D1	55	60	65	fz	0,008	0,011	0,013	0,016	0,022	0,027	0,031	0,034	0,038	0,040	0,043	0,047			
	1	1,25 x D1	75	85	90	fz	0,011	0,015	0,020	0,024	0,033	0,040	0,046	0,052	0,058	0,062	0,067	0,075			
	2	1,25 x D1	50	55	60	fz	0,009	0,013	0,016	0,019	0,026	0,032	0,037	0,042	0,046	0,050	0,053	0,060			
K	1	1,0 x D1	45	50	55	fz	0,008	0,011	0,013	0,016	0,022	0,027	0,031	0,034	0,038	0,040	0,043	0,047			
	1	1,0 x D1	110	120	130	fz	0,014	0,019	0,024	0,029	0,040	0,048	0,055	0,061	0,067	0,071	0,075	0,082			
	2	1,0 x D1	100	110	120	fz	0,011	0,015	0,020	0,024	0,033	0,040	0,046	0,052	0,058	0,062	0,067	0,075			
S	1	1,0 x D1	90	100	110	fz	0,009	0,013	0,016	0,019	0,026	0,032	0,037	0,042	0,046	0,050	0,053	0,060			
	1	0,75 x D1	80	85	90	fz	0,011	0,015	0,020	0,024	0,033	0,040	0,046	0,052	0,058	0,062	0,067	0,075			
	2	0,75 x D1	55	60	65	fz	0,009	0,013	0,016	0,019	0,026	0,032	0,037	0,042	0,046	0,050	0,053	0,060			
	3	0,5 x D1	20	25	28	fz	0,006	0,008	0,011	0,013	0,017	0,021	0,025	0,028	0,031	0,033	0,036	0,040			
H	1	1,25 x D1	35	40	45	fz	0,008	0,010	0,014	0,017	0,024	0,029	0,034	0,038	0,042	0,046	0,049	0,055			
	2	1,0 x D1	75	80	85	fz	0,011	0,014	0,018	0,022	0,030	0,036	0,041	0,046	0,051	0,055	0,058	0,064			
H	2	1,0 x D1	65	70	75	fz	0,008	0,011	0,013	0,016	0,022	0,027	0,031	0,034	0,038	0,040	0,043	0,047			

VARIMILL™ XTREME™ • PLUNGING/DRILLING • APPLICATION DATA • METRIC

Material Group	 																			
	Plunging/Drilling			Recommended feed per revolution (fn =mm/rev) for Plunging and Drilling																
				WS15PE Cutting Speed – vc m/min			D1 – Diameter													
	Max Depth	Applicable	Coolant	min	Start	max	mm	3,0	4,0	5,0	6,0	8,0	10,0	12,0	14,0	16,0	18,0	20,0	25,0	
P	0	1,5 x D	●	Preferred	140	150	165	fn	0,033	0,040	0,045	0,055	0,065	0,080	0,095	0,110	0,120	0,140	0,160	0,180
	1	1,5 x D	●	Required	140	150	165	fn	0,033	0,040	0,045	0,055	0,065	0,080	0,095	0,110	0,120	0,140	0,160	0,180
	2	1,5 x D	●	Required	140	150	165	fn	0,033	0,040	0,045	0,055	0,065	0,080	0,095	0,110	0,120	0,140	0,160	0,180
	3	1 x D	●	Required	105	115	120	fn	0,020	0,028	0,033	0,040	0,050	0,060	0,070	0,085	0,100	0,110	0,125	0,150
	4	1 x D	●	Required	90	100	110	fn	0,020	0,028	0,033	0,040	0,050	0,060	0,070	0,085	0,100	0,110	0,125	0,150
	5	0,5 x D	●	Required	70	75	80	fn	0,014	0,018	0,020	0,025	0,035	0,040	0,050	0,055	0,065	0,075	0,085	0,100
M	6	0,5 x D	●	Required	55	60	65	fn	0,014	0,018	0,020	0,025	0,035	0,040	0,050	0,055	0,065	0,075	0,085	0,100
	1	0,75 x D	●	Required	75	85	90	fn	0,020	0,028	0,033	0,040	0,050	0,060	0,070	0,085	0,100	0,110	0,125	0,150
	2	0,5 x D	●	Required	50	55	60	fn	0,014	0,018	0,020	0,025	0,035	0,040	0,050	0,055	0,065	0,075	0,085	0,100
K	3	0,5 x D	●	Required	45	50	55	fn	0,014	0,018	0,020	0,025	0,035	0,040	0,050	0,055	0,065	0,075	0,085	0,100
	1	1,5 x D	●	Preferred	110	120	130	fn	0,033	0,040	0,045	0,055	0,065	0,080	0,095	0,110	0,120	0,140	0,160	0,180
	2	1 x D	●	Required	100	110	120	fn	0,020	0,028	0,033	0,040	0,050	0,060	0,070	0,085	0,100	0,110	0,125	0,150
S	3	1 x D	●	Required	90	100	110	fn	0,020	0,028	0,033	0,040	0,050	0,060	0,070	0,085	0,100	0,110	0,125	0,150
	1	0,3 x D	○	Required	80	85	90	fn	0,020	0,028	0,033	0,040	0,050	0,060	0,070	0,085	0,100	0,110	0,125	0,150
	2	0,1 x D	○	Required	55	60	65	fn	0,014	0,018	0,020	0,025	0,035	0,040	0,050	0,055	0,065	0,075	0,085	0,100
	3	0,1 x D	○	Required	20	25	28	fn	0,010	0,012	0,015	0,018	0,022	0,028	0,033	0,040	0,045	0,050	0,060	0,070
H	4	0,2 x D	○	Required	35	40	45	fn	0,014	0,018	0,020	0,025	0,035	0,040	0,050	0,055	0,065	0,075	0,085	0,100
	1	0,3 x D	○	Required	75	80	85	fn	0,020	0,028	0,033	0,040	0,050	0,060	0,070	0,085	0,100	0,110	0,125	0,150
	2	0,2 x D	○	Required	65	70	75	fn	0,014	0,018	0,020	0,025	0,035	0,040	0,050	0,055	0,065	0,075	0,085	0,100

VARIMILL™ XTREME™ • ADJUSTMENT FACTOR TABLE FOR FEED CALCULATION

Metric

To calculate application-specific cutting data, please use KV coefficient table to the right for adaptation of cutting speed and KFz for feed, respectively.

$Vc_{new} = Vc \cdot Kv$
 $Fz_{new} = IPT \cdot KFz$

Calculation example:

Application: D = 20mm; M2 material group;
 Ae = 2mm
 Cutting data recommendation: Vc = 80 m/min;
 fz = 0,089 mm/th
 Adjustment coefficients: Ae = 2mm equals 10,0%;
 Kv = 1,35; KFz = 1,7

Final cutting data recommendation:

$Vc_{new} = 80 \cdot 1,35 = 108 \text{ m/min}$
 $Fz_{new} = 0,089 \cdot 1,7 = 0,15 \text{ mm/min}$

	Ae/D	2%	4%	5%	8%	10%	20%	30%	40%	50%
Speed factor	Kv	2	1,5	1,45	1,4	1,35	1,25	1,2	1	1
Feed factor	KFz	2,4	2,3	2,2	2	1,7	1,25	1,02	1	1

ALUFLASH™

*High-Performance Solid End Milling
for Aluminum*



Materials

N

Applications



Slotting



Side Milling/
Shoulder Milling



Ramping



Helical
Interpolation



Plunge Milling



Trochoidal Milling



Drilling

UNCOATED

2- and 3-flute solid carbide end mill.
Diameter Range: 1mm–20mm (1/8-1")





Built-in features to enable accelerated aluminum machining.

Balanced by design
to guarantee limited vibration and a low spindle load at very high RPMs.

“W” flute shape
for improved chip formation and evacuation, increasing process security.

Parabolic core
for increased tool stability and reduced deflection and risk of breakage.

Double/Triple rake gashing
for improved chip evacuation and higher ramping capabilities and Z-axis machining.



ALUFLASH • CATALOG NUMBERING SYSTEM

Each character in our catalog number signifies a specific trait of that product. Use the following key columns and corresponding images to easily identify which attributes apply.

3AN9M12006RJT

3A	N	9	M	120	0	6	R	J	T
Platform	Neck and Cutting Length	Shape/ Application	UOM	Cutting Diameter	Overall Length	Shank Size	Corner Style	Corner Size	Shank Style
2A = ALUFLASH 2 Flutes 3A = ALUFLASH 3 Flutes	0 = No Neck and Regular Cutting Length (approx 2 x D) 1 = No Neck - Long Cutting Length (approx 3 x D) 2 = No Neck - Longer Cutting Length (approx 5 x D) 3 = No Neck - Extended Cutting Length (approx 7 x D) N = Regular Neck approx 3 x D - Regular Cutting Length (approx 2 x D) L = Long Neck approx 4 x D - Regular Cutting Length (approx 2 x D) F = Extended Neck approx 5 x D - Regular Cutting Length (approx 2 x D) P = Neck - Longer Cutting Length (approx 3 x D) R = Neck - Extended Cutting Length (approx 5 x D)	9 = Specific for ISO N	M = Metric E = Inch	010 = 1.00mm 015 = 1.50mm 020 = 2.00mm 025 = 2.50mm 030 = 3.00mm (1/8") 035 = 3.50mm 040 = 4.00mm 045 = 4.50mm 050 = 5.00mm (3/16") 060 = 6.00mm 070 = 7.00mm (1/4") 080 = 8.00mm (5/16") 090 = 9.00mm 100 = 10.00mm (3/8") 110 = 7/16" 120 = 12mm 130 = 1/2" 160 = 16.00mm (5/8") 180 = 18.00mm 190 = 3/4" 200 = 20.00mm 250 = 25.00mm (1")	0 = Regular 1 = Extended 2 = Long 3 = Extra Long 4 = Stub	0 = 3.00mm (1/8") 1 = 4.00mm (3/16") 2 = 5.00mm 3 = 6.00mm (1/4") 4 = 8.00mm (5/16") 5 = 10.00mm (3/8") 6 = 12.00mm (1/2") 7 = 14.00mm 8 = 16.00mm (5/8") 9 = 20.00mm (3/4") A = 25.00mm (1")	S = Sharp R = Radius C = Chamfer G = Chamfer End Mill F = Concave Radius	Z = Sharp A = 0.20mm (.015") Y = 0.25mm (.017") E = 0.50mm (.030") G = 0.75mm (.060") J = 1.00mm (.090") H = 1.50mm (.010") K = 2.00mm (.120") M = 2.50mm (.160") P = 3.00mm (.190") Q = 4.00mm (.250") R = 5.00mm (.375") D = 6.00mm (.450") X = Special	T = Cylindrical

**ALUFLASH SERIES 2A09 • SQUARE END • 2 FLUTE •
REGULAR LENGTH • CYLINDRICAL SHANK • METRIC**

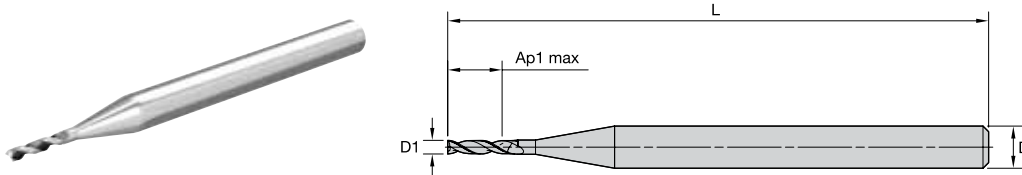

grade UNCOATED

order #	catalogue #	D1	D	length of cut Ap1 max	length L	Z U
6853514	2A09M01000SZT	1,0	3	4,00	38	2
6853515	2A09M01500SZT	1,5	3	6,00	38	2
6853517	2A09M02000SZT	2,0	3	8,00	38	2
6853519	2A09M02500SZT	2,5	3	9,00	38	2
6853542	2A09M04001SZT	4,0	4	12,00	50	2
6853544	2A09M05002SZT	5,0	5	14,00	50	2
6853547	2A09M06003SZT	6,0	6	16,00	50	2
6853549	2A09M08004SZT	8,0	8	20,00	63	2
6853552	2A09M12006SZT	12,0	12	25,00	76	2
6853554	2A09M16008SZT	16,0	16	32,00	89	2
6853556	2A09M20009SZT	20,0	20	40,00	104	2

**ALUFLASH SERIES 2A09 • RADIUS • 2 FLUTE •
REGULAR LENGTH • CYLINDRICAL SHANK • METRIC**

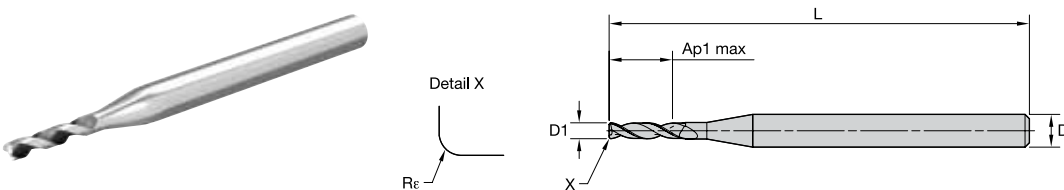

grade UNCOATED

order #	catalogue #	D1	D	length of cut Ap1 max	length L	Re	Z U
6853516	2A09M01500RAT	1,5	3	6,00	38	0,20	2
6853518	2A09M02000RAT	2,0	3	8,00	38	0,20	2
6853520	2A09M02500RAT	2,5	3	9,00	38	0,20	2
6853541	2A09M03000RAT	3,0	3	12,00	38	0,20	2
6853543	2A09M04001RAT	4,0	4	12,00	50	0,20	2
6853546	2A09M05002RAT	5,0	5	14,00	50	0,20	2
6853548	2A09M06003RET	6,0	6	16,00	50	0,50	2
6853550	2A09M08004RET	8,0	8	20,00	63	0,50	2
6853551	2A09M10005RJT	10,0	10	22,00	76	1,00	2
6853553	2A09M12006RJT	12,0	12	25,00	76	1,00	2
6853555	2A09M16008RJT	16,0	16	32,00	89	1,00	2
6853557	2A09M20009RJT	20,0	20	40,00	104	1,00	2

ALUFLASH SERIES 3A09 • SQUARE END • 3 FLUTE • REGULAR LENGTH • CYLINDRICAL SHANK • METRIC

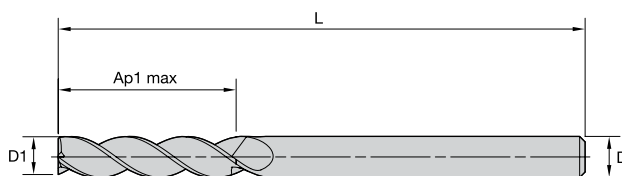

grade UNCOATED

order #	catalogue #	D1	D	length of cut Ap1 max	length L	Z U
6853511	3A09M03000SZT	3,0	3	12,00	38	3

ALUFLASH SERIES 3A09 • RADIUS • 3 FLUTE • REGULAR LENGTH • CYLINDRICAL SHANK • METRIC

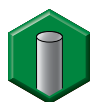
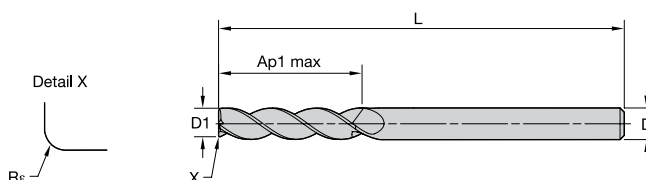

grade UNCOATED

order #	catalogue #	D1	D	length of cut Ap1 max	length L	Re	Z U
6853512	3A09M03000RAT	3,0	3	12,00	38	0,20	3
6853513	3A09M04001RET	4,0	4	12,00	63	0,50	3

**ALUFLASH SERIES 3AN9 • SQUARE END • 3 FLUTE •
REGULAR LENGTH • REGULAR NECK • CYLINDRICAL SHANK • METRIC**

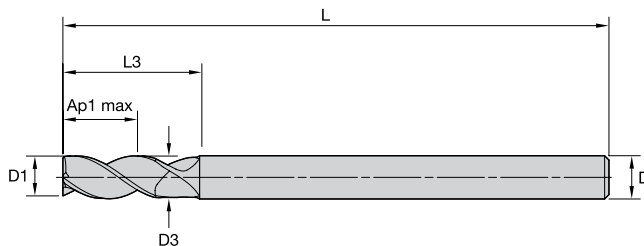

grade UNCOATED

order #	catalogue #	D1	D	D3	length of cut Ap1 max	length L	L3	Z U
6853460	3AN9M04001SZT	4,0	4	3,76	8,00	50	12,00	3
6853462	3AN9M05002SZT	5,0	5	4,70	10,00	63	15,00	3
6853465	3AN9M06003SZT	6,0	6	5,64	13,00	63	18,00	3
6853469	3AN9M08004SZT	8,0	8	7,52	18,00	76	24,00	3
6853474	3AN9M10005SZT	10,0	10	9,40	22,00	76	30,00	3
6853479	3AN9M12006SZT	12,0	12	11,28	25,00	76	36,00	3
6853486	3AN9M16008SZT	16,0	16	15,04	32,00	89	48,00	3
6853494	3AN9M20009SZT	20,0	20	18,80	40,00	115	60,00	3

ALUFLASH SERIES 3AN9 • RADIUS • 3 FLUTE • REGULAR LENGTH • REGULAR NECK • CYLINDRICAL SHANK • METRIC

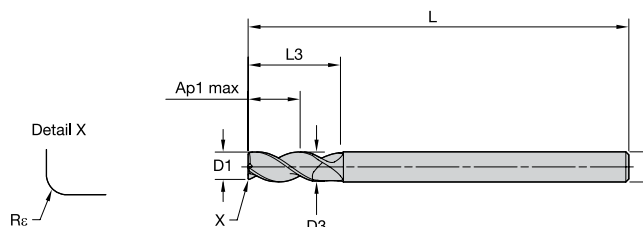

grade UNCOATED

order #	catalogue #	D1	D	D3	length of cut Ap1 max	length L	L3	Rε	Z U
6853461	3AN9M04001RAT	4,0	4	3,76	8,00	50	12,00	0,20	3
6853463	3AN9M05002RAT	5,0	5	4,70	10,00	63	15,00	0,20	3
6853464	3AN9M05002RET	5,0	5	4,70	10,00	63	15,00	0,50	3
6853466	3AN9M06003RAT	6,0	6	5,64	13,00	63	18,00	0,20	3
6853467	3AN9M06003RET	6,0	6	5,64	13,00	63	18,00	0,50	3
6853468	3AN9M06003RJT	6,0	6	5,64	13,00	63	18,00	1,00	3
6853470	3AN9M08004RAT	8,0	8	7,52	18,00	76	24,00	0,20	3
6853471	3AN9M08004RET	8,0	8	7,52	18,00	76	24,00	0,50	3
6853473	3AN9M08004RHT	8,0	8	7,52	18,00	76	24,00	1,50	3
6853472	3AN9M08004RJT	8,0	8	7,52	18,00	76	24,00	1,00	3
6853475	3AN9M10005RAT	10,0	10	9,40	22,00	76	30,00	0,20	3
6853476	3AN9M10005RET	10,0	10	9,40	22,00	76	30,00	0,50	3
6853478	3AN9M10005RHT	10,0	10	9,40	22,00	76	30,00	1,50	3
6853477	3AN9M10005RJT	10,0	10	9,40	22,00	76	30,00	1,00	3
6853480	3AN9M12006RAT	12,0	12	11,28	25,00	76	36,00	0,20	3
6853481	3AN9M12006RET	12,0	12	11,28	25,00	76	36,00	0,50	3
6853483	3AN9M12006RHT	12,0	12	11,28	25,00	76	36,00	1,50	3
6853482	3AN9M12006RJT	12,0	12	11,28	25,00	76	36,00	1,00	3
6853484	3AN9M12006RKT	12,0	12	11,28	25,00	76	36,00	2,00	3
6853485	3AN9M12006RPT	12,0	12	11,28	25,00	76	36,00	3,00	3
6853487	3AN9M16008RAT	16,0	16	15,04	32,00	89	48,00	0,20	3
6853488	3AN9M16008RET	16,0	16	15,04	32,00	89	48,00	0,50	3
6853490	3AN9M16008RHT	16,0	16	15,04	32,00	89	48,00	1,50	3
6853489	3AN9M16008RJT	16,0	16	15,04	32,00	89	48,00	1,00	3
6853491	3AN9M16008RMT	16,0	16	15,04	32,00	89	48,00	2,50	3
6853492	3AN9M16008RPT	16,0	16	15,04	32,00	89	48,00	3,00	3
6853493	3AN9M16008RQT	16,0	16	15,04	32,00	89	48,00	4,00	3
6853495	3AN9M20009RAT	20,0	20	18,80	40,00	115	60,00	0,20	3
6853496	3AN9M20009RHT	20,0	20	18,80	40,00	115	60,00	1,50	3
6853497	3AN9M20009RKT	20,0	20	18,80	40,00	115	60,00	2,00	3
6853498	3AN9M20009RPT	20,0	20	18,80	40,00	115	60,00	3,00	3
6853499	3AN9M20009RQT	20,0	20	18,80	40,00	115	60,00	4,00	3
6853500	3AN9M20009RRT	20,0	20	18,80	40,00	115	60,00	5,00	3

**ALUFLASH SERIES 3AP9 • SQUARE END • 3 FLUTE •
LONG LENGTH • REGULAR NECK • CYLINDRICAL SHANK • METRIC**

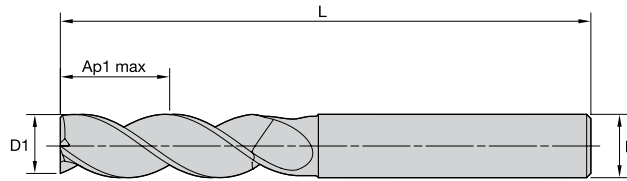

grade UNCOATED

order #	catalogue #	D1	D	D3	length of cut Ap1 max	length L	L3	Z U
6853448	3AP9M12016SZT	12,0	12	11,28	36,00	100	48,00	3

**ALUFLASH SERIES 3AP9 • RADIUS • 3 FLUTE •
LONG LENGTH • REGULAR NECK • CYLINDRICAL SHANK • METRIC**

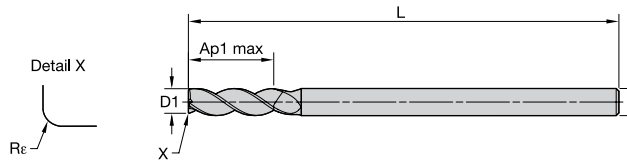

grade UNCOATED

order #	catalogue #	D1	D	D3	length of cut Ap1 max	length L	L3	Rε	Z U
6853439	3AP9M04011RAT	4,0	4	3,76	12,00	63	16,00	0,20	3
6853440	3AP9M05002RAT	5,0	5	4,70	15,00	63	20,00	0,20	3
6853441	3AP9M06013RET	6,0	6	5,64	18,00	76	24,00	0,50	3
6853442	3AP9M06013RJT	6,0	6	5,64	18,00	76	24,00	1,00	3
6853443	3AP9M08014RET	8,0	8	7,52	24,00	76	32,00	0,50	3
6853444	3AP9M08014RJT	8,0	8	7,52	24,00	76	32,00	1,00	3
6853445	3AP9M10015RET	10,0	10	9,40	30,00	89	40,00	0,50	3
6853446	3AP9M10015RHT	10,0	10	9,40	30,00	89	40,00	1,50	3
6853447	3AP9M10015RKT	10,0	10	9,40	30,00	89	40,00	2,00	3
6853449	3AP9M12016RET	12,0	12	11,28	36,00	100	48,00	0,50	3
6853450	3AP9M12016RHT	12,0	12	11,28	36,00	100	48,00	1,50	3
6853451	3AP9M12016RPT	12,0	12	11,28	36,00	100	48,00	3,00	3
6853452	3AP9M16018RET	16,0	16	15,04	48,00	110	64,00	0,50	3
6853453	3AP9M16018RHT	16,0	16	15,04	48,00	110	64,00	1,50	3
6853454	3AP9M16018RPT	16,0	16	15,04	48,00	110	64,00	3,00	3
6853455	3AP9M20019RET	20,0	20	18,80	60,00	150	80,00	0,50	3
6853456	3AP9M20019RHT	20,0	20	18,80	60,00	150	80,00	1,50	3
6853457	3AP9M20019RKT	20,0	20	18,80	60,00	150	80,00	2,00	3
6853458	3AP9M20019RPT	20,0	20	18,80	60,00	150	80,00	3,00	3
6853459	3AP9M20019RQT	20,0	20	18,80	60,00	150	80,00	4,00	3



ALUFLASH • SIDE MILLING AND SLOTTING • APPLICATION DATA • METRIC

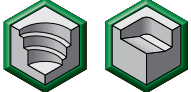
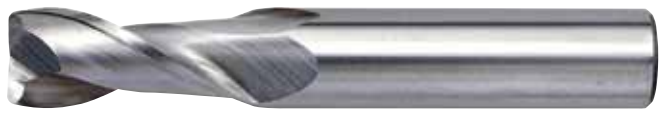

		Side Milling (A) and Slotting (B)			UNCOATED			Recommended feed per tooth (fz = mm/z) for side milling (A). For slotting (B), reduce fz by 20%.													
		A		B	Cutting Speed – Vc m/min			D1 – Diameter													
Material Group		ap	ae	ap	min	Start	max	mm	2.0	4.0	5.0	6.0	8.0	10.0	12.0	14.0	16.0	18.0	20.0	25.0	
N	1	Ap1 max	0,5 x D1	1 x D	500	600	2000	fz	0.022	0.044	0.055	0.066	0.088	0.110	0.132	0.153	0.176	0.198	0.220	0.275	
	2	Ap1 max	0,5 x D1	1 x D	500	600	1500	fz	0.020	0.040	0.048	0.059	0.079	0.099	0.119	0.138	0.158	0.178	0.198	0.247	
	3	Ap1 max	0,5 x D1	1 x D	500	600	1500	fz	0.015	0.031	0.038	0.046	0.062	0.077	0.092	0.107	0.123	0.138	0.154	0.192	
	4	Ap1 max	0,5 x D1	1 x D	400	450	750	fz	0.015	0.031	0.038	0.046	0.062	0.077	0.092	0.107	0.123	0.138	0.154	0.192	
	5	Ap1 max	0,5 x D1	1 x D	250	400	1000	fz	0.020	0.040	0.050	0.059	0.079	0.099	0.119	0.138	0.158	0.178	0.198	0.247	

		Side Milling (A) and Slotting (B)			UNCOATED			Recommended feed per tooth (fz = mm/z) for side milling (A). For slotting (B), reduce fz by 20%.													
		A		B	Cutting Speed – Vc m/min			D1 – Diameter													
Material Group		ap	ae	ap	min	Start	max	mm	2.0	4.0	5.0	6.0	8.0	10.0	12.0	14.0	16.0	18.0	20.0	25.0	
N	1	Ap1 max	0,5 x D1	1 x D	500	600	2000	fz	0.022	0.044	0.055	0.066	0.088	0.110	0.132	0.153	0.176	0.198	0.220	0.275	
	2	Ap1 max	0,5 x D1	1 x D	500	600	1500	fz	0.020	0.040	0.048	0.059	0.079	0.099	0.119	0.138	0.158	0.178	0.198	0.247	
	3	Ap1 max	0,5 x D1	1 x D	500	600	1500	fz	0.015	0.031	0.038	0.046	0.062	0.077	0.092	0.107	0.123	0.138	0.154	0.192	
	4	Ap1 max	0,5 x D1	1 x D	400	450	750	fz	0.015	0.031	0.038	0.046	0.062	0.077	0.092	0.107	0.123	0.138	0.154	0.192	
	5	Ap1 max	0,5 x D1	1 x D	250	400	1000	fz	0.020	0.040	0.050	0.059	0.079	0.099	0.119	0.138	0.158	0.178	0.198	0.247	

ALUFLASH • RAMPING 2FL • APPLICATION DATA • METRIC

Material Group	Helical Interpolation / Ramping 0° - 15°																	
		UNCOATED			Recommended feed per tooth (fz = mm/z) for Helical Interpolation and Ramping													
		Cutting Speed – Vc m/min			Diameter – D1 [Ømin–Ømax]													
		Max Depth	min	Start	max	mm	3.0	4.0	5.0	6.0	8.0	10.0	12.0	14.0	16.0	18.0	20.0	25.0
				mm	2.5-4.8	4.6-7.6	5.8-9.5	6.9-11.4	9.2-15.2	11.5-19.0	13.8-22.8	16.1-26.6	18.4-30.4	20.7-34.2	23.0-38.0	28.8-47.5		
N	1	1,25 x D1	500	600	2000	fz	0.022	0.044	0.055	0.066	0.088	0.110	0.132	0.153	0.176	0.198	0.220	0.275
	2	1,25 x D1	500	600	1500	fz	0.020	0.040	0.048	0.059	0.079	0.099	0.119	0.138	0.158	0.178	0.198	0.247
	3	1,25 x D1	500	600	1500	fz	0.015	0.031	0.038	0.046	0.062	0.077	0.092	0.107	0.123	0.138	0.154	0.192
	4	1,25 x D1	400	450	750	fz	0.015	0.031	0.038	0.046	0.062	0.077	0.092	0.107	0.123	0.138	0.154	0.192
	5	1,25 x D1	250	400	1000	fz	0.020	0.040	0.050	0.059	0.079	0.099	0.119	0.138	0.158	0.178	0.198	0.247

Material Group	Helical Interpolation / Ramping 15° - 30°																	
		UNCOATED			Recommended feed per tooth (fz = mm/z) for Helical Interpolation and Ramping													
		Cutting Speed – Vc m/min			Diameter – D1 [Ømin–Ømax]													
		Max Depth	min	Start	max	mm	3.0	4.0	5.0	6.0	8.0	10.0	12.0	14.0	16.0	18.0	20.0	25.0
				mm	2.5-4.8	4.6-7.6	5.8-9.5	6.9-11.4	9.2-15.2	11.5-19.0	13.8-22.8	16.1-26.6	18.4-30.4	20.7-34.2	23.0-38.0	28.8-47.5		
N	1	1,25 x D1	500	600	1600	fz	0.017	0.033	0.041	0.050	0.066	0.082	0.099	0.115	0.132	0.148	0.165	0.206
	2	1,25 x D1	500	600	1200	fz	0.015	0.030	0.036	0.045	0.059	0.074	0.089	0.104	0.119	0.134	0.148	0.185
	3	1,25 x D1	500	600	1200	fz	0.012	0.023	0.029	0.035	0.046	0.058	0.069	0.080	0.092	0.104	0.115	0.144
	4	1,25 x D1	400	450	600	fz	0.012	0.023	0.029	0.035	0.046	0.058	0.069	0.080	0.092	0.104	0.115	0.144
	5	1,25 x D1	250	400	800	fz	0.015	0.030	0.038	0.045	0.059	0.074	0.089	0.104	0.119	0.134	0.148	0.185

Material Group	Helical Interpolation / Ramping 30° - 45°																	
		UNCOATED			Recommended feed per tooth (fz = mm/z) for Helical Interpolation and Ramping													
		Cutting Speed – Vc m/min			Diameter – D1 [Ømin–Ømax]													
		Max Depth	min	Start	max	mm	3.0	4.0	5.0	6.0	8.0	10.0	12.0	14.0	16.0	18.0	20.0	25.0
				mm	2.5-4.8	4.6-7.6	5.8-9.5	6.9-11.4	9.2-15.2	11.5-19.0	13.8-22.8	16.1-26.6	18.4-30.4	20.7-34.2	23.0-38.0	28.8-47.5		
N	1	1,25 x D1	420	500	800	fz	0.013	0.026	0.033	0.040	0.053	0.066	0.079	0.092	0.106	0.119	0.132	0.165
	2	1,25 x D1	420	500	800	fz	0.012	0.024	0.029	0.036	0.048	0.059	0.071	0.083	0.095	0.107	0.119	0.148
	3	1,25 x D1	420	500	800	fz	0.009	0.018	0.023	0.028	0.037	0.046	0.055	0.064	0.074	0.083	0.092	0.115
	4	1,25 x D1	340	380	450	fz	0.009	0.018	0.023	0.028	0.037	0.046	0.055	0.064	0.074	0.083	0.092	0.115
	5	1,25 x D1	210	340	600	fz	0.012	0.024	0.030	0.036	0.048	0.059	0.071	0.083	0.095	0.107	0.119	0.148





ALUFLASH • RAMPING 3FL • APPLICATION DATA • METRIC

		Helical Interpolation / Ramping 0° - 15°			UNCOATED													
					Recommended feed per tooth (fz = mm/z) for Helical Interpolation and Ramping – fz x 1													
		Cutting Speed – Vc m/min			Diameter – D1 [Ømin-Ømax]													
Material Group	Max Depth	min	Start	max	mm	3.0	4.0	5.0	6.0	8.0	10.0	12.0	14.0	16.0	18.0	20.0	25.0	
					mm	2.5-4.8	4.6-7.6	5.8-9.5	6.9-11.4	9.2-15.2	11.5-19.0	13.8-22.8	16.1-26.6	18.4-30.4	20.7-34.2	23.0-38.0	28.8-47.5	
N	1	1,25 x D1	500	600	2000	fz	0.022	0.044	0.055	0.066	0.088	0.110	0.132	0.153	0.176	0.198	0.220	0.275
	2	1,25 x D1	500	600	1500	fz	0.020	0.040	0.048	0.059	0.079	0.099	0.119	0.138	0.158	0.178	0.198	0.247
	3	1,25 x D1	500	600	1500	fz	0.015	0.031	0.038	0.046	0.062	0.077	0.092	0.107	0.123	0.138	0.154	0.192
	4	1,25 x D1	400	450	750	fz	0.015	0.031	0.038	0.046	0.062	0.077	0.092	0.107	0.123	0.138	0.154	0.192
	5	1,25 x D1	250	400	1000	fz	0.020	0.040	0.050	0.059	0.079	0.099	0.119	0.138	0.158	0.178	0.198	0.247

		Helical Interpolation / Ramping 15° - 30°			UNCOATED													
					Recommended feed per tooth (fz = mm/z) for Helical Interpolation and Ramping – fz x 1													
		Cutting Speed – Vc m/min			Diameter – D1 [Ømin-Ømax]													
Material Group	Max Depth	min	Start	max	mm	3.0	4.0	5.0	6.0	8.0	10.0	12.0	14.0	16.0	18.0	20.0	25.0	
					mm	2.5-4.8	4.6-7.6	5.8-9.5	6.9-11.4	9.2-15.2	11.5-19.0	13.8-22.8	16.1-26.6	18.4-30.4	20.7-34.2	23.0-38.0	28.8-47.5	
N	1	1,25 x D1	500	600	1600	fz	0.017	0.033	0.041	0.050	0.066	0.082	0.099	0.115	0.132	0.148	0.165	0.206
	2	1,25 x D1	500	600	1200	fz	0.015	0.030	0.036	0.045	0.059	0.074	0.089	0.104	0.119	0.134	0.148	0.185
	3	1,25 x D1	500	600	1200	fz	0.012	0.023	0.029	0.035	0.046	0.058	0.069	0.080	0.092	0.104	0.115	0.144
	4	1,25 x D1	400	450	600	fz	0.012	0.023	0.029	0.035	0.046	0.058	0.069	0.080	0.092	0.104	0.115	0.144
	5	1,25 x D1	250	400	800	fz	0.015	0.030	0.038	0.045	0.059	0.074	0.089	0.104	0.119	0.134	0.148	0.185

		Helical Interpolation / Ramping 30° - 45°			UNCOATED													
					Recommended feed per tooth (fz = mm/z) for Helical Interpolation and Ramping – fz x 1													
		Cutting Speed – Vc m/min			Diameter – D1 [Ømin-Ømax]													
Material Group	Max Depth	min	Start	max	mm	3.0	4.0	5.0	6.0	8.0	10.0	12.0	14.0	16.0	18.0	20.0	25.0	
					mm	2.5-4.8	4.6-7.6	5.8-9.5	6.9-11.4	9.2-15.2	11.5-19.0	13.8-22.8	16.1-26.6	18.4-30.4	20.7-34.2	23.0-38.0	28.8-47.5	
N	1	1,25 x D1	420	500	800	fz	0.013	0.026	0.033	0.040	0.053	0.066	0.079	0.092	0.106	0.119	0.132	0.165
	2	1,25 x D1	420	500	800	fz	0.012	0.024	0.029	0.036	0.048	0.059	0.071	0.083	0.095	0.107	0.119	0.148
	3	1,25 x D1	420	500	800	fz	0.009	0.018	0.023	0.028	0.037	0.046	0.055	0.064	0.074	0.083	0.092	0.115
	4	1,25 x D1	340	380	450	fz	0.009	0.018	0.023	0.028	0.037	0.046	0.055	0.064	0.074	0.083	0.092	0.115
	5	1,25 x D1	210	340	600	fz	0.012	0.024	0.030	0.036	0.048	0.059	0.071	0.083	0.095	0.107	0.119	0.148

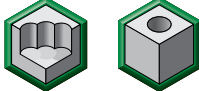
ALUFLASH • PLUNGING • APPLICATION DATA • METRIC

																				
																				Plunging/Drilling
Material Group				Cutting Speed – Vc m/min				D1 – Diameter												
				Max Depth	Applicable	Coolant	min	Start	max	mm	2.0	4.0	5.0	6.0	8.0	10.0	12.0	14.0	16.0	18.0
N	1	1,5 x D	●	Required	120	260	400	fn	0.080	0.120	0.135	0.150	0.160	0.200	0.220	0.235	0.250	0.265	0.280	0.300
	2	1,5 x D	●	Required	120	250	280	fn	0.080	0.120	0.135	0.150	0.160	0.200	0.220	0.235	0.250	0.265	0.280	0.300
	3	1,5 x D	●	Required	100	200	260	fn	0.080	0.120	0.135	0.150	0.160	0.200	0.220	0.235	0.250	0.265	0.280	0.300
	4	1 x D	●	Required	60	150	260	fn	0.060	0.080	0.100	0.120	0.140	0.160	0.200	0.210	0.220	0.235	0.250	0.280
	5	1,5 x D	●	Required	60	200	400	fn	0.080	0.120	0.135	0.150	0.160	0.200	0.220	0.235	0.250	0.265	0.280	0.300

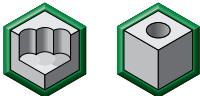
																				
																				Plunging/Drilling
Material Group				Cutting Speed – Vc m/min				D1 – Diameter												
				Max Depth	Applicable	Coolant	min	Start	max	mm	2.0	4.0	5.0	6.0	8.0	10.0	12.0	14.0	16.0	18.0
N	1	1,5 x D	●	Required	120	260	400	fn	0.056	0.084	0.095	0.105	0.112	0.140	0.154	0.165	0.175	0.186	0.196	0.210
	2	1,5 x D	●	Required	120	250	280	fn	0.056	0.084	0.095	0.105	0.112	0.140	0.154	0.165	0.175	0.186	0.196	0.210
	3	1,5 x D	●	Required	100	200	260	fn	0.056	0.084	0.095	0.105	0.112	0.140	0.154	0.165	0.175	0.186	0.196	0.210
	4	1 x D	●	Required	60	150	260	fn	0.042	0.056	0.070	0.084	0.098	0.112	0.140	0.147	0.154	0.165	0.175	0.196
	5	1,5 x D	●	Required	60	200	400	fn	0.056	0.084	0.095	0.105	0.112	0.140	0.154	0.165	0.175	0.186	0.196	0.210

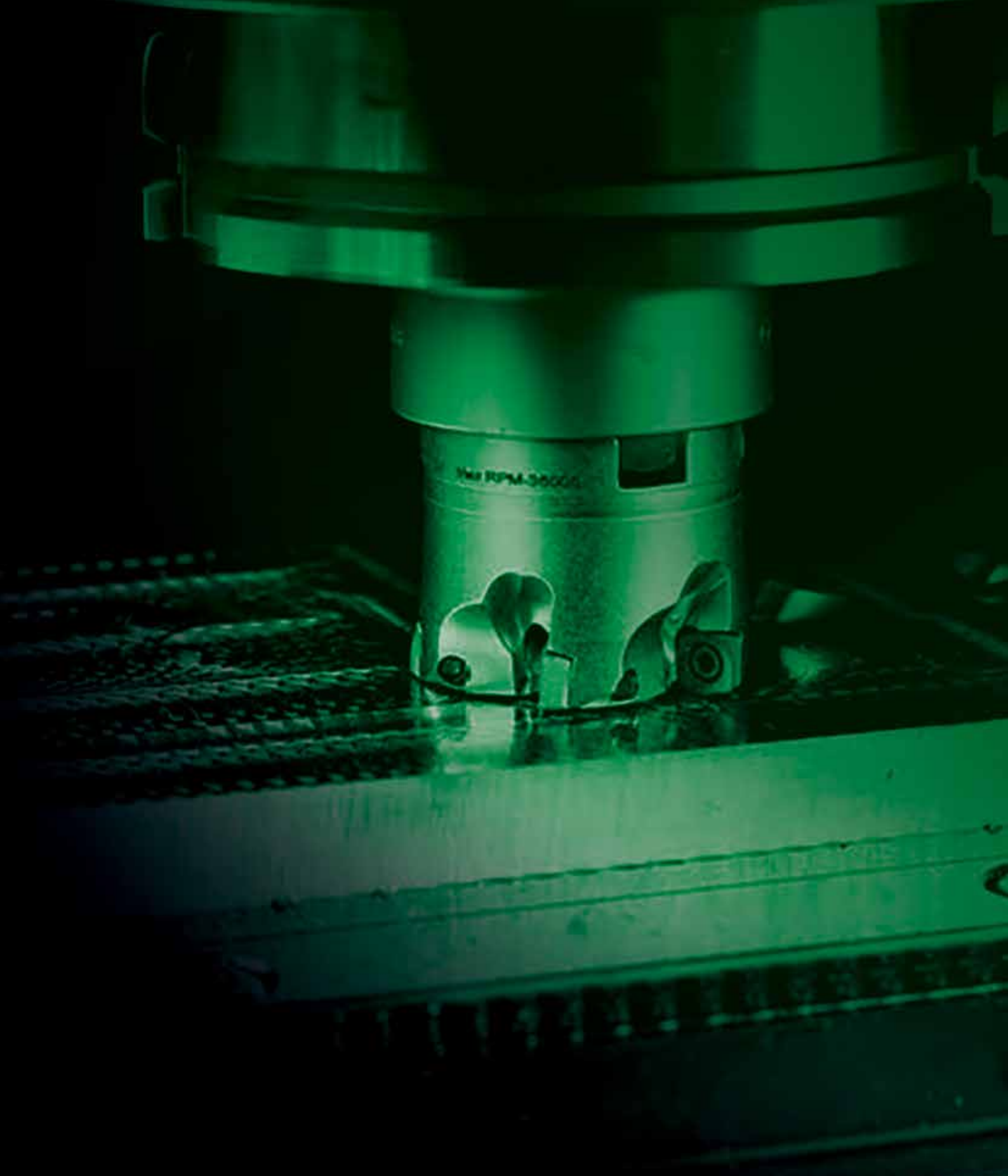

TO SEE ALL PRODUCT LINES, VISIT OUR DIGITAL RESOURCES



WIDIA NOVO™ Application
Download to your desktop or tablet:
widia.com/novo



WIDIA™ Machining Central Mobile App
Download for iOS or Android:
widia.com/en/featured/WidiaMobileApp

 youtube.com/WIDIASolutions

 linkedin.com/WIDIAProductGrp

 facebook.com/WIDIAProductGrp

To learn more, visit widia.com



Speed

The WIDIA™ brand encompasses a variety of standard tooling designed to perform well in a range of typical machine shop operations. A team of experienced application support specialists is readily available to help increase productivity in your shop via WIDIA website chat or over the phone for every step of the way.



Simplicity

Machinists can rely on the NOVO machining advisor or widia.com to easily select the right tool for the job.



Reliability

Trust our network of authorized distributors to put WIDIA tools to work for you — in your industry, in your region, and in your business. Together we will keep your machine running through the night.

For more than 90 years, the WIDIA brand has delivered quality milling, turning, holemaking, tapping, and systems tooling to metal-cutting customers across the globe. Customers experience reliability from selection to post-delivery support through product availability, digital connectivity, and an accessible network of authorized distribution partners.

Test WIDIA tooling today by selecting tools from the All-Star program. The All-Star program is comprised of proven tooling solutions that are easy to find and always available. This includes solid end mills, turning tools, drills, and taps from our most popular platforms, grades, and sizes grouped into one program and guaranteed to be in stock with same-day shipping on orders placed before 4pm ET.

Visit widia.com to see what products are available for same-day shipping through All-Star.

ALL-STAR

THE ALL-STAR PROGRAM PROVIDES PROVEN SOLUTIONS THAT ARE EASY TO FIND AND ALWAYS AVAILABLE.

All-Star includes products from our most popular platforms, grades, and sizes grouped into our program and guaranteed to be in stock with same-day shipping on orders placed before 4pm CET.

Visit widia.com to see what products are available for same-day shipping through All-Star.

Turning



Tapping



Holemaking



TO SEE ALL PRODUCT LINES, VISIT OUR DIGITAL RESOURCES



WIDIA NOVO™ Application
Download to your desktop or tablet:
widia.com/novo



WIDIA™ Machining Central Mobile App
Download for iOS or Android:
widia.com/en/featured/WidiaMobileApp

 youtube.com/WIDIASolutions

 linkedin.com/WIDIAProductGrp

 facebook.com/WIDIAProductGrp

To learn more, visit widia.com



Proven Solutions



Easy to Find

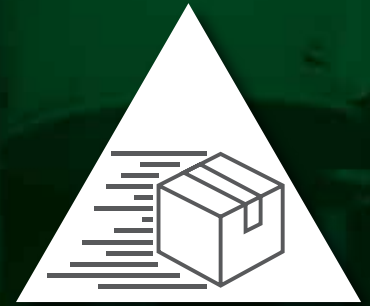

Always Available

Indexable Milling



Solid End Milling



M8065HD



HEAVY
DUTY

RELIABLE

Use the M8065HD to easily confront heavy-duty milling jobs in steel and cast-iron materials by applying deep depths of cut while consistently maintaining high metal removal rates.

M8065HD provides reliable cost savings to any machinist, starting at the price tag, ending on the spindle.





M8065HD

Shell Mills: 50-315mm

8-Edged Face Mill for Heavy-Duty Applications

- Universal SNMX15 -MM geometry insert in grades WP35CM, WU20PM, WK15CM.
- 64° approach angle of the cutter in combination with a 6.35mm thick insert.
- High DOC capability (9mm Ap1 max).
- Optimized chip gash design.

M8065HD

Face Mills • M8065HD Series



- 65° approach angle of the cutter in combination with a 6.35mm-thick insert.
- One universal geometry in latest Victory™ grades WP35CM, WK15CM, WU20PM.
- Extra wide chip gash design for efficient chip evacuation.
- PSTS insert with eight cutting edges.
- Insert with positive rake geometry.
- Large wall area on insert pocket seat stabilizing the insert seat.
- Common insert for RH & LH cutter.
- Strong insert screw (M4.5) for more secure clamping.

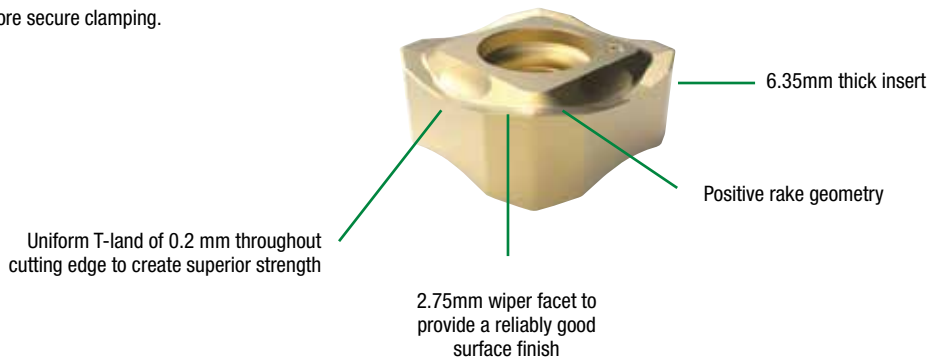

One Geometry, Three Grades

One universal geometry in the latest Victory™ grades WP35CM, WK15CM, and WU20PM. With less complexity, more materials can be machined. The proven Victory™ grades cover most target applications.

-MM



WK15CM



WK15CM is a wear-resistant grade with balanced toughness for general milling of cast irons. Best results in dry machining, but can also be used wet.

WP35CM



WP35CM has a wide range of applications in general and rough milling of steels and cast iron. Performs best in dry, but can also be used under wet conditions.

WU20PM



WU20PM is a universal grade for machining of steel, stainless steel, and high-temperature alloys. Also suitable for machining of grey and nodular irons. Resists breakage and offers improved wear resistance and increased strength. Can be used for both dry and wet machining.

M8065HD • Shell Mills • Heavy-Duty Face Milling

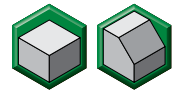
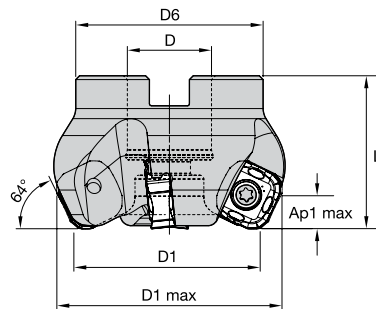

order number	catalogue number	D1	D1 max	D	D4	D6	L	Ap1 max	Z	coolant supply	kg
4124248	M8065HD050Z04S22SN15	50	58,9	22	—	49	40	9,0	4	No	0,38
4102270	M8065HD063Z05S22SN15	63	71,9	22	—	49	40	9,0	5	No	0,53
4073639	M8065HD080Z06S27SN15	80	88,8	27	—	60	50	9,0	6	No	1,15
4073640	M8065HD100Z07S32SN15	100	108,8	32	—	78	50	9,0	7	No	1,68
4039413	M8065HD125Z09S40SN15	125	133,8	40	—	89	63	9,0	9	No	3,24
4061110	M8065HD160Z11S40SN15	160	168,8	40	66,7	90	63	9,0	11	No	4,33
4113702	M8065HD200Z14S60SN15	200	208,8	60	101,6	130	63	9,0	14	No	7,13
4113753	M8065HD250Z16S60SN15	250	258,8	60	101,6	130	63	9,0	16	No	11,52
4113754	M8065HD315Z20S60SN15	315	323,8	60	101,6	225	80	9,0	20	No	27,90

Spare Parts

MM#	Description	ANSI = ISO	Required torque (Nm/in.lbs)
2018296	Insert screw M4.5 x 0.75 x 14 T20	MS-2260	4 Nm/35.4 in.lbs
1138446	T20 Torx Key	170_026	

Insert screws included but other hardware is sold separately

Cutter MM#	CAT ID	Lock Screw	Lock Screw MM#
4124248	M8065HD050Z04S22SN15	125.025	1136777
4102270	M8065HD063Z05S22SN15	125.025	1136777
4073639	M8065HD080Z06S27SN15	MS-2038	1841782
4073640	M8065HD100Z07S32SN15	KLS32MPKG (pack of 2 pcs)	1147970
4039413	M8065HD125Z09S40SN15	KLS40M	1016374
4061110	M8065HD160Z11S40SN15	PCD Holes	
4113702	M8065HD200Z14S60SN15		
4113753	M8065HD250Z16S60SN15		
4113754	M8065HD315Z20S30SN15		



M8065

Face Mills • M8065HD Series

Inserts • SNMX -MM • Heavy-Duty Face Milling

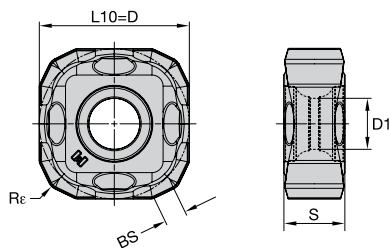

- first choice
- alternate choice

P	●	○
M	●	○
K	○	○
N	○	○
S	○	○
H	○	○

ISO catalogue number	cutting edges	D	L10	S	BS	Rε	hm	WP35CM	WK15CM	WU20PM
SNMX150612ZNSNMM	8	16	15,88	6,35	2,37	1,20	0,05	1	5649102	1
SNMX150612ZNSNMM	8	16	15,88	6,35	2,37	1,20	0,06	6852432	1	4137987

Inserts

Material Group	Light Machining		General Purpose		Heavy Machining	
	Geometry	Grade	Geometry	Grade	Geometry	Grade
P1-P2	.S..MM	WP35CM	.S..MM	WP35CM	.S..MM	WU20PM
P3-P4	.S..MM	WP35CM	.S..MM	WP35CM	.S..MM	WU20PM
P5-P6	.S..MM	WP35CM	.S..MM	WP35CM	.S..MM	WP35CM
M1-M2	.S..MM	WU20PM	.S..MM	WU20PM	.S..MM	WU20PM
M3	.S..MM	WP35CM	.S..MM	WP35CM	.S..MM	WP35CM
K1-K2	.S..MM	WK15CM	.S..MM	WK15CM	.S..MM	WU20PM
K3	.S..MM	WU20PM	.S..MM	WU20PM	.S..MM	WK15CM
N1-N2	.S..MM	WU20PM	.S..MM	WU20PM	.S..MM	WU20PM
N3	.S..MM	WU20PM	.S..MM	WU20PM	.S..MM	WU20PM
S1-S2	.S..MM	WU20PM	.S..MM	WU20PM	.S..MM	WU20PM
S3	.S..MM	WU20PM	.S..MM	WU20PM	.S..MM	WU20PM
S4	.S..MM	WP35CM	.S..MM	WU20PM	.S..MM	WU20PM
H1	.S..MM	WK15CM	-	-	-	-

Recommended Starting Feeds

Light Machining	General Purpose	Heavy Machining
-----------------	-----------------	-----------------

Insert Geometry	Programmed Feed per Tooth (fz) as a % of Radial Depth of Cut (ae)														Insert Geometry	
	5%		10%		20%		30%		40-100%							
.S..MM	0.22	0.65	1.07	0.16	0.47	0.77	0.12	0.35	0.58	0.10	0.31	0.50	0.10	0.28	0.46	.S..MM

NOTE: First choice starting feed (fz) is in **bold** type.
 Use corresponding speed (vc).
 fz and vc are valid for ae ≥ 0,4 D1.
 For smaller ae, fz and vc should be multiplied by the factor given below:



M8065

Face Mills • M8065HD Series

Recommended Starting Speeds

Material Group		WP35CM			WK15CM			WU20PM		
P	1	455	395	370	—	—	—	330	290	270
	2	280	255	230	—	—	—	275	250	200
	3	255	230	205	—	—	—	255	220	175
	4	190	175	160	—	—	—	225	190	150
	5	260	230	210	—	—	—	185	175	150
	6	160	135	—	—	—	—	165	130	100
M	1	205	185	155	—	—	—	205	180	165
	2	185	160	140	—	—	—	185	160	130
	3	145	130	115	—	—	—	140	120	95
K	1	295	265	240	420	385	340	250	220	185
	2	235	210	190	335	295	275	200	180	150
	3	195	175	160	280	250	230	180	150	120
N	1	—	—	—	—	—	—	550	470	400
	2	—	—	—	—	—	—	550	470	400
	3	—	—	—	—	—	—	400	350	300
S	1	—	—	—	—	—	—	40	35	25
	2	—	—	—	—	—	—	40	35	25
	3	—	—	—	—	—	—	50	40	25
	4	—	—	—	—	—	—	70	50	35
H	1	—	—	—	—	—	—	110	80	70

NOTE: First choice starting feed (fz) is in **bold** type.
 Use corresponding speed (vc).
 fz and vc are valid for ae ≥ 0,4 D1.
 For smaller ae, fz and vc should be multiplied by the factor given below:

WIDIA™ Digital Solutions

Tools and Resources at Your Fingertips

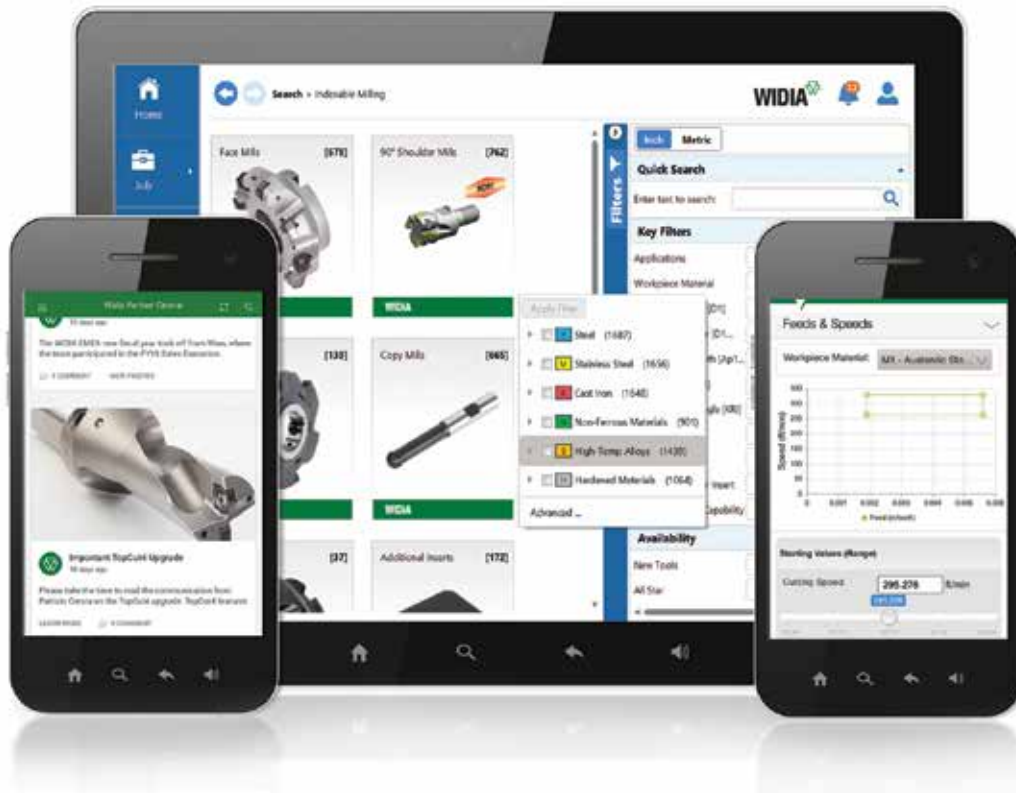

**WIDIA
Machining
Central**

PRODUCT DATA

- Tooling Dimensional Data
- Feeds and Speeds
- Inventory Availability
- ...and More!

DOWNLOAD THE **WIDIA MOBILE APPS** TODAY!



WIDIA.COM

M1200 MAX SCREW CLAMPING



M1200 Max Screw Clamping is for customers who need to run at a higher DOC up to 7,5mm with a tool with the best cost-per-edge.



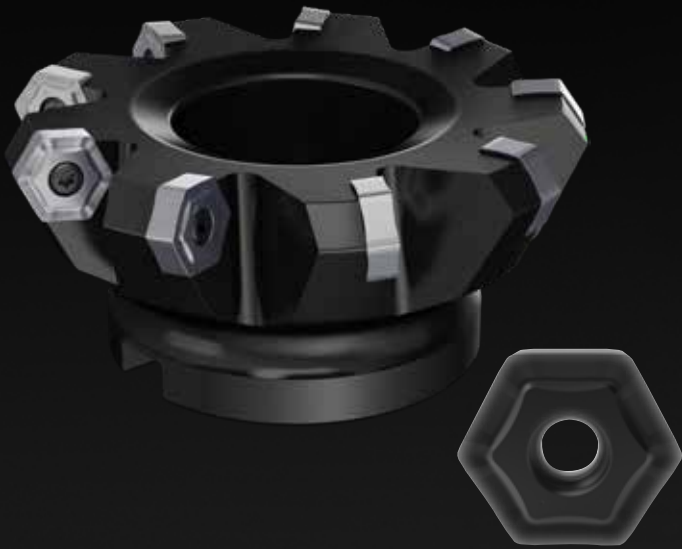

M1200 Max Screw Clamping

Shell Mills: 80-250mm

12-Edged Face Mill for Steel, Stainless Steel, Grey Cast Iron and Nodular Iron

- Universal HNMU11 -MM geometry in grades WP35CM, WU20PM, WK15CM.
- Comprehensive offering: Cutters with 56° lead angle with a 7mm strong and thick insert.
- Pressed-and-sintered-to-size (PSTS) insert in 11mm IC.
- High DOC capability (7,5mm Ap1 max).

M1200 Max Screw Clamping

Face Mills • M1200 Max Screw Clamping Series



- Cutters with 56° lead angle with a 7mm strong and thick insert.
- One universal geometry in latest Victory™ milling grades WP35CM, WK15CM, WU20PM.
- PSTS insert with 12 cutting edges.
- Insert with positive rake geometry.
- Suitable for roughing and semi-finish milling of all steels, stainless steels, grey cast iron, and nodular iron.

One Geometry, Three Grades

One universal geometry in the latest Victory™ grades WP35CM, WK15CM, and WU20PM. With less complexity, more materials can be machined. The proven Victory™ grades cover most target applications.

-MM

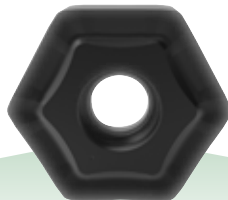

WK15CM

K

WK15CM is a wear-resistant grade with balanced toughness for general milling of cast irons. Best results in dry machining, but can also be used wet.

WP35CM

P K

WP35CM has a wide range of applications in general and rough milling of steels and cast iron. Performs best in dry, but can also be used under wet conditions.

WU20PM

P M K N S H

WU20PM is a universal grade for machining of steel, stainless steel, and high-temperature alloys. Also suitable for machining of grey and nodular irons. Resists breakage and offers improved wear resistance and increased strength. Can be used for both dry and wet machining.

M1200 Max Screw Clamping • Shell Mills

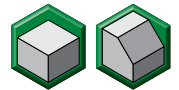
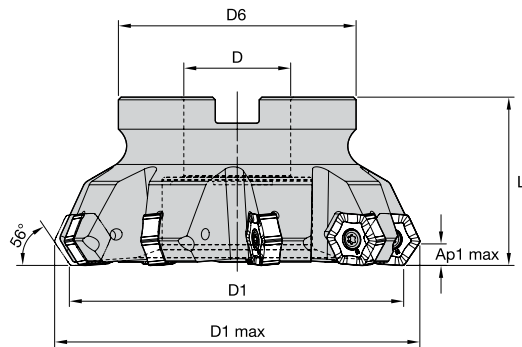

order number	catalogue number	D1	D1 max	D	D4	D6	L	Ap1 max	Z	coolant supply	kg
6581490	M1200D080Z05S27HN11	80	91,8	27	—	60	50	7,5	5	No	0,99
6495103	M1200D100Z07S32HN11	100	111,8	19	—	78	50	7,5	7	No	1,49
6495104	M1200D125Z09S40HN11	125	136,7	40	—	89	63	7,5	9	No	2,72
6581561	M1200D160Z10S40HN11	160	171,7	40	66,7	90	63	7,5	10	No	3,81
6626921	M1200D200Z12S60HN11	200	211,7	60	101,6	130	63	7,5	12	No	6,88
6852419	M1200D250Z14S60HN11	250	261,7	60	101,6	130	63	7,5	14	No	6,88

Spare Parts

MM#	Description	ANSI = ISO	Required torque (Nm/in.lbs)
1136819	INSERT SCREW M5-0.8 x 17 T20	199.123	5.1 Nm/45 in.lbs
1138446	TORX WRENCH T20	170.026	

Insert screws included but other hardware is sold separately

Cutter MM#	CAT ID	Lock Screw	Lock Screw MM#
6581490	M1200D080Z05S27HN10	MS-2038	1841782
6495103	M1200D100Z07S32HN10	KLS32MPKG (pack of 2 pcs)	1147970
6495104	M1200D125Z09S40HN10	KLS40M	1016374
6581561	M1200D160Z10S40HN10	PCD Holes	
6626921	M1200D200Z12S60HN10		
6852419	M1200D250Z14S60HN10		



M1200 Max Screw Clamping

Face Mills • M1200 Max Screw Clamping Series

Inserts • HNMU -MM • Universal Geometry Targeting a Variety of Applications

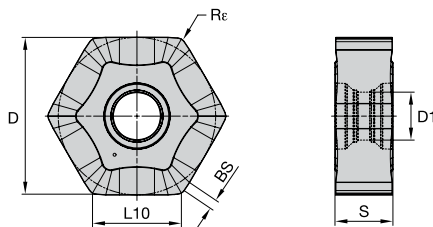

- first choice
- alternate choice

P	●	○
M	●	○
K	○	○
N	○	○
S	○	○
H	○	○

ISO catalogue number	cutting edges	D	L10	S	BS	R _ε	hm	WP35CM	WK15CM	WU20PM
HNMU110710ZNSNMM	12	19	10,75	6,92	1,20	1,00	0,06	6495105	6495106	6852420

Inserts

Material Group	Light Machining		General Purpose		Heavy Machining	
	Geometry	Grade	Geometry	Grade	Geometry	Grade
P1-P2	.S..MM	WP35CM	.S..MM	WP35CM	.S..MM	WU20PM
P3-P4	.S..MM	WP35CM	.S..MM	WP35CM	.S..MM	WU20PM
P5-P6	.S..MM	WP35CM	.S..MM	WP35CM	.S..MM	WP35CM
M1-M2	.S..MM	WU20PM	.S..MM	WU20PM	.S..MM	WU20PM
M3	.S..MM	WP35CM	.S..MM	WP35CM	.S..MM	WP35CM
K1-K2	.S..MM	WK15CM	.S..MM	WK15CM	.S..MM	WU20PM
K3	.S..MM	WU20PM	.S..MM	WU20PM	.S..MM	WK15CM
N1-N2	.S..MM	WU20PM	.S..MM	WU20PM	.S..MM	WU20PM
N3	.S..MM	WU20PM	.S..MM	WU20PM	.S..MM	WU20PM
S1-S2	.S..MM	WU20PM	.S..MM	WU20PM	.S..MM	WU20PM
S3	.S..MM	WU20PM	.S..MM	WU20PM	.S..MM	WU20PM
S4	.S..MM	WP35CM	.S..MM	WU20PM	.S..MM	WU20PM
H1	.S..MM	WU20PM	-	-	-	-

Recommended Starting Feeds

Insert Geometry	Programmed Feed per Tooth (fz) as a % of Radial Depth of Cut (ae)														Insert Geometry	
	5%		10%		20%		30%		40-100%							
.S..MM	0.22	0.71	1.15	0.16	0.51	0.82	0.12	0.38	0.61	0.10	0.33	0.54	0.09	0.31	0.49	.S..MM

NOTE: First choice starting feed (fz) is in **bold** type.
 Use corresponding speed (vc).
 fz and vc are valid for ae ≥ 0,4 D1.
 For smaller ae, fz and vc should be multiplied by the factor given below:



M1200 Max Screw Clamping

Face Mills • M1200 Max Screw Clamping Series

Recommended Starting Speeds

Material Group		WP35CM			WK15CM			WU20PM		
P	1	455	395	370	—	—	—	330	290	270
	2	280	255	230	—	—	—	275	250	200
	3	255	230	205	—	—	—	255	220	175
	4	190	175	160	—	—	—	225	190	150
	5	260	230	210	—	—	—	185	175	150
	6	160	135	—	—	—	—	165	130	100
M	1	205	185	155	—	—	—	205	180	165
	2	185	160	140	—	—	—	185	160	130
	3	145	130	115	—	—	—	140	120	95
K	1	295	265	240	420	385	340	250	220	185
	2	235	210	190	335	295	275	200	180	150
	3	195	175	160	280	250	230	180	150	120
N	1	—	—	—	—	—	—	550	470	400
	2	—	—	—	—	—	—	550	470	400
	3	—	—	—	—	—	—	400	350	300
S	1	—	—	—	—	—	—	40	35	25
	2	—	—	—	—	—	—	40	35	25
	3	—	—	—	—	—	—	50	40	25
	4	—	—	—	—	—	—	70	50	35
H	1	—	—	—	—	—	—	110	80	70

NOTE: First choice starting feed (fz) is in **bold** type.
 Use corresponding speed (vc).
 fz and vc are valid for ae ≥ 0,4 D1.
 For smaller ae, fz and vc should be multiplied by the factor given below:

★ ALL-STAR

visit widia.com

THE ALL-STAR PROGRAMME PROVIDES PROVEN SOLUTIONS THAT ARE EASY TO FIND AND ALWAYS AVAILABLE.



Proven Solutions



Easy to Find

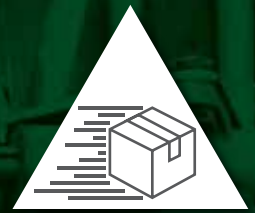

Always Available

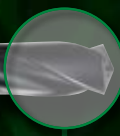

Holemaking

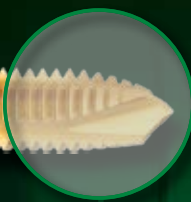

Tapping



Indexable Milling



Solid End Milling



Turning



M 1600



This face mill with a 16-edged insert provides smooth cutting action and low power consumption to steel, stainless steel, and cast iron medium roughing and semi-finishing jobs.



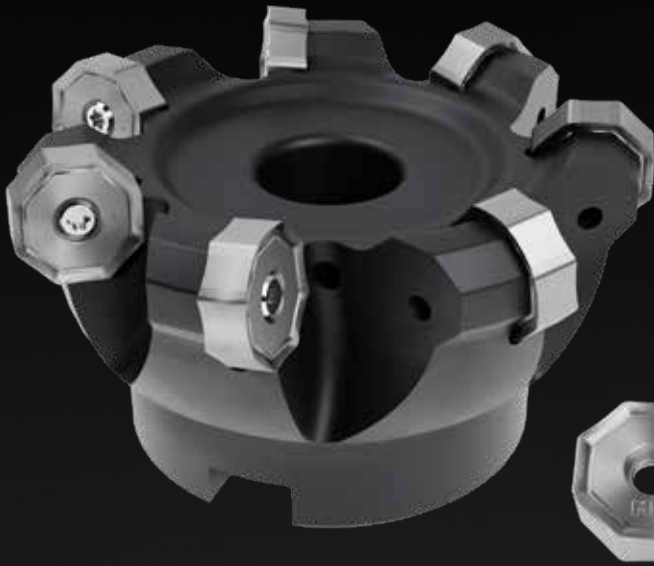

M1600

Shell Mills: 50-160mm

16-Edged Face Mill for Medium Roughing and Semi-Finishing of Steels, Stainless Steels, and Cast Iron.

- Universal -MM geometry in grades WP35CM, WU20PM, WK15CM.
- Comprehensive offering: Cutters with 44° lead angle.
- Precision ground insert.
- Maximum depth of cut: 4mm.
- Smart insert design engineered to resist shock loads resulting in longer tool life.

M1600

Face Mills • M1600 Series



- Cutters with 44° lead angle.
- One universal geometry in latest Victory™ milling grades WP35CM, WK15CM, WU20PM.
- Precision ground insert in 6mm IC 16 true cutting edges.
- Insert with positive geometry.
- Suitable for medium roughing and semi-finish milling of all steels, stainless steels, and cast iron.

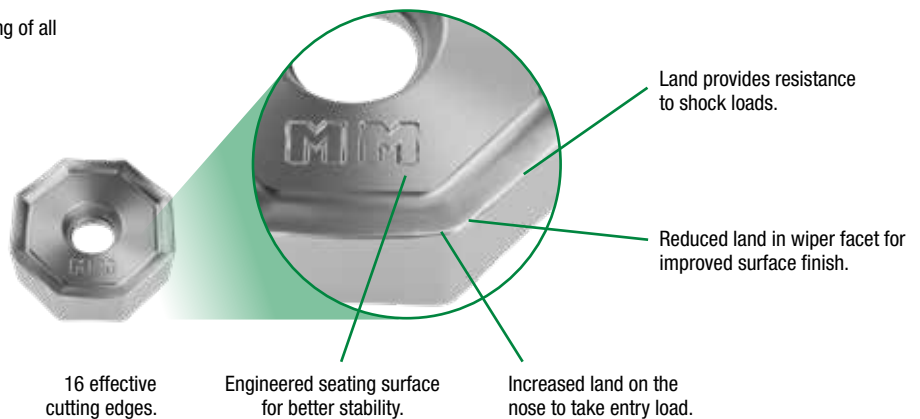

One Geometry, Three Grades

One universal geometry in the latest Victory™ grades WP35CM, WK15CM, and WU20PM. With less complexity, more materials can be machined. The proven Victory™ grades cover most target applications.

-MM



WK15CM



WK15CM is a wear-resistant grade with balanced toughness for general milling of cast irons. Best results in dry machining, but can also be used wet.

WP35CM



WP35CM has a wide range of applications in general and rough milling of steels and cast iron. Performs best in dry, but can also be used under wet conditions.

WU20PM



WU20PM is a universal grade for machining of steel, stainless steel, and high-temperature alloys. Also suitable for machining of grey and nodular irons. Resists breakage and offers improved wear resistance and increased strength. Can be used for both dry and wet machining.

M1600 • Shell Mills • Steel and Cast Iron Face Mills at Low Cost per Edge

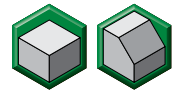
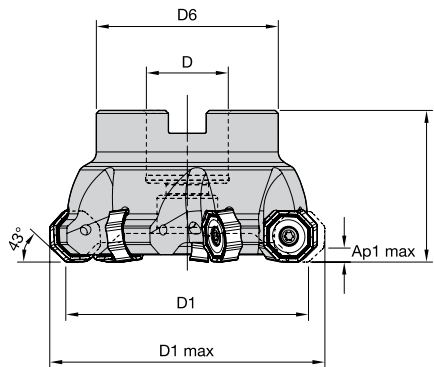

order number	catalogue number	D1	D1 max	D	D4	D6	L	LBX	Ap1 max	Z	coolant supply	kg
4002796	M1600D050Z04S22ON06	50	60,7	22	—	40	40	40	3,7	4	Yes	0,28
4002797	M1600D063Z05S22ON06	63	73,7	22	—	40	40	40	3,7	5	Yes	0,43
3837977	M1600D080Z07S27ON06	80	90,7	27	—	60	50	50	3,7	7	Yes	0,97
3860336	M1600D100Z09S32ON06	100	110,7	32	—	78	50	50	3,7	9	Yes	1,52
3837978	M1600D125Z11S40ON06	125	135,7	40	—	89	63	63	3,7	11	Yes	2,70
4002798	M1600D160Z13S40ON06	160	170,7	40	66,7	90	63	63	3,7	13	Yes	3,83

Spare Parts

MM#	Description	ANSI = ISO	Required torque (Nm/in.lbs)
1756815	INSERT SCR M4-0.7 x 11.5 T15	193.332	4 Nm/35.4 in.lbs
2029596	TORX WRENCH T15	12148082400	

Insert screws included but other hardware is sold separately

Cutter MM#	CAT ID	Lock Screw	Lock Screw MM#
4002796	M1600D050Z04S22ON06	125.025	1136777
4002797	M1600D063Z05S22ON06	125.025	1136777
3837977	M1600D080Z07S27ON06	MS-2038	1841782
3860336	M1600D100Z09S32ON06	MS-2189-C	3450356
3837978	M1600D125Z11S40ON06	420.200	1016374
4002798	M1600D160Z13S40ON06		



M1600

Face Mills • M1600 Series

Inserts • ONGX -MM • Machining at Low Cost per Edge

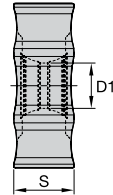
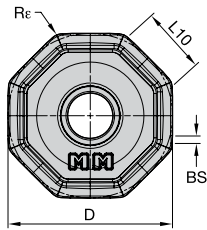

- first choice
- alternate choice

P	●	○
M	●	○
K	○	○
N	○	○
S	○	○
H	○	○

ISO catalogue number	cutting edges	D	L10	S	BS	Re	hm	WP35CM	WK15CM	WU20PM
ONGX060512ANSNMM	16	17	6,87	5,47	0,77	1,20	0,04	6852431	6072424	3778942
ONGX060512ANSNMM	16	17	6,87	5,47	0,77	1,20	0,06			

Inserts

Material Group	Light Machining		General Purpose		Heavy Machining	
	Geometry	Grade	Geometry	Grade	Geometry	Grade
P1-P2	.S.MM	WP35CM	.S.MM	WP35CM	.S.MM	WU20PM
P3-P4	.S.MM	WP35CM	.S.MM	WP35CM	.S.MM	WU20PM
P5-P6	.S.MM	WP35CM	.S.MM	WP35CM	.S.MM	WP35CM
M1-M2	.S.MM	WU20PM	.S.MM	WU20PM	.S.MM	WU20PM
M3	.S.MM	WP35CM	.S.MM	WP35CM	.S.MM	WP35CM
K1-K2	.S.MM	WK15CM	.S.MM	WK15CM	.S.MM	WU20PM
K3	.S.MM	WU20PM	.S.MM	WU20PM	.S.MM	WK15CM
N1-N2	.S.MM	WU20PM	.S.MM	WU20PM	.S.MM	WU20PM
N3	.S.MM	WU20PM	.S.MM	WU20PM	.S.MM	WU20PM
S1-S2	.S.MM	WU20PM	.S.MM	WU20PM	.S.MM	WU20PM
S3	.S.MM	WU20PM	.S.MM	WU20PM	.S.MM	WU20PM
S4	.S.MM	WP35CM	.S.MM	WU20PM	.S.MM	WU20PM
H1	.S.MM	WU20PM	-	-	-	-

Recommended Starting Feeds

Light Machining	General Purpose	Heavy Machining
-----------------	-----------------	-----------------

Insert Geometry	Programmed Feed per Tooth (fz) as a % of Radial Depth of Cut (ae)															Insert Geometry
	5%			10%			20%			30%			40-100%			
.S.MM	0.26	0.85	1.42	0.19	0.62	1.01	0.14	0.46	0.75	0.12	0.40	0.66	0.11	0.37	0.60	.S.MM

NOTE: First choice starting feed (fz) is in **bold** type.
 Use corresponding speed (vc).
 fz and vc are valid for ae ≥ 0,4 D1.
 For smaller ae, fz and vc should be multiplied by the factor given below:



M1600

Face Mills • M1600 Series

Recommended Starting Speeds

Material Group		WP35CM			WK15CM			WU20PM		
P	1	455	395	370	—	—	—	330	290	270
	2	280	255	230	—	—	—	275	250	200
	3	255	230	205	—	—	—	255	220	175
	4	190	175	160	—	—	—	225	190	150
	5	260	230	210	—	—	—	185	175	150
	6	160	135	—	—	—	—	165	130	100
M	1	205	185	155	—	—	—	205	180	165
	2	185	160	140	—	—	—	185	160	130
	3	145	130	115	—	—	—	140	120	95
K	1	295	265	240	420	385	340	250	220	185
	2	235	210	190	335	295	275	200	180	150
	3	195	175	160	280	250	230	180	150	120
N	1	—	—	—	—	—	—	550	470	400
	2	—	—	—	—	—	—	550	470	400
	3	—	—	—	—	—	—	400	350	300
S	1	—	—	—	—	—	—	40	35	25
	2	—	—	—	—	—	—	40	35	25
	3	—	—	—	—	—	—	50	40	25
	4	—	—	—	—	—	—	70	50	35
H	1	—	—	—	—	—	—	110	80	70

NOTE: First choice starting feed (fz) is in **bold** type.
 Use corresponding speed (vc).
 fz and vc are valid for ae ≥ 0,4 D1.
 For smaller ae, fz and vc should be multiplied by the factor given below:

WIDIA™ Digital Solutions

Tools and Resources at Your Fingertips

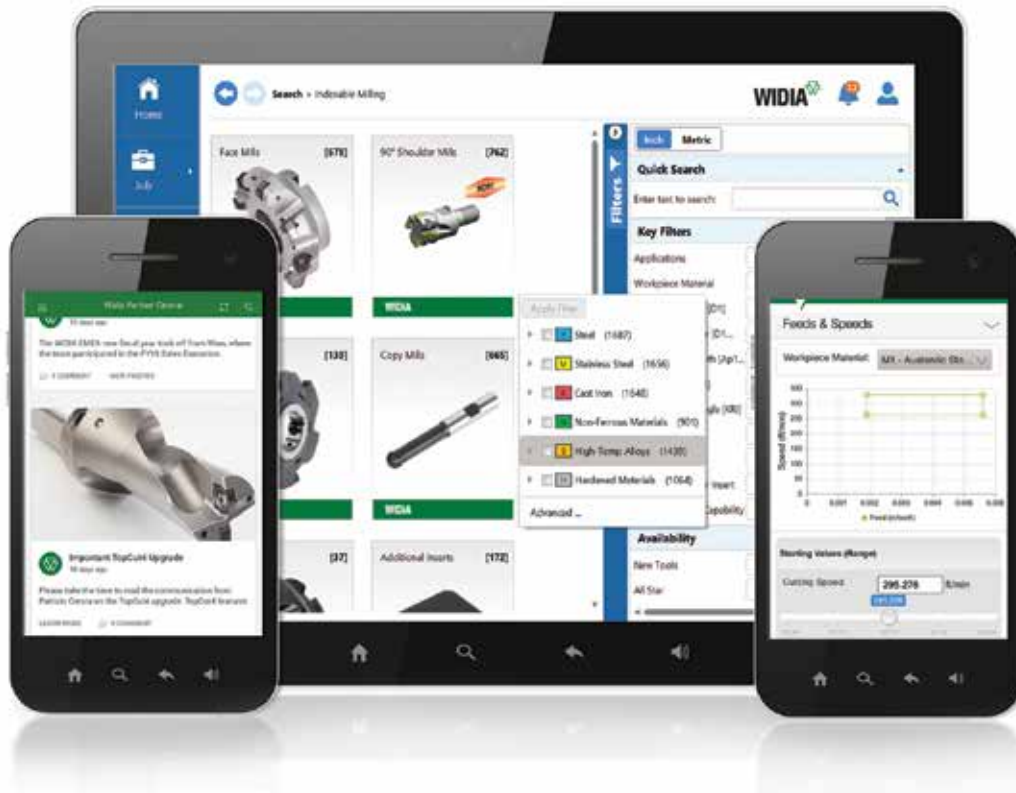

**WIDIA
Machining
Central**

PRODUCT DATA

- Tooling Dimensional Data
- Feeds and Speeds
- Inventory Availability
- ...and More!

DOWNLOAD THE **WIDIA MOBILE APPS** TODAY!



WIDIA.COM

TDMX

TOP DRILL™ MODULAR X



STABILITY AND RELIABILITY COMBINED INTO ONE MODULAR DRILL SYSTEM

TDMX modular drills now have modular, material-specific inserts for steel, cast iron, stainless steel, and super alloys. This expansion will extend the capability of the TDMX modular drilling portfolio to drill inclined entry/exit, stacked plates, and cross holes.



Platform

Standard drill bodies: 1.5 x D, 3 x D, 5xD, 8 x D, 12 x D.

Insert diameter range: 16-40mm



Easy to Apply

Front clamping design to easily change the insert without disassembling the holder from the body.

Easy-insert nomenclature logic to identify the targeted material group.

Increased Stability and Performance

Highly engineered pocket seat design to ensure maximum stability, even in challenging applications like cross hole, inclined entry/exit, and interrupted cuts.

Suitable for high feed rates.

Flanged shank for higher rigidity.

Polished flutes for improved chip evacuation.



MS(M) insert geometry for Stainless Steel and Super Alloys.

TDMX — TOP DRILL™ Modular X

Modular Drills • TOP DRILL Modular X



- Augmented insert stability thanks to the highly engineered pocket seat design.
- Front clamping for an easy insert change, without disassembling the holder from the machine spindle.



TDMX is a stable modular drilling platform delivering predictable performance and continuous productivity via three material-specific insert types.

PK(M)



P K

First choice for Steel and Cast Iron drilling.

FPE(M)



P M K

Flat bottom drilling, stacked plates, piloting for deep-hole drilling.

MS(M)



M S

First choice for stainless steel and super alloys.



TDMX — Drilling Stainless Steel

M 13-8 hyper chrome 110 KSI

pre-machined surface

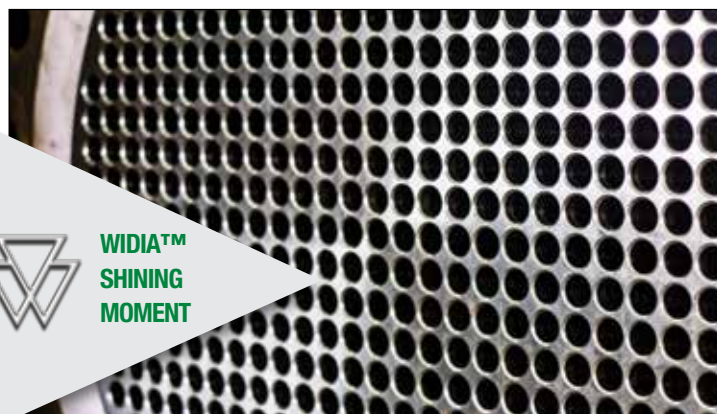

	Competitor	WIDIA
Head	—	TDMX6813780MS(M)
Diameter, mm	19.05	19.05
Grade	—	WM15PD
Drill body	—	TDMX0749RSL100
Length	3 x D	3 x D
Vc, m/min	65	75
n, rev/min	815	1225
Fn, mm/min	0.127	0.127
Vf, mm/min	118	155
Depth	56	56
Tool Life, m	6.3	10.6 m



WIDIA™
SHINING
MOMENT

TDMX • Inserts • MS(M)

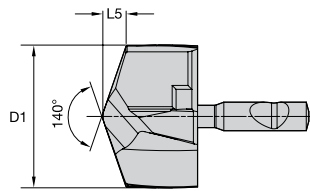
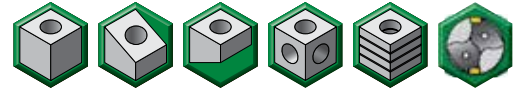

- first choice
- alternate choice

P		
M	●	
K	○	
N	○	
S	●	
H		

catalogue number	D1	L5	SSC	WM15PD
TDMX16000MSM	16,00	2,84	A	6568922
TDMX16200MSM	16,20	2,88	A	6568923
TDMX16281MSM	16,28	2,89	A	6568924
TDMX16500MSM	16,50	2,93	A	6568925
TDMX16667MSM	16,67	2,96	A	6568926
TDMX17000MSM	17,00	3,01	B	6568927
TDMX17064MSM	17,06	3,02	B	6568929
TDMX17463MSM	17,46	3,09	B	6568930
TDMX17500MSM	17,50	3,10	B	6568931
TDMX17600MSM	17,60	3,12	B	6568932
TDMX17800MSM	17,80	3,15	B	6568933
TDMX17859MSM	17,86	3,16	B	6568934
TDMX18000MSM	18,00	3,19	C	6568935
TDMX18255MSM	18,26	3,24	C	6568938
TDMX18500MSM	18,50	3,28	C	6568939
TDMX18651MSM	18,65	3,30	C	6568940
TDMX18800MSM	18,80	3,33	C	6568941
TDMX19000MSM	19,00	3,36	D	6568942
TDMX19050MSM	19,05	3,37	D	6568943
TDMX19200MSM	19,20	3,40	D	6568944
TDMX19270MSM	19,27	3,41	D	6568945
TDMX19450MSM	19,45	3,44	D	6568946
TDMX19500MSM	19,50	3,45	D	6568947
TDMX19700MSM	19,70	3,48	D	6568948
TDMX19840MSM	19,84	3,51	D	6568949
TDMX20000MSM	20,00	3,54	E	6568961
TDMX20100MSM	20,10	3,56	E	6568962
TDMX20200MSM	20,20	3,57	E	6568963
TDMX20239MSM	20,24	3,58	E	6568964
TDMX20300MSM	20,30	3,59	E	6568965
TDMX20400MSM	20,40	3,61	E	6568966
TDMX20500MSM	20,50	3,63	E	6568967
TDMX20600MSM	20,60	3,64	E	6568968
TDMX20650MSM	20,65	3,65	E	6568969
TDMX20700MSM	20,70	3,66	E	6568973
TDMX20800MSM	20,80	3,68	E	6568980

TDMX — TOP DRILL™ Modular X

Modular Drills • TOP DRILL Modular X

TDMX • Inserts • MS(M)

(continued)

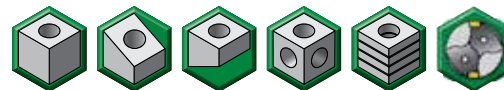

- first choice
- alternate choice

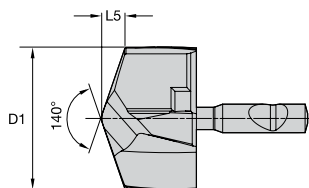

P	Blue	
M	Yellow	●
K	Red	○
N	Green	○
S	Orange	●
H	Grey	

catalogue number	D1	L5	SSC	WM15PD
TDMX20900MSM	20,90	3,69	E	6568981
TDMX21000MSM	21,00	3,71	F	6568982
TDMX21430MSM	21,43	3,79	F	6568983
TDMX21500MSM	21,50	3,80	F	6568984
TDMX22000MSM	22,00	3,89	G	6568985
TDMX22225MSM	22,23	3,93	G	6568986
TDMX22450MSM	22,45	3,97	G	6568987
TDMX22500MSM	22,50	3,97	G	6568988
TDMX23000MSM	23,00	4,06	H	6568989
TDMX23500MSM	23,50	4,15	H	6568990
TDMX23813MSM	23,81	4,20	H	6568991
TDMX24000MSM	24,00	4,24	I	6568993
TDMX24500MSM	24,50	4,32	I	6568994
TDMX24605MSM	24,61	4,34	I	6568995
TDMX25000MSM	25,00	4,41	J	6568996
TDMX25400MSM	25,40	4,48	J	6568998
TDMX25500MSM	25,50	4,49	J	6568999
TDMX25670MSM	25,67	4,52	J	6569000
TDMX25700MSM	25,70	4,53	J	6569001
TDMX25760MSM	25,76	4,54	J	6569002
TDMX25796MSM	25,80	4,55	J	6569003
TDMX26000MSM	26,00	4,59	K	6569006
TDMX26192MSM	26,19	4,62	K	6569007
TDMX26400MSM	26,40	4,65	K	6569008
TDMX26500MSM	26,50	4,67	K	6569009
TDMX26589MSM	26,59	4,69	K	6569010
TDMX27000MSM	27,00	4,76	L	6569502
TDMX27500MSM	27,50	4,84	L	6569503
TDMX27780MSM	27,78	4,89	L	6569504
TDMX28000MSM	28,00	4,93	M	6569505
TDMX28176MSM	28,18	4,96	M	6569506
TDMX28500MSM	28,50	5,02	M	6569507
TDMX28575MSM	28,58	5,03	M	6569508
TDMX29000MSM	29,00	5,11	N	6569509
TDMX29367MSM	29,37	5,17	N	6569510
TDMX29500MSM	29,50	5,19	N	6569521



TDMX • Inserts • MS(M)

(continued)

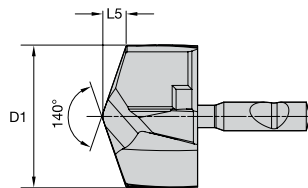
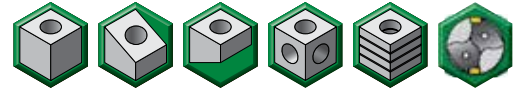

- first choice
- alternate choice

P	Blue	
M	Yellow	●
K	Red	○
N	Green	○
S	Orange	●
H	Grey	

catalogue number	D1	L5	SSC	WM15PD
TDMX29764MSM	29,76	5,24	N	6569522
TDMX30000MSM	30,00	5,28	O	6569523
TDMX30163MSM	30,16	5,31	O	6569524
TDMX30500MSM	30,50	5,37	O	6569525
TDMX30955MSM	30,96	5,45	O	6569526
TDMX31000MSM	31,00	5,45	P	6569527
TDMX31500MSM	31,50	5,54	P	6569528
TDMX31750MSM	31,75	5,58	P	6569529
TDMX32000MSM	32,00	5,63	Q	6569530
TDMX32500MSM	32,50	5,72	Q	6569531
TDMX33000MSM	33,00	5,80	Q	6569532
TDMX33338MSM	33,34	5,86	Q	6569533
TDMX34000MSM	34,00	5,98	R	6569534
TDMX34130MSM	34,13	6,00	R	6569535
TDMX34925MSM	34,93	6,13	R	6569536
TDMX35000MSM	35,00	6,15	R	6569537
TDMX35500MSM	35,50	6,23	R	6569538
TDMX36000MSM	36,00	6,33	S	6569539
TDMX36500MSM	36,50	6,41	S	6569540
TDMX37000MSM	37,00	6,50	S	6569551
TDMX37500MSM	37,50	6,59	S	6569552
TDMX38000MSM	38,00	6,67	T	6569553
TDMX38100MSM	38,10	6,69	T	6569554
TDMX38289MSM	38,29	6,72	T	6569557
TDMX38500MSM	38,50	6,76	T	6569555
TDMX39000MSM	39,00	6,84	T	6569556
TDMX39500MSM	39,50	6,93	T	6569558
TDMX40000MSM	40,00	7,01	T	6569559



NOTE: SSC = Pocket Seat Reference. To correspond with the SSC on the toolholder.

Insert Type	Metric	
	TDMX...PK:MS Tolerance k7	TDMX...FPE Tolerance s7
D1 16-18	+0,001/+0,019	+0,028/+0,046
>18-30	+0,002/+0,023	+0,035/+0,056
>30-40	+0,002/+0,027	+0,043/+0,068

TDMX — TOP DRILL™ Modular X

Modular Drills • TOP DRILL Modular X

Application Data • MS(M) • WM15PD • Metric

Material Group										
		Cutting Speed – Vc			Recommended Feed Rate (f) by Diameter					
		Range – m/min								
min	Starting Value	max	Tool Diameter (mm)	16,0	20,0	25,4	32,0	40,0		
M	1	40	80	110	mm/r	0,11 – 0,26	0,13 – 0,28	0,13 – 0,32	0,14 – 0,35	0,15 – 0,37
	2	35	55	75	mm/r	0,11 – 0,26	0,13 – 0,28	0,13 – 0,32	0,14 – 0,35	0,15 – 0,37
	3	20	35	50	mm/r	0,11 – 0,26	0,13 – 0,28	0,13 – 0,32	0,14 – 0,35	0,15 – 0,37
K	1	90	135	175	mm/r	0,19 – 0,25	0,22 – 0,29	0,29 – 0,38	0,32 – 0,43	0,33 – 0,50
	2	80	120	140	mm/r	0,19 – 0,25	0,22 – 0,29	0,29 – 0,38	0,32 – 0,43	0,33 – 0,50
	3	70	110	125	mm/r	0,18 – 0,26	0,21 – 0,29	0,23 – 0,37	0,25 – 0,42	0,27 – 0,46
N	1	90	155	220	mm/r	0,25 – 0,50	0,28 – 0,56	0,32 – 0,63	0,32 – 0,70	0,32 – 0,70
	2	90	155	220	mm/r	0,25 – 0,50	0,28 – 0,56	0,32 – 0,63	0,32 – 0,70	0,32 – 0,70
	3	80	120	160	mm/r	0,25 – 0,50	0,28 – 0,56	0,32 – 0,63	0,32 – 0,70	0,32 – 0,70
	4	90	155	220	mm/r	0,25 – 0,50	0,28 – 0,56	0,32 – 0,63	0,32 – 0,70	0,32 – 0,70
	5	160	200	240	mm/r	0,25 – 0,50	0,28 – 0,56	0,32 – 0,63	0,32 – 0,70	0,32 – 0,70
	6	160	200	240	mm/r	0,25 – 0,50	0,28 – 0,56	0,32 – 0,63	0,32 – 0,70	0,32 – 0,70
S	1	20	40	60	mm/r	0,07 – 0,12	0,09 – 0,14	0,11 – 0,17	0,13 – 0,20	0,16 – 0,25
	2	15	30	45	mm/r	0,07 – 0,12	0,09 – 0,14	0,11 – 0,17	0,13 – 0,20	0,16 – 0,25
	3	15	30	45	mm/r	0,07 – 0,12	0,09 – 0,14	0,11 – 0,17	0,13 – 0,20	0,16 – 0,25
	4	10	25	40	mm/r	0,07 – 0,12	0,13 – 0,20	0,16 – 0,25	0,18 – 0,28	0,21 – 0,31

***DON'T LET MONEY DRILL
HOLES IN YOUR POCKETS***

TDMX MODULAR DRILL

**Quick, Easy Insert change
without disassembling tool
from machine; regrindable.**



TDMX is a featured product in the All-Star program. Take advantage of same-day shipping on select line items today!



WGC

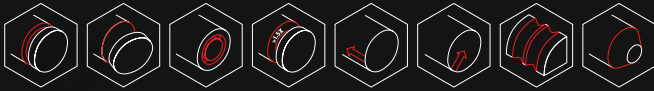

THE MOST VERSATILE TOOL IN THE
MARKET FOR GROOVING, PROFILING,
AND CUT-OFF OPERATIONS

4 BENEFITS IN 1

VERSATILE

GROOVING, PROFILING, AND
CUT-OFF OPERATIONS

SIMPLE

EASY TO SELECT
AND APPLY

STABLE

TRIPLE-V SEATING FOR
SECURE CLAMPING

PRODUCTIVE

LOW CUTTING FORCES IN
THROUGH COOLANT FOR
BETTER CHIP EVACUATION



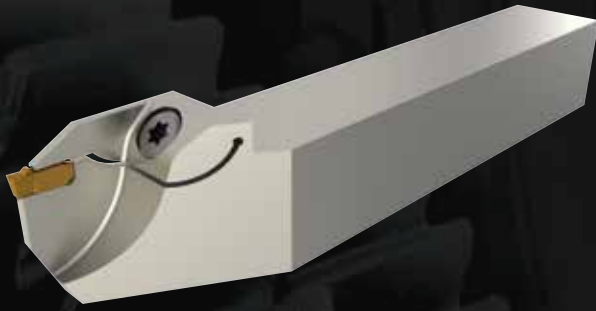

Grooving

New integral reinforced clamp tool holders.

New front clamping for seat size: 2-3mm, shank size from 10-20mm.

First choice for external grooving applications in most workpiece materials.

Through coolant capability and efficient coolant delivery for enhanced productivity.

Available in integral and modular style toolholders.

Full Portfolio Groove Width: 2–10mm.



Cut-Off

Specially engineered chipbreakers for effective parting/cut-off and deep grooving.

Positive geometry for lower forces.

Secure seating offers greatest stability.

Groove width: 1,4–8mm.



Profiling

Full radius chipbreaker for multi-directional turning and generating complex profiles.

Rigid design ensures smooth surface finish.

Groove width: 2–8mm.

WIDIA 

widia.com

WGC • Integral Reinforced Front Clamp Toolholders

Each character in our catalog number signifies a specific trait of that product. Use the following key columns and corresponding images to easily identify which attributes apply.

WGCSFL2020K316C
WGCSFL12316C

WGC	S	C	F	L	2020K	3	16	C
WGC	S	C	F	L	12	3	16	C
Family Name	Tool Style	Support Type	Clamping Screw Position	Hand	Shank Size	Seat Size	Cut-Off Depth	Coolant
Widia Grooving and Cut-Off	S: Straight Mount	C: Reinforced maximum support width circular clearance	F: Front	L: Left Hand R: Right Hand	Metric: Height x Width in mm Letter Indicates Tool Length according to ISO Inch: Height x Width in 1/16 inch increment	1B 1F 2 3 4 5 6 8 10	in Millimeters	Through Coolant Capability

Benefits of Front Clamp Compared to Top Clamp

Reduced Head Length for Added Stability.

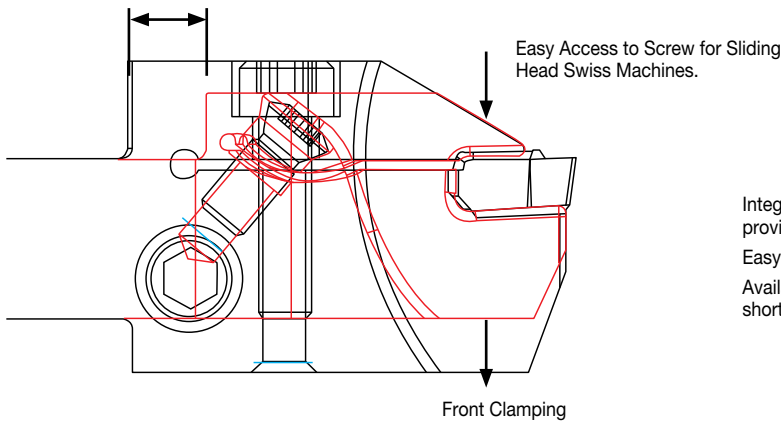

Integral reinforced Front Clamp Holders provide greater rigidity and stability. Easy access to clamp and unclamp screw. Available in small shank sizes and suitable for shorter CD's.

WGCSCF • Integral Reinforced Front Clamp Toolholders • Metric

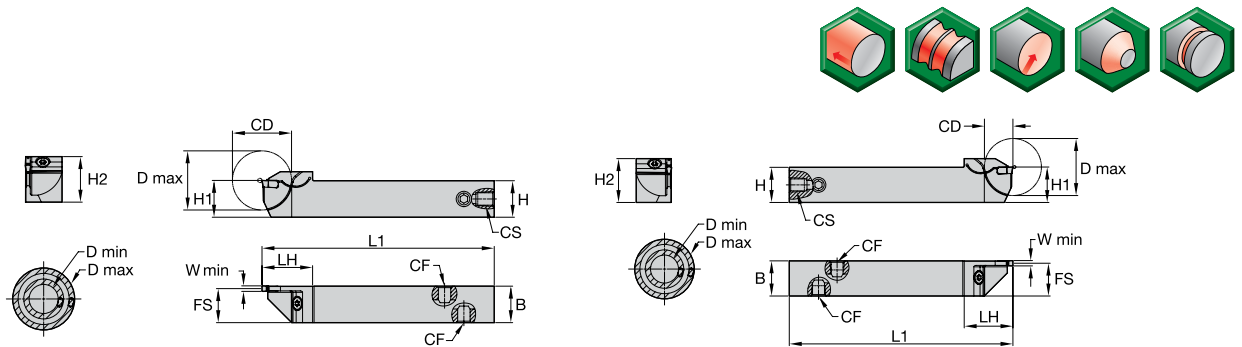

order number	catalogue number	SSC	CD	D max	H1	H	B	H2	L1	FS	LH	CF
right hand												
6765977	WGCSCFR1010K0210	2	10	20	10	10	10	14	125	9	21	—
6765978	WGCSCFR1212K0216	2	16	32	12	12	12	16	125	11	27	—
6765980	WGCSCFR1616K0216	2	16	32	16	16	16	21	125	15	27	—
6766062	WGCSCFR2020K0216	2	16	32	20	20	20	25	125	19	27	—
6765979	WGCSCFR1212K0316C	3	16	32	12	12	12	17	125	11	28	M8X1
6766061	WGCSCFR1616K0316C	3	16	32	16	16	16	18	125	15	28	M8X1
6766063	WGCSCFR2020K0316C	3	16	32	20	20	20	25	125	19	28	M8X1
left hand												
6766064	WGCSCFL1010K0210	2	10	20	10	10	10	14	125	9	21	—
6766065	WGCSCFL1212K0216	2	16	32	12	12	12	16	125	11	27	—
6766067	WGCSCFL1616K0216	2	16	32	16	16	16	21	125	15	27	—
6766069	WGCSCFL2020K0216	2	16	32	20	20	20	25	125	19	27	—
6766066	WGCSCFL1212K0316C	3	16	32	12	12	12	17	125	11	28	M8X1
6766068	WGCSCFL1616K0316C	3	16	32	16	16	16	21	125	15	28	M8X1
6766070	WGCSCFL2020K0316C	3	16	32	20	20	20	25	125	19	28	M8X1

NOTE: SSC = Pocket Seat Reference. To correspond with the SSC on the insert.

WGC • Spare Parts

screw		torque		wrench		wrench	
catalog number	order number	Nm	in. lbs.	thread	socket	catalog number	order number
MS1160	1099645	9	62	M5	T20	KT20	1022703
MS1162	1127019	7	80	M6	T25	KT25	1022725
MS1163	1124104	18	159	M8	T30	KT30L	3782185
MS1273	1020977	4	35.4	M4	T15	KT15	1022701
MS1490	2263299	17	151	M8	T45	KT45	1018227
MS1595	1094300	12	106	M6	T30	KT30	1099676
MS1970	1106668	12	106	M6	T30	KT30	1099676
MS2002	1621087	9	80	M6	T25	KT25	1022725
MS2091	1931147	9	80	M5	25IP	K25IP	2050113



RU: ROUGHING UNIVERSAL-POSITIVE

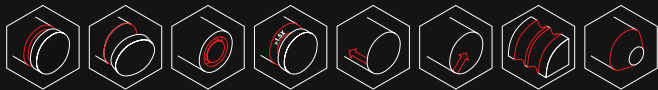

A SPECIALLY ENGINEERED
GEOMETRY IN VICTORY GRADES FOR
ROUGH TO MEDIUM TURNING OF A
VARIETY OF WORKPIECE MATERIALS.



RU: Roughing Universal-Positive

CNMG12/WNMG08/TNMG16 in corner radii 0.8 and 1.2mm.

Victory CVD grades for turning all types of steel, stainless steel, and cast iron materials.

Features and Benefits

Positive geometry for smooth cutting.

Positive T-land with rake angle to lower cutting forces and improve DOCN resistance.

Post-coat grinding of seating surface for secure seating surface.

Good edge strength for interrupted cuts, forging skin, and casting surfaces.

Post-coat treatment

- Improves edge toughness.
- Long, predictable tool life.
- Reduces depth-of-cut notching.
- Wide range of applications.

New geometry identification system.

Improved edge toughness

- Provides smooth outer surface to reduce forces, friction, and workpiece sticking.

Post-coat grinding

- Provides secure seating surface.

Alpha alumina layer

- Provides coating integrity at elevated speeds.
- Higher productivity and dependability at high cutting temperatures.

WIDIA 

widia.com

WIDIA™ VICTORY™

High-Performance Inserts • WIDIA Victory

CNMG-RU

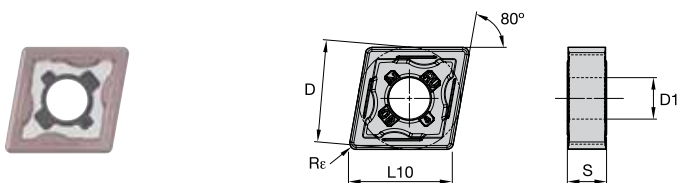

● first choice
○ alternate choice

P	Blue	●	●	●	○	○	○	○	○
M	Yellow			○	●	●	●		
K	Red	○	○					●	●
N	Green								
S	Orange				○				
H	Grey								

ISO catalogue number	D	L10	S	Rε	D1	WP15CT	WP25CT	WP35CT	WM15CT	WM25CT	WM35CT	WK05CT	WK15CT	WK20CT
CNMG120408RU	12,70	12,90	4,76	0,8	5,16	6690250	6690247	6690248	6817522	6817523	6817756	6817757	6678403	6690253
CNMG120412RU	12,70	12,90	4,76	1,2	5,16	6690251	6690249	6690248	6817523	6817757	6817756	6817757	6678404	6690254

TNMG-RU

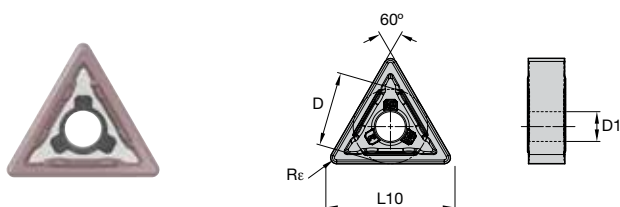

● first choice
○ alternate choice

P	Blue	●	●	●	○	○	○	○	○
M	Yellow			○	●	●	●		
K	Red	○	○					●	●
N	Green								
S	Orange				○				
H	Grey								

ISO catalogue number	D	L10	S	Rε	D1	WP15CT	WP25CT	WP35CT	WM15CT	WM25CT	WM35CT	WK05CT	WK15CT	WK20CT
TNMG160408RU	9,53	16,50	4,76	0,8	3,81	6776936	6776937	6776938	6817524	6817525	6817701	6817702	6746845	6817450
TNMG160412RU	9,53	16,50	4,76	1,2	3,81	6776936	6776937	6776938	6817524	6817525	6817701	6817702	6746846	6817521

WNMG-RU

● first choice
○ alternate choice

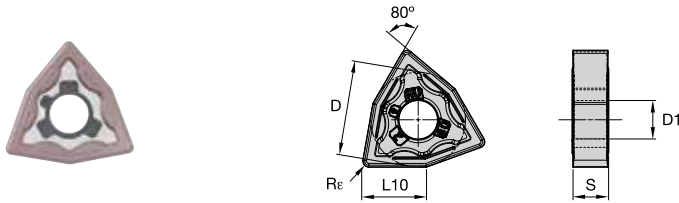

P	●	●	●	○	○	○	○	○	○
M	○	○	○	○	○	○	○	○	○
K	○	○	○	○	○	○	○	○	○
N	○	○	○	○	○	○	○	○	○
S	○	○	○	○	○	○	○	○	○
H	○	○	○	○	○	○	○	○	○

ISO catalogue number	D	L10	S	Rε	D1	6690252	6690249	6817526	6817759	6817526	6817759	6678405	6690255
WNMG080408RU	12,70	8,69	4,76	0,8	5,16	6696886	6696887	-	6711599	6817758	-	6696885	6583558
WNMG080412RU	12,70	8,69	4,76	1,2	5,16	6690252	6690249	-	6817759	6817758	-	6678405	6690255

Chip Control Chart



CNMG-RU



TNMG-RU

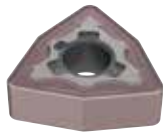

WNMG-RU

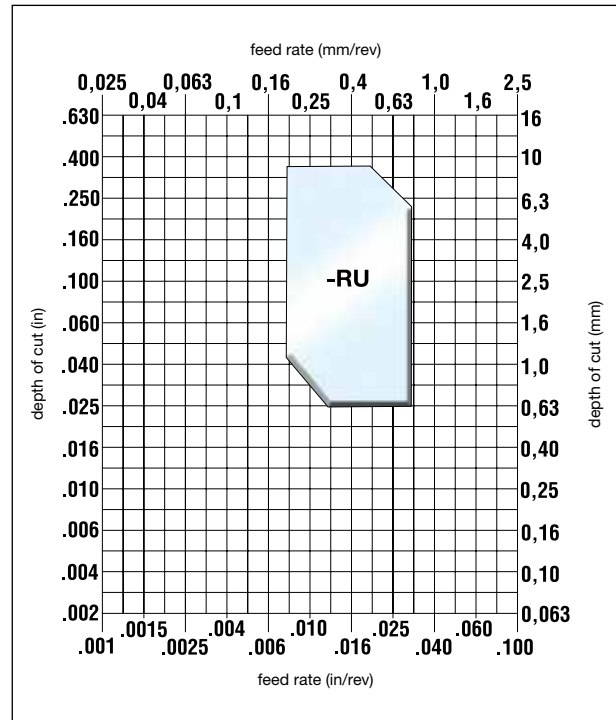

Insert Geometry



Feed: 0,2– 0,6mm
Depth of cut: 1,0 – 6,4mm

Chipbreaker Profile

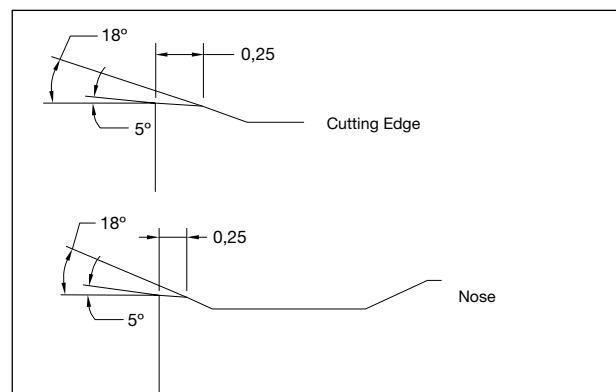

★ ALL-STAR

visit widia.com

THE ALL-STAR PROGRAMME PROVIDES PROVEN SOLUTIONS THAT ARE EASY TO FIND AND ALWAYS AVAILABLE.



Proven Solutions



Easy to Find

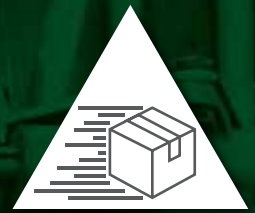

Always Available

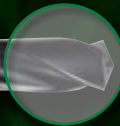

Holemaking

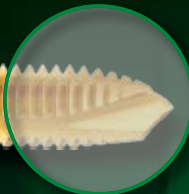

Tapping



Indexable Milling



Solid End Milling



Turning



INSERTS FOR ALUMINUM

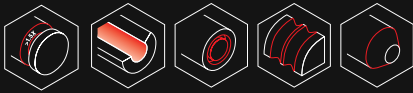

WIDIA OFFERS INSERTS SPECIALLY
DESIGNED FOR MACHINING
ALUMINUM AND NON-FERROUS
MATERIALS.





-AL Geometry

Universal geometry for aluminum and non-ferrous materials.

Periphery ground with rake face polished.



Features and Benefits

Polished rake surface for smooth flow of chips.

High positive rake on the nose and CE.

Positive, sharp cutting edge for low cutting forces and no built-up edge.

Microfine uncoated carbide for a long tool life.

Sharp cutting edge.

High positive rake for smooth chip flow.

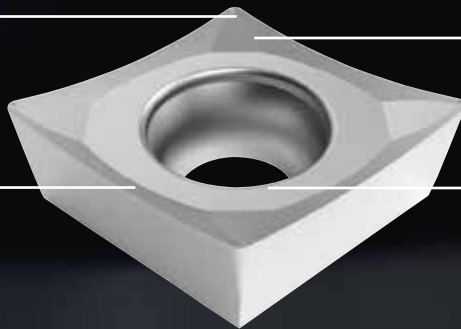

Highly polished inserts to prevent build-up edge and for longer tool life.

Periphery ground inserts for better precision.

WIDIA 

widia.com

ALUMINUM

ISO/ANSI Carbide Inserts

WIDIA™ Inserts • CCGT-AL • Machining Aluminum

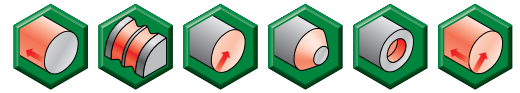

- first choice
- alternate choice

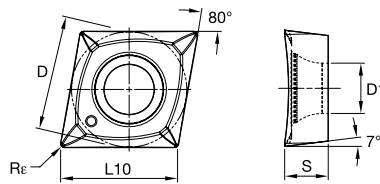
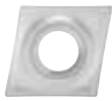

P	Blue	
M	Yellow	
K	Red	
N	Green	●
S	Orange	
H	Grey	

ISO catalogue number	D	L10	S	R _ε	D1	WU10HT
CCGT060202AL	6,35	6,45	2,38	0,2	2,79	6846528
CCGT060204AL	6,35	6,47	2,38	0,4	2,79	6846529
CCGT060208AL	6,35	6,45	2,38	0,8	2,80	6846530
CCGT09T302AL	9,53	9,67	3,97	0,2	4,40	6846581
CCGT09T304AL	9,53	9,67	3,97	0,4	4,40	6846582
CCGT09T308AL	9,53	9,67	3,97	0,8	4,40	6846583
CCGT120402AL	12,70	12,90	4,76	0,2	5,50	6846584
CCGT120404AL	12,70	12,90	4,76	0,4	5,50	6846585
CCGT120408AL	12,70	12,90	4,76	0,8	5,50	6846586

WIDIA™ Inserts • DCGT-AL • Machining Aluminum

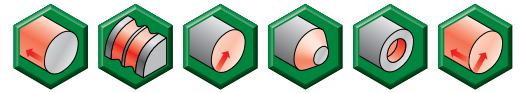

- first choice
- alternate choice

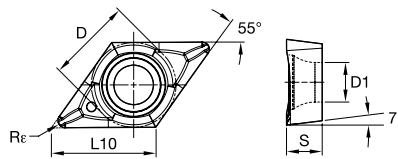

P		
M		
K		
N	●	
S		
H		

ISO catalogue number	D	L10	S	Rε	D1	WU10HT
DCGT070202AL	6,35	7,75	2,38	0,2	2,90	6846587
DCGT070204AL	6,35	7,75	2,38	0,4	2,90	6846588
DCGT11T302AL	9,53	11,63	3,97	0,2	4,40	6846589
DCGT11T304AL	9,53	11,59	3,97	0,4	4,40	6846590
DCGT11T308AL	9,53	11,63	3,97	0,8	4,40	6846591

ALUMINUM

ISO/ANSI Carbide Inserts

WIDIA™ Inserts • RCGT-AL • Machining Aluminum

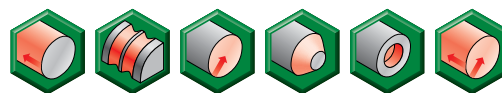

- first choice
- alternate choice

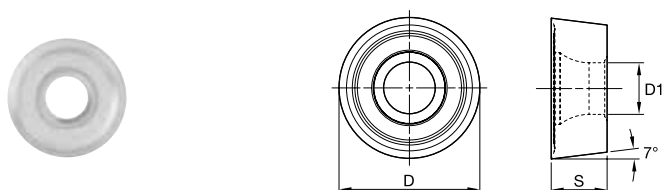

P	■	■
M	■	■
K	■	■
N	■	●
S	■	■
H	■	■

ISO catalogue number	D	S	D1	WU10HT
RCGT1204M0AL	12,00	4,76	4,40	6846592

WIDIA™ Inserts • TCGT-AL • Machining Aluminum

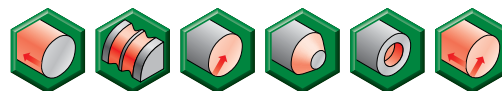

- first choice
- alternate choice

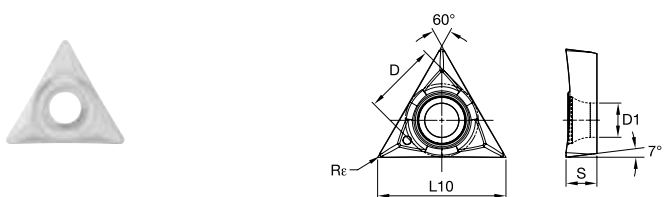

P	■	■
M	■	■
K	■	■
N	■	●
S	■	■
H	■	■

ISO catalogue number	D	L10	S	Re	D1	WU10HT
TCGT110204AL	6,35	11,00	2,38	0,4	2,80	6846593
TCGT16T304AL	9,53	16,51	3,97	0,4	4,40	6846594
TCGT16T308AL	9,53	16,50	3,97	0,8	4,40	6846595



WIDIA™ Inserts • VBGT-AL • Machining Aluminum

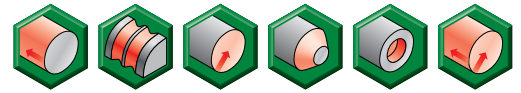

- first choice
- alternate choice

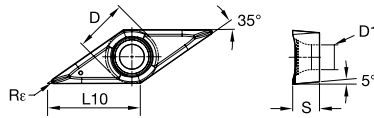

P		
M		
K		
N	●	
S		
H		

ISO catalogue number	D	L10	S	Rε	D1	WU10HT
VBGT160404AL	9,53	16,61	4,76	0,4	4,40	6846596
VBGT160408AL	9,53	16,46	4,76	0,8	4,40	6846597

ALUMINUM

Aluminum Inserts

WU10HT • Grade Information

A hard, un-alloyed, low binder content with fine grained carbide. It is a wear resistant, uncoated carbide for machining of aluminum and other non-ferrous materials.

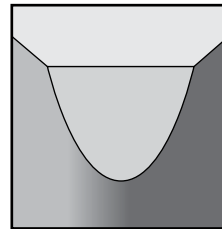

WU10HT



		Geometry
Conditions		AL
Lightly Interrupted Cut		WU10HT
Varying Depth of Cut		WU10HT
Smooth Cut		WU10HT

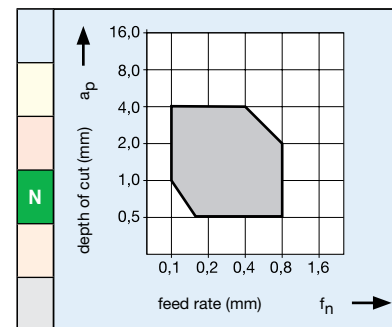

For cost-effective machining of aluminum, non-ferrous metals and plastics. Extremely sharp cutting edges result in optimum part finishes with low cutting forces and short chips.

Cutting Speed Recommendation

High-Silicon Aluminum Alloys
(hypereutectic >12,2% Si) and Magnesium Alloys

material group	grade	Speed – m/min										Starting Conditions
		250	500	750	1000	1250	1500	1750	2000	2250	2500	m/min
N1	WU10HT	◊										488

Low-Silicon Aluminum Alloys
(hypoeutectic <12,2% Si) and Magnesium Alloys

material group	grade	Speed – m/min										Starting Conditions
		250	500	750	1000	1250	1500	1750	2000	2250	2500	m/min
N1	WU10HT	◊										488

Copper-, Brass-, Zinc-Based on a Machinability
Index Range of 70–100

material group	grade	Speed – m/min				Starting Conditions
		250	500	750	1000	m/min
N1	WU10HT	◊				259

Nylon, Plastics, Rubbers, Phenolics, Resins,
Fibreglass, and Glass

material group	grade	Speed – m/min				Starting Conditions
		250	500	750	1000	m/min
N1	WU10HT	◊				107

MMCs (Aluminum-Based Metal Matrix Composites)

material group	grade	Speed – m/min				Starting Conditions
		250	500	750	1000	m/min
N1	WU10HT	◊				180

TOOLS FOR RAILWAY WHEELSET RECONDITIONING



WIDIA OFFERS TOOLHOLDERS AND INDEXABLE INSERTS FOR ALL TYPES OF WHEEL LATHES USED IN THE RAILROAD INDUSTRY.

This offering of railway tooling was developed in close cooperation with machine tool builders and railway workshops to ensure productivity in typical heavy-duty operations.



Toolholders

- Robust lever clamping design with no top clamp to interfere with chip flow.
- Toolholders are made from heat-treated alloy steel, providing rigid support to the insert to withstand severe roughing cuts on work-hardened wheels.

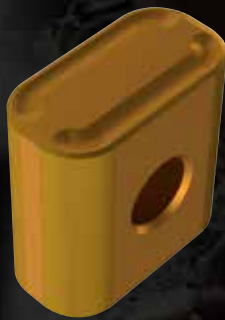

Inserts

- Upended inserts are neutral and common for either hand of the toolholder.
- Different chipbreaker profile and highly wear resistant coated carbide grades
- Grades are available to machine the wheels in a range of wear conditions.

Railway

Wheel Reprofilng/Wheelset Turning

Railway Toolholder • Wheel Turning Lathe

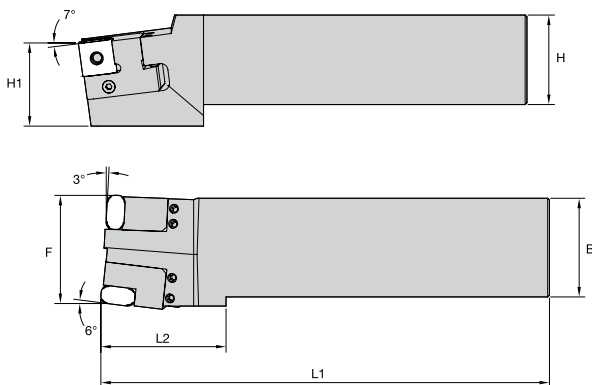

order number	catalogue number	B	F	H	H1	L1	L2
right hand							
2552321	6939143110	55,00	60,00	50,00	46,00	250,00	70,00

Railway Toolholder • Wheel Turning Lathe

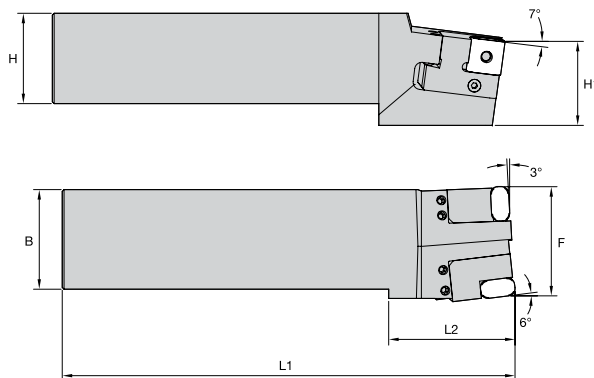

order number	catalogue number	B	F	H	H1	L1	L2
left hand							
2552320	6939143120	55,00	60,00	50,00	46,00	250,00	70,00

Railway Toolholder • Wheel Turning Lathe

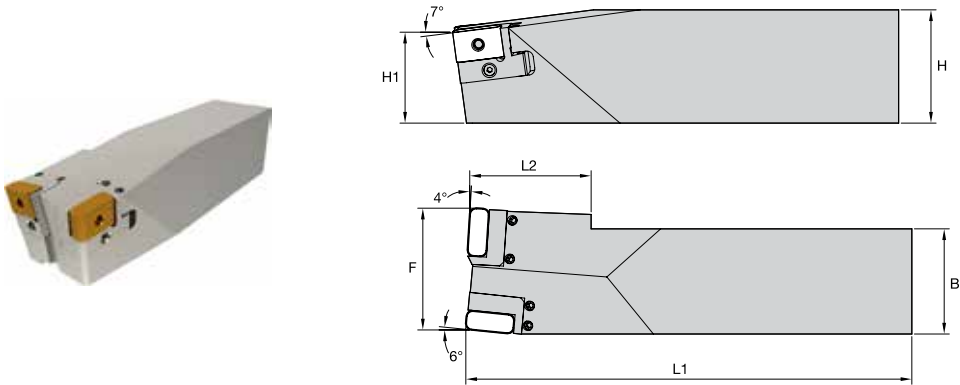

order number	catalogue number	B	F	H	H1	L1	L2
right hand							
2552319	6939145810	65,00	75,00	70,00	56,00	276,00	77,80

Railway Toolholder • Wheel Turning Lathe

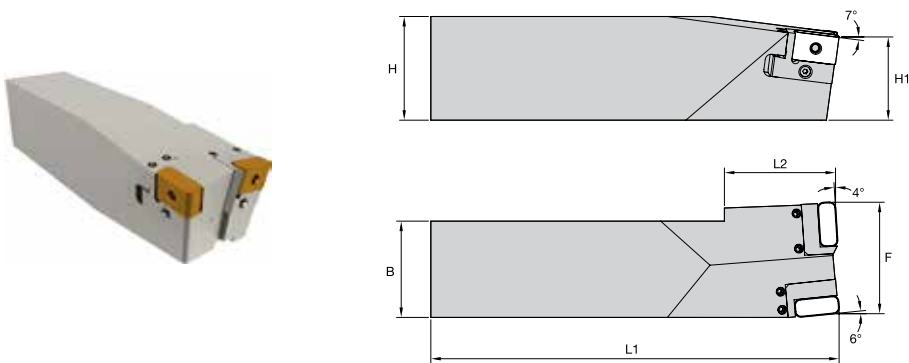

order number	catalogue number	B	F	H	H1	L1	L2
left hand							
2552318	6939145820	65,00	75,00	70,00	56,00	276,00	77,80

Railway

Wheel Reprofiling/Wheelset Turning

Railway Turning Cassette • Wheel Turning Lathe

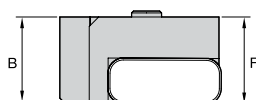
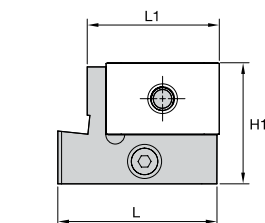

order number	catalogue number	B		F		L		L1		H1		gage insert	clamp screw	lever
		mm	in	mm	in	mm	in	mm	in	mm	in			
2035331	6939318620	22,50	.886	23,00	.906	42,20	1.660	35,00	1.378	32,00	1.260	LINUX301940	12148562700	12148566700

Railway Turning Cassette • Wheel Turning Lathe

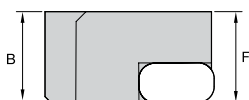
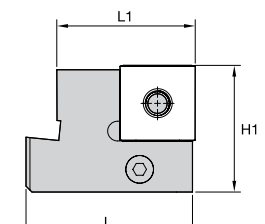

order number	catalogue number	B		F		L		L1		H1		gage insert	clamp screw	lever
		mm	in	mm	in	mm	in	mm	in	mm	in			
2276948	6939318820	22,50	.886	23,00	.906	42,20	1.660	35,00	1.378	32,00	1.260	LINUX191940	12148562700	12148566700

Railway Turning Cassette • Wheel Turning Lathe

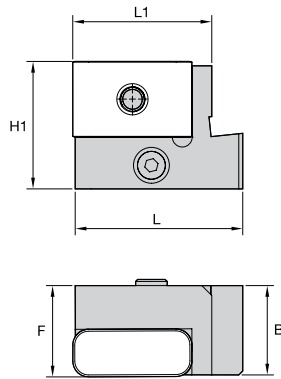

order number	catalogue number	B		F		L		L1		H1		gage insert	clamp screw	lever
		mm	in	mm	in	mm	in	mm	in	mm	in			
right hand														
2039208	6939318610	22,50	.886	23,00	.906	42,20	1.660	35,00	1.378	32,00	1.260	LINUX301940	12148562700	12148566700

Railway Turning Cassette • Wheel Turning Lathe

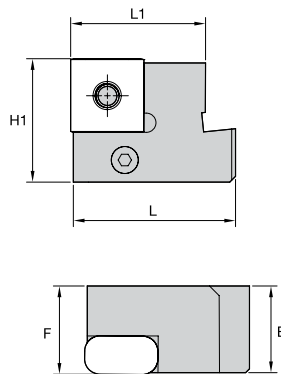

order number	catalogue number	B		F		L		L1		H1		gage insert	clamp screw	lever
		mm	in	mm	in	mm	in	mm	in	mm	in			
right hand														
2276947	6939318710	22,50	.886	23,00	.906	42,20	1.660	35,00	1.378	32,00	1.260	LINUX191940	12148562700	12148566700

Railway

Wheel Reprofiling/Wheelset Turning

Railway Facing Cassette • Wheel Turning Lathe

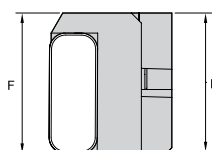
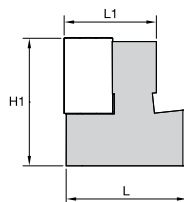
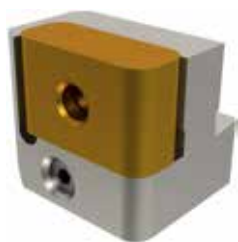

order number	catalogue number	B		F		L		L1		H1		gage insert	clamp screw	lever
		mm	in	mm	in	mm	in	mm	in	mm	in			
left hand														
2403738	6939322020	34,60	1.362	35,00	1.378	30,10	1.185	23,00	.906	32,00	1.260	LNUX301940	12148562700	12148566700

Railway Facing Cassette • Wheel Turning Lathe

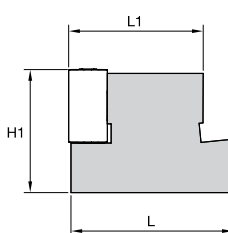
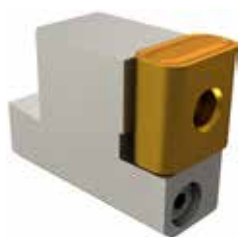

order number	catalogue number	B		F		L		L1		H1		gage insert	clamp screw	lever
		mm	in	mm	in	mm	in	mm	in	mm	in			
left hand														
2576256	6939318920	18,55	.730	19,05	.750	42,20	1.660	35,00	1.378	32,00	1.260	LNUX191940	12148562700	12148566700

Railway Facing Cassette • Wheel Turning Lathe

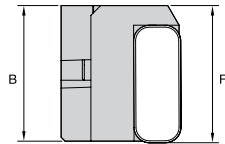
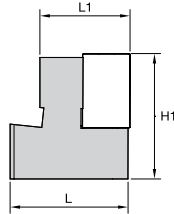

order number	catalogue number	B		F		L		L1		H1		gage insert	clamp screw	lever
		mm	in	mm	in	mm	in	mm	in	mm	in			
right hand														
2403739	6939322110	34,60	1.362	35,00	1.378	30,10	1.185	23,00	.906	32,00	1.260	LINUX301940	12148562700	12148566700

Railway Facing Cassette • Wheel Turning Lathe

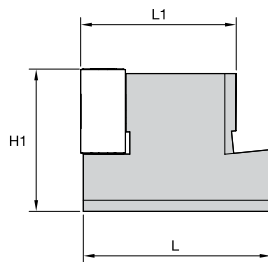

order number	catalogue number	B		F		L		L1		H1		gage insert	clamp screw	lever
		mm	in	mm	in	mm	in	mm	in	mm	in			
right hand														
2576255	6939319010	18,55	.730	19,05	.750	42,20	1.660	35,00	1.378	32,00	1.260	LINUX191940	12148562700	12148566700

Railway

High-Performance Inserts • WIDIA™ Victory™

LNUX

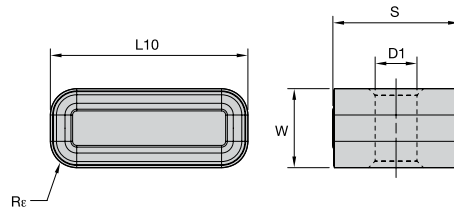

- first choice
- alternate choice

P	●	○
M	○	○
K	○	●
N	○	○
S	○	○
H	○	○

ISO catalogue number	W	L10	S	Re	D1	WP15CT	WK20CT
LNUX30194016	12,00	30,00	19,05	4,0	6,35	6128295	1

LNUX-13

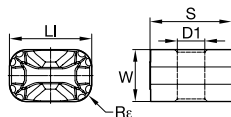
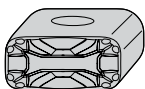

- first choice
- alternate choice

P	●	○
M	○	○
K	○	●
N	○	○
S	○	○
H	○	○

ISO catalogue number	W	L10	S	Re	D1	WP15CT	WK20CT
LNUX19194013	10,00	19,05	19,05	4,0	6,35	1	4170966
LNUX30194013	12,00	30,00	19,05	4,0	6,35	1	4170968

ISO/ANSI Carbide Inserts

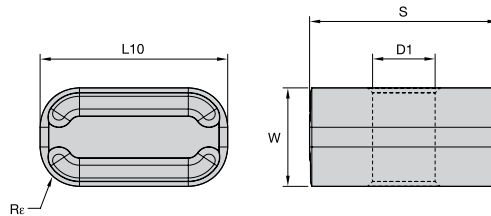

- first choice
- alternate choice

P	<input checked="" type="checkbox"/>	<input type="checkbox"/>
M	<input type="checkbox"/>	<input type="checkbox"/>
K	<input type="checkbox"/>	<input checked="" type="checkbox"/>
N	<input type="checkbox"/>	<input type="checkbox"/>
S	<input type="checkbox"/>	<input type="checkbox"/>
H	<input type="checkbox"/>	<input type="checkbox"/>







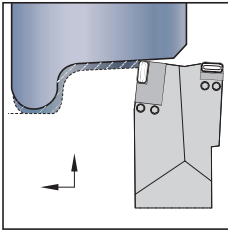

ISO catalogue number	W	L10	S	Re	D1	WP15CT	WK20CT
LNUX191940T	10,00	19,05	19,05	4,0	6,35	6128294	4170967
LNUX301940T	12,00	30,00	19,05	4,0	6,35	-	4170969

Railway

Toolholder • Wheel Lathes • Hegenscheidt 167 L and HEC Hegenscheidt LW 140B-A







Compound Toolholder • Spare Parts

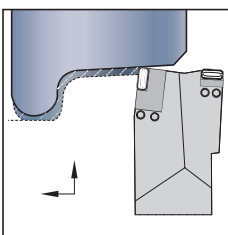

toolholder	 turning cassette	 facing cassette		 retaining screw	 hex 1	 locking screw	 hex 2	 adjusting screw
69.391.458.10	69.393.186.10	69.393.221.10	LINUX301940	73.085.863	73.398.965	73.398.589	73.398.931	73.398.577
69.391.458.20	69.393.186.20	69.393.220.20	LINUX301940	73.085.863	73.398.965	73.398.589	73.398.931	73.398.577
69.391.458.10	69.393.187.10	—	LINUX191940	73.085.863	73.398.965	73.398.589	73.398.931	73.398.577
69.391.458.20	69.393.188.20	—	LINUX191940	73.085.863	73.398.965	73.398.589	73.398.931	73.398.577

Compound Toolholder • Spare Parts





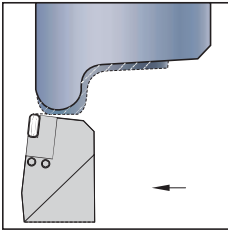

toolholder	 turning cassette	 facing cassette		 retaining screw	 hex	 adjusting screw
69.391.431.10	69.393.186.10	—	LINUX301940	73.085.863	73.398.965	73.398.577
69.391.431.20	69.393.186.20	—	LINUX301940	73.085.863	73.398.965	73.398.577
69.391.431.10	69.393.187.10	69.393.190.10	LINUX191940	73.085.863	73.398.965	73.398.577
69.391.431.20	69.393.188.20	69.393.189.20	LINUX191940	73.085.863	73.398.965	73.398.577

NOTE: The toolholders are supplied without the cassettes and inserts. However, the necessary screws for clamping the cassettes, locking and adjusting screws, and hex wrenches are supplied with the toolholders. Products available upon request.





Turning Cassette • Spare Parts

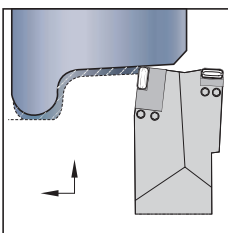

Cassette		 lever	 clamp screw	 hex
69.393.186.10	LNUX301940	214.85.667	214.85.627	73.398.965
69.393.186.20	LNUX301940	214.85.667	214.85.627	73.398.965
69.393.187.10	LNUX191940	214.85.667	214.85.627	73.398.965
69.393.188.20	LNUX191940	214.85.667	214.85.627	73.398.965

Facing Cassette • Spare Parts

















Cassette		 lever	 clamp screw	 hex
69.393.220.10	LNUX301940	214.85.667	214.85.627	73.398.965
69.393.221.20	LNUX301940	214.85.667	214.85.627	73.398.965
69.393.189.10	LNUX191940	214.85.667	214.85.627	73.398.965
69.393.190.20	LNUX191940	214.85.667	214.85.627	73.398.965





















NOTE: The cassettes are supplied without the inserts, which should be ordered separately.
Products available upon request.

Informational Icons Guide

Indexable Milling Icons





















 Counterboring	 Spiral Circular	 Face Milling	 Helical Milling	 Plunge Milling
 Ramping	 Slotting: Square End	 Side Milling/ Shoulder Milling: Square End	 3D Profiling: Inclined Square End Mill	 Pocketing
 Cylindrical/Plain Shank	 Weldon® Shank	 Screw-On Shank	 Shell Mill	 Through Coolant

Solid End Milling Icons









 Ramping: Blank	 Slotting: Square End	 Slotting: Square End with AP Dimension	 Side Milling/ Shoulder Milling: Square End	 Side Milling/ Shoulder Milling: Square End with AE/AP Dimension
 3D Profiling	 3D Profiling: 3D Profiling with AE/AP Dimensions	 Trochoidal Milling	 Corner Style: Corner Radius	 Corner Style: Square End
 Corner Style: Torus	 Cylindrical/Plain Shank	 Helix Angle: 20°	 Helix Angle: 30°	 Helix Angle: 40°
 Helix Angle: 45°	 DIN 6527	 ZU=X Tool Dimensions: Flute Configuration: X (Variable)	 ZU=3 Tool Dimensions: Flute Configuration: 3	 ZU=6 Tool Dimensions: Flute Configuration: 6

Informational Icons Guide

Holemaking Icons

 Drilling	 Drilling: Inclined Entry	 Drilling: Inclined Exit	 Drilling: X-Offset	 Drilling: Stacked Plates
 Drilling: Convex	 Drilling: Blind	 Chain Drilling	 Drilling: Cross Hole	 Drilling: Half Cylinder
 Drilling: Corner Drilling 45°	 Drilling Depth: 1x	 Drilling Depth: 3x	 Drilling Depth: 5x	 Drilling Depth: 8x
 Drilling Depth: 12x	 Flat Shank	 Shank: Cylindrical Plain	 Through Coolant: Radial: Drilling	 Through Coolant: Radial: Indexable Drilling
 Tool Dimensions: 2-Flute/2-Margin/ Coolant				

Turning Icons

 Turning	 Profiling	 Facing	 Face Grooving	 Chamfering
 Grooving	 Cut-off	 Deep Grooving	 Through Coolant: Grooving	

DIN – German Institute for Standardisation
ISO – International Standardisation Organisation

Customer Application Support (CAS)

Get fast and reliable answers to your toughest metal-cutting problems.

Our Customer Application Support (CAS) Team is the metalworking industry's leading help desk resource for tooling application solutions and problem resolution.

- Easy access to proven metalworking expertise.
- Service level excellence.
- Best-in-class application support tools and technology.

Easy access to proven metalworking expertise!

WIDIA™ Customer Application Engineers assist customers and engineering groups throughout the world with expert tool selection and application recommendations for the entire range of WIDIA tooling.

Service Level Excellence:

- Fast telephone response.
- Quick technical solutions.
- Efficient case management.

Services Provided:

- Tooling selection.
- Operating parameters.
- Troubleshooting.
- Process optimisation.
- Hardware support.

Best-in-Class Support Tools and Technology:

- Tooling performance experts.
- Materials database.
- Application calculators.

ORIGINATING COUNTRY	LANGUAGE	TEL	FAX	EMAIL
Australia	English	001-724-539-6921 *	001-724-539-6830 *	ap.techsupport@widia.com
Austria	German	0800 291630	0049-911-9735-429 *	eu.techsupport@widia.com
Belgium	English/French	0800 80410	0049-911-9735-429 *	eu.techsupport@widia.com
China	Chinese	400-889-2237	+86-21-5899985 *	w-cn.techsupport@widia.com
Denmark	English	808 89295	001-724-539-6830 *	na.techsupport@widia.com
Finland	English	0800 919413	001-724-539-6830 *	na.techsupport@widia.com
France	French	080 5540 379	0049-911-9735-429 *	eu.techsupport@widia.com
Germany	German	0800 1015774	0911-9735-429*	eu.techsupport@widia.com
India	English	1 800 103 5227	—	in.techsupport@widia.com
Israel	English	1809 449907	001-724-539-6830 *	na.techsupport@widia.com
Italy	Italian	800 916568	02 89512146 *	eu.techsupport@widia.com
Japan	English	001-724539-6921 *	001-724-539-6830 *	ap.techsupport@widia.com
Korea (South)	English	001-724539-6921 *	001-724-539-6830 *	ap.techsupport@widia.com
Malaysia	English	001-724539-6921 *	001-724-539-6830 *	ap.techsupport@widia.com
Netherlands	English	0800 0201131	001-724-539-6830 *	na.techsupport@widia.com
New Zealand	English	001-724539-6921 *	001-724-539-6830 *	ap.techsupport@widia.com
Norway	English	800 10081	001-724-539-6830 *	na.techsupport@widia.com
Poland	Polish	00800 4411943	06166 56504 *	eu.techsupport@widia.com
Russia (landline)	Russian	8800 5556395	0048 6166 56504 *	eu.techsupport@widia.com
Russia (cell phone)	Russian	+7 8005556395	0048 6166 56504 *	eu.techsupport@widia.com
Singapore	English	001-724539-6921 *	001-724-539-6830 *	ap.techsupport@widia.com
South Africa	English	0800 981644	001-724-539-6830 *	na.techsupport@widia.com
Sweden	English	020798794	001-724-539-6830 *	na.techsupport@widia.com
Taiwan	English	001-724539-6921 *	001-724-539-6830 *	ap.techsupport@widia.com
Thailand	English	001-724539-6921 *	001-724-539-6830 *	ap.techsupport@widia.com
United Kingdom	English	0800 028 2996	001-724-539-6830 *	na.techsupport@widia.com
Ukraine	Russian	800502665	0048 6166 56504 *	eu.techsupport@widia.com
USA	English	888 539 5145	001-724-539-6830 *	na.techsupport@widia.com

*Noted phone and fax numbers are not toll free.



Material Overview • DIN

DIN

P Steel	K Cast Iron	S High-Temp Alloys
M Stainless Steel	N Non-Ferrous	H Hardened Materials

material group	description	content	tensile strength RM (MPa)*	hardness (HB)	hardness (HRC)	material number
P0	Low-Carbon Steels, Long Chipping	C <0,25%	<530	<125	–	–
P1	Low-Carbon Steels, Short Chipping, Free Machining	C <0,25%	<530	<125	–	C15, Ck22, ST37-2, S235JR, 9SMnPb28, GS38
P2	Medium- and High-Carbon Steels	C >0,25%	>530	<220	<25	ST52, S355JR, C35, GS60, Cf53
P3	Alloy Steels and Tool Steels	C >0,25%	600–850	<330	<35	16MnCr5, Ck45, 21CrMoV5-7, 38SMn28
P4	Alloy Steels and Tool Steels	C >0,25%	850–1400	340–450	35–48	100Cr6, 30CrNiMo8, 42CrMo4, C70W2, S6525, X120Mn12
P5	Ferritic, Martensitic, and PH Stainless Steels	–	600–900	<330	<35	100Cr6, 30CrNiMo8, 42CrMo4, C70W2, S6525, X120Mn12
P6	High-Strength Ferritic, Martensitic, and PH Stainless Steels	–	900–1350	350–450	35–48	X102CrMo17, G-X120Cr29
M1	Austenitic Stainless Steel	–	<600	130–200	–	X5CrNi 18 10, X2CrNiMo 17 13 2, G-X25CrNiSi 18 9, X15CrNiSi 20 12
M2	High-Strength Austenitic Stainless and Cast Stainless Steels	–	600–800	150–230	<25	X2CrNiMo 13 4, X5NiCr 32 21, X5CrNiNb 18 10, G-X15CrNi 25-20
M3	Duplex Stainless Steel	–	<800	135–275	<30	X8CrNiMo27 5, X2CrNiMoN22 5 3, X20CrNiSi25 4, G-X40CrNiSi27 4
K1	Grey Cast Iron	–	125–500	120–290	<32	GG15, GG25, GG30, GG40, GTW40
K2	Low- and Medium-Strength Ductile Irons (Nodular Irons) and Compacted Graphite Irons (CGI)	–	<600	130–260	<28	GGG40, GTS35
K3	High-Strength Ductile Irons and Austempered Ductile Iron (ADI)	–	>600	180–350	<43	GGG60, GTW55, GTS65
N1	Wrought Aluminum	–	–	–	–	AlMg1, Al99.5, AlCuMg1, AlCuBiPb, AlMgSi1, AlMgSiPb
N2	Low-Silicon Aluminum Alloys and Magnesium Alloys	Si <12,2%	–	–	–	GAISiCu4, GDAISi10Mg
N3	High-Silicon Aluminum Alloys and Magnesium Alloys	Si >12,2%	–	–	–	G-ALSi12, G-AISi17Cu4, G-AISi21CuNiMg
N4	Copper-, Brass-, Zinc-Based on Machinability Index Range of 70–100	–	–	–	–	CuZn40, Ms60, G-CuSn5ZnPb, CuZn37, CuSi3Mn
N5	Nylon, Plastics, Rubbers, Phenolics, Resins, Fibreglass	–	–	–	–	LEXAN®, Hostalen™, Polystyrol®, MAKROLON®
N6	Carbon, Graphite Composites, CFRP	–	–	–	–	CFK, GFK
N7	Metal Matrix Composites (MMC)	–	–	–	–	–
S1	Iron-Based, Heat-Resistant Alloys	–	500–1200	160–260	25–48	X1NiCrMoCu32 28 7, X12NiCrSi36 16, X5NiCrAlTi31 20, X40CoCrNi20 20
S2	Cobalt-Based, Heat-Resistant Alloys	–	1000–1450	250–450	25–48	Haynes® 188, Stellite® 6,21,31
S3	Nickel-Based, Heat-Resistant Alloys	–	600–1700	160–450	<48	INCONEL® 690, INCONEL 625, Hastelloy®, NIMONIC® 75
S4	Titanium and Titanium Alloys	–	900–1600	300–400	33–48	Ti1, TiAl5Sn2, TiAl6V4, TiAl4Mo4Sn2
H1	Hardened Materials	–	–	–	44–48	GX260NiCr42, GX330NiCr42, GX300CrNiSi952, GX300CrMo153, Hardox® 400
H2	Hardened Materials	–	–	–	48–55	–
H3	Hardened Materials	–	–	–	56–60	–
H4	Hardened Materials	–	–	–	>60	–

WIDIA™ Digital Solutions

Tools and Resources at Your Fingertips

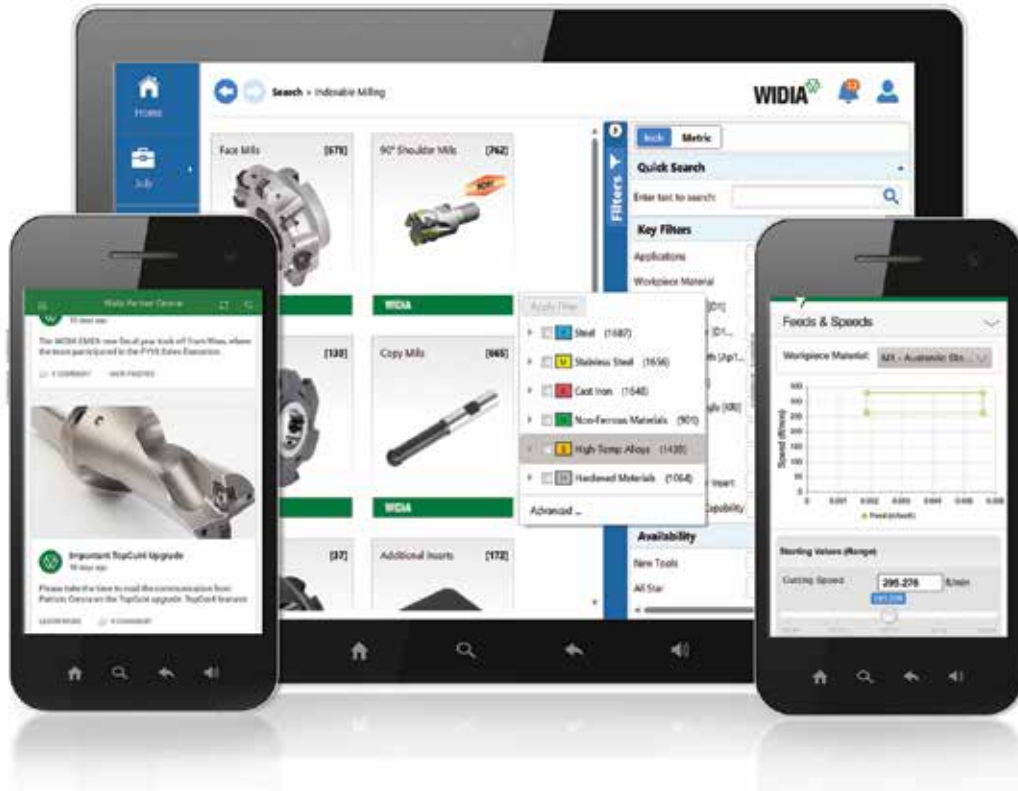

**WIDIA
Machining
Central**

PRODUCT DATA

- Tooling Dimensional Data
- Feeds and Speeds
- Inventory Availability
- ...and More!

DOWNLOAD THE WIDIA MOBILE APPS TODAY!



WIDIA.COM

Notes



Horizontal lines for writing notes.

Find Your Local WIDIA Authorized Distributor

WIDIA™ brand cutting tools are available exclusively through a specialized network of Authorized Distributor partners whom you can count on to deliver much more than products. Our distributors know us, and more importantly, they know you. They know better than anyone in the industry how to put the global power of WIDIA to work for you — in your industry, in your region, and for your business.

WIDIA distributor partners provide technical expertise that you can count on. They will show you how to:

- Significantly reduce cycle time.
- Improve machine tool utilization.
- Achieve measurable productivity improvements.
- Take advantage of proven supply chain solutions.
- Access local inventory and best-in-class technical support.
- Request onsite demonstrations of the latest tooling technology.

And with thousands of turning, milling, holemaking, tapping, and tooling systems products available from WIDIA, you'll find everything you need from one single source.



Find your Local WIDIA Authorized Distributor by accessing our distributor finder at widia.com.

IMPORTANT SAFETY INSTRUCTIONS: READ BEFORE USING THE TOOLS IN THIS CATALOG

METALCUTTING SAFETY

Projectile and Fragmentation Hazards

Modern metalcutting operations involve high spindle and cutter speeds and high temperatures and cutting forces. Hot metal chips may fly off the workpiece during metalcutting. Although cutting tools are designed and manufactured to withstand high cutting forces and temperatures, they can sometimes fragment, particularly if they are subjected to over-stress, severe impact, or other abuse.

To avoid injury:

- Always wear appropriate personal protective equipment, including safety goggles, when operating metalcutting machines or working nearby.
- Always make sure all machine guards are in place.

Breathing and Skin Contact Hazards

Grinding carbide or other advanced cutting tool materials produces dust or mist containing metallic particles. Breathing this dust or mist — especially over an extended period — can cause temporary or permanent lung disease or make existing medical conditions worse. Contact with this dust or mist can irritate eyes, skin, and mucous membranes and may make existing skin conditions worse.

To avoid injury:

- Always wear breathing protection and safety goggles when grinding.
- Provide ventilation control and collect and properly dispose of dust, mist, or sludge from grinding.
- Avoid skin contact with dust or mist.

For more information, read the applicable Material Safety Data Sheet provided by WIDIA and consult General Industry Safety and Health Regulations, Part 1910, Title 29 of the Code of Federal Regulations.

These safety instructions are general guidelines. Many variables affect machining operations. It is impossible to cover every specific situation. The technical information included in this catalog and recommendations on machining practices may not apply to your particular operation.

For more information, consult the WIDIA Metalcutting Safety booklet, available free from WIDIA at +1 724 539 5747 or fax +1 724 539 5439. For specific product safety and environmental questions, contact our Corporate Environmental Health and Safety Office at +1 724 539 5066 or fax +1 724 539 5372.

Kennametal, the stylized K, ALUFLASH, Hanita, NOVO, Stellite, TDMX, TOP DRILL, VariMill, VariMill XTREME, Victory, and WIDIA are trademarks of Kennametal, Inc. and are used as such herein. The absence of a product, service name, or logo from this list does not constitute a waiver of the Kennametal trademark or other intellectual property rights concerning that name or logo.

Android™ is a trademark of Google Inc.
App Store® is a registered trademark of Apple Inc., registered in the U.S. and other countries.
Google Play™ is a trademark of Google Inc.
Hardox® is a registered trademark of SSAB Technology AB Corporation.
Hastelloy® and Haynes® are registered trademarks of Haynes International, Inc.
Hostalen™ is a trademark of Hoechst GmbH Corporation.
INCONEL® and NIMONIC® are registered trademarks of Special Metals Corporation.
LEXAN® is a registered trademark of Sabic Innovative Plastics IP B.V. Company.
MAKROLON® is a registered trademark of Covestro Deutschland AG.
Polystyrol® is a registered trademark of BASF SE.

© Copyright 2021 by Kennametal Inc., Latrobe, PA 15650. All rights reserved.

WIDIA 



ADVANCES

METRIC | 2021

WORLD HEADQUARTERS

WIDIA Products Group

Kennametal Inc.

1600 Technology Way

Latrobe, PA 15650 USA

Tel: 1 800 979 4342

w-na.service@widia.com

EUROPEAN HEADQUARTERS

WIDIA Products Group

Kennametal Europe GmbH

Rheingoldstrasse 50

CH 8212 Neuhausen am Rheinfall

Switzerland

Tel: +41 52 6750 100

w-ch.service@widia.com

ASIA-PACIFIC HEADQUARTERS

WIDIA Products Group

Kennametal (Singapore) Pte. Ltd.

3A International Business Park

Unit #01-02/03/05, ICON@IBP

Singapore 609935

Tel: +65 6265 9222

w-sg.service@widia.com

INDIA HEADQUARTERS

WIDIA Products Group

REGD OFFICE: WIDIA India Tooling Pvt Ltd

CIN: U28110KA2018PTC119396

Survey No 11 Nagasandra

Adjacent to Nagasandra Metro Station

Bengaluru - Pune National Highway

Bengaluru - 560073 India

Tel: +91 80 2839 4321

w-in.service@widia.com



widia.com