

INCH 2018

ADVANCES

Introducing New Products from WIDIA™

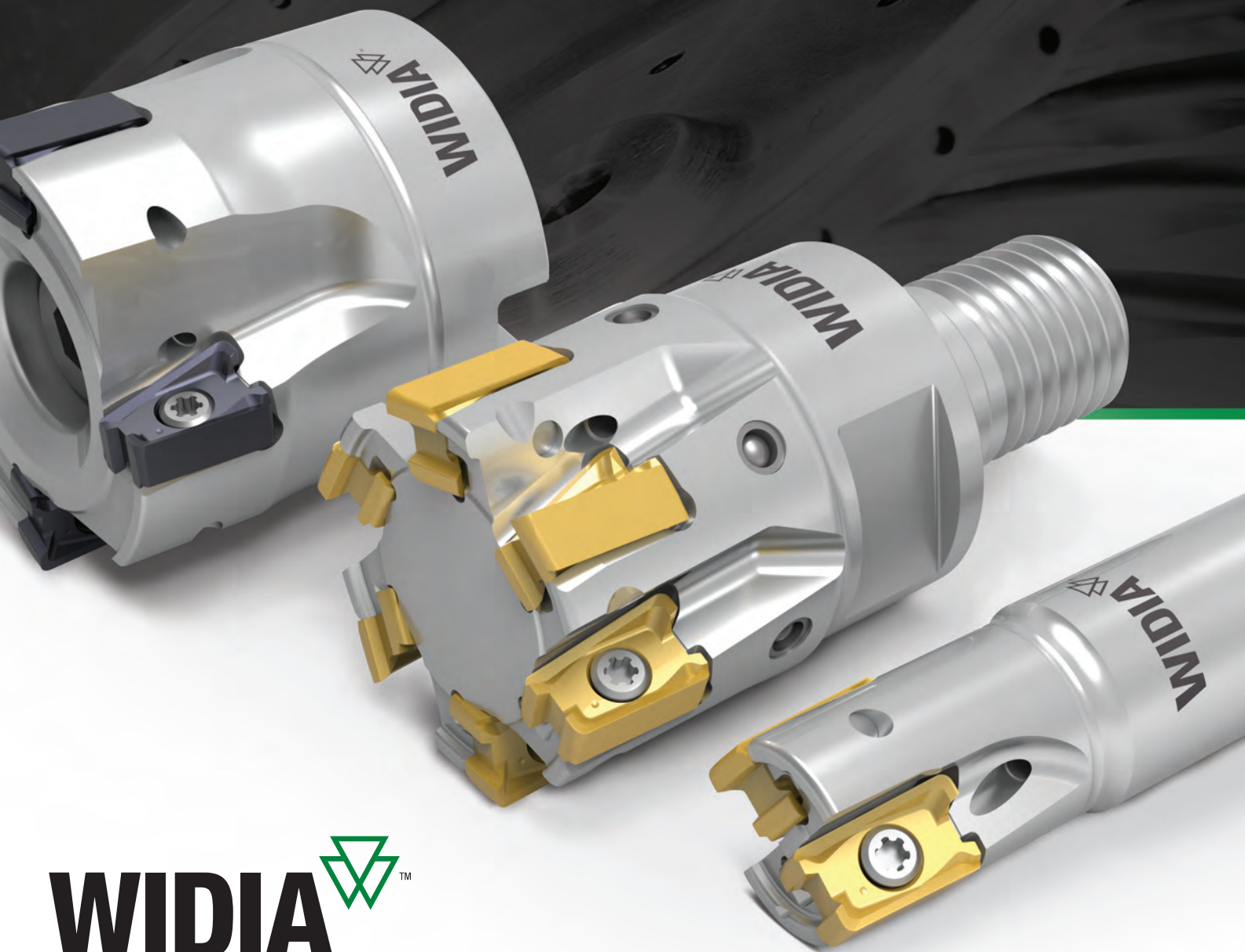

WIDIA 

Introducing...

NEW

PRODUCTS



TOP DRILL S™ for Stainless
Steel Drilling
pages 70–79



**2- and 4-flute General
Purpose End Mills**
pages 64–69



**Modular End Mills with a
Duo-Lock™ connection**
pages 46–62



widia.com

INDEXABLE MILLING 4-41

VSM490-10
VSM490-15
VSM11
VSM17
VHSC

SOLID END MILLING 46-69

VariMill Modular
GP

HOLEMAKING 70-79

TOP DRILL S

ORDERING INFORMATION 80-83

Icon Legend
Material Overview



VHSC Indexable Milling
Cutters for Aluminum
pages 34-41



VSM11™ Shoulder Mills
pages 16-24, 33



VSM17™ Shoulder Mills
pages 16, 26-33



VSM490™-10 Shoulder Mills
pages 4-11, 33



VSM490™-15 Shoulder Mills
pages 4, 12-15, 33

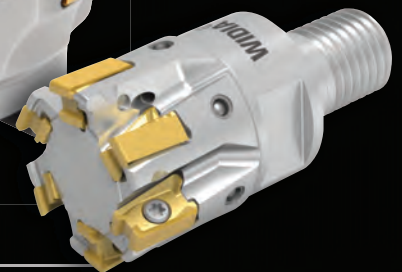

WIDIA 

AEROSPACE SOLUTIONS

Reduce Time, Increase Tool Life, and Relieve the Stress





WS40PM

Performance leader for advanced milling jobs in titanium, high-temp alloys, and stainless steels.

Page 25

VariMill II™ ER & VariMill III™ ER

Performance leader for advanced milling applications in exotic, aerospace materials.

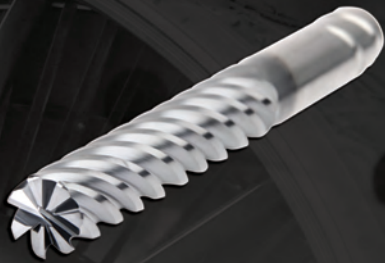

FS and MS Chipbreaker

High-performance solutions for turning nickel-, cobalt-, and Fe-based materials, as well as difficult-to-machine stainless steel and cobalt-chrome materials.



VariDrill™

The advanced-point geometry design offers the ultimate solution for drilling high-temp alloys.

IBR – Titanium 6AL-4V		
	Current Parameters	WIDIA™
Cycle time	75 min	18 min
Tool Life: # of parts	3	11
Cost savings	—	\$270,000/year

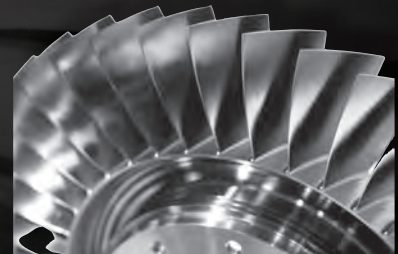

WIDIA 

widia.com

VSM49

The Ultimate Shoulder Milling Solution
for Step-Down Applications

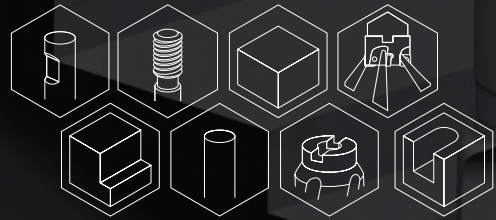

0TM

NEW!

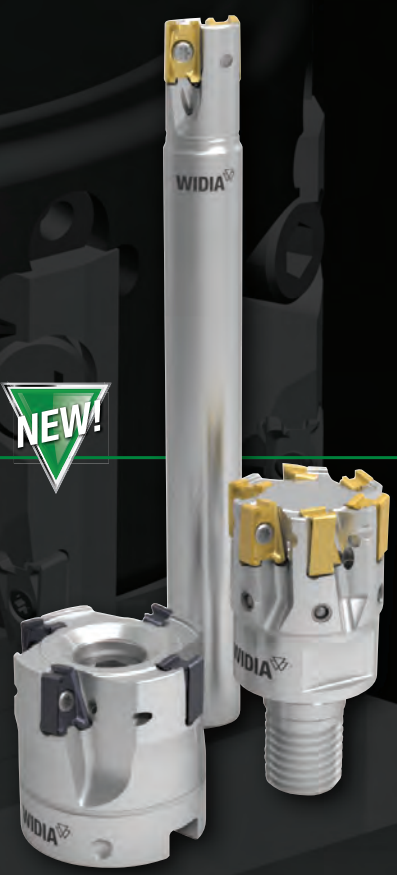

VSM490TM -10

- Ap Capabilities:** Up to .394"
- Weldon[®] End Mills:** .625–1.5"
- Cylindrical End Mills:** .625–1.5"
- Shell Mills:** 1.5–5.0"
- M4000 Cartridge Milling System:** 6–12"



VSM490TM -15

- Ap Capabilities:** Up to .591"
- Weldon End Mills:** 1–1.5"
- Cylindrical End Mills:** .625–1.5"
- Shell Mills:** 1.5–6.0"
- M4000 Cartridge Milling System:** 6–12"

4-Edged, Double-Sided 0° VictoryTM Shoulder Mill (VSM)

Delivers high surface quality and productivity in shoulder milling applications, including multiple passes (step-down) applications.

Eliminates finishing operations in many applications.

Versatile: steel, cast iron, stainless steel, titanium, aluminum; from roughing to finishing applications.

Double-sided strong insert with 4 cutting edges; high positive geometry for lower cutting forces.



widia.com

VSM490™ -10

4-Edged, Double-Sided 0° Victory Shoulder Mill



- True 0° roughing tool with embedded finishing capabilities all in one tool.
- Up to $A_{p1 \text{ max}} = .394"$.
- Best-in-class wall finish in axial stepping-down jobs.
- Lower cutting forces and real soft cutting action.
- Perfect fit for taper 40 spindles and driven units.

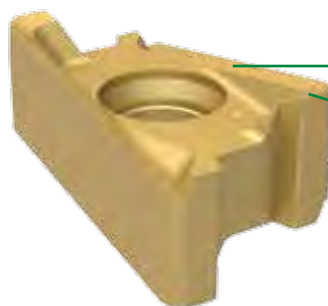

Super-positive rake design for low machine power consumption.

Integrated wiper facet for great surface floor finish.

Four insert geometries for all material groups in shoulder milling applications.

-ALP



N

For non-ferrous materials.

-ML



P M K S H

First choice for stainless steel, light machining, and finishing jobs.

-MM



P M K S H

First choice for general purpose in all material groups.

-MH



P K

First choice for HPC roughing cast iron. Strongest edge protection with additional margins.

Finishing Capabilities/Lower Cutting Forces

Geometry Strengthening

Applications

1. Face milling with modular M4000 cartridge milling system.
2. Full slotting with 100% radial engagement.
3. Shoulder milling with step-down capabilities and great wall finish.
4. Shoulder milling with low axial and high radial engagement.
5. Shoulder milling with low radial and high axial engagement.
6. HPC face milling. Excellent choice to clean up castings.
7. Trochoidal slot milling.
8. Z-axis plunge milling.
9. Contour milling.

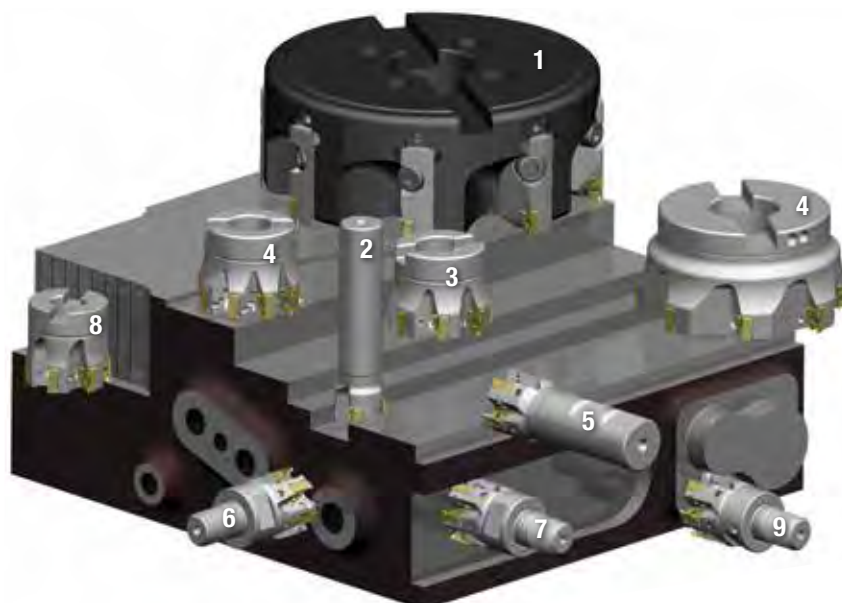

Victory™ Shoulder Mills • VSM490™-10 Series

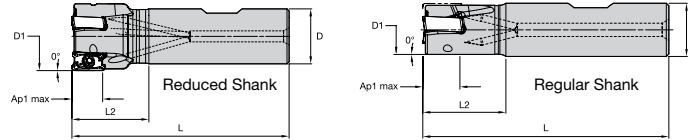

■ Weldon® End Mills

order number	catalog number	D1	D	L	L2	Ap1 max	Z	max RPM	coolant supply	lbs
6425459	VSM490D062Z02W062XN10	.625	.625	2.750	.844	.394	2	48000	Yes	.20
6425460	VSM490D075Z02W075XN10	.750	.750	3.250	1.220	.394	2	41700	Yes	.34
6425471	VSM490D075Z03W075XN10	.750	.750	3.250	1.220	.394	3	41700	Yes	.33
6425472	VSM490D100Z03W075XN10	1.000	.750	3.250	1.220	.394	3	33900	Yes	.39
6425473	VSM490D100Z03W100XN10	1.000	1.000	3.750	1.470	.394	3	33900	Yes	.71
6425474	VSM490D100Z04W100XN10	1.000	1.000	3.750	1.470	.394	4	33900	Yes	.71
6425475	VSM490D125Z04W075XN10	1.250	.750	3.250	1.220	.394	4	29200	Yes	.46
6425476	VSM490D125Z04W100XN10	1.250	1.000	3.750	1.470	.394	4	29200	Yes	.79
6425477	VSM490D125Z04W125XN10	1.250	1.250	4.000	1.720	.394	4	29200	Yes	1.20
6425478	VSM490D125Z05W125XN10	1.250	1.250	4.000	1.720	.394	5	29200	Yes	1.20
6425479	VSM490D150Z05W125XN10	1.500	1.250	4.500	2.220	.394	5	26200	Yes	1.48

NOTE: Weldon type not recommended for finishing operations.

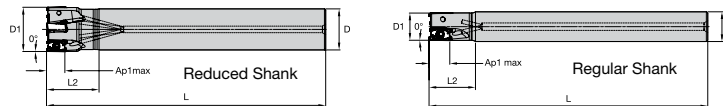

■ Cylindrical End Mills (Regular and Long Version)

order number	catalog number	D1	D	L	L2	Ap1 max	Z	max RPM	coolant supply	lbs
6425419	VSM490D062Z02C062XN10L360	.625	.625	3.600	.850	.394	2	48000	Yes	.27
6425420	VSM490D062Z02C062XN10L600	.625	.625	6.000	1.000	.394	2	48000	Yes	.47
6425442	VSM490D075Z02C075XN10L600	.750	.750	6.000	1.250	.394	2	41700	Yes	.67
6425441	VSM490D075Z03C075XN10L360	.750	.750	3.600	.900	.394	3	41700	Yes	.38
6425443	VSM490D075Z03C075XN10L600	.750	.750	6.000	1.250	.394	3	41700	Yes	.66
6425444	VSM490D100Z03C075XN10L400	1.000	.750	4.000	1.250	.394	3	33900	Yes	.49
6425446	VSM490D100Z03C100XN10L670	1.000	1.000	6.700	1.600	.394	3	33900	Yes	1.36
6425445	VSM490D100Z04C100XN10L400	1.000	1.000	4.000	1.250	.394	4	33900	Yes	.78
6425448	VSM490D100Z04C100XN10L670	1.000	1.000	6.700	1.600	.394	4	33900	Yes	1.35
6425450	VSM490D125Z04C075XN10L430	1.250	.750	4.300	1.600	.394	4	29200	Yes	.62
6425452	VSM490D125Z04C100XN10L430	1.250	1.000	4.300	1.600	.394	4	29200	Yes	.92
6425454	VSM490D125Z05C100XN10L430	1.250	1.000	4.300	1.600	.394	5	29200	Yes	.92
6425455	VSM490D125Z04C125XN10L800	1.250	1.250	8.000	1.900	.394	4	29200	Yes	2.58
6425456	VSM490D125Z05C125XN10L800	1.250	1.250	8.000	1.900	.394	5	29200	Yes	2.58
6425457	VSM490D150Z05C125XN10L800	1.500	1.250	8.000	2.000	.394	5	26200	Yes	2.69

VSM490™ -10

Victory™ Shoulder Mills • VSM490-10 Series

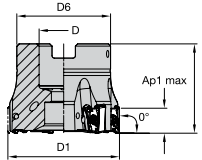

■ Shell Mills

order number	catalog number	D1	D	D6	L	Ap1 max	Z	max RPM	coolant supply	lbs
6425383	VSM490D150Z04S075XN10	1.500	.750	1.421	1.577	.394	4	26200	Yes	.44
6425384	VSM490D150Z06S075XN10	1.500	.750	1.421	1.577	.394	6	26200	Yes	.44
6425385	VSM490D150Z07S075XN10	1.500	.750	1.421	1.577	.394	7	26200	Yes	.42
6425386	VSM490D200Z05S075XN10	2.000	.750	1.750	1.577	.394	5	22100	Yes	.81
6425387	VSM490D200Z07S075XN10	2.000	.750	1.750	1.577	.394	7	22100	Yes	.81
6425388	VSM490D200Z09S075XN10	2.000	.750	1.750	1.577	.394	9	22100	Yes	.83
6425389	VSM490D250Z05S075XN10	2.500	.750	1.928	1.577	.394	5	22100	Yes	1.25
6425390	VSM490D250Z07S075XN10	2.500	.750	1.928	1.577	.394	7	22100	Yes	1.22
6425401	VSM490D250Z09S075XN10	2.500	.750	1.928	1.577	.394	9	22100	Yes	1.24
6425402	VSM490D300Z06S100XN10	3.000	1.000	2.190	1.750	.394	6	17600	Yes	2.06
6425403	VSM490D300Z08S100XN10	3.000	1.000	2.190	1.750	.394	8	17600	Yes	2.03
6425404	VSM490D300Z10S100XN10	3.000	1.000	2.190	1.750	.394	10	17600	Yes	2.05
6425405	VSM490D400Z08S150XN10	4.000	1.500	3.380	2.000	.394	8	15000	Yes	3.40
6425406	VSM490D400Z12S150XN10	4.000	1.500	3.380	2.000	.394	12	15000	Yes	3.37
6425407	VSM490D500Z10S150XN10	5.000	1.500	3.907	2.380	.394	10	13400	Yes	7.21
6425408	VSM490D500Z14S150XN10	5.000	1.500	3.907	2.380	.394	14	13400	Yes	7.19

■ Spare Parts

D1	insert screw	in. lbs.	wrench
.625 - 5.000	MS2263	13.3	DT91P

For M4000 cartridge milling system, please see page 33.



VSM490-10
M4000CA-XN10
(MM6433216)



Victory™ Shoulder Mills • VSM490™-10 Series

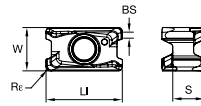

● first choice
○ alternate choice

P	■	■	■	○	●	●	○
M	■	■	■	○	●	●	○
K	■	■	■	○	○	○	●
N	■	■	■	○	○	○	○
S	■	■	■	○	○	○	○
H	■	■	■	○	○	○	○



■ VSM490-10 Series Inserts

catalog number	cutting edges	LI	S	W	BS	Rε	hm	WK15CM	WK15PM	WN25PM	WP35CM	WP40PM	WS40PM	WU10PM
XNGU100404ERALP	4	.459	.190	.260	.054	.016	.001	■	■	6425382	■	■	■	■
XNGU100408ERALP	4	.459	.190	.260	.039	.031	.001	■	■	6425411	■	■	■	■
XNGU100404ERML	4	.459	.190	.260	.054	.016	.001	■	■	■	6425414	■	■	■
XNGU100408ERML	4	.459	.190	.260	.039	.031	.001	■	■	■	6425369	6425415	6425370	6425421
XNGU100404SRMM	4	.459	.190	.260	.054	.016	.003	■	■	■	6425416	■	■	■
XNGU100408SRMM	4	.459	.190	.260	.039	.031	.003	■	■	■	6425422	■	■	6425423
XNGU100408SRMH	4	.459	.190	.260	.036	.032	.003	6425359	■	■	6425356	6425360	6425357	■
XNPU100408ERML	4	.457	.190	.260	.036	.031	.001	■	6425366	■	6425367	■	6425368	■
XNPU100408SRMM	4	.457	.190	.260	.036	.031	.003	6425364	6425270	■	6425361	6425365	6425363	■
XNPU100412SRMM	4	.457	.190	.260	.022	.047	.003	6425355	■	■	6425352	6425354	6425353	■
XNPU100416SRMM	4	.457	.190	.260	.002	.062	.003	■	■	■	■	6425267	6425269	6425268

NOTE: XNGU: High-precision periphery ground inserts.
XNPU: Precision-pressed and sintered-to-size inserts.

VSM490™ -10

Victory™ Shoulder Mills • VSM490-10 Series

■ Insert Selection Guide

Material Group	Light Machining		General Purpose		Heavy Machining	
	Geometry	Grade	Geometry	Grade	Geometry	Grade
P1-P2	XNGU-ML	WP40PM	XNPU-MM	WP40PM	XNPU-MM	WP40PM
P3-P4	XNGU-ML	WP40PM	XNPU-MM	WP40PM	XNPU-MM	WP40PM
P5-P6	XNGU-MM	WP25PM	XNPU-MM	WP35CM	XNPU-MM	WP40PM
M1-M2	XNGU-ML	WS40PM	XNGU-ML	WS40PM	XNPU-MM	WS40PM
M3	XNGU-ML	WS40PM	XNGU-ML	WS40PM	XNPU-MM	WS40PM
K1-K2	XNPU-ML	WK15PM	XNGU-MH	WK15CM	XNGU-MH	WK15CM
K3	XNPU-MM	WK15PM	XNGU-MH	WP35CM	XNGU-MH	WP35CM
N1-N2	XNGU-ALP	WN25PM	XNGU-ALP	WN25PM	XNGU-ALP	WN25PM
N3	XNGU-ALP	WN25PM	XNGU-ALP	WN25PM	XNGU-ALP	WN25PM
S1-S2	XNGU-ML	WP25PM	XNGU-ML	WS40PM	XNPU-MM	WS40PM
S3	XNGU-ML	WS40PM	XNGU-ML	WS40PM	XNPU-MM	WS40PM
S4	XNGU-ML	WS40PM	XNGU-ML	WS40PM	XNPU-MM	WS40PM
H1	XNGU-ML	WU10PM	XNGU-MM	WU10PM	-	-

■ Recommended Starting Speeds [SFM]*

Material Group		WK15CM			WK15PM			WN25PM			WP25PM			WP35CM			WP40PM			WS40PM			WU10PM		
P	1	-	-	-	-	-	-	-	-	-	1085	935	885	1495	1295	1215	970	855	805	-	-	-	-	-	-
	2	-	-	-	-	-	-	-	-	-	900	785	655	920	835	755	820	705	590	-	-	-	-	-	-
	3	-	-	-	-	-	-	-	-	-	835	705	575	835	755	675	755	640	525	-	-	-	-	-	-
	4	-	-	-	-	-	-	-	-	-	740	605	490	625	575	525	675	560	445	-	-	-	-	-	-
	5	-	-	-	-	-	-	-	-	-	605	560	490	855	755	690	560	510	445	560	475	395	-	-	-
	6	-	-	-	-	-	-	-	-	-	540	410	330	525	445	360	490	375	295	490	360	260	-	-	-
M	1	-	-	-	-	-	-	-	-	-	675	590	540	675	605	510	640	560	460	690	560	460	-	-	-
	2	-	-	-	-	-	-	-	-	-	605	525	425	605	525	460	575	490	410	590	475	395	-	-	-
	3	-	-	-	-	-	-	-	-	-	460	395	310	475	425	375	425	375	295	475	360	280	-	-	-
K	1	1380	1265	1115	885	805	705	-	-	-	755	675	605	970	870	785	-	-	-	-	-	-	970	870	785
	2	1100	970	900	690	625	575	-	-	-	590	525	490	770	690	625	-	-	-	-	-	-	755	675	625
	3	920	820	755	575	525	475	-	-	-	490	445	395	640	575	525	-	-	-	-	-	-	640	575	525
N	1	-	-	-	-	-	-	3525	3100	2870	-	-	-	-	-	-	-	-	-	-	-	-	-	-	-
	2	-	-	-	-	-	-	3100	2870	2495	-	-	-	-	-	-	-	-	-	-	-	-	-	-	-
	3	-	-	-	-	-	-	3100	2870	2495	-	-	-	-	-	-	-	-	-	-	-	-	-	-	-
S	1	-	-	-	-	-	-	-	-	-	130	115	80	-	-	-	-	-	-	130	115	80	-	-	-
	2	-	-	-	-	-	-	-	-	-	130	115	80	-	-	-	-	-	-	130	115	80	-	-	-
	3	-	-	-	-	-	-	-	-	-	165	130	80	-	-	-	-	-	-	165	130	80	-	-	-
	4	-	-	-	-	-	-	-	-	-	230	165	115	-	-	-	-	-	-	195	165	100	-	-	-
H	1	-	-	-	-	-	-	-	-	-	-	-	-	-	-	-	-	-	-	-	-	-	525	425	295

NOTE: FIRST choice starting speeds are in **bold** type. As the average chip thickness increases, the speed should be decreased.
 *Material groups P, M, K, and H show recommended starting speeds for dry machining. For wet machining, reduce speed by 20%.
 *Material groups N and S show recommended starting speeds for wet machining. Not recommended for dry machining.

■ Recommended Starting Feeds [IPT]

Light Machining	General Purpose	Heavy Machining
-----------------	-----------------	-----------------

Insert Geometry	Programmed Feed per Tooth (fz) as a % of Radial Depth of Cut (ae)															Insert Geometry
	5%			10%			20%			30%			40-100%			
.E..ALP	.005	.009	.013	.003	.007	.009	.003	.005	.007	.002	.004	.006	.002	.004	.006	.E..ALP
.E..ML	.007	.011	.015	.005	.008	.011	.004	.006	.008	.003	.005	.007	.003	.005	.006	.E..ML
.S..MM	.009	.014	.018	.007	.010	.013	.005	.007	.010	.004	.006	.008	.004	.006	.008	.S..MM
.S..MH	.009	.016	.022	.007	.012	.016	.005	.009	.012	.004	.008	.010	.004	.007	.010	.S..MH

NOTE: Use "Light Machining" values as starting feed rate.

Victory™ Shoulder Mills • VSM490™-10 Series

Best Practices

Best-in-class wall finish with VSM490-10 at axial stepping-down jobs. For many shop floor setups, no additional finishing is required and has a positive impact on shorter machining time and lower tooling cost.

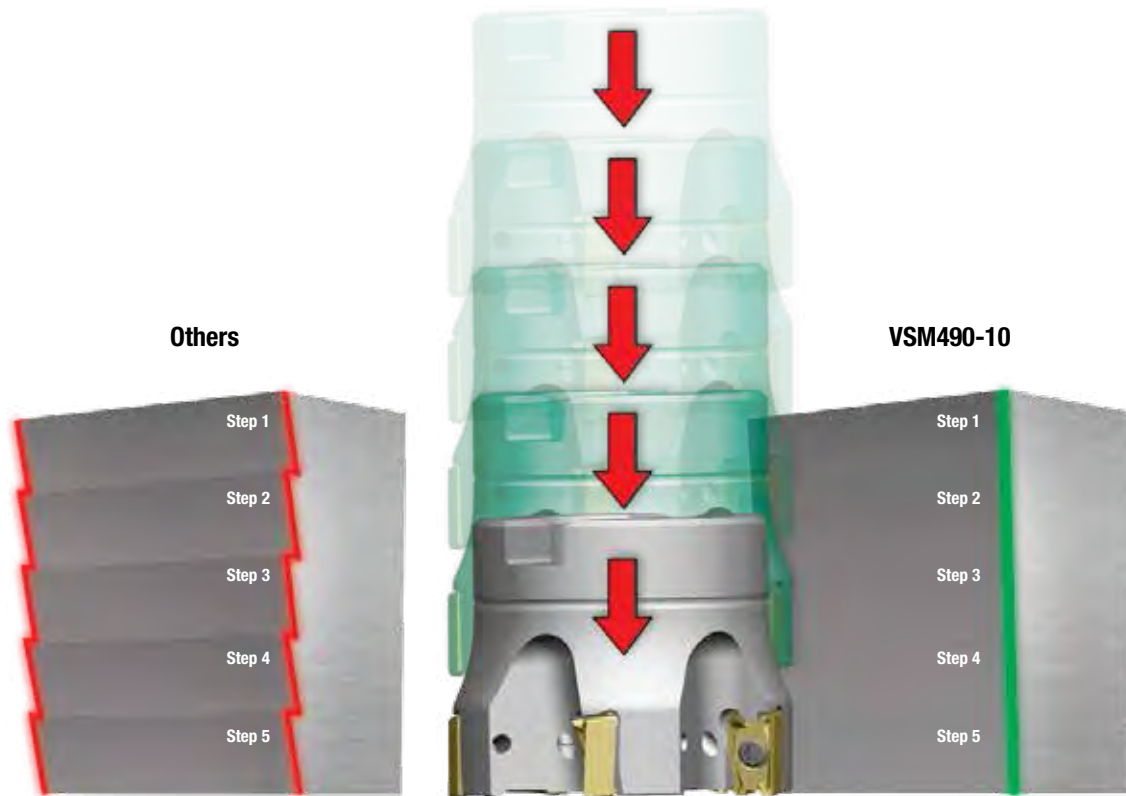

Excellent wall finish with VSM490-10

■ VSM490-10 Z-Axis Plunge Milling

cutting diameter (D1)	Z max	Y
0.625	.059	.076
0.750	.059	.083
1.000	.059	.096
1.250	.059	.107
1.500	.059	.118
2.000	.059	.136
2.500	.059	.152
3.000	.059	.166
4.000	.059	.192
5.000	.059	.215

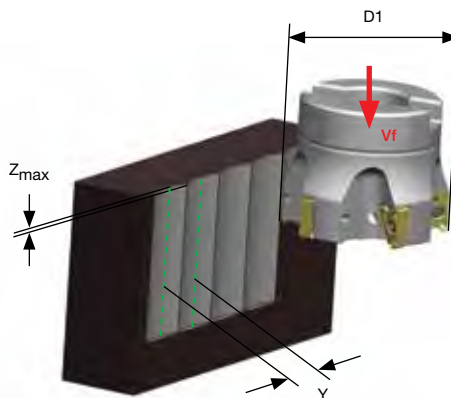

VSM490™ -15

4 Edged, Double-Sided 0° Victory Shoulder Mill



- True 0° roughing tool with embedded finishing capabilities all in one tool.
- Up to Ap1 max = .591".
- Best-in-class wall finish in axial stepping-down jobs.
- Lower cutting forces and real soft cutting action.
- Perfect fit for taper 50 spindles.
- Coarse, medium, and fine pitch shell mills available.

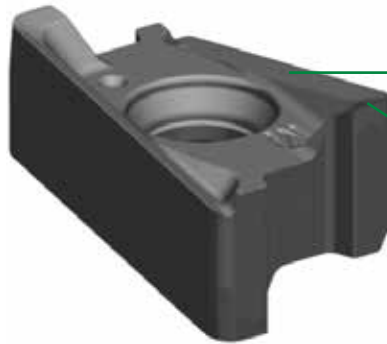





Super-positive rake design for low machine power consumption.

Integrated wiper facet for great surface floor finish.



See me in action!

Four geometries for all material groups in shoulder milling applications.

<p>-ALP</p>  <p>N</p> <p>For non-ferrous materials.</p>	<p>-ML</p>  <p>P M S</p> <p>First choice for stainless steel. Lower cutting forces.</p>	<p>-MM</p>  <p>P M K S</p> <p>First choice, especially when machining steels.</p>	<p>-MH</p>  <p>P K</p> <p>First choice for cast iron, and also recommended for heavy applications.</p>
---	---	---	--

Finishing Capabilities/Lower Cutting Forces

Geometry Strengthening

Wall Quality

Competitor Tool

Traditional tools are designed to achieve a 0° wall, but exhibit poor performance when machining walls in multiple passes.



VSM490-15

VSM490-15 eliminates the mismatch and minimizes the marks left behind in step-down milling operations. By increasing wall quality and avoiding a second tool, productivity increases significantly.



Victory™ Shoulder Mills • VSM490™ -15 Series

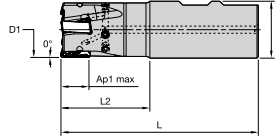

Weldon® End Mills

order number	catalog number	D1	D	L	L2	Ap1 max	Z	max RPM	coolant supply	lbs
5873069	VSM490D100Z02W075XN15	1.000	.750	3.780	1.750	.591	2	26300	Yes	.92
5710590	VSM490D100Z02W100XN15	1.000	1.000	4.030	1.750	.591	2	26300	Yes	.73
5710591	VSM490D125Z03W100XN15	1.250	1.000	4.530	2.250	.591	3	22100	Yes	.90
5873070	VSM490D150Z03W125XN15	1.500	1.250	4.530	2.250	.591	3	19500	Yes	1.41
5710592	VSM490D150Z04W125XN15	1.500	1.250	4.530	2.250	.591	4	19500	Yes	1.42

NOTE: Weldon type not recommended for finishing operations.

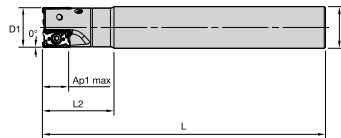

Cylindrical End Mills

order number	catalog number	D1	D	L	L2	Ap1 max	Z	max RPM	coolant supply	lbs
5873101	VSM490D100Z02C100XN15L800	1.000	1.000	8.000	1.750	.591	2	26300	Yes	1.60
5873102	VSM490D125Z03C125XN15L800	1.250	1.250	8.000	2.250	.591	3	22100	Yes	2.50
5873103	VSM490D150Z04C125XN15L800	1.500	1.250	8.000	2.250	.591	4	19500	Yes	2.61

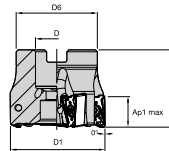

Shell Mills

order number	catalog number	D1	D	D6	L	Ap1 max	Z	max RPM	coolant supply	lbs
5710593	VSM490D150Z05S050XN15	1.500	.500	1.420	1.575	.591	5	19500	Yes	.43
5710594	VSM490D200Z05S075XN15	2.000	.750	1.750	1.575	.591	5	16100	Yes	.78
5710595	VSM490D200Z06S075XN15	2.000	.750	1.750	1.575	.591	6	16100	Yes	.77
5873104	VSM490D250Z05S075XN15	2.500	.750	1.750	1.575	.591	5	14100	Yes	1.11
5710596	VSM490D250Z06S075XN15	2.500	.750	1.750	1.575	.591	6	14100	Yes	1.06
5710597	VSM490D250Z07S100XN15	2.500	1.000	2.190	1.750	.591	7	14100	Yes	1.31
5710598	VSM490D300Z07S100XN15	3.000	1.000	2.190	1.750	.591	7	12700	Yes	1.83
5873105	VSM490D300Z09S100XN15	3.000	1.000	2.190	1.750	.591	9	12700	Yes	1.85
5873106	VSM490D400Z08S150XN15	4.000	1.500	3.380	2.000	.591	8	10800	Yes	3.31
5710599	VSM490D400Z11S150XN15	4.000	1.500	3.380	2.000	.591	11	10800	Yes	3.26
5873107	VSM490D500Z09S150XN15	5.000	1.500	3.907	2.380	.591	9	9600	Yes	7.67
5873108	VSM490D500Z12S150XN15	5.000	1.500	3.907	2.380	.591	12	9600	Yes	6.83
5873109	VSM490D600Z10S200XN15	6.000	2.000	4.880	2.380	.591	10	8600	Yes	10.42

Spare Parts

D1	insert screw	in. lbs.	wrench
1.000 - 6.000	MS-2071	31	DT151P

For M4000 cartridge milling system, please see page 33.



VSM490™ -15
M4000CA-XN15
(MM6357989)



VSM490™ -15

Victory™ Shoulder Mills • VSM490-15 Series

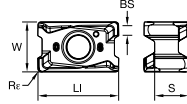

● first choice
○ alternate choice

P	■	■	■	○	●	○	○
M	■	■	○	○	○	○	○
K	■	■	○	○	○	○	○
N	■	■	○	○	○	○	○
S	■	■	○	○	○	○	○
H	■	■	○	○	○	○	○

VSM490-15 Series Inserts

catalog number	cutting edges	LI	W	S	BS	Re	hm	WK15CM	WK15PM	WN25PM	WP25PM	WP35CM	WP40PM	WS40PM	WU35PM
XNGU1501ERALP	4	.638	.394	.271	.088	.016	.001	■	■	6082644	■	■	■	■	■
XNGU1502ERALP	4	.638	.394	.271	.072	.032	.001	■	■	6082645	■	■	■	■	■
XNGU1501ERML	4	.638	.394	.271	.088	.016	.003	■	■	■	5890821	■	■	■	■
XNGU1502ERML	4	.638	.394	.271	.072	.032	.003	■	6242523	■	5873481	■	5873482	6180324	5890823
XNGU1501SRMM	4	.638	.394	.271	.088	.016	.004	■	■	6242521	■	5949204	■	5949205	■
XNGU1502SRMM	4	.638	.394	.271	.073	.031	.004	■	6242522	■	5710527	■	5710528	■	5710529
XNGU1503SRMM	4	.638	.394	.271	.058	.047	.003	6234707	■	■	■	■	■	■	■
XNGU1502SRMH	4	.638	.394	.271	.069	.031	.004	6003725	6003724	■	6003570	6003723	6003721	■	6003722
XNGU1504SRMH	4	.638	.394	.271	.040	.063	.004	6030380	6030378	■	6030376	6030377	■	■	■
XNPU1502ERML	4	.634	.394	.271	.073	.032	.003	■	■	■	5883097	■	5883098	■	■
XNPU1502SRMM	4	.634	.394	.271	.076	.032	.004	5873420	5873419	■	5890728	5873415	5873418	5873416	6180320
XNPU1503SRMM	4	.634	.394	.271	.059	.047	.004	5890763	5890762	■	5890761	5890729	5873416	6180321	5890730
XNPU1504SRMM	4	.634	.394	.271	.045	.063	.004	5883522	5883521	■	5883447	5883450	5883448	6180322	5883449
XNPU1505SRMM	4	.634	.394	.271	.027	.079	.004	6030375	■	■	6030372	6030374	6030373	■	■

NOTE: XNGU: High-precision periphery ground inserts.
XNPU: Precision-pressed and sintered-to-size inserts.



Victory™ Shoulder Mills • VSM490™-15 Series

Insert Selection Guide

Material Group	Light Machining		General Purpose		Heavy Machining	
	Geometry	Grade	Geometry	Grade	Geometry	Grade
P1-P2	XNGU-ML	WP40PM	XNPU-MM	WP40PM	XNPU-MM	WP40PM
P3-P4	XNGU-ML	WP40PM	XNPU-MM	WP40PM	XNPU-MM	WP40PM
P5-P6	XNGU-MM	WP25PM	XNPU-MM	WP35CM	XNPU-MM	WP40PM
M1-M2	XNGU-ML	WS40PM	XNGU-ML	WS40PM	XNPU-MM	WS40PM
M3	XNGU-ML	WS40PM	XNGU-ML	WS40PM	XNPU-MM	WS40PM
K1-K2	XNPU-MM	WK15PM	XNGU-MH	WK15CM	XNGU-MH	WK15CM
K3	XNPU-MM	WK15PM	XNGU-MH	WP35CM	XNGU-MH	WP35CM
N1-N2	XNGU-ALP	WN25PM	XNGU-ALP	WN25PM	XNGU-ALP	WN25PM
N3	XNGU-ALP	WN25PM	XNGU-ALP	WN25PM	XNGU-ALP	WN25PM
S1-S2	XNGU-ML	WP25PM	XNGU-ML	WS40PM	XNPU-MM	WS40PM
S3	XNGU-ML	WS40PM	XNGU-ML	WS40PM	XNPU-MM	WS40PM
S4	XNGU-ML	WS40PM	XNGU-ML	WS40PM	XNPU-MM	WS40PM
H1	-	-	-	-	-	-

Recommended Starting Speeds [SFM]*

Material Group		WK15CM			WK15PM			WN25PM			WP25PM			WP35CM			WP40PM			WS40PM			WU35PM		
		1	2	3	1	2	3	1	2	3	1	2	3	1	2	3	1	2	3	1	2	3	1	2	3
P	1	-	-	-	-	-	-	-	-	-	1085	935	885	1495	1295	1215	970	855	805	-	-	-	855	755	705
	2	-	-	-	-	-	-	-	-	-	900	785	655	920	835	755	820	705	590	-	-	-	720	625	525
	3	-	-	-	-	-	-	-	-	-	835	705	575	835	755	675	755	640	525	-	-	-	655	560	460
	4	-	-	-	-	-	-	-	-	-	740	605	490	625	575	525	675	560	445	-	-	-	590	490	395
	5	-	-	-	-	-	-	-	-	-	605	560	490	855	755	690	560	510	445	560	475	395	490	445	395
	6	-	-	-	-	-	-	-	-	-	540	410	330	525	445	360	490	375	295	490	360	260	425	330	260
M	1	-	-	-	-	-	-	-	-	-	675	590	540	675	605	510	640	560	510	690	560	460	560	490	445
	2	-	-	-	-	-	-	-	-	-	605	525	425	605	525	460	575	490	410	590	475	395	510	425	360
	3	-	-	-	-	-	-	-	-	-	460	395	310	475	425	375	425	375	295	475	360	280	375	330	260
K	1	1380	1265	1115	885	805	705	-	-	-	755	675	605	970	870	785	-	-	-	-	-	-	-	-	-
	2	1100	970	900	690	625	575	-	-	-	590	525	490	770	690	625	-	-	-	-	-	-	-	-	-
	3	920	820	755	575	525	475	-	-	-	490	445	395	640	575	525	-	-	-	-	-	-	-	-	-
N	1	-	-	-	-	-	-	3525	3100	2870	-	-	-	-	-	-	-	-	-	-	-	-	-	-	-
	2	-	-	-	-	-	-	3100	2870	2495	-	-	-	-	-	-	-	-	-	-	-	-	-	-	-
	3	-	-	-	-	-	-	3100	2870	2495	-	-	-	-	-	-	-	-	-	-	-	-	-	-	-
S	1	-	-	-	-	-	-	-	-	-	130	115	80	-	-	-	-	-	-	130	115	80	115	100	80
	2	-	-	-	-	-	-	-	-	-	130	115	80	-	-	-	-	-	-	130	115	80	115	100	80
	3	-	-	-	-	-	-	-	-	-	165	130	80	-	-	-	-	-	-	165	130	80	150	115	80
	4	-	-	-	-	-	-	-	-	-	230	165	115	-	-	-	-	-	-	195	165	100	195	150	100
H	1	-	-	-	-	-	-	-	-	-	395	295	230	-	-	-	-	-	-	-	-	-	-	-	-

NOTE: FIRST choice starting speeds are in **bold** type. As the average chip thickness increases, the speed should be decreased.
 *Material groups P, M, K, and H show recommended starting speeds for dry machining. For wet machining, reduce speed by 20%.
 *Material groups N and S show recommended starting speeds for wet machining. Not recommended for dry machining.

Recommended Starting Feeds [IPT]

Light Machining	General Purpose	Heavy Machining
-----------------	-----------------	-----------------

Insert Geometry	Programmed Feed per Tooth (fz) as a % of Radial Depth of Cut (ae)															Insert Geometry
	5%			10%			20%			30%			40-100%			
.E..ALP	.005	.008	.012	.003	.006	.009	.002	.004	.007	.002	.004	.006	.002	.004	.005	.E..ALP
.E..ML	.007	.012	.018	.005	.009	.013	.004	.006	.010	.003	.006	.008	.003	.005	.008	.E..ML
.S..MM	.008	.015	.024	.006	.011	.017	.005	.008	.013	.004	.007	.011	.004	.007	.010	.S..MM
.S..MH	.009	.017	.028	.006	.012	.020	.005	.009	.015	.004	.008	.013	.004	.007	.012	.S..MH

NOTE: Use "Light Machining" values as starting feed rate.

Best Practices

VSM490-15 Z-Axis Plunge

cutting diameter (D1)	Z max	Y	cutting diameter (D1)	Z max	Y
1.000	.094	.121	3.000	.094	.211
1.250	.094	.136	4.000	.094	.243
1.500	.094	.149	5.000	.094	.272
2.000	.094	.172	6.000	.094	.298
2.500	.094	.192			

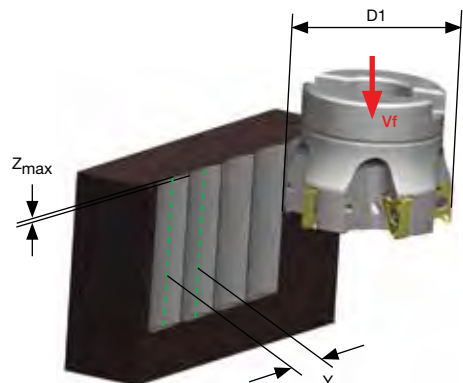

VSM

The Most Versatile 0° Shoulder Mill
Platform in the WIDIA™ Portfolio.

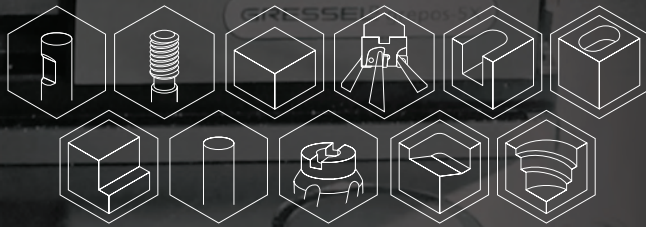



VSM11™

Ap Capabilities: Up to .453"

Screw-On End Mills: .75–1.5"

Weldon® End Mills: .625–1.25"

Cylindrical End Mills: .5–1.25"

Shell Mills: 1.5–4"

Helical Cutters: 1–2"

M4000 Cartridge Milling System: 6–12"



VSM17™

Ap Capabilities: Up to .638"

Screw-On End Mills: 1–1.5"

Weldon End Mills: 1–1.5"

Cylindrical End Mills: 1–1.5"

Shell Mills: 1.5–6"

Helical Cutters: 2–2.5"

M4000 Cartridge Milling System: 6–12"

2-Edged, 0° Victory™ Shoulder Mill (VSM)

High-performance, robust, highly positive, 0° shoulder milling platform with advanced ramping capability.

Delivers low horsepower consumption, versatility, and soft cutting action.

Latest WIDIA™ Victory grades, 4 geometries, and a well-rounded steel body portfolio covers multiple material types and applications from light, precise machining to medium roughing.

WIDIA 

widia.com

VSM11™

2 Edged, 0° Victory™ Shoulder Mill (VSM)



- True 0° shoulder milling platform; up to Ap1 max = .453".
- Aggressive ramping capability up to 12.5° with end mills with a diameter of .625".
- Optimized chip gash for improved cutter stability and chip flow.
- Well-guided internal coolant supply to the cutting edge.
- Best-in-class milling grade WS40PM boosts productivity when machining stainless steel and high-temp alloys.

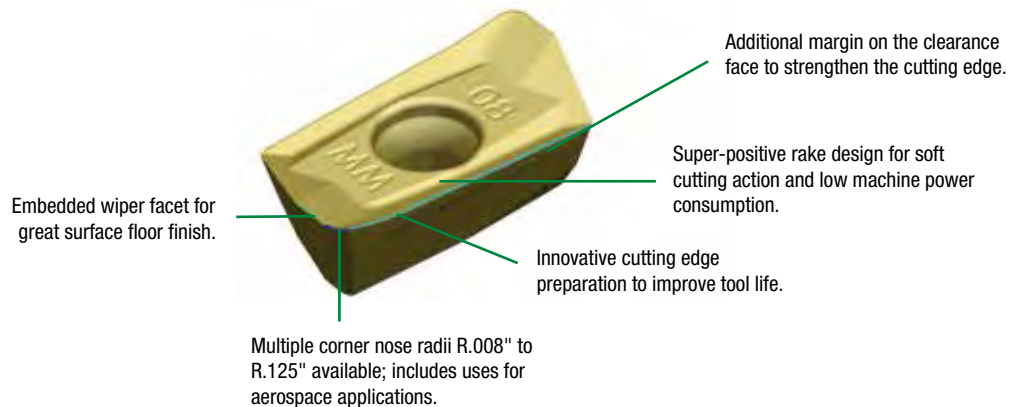

See me in action!

Geometries for all material groups in shoulder milling applications.

<p>-ALP</p>  <p>N</p>	<p>-PCD</p>  <p>N</p>	<p>-ML</p>  <p>P M S H</p>	<p>-MM</p>  <p>P M K S H</p>	<p>-MH</p>  <p>P M K S</p>
<p>Roughing and finishing of aluminum alloys. High precision. Periphery ground.</p>	<p>Roughing and finishing of aluminum alloys. Abrasive non-ferrous materials. High precision. Periphery ground.</p>	<p>Light machining and finishing. First choice for stainless steel and titanium. Periphery ground.</p>	<p>Medium machining. First choice for general purpose. Precision pressed to size.</p>	<p>First choice for heavy-duty machining. Steel and cast iron materials. Precision pressed to size.</p>

Finishing Capabilities/Lower Cutting Forces

Geometry Strengthening

Victory™ Shoulder Mills • VSM11™ Series

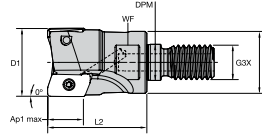

■ Screw-On End Mills

order number	catalog number	D1	D	DPM	G3X	L2	WF	Ap1 max	Z	max ramp angle	max RPM	coolant supply	lbs
5416990	VSM11D075Z03M10XD11	.750	.710	.410	M10	1.100	.590	.455	3	8.6°	36300	Yes	.09
5416991	VSM11D100Z04M12XD11	1.000	.827	.490	M12	1.250	.670	.453	4	5.1°	29900	Yes	.18
5416992	VSM11D125Z04M16XD11	1.250	1.140	.670	M16	1.500	.940	.451	4	3.6°	25900	Yes	.39
5416993	VSM11D150Z06M16XD11	1.500	1.142	.670	M16	1.500	.940	.449	6	1.9°	23300	Yes	.48

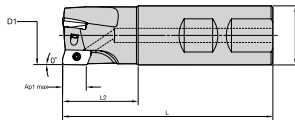

■ Weldon® End Mills

order number	catalog number	D1	D	L	L2	Ap1 max	Z	max ramp angle	max RPM	coolant supply	lbs
5416416	VSM11D062Z02W062XD11	.625	.625	2.750	.844	.454	2	12.5°	41700	Yes	.18
5416417	VSM11D075Z02W075XD11	.750	.750	3.200	1.170	.455	2	8.6°	36300	Yes	.30
5416418	VSM11D075Z03W075XD11	.750	.750	3.200	1.170	.455	3	8.6°	36300	Yes	.31
6025663	VSM11D100Z03W075XD11	1.000	.750	3.250	1.220	.453	3	5.1°	29900	Yes	.37
5416419	VSM11D100Z03W100XD11	1.000	1.000	3.500	1.220	.453	3	5.1°	29900	Yes	.62
5416450	VSM11D100Z04W100XD11	1.000	1.000	3.500	1.220	.453	4	5.1°	29900	Yes	.64
5416451	VSM11D125Z04W125XD11	1.250	1.250	4.000	1.720	.451	4	3.6°	25900	Yes	1.12
5416452	VSM11D125Z05W125XD11	1.250	1.250	4.000	1.720	.451	5	3.6°	25900	Yes	1.12

NOTE: Weldon type not recommended for finishing operations.

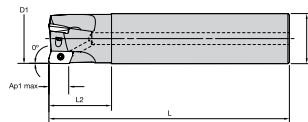

■ Cylindrical End Mills (Regular and Long Version)

order number	catalog number	D1	D	L	L2	Ap1 max	Z	max ramp angle	max RPM	coolant supply	lbs
5416485	VSM11D050Z01C062XD11L400	.500	.625	4.000	.800	.461	1	4.2°	50400	Yes	.29
5416486	VSM11D062Z02C062XD11L400	.625	.625	4.000	1.000	.454	2	12.5°	41700	Yes	.28
5416487	VSM11D075Z02C075XD11L450	.750	.750	4.500	1.100	.455	2	8.6°	36300	Yes	.46
5416726	VSM11D075Z02C075XD11L670	.750	.750	6.700	1.610	.455	2	8.6°	36300	Yes	.69
5416488	VSM11D075Z03C075XD11L450	.750	.750	4.500	1.100	.455	3	8.6°	36300	Yes	.47
5416727	VSM11D075Z03C075XD11L670	.750	.750	6.700	1.610	.455	3	8.6°	36300	Yes	.70
6025664	VSM11D100Z03C075XD11L480	1.000	.750	4.800	1.282	.453	3	5.1°	29900	Yes	—
5416489	VSM11D100Z03C100XD11L480	1.000	1.000	4.800	1.250	.453	3	5.1°	29900	Yes	.90
5416728	VSM11D100Z03C100XD11L800	1.000	1.000	8.000	2.100	.453	3	5.1°	29900	Yes	1.54
5416520	VSM11D100Z04C100XD11L480	1.000	1.000	4.800	1.250	.453	4	5.1°	29900	Yes	.92
5416729	VSM11D100Z04C100XD11L800	1.000	1.000	8.000	2.100	.453	4	5.1°	29900	Yes	1.56
5416750	VSM11D125Z03C125XD11L980	1.250	1.250	9.800	2.510	.451	3	3.6°	25900	Yes	3.00
5416522	VSM11D125Z05C125XD11L520	1.250	1.250	5.200	1.600	.451	5	3.6°	25900	Yes	1.56

NOTE: Standard milling cutters will accept insert nose radii up to .062" without modification. For tool body modification instructions, see page 24.

VSM11™

Victory™ Shoulder Mills • VSM11 Series

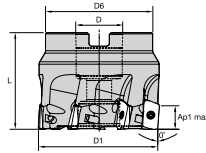

■ Shell Mills

order number	catalog number	D1	D	D6	L	Ap1 max	Z	max ramp angle	max RPM	coolant supply	lbs
5416391	VSM11D150Z04S075XD11	1.500	.750	1.420	1.575	.449	4	2.8°	23300	Yes	.41
5416392	VSM11D150Z06S075XD11	1.500	.750	1.420	1.575	.449	6	2.8°	23300	Yes	.42
5416393	VSM11D200Z05S075XD11	2.000	.750	1.750	1.575	.446	5	1.9°	19700	Yes	.79
5416394	VSM11D200Z08S075XD11	2.000	.750	1.750	1.575	.446	8	1.9°	19700	Yes	.80
5416395	VSM11D250Z06S075XD11	2.500	.750	1.750	1.575	.446	6	1.5°	17400	Yes	1.19
5416396	VSM11D250Z09S075XD11	2.500	.750	1.750	1.575	.446	9	1.5°	17400	Yes	1.21
5416397	VSM11D300Z08S100XD11	3.000	1.000	2.190	1.750	.446	8	1.2°	15700	Yes	1.96
5416399	VSM11D400Z09S150XD11	4.000	1.500	3.380	2.000	.446	9	.9°	13500	Yes	3.95

NOTE: Standard milling cutters will accept insert nose radii up to .062" without modification.
For tool body modification instructions, see page 24.

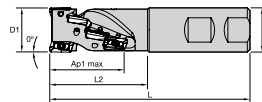

■ Helical End Mill with Weldon® Shank

order number	catalog number	D1	D	L	L2	Ap1 max	Z	Z U	max ramp angle	max RPM	coolant supply	lbs
6081720	VHM11D100Z02W225XD11	1.000	1.000	4.530	2.250	1.700	8	2	4.4°	29900	Yes	.74

NOTE: Z = number of pockets;
ZU = number of flutes.

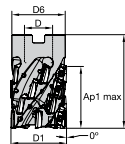

■ Helical Shell Mills

order number	catalog number	D1	D	D6	L	Ap1 max	Z	Z U	max ramp angle	max RPM	coolant supply	lbs
6081971	VHM11D150Z05S250XD11	1.500	.750	1.420	2.500	1.654	20	5	2.5°	23300	Yes	.65
6081972	VHM11D200Z04S300XD11	2.000	1.000	1.910	3.000	2.032	20	4	1.8°	19700	Yes	1.68
6081973	VHM11D200Z06S300XD11	2.000	1.000	1.910	3.000	2.032	30	6	1.8°	19700	Yes	1.60

NOTE: Z = number of pockets;
ZU = number of flutes.

■ Spare Parts

D1	insert screw	in. lbs.	wrench
.500 - 4.000	192.432	9	170.028

For M4000 cartridge milling system, please see page 33.



VSM11
M4000CA-XDPT11
(MM6152926)



Victory™ Shoulder Mills • VSM11™ Series



■ Inserts for VSM11 Series

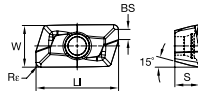

- first choice
- alternate choice

P	■						○	○	○	○	
M	■						○	○	○	○	
K	■	●	●				○	○	○	○	
N	■	●		●	●						
S	■						○	○	○	○	
H	■										

catalog number	cutting edges	LI	BS	S	W	R _ε	hm	WDN10U	WK15CM	WK15PM	WN10HM	WN25PM	WP25PM	WP35CM	WP40PM	WS30PM	WS40PM	WU35PM
								5415420	5415421									
XDCW1101RPCD	1	.529	.083	.157	.272	.016	.001	■	■	■	■	■	■	■	■	■	■	■
XDCW1102RPCD	1	.529	.067	.157	.272	.031	.001	■	■	■	■	■	■	■	■	■	■	■
XDCT1100RALP	2	.529	.090	.157	.272	.008	—	■	■	■	6407444	6407444	■	■	■	■	■	■
XDCT1101RALP	2	.529	.082	.157	.272	.016	.001	■	■	■	5933940	5933940	■	■	■	■	■	■
											5417054	5417054	■	■	■	■	■	■
XDCT1102RALP	2	.529	.067	.157	.272	.031	.001	■	■	■	6055634	6055634	■	■	■	■	■	■
XDCT1103RALP	2	.529	.051	.157	.272	.047	.001	■	■	■	6055635	6055635	■	■	■	■	■	■
XDCT1104RALP	2	.529	.035	.157	.271	.063	.001	■	■	■	6055598	6055598	■	■	■	■	■	■
XDCT1105RALP	2	.529	.019	.157	.271	.078	—	■	■	■	6407446	6407447	■	■	■	■	■	■
XDCT1106RALP	2	.529	.006	.157	.271	.095	.001	■	■	■	6055600	6055600	■	■	■	■	■	■
XDCT1108RALP	2	.506	—	.157	.271	.125	.001	■	■	■	6055632	6055633	■	■	■	■	■	■
XDCT1101ERML	2	.529	.082	.157	.272	.016	.002	■	■	■	6242456	6242456	■	■	■	■	■	■
XDCT1102ERML	2	.529	.067	.157	.272	.031	.002	■	5415549	6242457	■	■	■	■	■	■	■	■
											5415548	5536671	■	■	■	■	■	■
											5415547	5536670	■	■	■	■	■	■
											5545065	5642230	■	■	■	■	■	■
											5517826	6180174	■	■	■	■	■	■
											6408003	6408003	■	■	■	■	■	■
XDCT1103ERML	2	.529	.051	.157	.272	.047	—	■	■	■	■	■	■	■	■	■	■	■
XDCT1104ERML	2	.529	.035	.157	.271	.063	.002	■	■	■	■	■	■	■	■	■	■	■
											5964861	6408004	■	■	■	■	■	■
											5964810	6408004	■	■	■	■	■	■
XDCT1105ERML	2	.529	.019	.157	.271	.078	—	■	■	■	■	■	■	■	■	■	■	■
XDCT1106ERML	2	.529	.006	.157	.271	.095	—	■	■	■	■	■	■	■	■	■	■	■
											6408006	6408005	■	■	■	■	■	■

(continued)

VSM11™

Victory™ Shoulder Mills • VSM11 Series

(Inserts for VSM11 Series — continued)



Inserts for VSM11 Series

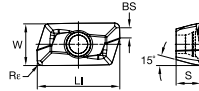

- first choice
- alternate choice

P	M	K	N	S	H	WDN10U	WK15CM	WK15PM	WN10HM	WN25PM	WP25PM	WP35CM	WP40PM	WS30PM	WS40PM	WU35PM
●	○	○	○	○	○											
●	○	○	○	○	○											
●	○	○	○	○	○											
●	○	○	○	○	○											
●	○	○	○	○	○											
●	○	○	○	○	○											
●	○	○	○	○	○											
●	○	○	○	○	○											
●	○	○	○	○	○											
●	○	○	○	○	○											
●	○	○	○	○	○											
●	○	○	○	○	○											
●	○	○	○	○	○											
●	○	○	○	○	○											
●	○	○	○	○	○											
●	○	○	○	○	○											
●	○	○	○	○	○											
●	○	○	○	○	○											
●	○	○	○	○	○											
●	○	○	○	○	○											
●	○	○	○	○	○											
●	○	○	○	○	○											

catalog number	cutting edges	LI	BS	S	W	Re	hm	WDN10U	WK15CM	WK15PM	WN10HM	WN25PM	WP25PM	WP35CM	WP40PM	WS30PM	WS40PM	WU35PM	
XDCT1108ERML	2	.506	—	.157	.271	.125	—												
XDPT1101SRMM	2	.531	.081	.163	.273	.015	.003		5415428	6242458			5642237	5415450	5642231		6180149	6408007	
XDPT1102SRMM	2	.531	.065	.163	.273	.031	.003		5415315	6242459			5415319	5415318	5545063	5519921	6180148	5415317	
XDPT1103SRMM	2	.529	.051	.157	.272	.047	.003		5415310				5415314	5415313	5642232		6180150	5415312	
XDPT1104SRMM	2	.532	.034	.163	.274	.062	.003		5415250				5415254	5415253	5642233		6180172		
XDPT1105SRMM	2	.532	.018	.163	.274	.078	.003						5980399	5980400	5980398		6408095		
XDPT1106SRMM	2	.526	—	.158	.273	.094	.003						5901355		5901354		6408096		
XDPT1108SRMM	2	.509	—	.158	.273	.122	.003		5415422				5415426	5415425	5642234	5517827	6279204		
XDPT1102SRMH	2	.529	.066	.157	.272	.031	.005		5415255					5415257	5545064		6408098		5415256
XDPT1103SRMH	2	.529	.051	.157	.272	.047	.005		5415360					5415362	5545064		6408099		
XDPT1104SRMH	2	.529	.035	.157	.272	.062	.005		5415364					5415366			6408100		

NOTE: XDCT11: High-precision periphery ground inserts.
XDPT11: Precision-pressed and sintered-to-size inserts.

Insert Selection Guide

Material Group	Light Machining		General Purpose		Heavy Machining	
	Geometry	Grade	Geometry	Grade	Geometry	Grade
P1-P2	XDCT-ML	WP40PM	XDPT-MM	WP40PM	XDPT-MH	WP40PM
P3-P4	XDCT-ML	WP40PM	XDPT-MM	WP40PM	XDPT-MH	WP40PM
P5-P6	XDPT-MM	WP25PM	XDPT-MM	WP35CM	XDPT-MH	WP40PM
M1-M2	XDCT-ML	WS40PM	XDPT-MM	WS40PM	XDPT-MH	WS40PM
M3	XDCT-ML	WS40PM	XDPT-MM	WS40PM	XDPT-MH	WS40PM
K1-K2	XDCT-ML	WK15CM	XDPT-MM	WK15CM	XDPT-MH	WK15CM
K3	XDCT-ML	WP35CM	XDPT-MM	WP35CM	XDPT-MH	WP35CM
N1-N2	XDCT-ALP	WN10HM	XDCT-ALP	WN25PM	XDCT-ALP	WN25PM
N3	XDCW-PCD	WDN10U	XDCW-PCD	WDN10U	XDCW-PCD	WDN10U
S1-S2	XDCT-ML	WP25PM	XDPT-MM	WP40PM	XDPT-MH	WS40PM
S3	XDCT-ML	WS40PM	XDPT-MM	WS40PM	XDPT-MH	WS40PM
S4	XDCT-ML	WS40PM	XDPT-MM	WS40PM	XDPT-MH	WS40PM
H1	XDCT-ML	WP25PM	XDPT-MM	WP25PM	—	—

Victory™ Shoulder Mills • VSM11™ Series

■ Recommended Starting Speeds [SFM]*

Material Group		WDN10U	WK15CM			WK15PM			WN10HM	WN25PM			WP25PM				
P	1	—	—	—	—	—	—	—	—	—	—	1085	935	885			
	2	—	—	—	—	—	—	—	—	—	—	900	785	655			
	3	—	—	—	—	—	—	—	—	—	—	835	705	575			
	4	—	—	—	—	—	—	—	—	—	—	740	605	490			
	5	—	—	—	—	—	—	—	—	—	—	605	560	490			
	6	—	—	—	—	—	—	—	—	—	—	540	410	330			
M	1	—	—	—	—	—	—	—	—	—	—	675	590	540			
	2	—	—	—	—	—	—	—	—	—	—	605	525	425			
	3	—	—	—	—	—	—	—	—	—	—	460	395	310			
K	1	—	—	—	1380	1265	1115	885	805	705	—	—	—	755	675	605	
	2	—	—	—	1100	970	900	690	625	575	—	—	—	590	525	490	
	3	—	—	—	920	820	755	575	525	475	—	—	—	490	445	395	
N	1	13155	11500	9810	—	—	—	—	—	—	2605	2275	1965	3525	3100	2870	
	2	5250	4905	4595	—	—	—	—	—	—	2605	2275	1965	3100	2870	2495	
	3	5250	4905	4595	—	—	—	—	—	—	1835	1590	1375	3100	2870	2495	
S	1	—	—	—	—	—	—	—	—	—	—	—	—	—	130	115	80
	2	—	—	—	—	—	—	—	—	—	—	—	—	—	130	115	80
	3	—	—	—	—	—	—	—	—	—	—	—	—	—	165	130	80
	4	—	—	—	—	—	—	—	—	—	—	—	—	—	230	165	115
H	1	—	—	—	—	—	—	—	—	—	—	—	—	—	395	295	230

Material Group		WP35CM			WP40PM			WS30PM			WS40PM			WU35PM		
P	1	1495	1295	1215	970	855	805	—	—	—	—	—	—	855	755	705
	2	920	835	755	820	705	590	—	—	—	—	—	—	720	625	525
	3	835	755	675	755	640	525	—	—	—	—	—	—	655	560	460
	4	625	575	525	675	560	445	—	—	—	—	—	—	590	490	395
	5	855	755	690	560	510	445	—	—	—	560	475	395	490	445	395
	6	525	445	360	490	375	295	—	—	—	490	360	260	425	330	260
M	1	675	605	510	640	560	510	740	655	605	690	560	460	560	490	445
	2	605	525	460	575	490	410	675	590	475	590	475	395	510	425	360
	3	475	425	375	425	375	295	510	445	345	475	360	280	375	330	260
K	1	970	870	785	—	—	—	—	—	—	—	—	—	—	—	—
	2	770	690	625	—	—	—	—	—	—	—	—	—	—	—	—
	3	640	575	525	—	—	—	—	—	—	—	—	—	—	—	—
N	1	—	—	—	—	—	—	—	—	—	—	—	—	—	—	—
	2	—	—	—	—	—	—	—	—	—	—	—	—	—	—	—
	3	—	—	—	—	—	—	—	—	—	—	—	—	—	—	—
S	1	—	—	—	—	—	—	150	130	100	130	115	80	115	100	80
	2	—	—	—	—	—	—	150	130	100	130	115	80	115	100	80
	3	—	—	—	—	—	—	180	150	100	165	130	80	150	115	80
	4	—	—	—	—	—	—	230	195	130	195	165	100	195	150	100
H	1	—	—	—	—	—	—	—	—	—	—	—	—	—	—	—

NOTE: FIRST choice starting speeds are in **bold** type. As the average chip thickness increases, the speed should be decreased.
 *Material groups P, M, K, and H show recommended starting speeds for dry machining. For wet machining, reduce speed by 20%.
 *Material groups N and S show recommended starting speeds for wet machining. Not recommended for dry machining.

■ Recommended Starting Feeds [IPT]

Light Machining	General Purpose	Heavy Machining
-----------------	-----------------	-----------------

Insert Geometry	Programmed Feed per Tooth (fz) as a % of Radial Depth of Cut (ae)															Insert Geometry
	5%			10%			20%			30%			40-100%			
.F..PCD	.005	.007	.011	.003	.005	.008	.003	.004	.006	.002	.003	.005	.002	.003	.005	.F..PCD
.F..ALP	.005	.009	.013	.003	.006	.009	.003	.005	.007	.002	.004	.006	.002	.004	.005	.F..ALP
.E..ML	.007	.011	.014	.005	.008	.010	.004	.006	.008	.003	.005	.007	.003	.005	.006	.E..ML
.S..MM	.009	.013	.019	.007	.009	.013	.005	.007	.010	.004	.006	.009	.004	.006	.008	.S..MM
.S..MH	.009	.014	.022	.007	.010	.016	.005	.008	.012	.004	.007	.010	.004	.006	.009	.S..MH

NOTE: Use "Light Machining" values as starting feed rate.

VSM11™

Victory™ Shoulder Mills • VSM11 Series

Best Practices

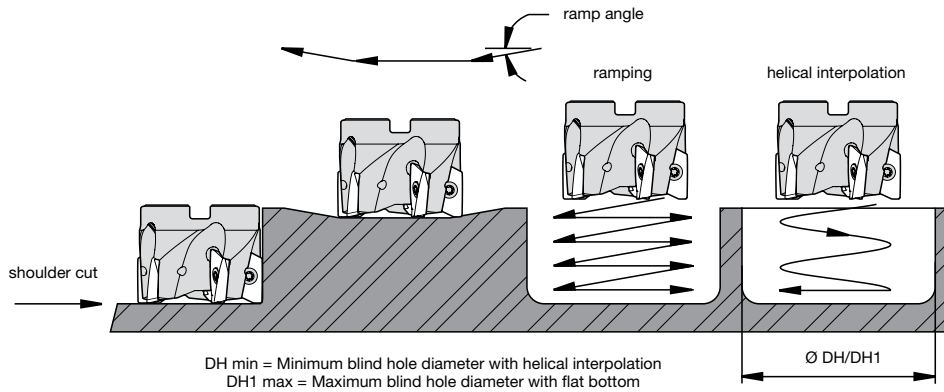

Modification Instructions for Use of Larger Radii Inserts (Shoulder Mills and Helical Mills)

cutting diameter (D1)	max RPM	max ramp angle to steel body interference	max flat-bottom hole diameter (DH1 max)	min hole diameter (DH min)
.062	41700	12.500°	1.240	0.730
.075	36300	8.600°	1.490	0.980
1.00	29900	5.100°	1.990	1.480
1.25	25900	3.600°	2.490	1.980
1.50	23300	2.800°	3.000	2.490
2.00	19700	1.900°	4.000	3.490
2.50	17400	1.500°	5.000	4.490
3.00	15700	1.200°	6.000	5.490
4.00	13500	.900°	8.000	7.490

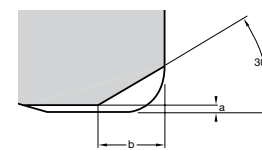

insert corner radius	material to remove	
	a	b
.079-.122"	.008"	.071"

NOTE: For DH1 max, subtract the insert corner radius from the max hole diameter.

NOTE: Standard milling cutters will accept insert nose radii up to 0.062" without modification.

VSM11 Z-Axis Plunging

cutting diameter (D1)	Z max	Y
.75	.252	.1714
1	.252	.1982
1.25	.252	.2218
1.5	.252	.2432
2	.252	.2810
2.5	.252	.3143
3	.252	.3445
4	.252	.3979
5	.252	.4450
6	.252	.4875

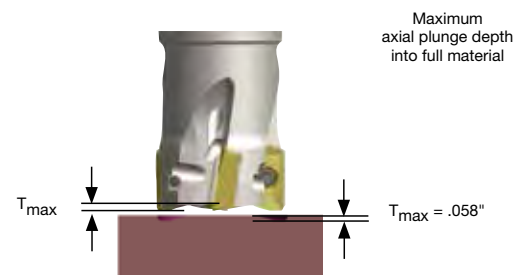
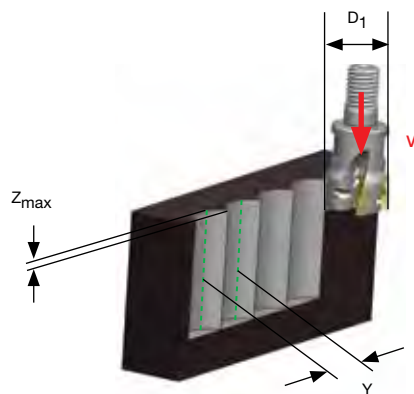

WIDIA™ Victory™



WS40PM

Breakthrough in the latest substrate and coating technology to boost productivity in **stainless steels and high-temp alloys**



Advanced Milling Grade for Titanium

Multilayer PVD AlTiN-TiN Coating

- Improved chemical and abrasive wear resistance.
- Consistent tool life performance.
- Primarily for wet machining. Also great results in dry machining.

New Medium-Grained Substrate

- Minimizes tendency for thermal cracking.
- Excellent fatigue resistance and edge strength.
- Rich in cobalt content for improved toughness.

VSM17™





2 Edged, 0° Victory™ Shoulder Mill (VSM)

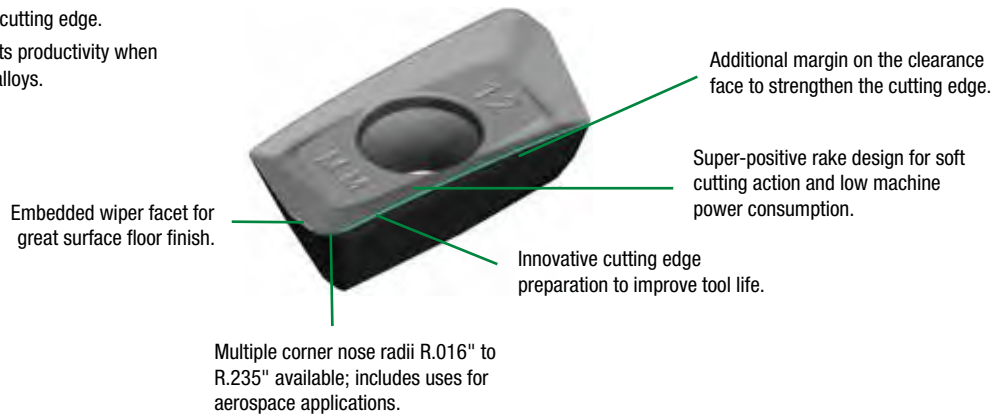

- True 0° shoulder milling platform; up to $A_{p1} \text{ max} = .638"$.
- Aggressive ramping capability up to 8.5° with end mills with a diameter of 1".
- Optimized chip gash for improved cutter stability and chip flow.
- Well-guided internal coolant supply to the cutting edge.
- Best-in-class milling grade WS40PM boosts productivity when machining stainless steel and high-temp alloys.



Geometries for all material groups in shoulder milling applications.

<p>-ALP</p>  <p>N</p> <p>Roughing and finishing of aluminum alloys. High precision. Periphery ground.</p>	<p>-ML</p>  <p>P M S H</p> <p>Light machining and finishing. First choice for stainless steel and titanium. Periphery ground.</p>	<p>-MM</p>  <p>P M K S H</p> <p>Medium machining. First choice for general purpose. Precision pressed to size.</p>	<p>-MH</p>  <p>P M K S</p> <p>First choice for heavy-duty machining. Steel and cast iron materials. Precision pressed to size.</p>
---	---	--	--

Finishing Capabilities/Lower Cutting Forces

Geometry Strengthening

2x Higher Metal Removal Rate!



Specifications	Before VSM	WIDIA™
Workpiece	—	K2 — Ductile Iron
Insert	—	XDPT170408PESRMM
Grade	—	WK15CM
Cutter	—	VSM17D080Z7S27XD17
Diameter	—	3.15"
No. cutting edges (z)	6	7
Vc	525 SFM	689 SFM
Feed rate (fz)	.0031 IPT	.0043" IPT
Vf	12 IPM	.1126 IPM
Ap	.118"	.118"
ae	2.362"	2.362"
MRR	3.3 in ³ /min	7.3 in³/min
Coolant	Dry	Dry



Victory™ Shoulder Mills • VSM17™ Series

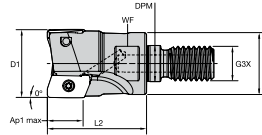

■ Screw-On End Mills

order number	catalog number	D1	D	DPM	G3X	L2	WF	Ap1 max	Z	max ramp angle	max RPM	coolant supply	lbs
5988017	VSM17D100Z02M12XD17	1.000	.827	.492	M12	1.250	.667	.642	2	8.5°	41300	Yes	.17
5988046	VSM17D125Z02M16XD17	1.250	1.142	.669	M16	1.500	.943	.641	2	5.8°	34700	Yes	.36
5988018	VSM17D125Z03M16XD17	1.250	1.142	.669	M16	1.500	.943	.641	3	5.8°	34700	Yes	.35
5988045	VSM17D150Z03M16XD17	1.500	1.142	.669	M16	1.500	.943	.638	3	4.3°	30700	Yes	.40
5988019	VSM17D150Z04M16XD17	1.500	1.142	.669	M16	1.500	.943	.638	4	4.3°	30700	Yes	.38

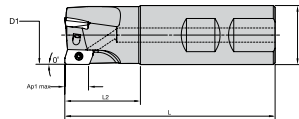

■ Weldon® End Mills

order number	catalog number	D1	D	L	L2	Ap1 max	Z	max ramp angle	max RPM	coolant supply	lbs
5988028	VSM17D100Z02W100XD17	1.000	1.000	3.500	1.220	.642	2	8.5°	41300	Yes	.59
5988052	VSM17D125Z02W125XD17	1.250	1.250	4.000	1.720	.641	2	5.8°	34700	Yes	1.06
5988029	VSM17D125Z03W125XD17	1.250	1.250	4.000	1.720	.641	3	5.8°	34700	Yes	1.05
5988051	VSM17D150Z03W150XD17	1.500	1.500	4.500	1.810	.638	3	4.3°	30700	Yes	1.77
5988030	VSM17D150Z04W150XD17	1.500	1.500	4.500	1.810	.638	4	4.3°	30700	Yes	1.77

NOTE: Weldon type not recommended for finishing operations.

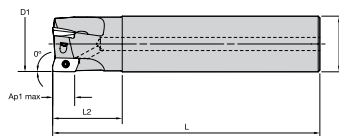

■ Cylindrical End Mills (Regular and Long Version)

order number	catalog number	D1	D	L	L2	Ap1 max	Z	max ramp angle	max RPM	coolant supply	lbs
5988011	VSM17D100Z02C100XD17L450	1.000	1.000	4.500	1.750	.642	2	8.5°	41300	Yes	.78
5988012	VSM17D100Z02C100XD17L670	1.000	1.000	6.700	1.750	.642	2	8.5°	41300	Yes	1.23
5988013	VSM17D125Z03C125XD17L480	1.250	1.250	4.800	2.000	.641	3	5.8°	34700	Yes	1.31
5988014	VSM17D125Z03C125XD17L800	1.250	1.250	8.000	2.000	.641	3	5.8°	34700	Yes	2.36
5988043	VSM17D150Z03C150XD17L520	1.500	1.500	5.200	2.000	.638	3	4.3°	30700	Yes	2.11
5988044	VSM17D150Z03C150XD17L980	1.500	1.500	9.800	2.000	.638	3	4.3°	30700	Yes	4.33
5988015	VSM17D150Z04C150XD17L520	1.500	1.500	5.200	2.000	.638	4	4.3°	30700	Yes	2.11
5988016	VSM17D150Z04C150XD17L980	1.500	1.500	9.800	2.000	.638	4	4.3°	30700	Yes	4.33

NOTE: Standard milling cutters will accept insert nose radii up to .062" without modification.
For tool body modification instructions, see page 32.

VSM17™

Victory™ Shoulder Mills • VSM17 Series

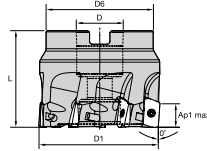

■ Shell Mills

order number	catalog number	D1	D	D6	L	Ap1 max	Z	max ramp angle	max RPM	coolant supply	lbs
5988020	VSM17D150Z04S075XD17	1.500	.750	1.417	1.575	.638	4	4.3°	30700	Yes	.38
5988021	VSM17D200Z04S075XD17	2.000	.750	1.750	1.575	.635	4	3.0°	25600	Yes	.68
5988022	VSM17D200Z05S075XD17	2.000	.750	1.750	1.575	.635	5	3.0°	25600	Yes	.71
5988050	VSM17D200Z06S075XD17	2.000	.750	1.750	1.575	.635	6	3.0°	25600	Yes	.66
5988023	VSM17D250Z05S075XD17	2.500	.750	1.750	1.575	.629	5	2.1°	22300	Yes	.98
5988048	VSM17D250Z06S075XD17	2.500	.750	1.750	1.575	.629	6	2.1°	22300	Yes	.97
5988024	VSM17D300Z06S100XD17	3.000	1.000	2.188	1.750	.626	6	1.7°	20100	Yes	1.73
5988047	VSM17D300Z07S100XD17	3.000	1.000	2.188	1.750	.626	7	1.7°	20100	Yes	1.68
5988025	VSM17D400Z08S150XD17	4.000	1.500	3.375	2.000	.623	8	1.2°	17100	Yes	3.52
5988026	VSM17D500Z09S150XD17	5.000	1.500	3.375	2.000	.617	9	.9°	15100	Yes	5.07
5988027	VSM17D600Z12S150XD17	6.000	1.500	3.375	2.000	.616	12	.7°	13700	Yes	6.88

NOTE: Standard milling cutters will accept insert nose radii up to .062" without modification.
For tool body modification instructions, see page 32.

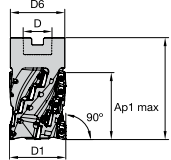

■ Helical Shell Mills

order number	catalog number	D1	D	D6	L	Ap1 max	Z	Z U	max ramp angle	max RPM	coolant supply	lbs
6083082	VHM17D200Z04S350XD17	2.000	1.000	1.910	3.500	2.380	16	4	3.0°	25600	Yes	1.79
6083085	VHM17D200Z04S550XD17	2.000	1.000	1.910	5.500	4.120	28	4	3.0°	25600	Yes	2.81
6083086	VHM17D200Z05S550XD17	2.000	1.000	1.910	5.500	4.120	35	5	3.0°	25600	Yes	2.82
6083083	VHM17D250Z04S450XD17	2.500	1.250	2.402	4.500	2.954	20	4	2.1°	22300	Yes	4.03
6083084	VHM17D250Z05S450XD17	2.500	1.250	2.402	4.500	2.954	25	5	2.1°	22300	Yes	4.06

NOTE: Z = number of pockets;
ZU = number of flutes.

■ Spare Parts

D1	insert screw	in. lbs.	wrench
1.000 - 6.000	191.725	31	170.025

For M4000 cartridge milling system, please see page 33.



VSM17
M4000CA-XDPT17
(MM6152927)



Victory™ Shoulder Mills • VSM17™ Series



■ Inserts for VSM17 Series

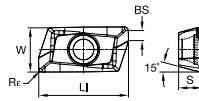

● first choice
○ alternate choice

P	■	■	■	○	●	●	○	○
M	■	■	■	○	●	●	○	○
K	■	■	■	○	○	○	○	○
N	■	■	■	○	○	○	○	○
S	■	■	■	○	○	○	○	○
H	■	■	■	○	○	○	○	○

catalog number	cutting edges	LI	BS	S	W	Rε	hm	WK15CM	WK15PM	WN10HM	WN25PM	WP25PM	WP35CM	WP40PM	WS40PM	WU35PM
XDCT1701RALP	2	.754	.103	.193	.378	.016	.001	■	■	6007341	6007220	■	■	■	■	■
XDCT1702RALP	2	.754	.088	.193	.378	.031	.001	■	■	6007345	6007344	■	■	■	■	■
XDCT1703RALP	2	.755	.072	.193	.378	.047	.001	■	■	6007342	6001537	■	■	■	■	■
XDCT1704RALP	2	.755	.056	.193	.378	.063	.001	■	■	■	6001256	■	■	■	■	■
XDCT1705RALP	2	.755	.040	.193	.378	.079	.001	■	■	■	6001254	■	■	■	■	■
XDCT1706RALP	2	.755	.025	.193	.378	.094	.001	■	■	■	6001252	■	■	■	■	■
XDCT1708RALP	2	.742	—	.192	.378	.125	.001	■	■	■	6001240	■	■	■	■	■
XDCT1710RALP	2	.722	—	.192	.377	.157	.001	■	■	■	6001238	■	■	■	■	■
XDCT1715RALP	2	.670	—	.189	.376	.235	.001	■	■	■	6118070	■	■	■	■	■
XDCT1701ERML	2	.754	.103	.193	.378	.016	.002	■	■	■	■	5989010	■	■	■	■
XDCT1702ERML	2	.754	.088	.193	.378	.031	.002	■	■	■	■	5988988	5988983	■	■	■
XDCT1703ERML	2	.754	.072	.193	.378	.047	.002	■	■	■	■	5988987	5988982	■	■	■
XDCT1704ERML	2	.755	.056	.193	.378	.062	.002	■	■	■	■	5988986	5988981	■	■	■
XDCT1705ERML	2	.755	.040	.193	.378	.079	.002	■	■	■	■	6001257	■	■	6425261	■
XDCT1706ERML	2	.755	.025	.193	.378	.094	.002	■	■	■	■	6001255	■	■	6425263	■
XDCT1708ERML	2	.742	—	.192	.378	.125	.002	■	■	■	■	6001251	6001253	■	6425264	■

(continued)

VSM17™

Victory™ Shoulder Mills • VSM17 Series

(Inserts for VSM17 Series — continued)

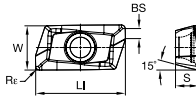

- first choice
- alternate choice

■ Inserts for VSM17 Series

P	■	■	■	■	○	○	○	○	○	○
M	■	■	■	■	○	○	○	○	○	○
K	■	■	■	■	○	○	○	○	○	○
N	■	■	■	■	○	○	○	○	○	○
S	■	■	■	■	○	○	○	○	○	○
H	■	■	■	■	○	○	○	○	○	○

catalog number	cutting edges	LI	BS	S	W	Re	hm	WK15CM	WK15PM	WN10HM	WN25PM	WP25PM	WP35CM	WP40PM	WS40PM	WU35PM
XDCT1710ERML	2	.722	—	.192	.377	.157	.002	■	■	■	■	6001239	■	■	■	■
XDCT1715ERML	2	.670	—	.189	.376	.235	.002	■	■	■	■	■	■	6118069	6232053	6425266
XDPT1701SRMM	2	.754	.099	.193	.378	.016	.004	■	■	■	■	■	■	5987689	■	5987690
XDPT1702SRMM	2	.754	.085	.193	.378	.031	.004	5987948	6242460	■	■	5987949	5987947	5987946	6180212	5987950
XDPT1703SRMM	2	.754	.070	.193	.378	.047	.004	5988138	■	■	■	5988151	5988140	5988139	6180213	5988152
XDPT1704SRMM	2	.755	.054	.193	.378	.063	.004	5988153	■	■	■	5988155	5988156	5988154	6180214	■
XDPT1705SRMM	2	.755	.039	.193	.378	.079	.004	■	■	■	■	5988158	5988160	5988159	6425145	■
XDPT1706SRMM	2	.755	.024	.193	.378	.094	.004	■	■	■	■	5988203	■	5988202	6425146	■
XDPT1708SRMM	2	.742	—	.192	.378	.125	.004	■	■	■	■	5988970	5988206	5988204	5988205	■
XDPT1710SRMM	2	.722	—	.192	.377	.157	.004	■	■	■	■	■	■	5988969	6425147	■
XDPT1702SRMH	2	.754	.083	.193	.378	.031	.005	5991817	5989053	■	■	■	■	5991816	5989054	■
XDPT1703SRMH	2	.754	.068	.193	.378	.047	.005	■	■	■	■	■	■	5991815	5989052	■

NOTE: XDCT17: High-precision periphery ground inserts.
XDPT17: Precision-pressed and sintered-to-size inserts.

Victory™ Shoulder Mills • VSM17™ Series

Insert Selection Guide

Material Group	Light Machining		General Purpose		Heavy Machining	
	Geometry	Grade	Geometry	Grade	Geometry	Grade
P1-P2	XDCT-ML	WP40PM	XDPT-MM	WP40PM	XDPT-MH	WP40PM
P3-P4	XDCT-ML	WP40PM	XDPT-MM	WP40PM	XDPT-MH	WP40PM
P5-P6	XDPT-MM	WP25PM	XDPT-MM	WP35CM	XDPT-MH	WP40PM
M1-M2	XDCT-ML	WS40PM	XDPT-MM	WS40PM	XDPT-MM	WS40PM
M3	XDCT-ML	WS40PM	XDPT-MM	WS40PM	XDPT-MH	WS40PM
K1-K2	XDPT-MM	WK15CM	XDPT-MM	WK15CM	XDPT-MH	WK15CM
K3	XDPT-MM	WP35CM	XDPT-MM	WP35CM	XDPT-MH	WP35CM
N1-N2	XDCT-ALP	WN10HM	XDCT-ALP	WN25PM	XDCT-ALP	WN25PM
N3	XDCT-ALP	WN10HM	XDCT-ALP	WN25PM	XDCT-ALP	WN25PM
S1-S2	XDCT-ML	WP25PM	XDPT-MM	WS40PM	XDPT-MM	WS40PM
S3	XDCT-ML	WS40PM	XDPT-MM	WS40PM	XDPT-MM	WS40PM
S4	XDCT-ML	WS40PM	XDPT-MM	WS40PM	XDPT-MM	WS40PM
H1	-	-	-	-	-	-

Recommended Starting Speeds [SFM]*

Material Group	WK15CM	WK15PM	WN10HM	WN25PM	WP25PM	WP35CM	WP40PM	WS40PM	WU35PM
P	1	-	-	-	1085 935 885	1495 1295 1215	970 855 805	-	855 755 705
	2	-	-	-	900 785 655	920 835 755	820 705 590	-	720 625 525
	3	-	-	-	835 705 575	835 755 675	755 640 525	-	655 560 460
	4	-	-	-	740 605 490	625 575 525	675 560 445	-	590 490 395
	5	-	-	-	605 560 490	855 755 690	560 510 445	560 475 395	490 445 395
	6	-	-	-	540 410 330	525 445 360	490 375 295	490 360 260	425 330 260
M	1	-	-	-	675 590 540	675 605 510	640 560 510	690 560 460	560 490 445
	2	-	-	-	605 525 425	605 525 460	575 490 410	590 475 395	510 425 360
	3	-	-	-	460 395 310	475 425 375	425 375 295	475 360 280	375 330 260
K	1	1380 1265 1115	885 805 705	-	-	755 675 605	970 870 785	-	-
	2	1100 970 900	690 625 575	-	-	590 525 490	770 690 625	-	-
	3	920 820 755	575 525 475	-	-	490 445 395	640 575 525	-	-
N	1	-	-	2605 2275 1965	3525 3100 2870	-	-	-	-
	2	-	-	2605 2275 1965	3100 2870 2495	-	-	-	-
	3	-	-	1835 1590 1375	3100 2870 2495	-	-	-	-
S	1	-	-	-	-	130 115 80	-	130 115 80	115 100 80
	2	-	-	-	-	130 115 80	-	130 115 80	115 100 80
	3	-	-	-	-	165 130 80	-	165 130 80	150 115 80
	4	-	-	-	-	230 165 115	-	195 165 100	195 150 100
H	1	-	-	-	395 295 230	-	-	-	-

NOTE: FIRST choice starting speeds are in bold type. As the average chip thickness increases, the speed should be decreased.
 *Material groups P, M, K, and H show recommended starting speeds for dry machining. For wet machining, reduce speed by 20%.
 *Material groups N and S show recommended starting speeds for wet machining. Not recommended for dry machining.

Recommended Starting Feeds [IPT]

Light Machining	General Purpose	Heavy Machining
-----------------	-----------------	-----------------

Insert Geometry	Programmed Feed per Tooth (fz) as a % of Radial Depth of Cut (ae)															Insert Geometry
	5%			10%			20%			30%			40-100%			
.F..ALP	.005	.009	.016	.003	.007	.012	.003	.005	.009	.002	.004	.008	.002	.004	.007	.F..ALP
.E..ML	.007	.014	.019	.005	.010	.013	.004	.008	.010	.003	.007	.009	.003	.006	.008	.E..ML
.S..MM	.007	.016	.026	.005	.012	.018	.004	.009	.014	.003	.008	.012	.003	.007	.011	.S..MM
.S..MH	.009	.019	.030	.007	.013	.021	.005	.010	.016	.004	.009	.014	.004	.008	.013	.S..MH

NOTE: Use "Light Machining" values as starting feed rate.

VSM17™

Victory™ Shoulder Mills • VSM17 Series

Best Practices

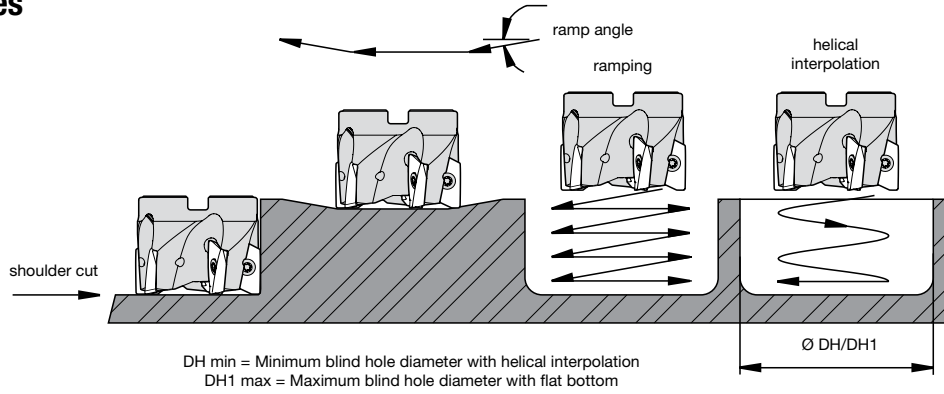

Modification Instructions for Use of Larger Radii Inserts (Shoulder Mills and Helical Mills)

cutting diameter (D1)	max RPM	max ramp angle to steel body interference	max flat-bottom hole diameter (DH1 max)	min hole diameter (DH min)
1.00	41300	8.5°	2.00	1.29
1.25	34700	5.8°	2.50	1.79
1.50	30700	4.3°	3.00	2.29
2.00	25600	3.0°	4.00	3.29
2.50	22300	2.1°	5.00	4.29
3.00	20100	1.7°	6.00	5.29
4.00	17100	1.2°	8.00	7.29
5.00	15100	.9°	10.00	9.29
6.00	13700	.7°	12.00	11.29

NOTE: For DH1 max, subtract the insert corner radius from the max hole diameter.

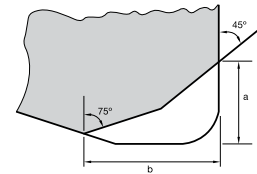

insert corner radius	material to remove	
	a	b
.094-.157"	.079"	.118"
.157-.236"	.157"	.197"

NOTE: Standard milling cutters will accept insert nose radii up to .079" without modification.

VSM17 Z-Axis Plunging

cutting diameter (D1)	Z max	Y
1	0.354	0.2346
1.25	0.354	0.2626
1.5	0.354	0.2880
2	0.354	0.3329
2.5	0.354	0.3725
3	0.354	0.4082
4	0.354	0.4716
5	0.354	0.5275
6	0.354	0.5779

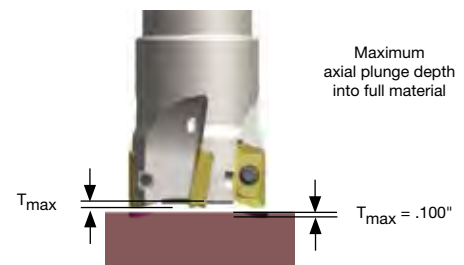
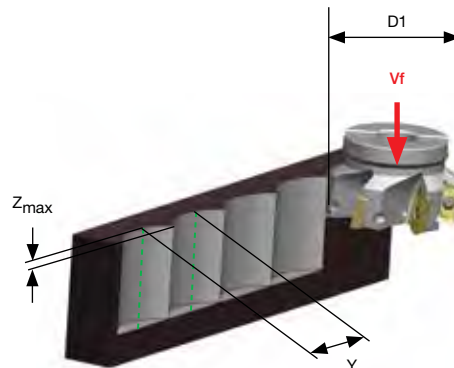

Face Mills • M4000 Series

M4000 Cartridge Milling System

Supporting the latest **WIDIA™ 0° shoulder milling technology up to D1 = 12"**.

- Roughing and finishing with a single tool.
- Quick cartridge stop feature.
- Easy runout adjustment.
- Easy change of cartridges with different insert styles and lead angles.



VSM11™

M4000CA-XDPT11
(MM6152926)



VSM17™

M4000CA-XDPT17
(MM6152927)



VSM490™-10

M4000CA-XN10
(MM6433216)



VSM490™-15

M4000CA-XN15
(MM6357989)

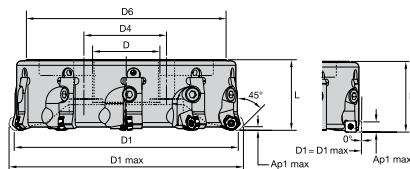

■ Cartridge Milling System

order number	catalog number	D1	D	D4	D6	L	number of cartridges	max RPM	coolant supply	lbs
4136312	M4000D600Z08ADJ	6.000	2.000	—	5.394	2.480	8	1800	No	9.73
4136353	M4000D600Z12ADJ	6.000	2.000	—	5.394	3.150	12	1800	No	13.53
4136358	M4000D1200Z16ADJ	12.000	2.500	4.000	11.260	3.150	16	1000	No	50.57
4136359	M4000D1200Z22ADJ	12.000	2.500	4.000	11.260	3.150	22	1000	No	50.42

■ Spare Parts

D1	cartridge screw	in. lbs.	wedge	adjusting screw	hex wrench
6.000 - 12.000	MS1294	177	12748308500	12748600900	MW3

VHSC

True High-Speed Aluminum Profiling
and Pocket Milling Cutter

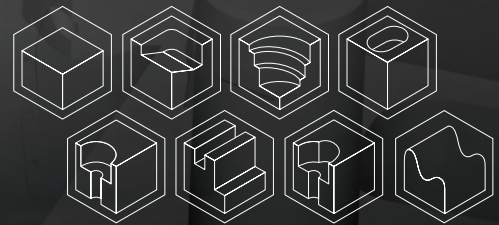



NEW!

Victory™ High-Speed Cutting

Up to $vc = 9843$ SFM

High-Speed Cutting Cylindrical End Mills: 1–1.5"

High-Speed Cutting Monoblocks: .98–1.97"

High-Speed Shell Mills: 1.5–4"

Proprietary pocket design allows multiple insert radii for one body definition. The insert also maintains axial positioning regardless of the size of the insert corner nose radius.

WIDIA 

widia.com

VHSC

VHSC Victory™ High-Speed Cutting

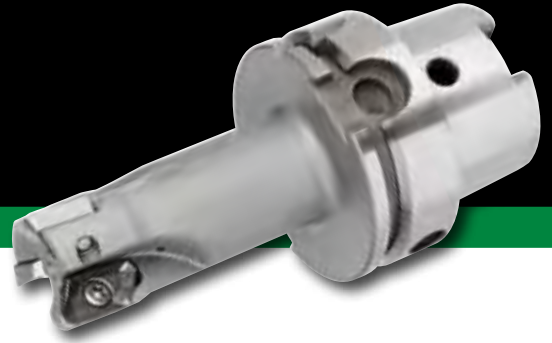

- Developed specifically to achieve true HSC cutting of aluminum components up to 9843 SFM.
- Latest cutter body technology allows for heavy feeding and ramping.
- Flutes and internal coolant channels engineered to support improved chip evacuation.
- Best-in-class solution for thin-walled machining.
- Productivity booster up to 525 in³/min MRR.

High-Speed Cutting Inserts XDET-ALP

- First choice for non-ferrous materials.
- Super-positive ALP geometry with polished rake to reduce built-up edge.
- Wear-resistant micro-grain carbide grade.
- Precision periphery ground.

FR-ALP



Sharp cutting edge "F" preparation for roughing and finishing jobs.

ER-ALP



Honed cutting edge "E" preparation for heavy roughing jobs and demanding castings.

Finishing Capabilities/Lower Cutting Forces

Geometry Strengthening

User-friendly Setup Makes a Big Difference

Large Corner Radius

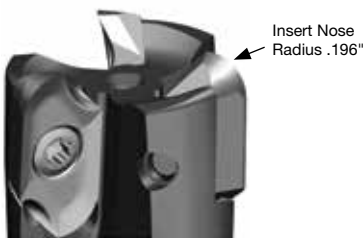

Small Corner Radius

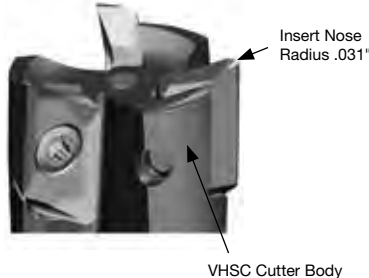

- Unique feature has a great impact on significant cost savings.
- Only one cutter body needed to load inserts with corner nose radii from R.020" to R.236" max.
- All other suppliers require modification and rebalance of the cutter body.

Insert Overlay

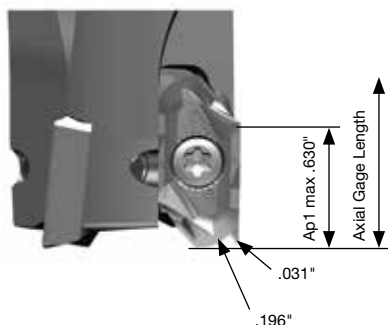

- Axial gage length on the cutter body will always be the same, no matter which insert nose radius is applied.
- Preferred by CNC programmers and operators.
- Ap1 max will always remain .630", no matter which insert nose radius is applied.

Victory™ Shoulder Mills • VHSC16

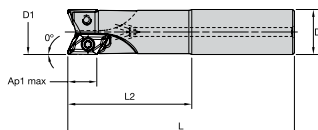

High-Speed Cutting Cylindrical End Mills

order number	catalog number	D1	D	L	L2	Ap1 max	Z	max ramp angle	max RPM	coolant supply	lbs
6425425	VHSC100Z02C100XD16	1.000	1.000	5.030	2.750	.630	2	14.7°	50000	Yes	.87
6425426	VHSC125Z02C125XD16	1.250	1.250	5.280	2.997	.630	2	11.5°	41500	Yes	1.49
6425427	VHSC125Z03C125XD16	1.250	1.250	5.280	3.000	.630	3	11.5°	41500	Yes	1.39
6425428	VHSC150Z03C150XD16	1.500	1.500	6.030	3.750	.630	3	7.6°	36500	Yes	1.39

NOTE: Pre-balanced to G6.3/30,000 RPM.

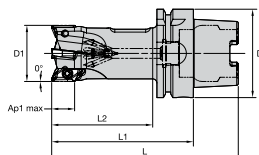

High-Speed Cutting Monoblocks • HSK63A

order number	catalog number	D1	D	L	L1	L2	Ap1 max	Z	max ramp angle	max RPM	coolant supply	lbs
6425447	VHSC025Z02HSK63XD16	.984	2.480	5.236	3.976	2.953	.630	2	14.5°	51000	Yes	1.79
6425449	VHSC032Z03HSK63XD16	1.260	2.480	5.236	3.976	2.953	.630	3	11.4°	41500	Yes	2.01
6425451	VHSC040Z04HSK63XD16	1.575	2.480	5.236	3.976	2.953	.630	4	7.8°	35000	Yes	2.40
6425453	VHSC050Z04HSK63XD16	1.969	2.478	5.232	3.976	2.955	.591	4	7.8°	30000	Yes	3.11

NOTE: Pre-balanced to G6.3/30,000 RPM.

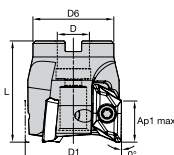

High-Speed Cutting Shell Mills

order number	catalog number	D1	D	D6	L	Ap1 max	Z	max ramp angle	max RPM	coolant supply	lbs
6425429	VHSC150Z03S050XD16	1.500	.500	1.260	1.575	.630	3	8.1°	36500	Yes	.34
6425430	VHSC200Z04S075XD16	2.000	.750	1.772	1.575	.630	4	7.7°	30000	Yes	.62
6425431	VHSC250Z04S100XD16	2.500	1.000	1.969	1.969	.630	4	5.8°	26000	Yes	1.38
6425432	VHSC300Z05S100XD16	3.000	1.000	1.969	1.969	.630	5	4.6°	23000	Yes	1.78
6425433	VHSC400Z05S125XD16	4.000	1.250	2.441	1.969	.630	5	3.7°	23000	Yes	3.51

Spare Parts

D1	insert screw	in. lbs.	Torx driver
.984 - 4.000	DP5009A	54	DT201P

NOTE: It is important to change the screw each time the insert is changed to ensure the highest security. A dynamometric key and the correct insert screw torque value are key for VHSC applications. Adjustable torque wrench (order number 6197561) and Torx Plus 20 bit (order number 6205891) may be purchased separately.

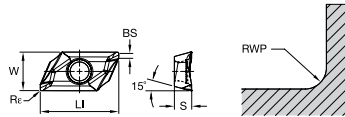

- first choice
- alternate choice

P	Blue
M	Yellow
K	Red
N	Green
S	Orange
H	Grey

High-Speed Cutting Inserts XDET-ALP

catalog number	cutting edges	LI	S	W	BS	Rε	RWP*	hm	
XDET16M5PDFRALP	2	.902	.197	.443	.056	.010	.010	.001	WN10HM
XDET16M504FRALP	2	.906	.197	.443	.050	.020	.020	.001	6425772
XDET16M508FRALP	2	.906	.197	.443	.034	.032	.032	.001	6425773
XDET16M520FRALP	2	.906	.197	.443	.023	.083	.079	.001	6425774
XDET16M530ERALP	2	.906	.197	.443	.019	.123	.118	.001	6425775
XDET16M530FRALP	2	.906	.197	.443	.019	.123	.118	.001	6425776
XDET16M540ERALP	2	.906	.197	.443	.023	.161	.157	.001	6425777
XDET16M540FRALP	2	.906	.197	.443	.023	.161	.157	.001	6425778
XDET16M550FRALP	2	.906	.197	.443	.009	.205	.197	.001	6425779
									6425780

NOTE: RWP* = Resultant workpiece radius.

Insert Selection Guide

Material Group	Light Machining		General Purpose		Heavy Machining	
	Geometry	Grade	Geometry	Grade	Geometry	Grade
N1-N2	.F..ALP	WN10HM	.F..ALP	WN10HM	.E..ALP	WN10HM
N3	.F..ALP	WN10HM	.F..ALP	WN10HM	.E..ALP	WN10HM

Recommended Starting Speeds for Wet Machining [SFM]

Material Group		WN10HM		
N	1	9640	5880	2860
	2	9640	5880	2860
	3	5230	2775	1565

NOTE: FIRST choice starting speeds are in **bold** type.
As the average chip thickness increases, the speed should be decreased.

Victory™ Shoulder Mills • VHSC16

■ Recommended Starting Feeds [IPT]

Light Machining	General Purpose	Heavy Machining
-----------------	-----------------	-----------------

Insert Geometry	Programmed Feed per Tooth (fz) as a % of Radial Depth of Cut (ae)														Insert Geometry	
	5%			10%			20%			30%			40-100%			
.F..ALP	.005	.018	.032	.003	.013	.023	.003	.010	.017	.002	.009	.015	.002	.008	.014	.F..ALP
.E..ALP	.006	.020	.037	.004	.014	.027	.003	.011	.020	.003	.009	.017	.003	.009	.016	.E..ALP

NOTE: Use "Light Machining" values as starting feed rate.

Recommendations for High Speed Machining at 8,000 RPM or above

- Check spindle condition:
 - Runout
 - Clamping of the attachment in traction
 - Marking and cleanliness
- Check that the tool is suitable for the required use.
- Inserts must be locked positively in the pocket and secured using the torx screw provided. The screw must be torqued to the correct value as indicated in the charts on the product pages.
- Because of heavy force to the screw, it is important to change the screw when changing the insert.
- Check the balancing of the assembled tool: cutter body, inserts, and attachment.
- Before start up, note the maximum RPM engraved on the tool. The maximum RPM is linked to a precise balancing value.
- Ensure that the field of application of the tool shown in our technical documents and technological parameters is observed:
 - A_e (inch) Width of cut, lateral engagement (radial)
 - a_p (inch) Axial depth of cut
 - f_z (IPT/tooth) Inch per tooth
 - n (RPM) Revolutions per minute



WIDIA™ cannot accept responsibility for misuse of this product due to:

- Non-observance of the above instructions
- Machine without casing
- Incorrect clamping of workpieces
- No safety device on the machine
- Any misuse or incorrect clamping

The optimum rotation must be determined by condition of the spindle. The spindle must be rigid to run at these higher RPMs.

Under no circumstances must any attempt be made to repair this tool. The only permitted maintenance is the indexing or replacement of the inserts.

When assembling the cutter to a Shrink Fit holder, the maximum protrusion cannot exceed 10% of the reach of tool.

Balancing:

- Cylindrical shank and HSK63A integral shanks are designed and balanced to G6.3 at 30,000 RPM for diameters up to 2".
- Cylindrical shank tools mounted in a Shrink Fit holder or any other chuck mill holder + inserts + screws must be re-inspected for balance as an assembly by the end-user when at or exceeding 8,000 RPM. End-user must balance the assembly at a G6.3 at 30,000 RPM maximum.
- Shell mills are not balanced. These tools must be re-inspected for balance as an assembly, cutter + inserts + screws by the end-user for high speed machining at 8,000 RPM or above. End-user must balance the assembly at a G6.3 value minimum.
- Balancing requires removing some material by drilling or milling operations.
- For each new shell mill installed on the same toolholder, re-balance the assembly.

Tighten the bolt between the shell mill and toolholder; with lubricant, apply the torque value of:

Thread sizes (inch)	Cutter Bore Size (inch)	Torque Values ft. lbs.
.250	.500	7.37
.375	.750	22.12
.500	1.000	36.87
.625	1.250	59.00
.750	1.500	81.13

■ Machinability by Materials • Aluminum

Alloy Group	Alloy Designation	Chemical Composition Limits (WT%)												Typical Temper	Rm (Mpa)	Machinability Chip Formation	Machinability
		Cu	Si	Fe	Mn	Mg	Zn	Cr	Ti	Pb	Bi	Al	Others				
Al	1050	0.05	0.25	0.40	0.50	0.05	0.05	-	-	-	-	99.50min	-	H14	105	D	A
	1100	0.05-0.20	Si+Fe 1.00 max	-	0.05	-	0.10	-	-	-	-	99.00min	-	H14	90	D	A
AlCu	2011	5.00-6.00	0.40	0.70	-	-	0.30	-	-	0.20	0.60	remaining	-	T3	310	A	A
	2014	3.90-5.00	0.50-1.20	0.70	0.40-1.20	0.20-0.80	0.25	0.10	0.15	-	-	remaining	-	T6	430	B	A
	2017	3.50-4.50	0.20-0.80	0.70	0.40-1.00	0.40-0.80	0.25	0.10	0.15	-	-	remaining	-	T4	390	B	A
	2024	3.80-4.90	0.50	0.50	0.30-0.90	1.20-1.80	0.25	0.10	0.15	-	-	remaining	-	T4	465	B	A
	2218	3.50-4.50	0.90	1	0.20	1.20-1.80	0.25	0.10	-	-	-	remaining	Ni1.7-2.3	T72	331	B	B
	2224	3.80-4.40	0.12	0.15	0.30-0.90	1.20-1.80	0.25	0.10	0.15	-	-	remaining	-	-	-	A	A
AlMn	3003	0.05-0.20	0.60	0.70	1.00-1.50	-	0.10	-	-	-	-	remaining	-	H14	140	D	B
AlSi	4032	0.50-1.30	11.00-13.50	1	-	0.80-1.30	0.25	0.10	-	-	-	remaining	Ni0.5-1.3	T6	379	B	D
AlMg	5083	0.10	0.40	0.40	0.40-1.00	4.00-4.90	0.25	0.05-0.25	0.15	-	-	remaining	-	H112	335	C	A
AlMgSi	6061	0.15-0.40	0.40-0.80	0.70	0.15	0.80-1.20	0.25	0.04-0.35	0.15	-	-	remaining	-	T6	300	C	B
	6063	0.10	0.20-0.60	0.35	0.10	0.45-0.90	0.10	0.10	0.10	-	-	remaining	-	T5	200	C	B
	6070	0.15-0.40	1.00-1.70	0.50	0.40-1.00	0.50-1.20	0.25	0.10	0.15	-	-	remaining	-	T6	379	C	C
	6151	0.35	0.60-1.20	1	0.20	0.45-0.80	0.25	0.15-0.35	0.15	-	-	remaining	-	T6	-	C	C
	6262	0.15-0.40	0.40-0.80	0.70	0.15	0.80-1.20	0.25	0.04-0.14	0.15	0.40	0.70	remaining	-	T9	400	B	B
	6351	0.10	0.70-1.30	0.50	0.40-0.80	0.40-0.80	0.20	-	0.20	-	-	remaining	-	T6	310	D	C
	6463	0.20	0.20-0.60	0.15	0.05	0.45-0.90	0.05	-	-	-	-	remaining	-	T6	241	C	B
AlZn	7001	1.60-2.60	0.35	0.40	0.20	2.60-3.40	6.80-8.00	0.18-0.35	0.20	-	-	remaining	-	O	-	B	A
	7003	0.20	0.30	0.35	0.30	0.50-1.00	5.00-6.50	0.20	0.20	-	-	remaining	Zr0.05-0.25	T5	400	B	A
	7050	2.00-2.60	0.12	0.15	0.10	1.90-2.60	5.70-6.70	0.04	0.06	-	-	remaining	Zr0.08-0.15	T73	530	B	A
	7075	1.20-2.00	0.40	0.50	0.30	2.10-2.90	5.10-6.10	0.18-0.28	0.20	-	-	remaining	-	T6	570	B	A
	7178	1.60-2.40	0.40	0.50	0.30	2.40-3.10	6.30-7.30	0.18-0.35	0.20	-	-	remaining	-	T6	600	B	A
	7475	1.20-1.90	0.10	0.12	0.06	1.90-2.60	5.20-6.20	0.18-0.25	0.06	-	-	remaining	-	T61	565	B	A

Machinability: A (Excellent), B (Good to Excellent), C (Good), D (Not Good)

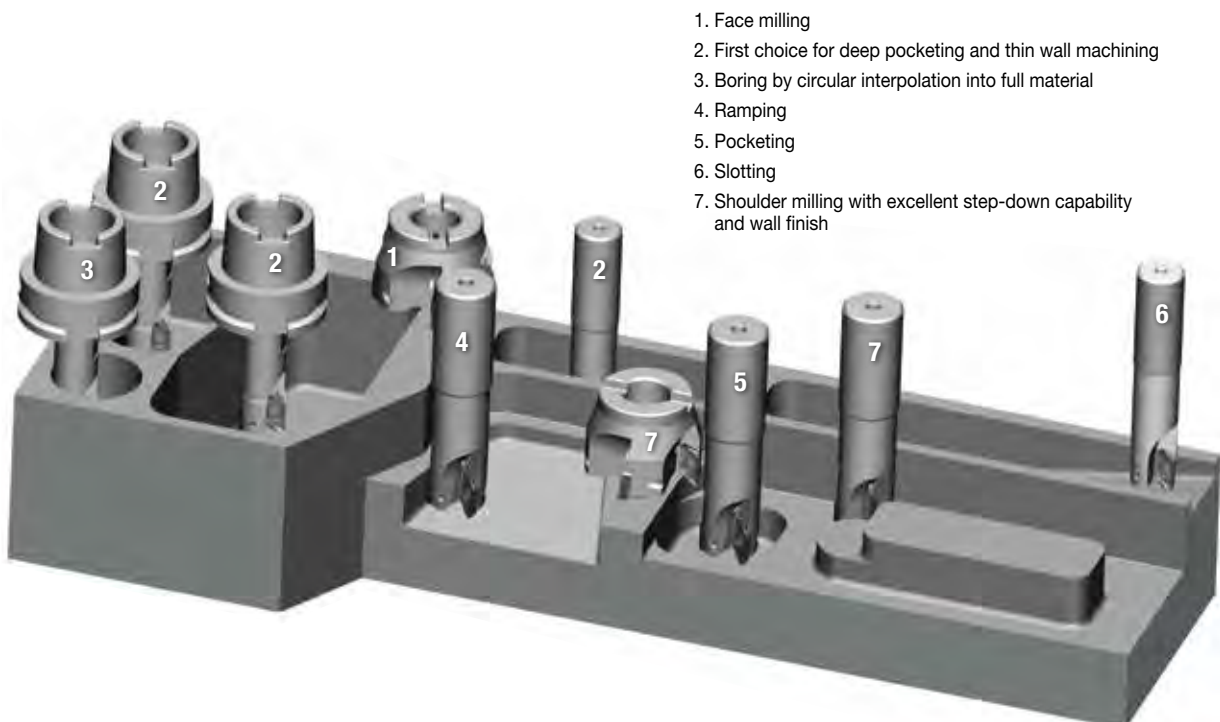

1. Face milling
2. First choice for deep pocketing and thin wall machining
3. Boring by circular interpolation into full material
4. Ramping
5. Pocketing
6. Slotting
7. Shoulder milling with excellent step-down capability and wall finish

Victory™ Shoulder Mills • VHSC16

Best Practices

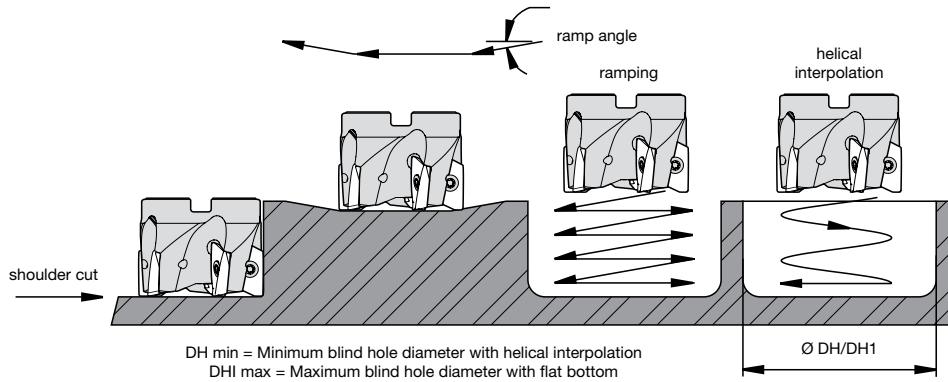

Ramp Angle

cutter diameter	Max. Ramping Angle Related to Insert Corner Nose Radius and Cutter D1						
	Facet	R .020	R .032	R .079	R .118	R .157	R .197
1.000	14.8°	14.8°	14.8°	9.2°	18.5°	8.8°	10.9°
1.250	11.5°	11.5°	11.5°	12.1°	12.7°	13.4°	14.0°
1.500	8.1°	8.1°	8.1°	8.5°	8.8°	9.1°	9.5°
2.000	7.7°	7.3°	7.7°	7.5°	7.7°	8.2°	8.8°
2.500	5.8°	5.5°	5.8°	5.6°	5.7°	6.1°	6.3°
3.000	4.6°	4.3°	4.6°	4.5°	4.6°	4.8°	5.0°
4.000	3.3°	3.3°	3.3°	3.2°	3.3°	3.4°	3.5°

Helical Min. Hole and Helical Max. Hole

cutter diameter	DH min	DH1 max
1.000	1.193	1.921
1.250	1.693	2.421
1.500	2.193	2.921
2.000	3.193	3.921
2.500	4.193	4.921
3.000	5.193	5.921
4.000	7.193	7.921

Ap1 max at Helical Interpolation for 360° Tool Path

cutter diameter	Helical interpolation depth Ap1 max for 360° tool path
1.000	.160
1.250	.160
1.500	.160
2.000	.160
2.500	.160
3.000	.160
4.000	.160

NOTE: Ap max depends on connection with cutter diameter, rigidity of the cutter, rigidity of the machine, and size of the flute.

Ap1 max at Full Slotting

cutting diameter (D1)	Number of inserts Z	Ap1 max
1.000	2	.300
1.250	2	.435
1.250	3	.240
1.500	3	.350
2.000	4	.350
2.500	4	.435
3.000	5	.435
4.000	5	.435

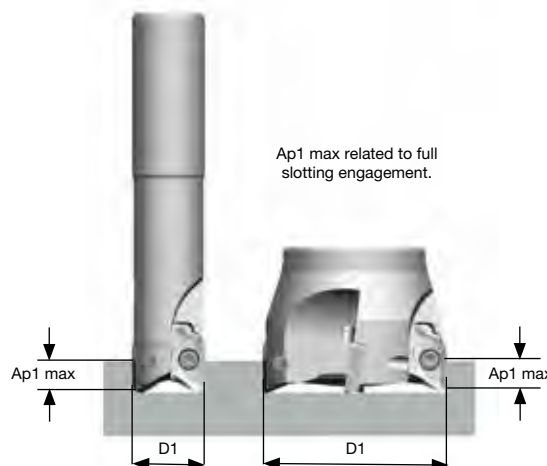

WIDIA-HA



A SOLID FOUNDATION

VariMill™

The original variable pitched geometry end mill that revolutionized the industry.

ArCut™

Double-rake face flute form reduces chatter in aluminum machining.

WavCut™

Special wave design for excellent performance in titanium and other aerospace applications.



NITA™

The Story



WIDIA™ remains a leader in aerospace and defense technology. These industries require increasingly complex machining techniques and exotic materials. The WIDIA-Hanita solid end milling product lines have built a strong ongoing reputation of continuous development and modification.

WIDIA™ HANITA 

widia.com

WIDIA-HA



VariMill II & III™

Advanced 5- and 7-flute geometries for advanced milling jobs in titanium, high-temp alloys, and stainless steels.

XFeed™

High-feed geometry with 6 flutes to reduce manufacturing time in heat-treated steel or titanium.

Roughers

High-performance profile for roughing applications in steel, stainless steel, and high-temp alloys.

Modular

VariMill™ technology meets the Duo-Lock™ connector system.

Pages 46–62



NITA™

The Evolution



WIDIA™ continues to provide advanced geometries that provide solutions for difficult to machine applications in exotic materials and enable customers to improve productivity and lower costs.

See how WIDIA-Hanita™ helped customers reduce cycle times by up to 35% in aerospace engine components.

Jet Engine Bracket	Current Parameters	WIDIA™
Workpiece		120mm x 120mm x 60mm
Cycle time	03:22 hours <i>(resulting in capital loss)</i>	01:20 hours
Cost-per-part	\$400	\$250



WIDIA™ HANITA™ 

widia.com

RUNOUT
ACCURACY

MAXIMUM
COUPLING
STABILITY

LENGTH
REPEATABILITY

MODUL

VariMill™ Technology Meets
DUO-LOCK® Connection

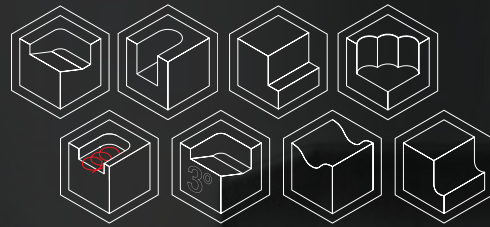



VariMill™ Modular

Cutting data and tool life comparable to high-performance solid carbide.

Proprietary VariMill geometries allow roughing and finishing with one tool.

1,5 x D standard cutting edge length allows for less passes.

Up to 1 x D full slotting increases Metal Removal Rates (MRR) and productivity significantly.

AR



Adapters

Extensive straight and conical shanks, as well as an integral adapter offering, including CV, PSC, BT, and HSK.

High-Performance Modular Solid Carbide End Mills

VariMill Modular combines highest runout accuracy and length repeatability with maximum coupling stability. This allows the VariMill Modular system to utilize the full potential of WIDIA™ VariMill cutting geometries and WIDIA Victory™ grades. The flexible VariMill Modular system targets applications like solid carbide end mills. A wide range of diameters between 3/8–1–1/4" and multiple corner configurations, such as sharp chamfer and radii, are available from stock.

Increased productivity enabled by the strength of Duo-Lock™ by Haimer and WIDIA connection system.

WIDIA 

widia.com

Modular End Mills

High-Performance Modular Solid Carbide End Mills



- High-performance geometries provide highest Metal Removal Rates (MRR).
- Unequal flute spacing reduces vibrations and improves surface finish.
- Intelligent thread ensures stress levels remain below critical values.
- Third-contact surface delivers high stiffness and highest accuracy below .0002" runout.



See me in action!

VariMill™ Modular Series

- Less cutting forces and pressure on cutting edge through tailored axial and radial rake angles.
- Proprietary tapered core provides highest tool stability in roughing and finishing operations.
- Eccentric relief design increases tool life through higher edge stability.



4XC5 VariMill Series

- 4 flute.
- New asymmetrical fluting geometry.
- High metal removal rates and tool life in:
 - Stainless steels, steels, and alloyed steels.
 - High-temperature alloys and titanium.



5VCC VariMill II™ Series

- 5 flute.
- High metal removal rates and tool life in:
 - Stainless steels, steels, and alloyed steels.
 - Cast iron.
 - High-temperature alloys and titanium.



45C7 & 45C8 High-Performance Finishing

- Multi-flute finishers.
- Radius corner.
- High metal removal rates and tool life in:
 - Stainless steels and steels.



4UC4 High-Performance Roughing 45°

- Multi-flute roughers.
- Radius corner.
- High-temperature geometries.



49C9 High-Performance Ball-Nose Roughing

- 4 Flute ball-nose rougher.
- Steel and stainless steel geometries.



49C6 High-Performance Roughing 20°

- Multi-flute roughers.
- Chamfer corner.
- Steel and stainless steel geometries.



4XC0 VariMill Series

- 4 flute.
- Stainless steel and steel geometry design.
- Center cutting ball nose.



4XCT VariMill Series

- 4 flute.
- New asymmetrical fluting geometry.
- Titanium geometry design.
- Extensive radii corner offering.



5VCE VariMill II ER Series

- 5 flute.
- Titanium geometry design.
- Eccentric relief for edge stability and strength.
- Extensive radii corner offering.



7VCE VariMill III™ ER Series

- 7 flute.
- Titanium geometry design.
- Eccentric relief for edge stability and strength.
- Extensive radii corner offering.



5AC2 & 5AC3 — AluSurf™

- 2- and 3-flute finishers.
- Radius corner.
- Aluminum geometries.



80C5 — Corner Rounding

- 4 flute.
- Corner rounding.



80C6 — Corner Chamfering

- Multi-flute roughers.
- Chamfer corner.

High-Performance DUO-λOCK® Modular End Mills • VariMill™

■ 4XC5 • 4XCT • 4 Flute • Inch

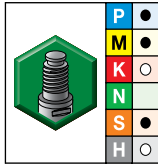
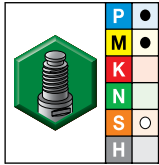

● first choice
○ alternate choice

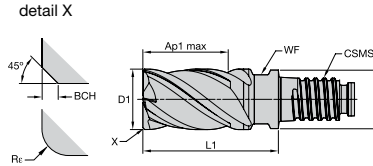

order #	order #	D1	D	length of cut Ap1 max	L1	CSMS system size	WF	BCH	Re
6071555	—	3/8	.359	9/16	1	DL10	.32	.02	—
6071179	—	3/8	.359	9/16	1	DL10	.32	—	—
—	6071561	3/8	.359	9/16	1	DL10	.32	—	.015
—	6071562	3/8	.359	9/16	1	DL10	.32	—	.030
—	6071563	3/8	.359	9/16	1	DL10	.32	—	.060
—	6071564	3/8	.359	9/16	1	DL10	.32	—	.090
6071556	—	1/2	.480	3/4	1	DL12	.37	.02	—
6071180	—	1/2	.480	3/4	1	DL12	.37	—	—
—	6071565	1/2	.480	3/4	1	DL12	.37	—	.015
—	6071566	1/2	.480	3/4	1	DL12	.37	—	.030
—	6071567	1/2	.480	3/4	1	DL12	.37	—	.060
—	6071568	1/2	.480	3/4	1	DL12	.37	—	.090
—	6071569	1/2	.480	3/4	1	DL12	.37	—	.120
6071557	—	5/8	.605	15/16	1	DL16	.51	.02	—
6071551	—	5/8	.605	15/16	1	DL16	.51	—	—
—	6071570	5/8	.605	15/16	1	DL16	.51	—	.015
—	6071571	5/8	.605	15/16	1	DL16	.51	—	.030
—	6071572	5/8	.605	15/16	1	DL16	.51	—	.060
—	6071573	5/8	.605	15/16	1	DL16	.51	—	.090
—	6071574	5/8	.605	15/16	1	DL16	.51	—	.120
6071558	—	3/4	.730	1 1/8	2	DL20	.63	.02	—
6071552	—	3/4	.730	1 1/8	2	DL20	.63	—	—
—	6071575	3/4	.730	1 1/8	2	DL20	.63	—	.030
—	6071576	3/4	.730	1 1/8	2	DL20	.63	—	.060
—	6071577	3/4	.730	1 1/8	2	DL20	.63	—	.090
—	6071578	3/4	.730	1 1/8	2	DL20	.63	—	.120
6071559	—	1	.961	1 1/2	2	DL25	.83	.02	—
6071553	—	1	.961	1 1/2	2	DL25	.83	—	—
—	6071579	1	.961	1 1/2	2	DL25	.83	—	.030
—	6071580	1	.961	1 1/2	2	DL25	.83	—	.060
—	6071591	1	.961	1 1/2	2	DL25	.83	—	.090
—	6071592	1	.961	1 1/2	2	DL25	.83	—	.120
—	6071593	1	.961	1 1/2	2	DL25	.83	—	.250
6071554	—	1 1/4	1.211	1 7/8	3	DL32	1.10	—	—
6071560	—	1 1/4	1.211	1 7/8	3	DL32	1.10	.02	—
—	6071594	1 1/4	1.211	1 7/8	3	DL32	1.10	—	.090
—	6071595	1 1/4	1.211	1 7/8	3	DL32	1.10	—	.250

NOTE: For application data, please see page 56.

End Mill Tolerances

D1	tolerance e8
13/32–23/32"	-0.00126/-0.00232
23/32–1-3/16"	-0.00157/-0.00287
>1-3/16"	-0.00197/-0.00350

Modular End Mills

High-Performance DUO-LOCK® Modular End Mills • VariMill™

■ 5VCC • 5VCE • 5 Flute • Inch

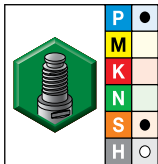
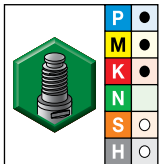

● first choice
○ alternate choice

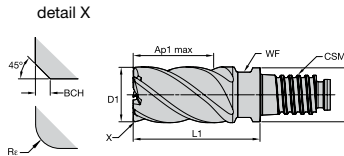

grade WP15PE AITiN		grade WS15PE AITiN		length of cut		CSMS system size		WF	BCH	Re
order #	order #	D1	D	Ap1 max	L1	system size				
6071665	—	3/8	.359	9/16	1	DL10	.32	.02	—	—
6071639	—	3/8	.359	9/16	1	DL10	.32	—	—	—
—	6071671	3/8	.359	9/16	1	DL10	.32	—	—	.015
—	6071672	3/8	.359	9/16	1	DL10	.32	—	—	.030
—	6071673	3/8	.359	9/16	1	DL10	.32	—	—	.060
—	6071674	3/8	.359	9/16	1	DL10	.32	—	—	.090
6071666	—	1/2	.480	3/4	1	DL12	.37	.02	—	—
6071640	—	1/2	.480	3/4	1	DL12	.37	—	—	—
—	6071675	1/2	.480	3/4	1	DL12	.37	—	—	.015
—	6071676	1/2	.480	3/4	1	DL12	.37	—	—	.030
—	6071677	1/2	.480	3/4	1	DL12	.37	—	—	.060
—	6071678	1/2	.480	3/4	1	DL12	.37	—	—	.090
—	6071679	1/2	.480	3/4	1	DL12	.37	—	—	.120
6071667	—	5/8	.605	15/16	1	DL16	.51	.02	—	—
6071661	—	5/8	.605	15/16	1	DL16	.51	—	—	—
—	6071680	5/8	.605	15/16	1	DL16	.51	—	—	.015
—	6071681	5/8	.605	15/16	1	DL16	.51	—	—	.030
—	6071682	5/8	.605	15/16	1	DL16	.51	—	—	.060
—	6071683	5/8	.605	15/16	1	DL16	.51	—	—	.090
—	6071684	5/8	.605	15/16	1	DL16	.51	—	—	.120
6071668	—	3/4	.730	1 1/8	2	DL20	.63	.02	—	—
6071662	—	3/4	.730	1 1/8	2	DL20	.63	—	—	—
—	6071685	3/4	.730	1 1/8	2	DL20	.63	—	—	.030
—	6071686	3/4	.730	1 1/8	2	DL20	.63	—	—	.060
—	6071687	3/4	.730	1 1/8	2	DL20	.63	—	—	.090
—	6071688	3/4	.730	1 1/8	2	DL20	.63	—	—	.120
6071669	—	1	.961	1 1/2	2	DL25	.83	.02	—	—
6071663	—	1	.961	1 1/2	2	DL25	.83	—	—	—
—	6071689	1	.961	1 1/2	2	DL25	.83	—	—	.030
—	6071690	1	.961	1 1/2	2	DL25	.83	—	—	.060
—	6071691	1	.961	1 1/2	2	DL25	.83	—	—	.090
—	6071692	1	.961	1 1/2	2	DL25	.83	—	—	.120
—	6071693	1	.961	1 1/2	2	DL25	.83	—	—	.250
6071664	—	1 1/4	1.211	1 7/8	3	DL32	1.10	—	—	—
6071670	—	1 1/4	1.211	1 7/8	3	DL32	1.10	.02	—	—
—	6071694	1 1/4	1.211	1 7/8	3	DL32	1.10	—	—	.090
—	6071695	1 1/4	1.211	1 7/8	3	DL32	1.10	—	—	.250

NOTE: For application data, please see page 56.

End Mill Tolerances

D1	tolerance e8
13/32–23/32"	-0.00126/-0.00232
23/32–1–3/16"	-0.00157/-0.00287
>1–3/16"	-0.00197/-0.00350



High-Performance DUO-λOCK® Modular End Mills • VariMill™

■ 7VCE • 7 Flute with Eccentric Relief Grind • Inch

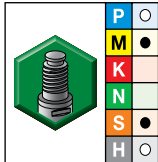

- first choice
- alternate choice

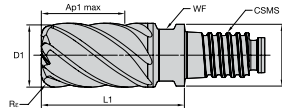

grade WS15PE
AITiN

order #	D1	D	length of cut Ap1 max	L1	CSMS system size	WF	Rε
6071721	3/8	.359	9/16	1	DL10	.32	.015
6071722	3/8	.359	9/16	1	DL10	.32	.030
6071723	3/8	.359	9/16	1	DL10	.32	.060
6071724	3/8	.359	9/16	1	DL10	.32	.090
6071725	1/2	.480	3/4	1	DL12	.37	.015
6071726	1/2	.480	3/4	1	DL12	.37	.030
6071727	1/2	.480	3/4	1	DL12	.37	.060
6071728	1/2	.480	3/4	1	DL12	.37	.090
6071729	1/2	.480	3/4	1	DL12	.37	.120
6071730	5/8	.605	15/16	1	DL16	.51	.015
6071741	5/8	.605	15/16	1	DL16	.51	.030
6071742	5/8	.605	15/16	1	DL16	.51	.060
6071743	5/8	.605	15/16	1	DL16	.51	.090
6071744	5/8	.605	15/16	1	DL16	.51	.120
6071745	3/4	.730	1 1/8	2	DL20	.63	.030
6071746	3/4	.730	1 1/8	2	DL20	.63	.060
6071747	3/4	.730	1 1/8	2	DL20	.63	.090
6071748	3/4	.730	1 1/8	2	DL20	.63	.120
6071749	1	.961	1 1/2	2	DL25	.83	.030
6071750	1	.961	1 1/2	2	DL25	.83	.060
6071751	1	.961	1 1/2	2	DL25	.83	.090
6071752	1	.961	1 1/2	2	DL25	.83	.120
6071753	1	.961	1 1/2	2	DL25	.83	.250
6071754	1 1/4	1.211	1 7/8	3	DL32	1.10	.090
6071755	1 1/4	1.211	1 7/8	3	DL32	1.10	.250

NOTE: For application data, please see page 57.

End Mill Tolerances

D1	tolerance e8
13/32-23/32"	-0.00126/-0.00232
23/32-1-3/16"	-0.00157/-0.00287
>1-3/16"	-0.00197/-0.00350

Modular End Mills

High-Performance DUO-LOCK® Modular End Mills • VariMill™

■ 4XC0 • 4-Flute Ball Nose • Inch

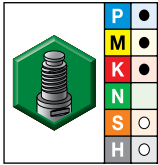

- first choice
- alternate choice

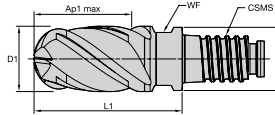

grade WP15PE
AITiN

order #	D1	D	length of cut Ap1 max	L1	CSMS system size	WF
6071539	3/8	.359	9/16	1	DL10	.32
6071540	1/2	.480	3/4	1	DL12	.37
6071631	5/8	.605	15/16	1	DL16	.51
6071632	3/4	.730	1 1/8	2	DL20	.63
6071633	1	.961	1 1/2	2	DL25	.83

NOTE: For application data, please see page 58.

■ 45C7 45C8 • Multi-Flute Finisher • Inch

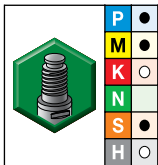

- first choice
- alternate choice

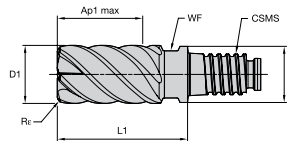

grade WS15PE
AITiN

order #	D1	D	length of cut Ap1 max	L1	CSMS system size	WF	Re
6126984	3/8	.359	9/16	1	DL10	.32	.015
6126985	3/8	.359	9/16	1	DL10	.32	.030
6126986	3/8	.359	9/16	1	DL10	.32	.060
6126987	3/8	.359	9/16	1	DL10	.32	.090
6126988	1/2	.480	3/4	1	DL12	.37	.015
6126989	1/2	.480	3/4	1	DL12	.37	.030
6126990	1/2	.480	3/4	1	DL12	.37	.060
6127021	1/2	.480	3/4	1	DL12	.37	.090
6127022	1/2	.480	3/4	1	DL12	.37	.120
6127023	5/8	.605	15/16	1	DL16	.51	.015
6127024	5/8	.605	15/16	1	DL16	.51	.030
6127025	5/8	.605	15/16	1	DL16	.51	.060
6127026	5/8	.605	15/16	1	DL16	.51	.090
6127027	5/8	.605	15/16	1	DL16	.51	.120
6127028	3/4	.730	1 1/8	2	DL20	.63	.030
6127029	3/4	.730	1 1/8	2	DL20	.63	.060
6127030	3/4	.730	1 1/8	2	DL20	.63	.090
6127031	3/4	.730	1 1/8	2	DL20	.63	.120
6127032	1	.961	1 1/2	2	DL25	.83	.030
6127033	1	.961	1 1/2	2	DL25	.83	.060
6127034	1	.961	1 1/2	2	DL25	.83	.090
6127035	1	.961	1 1/2	2	DL25	.83	.120
6127036	1	.961	1 1/2	2	DL25	.83	.250

NOTE: For application data, please see page 59.

High-Performance DUO-λOCK® Modular End Mills • Roughing

■ 49C6 • High-Performance Roughing • Inch

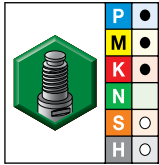

- first choice
- alternate choice

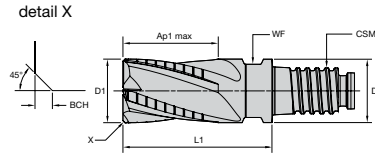

grade WP15PE
AITiN

order #	D1	D	length of cut Ap1 max	L1	CSMS system size	WF	BCH
6127390	3/8	.359	9/16	1	DL10	.32	.02
6127411	1/2	.480	3/4	1	DL12	.37	.02
6127412	5/8	.605	15/16	1	DL16	.51	.02
6127413	3/4	.730	1 1/8	2	DL20	.63	.02
6127414	1	.961	1 1/2	2	DL25	.83	.02

NOTE: For application data, please see page 59.

■ 49C9 • Ball-Nose Roughing • Inch

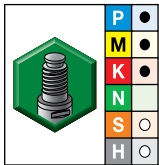

- first choice
- alternate choice

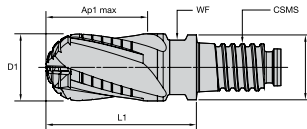

grade WP15PE
AITiN

order #	D1	D	length of cut Ap1 max	L1	CSMS system size	WF
6126845	3/8	.359	9/16	1	DL10	.32
6126846	1/2	.480	3/4	1	DL12	.37
6126847	5/8	.605	15/16	1	DL16	.51
6126848	3/4	.730	1 1/8	2	DL20	.63
6126849	1	.961	1 1/2	2	DL25	.83

NOTE: For application data, please see page 60.

■ 4UC4 • Roughing • Inch

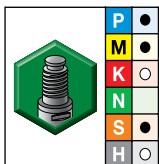

- first choice
- alternate choice

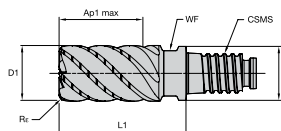

grade WS15PE
AITiN

order #	D1	D	length of cut Ap1 max	L1	CSMS system size	WF	R _r
6126881	3/8	.359	9/16	1	DL10	.32	.015
6126882	1/2	.480	3/4	1	DL12	.37	.030
6126883	5/8	.605	15/16	1	DL16	.51	.030
6126884	3/4	.730	1 1/8	2	DL20	.63	.030
6126885	1	.961	1 1/2	2	DL25	.83	.030

NOTE: For application data, please see page 60.

End Mill Tolerances

D1	tolerance e8
13/32-23/32"	-0.00126/-0.00232
23/32-1-3/16"	-0.00157/-0.00287
>1-3/16"	-0.00197/-0.00350

Modular End Mills

High-Performance DUO-LOCK® Modular End Mills • AluSurf™

■ 5AC2 • 2 Flute • Inch

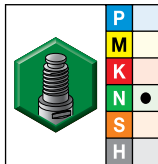

grade UNCOATED

- first choice
- alternate choice

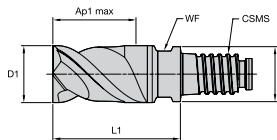

order #	D1	D	length of cut Ap1 max	L1	CSMS system size	WF
6151068	3/8	.359	9/16	1	DL10	.32
6151069	1/2	.480	3/4	1	DL12	.37
6151070	5/8	.605	15/16	1	DL16	.51
6151111	3/4	.730	1 1/8	2	DL20	.63

NOTE: For application data, please see page 61.

■ 5AC3 • 3 Flute • Inch

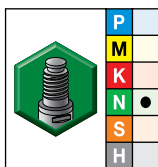

grade UNCOATED

- first choice
- alternate choice

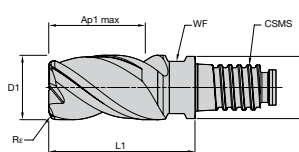

order #	D1	D	length of cut Ap1 max	L1	CSMS system size	WF	Re
6153855	3/8	.359	9/16	1	DL10	.32	.015
6153856	3/8	.359	9/16	1	DL10	.32	.030
6153857	3/8	.359	9/16	1	DL10	.32	.060
6153858	3/8	.359	9/16	1	DL10	.32	.090
6153859	1/2	.480	3/4	1	DL12	.37	.060
6153860	1/2	.480	3/4	1	DL12	.37	.030
6153931	1/2	.480	3/4	1	DL12	.37	.060
6153932	1/2	.480	3/4	1	DL12	.37	.090
6153933	1/2	.480	3/4	1	DL12	.37	.120
6153934	5/8	.605	15/16	1	DL16	.51	.015
6153935	5/8	.605	15/16	1	DL16	.51	.030
6153936	5/8	.605	15/16	1	DL16	.51	.060
6153937	5/8	.605	15/16	1	DL16	.51	.090
6153938	5/8	.605	15/16	1	DL16	.51	.900
6153939	3/4	.730	1 1/8	2	DL20	.63	.030
6153940	3/4	.730	1 1/8	2	DL20	.63	.060
6153941	3/4	.730	1 1/8	2	DL20	.63	.090
6153942	3/4	.730	1 1/8	2	DL20	.63	.120
6153943	1	.961	1 1/2	2	DL25	.83	.030
6153944	1	.961	1 1/2	2	DL25	.83	.060
6153945	1	.961	1 1/2	2	DL25	.83	.090
6153946	1	.961	1 1/2	2	DL25	.83	.120
6153947	1	.961	1 1/2	2	DL25	.83	.250

NOTE: For application data, please see page 61.

End Mill Tolerances

D1	tolerance e8
13/32-23/32"	-0.00126/-0.00232
23/32-1-3/16"	-0.00157/-0.00287
>1-3/16"	-0.00197/-0.00350



High-Performance DUO-LOCK® Modular End Mills • Corner Rounding/Chamfering

■ 80C5 • Corner Rounding

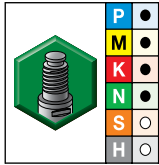

- first choice
- alternate choice

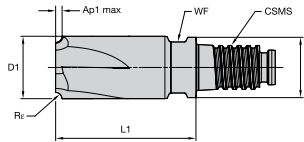

grade WP15PE
AITiN

order #	D1	D	length of cut Ap1 max	L1	CSMS system size	WF	Re
6127701	3/8	.359	.060	1	DL10	.32	.060
6127702	3/8	.359	.120	1	DL10	.32	.120
6127703	1/2	.480	.030	1	DL12	.37	.030
6127704	1/2	.480	.060	1	DL12	.37	.060
6127705	1/2	.480	.120	1	DL12	.37	.120
6127706	5/8	.605	.060	1	DL16	.51	.060
6127707	5/8	.605	.120	1	DL16	.51	.120
6127708	3/4	.730	.250	2	DL20	.63	.250

NOTE: For application data, please see page 61.

■ 80C6 • Chamfering

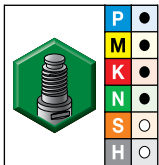

- first choice
- alternate choice

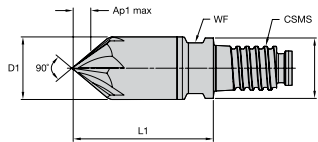

grade WP15PE
AITiN

order #	D1	D	length of cut Ap1 max	L1	CSMS system size	WF	BCH
6127318	3/8	.359	.178	1	DL10	.32	.08
6127319	1/2	.480	.100	1	DL12	.37	.10
6127320	5/8	.605	.125	1	DL16	.51	.13

NOTE: For application data, please see page 61.

End Mill Tolerances

D1	tolerance e8
13/32–23/32"	-0,00126"/-0,00232"
23/32–1-3/16"	-0,00157"/-0,00287"
>1-3/16"	-0,00197"/-0,00350"

DUO-LOCK® Accessories

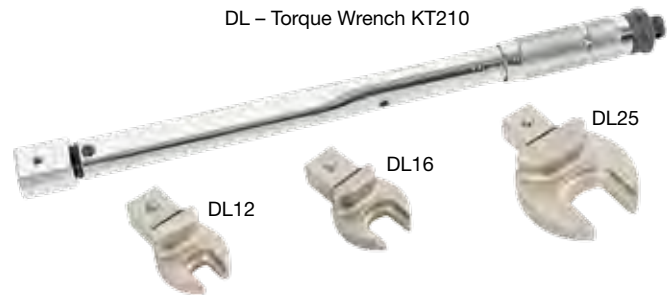

■ Torque Wrench



order number	catalog number	description	quantity
6390382	DL - Torque Wrench KT210	Only Wrench 30-130 Nm	10
6390561	DL - 12 Key	Only Key 30 Nm	20
6390562	DL - 16 Key	Only Key 60 Nm	20
6390563	DL - 20 Key	Only Key 80 Nm	10
6390564	DL - 25 Key	Only Key 100 Nm	10
6390565	DL - 32 Key	Only Key 130 Nm	10
6390566	DL10 - Torque Wrench + Key	Wrench + Key 25 Nm	5

NOTE: Combine basic Duo-Lock™ wrench with selected torque wrench inserts needed.



Modular End Mills

High-Performance DUO-LOCK® Modular End Mills • VariMill™

VariMill • 4XC5 • 4XCT • Asymmetrical Flute Spacing

Material Group											Recommended feed per tooth (IPT = inch/th) for side milling (A). For slotting (B), reduce IPT by 20%.							
	Side Milling (A) and Slotting (B)			short		medium		long		D1 – Diameter								
	A		B	adapter reach														
	ap		ae	ap		WP15PE WS15PE		WP15PE WS15PE		WP15PE WS15PE		frac.	3/8	1/2	5/8	3/4	1	1 1/4
	min		max	min		max		min		max		dec.	.3750	.5000	.6250	.7500	1.0000	1.2500
P	0	1.5 x D	0.5 x D	1 x D	490	660	441	594	441	594	IPT	.0023	.0029	.0034	.0037	.0042	.0042	
	1	1.5 x D	0.5 x D	1 x D	490	660	441	594	441	594	IPT	.0023	.0029	.0034	.0037	.0042	.0042	
	2	1.5 x D	0.5 x D	1 x D	460	620	414	558	414	558	IPT	.0023	.0029	.0034	.0037	.0042	.0042	
	3	1.5 x D	0.5 x D	1 x D	390	520	351	468	351	468	IPT	.0019	.0025	.0029	.0033	.0038	.0041	
	4	1.5 x D	0.5 x D	0.75 x D	300	490	270	441	270	441	IPT	.0017	.0022	.0026	.0029	.0033	.0034	
	5	1.5 x D	0.5 x D	1 x D	200	330	170	281	160	264	IPT	.0016	.0020	.0023	.0026	.0031	.0033	
M	6	1.5 x D	0.5 x D	0.75 x D	160	250	136	213	128	200	IPT	.0013	.0016	.0019	.0021	.0024	.0024	
	1	1.5 x D	0.5 x D	1 x D	300	380	240	304	210	266	IPT	.0019	.0025	.0029	.0033	.0038	.0041	
	2	1.5 x D	0.5 x D	1 x D	200	260	160	208	140	182	IPT	.0016	.0020	.0023	.0026	.0031	.0033	
K	3	1.5 x D	0.5 x D	1 x D	200	230	160	184	140	161	IPT	.0013	.0016	.0019	.0021	.0024	.0024	
	1	1.5 x D	0.5 x D	1 x D	390	490	351	441	351	441	IPT	.0023	.0029	.0034	.0037	.0042	.0042	
	2	1.5 x D	0.5 x D	1 x D	360	460	324	414	324	414	IPT	.0019	.0025	.0029	.0033	.0038	.0041	
S	3	1.5 x D	0.5 x D	1 x D	360	430	324	387	324	387	IPT	.0016	.0020	.0023	.0026	.0031	.0033	
	1	1.5 x D	0.3 x D	0.3 x D	160	300	128	240	96	180	IPT	.0019	.0025	.0029	.0033	.0038	.0041	
	2	1.5 x D	0.3 x D	0.3 x D	80	130	64	104	48	78	IPT	.0010	.0013	.0015	.0018	.0021	.0022	
	3	1.5 x D	0.5 x D	1 x D	200	260	160	208	120	156	IPT	.0016	.0020	.0023	.0026	.0031	.0033	
H	4	1.5 x D	0.5 x D	1 x D	160	200	128	160	96	120	IPT	.0014	.0018	.0021	.0024	.0028	.0030	
	1	1.5 x D	0.5 x D	0.75 x D	260	460	208	368	156	276	IPT	.0017	.0022	.0026	.0029	.0033	.0034	
	2	1.5 x D	0.2 x D	0.5 x D	230	390	184	312	138	234	IPT	.0013	.0016	.0019	.0021	.0024	.0024	



VariMill II™ • 5VCC • 5VCE • Unequal Flute Spacing

Material Group											Recommended feed per tooth (IPT = inch/th) for side milling (A). For slotting (B), reduce IPT by 20%.							
	Side Milling (A) and Slotting (B)			short		medium		long		D1 – Diameter								
	A		B	adapter reach														
	ap		ae	ap		WP15PE WS15PE		WP15PE WS15PE		WP15PE WS15PE		frac.	3/8	1/2	5/8	3/4	1	1 1/4
	min		max	min		max		min		max		dec.	.3750	.5000	.6250	.7500	1.0000	1.2500
P	0	1.5 x D	0.5 x D	1 x D	490	660	441	594	441	594	IPT	.0023	.0029	.0034	.0037	.0042	.0042	
	1	1.5 x D	0.5 x D	1 x D	490	660	441	594	441	594	IPT	.0023	.0029	.0034	.0037	.0042	.0042	
	2	1.5 x D	0.5 x D	1 x D	460	620	414	558	414	558	IPT	.0023	.0029	.0034	.0037	.0042	.0042	
	3	1.5 x D	0.5 x D	1 x D	390	520	351	468	351	468	IPT	.0019	.0025	.0029	.0033	.0038	.0041	
	4	1.5 x D	0.5 x D	0.75 x D	300	490	270	441	270	441	IPT	.0017	.0022	.0026	.0029	.0033	.0034	
	5	1.5 x D	0.5 x D	1 x D	200	330	170	281	160	264	IPT	.0016	.0020	.0023	.0026	.0031	.0033	
M	6	1.5 x D	0.5 x D	0.75 x D	160	250	136	213	128	200	IPT	.0013	.0016	.0019	.0021	.0024	.0024	
	1	1.5 x D	0.5 x D	1 x D	300	380	240	304	210	266	IPT	.0019	.0025	.0029	.0033	.0038	.0041	
	2	1.5 x D	0.5 x D	1 x D	200	260	160	208	140	182	IPT	.0016	.0020	.0023	.0026	.0031	.0033	
K	3	1.5 x D	0.5 x D	1 x D	200	230	160	184	140	161	IPT	.0013	.0016	.0019	.0021	.0024	.0024	
	1	1.5 x D	0.5 x D	1 x D	390	490	351	441	351	441	IPT	.0023	.0029	.0034	.0037	.0042	.0042	
	2	1.5 x D	0.5 x D	1 x D	360	460	324	414	324	414	IPT	.0019	.0025	.0029	.0033	.0038	.0041	
S	3	1.5 x D	0.5 x D	1 x D	360	430	324	387	324	387	IPT	.0016	.0020	.0023	.0026	.0031	.0033	
	1	1.5 x D	0.3 x D	0.3 x D	160	300	128	240	96	180	IPT	.0019	.0025	.0029	.0033	.0038	.0041	
	2	1.5 x D	0.3 x D	0.3 x D	80	130	64	104	48	78	IPT	.0010	.0013	.0015	.0018	.0021	.0022	
	3	1.5 x D	0.5 x D	1 x D	200	260	160	208	120	156	IPT	.0016	.0020	.0023	.0026	.0031	.0033	
H	4	1.5 x D	0.5 x D	1 x D	160	200	128	160	96	120	IPT	.0014	.0018	.0021	.0024	.0028	.0030	
	1	1.5 x D	0.5 x D	0.75 x D	260	460	208	368	156	276	IPT	.0017	.0022	.0026	.0029	.0033	.0034	
	2	1.5 x D	0.2 x D	0.5 x D	230	390	184	312	138	234	IPT	.0013	.0016	.0019	.0021	.0024	.0024	



NOTE: Lower value of cutting speed is used for high stock removal applications or for higher hardness (machinability) within group.
 Higher value of cutting speed is used for finishing applications or for lower hardness (machinability) within group.
 Above parameters are based on ideal conditions. For smaller taper machining centers, please adjust parameters accordingly on diameters >1/2".
 For side milling with ap bigger than 1 x D reduce IPT by 20%!

High-Performance DUO-LOCK® Modular End Mills • VariMill™ Roughing/Finishing

■ VariMill III™ • 7VCE • Unequal Flute Spacing • Roughing

Material Group																		
	Side Milling (A)		short		medium			long			Recommended feed per tooth (IPT = inch/th) for side milling (A).							
	A		adapter reach									D1 – Diameter						
			WS15PE		WS15PE			WS15PE			frac.	3/8	1/2	5/8	3/4	1	1 1/4	
	ap	ae	Cutting Speed – vc SFM		Cutting Speed – vc SFM			Cutting Speed – vc SFM										dec.
P	4	Ap max 0.3 x D	300	–	490	270	–	441	270	–	441	IPT	.0016	.0021	.0024	.0027	.0031	.0032
	5	Ap max 0.3 x D	200	–	330	170	–	280.5	160	–	264	IPT	.0015	.0018	.0022	.0025	.0029	.0031
M	1	Ap max 0.3 x D	300	–	380	240	–	304	210	–	266	IPT	.0018	.0023	.0027	.0031	.0036	.0039
	2	Ap max 0.3 x D	200	–	260	160	–	208	140	–	182	IPT	.0015	.0018	.0022	.0025	.0029	.0031
S	3	Ap max 0.3 x D	200	–	230	160	–	184	140	–	161	IPT	.0012	.0015	.0018	.0020	.0022	.0023
	1	Ap max 0.3 x D	160	–	300	128	–	240	96	–	180	IPT	.0018	.0023	.0027	.0031	.0036	.0039
	2	Ap max 0.3 x D	80	–	130	64	–	104	48	–	78	IPT	.0010	.0012	.0015	.0016	.0019	.0021
	3	Ap max 0.3 x D	200	–	260	160	–	208	120	–	156	IPT	.0015	.0018	.0022	.0025	.0029	.0031
H	4	Ap max 0.3 x D	160	–	200	128	–	160	96	–	120	IPT	.0013	.0017	.0020	.0023	.0026	.0028
	1	Ap max 0.3 x D	260	–	460	208	–	368	156	–	276	IPT	.0016	.0021	.0024	.0027	.0031	.0032
	2	Ap max 0.3 x D	230	–	390	184	–	312	138	–	234	IPT	.0012	.0015	.0018	.0020	.0022	.0023

■ VariMill III • 7VCE • Unequal Flute Spacing • Finishing



Material Group																		
	Side Milling (A)		short		medium			long			Recommended feed per tooth (IPT = inch/th) for side milling (A).							
	A		adapter reach									D1 – Diameter						
			WS15PE		WS15PE			WS15PE			frac.	3/8	1/2	5/8	3/4	1	1 1/4	
	ap	ae	Cutting Speed – vc SFM		Cutting Speed – vc SFM			Cutting Speed – vc SFM										dec.
P	4	Ap max 0.06 x D	590	–	980	531	–	882	531	–	882	IPT	.0020	.0025	.0029	.0032	.0037	.0039
	5	Ap max 0.06 x D	390	–	660	331.5	–	561	312	–	528	IPT	.0018	.0022	.0026	.0030	.0035	.0037
M	1	Ap max 0.06 x D	590	–	750	472	–	600	413	–	525	IPT	.0022	.0028	.0033	.0037	.0043	.0047
	2	Ap max 0.06 x D	390	–	520	312	–	416	273	–	364	IPT	.0018	.0022	.0026	.0030	.0035	.0037
S	3	Ap max 0.06 x D	390	–	460	312	–	368	273	–	322	IPT	.0015	.0018	.0021	.0024	.0027	.0028
	1	Ap max 0.06 x D	330	–	590	264	–	472	198	–	354	IPT	.0022	.0028	.0033	.0037	.0043	.0047
	2	Ap max 0.06 x D	160	–	260	128	–	208	96	–	156	IPT	.0012	.0015	.0017	.0020	.0023	.0025
	3	Ap max 0.06 x D	390	–	520	312	–	416	234	–	312	IPT	.0018	.0022	.0026	.0030	.0035	.0037
H	4	Ap max 0.06 x D	330	–	390	264	–	312	198	–	234	IPT	.0016	.0020	.0024	.0027	.0032	.0034
	1	Ap max 0.06 x D	520	–	920	416	–	736	312	–	552	IPT	.0020	.0025	.0029	.0032	.0037	.0039
	2	Ap max 0.06 x D	460	–	790	368	–	632	276	–	474	IPT	.0015	.0018	.0021	.0024	.0027	.0028

NOTE: Lower value of cutting speed is used for high stock removal applications or for higher hardness (machinability) within group.
 Higher value of cutting speed is used for finishing applications or for lower hardness (machinability) within group.
 Above parameters are based on ideal conditions. For smaller taper machining centers, please adjust parameters accordingly on diameters >1/2".

Modular End Mills

High-Performance DUO-LOCK® Modular End Mills • VariMill™



■ VariMill Ball Nose • 4XC0 • Asymmetrical Flute Spacing

Material Group																				
	Side Milling (A) and Slotting (B)			short		medium		long		Recommended feed per tooth (IPT = inch/th) for side milling (A). For slotting (B), reduce IPT by 20%.										
	A		B	adapter reach						D1 – Diameter										
				WP15PE		WP15PE		WP15PE		frac.	3/8	1/2	5/8	3/4	1	1 1/4				
	ap	ae	ap	Cutting Speed – vc SFM		Cutting Speed – vc SFM		Cutting Speed – vc SFM		dec.	.3750	.5000	.6250	.7500	1.0000	1.2500				
P	0	1.25 x D	0.5 x D	1 x D	490	–	660	441	–	594	441	–	594	IPT	.0023	.0029	.0034	.0037	.0042	.0042
	1	1.25 x D	0.5 x D	1 x D	490	–	660	441	–	594	441	–	594	IPT	.0023	.0029	.0034	.0037	.0042	.0042
	2	1.25 x D	0.5 x D	1 x D	460	–	620	414	–	558	414	–	558	IPT	.0023	.0029	.0034	.0037	.0042	.0042
	3	1.25 x D	0.5 x D	1 x D	390	–	520	351	–	468	351	–	468	IPT	.0019	.0025	.0029	.0033	.0038	.0041
	4	1.25 x D	0.5 x D	0.75 x D	300	–	490	270	–	441	270	–	441	IPT	.0017	.0022	.0026	.0029	.0033	.0034
	5	1.25 x D	0.5 x D	1 x D	200	–	330	170	–	281	160	–	264	IPT	.0016	.0020	.0023	.0026	.0031	.0033
M	6	1.25 x D	0.5 x D	0.75 x D	160	–	250	136	–	213	128	–	200	IPT	.0013	.0016	.0019	.0021	.0024	.0024
	1	1.25 x D	0.5 x D	1 x D	300	–	380	240	–	304	210	–	266	IPT	.0019	.0025	.0029	.0033	.0038	.0041
	2	1.25 x D	0.5 x D	1 x D	200	–	260	160	–	208	140	–	182	IPT	.0016	.0020	.0023	.0026	.0031	.0033
K	3	1.25 x D	0.5 x D	1 x D	200	–	230	160	–	184	140	–	161	IPT	.0013	.0016	.0019	.0021	.0024	.0024
	1	1.25 x D	0.5 x D	1 x D	390	–	490	351	–	441	351	–	441	IPT	.0023	.0029	.0034	.0037	.0042	.0042
	2	1.25 x D	0.5 x D	1 x D	360	–	460	324	–	414	324	–	414	IPT	.0019	.0025	.0029	.0033	.0038	.0041
S	3	1.25 x D	0.5 x D	1 x D	360	–	430	324	–	387	324	–	387	IPT	.0016	.0020	.0023	.0026	.0031	.0033
	1	1 x D	0.3 x D	0.3 x D	160	–	300	128	–	240	96	–	180	IPT	.0019	.0025	.0029	.0033	.0038	.0041
	2	1 x D	0.3 x D	0.3 x D	80	–	130	64	–	104	48	–	78	IPT	.0010	.0013	.0015	.0018	.0021	.0022
H	3	1.25 x D	0.5 x D	1 x D	200	–	260	160	–	208	120	–	156	IPT	.0016	.0020	.0023	.0026	.0031	.0033
	4	1.25 x D	0.5 x D	1 x D	160	–	200	128	–	160	96	–	120	IPT	.0014	.0018	.0021	.0024	.0028	.0030
H	1	1.25 x D	0.5 x D	0.75 x D	260	–	460	208	–	368	156	–	276	IPT	.0017	.0022	.0026	.0029	.0033	.0034
	2	1.25 x D	0.2 x D	0.5 x D	230	–	390	184	–	312	138	–	234	IPT	.0013	.0016	.0019	.0021	.0024	.0024

NOTE: Lower value of cutting speed is used for high stock removal applications or for higher hardness (machinability) within group.
 Higher value of cutting speed is used for finishing applications or for lower hardness (machinability) within group.
 Above parameters are based on ideal conditions. For smaller taper machining centers, please adjust parameters accordingly on diameters >1/2".
 For side milling with ap bigger than 1 x D reduce IPT by 20%!



High-Performance DUO-LOCK® Modular End Mills • Finishing/Roughing

■ 45C7 • 45C8 • Multi-Flute Finisher

Material Group												Recommended feed per tooth (IPT = inch/th) for side milling (A).						
	Side Milling (A)			short			medium			long								
	A			adapter reach									D1 – Diameter					
				WP15PE			WP15PE			WP15PE								
				Cutting Speed – vc SFM			Cutting Speed – vc SFM			Cutting Speed – vc SFM			frac.	3/8	1/2	5/8	3/4	1
ap	ae		min	max		min	max		min	max	dec.	.3750	.5000	.6250	.7500	1.0000	1.2500	
P	0	1.5 x D	0.05 x D	490	660	441	594	441	594	441	594	IPT	.0027	.0034	.0039	.0044	.0049	.0049
	1	1.5 x D	0.05 x D	490	660	441	594	441	594	441	594	IPT	.0027	.0034	.0039	.0044	.0049	.0049
	2	1.5 x D	0.05 x D	460	620	414	558	414	558	414	558	IPT	.0027	.0034	.0039	.0044	.0049	.0049
	3	1.5 x D	0.05 x D	390	520	351	468	351	468	351	468	IPT	.0023	.0029	.0034	.0039	.0045	.0048
	4	1.5 x D	0.05 x D	300	490	270	441	270	441	270	441	IPT	.0020	.0026	.0030	.0034	.0039	.0040
	5	1.5 x D	0.05 x D	200	330	170	280.5	160	264	160	264	IPT	.0018	.0023	.0027	.0031	.0036	.0039
6	1.5 x D	0.05 x D	160	250	136	212.5	128	200	128	200	IPT	.0015	.0019	.0022	.0025	.0028	.0029	
M	1	1.5 x D	0.05 x D	300	380	240	304	210	266	210	266	IPT	.0023	.0029	.0034	.0039	.0045	.0048
	2	1.5 x D	0.05 x D	200	260	160	208	140	182	140	182	IPT	.0018	.0023	.0027	.0031	.0036	.0039
	3	1.5 x D	0.05 x D	200	230	160	184	140	161	140	161	IPT	.0015	.0019	.0022	.0025	.0028	.0029
K	1	1.5 x D	0.05 x D	390	490	351	441	351	441	351	441	IPT	.0027	.0034	.0039	.0044	.0049	.0049
	2	1.5 x D	0.05 x D	360	460	324	414	324	414	324	414	IPT	.0023	.0029	.0034	.0039	.0045	.0048
	3	1.5 x D	0.05 x D	360	430	324	387	324	387	324	387	IPT	.0018	.0023	.0027	.0031	.0036	.0039
S	1	1.5 x D	0.05 x D	160	300	128	240	96	180	96	180	IPT	.0023	.0029	.0034	.0039	.0045	.0048
	2	1.5 x D	0.05 x D	80	130	64	104	48	78	48	78	IPT	.0012	.0015	.0018	.0021	.0024	.0026
	3	1.5 x D	0.05 x D	80	130	64	104	48	78	48	78	IPT	.0012	.0015	.0018	.0021	.0024	.0026
	4	1.5 x D	0.05 x D	160	200	128	160	96	120	96	120	IPT	.0017	.0021	.0025	.0028	.0033	.0036
H	1	1.5 x D	0.04 x D	260	460	208	368	156	276	156	276	IPT	.0020	.0026	.0030	.0034	.0039	.0040
	2	1.5 x D	0.04 x D	230	390	184	312	138	234	138	234	IPT	.0015	.0019	.0022	.0025	.0028	.0029

NOTE: Lower value of cutting speed is used for high stock removal applications or for higher hardness (machinability) within group.
 Higher value of cutting speed is used for finishing applications or for lower hardness (machinability) within group.
 Above parameters are based on ideal conditions.
 For smaller taper machining centers, please adjust parameters accordingly on diameters >1/2".

■ 49C6 • High-Performance Roughing

Material Group														Recommended feed per tooth (IPT = inch/th) for side milling (A). For slotting (B), reduce IPT by 20%.					
	Side Milling (A) and Slotting (B)				short			medium			long								
	A		B		adapter reach									D1 – Diameter					
					WP15PE			WP15PE			WP15PE								
					Cutting Speed – vc SFM			Cutting Speed – vc SFM			Cutting Speed – vc SFM			frac.	3/8	1/2	5/8	3/4	1 1/4
ap	ae	ap		min	max		min	max		min	max	dec.	.3750	.5000	.6250	.7500	1.2500		
P	0	1.5 x D	0.5 x D	1 x D	390	520	351	468	351	468	351	468	IPT	.0020	.0025	.0029	.0032	.0036	
	1	1.5 x D	0.5 x D	1 x D	390	520	351	468	351	468	351	468	IPT	.0020	.0025	.0029	.0032	.0036	
	2	1.5 x D	0.5 x D	1 x D	370	500	333	450	333	450	333	450	IPT	.0020	.0025	.0029	.0032	.0036	
	3	1.5 x D	0.4 x D	0.75 x D	310	420	279	378	279	378	279	378	IPT	.0017	.0021	.0025	.0028	.0035	
	4	1.5 x D	0.3 x D	0.30 x D	240	390	216	351	216	351	216	351	IPT	.0015	.0019	.0022	.0024	.0029	
5	1.5 x D	0.4 x D	0.75 x D	160	260	136	221	128	208	128	208	IPT	.0013	.0017	.0020	.0022	.0028		
M	1	1.0 x D	0.4 x D	0.75 x D	240	300	192	240	168	210	168	210	IPT	.0017	.0021	.0025	.0028	.0035	
	2	1.0 x D	0.4 x D	0.75 x D	160	210	128	168	112	147	112	147	IPT	.0013	.0017	.0020	.0022	.0028	
	3	1.0 x D	0.4 x D	0.75 x D	160	180	128	144	112	126	112	126	IPT	.0011	.0014	.0016	.0018	.0021	
K	1	1.5 x D	0.5 x D	1 x D	310	390	279	351	279	351	279	351	IPT	.0020	.0025	.0029	.0032	.0036	
	2	1.5 x D	0.4 x D	1 x D	290	370	261	333	261	333	261	333	IPT	.0017	.0021	.0025	.0028	.0035	
	3	1.5 x D	0.4 x D	1 x D	290	340	261	306	261	306	261	306	IPT	.0013	.0017	.0020	.0022	.0028	
S	1	1.0 x D	0.4 x D	0.75 x D	130	240	104	192	78	144	78	144	IPT	.0017	.0021	.0025	.0028	.0035	
	3	1.0 x D	0.4 x D	0.75 x D	70	100	56	80	42	60	42	60	IPT	.0009	.0011	.0013	.0015	.0019	
H	1	1.5 x D	0.3 x D	0.30 x D	210	370	168	296	126	222	126	222	IPT	.0015	.0019	.0022	.0024	.0029	

NOTE: Lower value of cutting speed is used for high stock removal applications or for higher hardness (machinability) within group.
 Higher value of cutting speed is used for finishing applications or for lower hardness (machinability) within group.
 Above parameters are based on ideal conditions. Please adjust parameters according to system's stability.
 For side milling with ap bigger than 1 x D reduce IPT by 20%! Do not use cylindrical shank for full slotting!

Modular End Mills

High-Performance DUO-LOCK® Modular End Mills • Roughing

■ 49C9 • Ball-Nose Roughing

Material Group												Recommended feed per tooth (IPT = inch/th) for side milling (A). For slotting (B), reduce IPT by 20%.								
	Side Milling (A) and Slotting (B)			short			medium			long			D1 – Diameter							
	A		B	adapter reach									D1 – Diameter							
	ap		ae	WP15PE			WP15PE			WP15PE			frac.	3/8	1/2	5/8	3/4	1	1 1/4	
	ap		ae	Cutting Speed – vc SFM		Cutting Speed – vc SFM		Cutting Speed – vc SFM		Cutting Speed – vc SFM		dec.	.3750	.5000	.6250	.7500	1.0000	1.2500		
P	0	1.5 x D	0.5 x D	1 x D	490	–	660	441	–	594	441	–	594	IPT	.0023	.0029	.0034	.0037	.0042	.0042
	1	1.5 x D	0.5 x D	1 x D	490	–	660	441	–	594	441	–	594	IPT	.0023	.0029	.0034	.0037	.0042	.0042
	2	1.5 x D	0.5 x D	1 x D	460	–	620	414	–	558	414	–	558	IPT	.0023	.0029	.0034	.0037	.0042	.0042
	3	1.5 x D	0.4 x D	0.75 x D	390	–	520	351	–	468	351	–	468	IPT	.0019	.0025	.0029	.0033	.0038	.0041
	4	1.5 x D	0.3 x D	0.30 x D	300	–	490	270	–	441	270	–	441	IPT	.0017	.0022	.0026	.0029	.0033	.0034
	5	1.5 x D	0.4 x D	0.75 x D	200	–	330	170	–	280.5	160	–	264	IPT	.0016	.0020	.0023	.0026	.0031	.0033
M	1	1.5 x D	0.4 x D	0.75 x D	300	–	380	240	–	304	210	–	266	IPT	.0019	.0025	.0029	.0033	.0038	.0041
	2	1.5 x D	0.4 x D	0.75 x D	200	–	260	160	–	208	140	–	182	IPT	.0016	.0020	.0023	.0026	.0031	.0033
	3	1.5 x D	0.4 x D	0.75 x D	200	–	230	160	–	184	140	–	161	IPT	.0013	.0016	.0019	.0021	.0024	.0024
K	1	1.5 x D	0.5 x D	1 x D	390	–	490	351	–	441	351	–	441	IPT	.0023	.0029	.0034	.0037	.0042	.0042
	2	1.5 x D	0.4 x D	1 x D	360	–	460	324	–	414	324	–	414	IPT	.0019	.0025	.0029	.0033	.0038	.0041
	3	1.5 x D	0.4 x D	1 x D	360	–	430	324	–	387	324	–	387	IPT	.0016	.0020	.0023	.0026	.0031	.0033
S	1	1.5 x D	0.4 x D	0.75 x D	160	–	300	128	–	240	96	–	180	IPT	.0019	.0025	.0029	.0033	.0038	.0041
	2	1.5 x D	0.3 x D	0.30 x D	80	–	130	64	–	104	48	–	78	IPT	.0010	.0013	.0015	.0018	.0021	.0022
	3	1.5 x D	0.3 x D	0.30 x D	80	–	130	64	–	104	48	–	78	IPT	.0010	.0013	.0015	.0018	.0021	.0022
	4	1.5 x D	0.3 x D	0.75 x D	160	–	200	128	–	160	96	–	120	IPT	.0014	.0018	.0021	.0024	.0028	.0030
H	1	1.5 x D	0.3 x D	0.30 x D	260	–	460	208	–	368	156	–	276	IPT	.0017	.0022	.0026	.0029	.0033	.0034
	2	1.5 x D	0.2 x D	0.20 x D	230	–	390	184	–	312	138	–	234	IPT	.0013	.0016	.0019	.0021	.0024	.0024
	3	1.5 x D	0.2 x D	0.20 x D	200	–	300	160	–	240	120	–	180	IPT	.0010	.0013	.0015	.0018	.0021	.0022





■ 4UC4 • Roughing

Material Group												Recommended feed per tooth (IPT = inch/th) for side milling (A). For slotting (B), reduce IPT by 20%.								
	Side Milling (A) and Slotting (B)			short			medium			long			D1 – Diameter							
	A		B	adapter reach									D1 – Diameter							
	ap		ae	WS15PE			WS15PE			WS15PE			frac.	3/8	1/2	5/8	3/4	1	1 1/4	
	ap		ae	Cutting Speed – vc SFM		Cutting Speed – vc SFM		Cutting Speed – vc SFM		Cutting Speed – vc SFM		dec.	.3750	.5000	.6250	.7500	1.0000	1.2500		
P	3	1.0 x D	0.5 x D	0.75 x D	390	–	520	351	–	468	351	–	468	IPT	.0019	.0025	.0029	.0033	.0033	.0041
	4	1.0 x D	0.3 x D	0.75 x D	300	–	490	270	–	441	270	–	441	IPT	.0017	.0022	.0026	.0029	.0028	.0034
	5	1.0 x D	0.4 x D	0.75 x D	200	–	330	170	–	280.5	160	–	264	IPT	.0016	.0020	.0023	.0026	.0026	.0033
	6	1.0 x D	0.3 x D	0.30 x D	160	–	250	136	–	212.5	128	–	200	IPT	.0013	.0016	.0019	.0021	.0020	.0024
M	1	1.0 x D	0.4 x D	0.75 x D	300	–	380	240	–	304	210	–	266	IPT	.0019	.0025	.0029	.0033	.0033	.0041
	2	1.0 x D	0.4 x D	0.75 x D	200	–	260	160	–	208	140	–	182	IPT	.0016	.0020	.0023	.0026	.0026	.0033
	3	1.0 x D	0.4 x D	0.75 x D	200	–	230	160	–	184	140	–	161	IPT	.0013	.0016	.0019	.0021	.0020	.0024
K	1	1.0 x D	0.5 x D	1 x D	390	–	490	351	–	441	351	–	441	IPT	.0023	.0029	.0034	.0037	.0035	.0042
	2	1.0 x D	0.5 x D	1 x D	360	–	460	324	–	414	324	–	414	IPT	.0019	.0025	.0029	.0033	.0033	.0041
	3	1.0 x D	0.5 x D	1 x D	360	–	430	324	–	387	324	–	387	IPT	.0016	.0020	.0023	.0026	.0026	.0033
S	1	1.0 x D	0.3 x D	0.75 x D	160	–	300	128	–	240	96	–	180	IPT	.0019	.0025	.0029	.0033	.0033	.0041
	2	1.0 x D	0.3 x D	0.75 x D	80	–	130	64	–	104	48	–	78	IPT	.0010	.0013	.0015	.0018	.0018	.0022
	3	1.0 x D	0.3 x D	0.75 x D	80	–	130	64	–	104	48	–	78	IPT	.0010	.0013	.0015	.0018	.0018	.0022
	4	1.0 x D	0.4 x D	0.75 x D	160	–	200	128	–	160	96	–	120	IPT	.0014	.0018	.0021	.0024	.0024	.0030
H	1	1.0 x D	0.3 x D	0.30 x D	260	–	460	208	–	368	156	–	276	IPT	.0017	.0022	.0026	.0029	.0028	.0034
	2	1.0 x D	0.2 x D	0.20 x D	230	–	390	184	–	312	138	–	234	IPT	.0013	.0016	.0019	.0021	.0020	.0024
	3	1.0 x D	0.2 x D	0.20 x D	200	–	300	160	–	240	120	–	180	IPT	.0010	.0013	.0015	.0018	.0018	.0022

NOTE: Lower value of cutting speed is used for high stock removal applications or for higher hardness (machinability) within group.
 Higher value of cutting speed is used for finishing applications or for lower hardness (machinability) within group.
 Above parameters are based on ideal conditions. Please adjust parameters according to system's stability.
 For side milling with ap bigger than 1 x D reduce IPT by 20%! Do not use cylindrical shank for full slotting!



High-Performance DUO-LOCK® Modular End Mills • Alusurf™/Corner Rounding/Chamfering

Alusurf • 5AC2 • 5AC3 • Aluminum

Material Group																				
	Side Milling (A) and Slotting (B)				short		medium		long		Recommended feed per tooth (IPT = inch/th) for side milling (A). For slotting (B), reduce IPT by 20%.									
	A		B		adapter reach						D1 – Diameter									
					UNCOATED		UNCOATED		UNCOATED											
	ap		ae		Cutting Speed – vc SFM		Cutting Speed – vc SFM		Cutting Speed – vc SFM		frac.	3/8	1/2	5/8	3/4	1	1 1/4			
min	max	min	max	min	max	min	max	dec.	.3750	.5000	.6250	.7500	1.0000	1.2500						
N	1	1.5 x D	0.3 x D	1.0 x D	1640	–	6560	1312	–	3936	984	–	3936	IPT	.0029	.0038	.0048	.0057	.0077	.0096
	2	1.5 x D	0.3 x D	1.0 x D	1640	–	4920	1312	–	2952	984	–	2952	IPT	.0023	.0031	.0038	.0046	.0061	.0077
	3	1.5 x D	0.3 x D	1.0 x D	1640	–	4920	1312	–	2952	984	–	2952	IPT	.0020	.0027	.0033	.0040	.0054	.0067
	4	1.5 x D	0.3 x D	1.0 x D	1310	–	2460	1048	–	1476	786	–	1476	IPT	.0020	.0027	.0033	.0040	.0054	.0067
	5	1.5 x D	0.3 x D	1.0 x D	820	–	3280	656	–	1968	492	–	1968	IPT	.0026	.0034	.0043	.0052	.0069	.0086

NOTE: ap for spindle with ceramic bearings multiply by 0.5.
 For better surface finish, reduce feed per tooth.
 Above parameters are based on ideal conditions. Please adjust parameters according to system's stability.
 For side milling with ap bigger than 1 x D, reduce IPT by 20%! Do not use cylindrical shank for full slotting!

80C5 Corner Rounding • 80C6 Chamfering

Material Group																
	Side Milling (A)		short		medium		long		Recommended feed per tooth (IPT = inch/th) for side milling (A).							
	A		adapter reach						D1 – Diameter							
			WP15PE		WP15PE		WP15PE									
	ap		ae		Cutting Speed – vc SFM		Cutting Speed – vc SFM		Cutting Speed – vc SFM		frac.	3/8	1/2	5/8		
min	max	min	max	min	max	min	max	dec.	.3750	.5000	.6250					
P	0	0.35 x D	0.35 x D	490	–	660	441	–	594	441	–	594	IPT	.0022	.0027	.0032
	1	0.35 x D	0.35 x D	490	–	660	441	–	594	441	–	594	IPT	.0022	.0027	.0032
	2	0.35 x D	0.35 x D	460	–	620	414	–	558	414	–	558	IPT	.0022	.0027	.0032
	3	0.35 x D	0.35 x D	390	–	520	351	–	468	351	–	468	IPT	.0018	.0023	.0027
	4	0.35 x D	0.35 x D	300	–	490	270	–	441	270	–	441	IPT	.0016	.0021	.0024
	5	0.35 x D	0.35 x D	200	–	330	170	–	280.5	160	–	264	IPT	.0015	.0018	.0022
M	6	0.35 x D	0.35 x D	160	–	250	136	–	212.5	128	–	200	IPT	.0012	.0015	.0018
	1	0.35 x D	0.35 x D	300	–	380	240	–	304	210	–	266	IPT	.0018	.0023	.0027
	2	0.35 x D	0.35 x D	200	–	260	160	–	208	140	–	182	IPT	.0015	.0018	.0022
K	3	0.35 x D	0.35 x D	200	–	230	160	–	184	140	–	161	IPT	.0012	.0015	.0018
	1	0.35 x D	0.35 x D	390	–	490	351	–	441	351	–	441	IPT	.0022	.0027	.0032
	2	0.35 x D	0.35 x D	360	–	460	324	–	414	324	–	414	IPT	.0018	.0023	.0027
N	3	0.35 x D	0.35 x D	360	–	430	324	–	387	324	–	387	IPT	.0015	.0018	.0022
	1	0.35 x D	0.35 x D	1640	–	6560	1312	–	5248	984	–	3936	IPT	.0030	.0040	.0050
	2	0.35 x D	0.35 x D	1640	–	4920	1312	–	3936	984	–	2952	IPT	.0024	.0032	.0040
	3	0.35 x D	0.35 x D	1640	–	4920	1312	–	3936	984	–	2952	IPT	.0021	.0028	.0035
	4	0.35 x D	0.35 x D	1310	–	2460	1048	–	1968	786	–	1476	IPT	.0021	.0028	.0035
	5	0.35 x D	0.35 x D	820	–	3280	656	–	2624	492	–	1968	IPT	.0027	.0036	.0045
	6	0.35 x D	0.35 x D	330	–	2460	264	–	1968	198	–	1476	IPT	.0030	.0040	.0050
	7	0.35 x D	0.35 x D	330	–	2460	264	–	1968	198	–	1476	IPT	.0021	.0028	.0035
S	1	0.35 x D	0.35 x D	160	–	300	128	–	240	96	–	180	IPT	.0018	.0023	.0027
	2	0.35 x D	0.35 x D	80	–	130	64	–	104	48	–	78	IPT	.0010	.0012	.0015
	3	0.35 x D	0.35 x D	80	–	130	64	–	104	48	–	78	IPT	.0010	.0012	.0015
	4	0.35 x D	0.35 x D	160	–	200	128	–	160	96	–	120	IPT	.0013	.0017	.0020
H	1	0.35 x D	0.35 x D	260	–	460	208	–	368	156	–	276	IPT	.0016	.0021	.0024

NOTE: Lower value of cutting speed is used for high stock removal applications or for higher hardness (machinability) within group.
 Higher value of cutting speed is used for finishing applications or for lower hardness (machinability) within group.
 Above parameters are based on ideal conditions. Please adjust parameters according to system's stability.

Modular End Mills

High-Performance DUO-LOCK® Modular End Mills

■ System Assembly Information

Please wear sufficient personal safety equipment such as gloves and eye protection during assembly.

- 1 Clean the Duo-Lock™ cutting insert and shank coupling.



- 2 Mount the Duo-Lock™ adapter in a mounting block with a clamping chuck sufficient to enable torque transmission.



- 3 Screw the Duo-Lock™ cutting tip into adapter by hand.

Attention: Use of protective gloves is mandatory!



- 4 A gap of approx. .06-.12" should be visible.



- 5 Apply the torque shown in the table. Use of a high quality common torque wrench is mandatory. The ERICKSON™ Torque Master wrench is recommended.



Duo-Lock™ Size	Torque Nm	Torque ft. lbs.
DL 10	20	15
DL 12	30	22
DL 16	60	44
DL 20	80	59
DL 25	100	74
DL 32	130	96



Machining Central App from WIDIA™

The fastest, easiest way to get feeds and speeds.

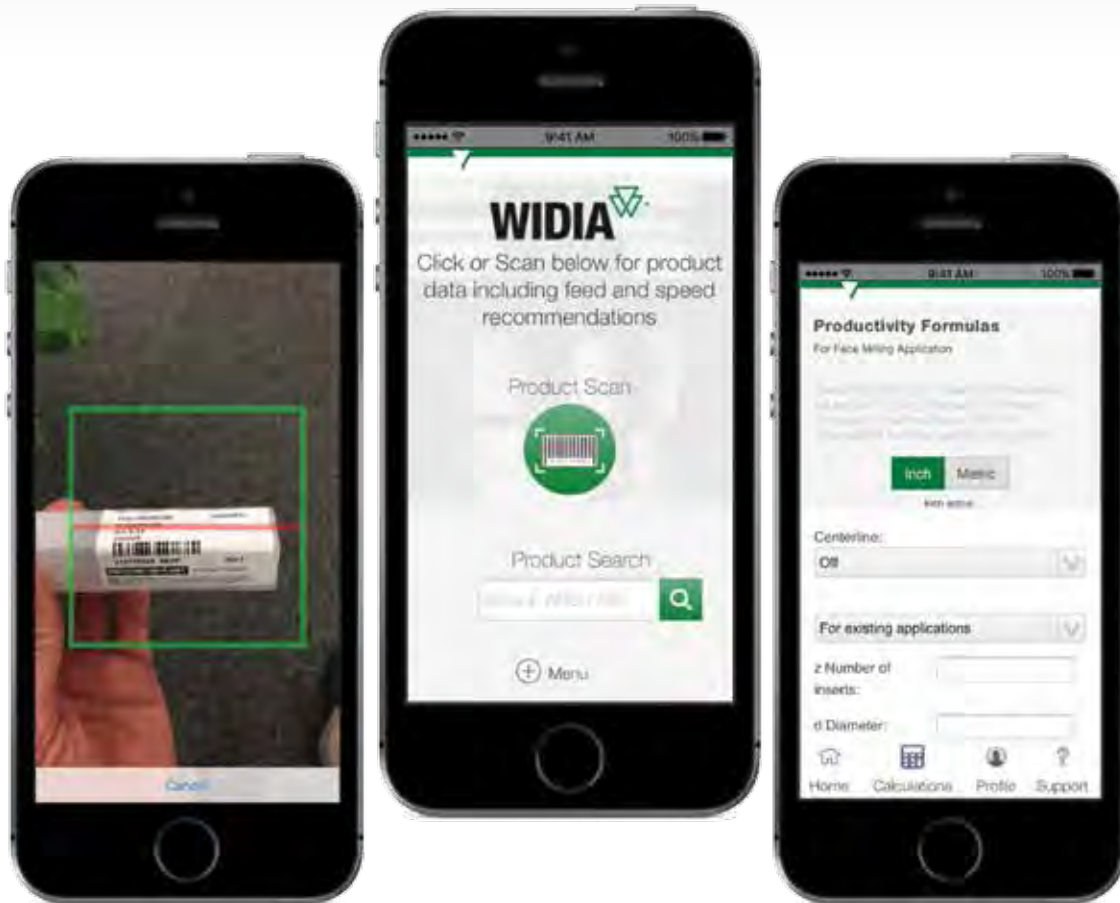

SCAN

With the new WIDIA app, product data is just a quick scan away. Now, when you're on the floor and need to quickly access the speeds and feeds of your favorite WIDIA tool, the WIDIA app gives you reliable information in just a few seconds.



SEARCH

Don't have a barcode? The new WIDIA app includes another simple search technique — just type the tool's corresponding order number or the ANSI or ISO catalog number into the search bar. You'll get the same reliable data as if you'd scanned the tool's barcode. It's simple and quick — no interruption in production!



CALCULATE

Have a specific machining need that our recommended speeds and feeds don't quite address? Try out our three NOVO™ based calculators. Both end milling and face milling calculators are available. Simply fill in the blank fields, and our calculators will quickly provide the data you need.

DOWNLOAD THE WIDIA MACHINING CENTRAL MOBILE APP

widia.com



GP

WIDIA-Hanita™ General Purpose End Mills

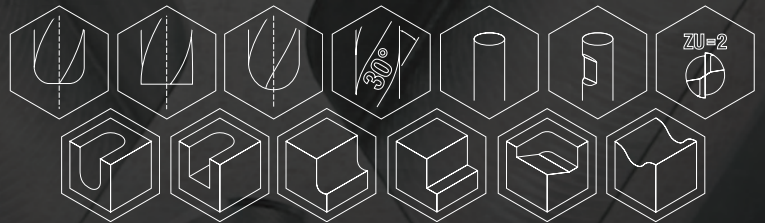

The Evolution of a Solid Carbide End Mill Revolution

The WIDIA-Hanita solid carbide end mill product lines have built a strong ongoing reputation of continuous development and diversification.

WIDIA-Hanita general purpose end mills offer plunging, slotting, and profiling for a wide range of materials and applications. Designed to provide high metal removal rates and excellent surface conditions at a value price. A wide range of diameters, lengths, and corner styles (such as chamfered, sharp edge, and ball nose) are available from stock.





2-Flute

- Center cutting.
- Steel, stainless steel, and cast iron.

Square Series I2S

- Wide range of lengths-of-cut — short, regular, long, and extra long.
- Sharp edge with dubbing for extended tool life.

Ball Nose Series I2B

- Wide range of lengths-of-cut — short, regular, long, and extra long.

Radius Series I2R

- Regular length-of-cut with corner radius.



3-Flute

- Center cutting.
- Steel, stainless steel, and cast iron.
- Sharp edge with dubbing for extended tool life.

Square Series I3S

- Short length-of-cut and overall length for ramping applications.

Series I3S..L/I3S..X

- Long and extra long length-of-cut and overall length for side milling applications.



4-Flute

- Steel, stainless steel, and cast iron.
- Center cutting.

Square Series I4S

- Wide range of lengths-of-cut — short, regular, long, and extra long.
- Sharp edge with dubbing for extended tool life.

Ball Nose Series I4B

- Wide range of lengths-of-cut — short, regular, long, and extra long.

Radius Series I4R

- Regular length-of-cut with corner radius.



WIDIA 

widia.com

2- and 4-Flute WIDIA-Hanita™ General Purpose End Mills

- Increased manufacturing flexibility and reduced tool cost.
- Fewer tool changes and high Metal Removal Rates (MRR).
- No specific tool for roughing and finishing required.
- Eccentric relief for improved edge stability and high tool life.
- Easy and cost-efficient regrinding due to eccentric relief.

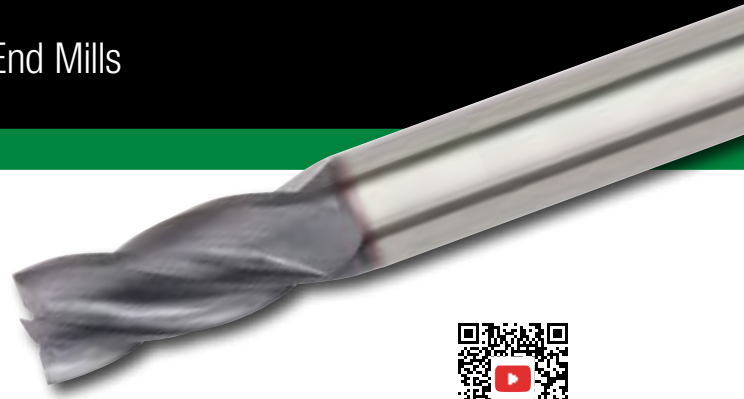

See me in action!

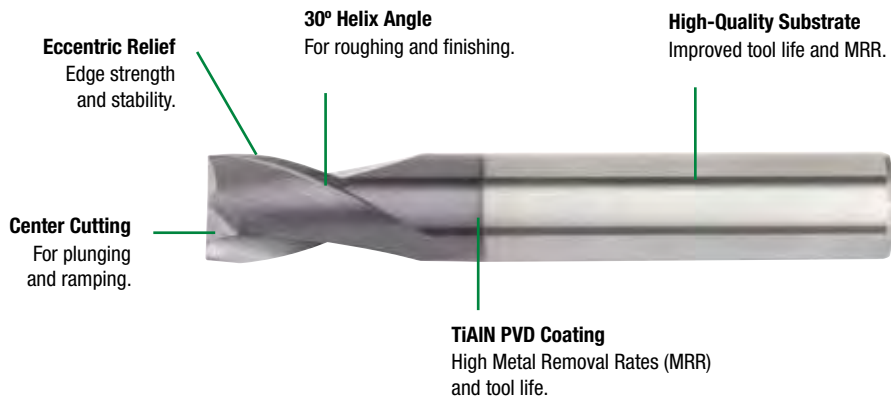

2- and 4-Flute General Purpose End Mills

- General purpose tools for a wide range of workpiece materials.
- Roughing and finishing with one tool.
- Various lengths-of-cut and overall lengths with different front-end designs available.



Series I2R

- Radius corner.
- New asymmetrical fluting geometry.
- High metal removal rates and tool life in:
 - Stainless steels, steels, and alloyed steels.
 - High-temperature alloys and titanium.
- Two flutes for high flexibility in unstable conditions.



Series I4R

- Radius corner.
- Steel and stainless steel geometries.
- Four flutes for high Metal Removal Rates (MRR) and tool life.

WIDIA-Hanita™ General Purpose End Mills • Roughing/Finishing

■ Series I2R • 2-Flute/I4R • 4-Flute Radius-Style End Mills

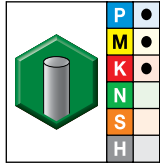

2-Flute
grade TiAlN

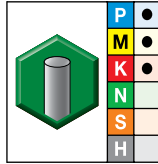

4-Flute
grade TiAlN

● first choice
○ alternate choice

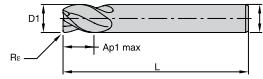

order #	order #	D1	D	length of cut Ap1 max	length L	Re
6286059	6282423	1/16	1/8	1/8	1 1/2	.010
6286060	6282424	1/16	1/8	1/8	1 1/2	.015
6286101	6282426	3/32	1/8	3/8	1 1/2	.010
6286102	6282427	3/32	1/8	3/8	1 1/2	.015
6286103	6282428	1/8	1/8	1/2	1 1/2	.010
6286104	6282429	1/8	1/8	1/2	1 1/2	.015
6286105	6282430	1/8	1/8	1/2	1 1/2	.020
6286106	6282441	1/8	1/8	1/2	1 1/2	.030
6286107	6282442	3/16	3/16	5/8	2	.010
6286108	6282443	3/16	3/16	5/8	2	.015
6286109	6282444	3/16	3/16	5/8	2	.020
6286110	6282446	3/16	3/16	5/8	2	.030
6286131	6282447	1/4	1/4	3/4	2 1/2	.015
6286132	6282448	1/4	1/4	3/4	2 1/2	.020
6286133	6282449	1/4	1/4	3/4	2 1/2	.030
6286134	6282450	1/4	1/4	3/4	2 1/2	.045
6286135	6282461	1/4	1/4	3/4	2 1/2	.060
6286136	6282462	5/16	5/16	13/16	2 1/2	.015
6286137	6282463	5/16	5/16	13/16	2 1/2	.020
6286138	6282464	5/16	5/16	13/16	2 1/2	.030
6286139	6282465	5/16	5/16	13/16	2 1/2	.045
6286140	6282467	5/16	5/16	13/16	2 1/2	.060
6286151	6285506	3/8	3/8	1	2 1/2	.015
6286152	6282468	3/8	3/8	1	2 1/2	.020
6286153	6282469	3/8	3/8	1	2 1/2	.030
6286154	6282470	3/8	3/8	1	2 1/2	.045
6286155	6282501	3/8	3/8	1	2 1/2	.060
6286763	6282503	1/2	1/2	1	3	.015
6286764	6282504	1/2	1/2	1	3	.020
6286765	6282505	1/2	1/2	1	3	.030
6286766	6282506	1/2	1/2	1	3	.045
6286767	6282507	1/2	1/2	1	3	.060
6286768	6282508	5/8	5/8	1 1/4	3 1/2	.015
6286769	6282509	5/8	5/8	1 1/4	3 1/2	.020
6286770	6282510	5/8	5/8	1 1/4	3 1/2	.030
6286811	6282531	5/8	5/8	1 1/4	3 1/2	.045
6286812	6282532	5/8	5/8	1 1/4	3 1/2	.060
6286813	6282533	5/8	5/8	1 1/4	3 1/2	.090
6286814	6282535	5/8	5/8	1 1/4	3 1/2	.125
6286815	6282536	3/4	3/4	1 1/2	4	.015
6286816	6282537	3/4	3/4	1 1/2	4	.020
6286817	6282538	3/4	3/4	1 1/2	4	.030
6286818	6282539	3/4	3/4	1 1/2	4	.045
6286819	6282540	3/4	3/4	1 1/2	4	.060

(continued)

(Series I2R • 2-Flute/I4R • 4-Flute Radius-Style End Mills — continued)

■ Series I2R • 2-Flute/I4R • 4-Flute Radius-Style End Mills

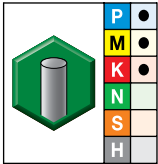

2-Flute
grade TiAlN

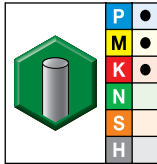

4-Flute
grade TiAlN

- first choice
- alternate choice

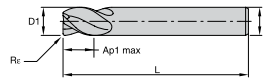

WIDIA HANITA 

order #	order #	D1	D	length of cut Ap1 max	length L	Re
6286820	6282561	3/4	3/4	1 1/2	4	.090
6286821	6282562	3/4	3/4	1 1/2	4	.125
6286822	6282563	7/8	7/8	1 1/2	4	.015
6286823	6282564	7/8	7/8	1 1/2	4	.020
6286824	6282565	7/8	7/8	1 1/2	4	.030
6286825	6282566	7/8	7/8	1 1/2	4	.045
6286826	6282567	7/8	7/8	1 1/2	4	.060
6286827	6282568	7/8	7/8	1 1/2	4	.090
6286828	6282569	7/8	7/8	1 1/2	4	.125
6286829	6282570	1	1	1 1/2	4	.015
6286830	6282571	1	1	1 1/2	4	.020
6286851	6282572	1	1	1 1/2	4	.030
6286852	6282573	1	1	1 1/2	4	.045
6286853	6282574	1	1	1 1/2	4	.060
6286854	6282575	1	1	1 1/2	4	.090
6286855	6282576	1	1	1 1/2	4	.125



NOTE: For application data, please see page 69.

End Mill Tolerances



D1	tolerance e8	D	tolerance h6 + / -
≤ 3	-0,014/-0,028	≤ 3	0/0,006
> 3-6	-0,020/-0,038	> 3-6	0/0,008
> 6-10	-0,025/-0,047	> 6-10	0/0,009
> 10-18	-0,032/-0,059	> 10-18	0/0,011
> 18-30	-0,040/-0,073	> 18-30	0/0,013

WIDIA-Hanita™ General Purpose End Mills • Roughing/Finishing

■ Series I2S..S I2S..R I2R... • TiAlN • 2-Flute Square-End and Radius-Style End Mills

Material Group																							
	Side Milling (A) and Slotting (B)				TiAlN		Recommended feed per tooth (IPT = inch/th) for side milling (A). For slotting (B), reduce IPT by 20%.																
	A		B		Cutting Speed – vc SFM		D1 – Diameter																
	ap	ae	ap	min	max	frac.	1/64	1/32	1/16	5/64	3/32	1/8	3/16	1/4	5/16	3/8	1/2	5/8	3/4	1			
P	0	Ap1 max	0.1 x D	0.5 x D	490	–	660	IPT	.0001	.0002	.0004	.0005	.0007	.0009	.0013	.0018	.0023	.0027	.0034	.0039	.0044	.0049	
	1	Ap1 max	0.1 x D	0.5 x D	490	–	660	IPT	.0001	.0002	.0004	.0005	.0007	.0009	.0013	.0018	.0023	.0027	.0034	.0039	.0044	.0049	
	2	Ap1 max	0.1 x D	0.5 x D	460	–	620	IPT	.0001	.0002	.0004	.0005	.0007	.0009	.0013	.0018	.0023	.0027	.0034	.0039	.0044	.0049	
	3	Ap1 max	0.1 x D	0.5 x D	390	–	520	IPT	.0001	.0002	.0004	.0004	.0005	.0007	.0011	.0015	.0020	.0023	.0029	.0034	.0039	.0045	
M	4	Ap1 max	0.1 x D	0.5 x D	300	–	490	IPT	.0001	.0002	.0003	.0004	.0005	.0007	.0010	.0014	.0017	.0020	.0026	.0030	.0034	.0039	
	1	Ap1 max	0.1 x D	0.5 x D	300	–	380	IPT	.0001	.0002	.0004	.0004	.0005	.0007	.0011	.0015	.0020	.0023	.0029	.0034	.0039	.0045	
K	2	Ap1 max	0.1 x D	0.5 x D	200	–	260	IPT	.0001	.0001	.0003	.0004	.0004	.0006	.0009	.0012	.0016	.0018	.0023	.0027	.0031	.0036	
	1	Ap1 max	0.1 x D	0.5 x D	390	–	490	IPT	.0001	.0002	.0004	.0005	.0007	.0009	.0013	.0018	.0023	.0027	.0034	.0039	.0044	.0049	
K	2	Ap1 max	0.1 x D	0.5 x D	360	–	460	IPT	.0001	.0002	.0004	.0004	.0005	.0007	.0011	.0015	.0020	.0023	.0029	.0034	.0039	.0045	

■ Series I4R..S I4S..S I4R..R I4S..R • TiAlN • 4-Flute Square-End and Radius-Style End Mills

Material Group																							
	Side Milling (A) and Slotting (B)				TiAlN		Recommended feed per tooth (IPT = inch/th) for side milling (A). For slotting (B), reduce IPT by 20%.																
	A		B		Cutting Speed – vc SFM		D1 – Diameter																
	ap	ae	ap	min	max	frac.	1/64	1/32	1/16	5/64	3/32	1/8	3/16	1/4	5/16	3/8	1/2	5/8	3/4	1			
P	0	Ap1 max	0.1 x D	0.5 x D	490	–	660	IPT	.0001	.0002	.0004	.0005	.0007	.0009	.0013	.0018	.0023	.0027	.0034	.0039	.0044	.0049	
	1	Ap1 max	0.1 x D	0.5 x D	490	–	660	IPT	.0001	.0002	.0004	.0005	.0007	.0009	.0013	.0018	.0023	.0027	.0034	.0039	.0044	.0049	
	2	Ap1 max	0.1 x D	0.5 x D	460	–	620	IPT	.0001	.0002	.0004	.0005	.0007	.0009	.0013	.0018	.0023	.0027	.0034	.0039	.0044	.0049	
	3	Ap1 max	0.1 x D	0.5 x D	390	–	520	IPT	.0001	.0002	.0004	.0004	.0005	.0007	.0011	.0015	.0020	.0023	.0029	.0034	.0039	.0045	
M	4	Ap1 max	0.1 x D	0.5 x D	300	–	490	IPT	.0001	.0002	.0003	.0004	.0005	.0007	.0010	.0014	.0017	.0020	.0026	.0030	.0034	.0039	
	1	Ap1 max	0.1 x D	0.5 x D	300	–	380	IPT	.0001	.0002	.0004	.0004	.0005	.0007	.0011	.0015	.0020	.0023	.0029	.0034	.0039	.0045	
K	2	Ap1 max	0.1 x D	0.5 x D	200	–	260	IPT	.0001	.0001	.0003	.0004	.0004	.0006	.0009	.0012	.0016	.0018	.0023	.0027	.0031	.0036	
	1	Ap1 max	0.1 x D	0.5 x D	390	–	490	IPT	.0001	.0002	.0004	.0005	.0007	.0009	.0013	.0018	.0023	.0027	.0034	.0039	.0044	.0049	
K	2	Ap1 max	0.1 x D	0.5 x D	360	–	460	IPT	.0001	.0002	.0004	.0004	.0005	.0007	.0011	.0015	.0020	.0023	.0029	.0034	.0039	.0045	

NOTE: Lower value of cutting speed is used for high stock removal applications or for higher hardness (machinability) within group.
Higher value of cutting speed is used for finishing applications or for lower hardness (machinability) within group.
Above parameters are based on ideal conditions. For smaller taper machining centers, please adjust parameters accordingly on >1/2" diameter.

TOP DRILL

Stainless Steel Drilling Redefined

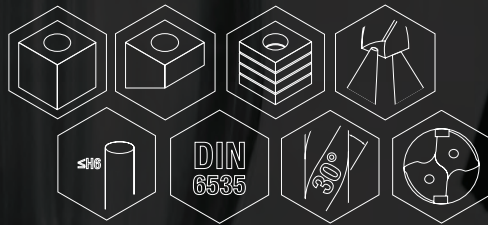



STM



Productivity

- Excellent chip flow due to flute design and finish.
- New coating enables higher cutting speeds.
- Higher feed rates on stainless steels and duplex.

Performance

- Available for custom solutions, as well as step-drilling.
- Real 8 x D drill lengths.
- Cylindrical shank h6 for perfect runout.
- Double-margin design for critical operations.

Cutting speed increased by up to 20% in drilling on austenitic and duplex stainless steels.

Series	Coolant	Length Ratio	Diameter Range
TDS451	Through Coolant	3 x D	.1181-.7874" (3,0-20,0 mm)
TDS452		5 x D	
TDS453		8 x D	

WIDIA 

widia.com

TOP DRILL S™

TDS45x for Stainless Steel



- Excellent centering ability.
- Increased wear resistance in heat-generating applications with tough materials.
- The average tool life improves dramatically 10–30%.
- The new technology improves chip evacuation, especially in deep holes and difficult cutting conditions.
- New gash design specifically for stainless steel, as well as difficult-to-machine materials:
 - Smooth chip transition from cutting edge to flutes.
 - Less cutting forces and temperatures generated. New WM15PD coating with high-aluminum content and polished flutes.
- Two margin lands.
- Real 8 x D ratio
 - Increased length of cut.
- Complete portfolio from .1181–.7874" in 3 x D, 5 x D, and 8 x D ratios.

WM15PD Grade
A multilayer, AlTiN-based coating with high hot hardness enables high-speed drilling and MQL applications.

Patented TDS Point
Excellent centering. Highest feed and speeds. Force reduction.

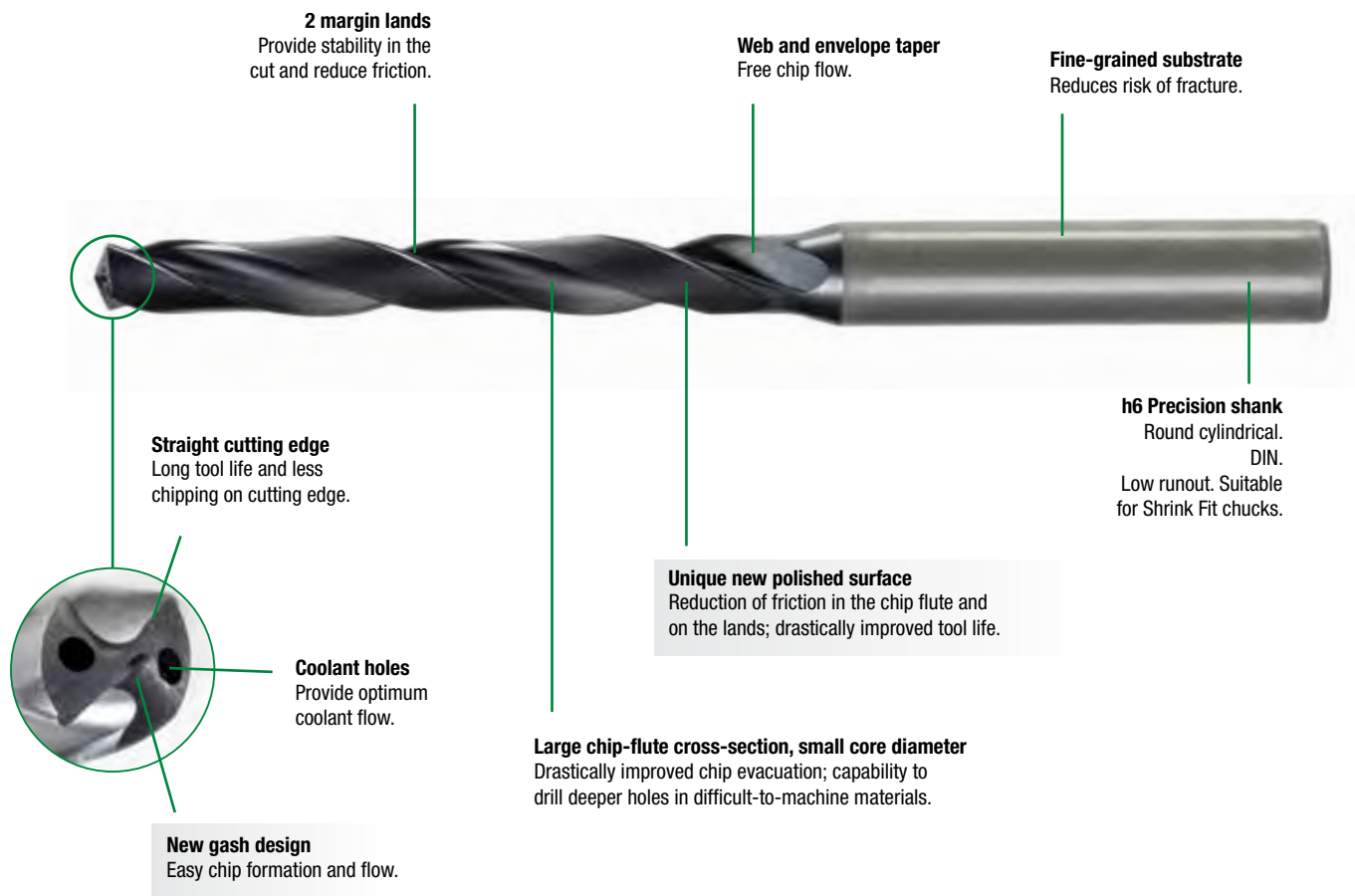

TOP DRILL S™ with Through Coolant • Stainless Steel

■ TDS451A • 3 x D/TDS452A • 5 x D/TDS453A • 8 x D

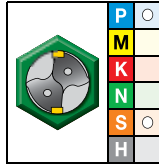
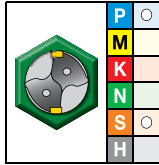
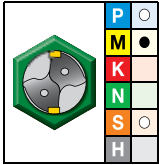

● first choice
○ alternate choice

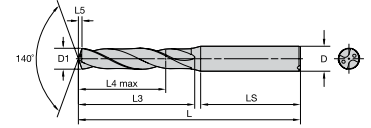

For information on L, L3, and L4 max, see the Dimension Table on page 79.

3 x D grade WM15PD AlTiN	5 x D grade WM15PD AlTiN	8 x D grade WM15PD AlTiN	D1 diameter				L5	LS	D
			mm	in	fraction	wire size			
6327647	6327948	6328197	3,000	.1181	—	—	0,5	36	6
6327648	6327950	6328200	3,048	.1200	—	31	0,5	36	6
6327649	6327952	6328202	3,100	.1220	—	—	0,5	36	6
6327650	6327954	6328204	3,175	.1250	1/8	—	0,5	36	6
6327711	6327956	6328206	3,200	.1260	—	—	0,5	36	6
6327712	6327958	6328208	3,264	.1285	—	30	0,5	36	6
6327713	6327960	6328209	3,300	.1299	—	—	0,5	36	6
6327714	6327962	6328211	3,400	.1339	—	—	0,6	36	6
6327715	6327964	6328213	3,455	.1360	—	—	0,6	36	6
6327716	6327966	6328216	3,500	.1378	—	—	0,6	36	6
6327717	6327968	6328218	3,571	.1406	9/64	—	0,6	36	6
6327718	6327970	6328219	3,600	.1417	—	—	0,6	36	6
6327719	6327972	6328221	3,658	.1440	—	—	0,6	36	6
6327720	6327974	6328223	3,700	.1457	—	—	0,6	36	6
6327721	6327976	6328225	3,734	.1470	—	26	0,6	36	6
6327722	6327978	6328227	3,800	.1496	—	—	0,6	36	6
6327723	6327980	6328229	3,900	.1535	—	—	0,6	36	6
6327724	6327982	6328231	3,970	.1563	5/32	—	0,7	36	6
6327725	6327984	6328233	4,000	.1575	—	—	0,7	36	6
6327726	6327986	6328235	4,039	.1590	—	—	0,7	36	6
6327727	6327988	6328237	4,090	.1610	—	—	0,7	36	6
6327728	6327990	6328239	4,100	.1614	—	—	0,7	36	6
6327729	6327992	6328241	4,200	.1654	—	—	0,7	36	6
6327730	6327994	6328242	4,217	.1660	—	—	0,7	36	6
6327741	6327996	6328243	4,300	.1693	—	—	0,7	36	6
6327742	6327998	6328244	4,366	.1719	—	—	0,7	36	6
6327743	6327999	6328245	4,400	.1732	—	—	0,7	36	6
6327744	6328000	6328246	4,500	.1772	—	—	0,7	36	6
6327745	6328001	6328247	4,600	.1811	—	—	0,8	36	6
6327746	6328002	6328248	4,623	.1820	—	14	0,8	36	6
6327747	6328003	6328249	4,700	.1850	—	—	0,8	36	6
6327748	6328004	6328250	4,763	.1875	3/16	—	0,8	36	6
6327749	6328005	6328261	4,800	.1890	—	—	0,8	36	6
6327750	6328006	6328262	4,852	.1910	—	—	0,8	36	6
6327751	6328007	6328263	4,900	.1929	—	—	0,8	36	6
6327752	6328008	6328264	5,000	.1969	—	—	0,8	36	6
6327753	6328009	6328265	5,100	.2008	—	—	0,9	36	6
6327754	6328010	6328266	5,106	.2010	—	—	0,9	36	6
6327755	6328011	6328267	5,159	.2031	—	—	0,9	36	6
6327756	6328012	6328268	5,200	.2047	—	—	0,9	36	6
6327757	6328013	6328269	5,300	.2087	—	—	0,9	36	6
6327758	6328014	6328270	5,400	.2126	—	—	0,9	36	6
6327759	6328015	6328271	5,410	.2130	—	3	0,9	36	6
6327760	6328016	6328272	5,500	.2165	—	—	0,9	36	6

(continued)

TOP DRILL S™

TOP DRILL S with Through Coolant • Stainless Steel

(TDS451A • 3 x D / TDS452A • 5 x D / TDS453A • 8 x D — continued)

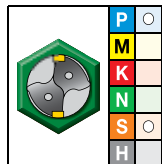
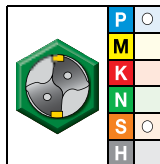
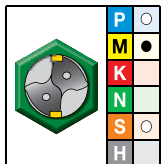

- first choice
- alternate choice

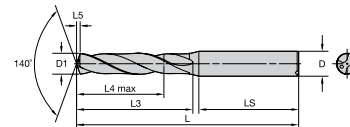

For information on L, L3, and L4 max, see the Dimension Table on page 79.

3 x D grade WM15PD AITiN	5 x D grade WM15PD AITiN	8 x D grade WM15PD AITiN	D1 diameter				L5	LS	D
			mm	in	fraction	wire size			
6327761	6328017	6328273	5,558	.2188	—	—	0,9	36	6
6327762	6328018	6328274	5,600	.2205	—	—	0,9	36	6
6327763	6328019	6328275	5,616	.2211	—	2	0,9	36	6
6327764	6328020	6328276	5,700	.2244	—	—	1,0	36	6
6327765	6328021	6328277	5,800	.2283	—	—	1,0	36	6
6327766	6328022	6328278	5,900	.2323	—	—	1,0	36	6
6327767	6328023	6328279	5,954	.2344	15/64	—	1,0	36	6
6327768	6328024	6328280	6,000	.2362	—	—	1,0	36	6
6327769	6328025	6328291	6,100	.2402	—	—	1,0	36	8
6327770	6328026	6328292	6,200	.2441	—	—	1,0	36	8
6327771	6328027	6328293	6,300	.2480	—	—	1,1	36	8
6327772	6328028	6328294	6,350	.2500	1/4	—	1,1	36	8
6327773	6328029	6328295	6,400	.2520	—	—	1,1	36	8
6327774	6328030	6328296	6,500	.2559	—	—	1,1	36	8
6327775	6328031	6328297	6,528	.2570	—	—	1,1	36	8
6327776	6328032	6328298	6,600	.2598	—	—	1,1	36	8
6327777	6328033	6328299	6,630	.2610	—	—	1,1	36	8
6327778	6328034	6328300	6,700	.2638	—	—	1,1	36	8
6327779	6328035	6328301	6,746	.2656	17/64	—	1,1	36	8
6327780	6328036	6328302	6,800	.2677	—	—	1,1	36	8
6327781	6328037	6328303	6,900	.2717	—	—	1,2	36	8
6327782	6328038	6328304	7,000	.2756	—	—	1,2	36	8
6327783	6328039	6328305	7,100	.2795	—	—	1,2	36	8
6327784	6328040	6328306	7,145	.2813	9/32	—	1,2	36	8
6327785	6328041	6328307	7,200	.2835	—	—	1,2	36	8
6327786	6328042	6328308	7,300	.2874	—	—	1,2	36	8
6327787	6328043	6328309	7,400	.2913	—	—	1,3	36	8
6327788	6328044	6328310	7,500	.2953	—	—	1,3	36	8
6327789	6328045	6328311	7,541	.2969	—	—	1,3	36	8
6327790	6328046	6328312	7,600	.2992	—	—	1,3	36	8
6327791	6328047	6328313	7,700	.3031	—	—	1,3	36	8
6327792	6328048	6328314	7,800	.3071	—	—	1,3	36	8
6327793	6328049	6328315	7,900	.3110	—	—	1,3	36	8
6327794	6328050	6328316	7,938	.3125	5/16	—	1,3	36	8
6327795	6328051	6328317	8,000	.3150	—	—	1,4	36	8
6327796	6328052	6328318	8,100	.3189	—	—	1,4	40	10
6327797	6328053	6328319	8,200	.3228	—	—	1,4	40	10
6327798	6328054	6328320	8,300	.3268	—	—	1,4	40	10
6327799	6328055	6328321	8,334	.3281	—	—	1,4	40	10
6327800	6328056	6328322	8,400	.3307	—	—	1,4	40	10
6327801	6328057	6328323	8,433	.3320	—	—	1,4	40	10
6327802	6328058	6328324	8,500	.3346	—	—	1,4	40	10
6327803	6328059	6328325	8,600	.3386	—	—	1,5	40	10
6327804	6328060	6328326	8,700	.3425	—	—	1,5	40	10

(continued)

TOP DRILL S™ with Through Coolant • Stainless Steel

(TDS451A • 3 x D / TDS452A • 5 x D / TDS453A • 8 x D — continued)

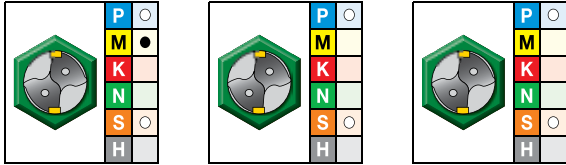

- first choice
- alternate choice

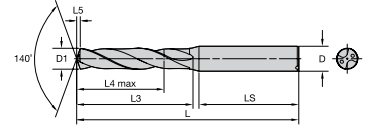

For information on L, L3, and L4 max, see the Dimension Table on page 79.

			D1 diameter						
3 x D grade WM15PD AlTiN	5 x D grade WM15PD AlTiN	8 x D grade WM15PD AlTiN	mm	in	fraction	wire size	L5	LS	D
6327805	6328061	6328327	8,733	.3438	—	—	1,5	40	10
6327806	6328062	6328328	8,800	.3465	—	—	1,5	40	10
6327807	6328063	6328329	8,900	.3504	—	—	1,5	40	10
6327808	6328064	6328330	9,000	.3543	—	—	1,5	40	10
6327809	6328065	6328331	9,100	.3583	—	—	1,6	40	10
6327810	6328066	6328332	9,129	.3594	23/64	—	1,6	40	10
6327811	6328067	6328333	9,200	.3622	—	—	1,6	40	10
6327812	6328068	6328335	9,300	.3661	—	—	1,6	40	10
6327813	6328069	6328336	9,347	.3680	—	—	1,6	40	10
6327814	6328070	6328337	9,400	.3701	—	—	1,6	40	10
6327815	6328071	6328338	9,500	.3740	—	—	1,6	40	10
6327816	6328072	6328339	9,525	.3750	3/8	—	1,6	40	10
6327817	6328073	6328340	9,600	.3780	—	—	1,6	40	10
6327818	6328074	6328341	9,700	.3819	—	—	1,7	40	10
6327819	6328075	6328342	9,800	.3858	—	—	1,7	40	10
6327820	6328076	6328343	9,900	.3898	—	—	1,7	40	10
6327821	6328077	6328344	9,921	.3906	25/64	—	1,7	40	10
6327822	6328078	6328345	10,000	.3937	—	—	1,7	40	10
6327823	6328079	6328346	10,100	.3976	—	—	1,7	45	12
6327824	6328080	6328347	10,200	.4016	—	—	1,7	45	12
6327825	6328081	6328348	10,300	.4055	—	—	1,8	45	12
6327826	6328082	6328349	10,320	.4063	13/32	—	1,8	45	12
6327827	6328083	6328350	10,400	.4094	—	—	1,8	45	12
6327828	6328084	6328351	10,500	.4134	—	—	1,8	45	12
6327829	6328085	6324404	10,600	.4173	—	—	1,8	45	12
6327830	6328086	6324405	10,700	.4213	—	—	1,8	45	12
6327841	6328087	6324406	10,716	.4219	—	—	1,8	45	12
6327842	6328088	6324407	10,800	.4252	—	—	1,9	45	12
6327843	6328089	6324408	10,900	.4291	—	—	1,9	45	12
6327844	6328090	6324409	11,000	.4331	—	—	1,9	45	12
6327845	6328091	6324410	11,100	.4370	—	—	1,9	45	12
6327846	6328092	6324491	11,113	.4375	7/16	—	1,9	45	12
6327847	6328093	6324492	11,200	.4409	—	—	1,9	45	12
6327848	6328094	6324493	11,300	.4449	—	—	1,9	45	12
6327849	6328095	6324494	11,400	.4488	—	—	2,0	45	12
6327850	6328096	6324495	11,500	.4528	—	—	2,0	45	12
6327851	6328097	6324496	11,509	.4531	—	—	2,0	45	12
6327852	6328098	6324497	11,600	.4567	—	—	2,0	45	12
6327853	6328099	6324498	11,700	.4606	—	—	2,0	45	12
6327854	6328100	6324499	11,800	.4646	—	—	2,0	45	12
6327855	6328111	6324500	11,900	.4685	—	—	2,0	45	12
6327856	6328112	6324501	11,908	.4688	—	—	2,0	45	12
6327857	6328113	6324502	12,000	.4724	—	—	2,1	45	12
6327858	6328114	6324503	12,100	.4764	—	—	2,1	45	14

(continued)

TOP DRILL S™

TOP DRILL S with Through Coolant • Stainless Steel

(TDS451A • 3 x D / TDS452A • 5 x D / TDS453A • 8 x D — continued)

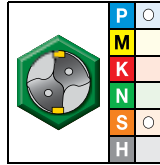
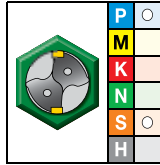
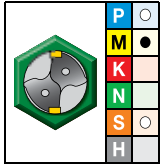

● first choice
○ alternate choice

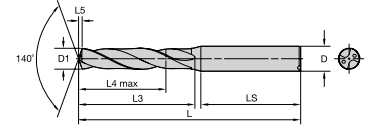

For information on L, L3, and L4 max, see the Dimension Table on page 79.

3 x D grade WM15PD AITiN	5 x D grade WM15PD AITiN	8 x D grade WM15PD AITiN	D1 diameter				L5	LS	D
			mm	in	fraction	wire size			
6327859	6328115	6324504	12,200	.4803	—	—	2,1	45	14
6327860	6328116	6324505	12,300	.4843	—	—	2,1	45	14
6327861	6328117	6345124	12,304	.4844	31/64	—	2,1	45	14
6327862	6328118	6345125	12,400	.4882	—	—	2,1	45	14
6327863	6328119	6345126	12,500	.4921	—	—	2,2	45	14
6327864	6328120	6345127	12,600	.4961	—	—	2,2	45	14
6327865	6328121	6345128	12,700	.5000	1/2	—	2,2	45	14
6327866	6328122	6345129	12,800	.5039	—	—	2,2	45	14
6327867	6328123	6345130	12,900	.5079	—	—	2,2	45	14
6327868	6328124	6345271	13,000	.5118	—	—	2,2	45	14
6327869	6328125	6345272	13,096	.5156	33/64	—	2,3	45	14
6327870	6328126	6345274	13,100	.5157	—	—	2,3	45	14
6327881	6328127	6345275	13,200	.5197	—	—	2,3	45	14
6327882	6328128	6345276	13,300	.5236	—	—	2,3	45	14
6327883	6328129	6345277	13,400	.5276	—	—	2,3	45	14
6327884	6328130	6345278	13,500	.5315	—	—	2,3	45	14
6327885	6328141	6345279	13,600	.5354	—	—	2,3	45	14
6327886	6328142	6345280	13,700	.5394	—	—	2,4	45	14
6327887	6328143	6345291	13,800	.5433	—	—	2,4	45	14
6327888	6328144	6345292	13,891	.5469	—	—	2,4	45	14
6327889	6328145	6345293	13,900	.5472	—	—	2,4	45	14
6327890	6328146	6345294	14,000	.5512	—	—	2,4	45	14
6327891	6328147	6345295	14,100	.5551	—	—	2,4	48	16
6327892	6328148	6345296	14,200	.5591	—	—	2,5	48	16
6327893	6328149	6345297	14,288	.5625	9/16	—	2,5	48	16
6327894	6328150	6345298	14,300	.5630	—	—	2,5	48	16
6327895	6328151	6345299	14,400	.5669	—	—	2,5	48	16
6327896	6328152	6345300	14,500	.5709	—	—	2,5	48	16
6327897	6328153	6345311	14,600	.5748	—	—	2,5	48	16
6327898	6328154	6345312	14,684	.5781	—	—	2,5	48	16
6327899	6328155	6345313	14,700	.5787	—	—	2,5	48	16
6327900	6328156	6345314	14,800	.5827	—	—	2,6	48	16
6327901	6328157	6345315	14,900	.5866	—	—	2,6	48	16
6327902	6328158	6345316	15,000	.5906	—	—	2,6	48	16
6327903	6328159	6345317	15,083	.5938	—	—	2,6	48	16
6327904	6328160	6345318	15,100	.5945	—	—	2,6	48	16
6327905	6328161	6345319	15,200	.5984	—	—	2,6	48	16
6327906	6328162	6345320	15,300	.6024	—	—	2,6	48	16
6327907	6328163	6345321	15,400	.6063	—	—	2,7	48	16
6327908	6328164	6345322	15,479	.6094	39/64	—	2,7	48	16
6327909	6328165	6345323	15,500	.6102	—	—	2,7	48	16
6327910	6328166	6345324	15,600	.6142	—	—	2,7	48	16
6327911	6328167	6345325	15,700	.6181	—	—	2,7	48	16
6327912	6328168	6345326	15,800	.6220	—	—	2,7	48	16

(continued)

TOP DRILL S™ with Through Coolant • Stainless Steel

(TDS451A • 3 x D / TDS452A • 5 x D / TDS453A • 8 x D — continued)

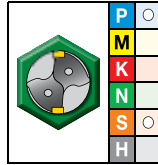
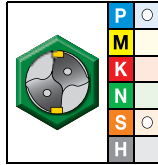
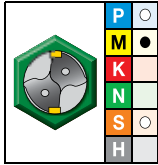

● first choice
○ alternate choice

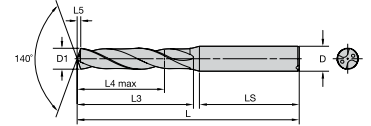

For information on L, L3, and L4 max, see the Dimension Table on page 79.

3 x D grade WM15PD AITiN	5 x D grade WM15PD AITiN	8 x D grade WM15PD AITiN	D1 diameter				L5	LS	D
			mm	in	fraction	wire size			
6327913	6328169	6345327	15,875	.6250	5/8	—	2,8	48	16
6327914	6328170	6345328	15,900	.6260	—	—	2,8	48	16
6327915	6328171	6345329	16,000	.6299	—	—	2,8	48	16
6327916	6328172	6345330	16,100	.6339	—	—	2,8	48	18
6327917	6328173	6345331	16,200	.6378	—	—	2,8	48	18
6327918	6328174	6345332	16,271	.6406	41/64	—	2,8	48	18
6327919	6328175	6345333	16,300	.6417	—	—	2,8	48	18
6327920	6328176	6345334	16,400	.6457	—	—	2,8	48	18
6327921	6328177	6345335	16,500	.6496	—	—	2,9	48	18
6327922	6328178	6345336	16,600	.6535	—	—	2,9	48	18
6327923	6328179	6345337	16,670	.6563	21/32	—	2,9	48	18
6327924	6328180	6345338	16,700	.6575	—	—	2,9	48	18
6327925	6328181	6345339	16,800	.6614	—	—	2,9	48	18
6327926	6328182	6345340	16,900	.6654	—	—	2,9	48	18
6327927	6328183	6345341	17,000	.6693	—	—	3,0	48	18
6327928	6328184	6345342	17,100	.6732	—	—	3,0	48	18
6327929	6328185	6345343	17,200	.6772	—	—	3,0	48	18
6327930	6328186	6345345	17,300	.6811	—	—	3,0	48	18
6327941	6328187	6345346	17,400	.6850	—	—	3,0	48	18
6327942	6328188	6345347	17,463	.6875	11/16	—	3,0	48	18
6327943	6328189	6345348	17,500	.6890	—	—	3,0	48	18
6327944	6328190	6345349	17,600	.6929	—	—	3,1	48	18
6327945	6328191	6345350	17,700	.6969	—	—	3,1	48	18
6327946	6328192	6345351	17,800	.7008	—	—	3,1	48	18
6327947	6328193	6345352	17,859	.7031	—	—	3,1	48	18
6327949	6328194	6345353	17,900	.7047	—	—	3,1	48	18
6327951	6328195	6345354	18,000	.7087	—	—	3,1	48	18
6327953	6328196	6345355	18,100	.7126	—	—	3,1	50	20
6327955	6328198	6345356	18,200	.7165	—	—	3,2	50	20
6327957	6328199	6345357	18,258	.7188	—	—	3,2	50	20
6327959	6328201	6345358	18,300	.7205	—	—	3,2	50	20
6327961	6328203	6345359	18,400	.7244	—	—	3,2	50	20
6327963	6328205	6345360	18,500	.7283	—	—	3,2	50	20
6327965	6328207	6345361	18,600	.7323	—	—	3,2	50	20
6327967	6328210	6345362	18,654	.7344	47/64	—	3,2	50	20
6327969	6328212	6345363	18,700	.7362	—	—	3,3	50	20
6327971	6328214	6345364	18,800	.7402	—	—	3,3	50	20
6327973	6328215	6345365	18,900	.7441	—	—	3,3	50	20
6327975	6328217	6345366	19,000	.7480	—	—	3,3	50	20
6327977	6328220	6345367	19,050	.7500	3/4	—	3,3	50	20
6327979	6328222	6345368	19,100	.7520	—	—	3,3	50	20
6327981	6328224	6345369	19,200	.7559	—	—	3,3	50	20
6327983	6328226	6345370	19,300	.7598	—	—	3,4	50	20
6327985	6328228	6345371	19,400	.7638	—	—	3,4	50	20

(continued)

TOP DRILL S™

TOP DRILL S with Through Coolant • Stainless Steel

(TDS451A • 3 x D / TDS452A • 5 x D / TDS453A • 8 x D — continued)

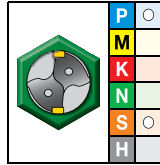
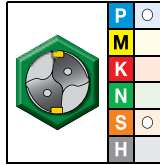
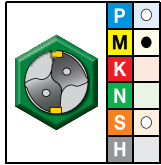

● first choice
○ alternate choice

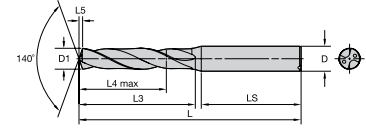

For information on L, L3, and L4 max, see the Dimension Table on page 79.

3 x D grade WM15PD AlTiN	5 x D grade WM15PD AlTiN	8 x D grade WM15PD AlTiN	D1 diameter				L5	LS	D
			mm	in	fraction	wire size			
order # 6327987	order # 6328230	order # 6345372	19,500	.7677	—	—	3,4	50	20
6327989	6328232	6345373	19,600	.7717	—	—	3,4	50	20
6327991	6328234	6345374	19,700	.7756	—	—	3,4	50	20
6327993	6328236	6345375	19,800	.7795	—	—	3,4	50	20
6327995	6328238	6345376	19,900	.7835	—	—	3,5	50	20
6327997	6328240	6345377	20,000	.7874	—	—	3,5	50	20

nominal size range	tolerance	
	D1 tolerance m7	D tolerance h6
>3-6	0,004/0,016	0,000/-0,008
>6-10	0,006/0,021	0,000/-0,009
>10-18	0,007/0,025	0,000/-0,011
>18-25,4	0,008/0,029	0,000/-0,013

TOP DRILL S™ with Through Coolant • Stainless Steel

■ Dimensions for TDS451A • 3 x D/TDS452A • 5 x D/TDS453A • 8 x D • Metric

mm ∅				SHORT* ~3 x D			LONG* ~5 x D			EXTRA LONG** ~8 x D		
D1 min	D1 max	D	LS	L	L3	L4 max	L	L3	L4 max	L	L3	L4 max
3,000	3,734	6	36	62	20	14	66	28	23	78	40	33
3,800	4,700	6	36	66	24	17	74	36	29	87	49	41
4,763	6,000	6	36	66	28	20	82	44	35	94	56	48
6,100	7,000	8	36	79	34	24	91	53	43	105	67	57
7,100	8,000	8	36	79	41	29	91	53	43	113	74	64
8,100	10,000	10	40	89	47	35	103	61	49	135	92	80
10,100	12,000	12	45	102	55	40	118	71	56	158	110	96
12,100	14,000	14	45	107	60	43	124	77	60	176	128	112
14,100	16,000	16	48	115	65	45	133	83	63	197	146	128
16,100	18,000	18	48	123	73	51	143	93	71	214	163	144
18,100	20,000	20	50	131	79	55	153	101	77	234	181	160

* D1 < 20mm to DIN 6537K

* D1 > 20mm to factory standard

** to factory standard

■ Dimensions for TDS451A • 3 x D/TDS452A • 5 x D/TDS453A • 8 x D • Inch



in ∅				SHORT* ~3 x D			LONG* ~5 x D			EXTRA LONG** ~8 x D		
D1 min	D1 max	D	LS	L	L3	L4 max	L	L3	L4 max	L	L3	L4 max
.1181	.1470	.2362	1.42	2.44	.79	.55	2.60	1.10	.91	3.07	1.57	1.30
.1496	.1850	.2362	1.42	2.60	.94	.67	2.91	1.42	1.14	3.43	1.93	1.61
.1875	.2362	.2362	1.42	2.60	1.10	.79	3.23	1.73	1.38	3.70	2.20	1.89
.2402	.2756	.3150	1.42	3.11	1.34	.94	3.58	2.09	1.69	4.13	2.64	2.24
.2795	.3150	.3150	1.42	3.11	1.61	1.14	3.58	2.09	1.69	4.45	2.91	2.52
.3189	.3937	.3937	1.57	3.50	1.85	1.38	4.06	2.40	1.93	5.32	3.62	3.15
.3976	.4724	.4724	1.77	4.02	2.17	1.57	4.65	2.80	2.20	6.22	4.33	3.78
.4764	.5512	.5512	1.77	4.21	2.36	1.69	4.88	3.03	2.36	6.93	5.04	4.41
.5551	.6299	.6299	1.89	4.53	2.56	1.77	5.24	3.27	2.48	7.76	5.75	5.04
.6339	.7087	.7087	1.89	4.84	2.87	2.01	5.63	3.66	2.80	8.43	6.42	5.67
.7126	.7874	.7874	1.97	5.16	3.11	2.17	6.02	3.98	3.03	9.21	7.13	6.30

* D1 < 20mm to DIN 6537K

* D1 > 20mm to factory standard













** to factory standard

■ TDS451/TDS452/TDS453 Series • WM15PD • Through Coolant • Inch





Material Group														
		Cutting Speed – vc Range – SFM			Recommended Feed Rate (f) by Diameter									
		min	-	max	Tool Diameter (inch)	.125–1/8	.188–3/16	.250 –1/4	.313–5/16	.375–3/8	.500–1/2	.625–5/8	.750–3/4	
P	0	260	-	520	IPR	.002–.004	.003–.005	.004–.007	.004–.009	.005–.010	.006–.012	.007–.014	.009–.018	
	1	230	-	460	IPR	.002–.005	.003–.007	.004–.009	.006–.012	.006–.014	.007–.015	.008–.018	.009–.020	
	2	300	-	460	IPR	.002–.005	.003–.007	.004–.008	.006–.009	.006–.011	.007–.013	.008–.015	.009–.016	
	3	200	-	330	IPR	.003–.005	.005–.007	.006–.009	.007–.012	.008–.014	.009–.015	.010–.018	.011–.020	
	4	160	-	330	IPR	.003–.005	.004–.007	.005–.009	.006–.011	.007–.013	.007–.015	.009–.017	.010–.019	
	5	160	-	260	IPR	.001–.004	.002–.004	.002–.004	.002–.006	.003–.007	.004–.008	.006–.009	.006–.010	
M	6	130	-	230	IPR	.002–.004	.003–.006	.004–.007	.005–.008	.006–.009	.007–.011	.007–.013	.009–.014	
	1	160	-	300	IPR	.002–.005	.002–.006	.003–.006	.004–.007	.005–.008	.005–.008	.006–.009	.007–.010	
	2	160	-	260	IPR	.002–.005	.002–.006	.003–.006	.004–.007	.005–.008	.005–.008	.006–.009	.007–.010	
S	3	160	-	230	IPR	.002–.005	.002–.006	.003–.006	.004–.007	.005–.008	.005–.008	.006–.009	.007–.010	
	1	70	-	100	IPR	.001–.002	.002–.003	.002–.004	.003–.005	.004–.005	.004–.006	.005–.006	.006–.007	
	2	30	-	100	IPR	.001–.002	.001–.002	.002–.003	.003–.004	.003–.004	.004–.005	.004–.006	.004–.006	
	3	30	-	130	IPR	.001–.002	.001–.002	.002–.003	.002–.004	.003–.004	.003–.004	.004–.005	.004–.006	
	4	30	-	130	IPR	.001–.002	.001–.002	.002–.003	.003–.004	.003–.004	.004–.005	.004–.006	.004–.006	

Informational Icons Guide











Indexable Milling Icons

 Face Milling	 Helical Milling	 Ramping	 Slotting: Square End	 Side Milling/ Shoulder Milling: Square End
 3D Profiling	 Pocketing	 Cylindrical/Plain Shank	 Weldon® Shank	 Screw-On Shank
 Shell Mill	 Through Coolant			

Solid End Milling Icons

 Plunge Milling	 Ramping: Blank	 Ramping: 3°	 Slotting: Ball Nose	 Slotting: Ball Nose with AP Dimension
 Slotting: Square End	 Slotting: Square End with AP Dimension	 Trochoidal Milling	 Side Milling/ Shoulder Milling: Ball Nose	 Side Milling/ Shoulder Milling: Ball Nose with AP/ AP Dimension
 Side Milling/ Shoulder Milling: Square End	 Side Milling/ Shoulder Milling: Square End with AE/AP Dimension	 Chamfer Milling	 Side/Shoulder Milling: Radius	 3D Profiling
 Corner Style: Ball Nose	 Corner Style: Corner Chamfer	 Corner Style: Corner Radius	 Corner Style: Square End	 Cylindrical/Plain Shank
 Shank: Duo-Lock™ Coupling	 Helix Angle: 0°	 Helix Angle: 20°	 Helix Angle: 30°	 Helix Angle: 38°
 Helix Angle: 45°	 Tool Dimensions: Flute Configuration: X (Variable)	 Tool Dimensions: Flute Configuration: 2	 Tool Dimensions: Flute Configuration: 3	 Tool Dimensions: Flute Configuration: 4
 Tool Dimensions: Flute Configuration: 5	 Tool Dimensions: Flute Configuration: 6	 Tool Dimensions: Flute Configuration: 7		

Holemaking Icons

 Drilling	 Drilling: Inclined Entry	 Drilling: Inclined Exit	 Drilling: Stacked Plates	 Drilling Depth: 3x
 Drilling Depth: 5x	 Drilling Depth: 8x	 Shank: Cylindrical Plain ≤h6	 Helix Angle: 30°	 Through Coolant: Radial: Drilling
 Tool Dimensions: 2-Flute/2-Margin/ Coolant				

DIN – German Institute for Standardization
ISO – International Standardization Organization

Customer Application Support (CAS)

Get fast and reliable answers to your toughest metalcutting problems.

Our Customer Application Support (CAS) Team is the metalworking industry's leading help desk resource for tooling application solutions and problem resolution.

- Easy access to proven metalworking expertise.
- Service level excellence.
- Best-in-class application support tools and technology.

Easy access to proven metalworking expertise!

WIDIA™ Customer Application Engineers assist customers and engineering groups throughout the world with expert tool selection and application recommendations for the entire range of WIDIA tooling.

Service Level Excellence:

- Fast telephone response.
- Quick technical solutions.
- Efficient case management.

Services Provided:

- Tooling selection.
- Operating parameters.
- Troubleshooting.
- Process optimization.
- Hardware support.

Best-in-Class Support Tools and Technology:

- Tooling performance experts.
- Materials database.
- Application calculators.

ORIGINATING COUNTRY	LANGUAGE	TEL	FAX	EMAIL
Australia	English	001-724-539-6921 *	001-724-539-6830 *	ap.techsupport@widia.com
Austria	German	0800 291630	0049-911-9735-429 *	eu.techsupport@widia.com
Belgium	English/French	0800 80410	0049-911-9735-429 *	eu.techsupport@widia.com
China	Chinese	400-889-2237	+86-21-58999985 *	w-cn.techsupport@widia.com
Denmark	English	808 89295	001-724-539-6830 *	na.techsupport@widia.com
Finland	English	0800 919413	001-724-539-6830 *	na.techsupport@widia.com
France	French	080 5540 379	0049-911-9735-429 *	eu.techsupport@widia.com
Germany	German	0800 1015774	0911-9735-429*	eu.techsupport@widia.com
India	English	1 800 103 5227	—	in.techsupport@widia.com
Israel	English	1809 449907	001-724-539-6830 *	na.techsupport@widia.com
Italy	Italian	800 916568	02 89512146 *	eu.techsupport@widia.com
Japan	English	001-724539-6921 *	001-724-539-6830 *	ap.techsupport@widia.com
Korea (South)	English	001-724539-6921 *	001-724-539-6830 *	ap.techsupport@widia.com
Malaysia	English	001-724539-6921 *	001-724-539-6830 *	ap.techsupport@widia.com
Netherlands	English	0800 0201131	001-724-539-6830 *	na.techsupport@widia.com
New Zealand	English	001-724539-6921 *	001-724-539-6830 *	ap.techsupport@widia.com
Norway	English	800 10081	001-724-539-6830 *	na.techsupport@widia.com
Poland	Polish	00800 4411943	06166 56504 *	eu.techsupport@widia.com
Russia (landline)	Russian	8800 5556395	0048 6166 56504 *	eu.techsupport@widia.com
Russia (cell phone)	Russian	+7 8005556395	0048 6166 56504 *	eu.techsupport@widia.com
Singapore	English	001-724539-6921 *	001-724-539-6830 *	ap.techsupport@widia.com
South Africa	English	0800 981644	001-724-539-6830 *	na.techsupport@widia.com
Sweden	English	020798794	001-724-539-6830 *	na.techsupport@widia.com
Taiwan	English	001-724539-6921 *	001-724-539-6830 *	ap.techsupport@widia.com
Thailand	English	001-724539-6921 *	001-724-539-6830 *	ap.techsupport@widia.com
United Kingdom	English	0800 028 2996	001-724-539-6830 *	na.techsupport@widia.com
Ukraine	Russian	800502665	0048 6166 56504 *	eu.techsupport@widia.com
USA	English	888 539 5145	001-724-539-6830 *	na.techsupport@widia.com

*Noted phone and fax numbers are not toll free.

Material Overview • ANSI

ANSI

P Steel	K Cast Iron	S High-Temp Alloys
M Stainless Steel	N Non-Ferrous	H Hardened Materials

material group	description	content	tensile strength RM (MPa)*	hardness (HB)	hardness (HRC)	material number
P0	Low-Carbon Steels, Long Chipping	C <0,25%	<530	<125	–	A36, 1008, 1010, 1018 through 1029; 1108, 1117
P1	Low-Carbon Steels, Short Chipping, Free Machining	C <0,25%	<530	<125	–	10L18, 1200 Series, 1213, 12L14
P2	Medium- and High-Carbon Steels	C >0,25%	>530	<220	<25	1035, 1045, 10L45, 1050, 10L50, 1080, 1137, 1144, 11L44, 1525, 1545, 1572
P3	Alloy Steels and Tool Steels	C >0,25%	600–850	<330	<35	1300, 2000, 3000, 4000, 5000, 8000, P20, SAE: A, D, H, O, S, M, T
P4	Alloy Steels and Tool Steels	C >0,25%	850–1400	340–450	35–48	1300, 2000, 3000, 4000, 5000, 8000, P20, SAE: A, D, H, O, S, M, T
P5	Ferritic, Martensitic, and PH Stainless Steels	–	600–900	<330	<35	15–5 PH, 13–8 PH, 17–4 PH, 400 and 500 Series
P6	High-Strength Ferritic, Martensitic, and PH Stainless Steels	–	900–1350	350–450	35–48	15–5 PH, 13–8 PH, 17–4 PH, 400 and 500 Series
M1	Austenitic Stainless Steel	–	<600	130–200	–	200 Series, 301, 302, 304, 304L, 309
M2	High-Strength Austenitic Stainless and Cast Stainless Steels	–	600–800	150–230	<25	310, 316, 316L, 321, 347, 384 ASTM Cast XM-1, XM-5, XM-7, XM-21
M3	Duplex Stainless Steel	–	<800	135–275	<30	323, 329, F55, 2205, S329000
K1	Gray Cast Iron	–	125–500	120–290	<32	class 20, 25, 30, 35, 40, 45, 50, 55, 60, G1800, G3000, G3500, G4000
K2	Low- and Medium-Strength Ductile Irons (Nodular Irons) and Compacted Graphite Irons (CGI)	–	<600	130–260	<28	60-40-18, 65-45-12, 80-55-06, SAE J434:D4018, D4512, D5506, ASTM A47: Grade 32510, 35018, SAE J158: Grade M3210, M4504, M5003, M5503, M7002, ASTMA842: Grade 250, 300, 350, 400, 450
K3	High-Strength Ductile Irons and Austempered Ductile Iron (ADI)	–	>600	180–350	<43	ASTM A536:100-70-03, 120-90-02, SAE J434: D7003, SAE J158: Grade M8501AST A897: 125-80-10, 150-100-7, 175-125-4, 200-150-1, 230-185
N1	Wrought Aluminum	–	–	–	–	2025, 5050, 7050, 1000, 2017
N2	Low-Silicon Aluminum Alloys and Magnesium Alloys	Si <12,2%	–	–	–	2024, 6061, 7075
N3	High-Silicon Aluminum Alloys and Magnesium Alloys	Si >12,2%	–	–	–	–
N4	Copper-, Brass-, Zinc-Based on Machinability Index Range of 70–100	–	–	–	–	C81500
N5	Nylon, Plastics, Rubbers, Phenolics, Resins, Fiberglass	–	–	–	–	–
N6	Carbon, Graphite Composites, CFRP	–	–	–	–	Graphite, CFK, CFRP
N7	Metal Matrix Composites (MMC)	–	–	–	–	C63000
S1	Iron-Based, Heat-Resistant Alloys	–	500–1200	160–260	25–48	A-286, INCOLOY® 800 Series, A608, A567, Discaloy™, INVAR®, N-155, 16-25-6, 19-9 DL; Cast: ASTM A-297, A-351, A-567, A-608
S2	Cobalt-Based, Heat-Resistant Alloys	–	1000–1450	250–450	25–48	Haynes® 25 (L605), Haynes 188, J-1570, Stellite®, AiResist 213; Cast: AiResist 13, Haynes 21, MAR-M302, MAR-M509, NASA Co-W-Re, WI-52
S3	Nickel-Based, Heat-Resistant Alloys	–	600–1700	160–450	<48	Astrolloy™, Hastelloy® B/C/ C-276 /X, INCONEL® 600 and 700 Series, IN102, INCOLOY 900 Series, Rene 41, Waspalloy®, Monel®, K-500, MAR-M20, NIMONIC®, UDIMET®
S4	Titanium and Titanium Alloys	–	900–1600	300–400	33–48	Pure: Ti 98.8, Ti 98.9, Ti 99.9; Alloyed: Ti 5Al-2.5Sn, Ti6Al-4V, Ti6Al-2Sn-4Zr-2Mo, Ti-3Al-8V-6Cr-4Mo-4Zr, Ti-10V-2Fe-3Al, Ti-13V-11Cr-3Al
H1	Hardened Materials	–	–	–	44–48	Tool Steel H10, H11, H13, D2, D3, 4340, P20
H2	Hardened Materials	–	–	–	48–55	Tool Steel H10, H11, H13, D2, D3, 4340, P20
H3	Hardened Materials	–	–	–	56–60	Tool Steel H10, H11, H13, D2, D3, 4340, P20
H4	Hardened Materials	–	–	–	>60	Tool Steel H10, H11, H13, D2, D3, 4340, P20

Material Overview • DIN

DIN

P Steel	K Cast Iron	S High-Temp Alloys
M Stainless Steel	N Non-Ferrous	H Hardened Materials

material group	description	content	tensile strength RM (MPa)*	hardness (HB)	hardness (HRC)	material number
P0	Low-Carbon Steels, Long Chipping	C <0,25%	<530	<125	–	–
P1	Low-Carbon Steels, Short Chipping, Free Machining	C <0,25%	<530	<125	–	C15, Ck22, ST37-2, S235JR, 9SMnPb28, GS38
P2	Medium- and High-Carbon Steels	C >0,25%	>530	<220	<25	ST52, S355JR, C35, GS60, Cf53
P3	Alloy Steels and Tool Steels	C >0,25%	600–850	<330	<35	16MnCr5, Ck45, 21CrMoV5-7, 38SMn28
P4	Alloy Steels and Tool Steels	C >0,25%	850–1400	340–450	35–48	100Cr6, 30CrNiMo8, 42CrMo4, C70W2, S6525, X120Mn12
P5	Ferritic, Martensitic, and PH Stainless Steels	–	600–900	<330	<35	100Cr6, 30CrNiMo8, 42CrMo4, C70W2, S6525, X120Mn12
P6	High-Strength Ferritic, Martensitic, and PH Stainless Steels	–	900–1350	350–450	35–48	X102CrMo17, G-X120Cr29
M1	Austenitic Stainless Steel	–	<600	130–200	–	X5CrNi 18 10, X2CrNiMo 17 13 2, G-X25CrNiSi18 9, X15CrNiSi 20 12
M2	High-Strength Austenitic Stainless and Cast Stainless Steels	–	600–800	150–230	<25	X2CrNiMo 13 4, X5NiCr 32 21, X5CrNiNb 18 10, G-X15CrNi 25-20
M3	Duplex Stainless Steel	–	<800	135–275	<30	X8CrNiMo27 5, X2CrNiMoN22 5 3, X20CrNiSi25 4, G-X40CrNiSi27 4
K1	Gray Cast Iron	–	125–500	120–290	<32	GG15, GG25, GG30, GG40, GTW40
K2	Low- and Medium-Strength Ductile Irons (Nodular Irons) and Compacted Graphite Irons (CGI)	–	<600	130–260	<28	GGG40, GTS35
K3	High-Strength Ductile Irons and Austempered Ductile Iron (ADI)	–	>600	180–350	<43	GGG60, GTW55, GTS65
N1	Wrought Aluminum	–	–	–	–	AlMg1, Al99.5, AlCuMg1, AlCuBiPb, AlMgSi1, AlMgSiPb
N2	Low-Silicon Aluminum Alloys and Magnesium Alloys	Si <12,2%	–	–	–	GAISiCu4, GDAISi10Mg
N3	High-Silicon Aluminum Alloys and Magnesium Alloys	Si >12,2%	–	–	–	G-ALSi12, G-AISi17Cu4, G-AISi21CuNiMg
N4	Copper-, Brass-, Zinc-Based on Machinability Index Range of 70–100	–	–	–	–	CuZn40, Ms60, G-CuSn5ZnPb, CuZn37, CuSi3Mn
N5	Nylon, Plastics, Rubbers, Phenolics, Resins, Fiberglass	–	–	–	–	Lexan®, Hostalen™, Polystyrol, Makralon®
N6	Carbon, Graphite Composites, CFRP	–	–	–	–	CFK, GFK
N7	Metal Matrix Composites (MMC)	–	–	–	–	–
S1	Iron-Based, Heat-Resistant Alloys	–	500–1200	160–260	25–48	X1NiCrMoCu32 28 7, X12NiCrSi36 16, X5NiCrAlTi31 20, X40CoCrNi20 20
S2	Cobalt-Based, Heat-Resistant Alloys	–	1000–1450	250–450	25–48	Haynes® 188, Stellite® 6,21,31
S3	Nickel-Based, Heat-Resistant Alloys	–	600–1700	160–450	<48	INCONEL® 690, INCONEL 625, Hastelloy®, Nimonic® 75
S4	Titanium and Titanium Alloys	–	900–1600	300–400	33–48	Ti1, TiAl5Sn2, TiAl6V4, TiAl4Mo4Sn2
H1	Hardened Materials	–	–	–	44–48	GX260NiCr42, GX330NiCr42, GX300CrNiSi952, GX300CrMo153, Hardox® 400
H2	Hardened Materials	–	–	–	48–55	–
H3	Hardened Materials	–	–	–	56–60	–
H4	Hardened Materials	–	–	–	>60	–

NOVO KNOWS SEARCH

Searching for a tool has been enhanced by Advise and Select functions from NOVO™ applications — saving you time and money.

ADVISE

Uses a rules-based approach to provide cutting tool recommendations:

- Define Machining Feature (face milling, slotting, blind hole, etc.)
- Apply Constraint Requirements (geometric, material, tolerance, etc.)
- Set Machining Sequence (single or multi-step operations, rough then finish, etc.)
- Receive Ranked Results

SELECT

A method of selecting cutting tools from a tree structure via a hierarchy or parametric search:

- If you know which product you are looking for, a quick search can be performed by just the catalog number or product description.
- Smart filters significantly reduce the amount of potential tooling solutions.
- After the tool is selected, NOVO also provides cutting and adaptive item options that fit with your solution.

NOVO applications can ensure you have the right tools on your machines, in the right sequence. Resulting in flawless execution that accelerates every job, and maximizes every shift. widia.com/novo

Find your Local WIDIA Authorized Distributor

WIDIA™ brand cutting tools are available exclusively through a specialized network of Authorized Distributor partners whom you can count on to deliver much more than products. Our distributors know us, and more importantly, they know you. They know better than anyone in the industry how to put the global power of WIDIA to work for you — in your industry, in your region, and for your business.

WIDIA distributor partners provide technical expertise that you can count on. They will show you how to:

- Significantly reduce cycle time.
- Improve machine tool utilization.
- Achieve measurable productivity improvements.
- Take advantage of proven supply chain solutions.
- Access local inventory and best-in-class technical support.
- Request onsite demonstrations of the latest tooling technology.

And with thousands of turning, milling, holemaking, tapping, and tooling systems products available from WIDIA, you'll find everything you need from one single source.



Find your Local WIDIA Authorized Distributor by accessing our distributor finder at widia.com.

IMPORTANT SAFETY INSTRUCTIONS: READ BEFORE USING THE TOOLS IN THIS CATALOG

METALCUTTING SAFETY

Projectile and Fragmentation Hazards

Modern metalcutting operations involve high spindle and cutter speeds and high temperatures and cutting forces. Hot metal chips may fly off the workpiece during metalcutting. Although cutting tools are designed and manufactured to withstand high cutting forces and temperatures, they can sometimes fragment, particularly if they are subjected to over-stress, severe impact, or other abuse.

To avoid injury:

- Always wear appropriate personal protective equipment, including safety goggles, when operating metalcutting machines or working nearby.
- Always make sure all machine guards are in place.

Breathing and Skin Contact Hazards

Grinding carbide or other advanced cutting tool materials produces dust or mist containing metallic particles. Breathing this dust or mist — especially over an extended period — can cause temporary or permanent lung disease or make existing medical conditions worse. Contact with this dust or mist can irritate eyes, skin, and mucous membranes and may make existing skin conditions worse.

To avoid injury:

- Always wear breathing protection and safety goggles when grinding.
- Provide ventilation control and collect and properly dispose of dust, mist, or sludge from grinding.
- Avoid skin contact with dust or mist.

For more information, read the applicable Material Safety Data Sheet provided by WIDIA and consult General Industry Safety and Health Regulations, Part 1910, Title 29 of the Code of Federal Regulations.

These safety instructions are general guidelines. Many variables affect machining operations. It is impossible to cover every specific situation. The technical information included in this catalog and recommendations on machining practices may not apply to your particular operation.

For more information, consult the WIDIA Metalcutting Safety booklet, available free from WIDIA at +1 724 539 5747 or fax +1 724 539 5439. For specific product safety and environmental questions, contact our Corporate Environmental Health and Safety Office at +1 724 539 5066 or fax +1 724 539 5372.

AluSurf, ArCut, ERICKSON, TOP DRILL S, VariDrill, VariMill, VariMill II, VariMill III, Victory, VSM11, VSM17, VSM490, VSM490-10, VSM490-15, WavCut, WIDIA, WIDIA-Hanita, and X-Feed are trademarks of Kennametal, Inc. and are used as such herein. The absence of a product, service name, or logo from this list does not constitute a waiver of the Kennametal trademark or other intellectual property rights concerning that name or logo.

DUO-LOCK® is a registered trademark and Duo-Lock™ is a trademark of Haimer GmbH.
Weldon® is a registered trademark of Weldon Tool Company.

©Copyright 2017 by Kennametal Inc., Latrobe, PA 15650. All rights reserved.

WIDIA

WORLD HEADQUARTERS
WIDIA Products Group
Kennametal Inc.
1600 Technology Way
Latrobe, PA 15650 USA
Tel: 1 800 979 4342
w-na.service@widia.com

EUROPEAN HEADQUARTERS
WIDIA Products Group
Kennametal Europe GmbH
Rheingoldstrasse 50
CH 8212 Neuhausen am Rheinfall
Switzerland
Tel: +41 52 6750 100
w-ch.service@widia.com

ASIA-PACIFIC HEADQUARTERS
WIDIA Products Group
Kennametal (Singapore) Pte. Ltd.
3A International Business Park
Unit #01-02/03/05, ICON@IBP
Singapore 609935
Tel: +65 6265 9222
w-sg.service@widia.com

INDIA HEADQUARTERS
WIDIA Products Group
Kennametal India Limited
CIN: L27109KA1964PLC001546
8/9th Mile, Tumkur Road
Bangalore - 560 073
Tel: +91 80 2839 4321
w-in.service@widia.com

INCH 2018

ADVANCES

WIDIA 

widia.com