

METRIC 2018

ADVANCES

Introducing New Products from WIDIA™

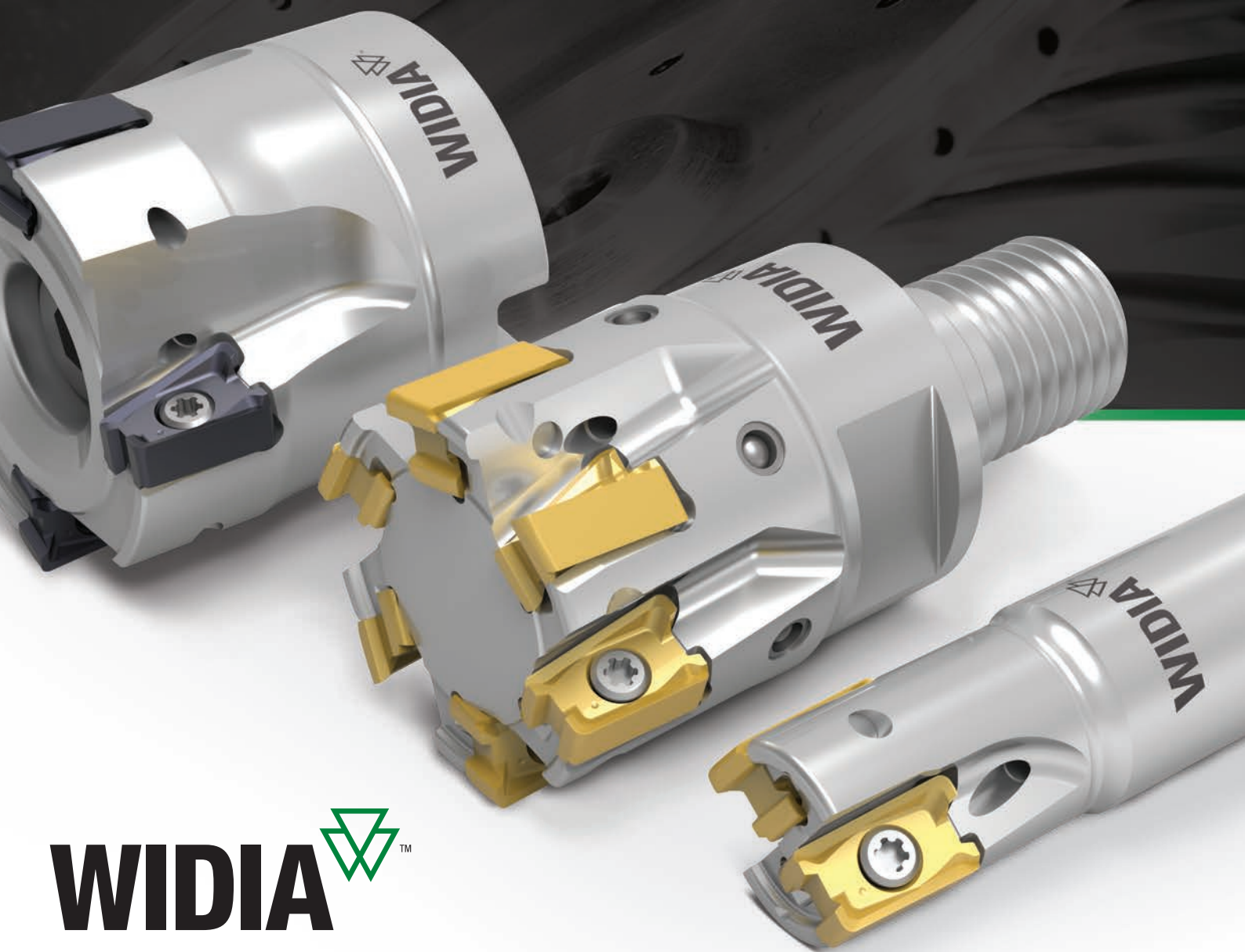

WIDIA 

Introducing...

NEW PRODUCTS



TOP DRILL S™ for
Stainless Steel Drilling
pages 68–77



Modular End Mills with
a Duo-Lock™ connection
pages 48–64



General Purpose End Mills
pages 66–67



widia.com

INDEXABLE MILLING 4-43

VSM490-10
VSM490-15
VSM11
VSM17
VHSC

SOLID END MILLING 48-67

VariMill Modular
GP

HOLEMAKING 68-77

TOP DRILL S

ORDERING INFORMATION 78-80

Icon Legend
Material Overview



VHSC Indexable Milling
Cutters for Aluminium
pages 36-43



VSM11™ Shoulder Mills
pages 18-26, 35



VSM17™ Shoulder Mills
pages 18, 28-35



VSM490™-10 Shoulder Mills
pages 4-11, 35



VSM490™-15 Shoulder Mills
pages 4, 12-16, 35



WIDIA 

AEROSPACE SOLUTIONS

Reduce Time, Increase Tool Life, and Relieve the Stress





WS40PM

Performance leader for advanced milling jobs in titanium, high-temp alloys, and stainless steels.

Page 27

VariMill II™ ER & VariMill III™ ER

Performance leader for advanced milling applications in exotic, aerospace materials.



FS and MS Chipbreaker

High-performance solutions for turning nickel-, cobalt-, and Fe-based materials, as well as difficult-to-machine stainless steel and cobalt-chrome materials.



VariDrill™

The advanced-point geometry design offers the ultimate solution for drilling high-temp alloys.



IBR – Titanium 6AL-4V		
	Current Parameters	WIDIA™
Cycle time	75 min	18 min
Tool Life: # of parts	3	11
Cost savings	–	\$270,000/year

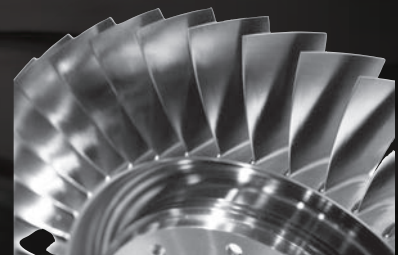

WIDIA 

widia.com

VSM49

The Ultimate Shoulder Milling Solution
for Step-Down Applications

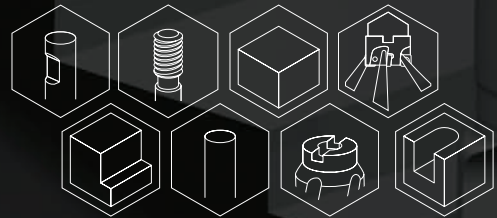

0™

NEW!



VSM490™ -10

- Ap Capabilities:** Up to 10mm
- Screw-On End Mills:** 16–32mm
- Weldon® End Mills:** 16–32mm
- Cylindrical End Mills:** 16–32mm
- Shell Mills:** 40–125mm
- Shell Mills JIS:** 80–125mm
- M4000 Cartridge Milling System:** 125–315mm

VSM490™ -15

- Ap Capabilities:** Up to 15mm
- Screw-On End Mills:** 25–35mm
- Weldon End Mills:** 25–40mm
- Cylindrical End Mills:** 25–32mm
- Shell Mills:** 40–160mm
- Shell Mills JIS:** 80–160mm
- M4000 Cartridge Milling System:** 125–315mm



4-Edged, Double-Sided 90° Victory™ Shoulder Mill (VSM)

Delivers high surface quality and productivity in shoulder milling applications, including multiple passes (step-down) applications.

Eliminates finishing operations in many applications.

Versatile: steel, cast iron, stainless steel, titanium, aluminium; from roughing to finishing applications.

Double-sided strong insert with 4 cutting edges; high positive geometry for lower cutting forces.

WIDIA 

widia.com

VSM490™ -10

4-Edged, Double-Sided 90° Victory™ Shoulder Mill



- True 90° roughing tool with embedded finishing capabilities all in one tool.
- Up to $A_{p1 \max} = 10\text{mm}$.
- Best-in-class wall finish in axial stepping-down jobs.
- Lower cutting forces and real soft cutting action.
- Perfect fit for taper 40 spindles and driven units.

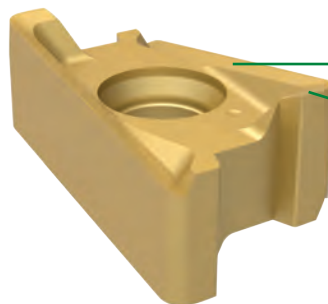

Super-positive rake design for low machine power consumption.

Integrated wiper facet for great surface floor finish.

Four insert geometries for all material groups in shoulder milling applications.

-ALP



N

For non-ferrous materials.

-ML



P M K S H

First choice for stainless steel, light machining, and finishing jobs.

-MM



P M K S H

First choice for general purpose in all material groups.

-MH



P K

First choice for HPC roughing cast iron. Strongest edge protection with additional margins.

Finishing Capabilities/Lower Cutting Forces

Geometry Strengthening

Applications

1. Face milling with modular M4000 cartridge milling system.
2. Full slotting with 100% radial engagement.
3. Shoulder milling with step-down capabilities and great wall finish.
4. Shoulder milling with low axial and high radial engagement.
5. Shoulder milling with low radial and high axial engagement.
6. HPC face milling. Excellent choice to clean up castings.
7. Trochoidal slot milling.
8. Z-axis plunge milling.
9. Contour milling.

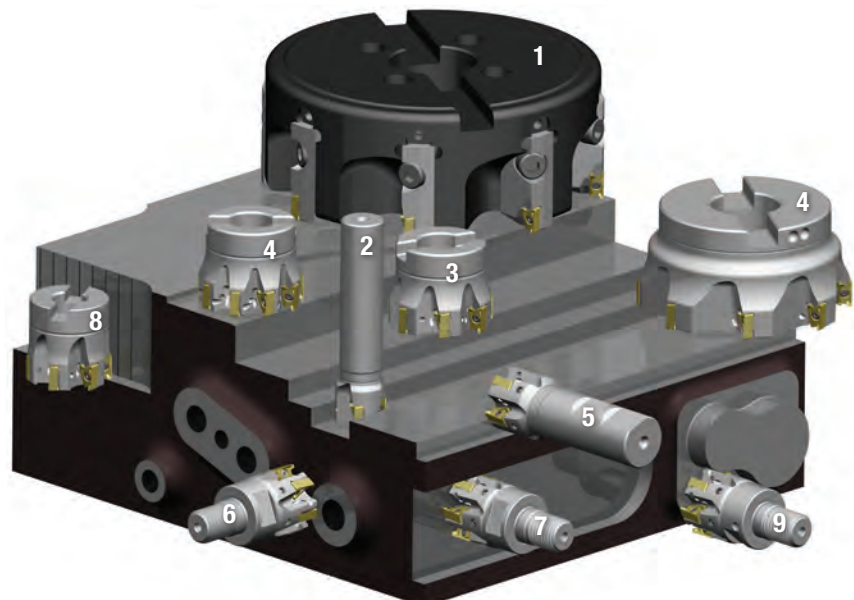

Victory™ Shoulder Mills • VSM490™-10 Series

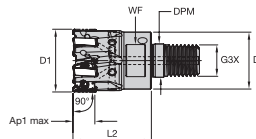

■ Screw-On End Mills

order number	catalogue number	D1	D	DPM	G3X	L2	WF	Ap1 max	Z	max RPM	coolant supply	kg
6425553	VSM490D016Z02M08XN10	16	13	8,5	M8	25	10	10,0	2	48000	Yes	0,03
6425554	VSM490D020Z03M10XN10	20	18	10,5	M10	28	15	10,0	3	40200	Yes	0,05
6425555	VSM490D025Z04M12XN10	25	21	12,5	M12	32	17	10,0	4	34300	Yes	0,09
6425556	VSM490D032Z05M16XN10	32	29	17,0	M16	40	24	10,0	5	29200	Yes	0,20
6425557	VSM490D032Z06M16XN10	32	29	17,0	M16	40	24	10,0	6	29200	Yes	0,20

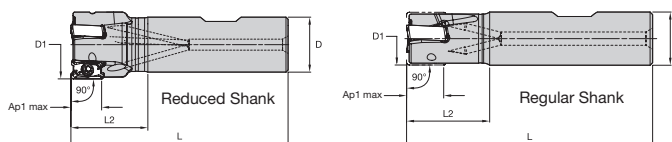

■ Weldon® End Mills

order number	catalogue number	D1	D	L	L2	Ap1 max	Z	max RPM	coolant supply	kg
6425558	VSM490D016Z02B16XN10	16	16	74	25	10,0	2	48000	Yes	0,09
6425559	VSM490D020Z02B20XN10	20	20	79	28	10,0	2	40200	Yes	0,16
6425560	VSM490D020Z03B20XN10	20	20	79	28	10,0	3	40200	Yes	0,16
6425571	VSM490D025Z03B20XN10	25	20	79	28	10,0	3	34300	Yes	0,18
6425572	VSM490D025Z03B25XN10	25	25	89	32	10,0	3	34300	Yes	0,29
6425573	VSM490D025Z04B25XN10	25	25	89	32	10,0	4	34300	Yes	0,29
6425574	VSM490D032Z04B25XN10	32	25	89	32	10,0	4	29200	Yes	0,29
6425575	VSM490D032Z05B25XN10	32	25	89	32	10,0	5	29200	Yes	0,33

NOTE: Weldon type not recommended for finishing operations.

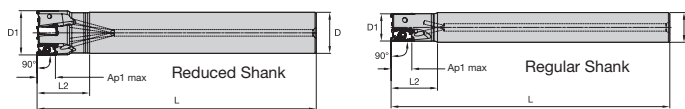

■ Cylindrical End Mills (Regular and Long Version)

order number	catalogue number	D1	D	L	L2	Ap1 max	Z	max RPM	coolant supply	kg
6425502	VSM490D016Z02A16XN10L090	16	16	90	25	10,0	2	48000	Yes	0,12
6425503	VSM490D016Z02A16XN10L150	16	16	150	25	10,0	2	48000	Yes	0,21
6425504	VSM490D018Z02A16XN10L150	18	16	150	25	10,0	2	43500	Yes	0,21
6425506	VSM490D020Z02A20XN10L150	20	20	150	28	10,0	2	40200	Yes	0,33
6425505	VSM490D020Z03A20XN10L090	20	20	90	28	10,0	3	40200	Yes	0,19
6425507	VSM490D020Z03A20XN10L150	20	20	150	28	10,0	3	40200	Yes	0,33
6425508	VSM490D022Z03A20XN10L150	22	20	150	28	10,0	3	37500	Yes	0,34
6425509	VSM490D025Z03A20XN10L100	25	20	100	28	10,0	3	34300	Yes	0,23
6425511	VSM490D025Z03A25XN10L170	25	25	170	43	10,0	3	34300	Yes	0,60
6425510	VSM490D025Z04A25XN10L100	25	25	100	43	10,0	4	34300	Yes	0,33
6425512	VSM490D025Z04A25XN10L170	25	25	170	43	10,0	4	34300	Yes	0,59
6425513	VSM490D028Z04A25XN10L170	28	25	170	32	10,0	4	31800	Yes	0,61
6425514	VSM490D032Z04A25XN10L110	32	25	110	32	10,0	4	29200	Yes	0,41
6425516	VSM490D032Z04A25XN10L200	32	25	200	32	10,0	4	29200	Yes	0,75
6425515	VSM490D032Z05A25XN10L110	32	25	110	32	10,0	5	29200	Yes	0,41
6425517	VSM490D032Z05A25XN10L200	32	25	200	32	10,0	5	29200	Yes	0,75

VSM490™ -10

Victory™ Shoulder Mills • VSM490-10 Series

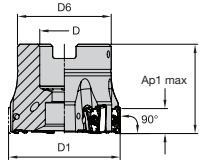

■ Shell Mills

order number	catalogue number	D1	D	D6	L	Ap1 max	Z	max RPM	coolant supply	kg
6425434	VSM490D040Z04S16XN10	40	16	37	40	10,0	4	25400	Yes	0,23
6425435	VSM490D040Z06S16XN10	40	16	37	40	10,0	6	25400	Yes	0,23
6425436	VSM490D040Z07S16XN10	40	16	37	40	10,0	7	25400	Yes	0,23
6425437	VSM490D050Z05S22XN10	50	22	42	40	10,0	5	22300	Yes	0,31
6425438	VSM490D050Z07S22XN10	50	22	42	40	10,0	7	22300	Yes	0,35
6425439	VSM490D050Z09S22XN10	50	22	42	40	10,0	9	22300	Yes	0,32
6425440	VSM490D063Z05S22XN10	63	22	49	40	10,0	5	19500	Yes	0,56
6425481	VSM490D063Z07S22XN10	63	22	49	40	10,0	7	19500	Yes	0,56
6425482	VSM490D063Z09S22XN10	63	22	49	40	10,0	9	19500	Yes	0,56
6425483	VSM490D080Z06S27XN10	80	27	60	50	10,0	6	17100	Yes	1,10
6425484	VSM490D080Z08S27XN10	80	27	60	50	10,0	8	17100	Yes	1,11
6425485	VSM490D080Z10S27XN10	80	27	60	50	10,0	10	17100	Yes	1,12
6425486	VSM490D100Z08S32XN10	100	32	80	50	10,0	8	15200	Yes	1,73
6425487	VSM490D100Z12S32XN10	100	32	80	50	10,0	12	15200	Yes	1,74
6425488	VSM490D125Z10S40XN10	125	40	90	63	10,0	10	13500	Yes	3,18
6425489	VSM490D125Z14S40XN10	125	40	90	63	10,0	14	13500	Yes	3,20

■ Shell Mills • Japanese Industry Standard (JIS)

order number	catalogue number	D1	D	D6	L	Ap1 max	Z	max RPM	coolant supply	kg
6425490	VSM490D080Z06S254XN10JIS	80	25,40	50	50	10,0	6	17100	Yes	0,93
6425491	VSM490D080Z08S254XN10JIS	80	25,40	50	50	10,0	8	17100	Yes	0,94
6425492	VSM490D100Z08S3175XN10JIS	100	31,75	60	50	10,0	8	15200	Yes	1,41
6425493	VSM490D125Z10S381XN10JIS	125	38,10	80	63	10,0	10	13500	Yes	3,02

■ Spare Parts

D1	insert screw	Nm	wrench
16 - 125	MS2263	1,5	DT91P

For M4000 cartridge milling system, please see page 35.



VSM490-10
M4000CA-XN10
(MM6433216)



Victory™ Shoulder Mills • VSM490™-10 Series

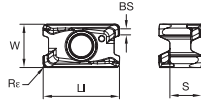

● first choice
○ alternate choice

P	■	■	■	○	●	●	○
M	■	■	■	○	●	●	○
K	■	■	■	○	○	○	○
N	■	■	■	○	○	○	○
S	■	■	■	○	○	○	○
H	■	■	■	○	○	○	○



VSM490-10 Series Inserts

catalogue number	cutting edges	LI	S	W	BS	Rε	hm	WK15CM	WK15PM	WN25PM	WP25PM	WP35CM	WP40PM	WS40PM	WU10PM
XNGU100404ERALP	4	11,66	4,83	6,60	1,37	0,40	0,02	■	■	6425382	■	■	■	■	■
XNGU100408ERALP	4	11,66	4,83	6,60	1,00	0,80	0,02	■	■	6425411	■	■	■	■	■
XNGU100404ERML	4	11,66	4,83	6,60	1,37	0,40	0,02	■	■	■	6425414	■	■	■	■
XNGU100408ERML	4	11,66	4,83	6,60	1,00	0,80	0,02	■	■	■	6425369	■	■	6425370	6425415
XNGU100404SRMM	4	11,66	4,83	6,60	1,37	0,40	0,08	■	■	■	6425416	■	■	6425417	■
XNGU100408SRMM	4	11,66	4,83	6,60	1,00	0,80	0,08	■	■	■	6425422	■	■	6425423	6425424
XNGU100408SRMH	4	11,66	4,83	6,60	0,90	0,80	0,08	6425359	■	■	6425356	6425360	6425357	■	■
XNPU100408ERML	4	11,60	4,83	6,60	0,90	0,80	0,02	■	6425366	6425367	■	■	6425368	■	■
XNPU100408SRMM	4	11,60	4,83	6,60	0,90	0,80	0,08	6425364	6425270	■	6425361	6425365	6425363	6425362	■
XNPU100412SRMM	4	11,61	4,83	6,60	0,50	1,20	0,08	6425355	■	■	6425352	6425354	6425353	■	■
XNPU100416SRMM	4	11,61	4,83	6,60	0,10	1,60	0,08	■	■	■	6425267	6425269	6425268	■	■

NOTE: XNGU: High-precision periphery ground inserts.
XNPU: Precision-pressed and sintered-to-size inserts.

VSM490™ -10

Victory™ Shoulder Mills • VSM490-10 Series

■ Insert Selection Guide

Material Group	Light Machining		General Purpose		Heavy Machining	
	Geometry	Grade	Geometry	Grade	Geometry	Grade
P1-P2	XNGU-ML	WP40PM	XNPU-MM	WP40PM	XNPU-MM	WP40PM
P3-P4	XNGU-ML	WP40PM	XNPU-MM	WP40PM	XNPU-MM	WP40PM
P5-P6	XNGU-MM	WP25PM	XNPU-MM	WP35CM	XNPU-MM	WP40PM
M1-M2	XNGU-ML	WS40PM	XNGU-ML	WS40PM	XNPU-MM	WS40PM
M3	XNGU-ML	WS40PM	XNGU-ML	WS40PM	XNPU-MM	WS40PM
K1-K2	XNPU-ML	WK15PM	XNGU-MH	WK15CM	XNGU-MH	WK15CM
K3	XNPU-MM	WK15PM	XNGU-MH	WP35CM	XNGU-MH	WP35CM
N1-N2	XNGU-ALP	WN25PM	XNGU-ALP	WN25PM	XNGU-ALP	WN25PM
N3	XNGU-ALP	WN25PM	XNGU-ALP	WN25PM	XNGU-ALP	WN25PM
S1-S2	XNGU-ML	WP25PM	XNGU-ML	WS40PM	XNPU-MM	WS40PM
S3	XNGU-ML	WS40PM	XNGU-ML	WS40PM	XNPU-MM	WS40PM
S4	XNGU-ML	WS40PM	XNGU-ML	WS40PM	XNPU-MM	WS40PM
H1	XNGU-ML	WU10PM	XNGU-MM	WU10PM	-	-

■ Recommended Starting Speeds [m/min]*

Material Group		WK15CM	WK15PM	WN25PM	WP25PM	WP35CM	WP40PM	WS40PM	WU10PM	
P	1	-	-	-	330 285 270	455 395 370	295 260 245	-	-	-
	2	-	-	-	275 240 200	280 255 230	250 215 180	-	-	-
	3	-	-	-	255 215 175	255 230 205	230 195 160	-	-	-
	4	-	-	-	225 185 150	190 175 160	205 170 135	-	-	-
	5	-	-	-	185 170 150	260 230 210	170 155 135	170 145 120	-	-
	6	-	-	-	165 125 100	160 135 110	150 115 90	150 110 80	-	-
M	1	-	-	-	205 180 165	205 185 155	195 170 155	210 170 140	-	-
	2	-	-	-	185 160 130	185 160 140	175 150 125	180 145 120	-	-
	3	-	-	-	140 120 95	145 130 115	130 115 90	145 110 85	-	-
K	1	420 385 340	270 245 215	-	230 205 185	295 265 240	-	-	295 265 240	
	2	335 295 275	210 190 175	-	180 160 150	235 210 190	-	-	230 205 190	
	3	280 250 230	175 160 145	-	150 135 120	195 175 160	-	-	195 175 160	
N	1	-	-	1075 945 875	-	-	-	-	-	
	2	-	-	945 875 760	-	-	-	-	-	
	3	-	-	945 875 760	-	-	-	-	-	
S	1	-	-	-	40 35 25	-	-	40 35 25	-	
	2	-	-	-	40 35 25	-	-	40 35 25	-	
	3	-	-	-	50 40 25	-	-	50 40 25	-	
	4	-	-	-	70 50 35	-	-	60 50 30	-	
H	1	-	-	-	-	-	-	-	160 130 90	

NOTE: FIRST choice starting speeds are in **bold** type. As the average chip thickness increases, the speed should be decreased.
 *Material groups P, M, K, and H show recommended starting speeds for dry machining. For wet machining, reduce speed by 20%.
 *Material groups N and S show recommended starting speeds for wet machining. Not recommended for dry machining.

■ Recommended Starting Feeds [mm]

Light Machining	General Purpose	Heavy Machining
-----------------	-----------------	-----------------

Insert Geometry	Programmed Feed per Tooth (fz) as a % of Radial Depth of Cut (ae)														Insert Geometry	
	5%			10%			20%			30%			40-100%			
.E..ALP	0,12	0,23	0,32	0,08	0,17	0,23	0,06	0,13	0,18	0,06	0,11	0,15	0,05	0,10	0,14	.E..ALP
.E..ML	0,18	0,28	0,37	0,13	0,20	0,27	0,10	0,15	0,20	0,09	0,13	0,17	0,08	0,12	0,16	.E..ML
.S..MM	0,23	0,35	0,46	0,17	0,25	0,33	0,13	0,19	0,25	0,11	0,17	0,22	0,10	0,15	0,20	.S..MM
.S..MH	0,23	0,43	0,58	0,17	0,31	0,42	0,13	0,23	0,31	0,11	0,20	0,27	0,10	0,18	0,25	.S..MH

NOTE: Use "Light Machining" values as starting feed rate.

Victory™ Shoulder Mills • VSM490™-10 Series

Best Practices

Best-in-class wall finish with VSM490-10 at axial stepping-down jobs. For many shop floor setups, no additional finishing is required and has a positive impact on shorter machining time and lower tooling cost.

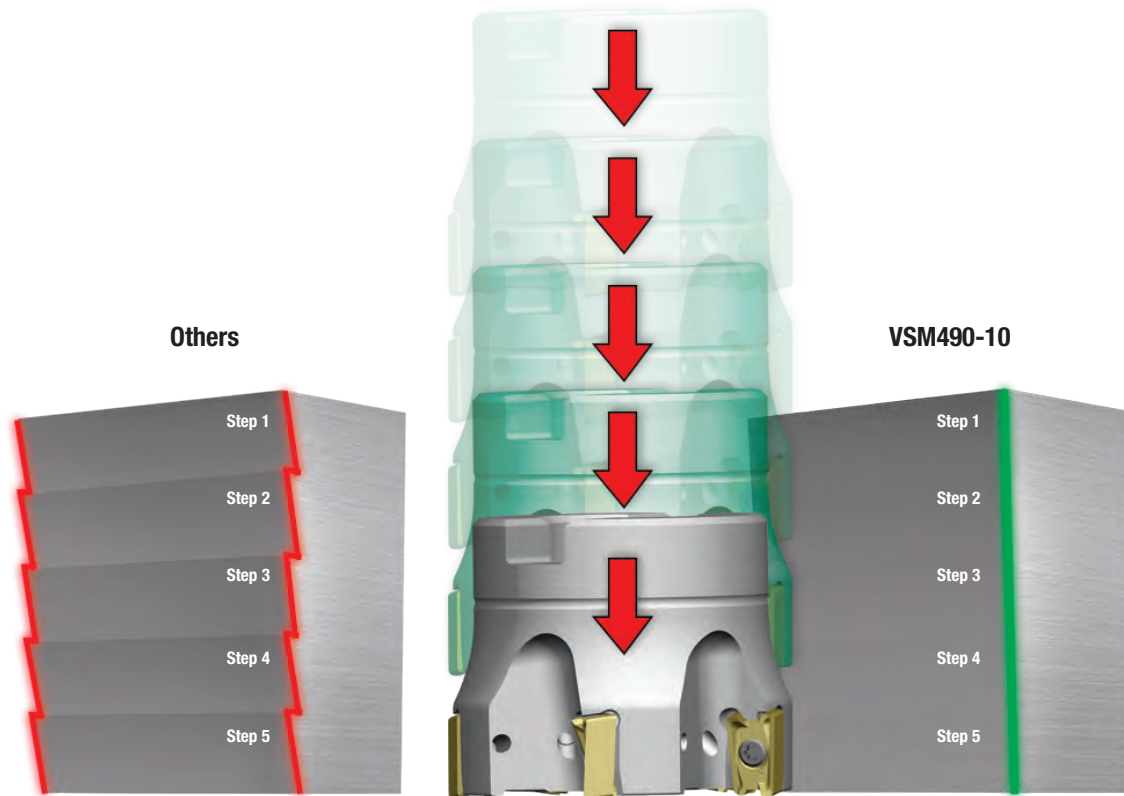

Excellent wall finish with VSM490-10

■ VSM490-10 Z-Axis Plunge Milling

cutting diameter (D1)	Z max	Y
16	1,5	9,33
18	1,5	9,95
20	1,5	10,54
22	1,5	11,09
25	1,5	11,87
28	1,5	12,61
32	1,5	13,53
40	1,5	15,20
50	1,5	17,06
63	1,5	19,21
80	1,5	21,70
100	1,5	24,31
125	1,5	27,22

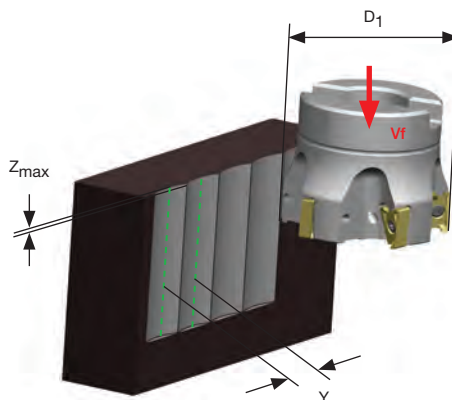

VSM490™ -15

4 Edged, Double-Sided 90° Victory™ Shoulder Mill



- True 90° roughing tool with embedded finishing capabilities all in one tool.
- Up to Ap1 max = 15mm.
- Best-in-class wall finish in axial stepping-down jobs.
- Lower cutting forces and real soft cutting action.
- Perfect fit for taper 50 spindles.
- Coarse, medium, and fine pitch shell mills available.

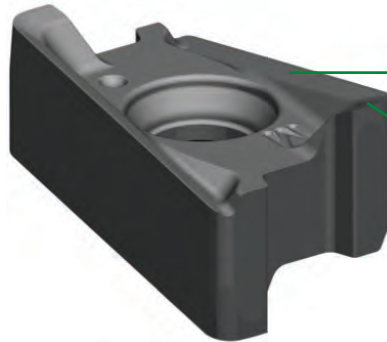





Super-positive rake design for low machine power consumption.

Integrated wiper facet for great surface floor finish.



See me in action!

Four geometries for all material groups in shoulder milling applications.

<p>-ALP</p>  <p>N</p> <p>For non-ferrous materials.</p>	<p>-ML</p>  <p>P M S</p> <p>First choice for stainless steel. Lower cutting forces.</p>	<p>-MM</p>  <p>P M K S</p> <p>First choice, especially when machining steels.</p>	<p>-MH</p>  <p>P K</p> <p>First choice for cast iron, and also recommended for heavy applications.</p>
---	---	---	--

Finishing Capabilities/Lower Cutting Forces

Geometry Strengthening

Wall Quality

Competitor Tool

Traditional tools are designed to achieve a 90° wall, but exhibit poor performance when machining walls in multiple passes.



VSM490-15

VSM490-15 eliminates the mismatch and minimises the marks left behind in step-down milling operations. By increasing wall quality and avoiding a second tool, productivity increases significantly.

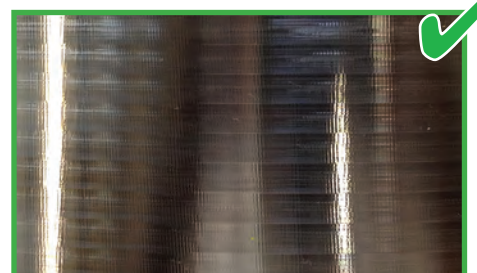

Victory™ Shoulder Mills • VSM490™-15 Series

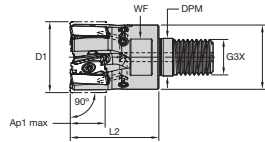

■ Screw-On End Mills

order number	catalogue number	D1	D	DPM	G3X	L2	WF	Ap1 max	Z	max RPM	coolant supply	kg
5873211	VSM490D025Z02M12XN15	25	21	12,5	M12	32	17	15,0	2	26700	Yes	0,18
5873212	VSM490D032Z03M16XN15	32	29	17,0	M16	40	24	15,0	3	22000	Yes	0,18
5873213	VSM490D032Z04M16XN15	32	29	17,0	M16	40	24	15,0	4	22000	Yes	0,18
5873214	VSM490D035Z04M16XN15	35	29	17,0	M16	40	24	15,0	4	20600	Yes	0,19

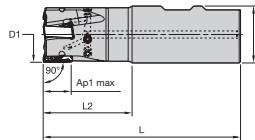

■ Weldon® End Mills

order number	catalogue number	D1	D	L	L2	Ap1 max	Z	max RPM	coolant supply	kg
5710285	VSM490D025Z02B25XN15	25	25	89	32	15,0	2	26700	Yes	0,28
5710286	VSM490D032Z03B32XN15	32	32	111	50	15,0	3	22000	Yes	0,58
5873215	VSM490D040Z03B32XN15	40	32	111	50	15,0	3	18800	Yes	0,65

NOTE: Weldon type not recommended for finishing operations.

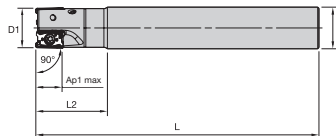

■ Cylindrical End Mills

order number	catalogue number	D1	D	L	L2	Ap1 max	Z	max RPM	coolant supply	kg
5873216	VSM490D025Z02A25XN15L100	25	25	100	43	15,0	2	26700	Yes	0,32
5710287	VSM490D025Z02A25XN15L170	25	25	170	43	15,0	2	26700	Yes	0,59
5873217	VSM490D032Z03A32XN15L110	32	32	110	49	15,0	3	22000	Yes	0,59
5710288	VSM490D032Z03A32XN15L200	32	32	200	50	15,0	3	22000	Yes	1,14
5873218	VSM490D032Z04A32XN15L110	32	32	110	49	15,0	4	22000	Yes	0,58
5873219	VSM490D032Z04A32XN15L200	32	32	200	50	15,0	4	22000	Yes	1,14

VSM490™ -15

Victory™ Shoulder Mills • VSM490-15 Series

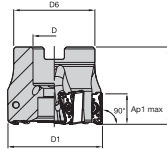

■ Shell Mills

order number	catalogue number	D1	D	D6	L	Ap1 max	Z	max RPM	coolant supply	kg
5710289	VSM490D040Z04S16XN15	40	16	37	40	15,0	4	18800	Yes	0,20
5710520	VSM490D040Z05S16XN15	40	16	37	40	15,0	5	18800	Yes	0,19
5873221	VSM490D050Z04S22XN15	50	22	42	40	15,0	4	16300	Yes	0,28
5710521	VSM490D050Z05S22XN15	50	22	42	40	15,0	5	16300	Yes	0,28
5710522	VSM490D050Z06S22XN15	50	22	42	40	15,0	6	16300	Yes	0,28
5873222	VSM490D063Z05S22XN15	63	22	50	40	15,0	5	14200	Yes	0,50
5710523	VSM490D063Z06S22XN15	63	22	50	40	15,0	6	14200	Yes	0,49
5710524	VSM490D063Z07S22XN15	63	22	50	40	15,0	7	14200	Yes	0,48
5873223	VSM490D080Z05S27XN15	80	27	60	50	15,0	5	12300	Yes	1,03
5710525	VSM490D080Z07S27XN15	80	27	60	50	15,0	7	12300	Yes	1,03
5873224	VSM490D080Z09S27XN15	80	27	60	50	15,0	9	12300	Yes	1,04
5710526	VSM490D100Z08S32XN15	100	32	80	50	15,0	8	10900	Yes	1,61
5873225	VSM490D100Z11S32XN15	100	32	80	50	15,0	11	10900	Yes	1,64
5873226	VSM490D125Z09S40XN15	125	40	90	63	15,0	9	9600	Yes	2,96
5873227	VSM490D125Z12S40XN15	125	40	90	63	15,0	12	9600	Yes	3,11
5873228	VSM490D160Z12S40XN15	160	40	110	63	15,0	12	8400	Yes	4,80

■ Shell Mills • Japanese Industry Standard (JIS)

order number	catalogue number	D1	D	D6	L	Ap1 max	Z	max RPM	coolant supply	kg
6342806	VSM490D080Z05S254XN15JIS	80	25,40	50	50	15,0	5	12300	Yes	0,89
6342807	VSM490D080Z07S254XN15JIS	80	25,40	50	50	15,0	7	12300	Yes	0,87
6342808	VSM490D100Z08S3175XN15JIS	100	31,76	60	50	15,0	8	10900	Yes	1,23
6342809	VSM490D125Z09S381XN15JIS	125	38,10	80	63	15,0	9	9600	Yes	2,81
6342810	VSM490D160Z12S508XN15JIS	160	50,80	100	63	15,0	12	8400	Yes	4,88

■ Spare Parts

D1	insert screw	Nm	wrench
25 - 160	MS-2071	3,5	DT15IP

For M4000 cartridge milling system, please see page 35.



VSM490-15
M4000CA-XN15
(MM6357989)



Victory™ Shoulder Mills • VSM490™-15 Series

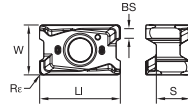

● first choice
○ alternate choice

P	■	■	■	○	●	●	○	○
M	■	■	■	○	●	●	○	○
K	■	■	■	○	●	●	○	○
N	■	■	■	○	●	●	○	○
S	■	■	■	○	●	●	○	○
H	■	■	■	○	●	●	○	○



■ VSM490-15 Series Inserts

catalogue number	cutting edges	LI	S	W	BS	Re	hm	WK15CM	WK15PM	WN25PM	WP25PM	WP35CM	WP40PM	WS40PM	WU35PM
XNGU15T604ERALP	4	16,20	6,88	10,00	2,20	0,40	0,03	■	■	6082644	■	■	■	■	■
XNGU15T608ERALP	4	16,20	6,88	10,00	1,80	0,80	0,03	■	■	6082645	■	■	■	■	■
XNGU15T604ERML	4	16,20	6,88	10,00	2,20	0,40	0,08	■	■	■	5890821	■	■	■	■
XNGU15T608ERML	4	16,20	6,88	10,00	1,80	0,80	0,08	■	6242523	■	5873481	5890822	6180324	6180323	5873483
XNGU15T604SRMM	4	16,20	6,88	10,00	2,20	0,40	0,10	■	6242521	■	5949204	■	■	■	■
XNGU15T608SRMM	4	16,20	6,88	10,00	1,90	0,80	0,10	■	6242522	■	5710527	5949205	5710528	5710529	5949206
XNGU15T612SRMM	4	16,20	6,88	10,00	1,50	1,20	0,08	■	6234707	■	■	■	■	■	■
XNGU15T608SRMH	4	16,20	6,88	10,00	1,80	0,80	0,10	6003725	6003724	6003570	6003723	6003721	■	6003722	
XNGU15T616SRMH	4	16,20	6,88	10,00	1,00	1,60	0,10	6030380	6030378	6030376	6030377	■	■	■	
XNPU15T608ERML	4	16,10	6,88	10,00	1,90	0,80	0,08	■	■	5883097	■	5883098	■	5883099	
XNPU15T608SRMM	4	16,10	6,88	10,00	1,90	0,80	0,10	5873420	5873419	5873415	5890761	5873418	5873416	6180320	5873417
XNPU15T612SRMM	4	16,10	6,88	10,00	1,50	1,20	0,10	5890763	5890762	5890728	5890729	6180321	6180320	5890730	5890730
XNPU15T616SRMM	4	16,10	6,88	10,00	1,10	1,60	0,10	5883522	5883521	■	■	■	■	■	■
XNPU15T620SRMM	4	16,10	6,88	10,00	0,70	2,00	0,10	6030375	■	6030372	6030374	5883448	6180322	5883449	■

NOTE: XNGU: High-precision periphery ground inserts.
XNPU: Precision-pressed and sintered-to-size inserts.

VSM490™ -15

Victory™ Shoulder Mills • VSM490-15 Series

Insert Selection Guide

Material Group	Light Machining		General Purpose		Heavy Machining	
	Geometry	Grade	Geometry	Grade	Geometry	Grade
P1-P2	XNGU-ML	WP40PM	XNPU-MM	WP40PM	XNPU-MM	WP40PM
P3-P4	XNGU-ML	WP40PM	XNPU-MM	WP40PM	XNPU-MM	WP40PM
P5-P6	XNGU-MM	WP25PM	XNPU-MM	WP35CM	XNPU-MM	WP40PM
M1-M2	XNGU-ML	WS40PM	XNGU-ML	WS40PM	XNPU-MM	WS40PM
M3	XNGU-ML	WS40PM	XNGU-ML	WS40PM	XNPU-MM	WS40PM
K1-K2	XNPU-MM	WK15PM	XNGU-MH	WK15CM	XNGU-MH	WK15CM
K3	XNPU-MM	WK15PM	XNGU-MH	WP35CM	XNGU-MH	WP35CM
N1-N2	XNGU-ALP	WN25PM	XNGU-ALP	WN25PM	XNGU-ALP	WN25PM
N3	XNGU-ALP	WN25PM	XNGU-ALP	WN25PM	XNGU-ALP	WN25PM
S1-S2	XNGU-ML	WP25PM	XNGU-ML	WS40PM	XNPU-MM	WS40PM
S3	XNGU-ML	WS40PM	XNGU-ML	WS40PM	XNPU-MM	WS40PM
S4	XNGU-ML	WS40PM	XNGU-ML	WS40PM	XNPU-MM	WS40PM
H1	-	-	-	-	-	-

Recommended Starting Speeds [m/min]*

Material Group		WK15CM			WK15PM			WN25PM			WP25PM			WP35CM			WP40PM			WS40PM			WU35PM		
P	1	-	-	-	-	-	-	-	-	330	285	270	455	395	370	295	260	245	-	-	-	260	230	215	
	2	-	-	-	-	-	-	-	-	275	240	200	280	255	230	250	215	180	-	-	-	220	190	160	
	3	-	-	-	-	-	-	-	-	255	215	175	255	230	205	230	195	160	-	-	-	200	170	140	
	4	-	-	-	-	-	-	-	-	225	185	150	190	175	160	205	170	135	-	-	-	180	150	120	
	5	-	-	-	-	-	-	-	-	185	170	150	260	230	210	170	155	135	170	145	120	150	135	120	
	6	-	-	-	-	-	-	-	-	165	125	100	160	135	110	150	115	90	150	110	80	130	100	80	
M	1	-	-	-	-	-	-	-	-	205	180	165	205	185	155	195	170	155	210	170	140	170	150	135	
	2	-	-	-	-	-	-	-	-	185	160	130	185	160	140	175	150	125	180	145	120	155	130	110	
	3	-	-	-	-	-	-	-	-	140	120	95	145	130	115	130	115	90	145	110	85	115	100	80	
K	1	420	385	340	270	245	215	-	-	230	205	185	295	265	240	-	-	-	-	-	-	-	-	-	
	2	335	295	275	210	190	175	-	-	180	160	150	235	210	190	-	-	-	-	-	-	-	-	-	
	3	280	250	230	175	160	145	-	-	150	135	120	195	175	160	-	-	-	-	-	-	-	-	-	
N	1	-	-	-	-	-	-	1075	945	875	-	-	-	-	-	-	-	-	-	-	-	-	-	-	
	2	-	-	-	-	-	-	945	875	760	-	-	-	-	-	-	-	-	-	-	-	-	-	-	
	3	-	-	-	-	-	-	945	875	760	-	-	-	-	-	-	-	-	-	-	-	-	-	-	
S	1	-	-	-	-	-	-	-	-	40	35	25	-	-	-	-	-	40	35	25	35	30	25		
	2	-	-	-	-	-	-	-	-	40	35	25	-	-	-	-	-	40	35	25	35	30	25		
	3	-	-	-	-	-	-	-	-	50	40	25	-	-	-	-	-	50	40	25	45	35	25		
	4	-	-	-	-	-	-	-	-	70	50	35	-	-	-	-	-	60	50	30	60	45	30		
H	1	-	-	-	-	-	-	-	-	120	90	70	-	-	-	-	-	-	-	-	-	-	-		

NOTE: FIRST choice starting speeds are in **bold** type. As the average chip thickness increases, the speed should be decreased.
 *Material groups P, M, K, and H show recommended starting speeds for dry machining. For wet machining, reduce speed by 20%.
 *Material groups N and S show recommended starting speeds for wet machining. Not recommended for dry machining.

Recommended Starting Feeds [mm]

Insert Geometry	Programmed Feed per Tooth (fz) as a % of Radial Depth of Cut (ae)															Insert Geometry
	5%			10%			20%			30%			40-100%			
.E..ALP	0,11	0,23	0,35	0,08	0,17	0,25	0,06	0,13	0,19	0,05	0,11	0,16	0,05	0,10	0,15	.E..ALP
.E..ML	0,17	0,31	0,46	0,13	0,23	0,33	0,09	0,17	0,25	0,08	0,15	0,22	0,08	0,14	0,20	.E..ML
.S..MM	0,22	0,40	0,64	0,16	0,29	0,46	0,12	0,22	0,34	0,10	0,19	0,30	0,10	0,18	0,28	.S..MM
.S..MH	0,23	0,45	0,74	0,17	0,33	0,54	0,13	0,24	0,40	0,11	0,21	0,35	0,10	0,20	0,32	.S..MH

NOTE: Use "Light Machining" values as starting feed rate.

Best Practices

VSM490-15 Z-Axis Plunge

cutting diameter (D1)	Z max	Y	cutting diameter (D1)	Z max	Y
25	2,4	14,73	50	2,4	21,38
32	2,4	16,86	63	2,4	24,12
35	2,4	17,69	80	2,4	27,29
40	2,4	19,00	100	2,4	30,61
			125	2,4	34,31
			160	2,4	38,90

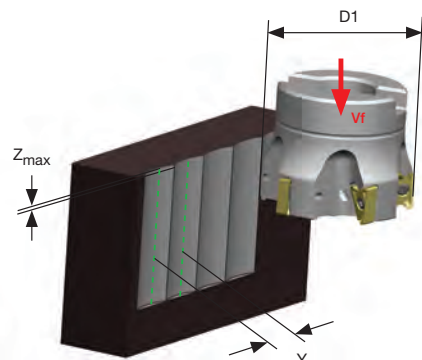



Machining Central App from WIDIA™

The fastest, easiest way to get feeds and speeds.

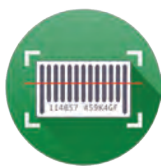
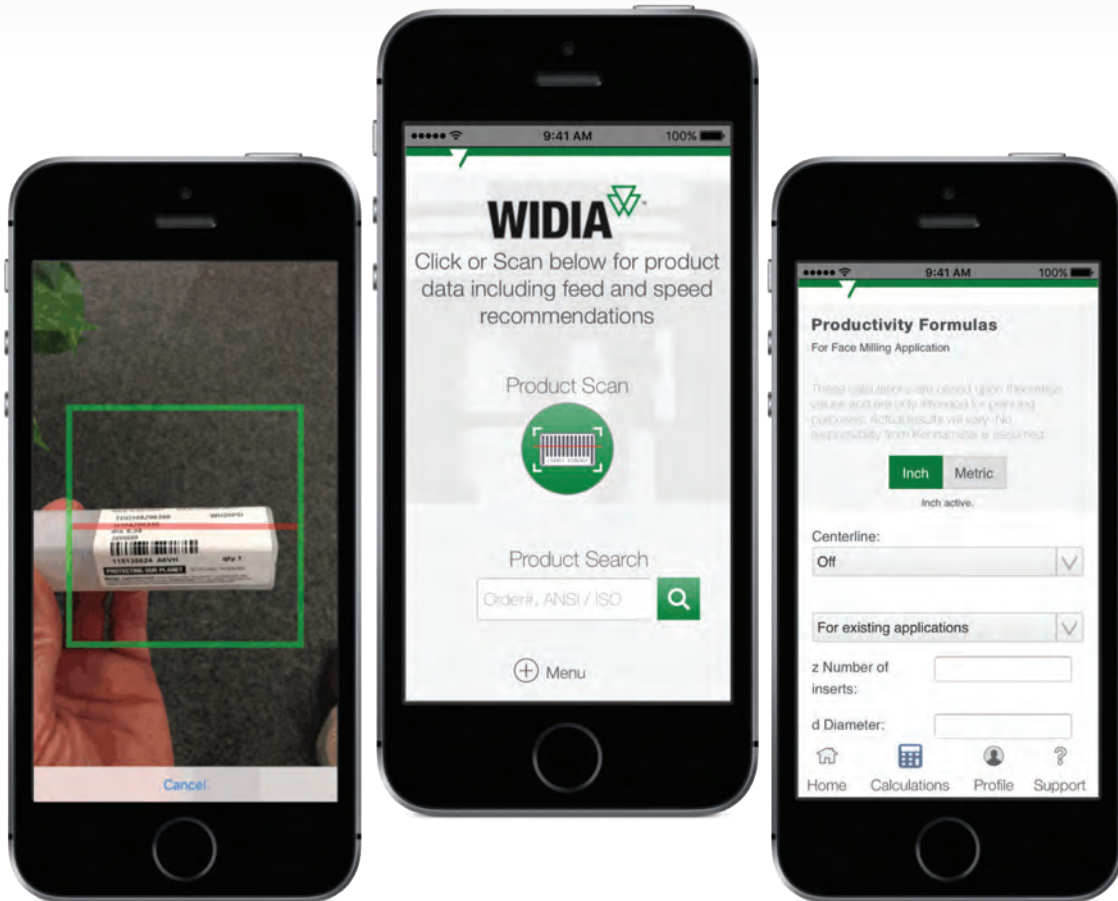

SCAN

With the new WIDIA app, product data is just a quick scan away. Now, when you're on the floor and need to quickly access the speeds and feeds of your favorite WIDIA tool, the WIDIA app gives you reliable information in just a few seconds.



SEARCH

Don't have a barcode? The new WIDIA app includes another simple search technique — just type the tool's corresponding order number or the ANSI or ISO catalogue number into the search bar. You'll get the same reliable data as if you'd scanned the tool's barcode. It's simple and quick — no interruption in production!



CALCULATE

Have a specific machining need that our recommended speeds and feeds don't quite address? Try out our three NOVO™ based calculators. Both end milling and face milling calculators are available. Simply fill in the blank fields, and our calculators will quickly provide the data you need.

DOWNLOAD THE WIDIA MACHINING CENTRAL MOBILE APP

widia.com



VSM

The Most Versatile 90° Shoulder Mill
Platform in the WIDIA™ Portfolio.

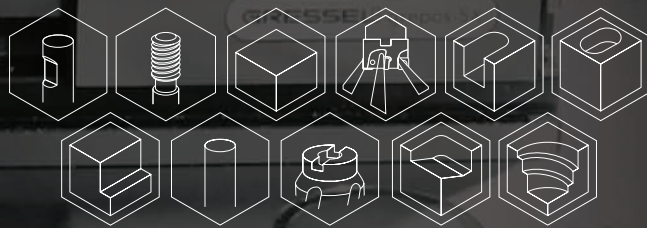



VSM11™

Ap Capabilities: Up to 11mm

Screw-On End Mills: 16–40mm

Weldon® End Mills: 12–32mm

Cylindrical End Mills: 12–32mm

Shell Mills: 40–125mm

M4000 Cartridge Milling System: 125–315mm



VSM17™

Ap Capabilities: Up to 16,4mm

Screw-On End Mills: 25–40mm

Weldon End Mills: 25–40mm

Cylindrical End Mills: 25–40mm

Shell Mills: 40–160mm

M4000 Cartridge Milling System: 125–315mm



2-Edged, 90° Victory™ Shoulder Mill (VSM)

High-performance, robust, highly positive, 90° shoulder milling platform with advanced ramping capability.

Delivers low horsepower consumption, versatility, and soft cutting action.

Latest WIDIA™ Victory grades, 4 geometries, and a well-rounded steel body portfolio covers multiple material types and applications from light, precise machining to medium roughing.

WIDIA 

widia.com

VSM11™

2 Edged, 90° Victory™ Shoulder Mill (VSM)



- True 90° shoulder milling platform; up to Ap1 max = 11mm.
- Aggressive ramping capability up to 10° with end mills with a diameter of 16mm.
- Optimised chip gash for improved cutter stability and chip flow.
- Well-guided internal coolant supply to the cutting edge.
- Best-in-class milling grade WS40PM boosts productivity when machining stainless steel and high-temp alloys.

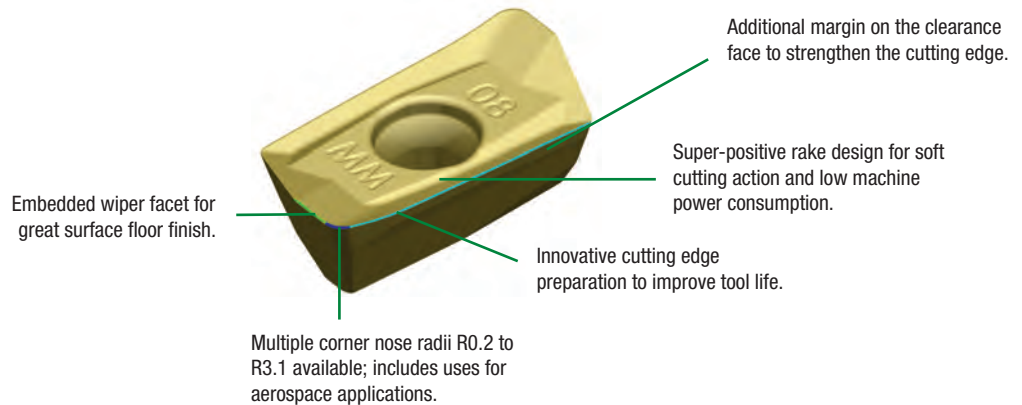

See me in action!

Geometries for all material groups in shoulder milling applications.

-ALP	-PCD	-ML	-MM	-MH
				
N	N	P M S H	P M K S H	P M K S
Roughing and finishing of aluminium alloys. High precision. Periphery ground.	Roughing and finishing of aluminium alloys. Abrasives non-ferrous materials. High precision. Periphery ground.	Light machining and finishing. First choice for stainless steel and titanium. Periphery ground.	Medium machining. First choice for general purpose. Precision pressed to size.	First choice for heavy-duty machining. Steel and cast iron materials. Precision pressed to size.

Finishing Capabilities/Lower Cutting Forces

Geometry Strengthening

Victory™ Shoulder Mills • VSM11™ Series

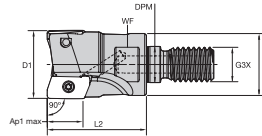

■ Screw-On End Mills

order number	catalogue number	D1	D	DPM	G3X	L2	WF	Ap1 max	Z	max ramp angle	max RPM	coolant supply	kg
5417011	VSM11D016Z02M08XD11	16	13	8,5	M8	25	10	11,5	2	10.0°	41400	Yes	0,02
5417013	VSM11D020Z03M10XD11	20	18	10,5	M10	28	15	11,6	3	7.8°	35100	Yes	0,05
5417015	VSM11D025Z04M12XD11	25	21	12,5	M12	32	17	11,5	4	5.3°	30200	Yes	0,08
5417017	VSM11D032Z04M16XD11	32	29	17,0	M16	40	24	11,4	4	3.6°	25800	Yes	0,18
5417019	VSM11D040Z06M16XD11	40	29	17,0	M16	40	24	11,4	6	2.6°	22600	Yes	0,24

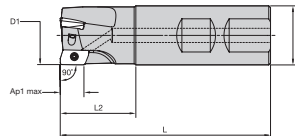

■ Weldon® End Mills

order number	catalogue number	D1	D	L	L2	Ap1 max	Z	max ramp angle	max RPM	coolant supply	kg
5416454	VSM11D012Z01B16XD11	12	16	70	21	11,7	1	3.7°	53100	Yes	0,08
5416455	VSM11D016Z02B16XD11	16	16	70	21	11,5	2	10.0°	41400	Yes	0,09
5416457	VSM11D020Z02B20XD11	20	20	81	30	11,6	2	7.8°	35100	Yes	0,15
5416458	VSM11D020Z03B20XD11	20	20	81	30	11,6	3	7.8°	35100	Yes	0,16
5416459	VSM11D025Z03B25XD11	25	25	88	31	11,5	3	5.3°	30200	Yes	0,27
5416480	VSM11D025Z04B25XD11	25	25	88	31	11,5	4	5.3°	30200	Yes	0,28
5416481	VSM11D030Z04B25XD11	30	25	88	31	11,5	4	3.2°	26900	Yes	0,30
5416482	VSM11D032Z04B32XD11	32	32	100	39	11,4	4	3.6°	25800	Yes	0,51
5416483	VSM11D032Z05B32XD11	32	32	100	39	11,4	5	3.6°	25800	Yes	0,52

NOTE: Weldon type not recommended for finishing operations.

VSM11™

Victory™ Shoulder Mills • VSM11 Series

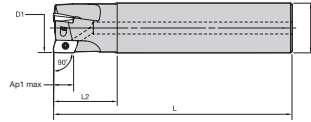

■ Cylindrical End Mills (Regular and Long Version)

order number	catalogue number	D1	D	L	L2	Ap1 max	Z	max ramp angle	max RPM	coolant supply	kg
5416632	VSM11D012Z01A16XD11L100	12	16	100	25	11,7	1	3.7°	53100	Yes	0,13
5416633	VSM11D016Z02A16XD11L100	16	16	100	31	11,5	2	10.0°	41400	Yes	0,12
5416700	VSM11D016Z02A16XD11L170	16	16	170	25	11,5	2	10.0°	41400	Yes	0,23
5416701	VSM11D018Z02A16XD11L170	18	16	170	25	11,6	2	9.7°	37900	Yes	0,23
5416634	VSM11D020Z02A20XD11L110	20	20	110	31	11,6	2	7.8°	35100	Yes	0,22
5416702	VSM11D020Z02A20XD11L170	20	20	170	41	11,6	2	7.8°	35100	Yes	0,35
5416635	VSM11D020Z03A20XD11L110	20	20	110	31	11,6	3	7.8°	35100	Yes	0,23
5416703	VSM11D020Z03A20XD11L170	20	20	170	41	11,6	3	7.8°	35100	Yes	0,36
5416704	VSM11D022Z03A20XD11L170	22	20	170	30	11,5	3	6.6°	32900	Yes	0,37
5416636	VSM11D025Z03A25XD11L120	25	25	120	33	11,5	3	5.3°	30200	Yes	0,39
5416705	VSM11D025Z03A25XD11L210	25	25	210	50	11,5	3	5.3°	30200	Yes	0,70
5416637	VSM11D025Z04A25XD11L120	25	25	120	33	11,5	4	5.3°	30200	Yes	0,40
5416706	VSM11D025Z04A25XD11L210	25	25	210	50	11,5	4	5.3°	30200	Yes	0,72
5416638	VSM11D032Z03A32XD11L130	32	32	130	41	11,4	3	3.6°	25800	Yes	0,70
5416707	VSM11D032Z03A32XD11L250	32	32	250	65	11,4	3	3.6°	25800	Yes	1,39
5416639	VSM11D032Z05A32XD11L130	32	32	130	41	11,4	5	3.6°	25800	Yes	0,71

NOTE: Standard milling cutters will accept insert nose radii up to 1,6mm without modification.
For tool body modification instructions, see page 26.

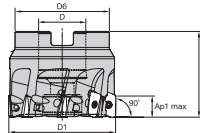

■ Shell Mills

order number	catalogue number	D1	D	D6	L	Ap1 max	Z	max ramp angle	max RPM	coolant supply	kg
5416316	VSM11D040Z04S016XD11	40	16	37	40	11,4	4	2.6°	22600	Yes	0,22
5416317	VSM11D040Z06S016XD11	40	16	37	40	11,4	6	2.6°	22600	Yes	0,22
5416318	VSM11D050Z05S022XD11	50	22	44	40	11,3	5	1.9°	19900	Yes	0,33
5416319	VSM11D050Z08S022XD11	50	22	44	40	11,3	8	1.9°	19900	Yes	0,33
5416340	VSM11D063Z06S022XD11	63	22	44	40	11,3	6	1.5°	17500	Yes	0,50
5416341	VSM11D063Z09S022XD11	63	22	44	40	11,3	9	1.5°	17500	Yes	0,52
5416342	VSM11D080Z08S027XD11	80	27	60	50	11,3	8	1.1°	15300	Yes	1,14
5416345	VSM11D100Z09S032XD11	100	32	80	50	11,3	9	.9°	13600	Yes	1,79
5416347	VSM11D125Z011S040XD11	125	40	80	63	11,3	11	.7°	12100	Yes	3,01

■ Spare Parts

D1	insert screw	Nm	wrench
12 - 125	192.432	1,0	170.028

For M4000 cartridge milling system, please see page 35.



VSM11
M4000CA-XDPT11
(MM6152926)



Victory™ Shoulder Mills • VSM11™ Series

Recommended Starting Speeds [m/min]*

Material Group		WDN10U			WK15CM			WK15PM			WN10HM			WN25PM			WP25PM		
P	1	—	—	—	—	—	—	—	—	—	—	—	—	—	330	285	270		
	2	—	—	—	—	—	—	—	—	—	—	—	—	—	275	240	200		
	3	—	—	—	—	—	—	—	—	—	—	—	—	—	255	215	175		
	4	—	—	—	—	—	—	—	—	—	—	—	—	—	225	185	150		
	5	—	—	—	—	—	—	—	—	—	—	—	—	—	185	170	150		
	6	—	—	—	—	—	—	—	—	—	—	—	—	—	165	125	100		
M	1	—	—	—	—	—	—	—	—	—	—	—	—	—	205	180	165		
	2	—	—	—	—	—	—	—	—	—	—	—	—	—	185	160	130		
	3	—	—	—	—	—	—	—	—	—	—	—	—	—	140	120	95		
K	1	—	—	—	420	385	340	270	245	215	—	—	—	—	230	205	185		
	2	—	—	—	335	295	275	210	190	175	—	—	—	—	180	160	150		
	3	—	—	—	280	250	230	175	160	145	—	—	—	—	150	135	120		
N	1	4010	3505	2990	—	—	—	—	—	—	795	695	600	1075	945	875	—	—	
	2	1600	1495	1400	—	—	—	—	—	—	795	695	600	945	875	760	—	—	
	3	1600	1495	1400	—	—	—	—	—	—	560	485	420	945	875	760	—	—	
S	1	—	—	—	—	—	—	—	—	—	—	—	—	—	—	—	40	35	25
	2	—	—	—	—	—	—	—	—	—	—	—	—	—	—	—	40	35	25
	3	—	—	—	—	—	—	—	—	—	—	—	—	—	—	—	50	40	25
	4	—	—	—	—	—	—	—	—	—	—	—	—	—	—	—	70	50	35
H	1	—	—	—	—	—	—	—	—	—	—	—	—	—	—	—	120	90	70

Material Group		WP35CM			WP40PM			WS30PM			WS40PM			WU35PM		
P	1	455	395	370	295	260	245	—	—	—	—	—	—	260	230	215
	2	280	255	230	250	215	180	—	—	—	—	—	—	220	190	160
	3	255	230	205	230	195	160	—	—	—	—	—	—	200	170	140
	4	190	175	160	205	170	135	—	—	—	—	—	—	180	150	120
	5	260	230	210	170	155	135	—	—	—	170	145	120	150	135	120
	6	160	135	110	150	115	90	—	—	—	150	110	80	130	100	80
M	1	205	185	155	195	170	155	225	200	185	210	170	140	170	150	135
	2	185	160	140	175	150	125	205	180	145	180	145	120	155	130	110
	3	145	130	115	130	115	90	155	135	105	145	110	85	115	100	80
K	1	295	265	240	—	—	—	—	—	—	—	—	—	—	—	—
	2	235	210	190	—	—	—	—	—	—	—	—	—	—	—	—
	3	195	175	160	—	—	—	—	—	—	—	—	—	—	—	—
N	1	—	—	—	—	—	—	—	—	—	—	—	—	—	—	—
	2	—	—	—	—	—	—	—	—	—	—	—	—	—	—	—
	3	—	—	—	—	—	—	—	—	—	—	—	—	—	—	—
S	1	—	—	—	—	—	—	45	40	30	40	35	25	35	30	25
	2	—	—	—	—	—	—	45	40	30	40	35	25	35	30	25
	3	—	—	—	—	—	—	55	45	30	50	40	25	45	35	25
	4	—	—	—	—	—	—	70	60	40	60	50	30	60	45	30
H	1	—	—	—	—	—	—	—	—	—	—	—	—	—	—	—

NOTE: FIRST choice starting speeds are in **bold** type. As the average chip thickness increases, the speed should be decreased.
 *Material groups P, M, K, and H show recommended starting speeds for dry machining. For wet machining, reduce speed by 20%.
 *Material groups N and S show recommended starting speeds for wet machining. Not recommended for dry machining.

Light Machining	General Purpose	Heavy Machining
-----------------	-----------------	-----------------

Recommended Starting Feeds [mm]

Insert Geometry	Programmed Feed per Tooth (fz) as a % of Radial Depth of Cut (ae)															Insert Geometry
	5%			10%			20%			30%			40-100%			
.F..PCD	0,12	0,18	0,29	0,08	0,13	0,21	0,06	0,10	0,16	0,06	0,09	0,14	0,05	0,08	0,12	.F..PCD
.F..ALP	0,12	0,22	0,31	0,08	0,16	0,23	0,06	0,12	0,17	0,06	0,10	0,15	0,05	0,10	0,14	.F..ALP
.E..ML	0,17	0,27	0,36	0,13	0,20	0,26	0,10	0,15	0,19	0,08	0,13	0,17	0,08	0,12	0,16	.E..ML
.S..MM	0,23	0,32	0,47	0,17	0,23	0,34	0,13	0,17	0,25	0,11	0,15	0,22	0,10	0,14	0,20	.S..MM
.S..MH	0,23	0,37	0,56	0,17	0,27	0,40	0,13	0,20	0,30	0,11	0,17	0,26	0,10	0,16	0,24	.S..MH

NOTE: Use "Light Machining" values as starting feed rate.

Best Practices

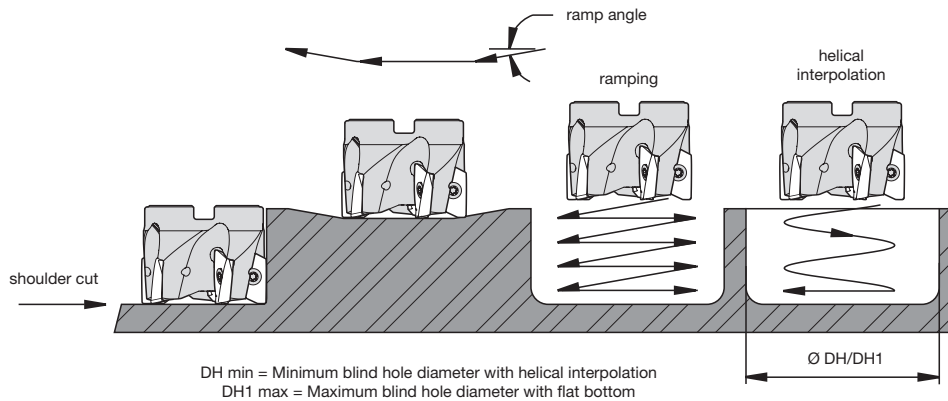

cutting diameter (D1)	max RPM	max ramp angle to steel body interference	max flat-bottom hole diameter (DH1 max)	min hole diameter (DH min)
16	41400	10.00°	32,00	19,00
20	35100	7.80°	40,00	27,00
25	30200	5.30°	50,00	37,00
32	25800	3.60°	64,00	51,00
40	22600	2.60°	80,00	67,00
50	19900	2.00°	100,00	87,00
63	17500	2.00°	126,00	113,00
80	15300	1.00°	160,00	147,00
100	13600	0.90°	200,00	187,00
125	12100	0.70°	250,00	237,00

NOTE: For DH1 max, subtract the insert corner radius from the max hole diameter.

Modification Instructions for Use of Larger Radii Inserts (Shoulder Mills and Helical Mills)

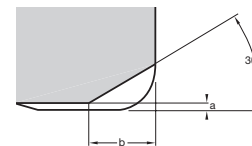

insert corner radius	material to remove	
	a	b
2,0–3,2mm	0,2mm	1,8mm

NOTE: Standard milling cutters will accept insert nose radii up to 1,6mm without modification.

VSM11 Z-Axis Plunging

cutting diameter (D1)	Z max	Y
16	6,4	15,68
18	6,4	17,23
20	6,4	18,66
22	6,4	19,98
25	6,4	21,82
32	6,4	25,60
40	6,4	29,33
50	6,4	33,41
63	6,4	38,07
80	6,4	43,41
100	6,4	48,95
125	6,4	55,10
160	6,4	62,71

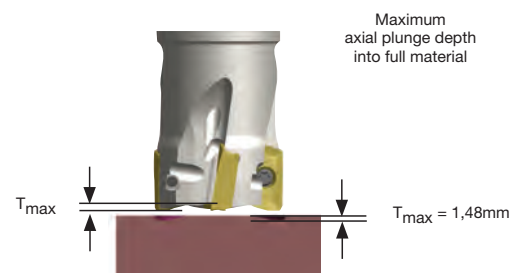
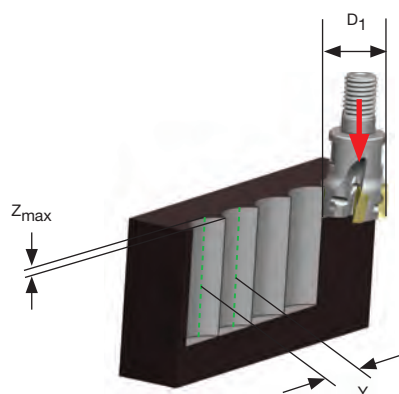

WIDIA™ Victory™



WS40PM

Breakthrough in the latest substrate and coating technology to boost productivity in **stainless steels and high-temp alloys**



Advanced Milling Grade for Titanium

Multilayer PVD AlTiN-TiN Coating

- Improved chemical and abrasive wear resistance.
- Consistent tool life performance.
- Primarily for wet machining. Also great results in dry machining.

New Medium-Grained Substrate

- Minimises tendency for thermal cracking.
- Excellent fatigue resistance and edge strength.
- Rich in cobalt content for improved toughness.

VSM17™





2 Edged, 90° Victory™ Shoulder Mill (VSM)

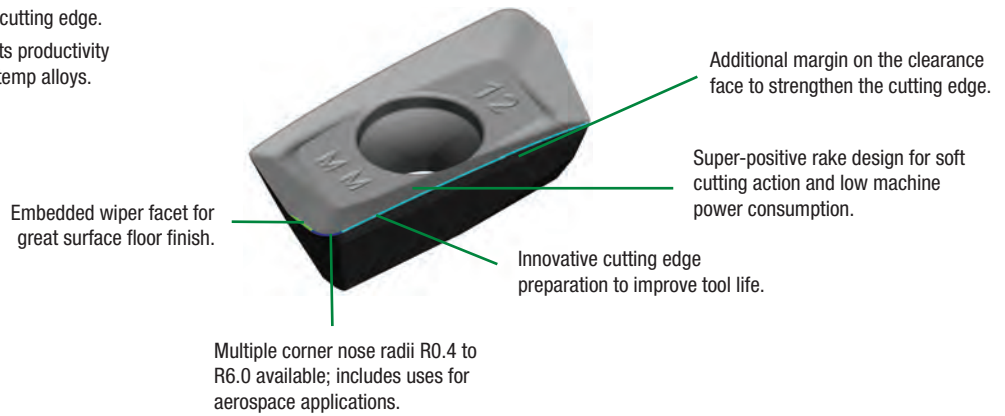

- True 90° shoulder milling platform; up to $A_{p1} \text{ max} = 16\text{mm}$.
- Aggressive ramping capability up to 8.8° with end mills with a diameter of 25mm.
- Optimised chip gash for improved cutter stability and chip flow.
- Well-guided internal coolant supply to the cutting edge.
- Best-in-class milling grade WS40PM boosts productivity when machining stainless steel and high-temp alloys.



Geometries for all material groups in shoulder milling applications.

<p>-ALP</p>  <p>N</p> <p>Roughing and finishing of aluminium alloys. High precision. Periphery ground.</p>	<p>-ML</p>  <p>P M S H</p> <p>Light machining and finishing. First choice for stainless steel and titanium. Periphery ground.</p>	<p>-MM</p>  <p>P M K S H</p> <p>Medium machining. First choice for general purpose. Precision pressed to size.</p>	<p>-MH</p>  <p>P M K S</p> <p>First choice for heavy-duty machining. Steel and cast iron materials. Precision pressed to size.</p>
--	---	--	--

Finishing Capabilities/Lower Cutting Forces

Geometry Strengthening

2x Higher Metal Removal Rate!



Specifications	Before VSM	WIDIA™
Workpiece	—	K2 — Ductile Iron
Insert	—	XDPT170408PESRMM
Grade	—	WK15CM
Cutter	—	VSM17D080Z7S27XD17
Diameter	—	80mm
No. cutting edges (z)	6	7
Vc	160 m/min	210 m/min
Feed rate (fz)	0,078mm	0,11mm
Vf	298 mm/min	665 mm/min
Ap	3mm	3mm
ae	60mm	60mm
MRR	54 cm ³ /min	120 cm³/min
Coolant	Dry	Dry



Victory™ Shoulder Mills • VSM17™ Series

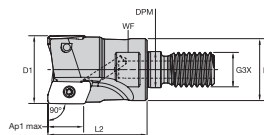

■ Screw-On End Mills

order number	catalogue number	D1	D	DPM	G3X	L2	WF	Ap1 max	Z	max ramp angle	max RPM	coolant supply	kg
5988091	VSM17D025Z02M12XD17	25	21	12,5	M12	35	17	16,4	2	8.8°	41800	Yes	0,08
5988092	VSM17D032Z03M16XD17	32	29	17,0	M16	40	24	16,3	3	5.7°	34700	Yes	0,17
5988131	VSM17D40Z03M016XD17	40	29	17,0	M16	40	24	16,2	3	4.0°	29800	Yes	0,20
5988093	VSM17D040Z04M16XD17	40	29	17,0	M16	40	24	16,2	4	4.0°	29800	Yes	0,20

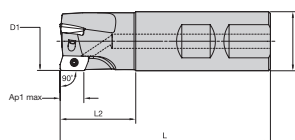

■ Weldon® End Mills

order number	catalogue number	D1	D	L	L2	Ap1 max	Z	max ramp angle	max RPM	coolant supply	kg
5988102	VSM17D025Z02B25XD17	25	25	90	33	16,4	2	8.8°	41800	Yes	0,26
5988103	VSM17D032Z03B32XD17	32	32	100	39	16,3	3	5.7°	34700	Yes	0,48
5988104	VSM17D040Z04B40XD17	40	40	110	39	16,2	4	4.0°	29800	Yes	0,87

NOTE: Weldon type not recommended for finishing operations.

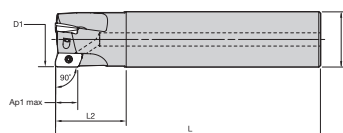

■ Cylindrical End Mills (Regular and Long Version)

order number	catalogue number	D1	D	L	L2	Ap1 max	Z	max ramp angle	max RPM	coolant supply	kg
5988055	VSM17D025Z02A25XD17L110	25	25	110	44	16,4	2	8.8°	41800	Yes	0,32
5988056	VSM17D025Z02A25XD17L170	25	25	170	44	16,4	2	8.8°	41800	Yes	0,54
5988107	VSM17D032Z02A32XD17L120	32	32	120	50	16,3	2	5.7°	34700	Yes	0,60
5988108	VSM17D032Z02A32XD17L210	32	32	210	50	16,3	2	5.7°	34700	Yes	1,14
5988057	VSM17D032Z03A32XD17L120	32	32	120	50	16,3	3	5.7°	34700	Yes	0,60
5988058	VSM17D032Z03A32XD17L210	32	32	210	50	16,3	3	5.7°	34700	Yes	1,13
5988109	VSM17D040Z03A32XD17L130	40	32	130	50	16,2	3	4.0°	29800	Yes	0,77
5988110	VSM17D040Z03A32XD17L250	40	32	250	50	16,2	3	4.0°	29800	Yes	1,49
5988059	VSM17D040Z04A32XD17L130	40	32	130	50	16,2	4	4.0°	29800	Yes	0,77
5988060	VSM17D040Z04A32XD17L250	40	32	250	50	16,2	4	4.0°	29800	Yes	1,49

NOTE: Standard milling cutters will accept insert nose radii up to 2,0mm without modification.
For tool body modification instructions, see page 34.

VSM17™

Victory™ Shoulder Mills • VSM17 Series

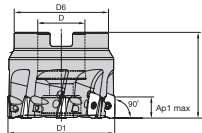

■ Shell Mills

order number	catalogue number	D1	D	D6	L	Ap1 max	Z	max ramp angle	max RPM	coolant supply	kg
5988094	VSM17D040Z04S16XD17	40	16	37	40	16,2	4	4.0°	29800	Yes	0,19
5988095	VSM17D050Z04S22XD17	50	22	45	40	16,1	4	3.0°	25800	Yes	0,28
5988096	VSM17D050Z05S22XD17	50	22	45	40	16,1	5	3.0°	25800	Yes	0,29
5988134	VSM17D050Z06S22XD17	50	22	45	40	16,1	6	3.0°	25800	Yes	0,28
5988097	VSM17D063Z05S22XD17	63	22	50	40	16,0	5	2.1°	22400	Yes	0,45
5988135	VSM17D063Z06S22XD17	63	22	50	40	16,0	6	2.1°	22400	Yes	0,45
5988098	VSM17D080Z06S27XD17	80	27	60	50	15,9	6	1.6°	19500	Yes	0,98
5988133	VSM17D080Z07S27XD17	80	27	60	50	15,9	7	1.6°	19500	Yes	0,96
5988099	VSM17D100Z08S32XD17	100	32	80	50	15,8	8	1.2°	17200	Yes	1,63
5988100	VSM17D125Z09S40XD17	125	40	90	63	15,7	9	.9°	15200	Yes	2,94
5988101	VSM17D160Z12S40XD17	160	40	100	63	15,8	12	.7°	13300	Yes	3,66

NOTE: Standard milling cutters will accept insert nose radii up to 2,0mm without modification.
For tool body modification instructions, see page 34.

■ Spare Parts

D1	insert screw	Nm	wrench
25 - 160	191.725	3,5	170.025

For M4000 cartridge milling system, please see page 35.



VSM17
M4000CA-XDPT17
(MM6152927)



Victory™ Shoulder Mills • VSM17™ Series



Inserts for VSM17 Series

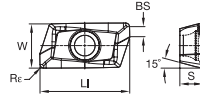

● first choice
○ alternate choice

P	■	■	■	■	○	●	●	○	●
M	■	■	■	■	○	●	●	○	●
K	■	■	■	■	○	●	●	○	●
N	■	■	■	■	○	●	●	○	●
S	■	■	■	■	○	●	●	○	●
H	■	■	■	■	○	●	●	○	●

catalogue number	cutting edges	LI	BS	S	W	Re	hm	WK15CM	WK15PM	WN10HM	WN25PM	WP25PM	WP35CM	WP40PM	WS40PM	WU35PM
XDCT170404PEFRALP	2	19,15	2,62	4,90	9,60	0,40	0,02	■	■	■	○	○	○	○	○	○
XDCT170408PEFRALP	2	19,15	2,22	4,90	9,60	0,80	0,02	■	■	■	○	○	○	○	○	○
XDCT170412PEFRALP	2	19,16	1,82	4,90	9,60	1,20	0,02	■	■	■	○	○	○	○	○	○
XDCT170416PEFRALP	2	19,17	1,42	4,90	9,60	1,60	0,02	■	■	■	○	○	○	○	○	○
XDCT170420PEFRALP	2	19,17	1,01	4,90	9,60	2,00	0,02	■	■	■	○	○	○	○	○	○
XDCT170424PEFRALP	2	19,17	0,63	4,90	9,60	2,40	0,02	■	■	■	○	○	○	○	○	○
XDCT170432PEFRALP	2	18,85	—	4,88	9,59	3,20	0,02	■	■	■	○	○	○	○	○	○
XDCT170440PEFRALP	2	18,33	—	4,87	9,59	4,00	0,02	■	■	■	○	○	○	○	○	○
XDCT170460PEFRALP	2	17,02	—	4,80	9,56	6,00	0,02	■	■	■	○	○	○	○	○	○
XDCT170404PEERML	2	19,15	2,62	4,90	9,60	0,40	0,04	■	■	■	○	○	○	○	○	○
XDCT170408PEERML	2	19,15	2,22	4,90	9,60	0,80	0,04	■	■	■	○	○	○	○	○	○
XDCT170412PEERML	2	19,16	1,82	4,90	9,60	1,20	0,04	■	■	■	○	○	○	○	○	○
XDCT170416PEERML	2	19,17	1,42	4,90	9,60	1,60	0,04	■	■	■	○	○	○	○	○	○
XDCT170420PEERML	2	19,17	1,01	4,90	9,60	2,00	0,04	■	■	■	○	○	○	○	○	○
XDCT170424PEERML	2	19,17	0,63	4,90	9,60	2,40	0,04	■	■	■	○	○	○	○	○	○
XDCT170432PEERML	2	18,85	—	4,89	9,59	3,20	0,04	■	■	■	○	○	○	○	○	○

(continued)

VSM17™

Victory™ Shoulder Mills • VSM17 Series

(Inserts for VSM17 Series — continued)



■ Inserts for VSM17 Series

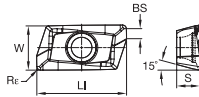

- first choice
- alternate choice

P	■	■	■	■	○	●	○	○
M	■	■	■	■	○	●	○	○
K	■	■	■	■	○	○	○	○
N	■	■	■	■	○	○	○	○
S	■	■	■	■	○	○	○	○
H	■	■	■	■	○	○	○	○

catalogue number	cutting edges	LI	BS	S	W	Rε	hm	WK15CM	WK15PM	WN10HM	WN25PM	WP25PM	WP35CM	WP40PM	WS40PM	WU35PM
XDCT170440PEERML	2	18,33	—	4,87	9,59	4,00	0,04	■	■	■	■	6001239	■	■	6425266	■
XDCT170460PEERML	2	17,02	—	4,80	9,56	6,00	0,04	■	■	■	■	■	■	6118069	6232053	■
XDPT170404PESRMM	2	19,15	2,52	4,90	9,60	0,40	0,10	■	■	■	■	■	■	5987689	■	5987690
XDPT170408PESRMM	2	19,15	2,15	4,90	9,60	0,80	0,10	5987948	6242460	■	■	5987949	5987947	5987946	6180212	5987950
XDPT170412PESRMM	2	19,16	1,77	4,90	9,60	1,20	0,10	5988138	■	■	■	5988151	5988140	5988139	6180213	5988152
XDPT170416PESRMM	2	19,17	1,38	4,90	9,60	1,60	0,10	5988153	■	■	■	5988155	5988156	5988154	6180214	■
XDPT170420PESRMM	2	19,17	0,99	4,90	9,60	2,00	0,10	■	■	■	■	5988158	5988160	5988159	6425145	■
XDPT170424PESRMM	2	19,17	0,62	4,90	9,60	2,40	0,10	■	■	■	■	5988203	■	5988202	6425146	■
XDPT170432PESRMM	2	18,85	—	4,89	9,59	3,20	0,10	■	■	■	■	5988206	5988204	5988205	6277261	■
XDPT170440PESRMM	2	18,33	—	4,87	9,59	4,00	0,10	■	■	■	■	5988970	■	5988969	6425147	■
XDPT170408PESRMH	2	19,15	2,10	4,91	9,60	0,80	0,13	5991817	5989053	■	■	■	5991816	5989054	5991815	5989052
XDPT170412PESRMH	2	19,16	1,73	4,91	9,60	1,20	0,13	■	■	■	■	■	■	6425148	■	■

NOTE: XDCT17: High-precision periphery ground inserts.
XDPT17: Precision-pressed and sintered-to-size inserts.

Victory™ Shoulder Mills • VSM17™ Series

Insert Selection Guide

Material Group	Light Machining		General Purpose		Heavy Machining	
	Geometry	Grade	Geometry	Grade	Geometry	Grade
P1-P2	XDCT-ML	WP40PM	XDPT-MM	WP40PM	XDPT-MH	WP40PM
P3-P4	XDCT-ML	WP40PM	XDPT-MM	WP40PM	XDPT-MH	WP40PM
P5-P6	XDPT-MM	WP25PM	XDPT-MM	WP35CM	XDPT-MH	WP40PM
M1-M2	XDCT-ML	WS40PM	XDPT-MM	WS40PM	XDPT-MM	WS40PM
M3	XDCT-ML	WS40PM	XDPT-MM	WS40PM	XDPT-MH	WS40PM
K1-K2	XDPT-MM	WK15CM	XDPT-MM	WK15CM	XDPT-MH	WK15CM
K3	XDPT-MM	WP35CM	XDPT-MM	WP35CM	XDPT-MH	WP35CM
N1-N2	XDCT-ALP	WN10HM	XDCT-ALP	WN25PM	XDCT-ALP	WN25PM
N3	XDCT-ALP	WN10HM	XDCT-ALP	WN25PM	XDCT-ALP	WN25PM
S1-S2	XDCT-ML	WP25PM	XDPT-MM	WS40PM	XDPT-MM	WS40PM
S3	XDCT-ML	WS40PM	XDPT-MM	WS40PM	XDPT-MM	WS40PM
S4	XDCT-ML	WS40PM	XDPT-MM	WS40PM	XDPT-MM	WS40PM
H1	-	-	-	-	-	-

Recommended Starting Speeds [m/min]*

Material Group		WK15CM			WK15PM			WN10HM			WN25PM			WP25PM			WP35CM			WP40PM			WS40PM			WU35PM		
		P	1	-	-	-	-	-	-	-	-	-	-	-	-	330	285	270	455	395	370	295	260	245	-	-	-	260
	2	-	-	-	-	-	-	-	-	-	-	-	-	275	240	200	280	255	230	250	215	180	-	-	-	220	190	160
	3	-	-	-	-	-	-	-	-	-	-	-	-	255	215	175	255	230	205	230	195	160	-	-	-	200	170	140
	4	-	-	-	-	-	-	-	-	-	-	-	-	225	185	150	190	175	160	205	170	135	-	-	-	180	150	120
	5	-	-	-	-	-	-	-	-	-	-	-	-	185	170	150	260	230	210	170	155	135	170	145	120	150	135	120
	6	-	-	-	-	-	-	-	-	-	-	-	-	165	125	100	160	135	110	150	115	90	150	110	80	130	100	80
M	1	-	-	-	-	-	-	-	-	-	-	-	-	205	180	165	205	185	155	195	170	155	210	170	140	170	150	135
	2	-	-	-	-	-	-	-	-	-	-	-	-	185	160	130	185	160	140	175	150	125	180	145	120	155	130	110
	3	-	-	-	-	-	-	-	-	-	-	-	-	140	120	95	145	130	115	130	115	90	145	110	85	115	100	80
K	1	420	385	340	270	245	215	-	-	-	-	-	-	230	205	185	295	265	240	-	-	-	-	-	-	-	-	-
	2	335	295	275	210	190	175	-	-	-	-	-	-	180	160	150	235	210	190	-	-	-	-	-	-	-	-	-
	3	280	250	230	175	160	145	-	-	-	-	-	-	150	135	120	195	175	160	-	-	-	-	-	-	-	-	-
N	1	-	-	-	-	-	-	795	695	600	1075	945	875	-	-	-	-	-	-	-	-	-	-	-	-	-	-	-
	2	-	-	-	-	-	-	795	695	600	945	875	760	-	-	-	-	-	-	-	-	-	-	-	-	-	-	-
	3	-	-	-	-	-	-	560	485	420	945	875	760	-	-	-	-	-	-	-	-	-	-	-	-	-	-	-
S	1	-	-	-	-	-	-	-	-	-	-	-	-	40	35	25	-	-	-	-	-	-	40	35	25	35	30	25
	2	-	-	-	-	-	-	-	-	-	-	-	-	40	35	25	-	-	-	-	-	-	40	35	25	35	30	25
	3	-	-	-	-	-	-	-	-	-	-	-	-	50	40	25	-	-	-	-	-	-	50	40	25	45	35	25
	4	-	-	-	-	-	-	-	-	-	-	-	-	70	50	35	-	-	-	-	-	-	60	50	30	60	45	30
H	1	-	-	-	-	-	-	-	-	-	-	-	-	120	90	70	-	-	-	-	-	-	-	-	-	-	-	-

NOTE: FIRST choice starting speeds are in **bold** type. As the average chip thickness increases, the speed should be decreased.
 *Material groups P, M, K, and H show recommended starting speeds for dry machining. For wet machining, reduce speed by 20%.
 *Material groups N and S show recommended starting speeds for wet machining. Not recommended for dry machining.

Recommended Starting Feeds [mm]

Light Machining	General Purpose	Heavy Machining
-----------------	-----------------	-----------------

Insert Geometry	Programmed Feed per Tooth (fz) as a % of Radial Depth of Cut (ae)															Insert Geometry
	5%			10%			20%			30%			40-100%			
.F..ALP	0,12	0,23	0,40	0,08	0,17	0,29	0,06	0,13	0,22	0,06	0,11	0,19	0,05	0,10	0,18	.F..ALP
.E..ML	0,16	0,35	0,46	0,12	0,25	0,33	0,09	0,19	0,25	0,08	0,16	0,22	0,07	0,15	0,20	.E..ML
.S..MM	0,16	0,40	0,64	0,12	0,29	0,46	0,09	0,22	0,34	0,08	0,19	0,30	0,07	0,18	0,28	.S..MM
.S..MH	0,23	0,46	0,74	0,17	0,33	0,54	0,13	0,25	0,40	0,11	0,22	0,35	0,10	0,20	0,32	.S..MH

NOTE: Use "Light Machining" values as starting feed rate.

VSM17™

Victory™ Shoulder Mills • VSM17 Series

Best Practices

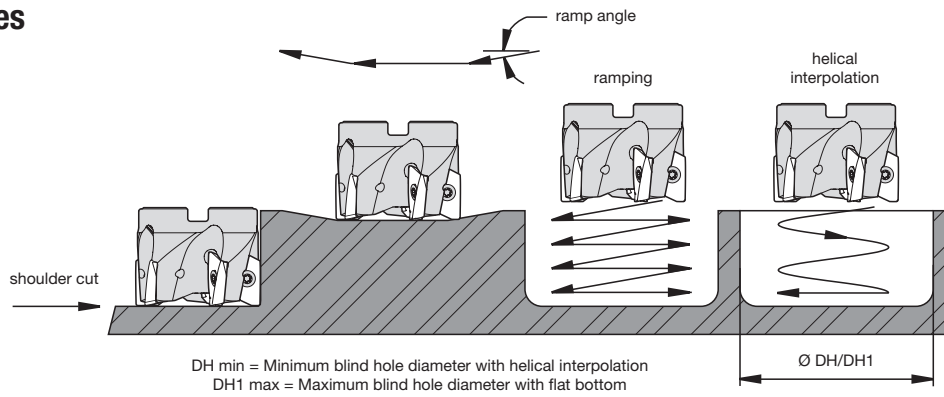

Modification Instructions for Use of Larger Radii Inserts (Shoulder Mills and Helical Mills)

cutting diameter (D1)	max RPM	max ramp angle to steel body interference	max flat-bottom hole diameter (DH1 max)	min hole diameter (DH min)
25	41800	8,8°	50	32
32	34700	5,7°	64	46
40	29800	4,0°	80	62
50	25800	3,0°	100	82
63	22400	2,1°	126	108
80	19500	1,6°	160	142
100	17200	1,2°	200	182
125	15200	0,9°	150	132
160	13300	0,7°	320	302

NOTE: For DH1 max, subtract the insert corner radius from the max hole diameter.

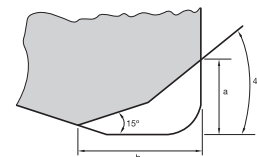

insert corner radius	material to remove	
	a	b
2,4–4,0mm	2	3
4,0–6,0mm	4	5

NOTE: Standard milling cutters will accept insert nose radii up to 2,0mm without modification.

VSM17 Z-Axis Plunging

cutting diameter (D1)	Z max	Y
25	9	24,00
32	9	28,77
40	9	33,41
50	9	38,42
63	9	44,09
80	9	50,56
100	9	57,24
125	9	64,62
160	9	73,73

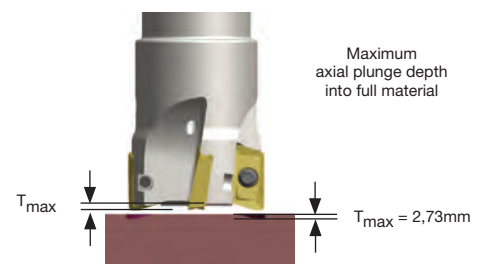
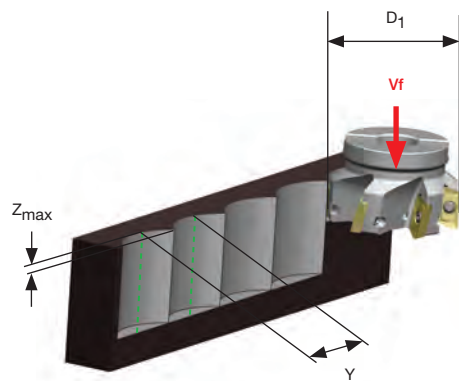

Face Mills • M4000 Series

M4000 Cartridge Milling System

Supporting the latest WIDIA™ 90° shoulder milling technology up to D1 = 315mm.

- Roughing and finishing with a single tool.
- Quick cartridge stop feature.
- Easy runout adjustment.
- Easy change of cartridges with different insert styles and lead angles.



VSM11™

M4000CA-XDPT11
(MM6152926)



VSM17™

M4000CA-XDPT17
(MM6152927)

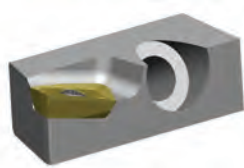

VSM490™-10

M4000CA-XN10
(MM6433216)

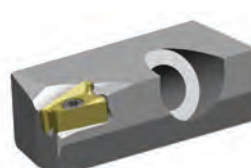

VSM490™-15

M4000CA-XN15
(MM6357989)

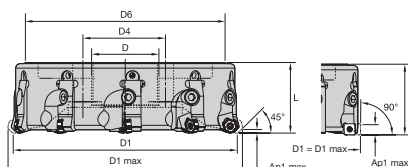
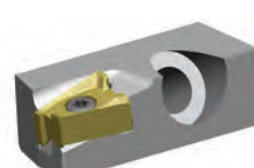

■ Cartridge Milling System

order number	catalogue number	D1	D	D4	D6	L	number of cartridges	max RPM	coolant supply	kg
4136343	M4000D125Z06ADJ	125	40	—	108	68,0	6	2000	No	3,34
4136344	M4000D125Z08ADJ	125	40	—	108	68,0	8	2000	No	3,51
4136345	M4000D160Z08ADJ	160	40	66,7	137	63,0	8	1800	No	5,19
4136346	M4000D160Z12ADJ	160	40	66,7	137	63,0	12	1800	No	5,20
4136347	M4000D200Z10ADJ	200	60	101,6	178	63,0	10	1500	No	8,02
4136348	M4000D200Z14ADJ	200	60	101,6	178	80,0	14	1500	No	12,57
4136349	M4000D250Z12ADJ	250	60	101,6	228	63,0	12	1200	No	13,53
4136350	M4000D250Z18ADJ	250	60	101,6	228	63,0	18	1200	No	13,90
4136351	M4000D315Z16ADJ	315	60	101,6	293	80,0	16	1000	No	25,08
4136352	M4000D315Z22ADJ	315	60	101,6	293	80,0	22	1000	No	25,42

■ Spare Parts

D1	cartridge screw	Nm	wedge	adjusting screw	hex wrench
125 - 315	MS1294	20,0	12748308500	12748600900	MW3

VHSC

True High-Speed Aluminium Profiling
and Pocket Milling Cutter

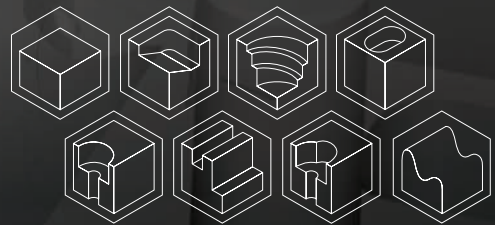



Victory™ High-Speed Cutting

Up to $vc = 3000$ m/min

High-Speed Cutting Cylindrical End Mills: 25–32mm

High-Speed Cutting Monoblocks: 25–50mm

High-Speed Shell Mills: 40–80mm

Proprietary pocket design allows multiple insert radii for one body definition. The insert also maintains axial positioning regardless of the size of the insert corner nose radius.



WIDIA 

widia.com

VHSC

VHSC Victory™ High-Speed Cutting

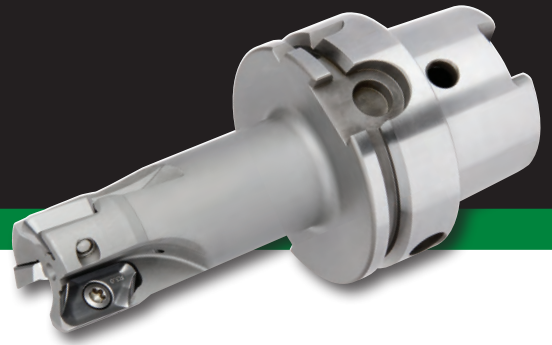

- Developed specifically to achieve true HSC cutting of aluminium components up to 3000 m/min.
- Latest cutter body technology allows for heavy feeding and ramping.
- Flutes and internal coolant channels engineered to support improved chip evacuation.
- Best-in-class solution for thin-walled machining.
- Productivity booster up to 8600 cm³/min MRR.

High-Speed Cutting Inserts XDET-ALP

- First choice for non-ferrous materials.
- Super-positive ALP geometry with polished rake to reduce built-up edge.
- Wear-resistant micro-grain carbide grade.
- Precision periphery ground.

FR-ALP



Sharp cutting edge "F" preparation for roughing and finishing jobs.

ER-ALP



Honed cutting edge "E" preparation for heavy roughing jobs and demanding castings.

Finishing Capabilities/Lower Cutting Forces

Geometry Strengthening

User-friendly Setup Makes a Big Difference

Large Corner Radius

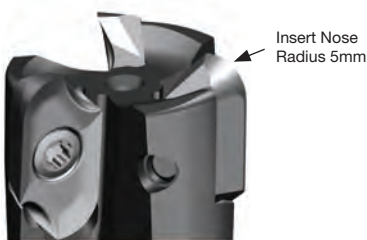

Small Corner Radius

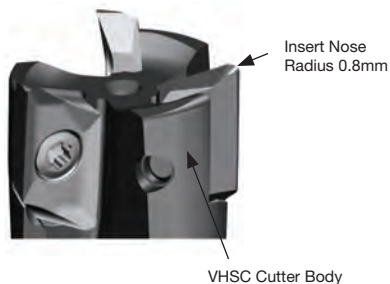

- Unique feature has a great impact on significant cost savings.
- Only one cutter body needed to load inserts with corner nose radii from R0.4 to R6.0 max.
- All other suppliers require modification and rebalance of the cutter body.

Insert Overlay

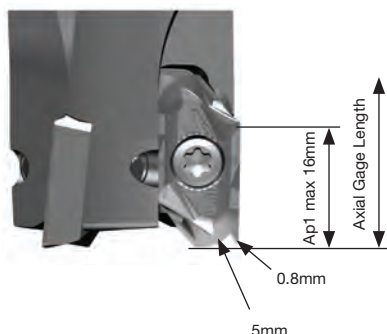

- Axial gage length on the cutter body will always be the same, no matter which insert nose radius is applied.
- Preferred by CNC programmers and operators.
- Ap1 max will always remain 16mm, no matter which insert nose radius is applied.

Victory™ Shoulder Mills • VHSC16

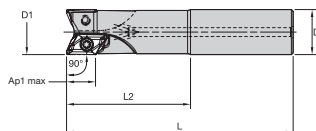

High-Speed Cutting Cylindrical End Mills

order number	catalogue number	D1	D	L	L2	Ap1 max	Z	max ramp angle	max RPM	coolant supply	kg
6425258	VHSC025Z02A25XD16	25	25	131	75	16	2	14.7°	50000	Yes	0,39
6425259	VHSC032Z02A32XD16	32	32	135	75	16	2	11.4°	41500	Yes	0,65
6425260	VHSC032Z03A32XD16	32	32	135	75	16	3	11.4°	41500	Yes	0,65

NOTE: Pre-balanced to G6.3/30000 RPM.

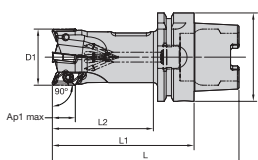

High-Speed Cutting Monoblocks • HSK63A

order number	catalogue number	D1	D	L	L1	L2	Ap1 max	Z	max ramp angle	max RPM	coolant supply	kg
6425447	VHSC025Z02HSK63XD16	25	63	133	101	75	16	2	14.5°	51000	Yes	0,81
6425449	VHSC032Z03HSK63XD16	32	63	133	101	75	16	3	11.4°	41500	Yes	0,91
6425451	VHSC040Z04HSK63XD16	40	63	133	101	75	16	4	7.8°	35000	Yes	1,09
6425453	VHSC050Z04HSK63XD16	50	63	133	101	75	15	4	7.8°	30000	Yes	1,41

NOTE: Pre-Balanced G6.3/30000 RPM.

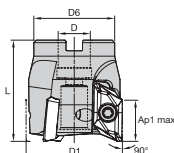

High-Speed Cutting Shell Mills

order number	catalogue number	D1	D	D6	L	Ap1 max	Z	max ramp angle	max RPM	coolant supply	kg
6425291	VHSC040Z03S16XD16	40	16	32	45	16	3	7.6°	35000	Yes	0,20
6425292	VHSC050Z04S22XD16	50	22	45	45	16	4	7.8°	30000	Yes	0,31
6425293	VHSC063Z04S22XD16	63	22	50	45	16	4	5.9°	26000	Yes	0,55
6425294	VHSC080Z05S27XD16	80	27	55	50	16	5	4.4°	22500	Yes	0,89

Spare Parts

D1	insert screw	Nm	Torx driver
25 - 80	DP5009A	6,1	DT20IP

NOTE: It is important to change the screw each time the insert is changed to ensure the highest security. A dynamometric key and the correct insert screw torque value are key for HSC applications. Adjustable torque wrench (order number 6197561) and Torx Plus 20 bit (order number 6205891) may be purchased separately.

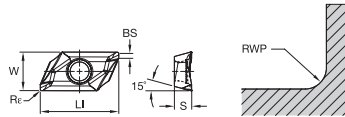

- first choice
- alternate choice

P	■
M	■
K	■
N	●
S	■
H	■

High-Speed Cutting Inserts XDET-ALP

catalogue number	cutting edges	LI	S	W	BS	Rε	RWP*	hm	WN10HM
XDET16M5PDFRALP	2	22,92	5,00	11,25	1,42	0,30	0,30	0,02	6425772
XDET16M504FRALP	2	23,02	5,00	11,25	1,27	0,40	0,40	0,02	6425773
XDET16M508FRALP	2	23,02	5,00	11,25	0,87	0,80	0,80	0,02	6425774
XDET16M520FRALP	2	23,02	5,00	11,25	0,58	2,10	2,00	0,02	6425775
XDET16M530ERALP	2	23,02	5,00	11,25	0,48	3,10	3,00	0,03	6425776
XDET16M530FRALP	2	23,02	5,00	11,25	0,48	3,10	3,00	0,02	6425777
XDET16M540ERALP	2	23,02	5,00	11,25	0,60	4,10	4,00	0,03	6425778
XDET16M540FRALP	2	23,02	5,00	11,25	0,60	4,10	4,00	0,02	6425779
XDET16M550FRALP	2	23,02	5,00	11,25	0,24	5,20	5,00	0,02	6425780

NOTE: RWP* = Resultant workpiece radius.

Insert Selection Guide

Material Group	Light Machining		General Purpose		Heavy Machining	
	Geometry	Grade	Geometry	Grade	Geometry	Grade
N1-N2	.F..ALP	WN10HM	.F..ALP	WN10HM	.E..ALP	WN10HM
N3	.F..ALP	WN10HM	.F..ALP	WN10HM	.E..ALP	WN10HM

Recommended Starting Speeds For Wet Machining [m/min]

Material Group	WN10HM		
	1	2	3
N	2950	1800	875
	2950	1800	875
	1600	850	480

NOTE: FIRST choice starting speeds are in **bold** type.
As the average chip thickness increases, the speed should be decreased.

Victory™ Shoulder Mills • VHSC16

Recommended Starting Feeds [mm]

Light Machining	General Purpose	Heavy Machining
-----------------	-----------------	-----------------

Insert Geometry	Programmed Feed per Tooth (fz) as a % of Radial Depth of Cut (ae)														Insert Geometry	
	5%			10%			20%			30%			40-100%			
.F..ALP	0,12	0,45	0,81	0,08	0,33	0,58	0,06	0,25	0,43	0,06	0,21	0,38	0,05	0,20	0,35	.F..ALP
.E..ALP	0,15	0,50	0,92	0,11	0,36	0,66	0,08	0,27	0,50	0,07	0,24	0,43	0,07	0,22	0,40	.E..ALP

NOTE: Use "Light Machining" values as starting feed rate.

Recommendations for High Speed Machining at 8000 RPM or above

- Check spindle condition:
 - Runout
 - Clamping of the attachment in traction
 - Marking and cleanliness
- Check that the tool is suitable for the required use.
- Inserts must be locked positively in the pocket and secured using the torx screw provided. The screw must be torqued to the correct value as indicated in the charts on the product pages.
- Because of heavy force to the screw, it is important to change the screw when changing the insert.
- Check the balancing of the assembled tool: cutter body, inserts, and attachment.
- Before start up, note the maximum RPM engraved on the tool. The maximum RPM is linked to a precise balancing value.
- Ensure that the field of application of the tool shown in our technical documents and technological parameters is observed:
 - Ae (mm) Width of cut, lateral engagement (radial)
 - ap (mm) Axial depth of cut
 - fz (mm/tooth) mm per tooth
 - n (RPM) Revolutions per minute



WIDIA™ cannot accept responsibility for misuse of this product due to:

- Non-observance of the above instructions
- Machine without casing
- Incorrect clamping of workpieces
- No safety device on the machine
- Any misuse or incorrect clamping

The optimum rotation must be determined by condition of the spindle. The spindle must be rigid to run at these higher RPMs.

Under no circumstances must any attempt be made to repair this tool. The only permitted maintenance is the indexing or replacement of the inserts.

When assembling the cutter to a Shrink Fit holder, the maximum protrusion cannot exceed 10% of the reach of tool.

Balancing:

- Cylindrical shank and HSK63A integral shanks are designed and balanced to G6.3 at 30000 RPM for diameters up to 50mm.
- Cylindrical shank tools mounted in a Shrink Fit holder or any other chuck mill holder + inserts + screws must be re-inspected for balance as an assembly by the end-user when at or exceeding 8000 RPM. End-user must balance the assembly at a G6.3 at 30000 RPM maximum.
- Shell mills are not balanced. These tools must be re-inspected for balance as an assembly, cutter + inserts + screws by the end-user for high speed machining at 8000 RPM or above. End-user must balance the assembly at a G6.3 value minimum.
- Balancing requires removing some material by drilling or milling operations.
- For each new shell mill installed on the same toolholder, re-balance the assembly.

Tighten the bolt between the shell mill and toolholder; with lubricant, apply the torque value of:

Thread sizes (mm)	Cutter Bore Size (mm)	Torque Values Nm
M6	13	10
M8	16	30
M10	22	50
M12	27	80
M16	32	110
M20	40	120

■ Machinability by Materials • Aluminium

Alloy Group	Alloy Designation	Chemical Composition Limits (WT%)												Typical Temper	Rm (Mpa)	Machinability Chip Formation	Machinability
		Cu	Si	Fe	Mn	Mg	Zn	Cr	Ti	Pb	Bi	Al	Others				
Al	1050	0.05	0.25	0.40	0.50	0.05	0.05	-	-	-	-	99.50min	-	H14	105	D	A
	1100	0.05-0.20	Si+Fe 1.00 max	-	0.05	-	0.10	-	-	-	-	99.00min	-	H14	90	D	A
AlCu	2011	5.00-6.00	0.40	0.70	-	-	0.30	-	-	0.20	0.60	remaining	-	T3	310	A	A
	2014	3.90-5.00	0.50-1.20	0.70	0.40-1.20	0.20-0.80	0.25	0.10	0.15	-	-	remaining	-	T6	430	B	A
	2017	3.50-4.50	0.20-0.80	0.70	0.40-1.00	0.40-0.80	0.25	0.10	0.15	-	-	remaining	-	T4	390	B	A
	2024	3.80-4.90	0.50	0.50	0.30-0.90	1.20-1.80	0.25	0.10	0.15	-	-	remaining	-	T4	465	B	A
	2218	3.50-4.50	0.90	1	0.20	1.20-1.80	0.25	0.10	-	-	-	remaining	Ni1.7-2.3	T72	331	B	B
	2224	3.80-4.40	0.12	0.15	0.30-0.90	1.20-1.80	0.25	0.10	0.15	-	-	remaining	-	-	-	A	A
AlMn	3003	0.05-0.20	0.60	0.70	1.00-1.50	-	0.10	-	-	-	-	remaining	-	H14	140	D	B
AlSi	4032	0.50-1.30	11.00-13.50	1	-	0.80-1.30	0.25	0.10	-	-	-	remaining	Ni0.5-1.3	T6	379	B	D
AlMg	5083	0.10	0.40	0.40	0.40-1.00	4.00-4.90	0.25	0.05-0.25	0.15	-	-	remaining	-	H112	335	C	A
AlMgSi	6061	0.15-0.40	0.40-0.80	0.70	0.15	0.80-1.20	0.25	0.04-0.35	0.15	-	-	remaining	-	T6	300	C	B
	6063	0.10	0.20-0.60	0.35	0.10	0.45-0.90	0.10	0.10	0.10	-	-	remaining	-	T5	200	C	B
	6070	0.15-0.40	1.00-1.70	0.50	0.40-1.00	0.50-1.20	0.25	0.10	0.15	-	-	remaining	-	T6	379	C	C
	6151	0.35	0.60-1.20	1	0.20	0.45-0.80	0.25	0.15-0.35	0.15	-	-	remaining	-	T6	-	C	C
	6262	0.15-0.40	0.40-0.80	0.70	0.15	0.80-1.20	0.25	0.04-0.14	0.15	0.40	0.70	remaining	-	T9	400	B	B
	6351	0.10	0.70-1.30	0.50	0.40-0.80	0.40-0.80	0.20	-	0.20	-	-	remaining	-	T6	310	D	C
	6463	0.20	0.20-0.60	0.15	0.05	0.45-0.90	0.05	-	-	-	-	remaining	-	T6	241	C	B
AlZn	7001	1.60-2.60	0.35	0.40	0.20	2.60-3.40	6.80-8.00	0.18-0.35	0.20	-	-	remaining	-	O	-	B	A
	7003	0.20	0.30	0.35	0.30	0.50-1.00	5.00-6.50	0.20	0.20	-	-	remaining	Zr0.05-0.25	T5	400	B	A
	7050	2.00-2.60	0.12	0.15	0.10	1.90-2.60	5.70-6.70	0.04	0.06	-	-	remaining	Zr0.08-0.15	T73	530	B	A
	7075	1.20-2.00	0.40	0.50	0.30	2.10-2.90	5.10-6.10	0.18-0.28	0.20	-	-	remaining	-	T6	570	B	A
	7178	1.60-2.40	0.40	0.50	0.30	2.40-3.10	6.30-7.30	0.18-0.35	0.20	-	-	remaining	-	T6	600	B	A
	7475	1.20-1.90	0.10	0.12	0.06	1.90-2.60	5.20-6.20	0.18-0.25	0.06	-	-	remaining	-	T61	565	B	A

Machinability: A (Excellent), B (Good to Excellent), C (Good), D (Not Good)

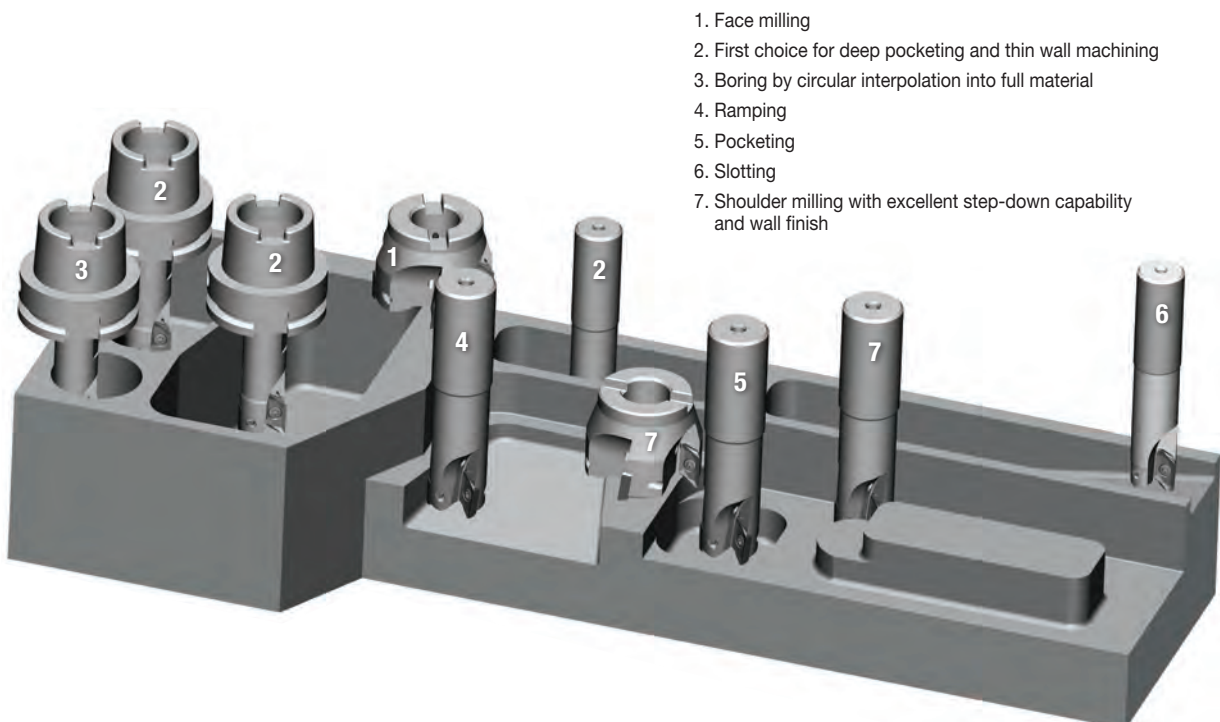

1. Face milling
2. First choice for deep pocketing and thin wall machining
3. Boring by circular interpolation into full material
4. Ramping
5. Pocketing
6. Slotting
7. Shoulder milling with excellent step-down capability and wall finish

Victory™ Shoulder Mills • VHSC16

Best Practices

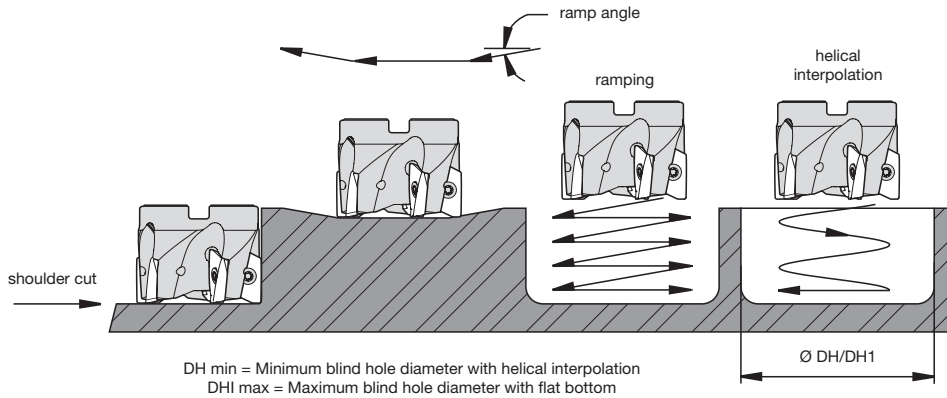

Ramp Angle

cutter diameter	Max. Ramping Angle Related to Insert Corner Nose Radius and Cutter D1						
	Facet	R0.4	R0.8	R2.0	R3.0	R4.0	R5.0
25	14,8°	14,8°	14,8°	9,4°	18,8°	9,0°	11,2°
32	11,4°	11,4°	11,4°	11,9°	12,4°	13,1°	13,8°
40	7,6°	7,6°	7,6°	7,8°	8,1°	8,5°	8,8°
50	7,8°	7,5°	7,8°	7,7°	7,9°	8,4°	8,8°
63	5,8°	5,6°	5,9°	5,7°	5,8°	6,1°	6,3°
80	4,4°	4,2°	4,4°	4,2°	4,3°	4,5°	4,7°

Helical Min. Hole and Helical Max. Hole

cutter diameter	DH min	DH1 max
25	30,3	48,8
32	43,5	62,0
40	59,5	78,0
50	79,5	98,0
63	105,5	124,0
80	139,5	158,0

Ap1 max at Helical Interpolation for 360° Tool Path

cutter diameter	Helical Interpolation depth Ap1 max for 360° tool path
25	4,06
32	4,06
40	4,06
50	4,06
63	4,06
80	4,06

NOTE: Ap max depending on cutter diameter, rigidity of the cutter, rigidity of the machine, and size of the flute.

Ap1 max at Full Slotting

cutting diameter (D1)	Number of inserts Z	Ap1 max
25	2	7,5
32	2	11,0
32	3	6,0
40	3	9,0
50	4	9,0
63	4	11,0
80	5	11,0

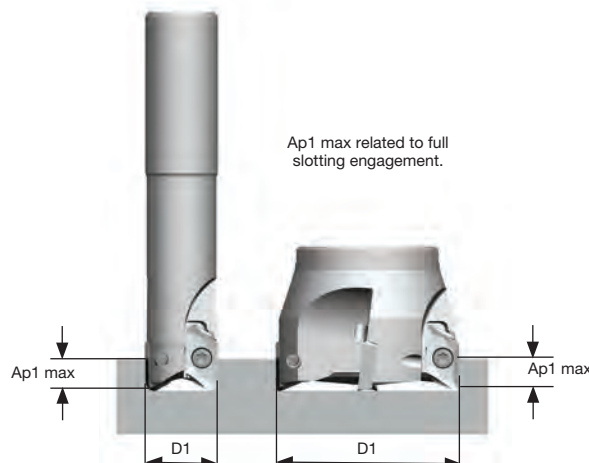

WIDIA-HA



A SOLID FOUNDATION

VariMill™

The original variable pitched geometry end mill that revolutionised the industry.

ArCut™

Propriety geometry is designed for rigidity and improved chip evacuation in roughing and finishing aluminium.

WavCut™

Special wave design for excellent performance in titanium and other aerospace applications.



NITA™

The Story



WIDIA™ remains a leader in aerospace and defense technology. These industries require increasingly complex machining techniques and exotic materials. The WIDIA-Hanita solid end milling product lines have built a strong ongoing reputation of continuous development and modification.

WIDIA™ HANITA 

widia.com

WIDIA-HA



VariMill™ II & III

Advanced 5- and 7-flute geometries for advanced milling jobs in titanium, high-temp alloys, and stainless steels.

X Feed™

High-feed geometry with 6 flutes to reduce manufacturing time in heat-treated steel or titanium.

Roughers

High-performance profile for roughing applications in steel, stainless steel, and high-temp alloys.

Modular

VariMill™ technology meets the Duo-Lock™ connector system.

Pages 48–64



NITA™

The Evolution



WIDIA™ continues to provide advanced geometries that provide solutions for difficult to machine applications in exotic materials and enable customers to improve productivity and lower costs.

See how WIDIA-Hanita™ helped customers reduce cycle times by up to 35% in aerospace engine components.

Jet Engine Bracket	Current Parameters	WIDIA™
Workpiece	—	120mm x 120mm x 60mm
Cycle time	03:22 hours <i>(resulting in capital loss)</i>	01:20 hours
Cost-per-part	\$400	\$250



WIDIA™ HANITA™ 

widia.com

RUNOUT
ACCURACY

MAXIMUM
COUPLING
STABILITY

LENGTH
REPEATABILITY

MODUL

VariMill™ Technology Meets
DUO-LOCK® Connection

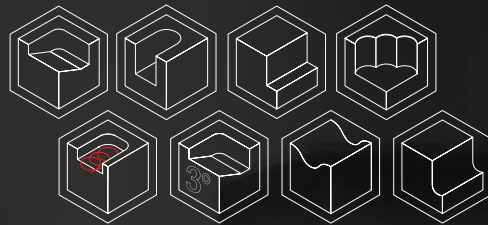



VariMill™ Modular

Cutting data and tool life comparable to high-performance solid carbide.

Proprietary VariMill geometries allow roughing and finishing with one tool.

1,5 x D standard cutting edge length allows for less passes.

Up to 1 x D full slotting increases Metal Removal Rates (MRR) and productivity significantly.

AR



Adaptors

Extensive straight and conical shanks, as well as an integral adaptor offering, including CV, PSC, BT, and HSK.



High-Performance Modular Solid Carbide End Mills

VariMill Modular combines highest runout accuracy and length repeatability with maximum coupling stability. This allows the VariMill Modular system to utilise the full potential of WIDIA™ VariMill cutting geometries and WIDIA Victory™ grades. The flexible VariMill Modular system targets applications like solid carbide end mills.

A wide range of diameters between 10–32mm and multiple corner configurations, such as sharp chamfer and radii, are available from stock.

Increased productivity enabled by the strength of Duo-Lock™ by Haimer and WIDIA connection system.

WIDIA 

widia.com

Modular End Mills

High-Performance Modular Solid Carbide End Mills

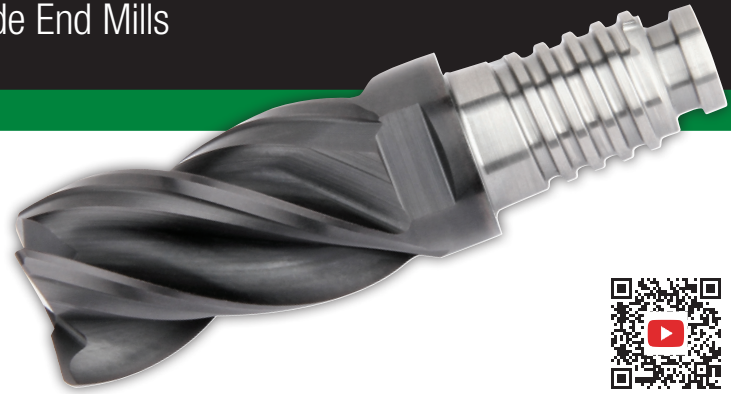

- High-performance geometries provide highest Metal Removal Rates (MRR).
- Unequal flute spacing reduces vibrations and improves surface finish.
- Intelligent thread ensures stress levels remain below critical values.
- Third-contact surface delivers high stiffness and highest accuracy below 5µm runout.



See me in action!

VariMill™ Modular Series

- Less cutting forces and pressure on cutting edge through tailored axial and radial rake angles.
- Proprietary tapered core provides highest tool stability in roughing and finishing operations.
- Eccentric relief design increases tool life through higher edge stability.



4X47 VariMill Series

- 4 flute.
- New asymmetrical fluting geometry.
- High metal removal rates and tool life in:
 - Stainless steels, steels, and alloyed steels.
 - High-temperature alloys and titanium.



5747 VariMill II™ Series

- 5 flute.
- High metal removal rates and tool life in:
 - Stainless steels, steels, and alloyed steels.
 - Cast iron.
 - High-temperature alloys and titanium.



4547 & 4548 High-Performance Finishing

- Multi-flute finishers.
- Radius corner.
- High metal removal rates and tool life in:
 - Stainless steels and steels.



4U40 High-Performance Roughing 45°

- Multi-flute roughers.
- Radius corner.
- High-temperature geometries.



4969 High-Performance Ball-Nose Roughing

- 4 Flute ball-nose rougher.
- Steel and stainless steel geometries.



4946 High-Performance Roughing 20°

- Multi-flute roughers.
- Chamfer corner.
- Steel and stainless steel geometries.



4XN0 VariMill Series

- 4 flute.
- Stainless steel and steel geometry design.
- Centre cutting ball nose.



4X48 VariMill Series

- 4 flute.
- New asymmetrical fluting geometry.
- Titanium geometry design.
- Extensive radii corner offering.



5748 VariMill II ER Series

- 5 flute.
- Titanium geometry design.
- Eccentric relief for edge stability and strength.
- Extensive radii corner offering.



774E VariMill III™ ER Series

- 7 flute.
- Titanium geometry design.
- Eccentric relief for edge stability and strength.
- Extensive radii corner offering.



5142 & 5143 — AluSurf™

- 2- and 3-flute finishers.
- Radius corner.
- Aluminium geometries.



8045 — Corner Rounding

- 4 flute.
- Corner rounding.



8046 — Corner Chamfering

- Multi-flute roughers.
- Chamfer corner.

High-Performance DUO-λOCK® Modular End Mills • VariMill™

■ 4X47 • 4X48 • 4 Flute • 38° Helix • Metric

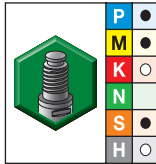
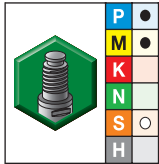

● first choice
○ alternate choice

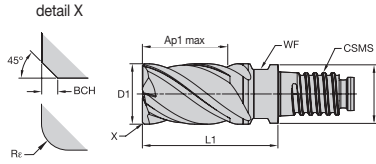

order #	order #	D1	D	length of cut Ap1 max	L1	CSMS system size	WF	BCH	Re
6071019	—	10,0	9,60	15,00	23	DL10	8,00	0,50	—
—	6071095	10,0	9,60	15,00	23	DL10	8,00	—	0,50
—	6071096	10,0	9,60	15,00	23	DL10	8,00	—	1,00
—	6071097	10,0	9,60	15,00	23	DL10	8,00	—	2,00
6071020	—	12,0	11,50	18,00	27	DL12	9,50	0,50	—
—	6071098	12,0	11,50	18,00	27	DL12	9,50	—	0,50
—	6071099	12,0	11,50	18,00	27	DL12	9,50	—	1,00
—	6071100	12,0	11,50	18,00	27	DL12	9,50	—	2,00
6071091	—	16,0	15,50	24,00	36	DL16	13,00	0,50	—
—	6071111	16,0	15,50	24,00	36	DL16	13,00	—	1,00
—	6071112	16,0	15,50	24,00	36	DL16	13,00	—	2,00
—	6071113	16,0	15,50	24,00	36	DL16	13,00	—	3,00
6071092	—	20,0	19,30	30,00	45	DL20	16,00	0,50	—
—	6071114	20,0	19,30	30,00	45	DL20	16,00	—	1,00
—	6071115	20,0	19,30	30,00	45	DL20	16,00	—	2,00
—	6071116	20,0	19,30	30,00	45	DL20	16,00	—	3,00
—	6071117	20,0	19,30	30,00	45	DL20	16,00	—	4,00
6071093	—	25,0	24,00	37,50	57	DL25	21,00	0,50	—
—	6071118	25,0	24,00	37,50	57	DL25	21,00	—	1,00
—	6071119	25,0	24,00	37,50	57	DL25	21,00	—	2,00
—	6071120	25,0	24,00	37,50	57	DL25	21,00	—	3,00
—	6071121	25,0	24,00	37,50	57	DL25	21,00	—	4,00
6071094	—	32,0	31,00	48,00	72	DL32	28,00	0,50	—
—	6071122	32,0	31,00	48,00	72	DL32	28,00	—	2,00
—	6071123	32,0	31,00	48,00	72	DL32	28,00	—	3,00

NOTE: For application data, please see page 58.

End Mill Tolerances

D1	tolerance e8
> 10-18	-0,032/-0,059
> 18-30	-0,040/-0,073
> 30	-0,050/-0,089

Modular End Mills

High-Performance DUO-LOCK® Modular End Mills • VariMill™

■ 5747 • 5748 • 5 Flute • 38° Helix • Metric

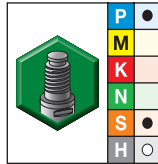
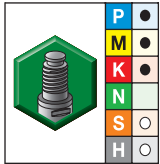

● first choice
○ alternate choice

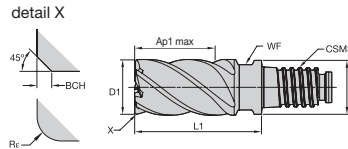

WIDIA HANITA

		D1	D	length of cut Ap1 max	L1	CSMS system size	WF	BCH	Rε
5747 grade WP15PE AITiN	5748 grade WS15PE AITiN								
order #	order #								
6071260	—	10,0	9,60	15,00	23	DL10	8,00	0,50	—
—	6071366	10,0	9,60	15,00	23	DL10	8,00	—	0,50
—	6071367	10,0	9,60	15,00	23	DL10	8,00	—	1,00
—	6071368	10,0	9,60	15,00	23	DL10	8,00	—	2,00
6071361	—	12,0	11,50	18,00	27	DL12	9,50	0,50	—
—	6071369	12,0	11,50	18,00	27	DL12	9,50	—	0,50
—	6071370	12,0	11,50	18,00	27	DL12	9,50	—	1,00
—	6071371	12,0	11,50	18,00	27	DL12	9,50	—	2,00
6071362	—	16,0	15,50	24,00	36	DL16	13,00	0,50	—
—	6071372	16,0	15,50	24,00	36	DL16	13,00	—	1,00
—	6071373	16,0	15,50	24,00	36	DL16	13,00	—	2,00
—	6071374	16,0	15,50	24,00	36	DL16	13,00	—	3,00
6071363	—	20,0	19,30	30,00	45	DL20	16,00	0,50	—
—	6071375	20,0	19,30	30,00	45	DL20	16,00	—	1,00
—	6071376	20,0	19,30	30,00	45	DL20	16,00	—	2,00
—	6071377	20,0	19,30	30,00	45	DL20	16,00	—	3,00
—	6071378	20,0	19,30	30,00	45	DL20	16,00	—	4,00
6071364	—	25,0	24,00	37,50	57	DL25	21,00	0,50	—
—	6071379	25,0	24,00	37,50	56	DL25	21,00	—	1,00
—	6071380	25,0	24,00	37,50	56	DL25	21,00	—	2,00
—	6071391	25,0	24,00	37,50	56	DL25	21,00	—	3,00
—	6071392	25,0	24,00	37,50	56	DL25	21,00	—	4,00
6071365	—	32,0	31,00	48,00	72	DL32	28,00	0,50	—
—	6071393	32,0	31,00	48,00	72	DL32	28,00	—	2,00
—	6071394	32,0	31,00	48,00	72	DL32	28,00	—	3,00

NOTE: For application data, please see page 58.

End Mill Tolerances

D1	tolerance e8
> 10–18	-0,032/-0,059
> 18–30	-0,040/-0,073
> 30	-0,050/-0,089

High-Performance DUO-λOCK® Modular End Mills • VariMill™

■ 774E • 7 Flute with Eccentric Relief Grind • 38° Helix • Metric

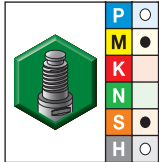

- first choice
- alternate choice

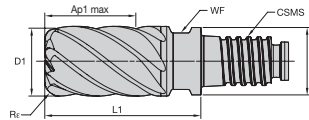

grade WS15PE
AlTiN

order #	D1	D	length of cut Ap1 max	L1	CSMS system size	WF	Re
6071475	10,0	9,60	15,00	23	DL10	8,00	0,50
6071476	10,0	9,60	15,00	23	DL10	8,00	1,00
6071477	10,0	9,60	15,00	23	DL10	8,00	2,00
6071478	12,0	11,50	18,00	27	DL12	9,50	0,50
6071479	12,0	11,50	18,00	27	DL12	9,50	1,00
6071480	12,0	11,50	18,00	27	DL12	9,50	2,00
6071521	16,0	15,50	24,00	36	DL16	13,00	1,00
6071522	16,0	15,50	24,00	36	DL16	13,00	2,00
6071523	16,0	15,50	24,00	36	DL16	13,00	3,00
6071524	20,0	19,30	30,00	45	DL20	16,00	1,00
6071525	20,0	19,30	30,00	45	DL20	16,00	2,00
6071526	20,0	19,30	30,00	45	DL20	16,00	3,00
6071527	20,0	19,30	30,00	45	DL20	16,00	4,00
6071528	25,0	24,00	37,50	57	DL25	21,00	1,00
6071529	25,0	24,00	37,50	57	DL25	21,00	2,00
6071530	25,0	24,00	37,50	57	DL25	21,00	3,00
6071531	25,0	24,00	37,50	57	DL25	21,00	4,00
6071532	32,0	31,00	48,00	72	DL32	28,00	2,00
6071533	32,0	31,00	48,00	72	DL32	28,00	3,00

NOTE: For application data, please see page 59.

■ 4XN0 • 4-Flute Ball Nose • 38° Helix • Metric

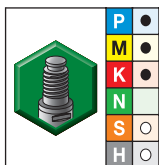

- first choice
- alternate choice

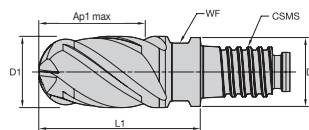

grade WP15PE
AlTiN

order #	D1	D	length of cut Ap1 max	L1	CSMS system size	WF
6071128	10,0	9,60	15,00	23	DL10	8,00
6071130	12,0	11,50	18,00	27	DL12	9,50
6071151	16,0	15,50	24,00	36	DL16	13,00
6071152	20,0	19,30	30,00	45	DL20	16,00
6071153	25,0	24,00	37,50	57	DL25	21,00

NOTE: For application data, please see page 60.

End Mill Tolerances

D1	tolerance e8
> 10-18	-0,032/-0,059
> 18-30	-0,040/-0,073
> 30	-0,050/-0,089

Modular End Mills

High-Performance DUO-LOCK® Modular End Mills • Finishing/Roughing

■ 4547 • Multi-Flute Finisher • 45° Helix • Metric

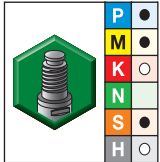

- first choice
- alternate choice

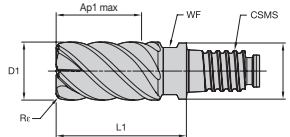

WIDIA HANITA

grade WP15PE
AITiN

order #	D1	D	length of cut Ap1 max	L1	CSMS system size	WF	Re	Z U
6127193	10,0	9,60	15,00	23	DL10	8,00	0,50	6
6127194	12,0	11,50	18,00	27	DL12	9,50	0,75	6
6127195	16,0	15,50	24,00	36	DL16	13,00	0,75	6
6127196	20,0	19,30	30,00	45	DL20	16,00	0,75	6
6127197	25,0	24,00	37,50	57	DL25	21,00	0,75	6

NOTE: For application data, please see page 60.

For more information on the 4548 series, visit widia.com or widia.com/novo.

End Mill Tolerances

D1	tolerance e8
> 10-18	-0,032/-0,059
> 18-30	-0,040/-0,073
> 30	-0,050/-0,089

■ 4946 • High-Performance Roughing • 20° Helix • Metric

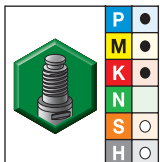

- first choice
- alternate choice

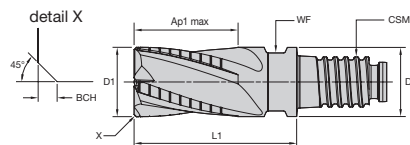

WIDIA HANITA

grade WP15PE
AITiN

order #	D1	D	length of cut Ap1 max	L1	CSMS system size	WF	BCH	Z U
6127281	10,0	9,60	15,00	23	DL10	8,00	0,50	4
6127282	12,0	11,50	18,00	27	DL12	9,50	0,50	4
6127283	16,0	15,50	24,00	36	DL16	13,00	0,50	4
6127284	20,0	19,30	30,00	45	DL20	16,00	0,50	4
6127285	25,0	24,00	37,50	57	DL25	21,00	0,50	5

NOTE: For application data, please see page 61.

End Mill Tolerances

D1	tolerance d11
> 10-18	-0,050/-0,160
> 18-30	-0,065/-0,195

High-Performance DUO-LOCK® Modular End Mills • Roughing

■ 4969 • Ball-Nose Roughing • 20° Helix • Metric

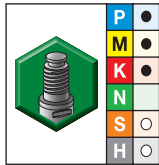

- first choice
- alternate choice

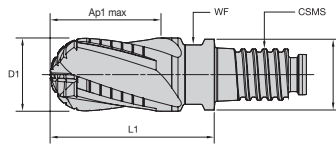

grade WP15PE
AlTiN

order #	D1	D	length of cut Ap1 max	L1	CSMS system size	WF	Z U
6126824	10,0	9,60	15,00	23	DL10	8,00	4
6126825	12,0	11,50	18,00	27	DL12	9,50	4
6126826	16,0	15,50	24,00	36	DL16	13,00	4
6126827	20,0	19,30	30,00	45	DL20	16,00	4
6126828	25,0	24,00	37,50	57	DL25	21,00	4

NOTE: For application data, please see page 61.

End Mill Tolerances

D1	tolerance d11
> 10-18	-0,050/-0,160
> 18-30	-0,065/-0,195

■ 4U40 • Roughing • 45° Helix • Metric

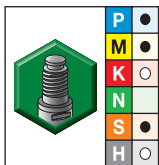

- first choice
- alternate choice

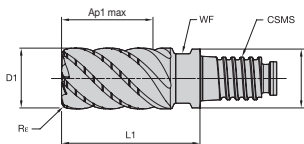

grade WS15PE
AlTiN

order #	D1	D	length of cut Ap1 max	L1	CSMS system size	WF	Re	Z U
6126560	10,0	9,60	15,00	23	DL10	8,00	0,50	4
6126721	12,0	11,50	18,00	27	DL12	9,50	0,75	4
6126722	16,0	15,50	24,00	36	DL16	13,00	0,75	6
6126723	20,0	19,30	30,00	45	DL20	16,00	0,75	6
6126724	25,0	24,00	37,50	57	DL25	21,00	0,75	6

NOTE: For application data, please see page 62.

End Mill Tolerances

D1	tolerance e8
> 10-18	-0,032/-0,059
> 18-30	-0,040/-0,073
> 30	-0,050/-0,089

Modular End Mills

High-Performance DUO-LOCK® Modular End Mills • AluSurf™

■ AluSurf • 5142 • 2 Flute • 45° Helix • Aluminium

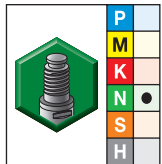

- first choice
- alternate choice

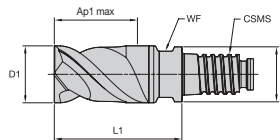

WIDIA HANITA

grade UNCOATED

order #	D1	D	length of cut Ap1 max	L1	CSMS system size	WF
6151048	10,0	9,60	15,00	23	DL10	8,00
6151049	12,0	11,50	18,00	27	DL12	9,50
6151050	16,0	15,50	24,00	36	DL16	13,00
6151061	20,0	19,30	30,00	45	DL20	16,00

NOTE: For application data, please see page 62.

■ AluSurf • 5143 • 3 Flute • 38° Helix • Aluminium

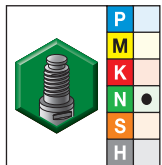

- first choice
- alternate choice

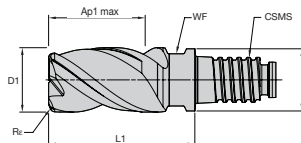

WIDIA HANITA

grade UNCOATED

order #	D1	D	length of cut Ap1 max	L1	CSMS system size	WF	Rε
6150886	10,0	9,60	15,00	23	DL10	8,00	0,50
6150887	10,0	9,60	15,00	23	DL10	8,00	1,00
6150888	10,0	9,60	15,00	23	DL10	8,00	2,00
6150889	12,0	11,50	17,50	27	DL12	9,50	0,50
6150890	12,0	11,50	18,00	27	DL12	9,50	1,00
6151011	12,0	11,50	18,00	27	DL12	9,50	2,00
6151013	16,0	15,50	24,00	36	DL16	13,00	1,00
6151014	16,0	15,50	24,00	36	DL16	13,00	2,00
6151015	16,0	15,50	24,00	36	DL16	13,00	3,00
6151016	20,0	19,30	30,00	45	DL20	16,00	1,00
6151017	20,0	19,30	30,00	45	DL20	16,00	2,00
6151018	20,0	19,30	30,00	45	DL20	16,00	3,00
6151019	20,0	19,30	30,00	45	DL20	16,00	4,00
6151020	25,0	24,00	37,50	57	DL25	21,00	1,00
6151021	25,0	24,00	37,50	57	DL25	21,00	2,00
6151022	25,0	24,00	37,50	57	DL25	21,00	3,00
6151024	25,0	24,00	37,50	57	DL25	21,00	4,00

NOTE: For application data, please see page 62.

End Mill Tolerances

D1	tolerance e8
> 10-18	-0,032/-0,059
> 18-30	-0,040/-0,073
> 30	-0,050/-0,089

High-Performance DUO-LOCK® Modular End Mills • Corner Rounding/Chamfering

■ 8045 • Corner Rounding

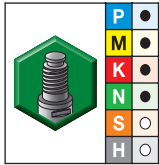

● first choice
○ alternate choice

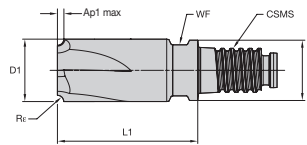

grade WP15PE
AlTiN

order #	D1	D	length of cut Ap1 max	L1	CSMS system size	WF	R _ε	Z U
6127354	10,0	9,60	1,50	23	DL10	8,00	1,50	4
6127355	10,0	9,60	3,00	23	DL10	8,00	3,00	4
6127356	12,0	11,50	1,00	27	DL12	9,50	1,00	4
6127357	12,0	11,50	2,00	27	DL12	9,50	2,00	4
6127358	12,0	11,50	3,00	27	DL12	9,50	3,00	4
6127359	16,0	15,50	2,00	36	DL16	13,00	2,00	4
6127360	16,0	15,50	3,00	36	DL16	13,00	3,00	4
6127381	16,0	15,50	4,00	36	DL16	13,00	4,00	4

NOTE: For application data, please see page 63.

■ 8046 • Chamfering

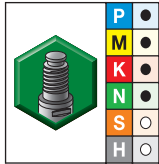

● first choice
○ alternate choice

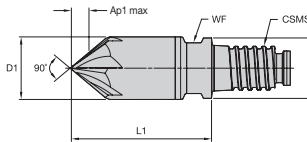

grade WP15PE
AlTiN

order #	D1	D	length of cut Ap1 max	L1	CSMS system size	WF	BCH	Z U
6127401	10,0	9,60	2,00	23	DL10	8,00	2,00	4
6127402	12,0	11,50	3,00	27	DL12	9,50	3,00	5
6127403	16,0	15,50	4,00	36	DL16	13,00	4,00	6

NOTE: For application data, please see page 63.

End Mill Tolerances

D1	tolerance e8
> 10-18	-0,032/-0,059
> 18-30	-0,040/-0,073
> 30	-0,050/-0,089

DUO-LOCK® Accessories

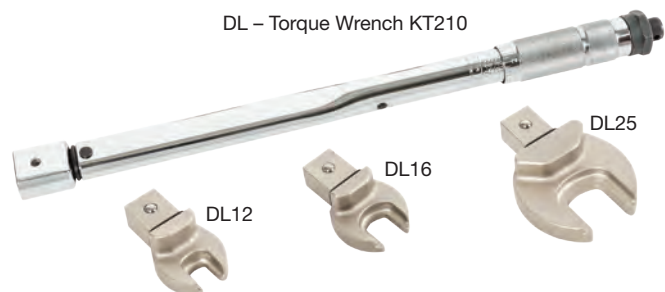

■ Torque Wrench

order number	catalogue number	description	quantity
6390382	DL - Torque Wrench KT210	Only Wrench 30-130 Nm	10
6390561	DL - 12 Key	Only Key 30 Nm	20
6390562	DL - 16 Key	Only Key 60 Nm	20
6390563	DL - 20 Key	Only Key 80 Nm	10
6390564	DL - 25 Key	Only Key 100 Nm	10
6390565	DL - 32 Key	Only Key 130 Nm	10
6390566	DL10 - Torque Wrench + Key	Wrench + Key 25 Nm	5

NOTE: Combine basic Duo-Lock™ wrench with selected torque wrench inserts needed.

Modular End Mills

High-Performance DUO-LOCK® Modular End Mills • VariMill™

■ VariMill™ • 4X47 • 4X48 • Asymmetrical Flute Spacing

Material Group												Recommended feed per tooth (fz = mm/th) for side milling (A). For slotting (B), reduce fz by 20%.								
	Side Milling (A) and Slotting (B)			short			medium			long			D1 – Diameter							
	A	B	adaptor reach																	
			WP15PE WS15PE			WP15PE WS15PE			WP15PE WS15PE											
	ap		ae	ap		Cutting Speed – vc m/min		Cutting Speed – vc m/min		Cutting Speed – vc m/min		mm	10,0	12,0	16,0	20,0	25,0	32,0		
P	0	1,5 x D	0,5 x D	1 x D	150	–	200	135	–	180	135	–	180	fz	0,061	0,070	0,086	0,097	0,105	0,106
	1	1,5 x D	0,5 x D	1 x D	150	–	200	135	–	180	135	–	180	fz	0,061	0,070	0,086	0,097	0,105	0,106
	2	1,5 x D	0,5 x D	1 x D	140	–	190	126	–	171	126	–	171	fz	0,061	0,070	0,086	0,097	0,105	0,106
	3	1,5 x D	0,5 x D	1 x D	120	–	160	108	–	144	108	–	144	fz	0,051	0,060	0,074	0,086	0,097	0,105
	4	1,5 x D	0,5 x D	0,75 x D	90	–	150	81	–	135	81	–	135	fz	0,046	0,053	0,065	0,075	0,083	0,087
	5	1,5 x D	0,5 x D	1 x D	60	–	100	51	–	85	48	–	80	fz	0,041	0,048	0,059	0,069	0,077	0,084
M	6	1,5 x D	0,5 x D	0,75 x D	50	–	75	42	–	64	40	–	60	fz	0,034	0,040	0,048	0,055	0,060	0,062
	1	1,5 x D	0,5 x D	1 x D	90	–	115	72	–	92	63	–	80	fz	0,051	0,060	0,074	0,086	0,097	0,105
	2	1,5 x D	0,5 x D	1 x D	60	–	80	48	–	64	42	–	56	fz	0,041	0,048	0,059	0,069	0,077	0,084
K	3	1,5 x D	0,5 x D	1 x D	60	–	70	48	–	56	42	–	49	fz	0,034	0,040	0,048	0,055	0,060	0,062
	1	1,5 x D	0,5 x D	1 x D	120	–	150	108	–	135	108	–	135	fz	0,061	0,070	0,086	0,097	0,105	0,106
	2	1,5 x D	0,5 x D	1 x D	110	–	140	99	–	126	99	–	126	fz	0,051	0,060	0,074	0,086	0,097	0,105
S	3	1,5 x D	0,5 x D	1 x D	110	–	130	99	–	117	99	–	117	fz	0,041	0,048	0,059	0,069	0,077	0,084
	1	1,5 x D	0,3 x D	0,3 x D	50	–	90	40	–	72	30	–	54	fz	0,051	0,060	0,074	0,086	0,097	0,105
	2	1,5 x D	0,3 x D	0,3 x D	25	–	40	20	–	32	15	–	24	fz	0,027	0,032	0,039	0,046	0,052	0,057
	3	1,5 x D	0,5 x D	1 x D	60	–	80	48	–	64	36	–	48	fz	0,041	0,048	0,059	0,069	0,077	0,084
H	4	1,5 x D	0,5 x D	1 x D	50	–	60	40	–	48	30	–	36	fz	0,038	0,044	0,055	0,063	0,071	0,077
	1	1,5 x D	0,5 x D	0,75 x D	80	–	140	64	–	112	48	–	84	fz	0,046	0,053	0,065	0,075	0,083	0,087
	2	1,5 x D	0,2 x D	0,5 x D	70	–	120	56	–	96	42	–	72	fz	0,034	0,040	0,048	0,055	0,060	0,062



■ VariMill II™ • 5747 • 5748 • Unequal Flute Spacing

Material Group												Recommended feed per tooth (fz = mm/th) for side milling (A). For slotting (B), reduce fz by 20%.								
	Side Milling (A) and Slotting (B)			short			medium			long			D1 – Diameter							
	A	B	adaptor reach																	
			WP15PE WS15PE			WP15PE WS15PE			WP15PE WS15PE											
	ap		ae	ap		Cutting Speed – vc m/min		Cutting Speed – vc m/min		Cutting Speed – vc m/min		mm	10,0	12,0	16,0	20,0	25,0	32,0		
P	0	1,5 x D	0,5 x D	1 x D	150	–	200	135	–	180	135	–	180	fz	0,061	0,070	0,086	0,097	0,105	0,106
	1	1,5 x D	0,5 x D	1 x D	150	–	200	135	–	180	135	–	180	fz	0,061	0,070	0,086	0,097	0,105	0,106
	2	1,5 x D	0,5 x D	1 x D	140	–	190	126	–	171	126	–	171	fz	0,061	0,070	0,086	0,097	0,105	0,106
	3	1,5 x D	0,5 x D	1 x D	120	–	160	108	–	144	108	–	144	fz	0,051	0,060	0,074	0,086	0,097	0,105
	4	1,5 x D	0,5 x D	0,75 x D	90	–	150	81	–	135	81	–	135	fz	0,046	0,053	0,065	0,075	0,083	0,087
	5	1,5 x D	0,5 x D	1 x D	60	–	100	51	–	85	48	–	80	fz	0,041	0,048	0,059	0,069	0,077	0,084
M	6	1,5 x D	0,5 x D	0,75 x D	50	–	75	42	–	64	40	–	60	fz	0,034	0,040	0,048	0,055	0,060	0,062
	1	1,5 x D	0,5 x D	1 x D	90	–	115	72	–	92	63	–	80	fz	0,051	0,060	0,074	0,086	0,097	0,105
	2	1,5 x D	0,5 x D	1 x D	60	–	80	48	–	64	42	–	56	fz	0,041	0,048	0,059	0,069	0,077	0,084
K	3	1,5 x D	0,5 x D	1 x D	60	–	70	48	–	56	42	–	49	fz	0,034	0,040	0,048	0,055	0,060	0,062
	1	1,5 x D	0,5 x D	1 x D	120	–	150	108	–	135	108	–	135	fz	0,061	0,070	0,086	0,097	0,105	0,106
	2	1,5 x D	0,5 x D	1 x D	110	–	140	99	–	126	99	–	126	fz	0,051	0,060	0,074	0,086	0,097	0,105
S	3	1,5 x D	0,5 x D	1 x D	110	–	130	99	–	117	99	–	117	fz	0,041	0,048	0,059	0,069	0,077	0,084
	1	1,5 x D	0,3 x D	0,3 x D	50	–	90	40	–	72	30	–	54	fz	0,051	0,060	0,074	0,086	0,097	0,105
	2	1,5 x D	0,3 x D	0,3 x D	25	–	40	20	–	32	15	–	24	fz	0,027	0,032	0,039	0,046	0,052	0,057
	3	1,5 x D	0,5 x D	1 x D	60	–	80	48	–	64	36	–	48	fz	0,041	0,048	0,059	0,069	0,077	0,084
H	4	1,5 x D	0,5 x D	1 x D	50	–	60	40	–	48	30	–	36	fz	0,038	0,044	0,055	0,063	0,071	0,077
	1	1,5 x D	0,5 x D	0,75 x D	80	–	140	64	–	112	48	–	84	fz	0,046	0,053	0,065	0,075	0,083	0,087
	2	1,5 x D	0,2 x D	0,5 x D	70	–	120	56	–	96	42	–	72	fz	0,034	0,040	0,048	0,055	0,060	0,062



NOTE: Lower value of cutting speed is used for high stock removal applications or for higher hardness (machinability) within group.
 Higher value of cutting speed is used for finishing applications or for lower hardness (machinability) within group.
 Above parameters are based on ideal conditions. For smaller taper machining centres, please adjust parameters accordingly on diameters >12mm.
 For side milling with ap larger than 1 x D, reduce fz by 20%!

High-Performance DUO-λOCK® Modular End Mills • VariMill™ Roughing/Finishing

■ VariMill III™ • 774E • Unequal Flute Spacing • Roughing

Material Group													Recommended feed per tooth (fz = mm/th) for side milling (A).						
	Side Milling (A)		short		medium			long			D1 – Diameter								
	A		adaptor reach														D1 – Diameter		
			WS15PE		WS15PE			WS15PE			mm 10,0 12,0 16,0 20,0 25,0 32,0								
	ap	ae	Cutting Speed – vc m/min		Cutting Speed – vc m/min			Cutting Speed – vc m/min											
P	4	Ap max	0,3 x D	90	–	150	81	–	135	81	–	135	fz	0,043	0,050	0,061	0,070	0,078	0,082
	5	Ap max	0,3 x D	60	–	100	51	–	85	48	–	80	fz	0,039	0,045	0,056	0,065	0,073	0,079
M	1	Ap max	0,3 x D	90	–	115	72	–	92	63	–	80,5	fz	0,048	0,056	0,070	0,081	0,091	0,099
	2	Ap max	0,3 x D	60	–	80	48	–	64	42	–	56	fz	0,039	0,045	0,056	0,065	0,073	0,079
S	3	Ap max	0,3 x D	60	–	70	48	–	56	42	–	49	fz	0,032	0,037	0,046	0,052	0,057	0,058
	1	Ap max	0,3 x D	50	–	90	40	–	72	30	–	54	fz	0,048	0,056	0,070	0,081	0,091	0,099
	2	Ap max	0,3 x D	25	–	40	20	–	32	15	–	24	fz	0,026	0,030	0,037	0,043	0,049	0,054
	3	Ap max	0,3 x D	60	–	80	48	–	64	36	–	48	fz	0,039	0,045	0,056	0,065	0,073	0,079
H	4	Ap max	0,3 x D	50	–	60	40	–	48	30	–	36	fz	0,036	0,041	0,051	0,059	0,067	0,072
	1	Ap max	0,3 x D	80	–	140	64	–	112	48	–	84	fz	0,043	0,050	0,061	0,070	0,078	0,082
	2	Ap max	0,3 x D	70	–	120	56	–	96	42	–	72	fz	0,032	0,037	0,046	0,052	0,057	0,058

■ VariMill III • 774E • Unequal Flute Spacing • Finishing



Material Group													Recommended feed per tooth (fz = mm/th) for side milling (A).						
	Side Milling (A)		short		medium			long			D1 – Diameter								
	A		adaptor reach														D1 – Diameter		
			WS15PE		WS15PE			WS15PE			mm 10,0 12,0 16,0 20,0 25,0 32,0								
	ap	ae	Cutting Speed – vc m/min		Cutting Speed – vc m/min			Cutting Speed – vc m/min											
P	4	Ap max	0,06 x D	180	–	300	162	–	270	162	–	270	fz	0,052	0,060	0,074	0,084	0,094	0,098
	5	Ap max	0,06 x D	120	–	200	102	–	170	96	–	160	fz	0,046	0,054	0,067	0,078	0,087	0,095
M	1	Ap max	0,06 x D	180	–	230	144	–	184	126	–	161	fz	0,058	0,067	0,084	0,097	0,109	0,118
	2	Ap max	0,06 x D	120	–	160	96	–	128	84	–	112	fz	0,046	0,054	0,067	0,078	0,087	0,095
S	3	Ap max	0,06 x D	120	–	140	96	–	112	84	–	98	fz	0,039	0,045	0,055	0,062	0,068	0,070
	1	Ap max	0,06 x D	100	–	180	80	–	144	60	–	108	fz	0,058	0,067	0,084	0,097	0,109	0,118
	2	Ap max	0,06 x D	50	–	80	40	–	64	30	–	48	fz	0,031	0,036	0,045	0,052	0,059	0,065
	3	Ap max	0,06 x D	120	–	160	96	–	128	72	–	96	fz	0,046	0,054	0,067	0,078	0,087	0,095
H	4	Ap max	0,06 x D	100	–	120	80	–	96	60	–	72	fz	0,043	0,050	0,062	0,071	0,080	0,087
	1	Ap max	0,06 x D	160	–	280	128	–	224	96	–	168	fz	0,052	0,060	0,074	0,084	0,094	0,098
	2	Ap max	0,06 x D	140	–	240	112	–	192	84	–	144	fz	0,039	0,045	0,055	0,062	0,068	0,070

NOTE: Lower value of cutting speed is used for high stock removal applications or for higher hardness (machinability) within group.
 Higher value of cutting speed is used for finishing applications or for lower hardness (machinability) within group.
 Above parameters are based on ideal conditions. For smaller taper machining centres, please adjust parameters accordingly on diameters >12mm.

Modular End Mills



High-Performance DUO-LOCK® Modular End Mills • VariMill™ Finishing

■ VariMill Ball Nose • 4XN0 • Asymmetrical Flute Spacing

Material Group									Recommended feed per tooth (fz = mm/th) for side milling (A). For slotting (B), reduce fz by 20%.											
	Side Milling (A) and Slotting (B)		short		medium		long		D1 – Diameter											
	A		B		adaptor reach															
					WP15PE		WP15PE									WP15PE				
	ap		ae		Cutting Speed – vc m/min		Cutting Speed – vc m/min		Cutting Speed – vc m/min		mm	10,0	12,0	16,0	20,0	25,0	32,0			
P	0	1,25 x D	0,5 x D	1 x D	150	–	200	135	–	180	135	–	180	fz	0,061	0,070	0,086	0,097	0,105	0,106
	1	1,25 x D	0,5 x D	1 x D	150	–	200	135	–	180	135	–	180	fz	0,061	0,070	0,086	0,097	0,105	0,106
	2	1,25 x D	0,5 x D	1 x D	140	–	190	126	–	171	126	–	171	fz	0,061	0,070	0,086	0,097	0,105	0,106
	3	1,25 x D	0,5 x D	1 x D	120	–	160	108	–	144	108	–	144	fz	0,051	0,060	0,074	0,086	0,097	0,105
	4	1,25 x D	0,5 x D	0,75 x D	90	–	150	81	–	135	81	–	135	fz	0,046	0,053	0,065	0,075	0,083	0,087
	5	1,25 x D	0,5 x D	1 x D	60	–	100	51	–	85	48	–	80	fz	0,041	0,048	0,059	0,069	0,077	0,084
M	1	1,25 x D	0,5 x D	1 x D	50	–	75	42	–	64	40	–	60	fz	0,034	0,040	0,048	0,055	0,060	0,062
	2	1,25 x D	0,5 x D	1 x D	90	–	115	72	–	92	63	–	80	fz	0,051	0,060	0,074	0,086	0,097	0,105
	3	1,25 x D	0,5 x D	1 x D	60	–	80	48	–	64	42	–	56	fz	0,041	0,048	0,059	0,069	0,077	0,084
K	1	1,25 x D	0,5 x D	1 x D	60	–	70	48	–	56	42	–	49	fz	0,034	0,040	0,048	0,055	0,060	0,062
	2	1,25 x D	0,5 x D	1 x D	120	–	150	108	–	135	108	–	135	fz	0,061	0,070	0,086	0,097	0,105	0,106
	3	1,25 x D	0,5 x D	1 x D	110	–	140	99	–	126	99	–	126	fz	0,051	0,060	0,074	0,086	0,097	0,105
S	1	1,25 x D	0,5 x D	1 x D	110	–	130	99	–	117	99	–	117	fz	0,041	0,048	0,059	0,069	0,077	0,084
	1	1 x D	0,3 x D	0,3 x D	50	–	90	40	–	72	30	–	54	fz	0,051	0,060	0,074	0,086	0,097	0,105
	2	1 x D	0,3 x D	0,3 x D	25	–	40	20	–	32	15	–	24	fz	0,027	0,032	0,039	0,046	0,052	0,057
	3	1,25 x D	0,5 x D	1 x D	60	–	80	48	–	64	36	–	48	fz	0,041	0,048	0,059	0,069	0,077	0,084
H	1	1,25 x D	0,5 x D	1 x D	50	–	60	40	–	48	30	–	36	fz	0,038	0,044	0,055	0,063	0,071	0,077
	2	1,25 x D	0,5 x D	0,75 x D	80	–	140	64	–	112	48	–	84	fz	0,046	0,053	0,065	0,075	0,083	0,087
	2	1,25 x D	0,2 x D	0,5 x D	70	–	120	56	–	96	42	–	72	fz	0,034	0,040	0,048	0,055	0,060	0,062

NOTE: Lower value of cutting speed is used for high stock removal applications or for higher hardness (machinability) within group.
Higher value of cutting speed is used for finishing applications or for lower hardness (machinability) within group.
Above parameters are based on ideal conditions. For smaller taper machining centres, please adjust parameters accordingly on diameters >12mm.
For side milling with ap larger than 1 x D, reduce fz by 20%!

■ 4547 • 4548 • Multi-Flute Finisher • Metric

Material Group									Recommended feed per tooth (fz = mm/th) for side milling (A).										
	Side Milling (A)		short		medium		long		D1 – Diameter										
	A		adaptor reach																
			WP15PE		WP15PE		WP15PE												
	ap		ae		Cutting Speed – vc m/min		Cutting Speed – vc m/min		Cutting Speed – vc m/min		mm	10,0	12,0	16,0	20,0	25,0	32,0		
P	0	1,5 x D	0,05 x D	150	–	200	135	–	180	135	–	180	fz	0,072	0,083	0,101	0,114	0,124	0,125
	1	1,5 x D	0,05 x D	150	–	200	135	–	180	135	–	180	fz	0,072	0,083	0,101	0,114	0,124	0,125
	2	1,5 x D	0,05 x D	140	–	190	126	–	171	126	–	171	fz	0,072	0,083	0,101	0,114	0,124	0,125
	3	1,5 x D	0,05 x D	120	–	160	108	–	144	108	–	144	fz	0,061	0,070	0,087	0,101	0,114	0,123
	4	1,5 x D	0,05 x D	90	–	150	81	–	135	81	–	135	fz	0,054	0,062	0,077	0,088	0,098	0,102
	5	1,5 x D	0,05 x D	60	–	100	51	–	85	48	–	80	fz	0,048	0,056	0,070	0,081	0,091	0,099
M	1	1,5 x D	0,05 x D	50	–	75	42,5	–	63,75	40	–	60	fz	0,040	0,047	0,057	0,065	0,071	0,073
	1	1,5 x D	0,05 x D	90	–	115	72	–	92	63	–	80,5	fz	0,061	0,070	0,087	0,101	0,114	0,123
	2	1,5 x D	0,05 x D	60	–	80	48	–	64	42	–	56	fz	0,048	0,056	0,070	0,081	0,091	0,099
K	1	1,5 x D	0,05 x D	60	–	70	48	–	56	42	–	49	fz	0,040	0,047	0,057	0,065	0,071	0,073
	1	1,5 x D	0,05 x D	120	–	150	108	–	135	108	–	135	fz	0,072	0,083	0,101	0,114	0,124	0,125
	2	1,5 x D	0,05 x D	110	–	140	99	–	126	99	–	126	fz	0,061	0,070	0,087	0,101	0,114	0,123
S	1	1,5 x D	0,05 x D	110	–	130	99	–	117	99	–	117	fz	0,048	0,056	0,070	0,081	0,091	0,099
	1	1,5 x D	0,05 x D	50	–	90	40	–	72	30	–	54	fz	0,061	0,070	0,087	0,101	0,114	0,123
	2	1,5 x D	0,05 x D	25	–	40	20	–	32	15	–	24	fz	0,032	0,037	0,046	0,054	0,061	0,067
	3	1,5 x D	0,05 x D	25	–	40	20	–	32	15	–	24	fz	0,032	0,037	0,046	0,054	0,061	0,067
H	1	1,5 x D	0,05 x D	50	–	60	40	–	48	30	–	36	fz	0,045	0,052	0,064	0,074	0,084	0,090
	1	1,5 x D	0,05 x D	80	–	140	64	–	112	48	–	84	fz	0,054	0,062	0,077	0,088	0,098	0,102
	2	1,5 x D	0,05 x D	70	–	120	56	–	96	42	–	72	fz	0,040	0,047	0,057	0,065	0,071	0,073

NOTE: Lower value of cutting speed is used for high stock removal applications or for higher hardness (machinability) within group.
Higher value of cutting speed is used for finishing applications or for lower hardness (machinability) within group.
Above parameters are based on ideal conditions.
For smaller taper machining centres, please adjust parameters accordingly on diameters > 12mm.

High-Performance DUO-λOCK® Modular End Mills • VariMill™ Roughing

■ 4946 • High-Performance Roughing • Metric

Material Group	Side Milling (A) and Slotting (B)			short			medium			long			Recommended feed per tooth (fz = mm/th) for side milling (A). For slotting (B), reduce fz by 20%.							
	A		B	adaptor reach									D1 – Diameter							
	ap		ae	WP15PE			WP15PE			WP15PE										
	ap		ae	Cutting Speed – vc m/min		max	Cutting Speed – vc m/min		min	max	Cutting Speed – vc m/min								min	max
	ap	ae	ap	min	max	min	max	min	max	min	max	mm	10,0	12,0	16,0	20,0	25,0	32,0		
P	0	1,5 x D	0,5 x D	1 x D	120	–	160	108	–	144	108	–	144	fz	0,061	0,070	0,086	0,097	0,105	0,106
	1	1,5 x D	0,5 x D	1 x D	120	–	160	108	–	144	108	–	144	fz	0,061	0,070	0,086	0,097	0,105	0,106
	2	1,5 x D	0,5 x D	1 x D	112	–	152	100,8	–	136,8	100,8	–	136,8	fz	0,061	0,070	0,086	0,097	0,105	0,106
	3	1,5 x D	0,4 x D	0,75 x D	96	–	128	86,4	–	115,2	86,4	–	115,2	fz	0,051	0,060	0,074	0,086	0,097	0,105
	4	1,5 x D	0,3 x D	0,30 x D	72	–	120	64,8	–	108	64,8	–	108	fz	0,046	0,053	0,065	0,075	0,083	0,087
M	5	1,5 x D	0,4 x D	0,75 x D	48	–	80	40,8	–	68	38,4	–	64	fz	0,041	0,048	0,059	0,069	0,077	0,084
	1	1,5 x D	0,4 x D	0,75 x D	72	–	92	57,6	–	73,6	50,4	–	64,4	fz	0,051	0,060	0,074	0,086	0,097	0,105
	2	1,5 x D	0,4 x D	0,75 x D	48	–	64	38,4	–	51,2	33,6	–	44,8	fz	0,041	0,048	0,059	0,069	0,077	0,084
K	3	1,5 x D	0,4 x D	0,75 x D	48	–	56	38,4	–	44,8	33,6	–	39,2	fz	0,034	0,040	0,048	0,055	0,060	0,062
	1	1,5 x D	0,5 x D	1 x D	96	–	120	86,4	–	108	86,4	–	108	fz	0,061	0,070	0,086	0,097	0,105	0,106
	2	1,5 x D	0,4 x D	1 x D	88	–	112	79,2	–	100,8	79,2	–	100,8	fz	0,051	0,060	0,074	0,086	0,097	0,105
S	3	1,5 x D	0,4 x D	1 x D	88	–	104	79,2	–	93,6	79,2	–	93,6	fz	0,041	0,048	0,059	0,069	0,077	0,084
	1	1,5 x D	0,4 x D	0,75 x D	40	–	72	32	–	57,6	24	–	43,2	fz	0,051	0,060	0,074	0,086	0,097	0,105
	3	1,5 x D	0,4 x D	0,75 x D	20	–	32	16	–	25,6	12	–	19,2	fz	0,027	0,032	0,039	0,046	0,052	0,057
H	1	1,5 x D	0,3 x D	0,30 x D	64	–	112	51,2	–	89,6	38,4	–	67,2	fz	0,046	0,053	0,065	0,075	0,083	0,087

NOTE: Lower value of cutting speed is used for high stock removal applications or for higher hardness (machinability) within group.
 Higher value of cutting speed is used for finishing applications or for lower hardness (machinability) within group.
 Above parameters are based on ideal conditions. For smaller taper machining centres, please adjust parameters according to system's stability.
 For side milling with ap larger than 1 x D, reduce fz by 20%! Do not use cylindrical shank for full slotting!

■ 4969 • Ball Nose Roughing • Metric



Material Group	Side Milling (A) and Slotting (B)			short			medium			long			Recommended feed per tooth (fz = mm/th) for side milling (A). For slotting (B), reduce fz by 20%.							
	A		B	adaptor reach									D1 – Diameter							
	ap		ae	WP15PE			WP15PE			WP15PE										
	ap		ae	Cutting Speed – vc m/min		max	Cutting Speed – vc m/min		min	max	Cutting Speed – vc m/min								min	max
	ap	ae	ap	min	max	min	max	min	max	min	max	mm	10,0	12,0	16,0	20,0	25,0	32,0		
P	0	1,5 x D	0,5 x D	1 x D	150	–	200	135	–	180	135	–	180	fz	0,061	0,070	0,086	0,097	0,105	0,106
	1	1,5 x D	0,5 x D	1 x D	150	–	200	135	–	180	135	–	180	fz	0,061	0,070	0,086	0,097	0,105	0,106
	2	1,5 x D	0,5 x D	1 x D	140	–	190	126	–	171	126	–	171	fz	0,061	0,070	0,086	0,097	0,105	0,106
	3	1,5 x D	0,4 x D	0,75 x D	120	–	160	108	–	144	108	–	144	fz	0,051	0,060	0,074	0,086	0,097	0,105
	4	1,5 x D	0,3 x D	0,30 x D	90	–	150	81	–	135	81	–	135	fz	0,046	0,053	0,065	0,075	0,083	0,087
M	5	1,5 x D	0,4 x D	0,75 x D	60	–	100	51	–	85	48	–	80	fz	0,041	0,048	0,059	0,069	0,077	0,084
	1	1,5 x D	0,3 x D	0,30 x D	50	–	75	42,5	–	63,75	40	–	60	fz	0,034	0,040	0,048	0,055	0,060	0,062
	2	1,5 x D	0,4 x D	0,75 x D	90	–	115	72	–	92	63	–	80,5	fz	0,051	0,060	0,074	0,086	0,097	0,105
K	3	1,5 x D	0,4 x D	0,75 x D	60	–	80	48	–	64	42	–	56	fz	0,041	0,048	0,059	0,069	0,077	0,084
	1	1,5 x D	0,5 x D	1 x D	120	–	150	108	–	135	108	–	135	fz	0,061	0,070	0,086	0,097	0,105	0,106
	2	1,5 x D	0,4 x D	1 x D	110	–	140	99	–	126	99	–	126	fz	0,051	0,060	0,074	0,086	0,097	0,105
S	3	1,5 x D	0,4 x D	1 x D	110	–	130	99	–	117	99	–	117	fz	0,041	0,048	0,059	0,069	0,077	0,084
	1	1,5 x D	0,4 x D	0,75 x D	50	–	90	40	–	72	30	–	54	fz	0,051	0,060	0,074	0,086	0,097	0,105
	2	1,5 x D	0,3 x D	0,30 x D	25	–	40	20	–	32	15	–	24	fz	0,027	0,032	0,039	0,046	0,052	0,057
H	3	1,5 x D	0,3 x D	0,30 x D	25	–	40	20	–	32	15	–	24	fz	0,027	0,032	0,039	0,046	0,052	0,057
	4	1,5 x D	0,3 x D	0,75 x D	50	–	60	40	–	48	30	–	36	fz	0,038	0,044	0,055	0,063	0,071	0,077
	1	1,5 x D	0,3 x D	0,30 x D	80	–	140	64	–	112	48	–	84	fz	0,046	0,053	0,065	0,075	0,083	0,087
H	2	1,5 x D	0,2 x D	0,20 x D	70	–	120	56	–	96	42	–	72	fz	0,034	0,040	0,048	0,055	0,060	0,062
	3	1,5 x D	0,2 x D	0,20 x D	60	–	90	48	–	72	36	–	54	fz	0,027	0,032	0,039	0,046	0,052	0,057

NOTE: Lower value of cutting speed is used for high stock removal applications or for higher hardness (machinability) within group.
 Higher value of cutting speed is used for finishing applications or for lower hardness (machinability) within group.
 Above parameters are based on ideal conditions. Please adjust parameters accordingly on diameters > 12mm.
 For side milling with ap bigger than 1 x D reduce fz by 20%! Do not use cylindrical shank for full slotting!

Modular End Mills





High-Performance DUO-LOCK® Modular End Mills • Roughing/AluSurf™

4U40 • Roughing

Material Group											Recommended feed per tooth (fz = mm/th) for side milling (A). For slotting (B), reduce fz by 20%.									
	Side Milling (A) and Slotting (B)				short		medium		long		D1 – Diameter									
	A		B		adaptor reach															
					WS15PE		WS15PE		WS15PE											
	ap		ae		Cutting Speed – vc m/min		Cutting Speed – vc m/min		Cutting Speed – vc m/min		mm	10,0	12,0	16,0	20,0	25,0	32,0			
P	3	1,0 x D	0,5 x D	0,75 x D	120	–	160	108	–	144	108	–	144	fz	0,051	0,060	0,074	0,086	0,097	0,105
	4	1,0 x D	0,3 x D	0,75 x D	90	–	150	81	–	135	81	–	135	fz	0,046	0,053	0,065	0,075	0,083	0,087
	5	1,0 x D	0,5 x D	0,75 x D	60	–	100	51	–	85	48	–	80	fz	0,041	0,048	0,059	0,069	0,077	0,084
M	6	1,0 x D	0,3 x D	0,30 x D	50	–	75	42,5	–	63,75	40	–	60	fz	0,034	0,040	0,048	0,055	0,060	0,062
	1	1,0 x D	0,4 x D	0,75 x D	90	–	115	72	–	92	63	–	80,5	fz	0,051	0,060	0,074	0,086	0,097	0,105
	2	1,0 x D	0,4 x D	0,75 x D	60	–	80	48	–	64	42	–	56	fz	0,041	0,048	0,059	0,069	0,077	0,084
K	3	1,0 x D	0,4 x D	0,75 x D	60	–	70	48	–	56	42	–	49	fz	0,034	0,040	0,048	0,055	0,060	0,062
	1	1,0 x D	0,5 x D	1 x D	120	–	150	108	–	135	108	–	135	fz	0,061	0,070	0,086	0,097	0,105	0,106
	2	1,0 x D	0,5 x D	1 x D	110	–	140	99	–	126	99	–	126	fz	0,051	0,060	0,074	0,086	0,097	0,105
S	3	1,0 x D	0,5 x D	1 x D	110	–	130	99	–	117	99	–	117	fz	0,041	0,048	0,059	0,069	0,077	0,084
	1	1,0 x D	0,3 x D	0,75 x D	50	–	90	40	–	72	30	–	54	fz	0,051	0,060	0,074	0,086	0,097	0,105
	2	1,0 x D	0,3 x D	0,75 x D	25	–	40	20	–	32	15	–	24	fz	0,027	0,032	0,039	0,046	0,052	0,057
	3	1,0 x D	0,3 x D	0,75 x D	25	–	40	20	–	32	15	–	24	fz	0,027	0,032	0,039	0,046	0,052	0,057
H	4	1,0 x D	0,4 x D	0,75 x D	50	–	60	40	–	48	30	–	36	fz	0,038	0,044	0,055	0,063	0,071	0,077
	1	1,0 x D	0,3 x D	0,30 x D	80	–	140	64	–	112	48	–	84	fz	0,046	0,053	0,065	0,075	0,083	0,087
	2	1,0 x D	0,2 x D	0,20 x D	70	–	120	56	–	96	42	–	72	fz	0,034	0,040	0,048	0,055	0,060	0,062
	3	1,0 x D	0,2 x D	0,20 x D	60	–	90	48	–	72	36	–	54	fz	0,027	0,032	0,039	0,046	0,052	0,057

NOTE: Lower value of cutting speed is used for high stock removal applications or for higher hardness (machinability) within group.
Higher value of cutting speed is used for finishing applications or for lower hardness (machinability) within group.
Above parameters are based on ideal conditions. Please adjust parameters according to system's stability.
For side milling with ap bigger than 1 x D reduce fz by 20%! Do not use cylindrical shank for full slotting!



AluSurf • 5142 • 5143 • Aluminium

Material Group																				
	Side Milling (A) and Slotting (B)				short		medium		long		Recommended feed per tooth (fz = mm/th) for side milling (A). For slotting (B), reduce fz by 20%.									
	A		B		adaptor reach						D1 – Diameter									
					UNCOATED		UNCOATED		UNCOATED											
	ap		ae		Cutting Speed – vc m/min		Cutting Speed – vc m/min		Cutting Speed – vc m/min									mm	10,0	12,0
N	1	1,5 x D	0,3 x D	1,0 x D	500	–	2000	400	–	1200	300	–	1200	fz	0,077	0,092	0,122	0,153	0,191	0,245
	2	1,5 x D	0,3 x D	1,0 x D	500	–	1500	400	–	900	300	–	900	fz	0,069	0,083	0,110	0,138	0,172	0,220
	3	1,5 x D	0,3 x D	1,0 x D	500	–	1500	400	–	900	300	–	900	fz	0,054	0,064	0,086	0,107	0,134	0,171
	4	1,5 x D	0,3 x D	1,0 x D	400	–	750	320	–	450	240	–	450	fz	0,054	0,064	0,086	0,107	0,134	0,171
	5	1,5 x D	0,3 x D	1,0 x D	250	–	1000	200	–	600	150	–	600	fz	0,069	0,083	0,110	0,138	0,172	0,220

NOTE: ap for spindle with ceramic bearings multiply by 0.5.
For better surface finish, reduce feed per tooth.
Above parameters are based on ideal conditions. Please adjust parameters according to system's stability.
For side milling with ap bigger than 1 x D, reduce fz by 20%! Do not use cylindrical shank for full slotting!

High-Performance DUO-LOCK® Modular End Mills • Corner Rounding/Chamfering

■ 8045 Corner Rounding • 8046 Chamfering

Material Group																
	Side Milling (A)		short			medium			long			Recommended feed per tooth (fz = mm/th) for side milling (A).				
	A		adaptor reach									D1 – Diameter				
			WP15PE			WP15PE			WP15PE							
	ap		ae		Cutting Speed – vc m/min		Cutting Speed – vc m/min		Cutting Speed – vc m/min		mm					10,0
min	max	min	max	min	max	min	max	min	max	mm	10,0	12,0	16,0			
P	0	0,35 x D	0,35 x D	150	–	200	135	–	180	135	–	180	fz	0,058	0,066	0,081
	1	0,35 x D	0,35 x D	150	–	200	135	–	180	135	–	180	fz	0,058	0,066	0,081
	2	0,35 x D	0,35 x D	140	–	190	126	–	171	126	–	171	fz	0,058	0,066	0,081
	3	0,35 x D	0,35 x D	120	–	160	108	–	144	108	–	144	fz	0,048	0,056	0,070
	4	0,35 x D	0,35 x D	90	–	150	81	–	135	81	–	135	fz	0,043	0,050	0,061
	5	0,35 x D	0,35 x D	60	–	100	51	–	85	48	–	80	fz	0,039	0,045	0,056
M	6	0,35 x D	0,35 x D	50	–	75	42,5	–	63,75	40	–	60	fz	0,032	0,037	0,046
	1	0,35 x D	0,35 x D	90	–	115	72	–	92	63	–	80,5	fz	0,048	0,056	0,070
	2	0,35 x D	0,35 x D	60	–	80	48	–	64	42	–	56	fz	0,039	0,045	0,056
K	3	0,35 x D	0,35 x D	60	–	70	48	–	56	42	–	49	fz	0,032	0,037	0,046
	1	0,35 x D	0,35 x D	120	–	150	108	–	135	108	–	135	fz	0,058	0,066	0,081
	2	0,35 x D	0,35 x D	110	–	140	99	–	126	99	–	126	fz	0,048	0,056	0,070
N	3	0,35 x D	0,35 x D	110	–	130	99	–	117	99	–	117	fz	0,039	0,045	0,056
	1	0,35 x D	0,35 x D	500	–	2000	400	–	1600	300	–	1200	fz	0,080	0,096	0,128
	2	0,35 x D	0,35 x D	500	–	1500	400	–	1200	300	–	900	fz	0,072	0,086	0,115
	3	0,35 x D	0,35 x D	500	–	1500	400	–	1200	300	–	900	fz	0,056	0,067	0,090
	4	0,35 x D	0,35 x D	400	–	750	320	–	600	240	–	450	fz	0,056	0,067	0,090
	5	0,35 x D	0,35 x D	250	–	1000	200	–	800	150	–	600	fz	0,072	0,086	0,115
	6	0,35 x D	0,35 x D	100	–	750	80	–	600	60	–	450	fz	0,080	0,096	0,128
S	7	0,35 x D	0,35 x D	100	–	750	80	–	600	60	–	450	fz	0,056	0,067	0,090
	1	0,35 x D	0,35 x D	50	–	90	40	–	72	30	–	54	fz	0,048	0,056	0,070
	2	0,35 x D	0,35 x D	25	–	40	20	–	32	15	–	24	fz	0,026	0,030	0,037
	3	0,35 x D	0,35 x D	25	–	40	20	–	32	15	–	24	fz	0,026	0,030	0,037
H	4	0,35 x D	0,35 x D	50	–	60	40	–	48	30	–	36	fz	0,036	0,041	0,051
	1	0,35 x D	0,35 x D	80	–	140	64	–	112	48	–	84	fz	0,043	0,050	0,061

NOTE: Lower value of cutting speed is used for high stock removal applications or for higher hardness (machinability) within group.
 Higher value of cutting speed is used for finishing applications or for lower hardness (machinability) within group.
 Above parameters are based on ideal conditions. Please adjust parameters according to system's stability.

Modular End Mills

High-Performance DUO-LOCK® Modular End Mills

■ System Assembly Information

Please wear sufficient personal safety equipment such as gloves and eye protection during assembly.

- 1 Clean the Duo-Lock™ cutting insert and shank coupling.

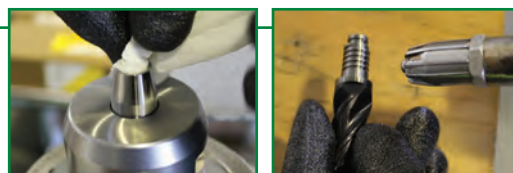

- 2 Mount the Duo-Lock™ adaptor in a mounting block with a clamping chuck sufficient to enable torque transmission.



- 3 Screw the Duo-Lock™ cutting tip into adaptor by hand.

Attention: Use of protective gloves is mandatory!



- 4 A gap of approx. 0,15–0,3mm should be visible.

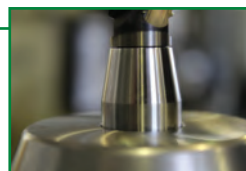

- 5 Apply the torque shown in the table. Use of a high quality common torque wrench is mandatory. The ERICKSON™ Torque Master wrench is recommended.



Duo-Lock™ Size	Torque Nm
DL 16	60
DL 20	80
DL 25	100
DL 32	130



Machining Central App from WIDIA™

The fastest, easiest way to get feeds and speeds.

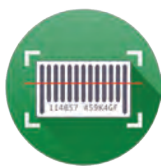
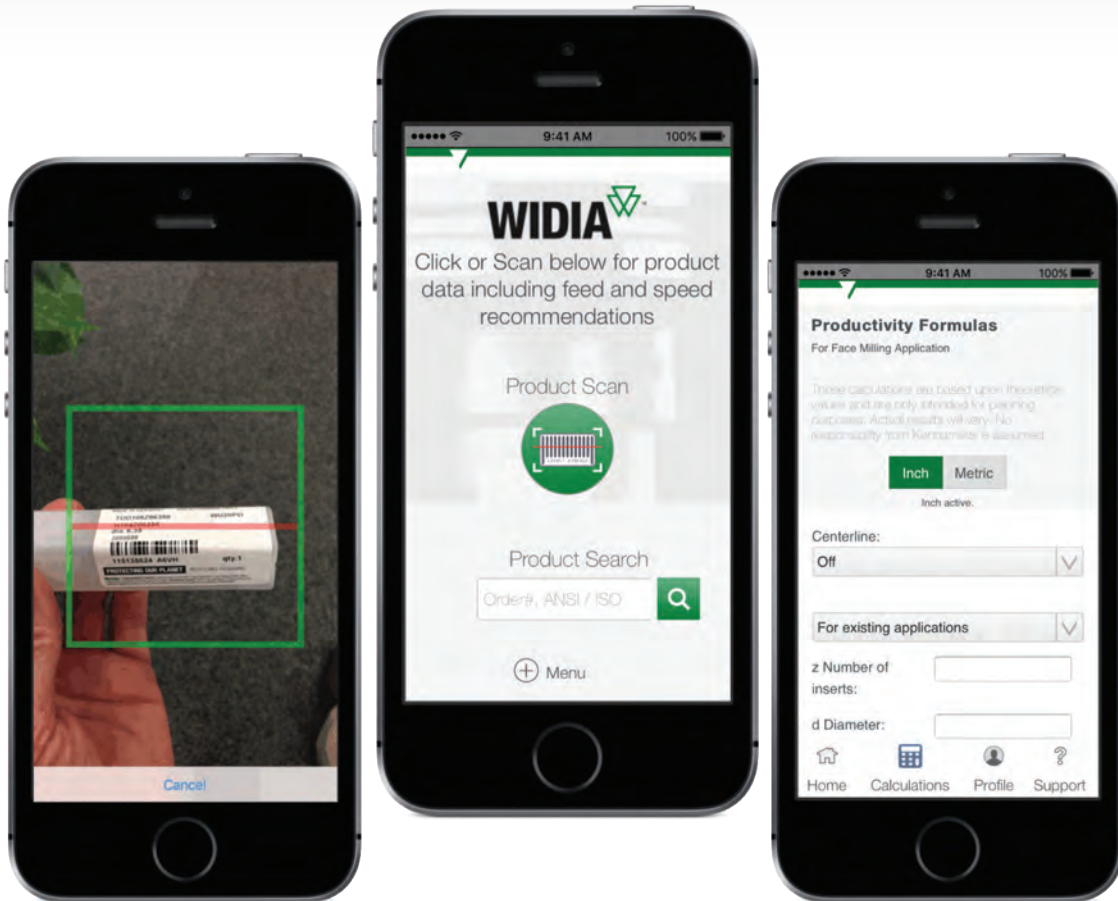

SCAN

With the new WIDIA app, product data is just a quick scan away. Now, when you're on the floor and need to quickly access the speeds and feeds of your favorite WIDIA tool, the WIDIA app gives you reliable information in just a few seconds.



SEARCH

Don't have a barcode? The new WIDIA app includes another simple search technique — just type the tool's corresponding order number or the ANSI or ISO catalogue number into the search bar. You'll get the same reliable data as if you'd scanned the tool's barcode. It's simple and quick — no interruption in production!



CALCULATE

Have a specific machining need that our recommended speeds and feeds don't quite address? Try out our three NOVO™ based calculators. Both end milling and face milling calculators are available. Simply fill in the blank fields, and our calculators will quickly provide the data you need.

DOWNLOAD THE WIDIA MACHINING CENTRAL MOBILE APP

widia.com



GP

WIDIA-Hanita™ General Purpose End Mills

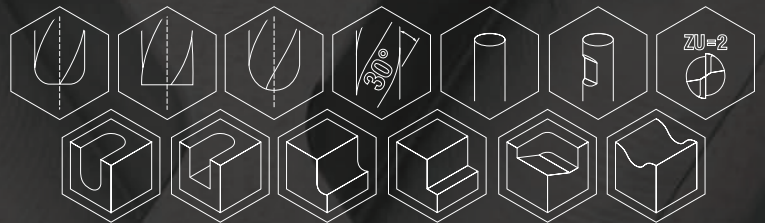

The Evolution of a Solid Carbide End Mill Revolution

The WIDIA-Hanita solid carbide end mill product lines have built a strong ongoing reputation of continuous development and diversification.

WIDIA-Hanita general purpose end mills offer plunging, slotting, and profiling for a wide range of materials and applications. Designed to provide high metal removal rates and excellent surface conditions at a value price. A wide range of diameters, lengths, and corner styles (such as chamfered, sharp edge, and ball nose) are available from stock.





2-Flute

- Centre cutting.
- Steel, stainless steel, and cast iron.
- Wide range of lengths-of-cut — short, regular, long, and extra long.

Square Series: D002/D012 • 2819 • 4002/4012/4022

- Sharp edge with dubbing for extended tool life.

Ball Nose Series: D001/D011 • 2838 • 4001/4011/4021



3-Flute

- Centre cutting.
- Steel, stainless steel, and cast iron.
- Sharp edge with dubbing for extended tool life.
- Wide range of lengths-of-cut — short, regular, long, and extra long.

Square Series: D003..S/D013..S • D003/D013 • 4003..S/4013..S • 4003/4013

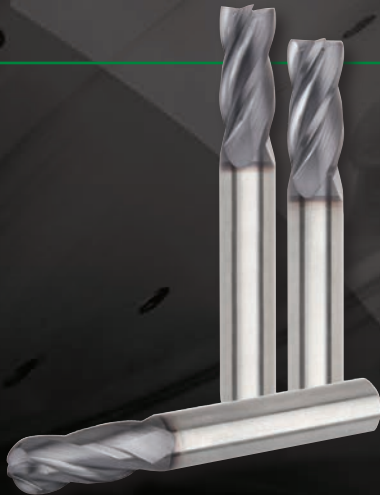

4-Flute

- Centre cutting
- Steel, stainless steel, and cast iron.

Square Series: D004/D014 • 2528 • 4004/4014/4024

- Wide range of lengths-of-cut — short, regular, long, and extra long.
- Sharp edge with dubbing for extended tool life.

Ball Nose Series: D010 • 2848 • 4000/4010

- Wide range of lengths-of-cut — short, regular, long, and extra long.

Radius Series: 4004/4014/4024

- Regular length-of-cut with corner radius.

COMING SOON!

WIDIA 

widia.com

TOP DRILL

Stainless Steel Drilling Redefined

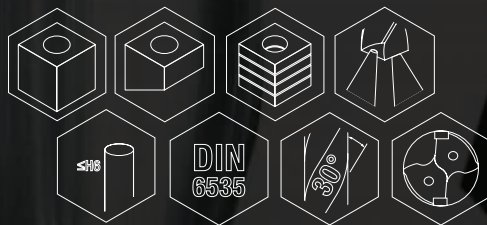



STM

Productivity

- Excellent chip flow due to flute design and finish.
- New coating enables higher cutting speeds.
- Higher feed rates on stainless steels and duplex.

Performance

- Available for custom solutions, as well as step-drilling.
- Real 8 x D drill lengths.
- Cylindrical shank h6 for perfect runout.
- Double-margin design for critical operations.



Cutting speed increased by up to 20% in drilling on austenitic and duplex stainless steels.

series	Coolant	Length Ratio	Diameter Range
TDS451	Through Coolant	3 x D	3,0–20,0mm (.1181–.7874")
TDS452		5 x D	
TDS453		8 x D	

WIDIA 

widia.com

TOP DRILL S™

TDS45x for Stainless Steel

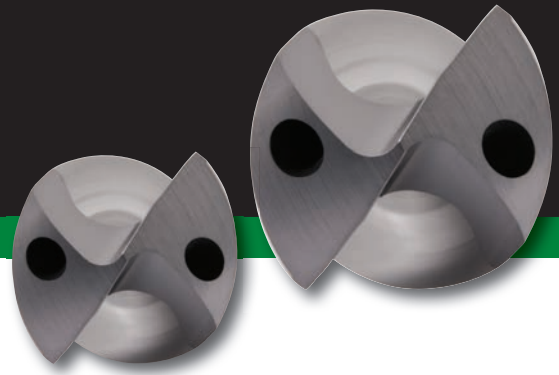

- Excellent centring ability.
- Increased wear resistance in heat-generating applications with tough materials.
- The average tool life improves dramatically 10–30%.
- The new technology improves chip evacuation, especially in deep holes and difficult cutting conditions.
- New gash design specifically for stainless steel, as well as difficult-to-machine materials:
 - Smooth chip transition from cutting edge to flutes.
 - Less cutting forces and temperatures generated. New WM15PD coating with high-aluminium content and polished flutes.
- Two margin lands.
- Real 8 x D ratio
 - Increased length of cut.
- Complete portfolio from 3–20mm in 3 x D, 5 x D, and 8 x D ratios.

WM15PD Grade

A multilayer, AlTiN-based coating with high hot hardness enables high-speed drilling and MQL applications.

Patented TDS Point

Excellent centring. Highest feed and speeds. Force reduction.

2 margin lands
Provide stability in the cut and reduce friction.

Web and envelope taper
Free chip flow.

Fine-grained substrate
Reduces risk of fracture.

Straight cutting edge
Long tool life and less chipping on cutting edge.

Coolant holes
Provide optimum coolant flow.

Unique new polished surface
Reduction of friction in the chip flute and on the lands; drastically improved tool life.

h6 Precision shank
Round cylindrical. DIN.
Low runout. Suitable for Shrink Fit chucks.

Large chip-flute cross-section, small core diameter
Drastically improved chip evacuation; capability to drill deeper holes in difficult-to-machine materials.

New gash design
Easy chip formation and flow.

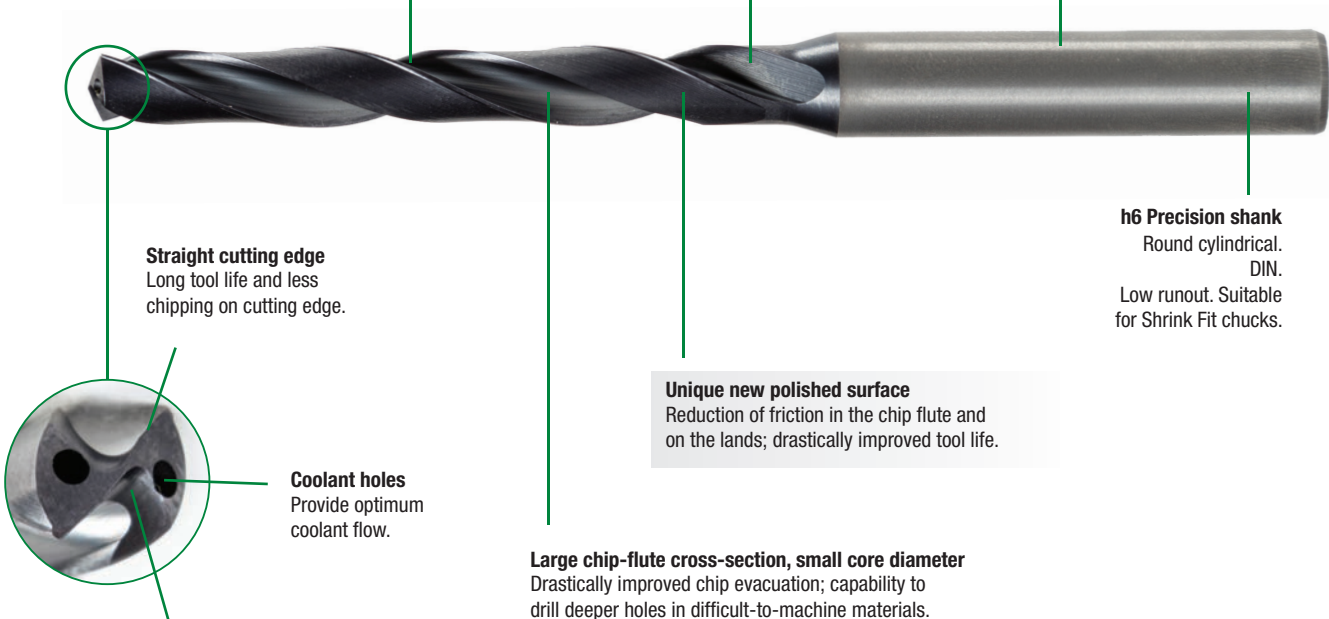

TOP DRILL S™ with Through Coolant • Stainless Steel

■ TDS451A • 3 x D / TDS452A • 5 x D / TDS453A • 8 x D

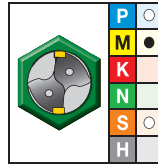
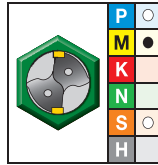
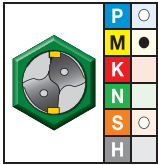

● first choice
○ alternate choice

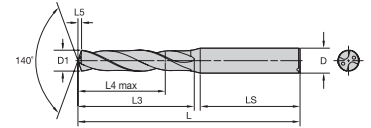

For information on L, L3, and L4 max, see the Dimension Table on page 77.

3 x D grade WM15PD AlTiN	5 x D grade WM15PD AlTiN	8 x D grade WM15PD AlTiN	D1 diameter				
			mm	in	L5	LS	D
6327647	6327948	6328197	3,000	.1181	0,5	36	6
6327648	6327950	6328200	3,048	.1200	0,5	36	6
6327649	6327952	6328202	3,100	.1220	0,5	36	6
6327650	6327954	6328204	3,175	.1250	0,5	36	6
6327711	6327956	6328206	3,200	.1260	0,5	36	6
6327712	6327958	6328208	3,264	.1285	0,5	36	6
6327713	6327960	6328209	3,300	.1299	0,5	36	6
6327714	6327962	6328211	3,400	.1339	0,6	36	6
6327715	6327964	6328213	3,455	.1360	0,6	36	6
6327716	6327966	6328216	3,500	.1378	0,6	36	6
6327717	6327968	6328218	3,571	.1406	0,6	36	6
6327718	6327970	6328219	3,600	.1417	0,6	36	6
6327719	6327972	6328221	3,658	.1440	0,6	36	6
6327720	6327974	6328223	3,700	.1457	0,6	36	6
6327721	6327976	6328225	3,734	.1470	0,6	36	6
6327722	6327978	6328227	3,800	.1496	0,6	36	6
6327723	6327980	6328229	3,900	.1535	0,6	36	6
6327724	6327982	6328231	3,970	.1563	0,7	36	6
6327725	6327984	6328233	4,000	.1575	0,7	36	6
6327726	6327986	6328235	4,039	.1590	0,7	36	6
6327727	6327988	6328237	4,090	.1610	0,7	36	6
6327728	6327990	6328239	4,100	.1614	0,7	36	6
6327729	6327992	6328241	4,200	.1654	0,7	36	6
6327730	6327994	6328242	4,217	.1660	0,7	36	6
6327741	6327996	6328243	4,300	.1693	0,7	36	6
6327742	6327998	6328244	4,366	.1719	0,7	36	6
6327743	6327999	6328245	4,400	.1732	0,7	36	6
6327744	6328000	6328246	4,500	.1772	0,7	36	6
6327745	6328001	6328247	4,600	.1811	0,8	36	6
6327746	6328002	6328248	4,623	.1820	0,8	36	6
6327747	6328003	6328249	4,700	.1850	0,8	36	6
6327748	6328004	6328250	4,763	.1875	0,8	36	6
6327749	6328005	6328261	4,800	.1890	0,8	36	6
6327750	6328006	6328262	4,852	.1910	0,8	36	6
6327751	6328007	6328263	4,900	.1929	0,8	36	6
6327752	6328008	6328264	5,000	.1969	0,8	36	6
6327753	6328009	6328265	5,100	.2008	0,9	36	6
6327754	6328010	6328266	5,106	.2010	0,9	36	6
6327755	6328011	6328267	5,159	.2031	0,9	36	6
6327756	6328012	6328268	5,200	.2047	0,9	36	6
6327757	6328013	6328269	5,300	.2087	0,9	36	6
6327758	6328014	6328270	5,400	.2126	0,9	36	6
6327759	6328015	6328271	5,410	.2130	0,9	36	6
6327760	6328016	6328272	5,500	.2165	0,9	36	6

(continued)

TOP DRILL S™

TOP DRILL S with Through Coolant • Stainless Steel

(TDS451A • 3 x D / TDS452A • 5 x D / TDS453A • 8 x D — continued)

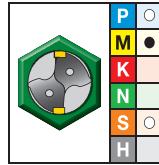
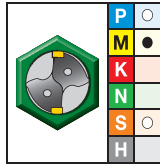
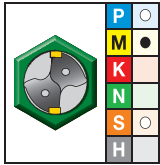

- first choice
- alternate choice

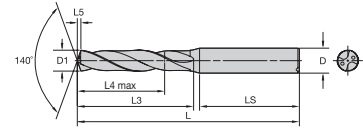

For information on L, L3, and L4 max, see the Dimension Table on page 77.

			D1 diameter		L5	LS	D
3 x D grade WM15PD AITiN	5 x D grade WM15PD AITiN	8 x D grade WM15PD AITiN	mm	in			
order #	order #	order #					
6327761	6328017	6328273	5,558	.2188	0,9	36	6
6327762	6328018	6328274	5,600	.2205	0,9	36	6
6327763	6328019	6328275	5,616	.2211	0,9	36	6
6327764	6328020	6328276	5,700	.2244	1,0	36	6
6327765	6328021	6328277	5,800	.2283	1,0	36	6
6327766	6328022	6328278	5,900	.2323	1,0	36	6
6327767	6328023	6328279	5,954	.2344	1,0	36	6
6327768	6328024	6328280	6,000	.2362	1,0	36	6
6327769	6328025	6328291	6,100	.2402	1,0	36	8
6327770	6328026	6328292	6,200	.2441	1,0	36	8
6327771	6328027	6328293	6,300	.2480	1,1	36	8
6327772	6328028	6328294	6,350	.2500	1,1	36	8
6327773	6328029	6328295	6,400	.2520	1,1	36	8
6327774	6328030	6328296	6,500	.2559	1,1	36	8
6327775	6328031	6328297	6,528	.2570	1,1	36	8
6327776	6328032	6328298	6,600	.2598	1,1	36	8
6327777	6328033	6328299	6,630	.2610	1,1	36	8
6327778	6328034	6328300	6,700	.2638	1,1	36	8
6327779	6328035	6328301	6,746	.2656	1,1	36	8
6327780	6328036	6328302	6,800	.2677	1,1	36	8
6327781	6328037	6328303	6,900	.2717	1,2	36	8
6327782	6328038	6328304	7,000	.2756	1,2	36	8
6327783	6328039	6328305	7,100	.2795	1,2	36	8
6327784	6328040	6328306	7,145	.2813	1,2	36	8
6327785	6328041	6328307	7,200	.2835	1,2	36	8
6327786	6328042	6328308	7,300	.2874	1,2	36	8
6327787	6328043	6328309	7,400	.2913	1,3	36	8
6327788	6328044	6328310	7,500	.2953	1,3	36	8
6327789	6328045	6328311	7,541	.2969	1,3	36	8
6327790	6328046	6328312	7,600	.2992	1,3	36	8
6327791	6328047	6328313	7,700	.3031	1,3	36	8
6327792	6328048	6328314	7,800	.3071	1,3	36	8
6327793	6328049	6328315	7,900	.3110	1,3	36	8
6327794	6328050	6328316	7,938	.3125	1,3	36	8
6327795	6328051	6328317	8,000	.3150	1,4	36	8
6327796	6328052	6328318	8,100	.3189	1,4	40	10
6327797	6328053	6328319	8,200	.3228	1,4	40	10
6327798	6328054	6328320	8,300	.3268	1,4	40	10
6327799	6328055	6328321	8,334	.3281	1,4	40	10
6327800	6328056	6328322	8,400	.3307	1,4	40	10
6327801	6328057	6328323	8,433	.3320	1,4	40	10
6327802	6328058	6328324	8,500	.3346	1,4	40	10
6327803	6328059	6328325	8,600	.3386	1,5	40	10
6327804	6328060	6328326	8,700	.3425	1,5	40	10

(continued)

TOP DRILL S™ with Through Coolant • Stainless Steel

(TDS451A • 3 x D / TDS452A • 5 x D / TDS453A • 8 x D — continued)

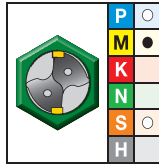
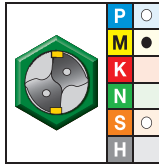
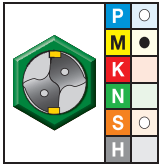

- first choice
- alternate choice

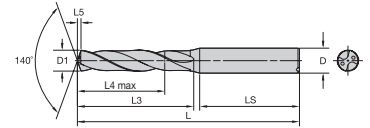

For information on L, L3, and L4 max, see the Dimension Table on page 77.

			D1 diameter		L5	LS	D
3 x D grade WM15PD AITiN	5 x D grade WM15PD AITiN	8 x D grade WM15PD AITiN	mm	in			
order #	order #	order #					
6327805	6328061	6328327	8,733	.3438	1,5	40	10
6327806	6328062	6328328	8,800	.3465	1,5	40	10
6327807	6328063	6328329	8,900	.3504	1,5	40	10
6327808	6328064	6328330	9,000	.3543	1,5	40	10
6327809	6328065	6328331	9,100	.3583	1,6	40	10
6327810	6328066	6328332	9,129	.3594	1,6	40	10
6327811	6328067	6328333	9,200	.3622	1,6	40	10
6327812	6328068	6328335	9,300	.3661	1,6	40	10
6327813	6328069	6328336	9,347	.3680	1,6	40	10
6327814	6328070	6328337	9,400	.3701	1,6	40	10
6327815	6328071	6328338	9,500	.3740	1,6	40	10
6327816	6328072	6328339	9,525	.3750	1,6	40	10
6327817	6328073	6328340	9,600	.3780	1,6	40	10
6327818	6328074	6328341	9,700	.3819	1,7	40	10
6327819	6328075	6328342	9,800	.3858	1,7	40	10
6327820	6328076	6328343	9,900	.3898	1,7	40	10
6327821	6328077	6328344	9,921	.3906	1,7	40	10
6327822	6328078	6328345	10,000	.3937	1,7	40	10
6327823	6328079	6328346	10,100	.3976	1,7	45	12
6327824	6328080	6328347	10,200	.4016	1,7	45	12
6327825	6328081	6328348	10,300	.4055	1,8	45	12
6327826	6328082	6328349	10,320	.4063	1,8	45	12
6327827	6328083	6328350	10,400	.4094	1,8	45	12
6327828	6328084	6328351	10,500	.4134	1,8	45	12
6327829	6328085	6324404	10,600	.4173	1,8	45	12
6327830	6328086	6324405	10,700	.4213	1,8	45	12
6327841	6328087	6324406	10,716	.4219	1,8	45	12
6327842	6328088	6324407	10,800	.4252	1,9	45	12
6327843	6328089	6324408	10,900	.4291	1,9	45	12
6327844	6328090	6324409	11,000	.4331	1,9	45	12
6327845	6328091	6324410	11,100	.4370	1,9	45	12
6327846	6328092	6324491	11,113	.4375	1,9	45	12
6327847	6328093	6324492	11,200	.4409	1,9	45	12
6327848	6328094	6324493	11,300	.4449	1,9	45	12
6327849	6328095	6324494	11,400	.4488	2,0	45	12
6327850	6328096	6324495	11,500	.4528	2,0	45	12
6327851	6328097	6324496	11,509	.4531	2,0	45	12
6327852	6328098	6324497	11,600	.4567	2,0	45	12
6327853	6328099	6324498	11,700	.4606	2,0	45	12
6327854	6328100	6324499	11,800	.4646	2,0	45	12
6327855	6328111	6324500	11,900	.4685	2,0	45	12
6327856	6328112	6324501	11,908	.4688	2,0	45	12
6327857	6328113	6324502	12,000	.4724	2,1	45	12
6327858	6328114	6324503	12,100	.4764	2,1	45	14

(continued)

TOP DRILL S™

TOP DRILL S with Through Coolant • Stainless Steel

(TDS451A • 3 x D / TDS452A • 5 x D / TDS453A • 8 x D — continued)

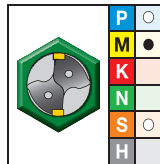
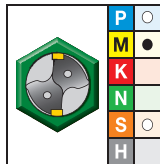
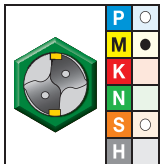

- first choice
- alternate choice

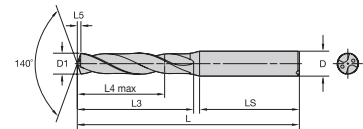

For information on L, L3, and L4 max, see the Dimension Table on page 77.

			D1 diameter		L5	LS	D
3 x D grade WM15PD AITiN	5 x D grade WM15PD AITiN	8 x D grade WM15PD AITiN	mm	in			
order #	order #	order #					
6327859	6328115	6324504	12,200	.4803	2,1	45	14
6327860	6328116	6324505	12,300	.4843	2,1	45	14
6327861	6328117	6345124	12,304	.4844	2,1	45	14
6327862	6328118	6345125	12,400	.4882	2,1	45	14
6327863	6328119	6345126	12,500	.4921	2,2	45	14
6327864	6328120	6345127	12,600	.4961	2,2	45	14
6327865	6328121	6345128	12,700	.5000	2,2	45	14
6327866	6328122	6345129	12,800	.5039	2,2	45	14
6327867	6328123	6345130	12,900	.5079	2,2	45	14
6327868	6328124	6345271	13,000	.5118	2,2	45	14
6327869	6328125	6345272	13,096	.5156	2,3	45	14
6327870	6328126	6345274	13,100	.5157	2,3	45	14
6327881	6328127	6345275	13,200	.5197	2,3	45	14
6327882	6328128	6345276	13,300	.5236	2,3	45	14
6327883	6328129	6345277	13,400	.5276	2,3	45	14
6327884	6328130	6345278	13,500	.5315	2,3	45	14
6327885	6328141	6345279	13,600	.5354	2,3	45	14
6327886	6328142	6345280	13,700	.5394	2,4	45	14
6327887	6328143	6345291	13,800	.5433	2,4	45	14
6327888	6328144	6345292	13,891	.5469	2,4	45	14
6327889	6328145	6345293	13,900	.5472	2,4	45	14
6327890	6328146	6345294	14,000	.5512	2,4	45	14
6327891	6328147	6345295	14,100	.5551	2,4	48	16
6327892	6328148	6345296	14,200	.5591	2,5	48	16
6327893	6328149	6345297	14,288	.5625	2,5	48	16
6327894	6328150	6345298	14,300	.5630	2,5	48	16
6327895	6328151	6345299	14,400	.5669	2,5	48	16
6327896	6328152	6345300	14,500	.5709	2,5	48	16
6327897	6328153	6345311	14,600	.5748	2,5	48	16
6327898	6328154	6345312	14,684	.5781	2,5	48	16
6327899	6328155	6345313	14,700	.5787	2,5	48	16
6327900	6328156	6345314	14,800	.5827	2,6	48	16
6327901	6328157	6345315	14,900	.5866	2,6	48	16
6327902	6328158	6345316	15,000	.5906	2,6	48	16
6327903	6328159	6345317	15,083	.5938	2,6	48	16
6327904	6328160	6345318	15,100	.5945	2,6	48	16
6327905	6328161	6345319	15,200	.5984	2,6	48	16
6327906	6328162	6345320	15,300	.6024	2,6	48	16
6327907	6328163	6345321	15,400	.6063	2,7	48	16
6327908	6328164	6345322	15,479	.6094	2,7	48	16
6327909	6328165	6345323	15,500	.6102	2,7	48	16
6327910	6328166	6345324	15,600	.6142	2,7	48	16
6327911	6328167	6345325	15,700	.6181	2,7	48	16
6327912	6328168	6345326	15,800	.6220	2,7	48	16

(continued)

TOP DRILL S™ with Through Coolant • Stainless Steel

(TDS451A • 3 x D / TDS452A • 5 x D / TDS453A • 8 x D — continued)

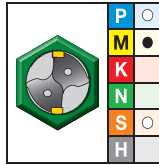
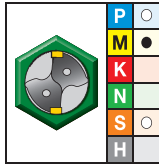
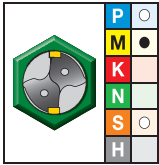

- first choice
- alternate choice

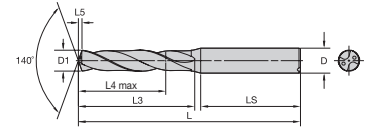

For information on L, L3, and L4 max, see the Dimension Table on page 77.

			D1 diameter		L5	LS	D
3 x D grade WM15PD AITiN	5 x D grade WM15PD AITiN	8 x D grade WM15PD AITiN	mm	in			
order #	order #	order #					
6327913	6328169	6345327	15,875	.6250	2,8	48	16
6327914	6328170	6345328	15,900	.6260	2,8	48	16
6327915	6328171	6345329	16,000	.6299	2,8	48	16
6327916	6328172	6345330	16,100	.6339	2,8	48	18
6327917	6328173	6345331	16,200	.6378	2,8	48	18
6327918	6328174	6345332	16,271	.6406	2,8	48	18
6327919	6328175	6345333	16,300	.6417	2,8	48	18
6327920	6328176	6345334	16,400	.6457	2,8	48	18
6327921	6328177	6345335	16,500	.6496	2,9	48	18
6327922	6328178	6345336	16,600	.6535	2,9	48	18
6327923	6328179	6345337	16,670	.6563	2,9	48	18
6327924	6328180	6345338	16,700	.6575	2,9	48	18
6327925	6328181	6345339	16,800	.6614	2,9	48	18
6327926	6328182	6345340	16,900	.6654	2,9	48	18
6327927	6328183	6345341	17,000	.6693	3,0	48	18
6327928	6328184	6345342	17,100	.6732	3,0	48	18
6327929	6328185	6345343	17,200	.6772	3,0	48	18
6327930	6328186	6345345	17,300	.6811	3,0	48	18
6327941	6328187	6345346	17,400	.6850	3,0	48	18
6327942	6328188	6345347	17,463	.6875	3,0	48	18
6327943	6328189	6345348	17,500	.6890	3,0	48	18
6327944	6328190	6345349	17,600	.6929	3,1	48	18
6327945	6328191	6345350	17,700	.6969	3,1	48	18
6327946	6328192	6345351	17,800	.7008	3,1	48	18
6327947	6328193	6345352	17,859	.7031	3,1	48	18
6327949	6328194	6345353	17,900	.7047	3,1	48	18
6327951	6328195	6345354	18,000	.7087	3,1	48	18
6327953	6328196	6345355	18,100	.7126	3,1	50	20
6327955	6328198	6345356	18,200	.7165	3,2	50	20
6327957	6328199	6345357	18,258	.7188	3,2	50	20
6327959	6328201	6345358	18,300	.7205	3,2	50	20
6327961	6328203	6345359	18,400	.7244	3,2	50	20
6327963	6328205	6345360	18,500	.7283	3,2	50	20
6327965	6328207	6345361	18,600	.7323	3,2	50	20
6327967	6328210	6345362	18,654	.7344	3,2	50	20
6327969	6328212	6345363	18,700	.7362	3,3	50	20
6327971	6328214	6345364	18,800	.7402	3,3	50	20
6327973	6328215	6345365	18,900	.7441	3,3	50	20
6327975	6328217	6345366	19,000	.7480	3,3	50	20
6327977	6328220	6345367	19,050	.7500	3,3	50	20
6327979	6328222	6345368	19,100	.7520	3,3	50	20
6327981	6328224	6345369	19,200	.7559	3,3	50	20
6327983	6328226	6345370	19,300	.7598	3,4	50	20
6327985	6328228	6345371	19,400	.7638	3,4	50	20

(continued)

TOP DRILL S™

TOP DRILL S with Through Coolant • Stainless Steel

(TDS451A • 3 x D / TDS452A • 5 x D / TDS453A • 8 x D — continued)

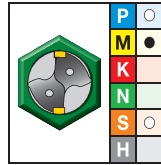
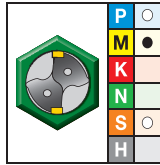
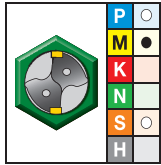

- first choice
- alternate choice

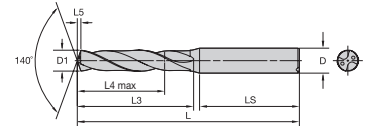

For information on L, L3, and L4 max, see the Dimension Table on page 77.

3 x D grade WM15PD AlTiN	5 x D grade WM15PD AlTiN	8 x D grade WM15PD AlTiN	D1 diameter		L5	LS	D
			mm	in			
order #	order #	order #					
6327987	6328230	6345372	19,500	.7677	3,4	50	20
6327989	6328232	6345373	19,600	.7717	3,4	50	20
6327991	6328234	6345374	19,700	.7756	3,4	50	20
6327993	6328236	6345375	19,800	.7795	3,4	50	20
6327995	6328238	6345376	19,900	.7835	3,5	50	20
6327997	6328240	6345377	20,000	.7874	3,5	50	20

nominal size range	tolerance	
	D1 tolerance m7	D tolerance h6
>3-6	0,004/0,016	0,000/-0,008
>6-10	0,006/0,021	0,000/-0,009
>10-18	0,007/0,025	0,000/-0,011
>18-25,4	0,008/0,029	0,000/-0,013

TOP DRILL S™ with Through Coolant • Stainless Steel

■ Dimensions for TDS451A • 3 x D/TDS452A • 5 x D/TDS453A • 8 x D • Metric

mm Ø				SHORT* ~3 x D			LONG* ~5 x D			EXTRA LONG** ~8 x D		
D1 min	D1 max	D	LS	L	L3	L4 max	L	L3	L4 max	L	L3	L4 max
3,000	3,734	6	36	62	20	14	66	28	23	78	40	33
3,800	4,700	6	36	66	24	17	74	36	29	87	49	41
4,763	6,000	6	36	66	28	20	82	44	35	94	56	48
6,100	7,000	8	36	79	34	24	91	53	43	105	67	57
7,100	8,000	8	36	79	41	29	91	53	43	113	74	64
8,100	10,000	10	40	89	47	35	103	61	49	135	92	80
10,100	12,000	12	45	102	55	40	118	71	56	158	110	96
12,100	14,000	14	45	107	60	43	124	77	60	176	128	112
14,100	16,000	16	48	115	65	45	133	83	63	197	146	128
16,100	18,000	18	48	123	73	51	143	93	71	214	163	144
18,100	20,000	20	50	131	79	55	153	101	77	234	181	160

* D1 < 20mm to DIN 6537K

* D1 > 20mm to factory standard













** to factory standard

■ TDS451/TDS452/TDS453 Series • WM15PD • Through Coolant • Metric









Material Group	Cutting Speed – vc Range – m/min			Tool Diameter (mm)	Recommended Feed Rate (f) by Diameter								
	min	-	max		3,0	4,0	6,0	8,0	10,0	12,0	16,0	20,0	
					mm/r	mm/r	mm/r	mm/r	mm/r	mm/r	mm/r	mm/r	mm/r
P	0	80	-	160	mm/r	0,05-0,11	0,08-0,14	0,09-0,19	0,11-0,22	0,13-0,26	0,15-0,30	0,19-0,36	0,24-0,46
	1	70	-	140	mm/r	0,05-0,13	0,08-0,19	0,11-0,24	0,14-0,30	0,16-0,35	0,18-0,39	0,20-0,46	0,23-0,51
	2	90	-	140	mm/r	0,05-0,13	0,08-0,17	0,11-0,20	0,14-0,24	0,16-0,28	0,18-0,32	0,20-0,37	0,23-0,41
	3	60	-	100	mm/r	0,08-0,13	0,12-0,19	0,14-0,24	0,17-0,30	0,20-0,35	0,22-0,39	0,26-0,46	0,29-0,51
	4	50	-	100	mm/r	0,08-0,12	0,11-0,18	0,12-0,23	0,15-0,28	0,17-0,33	0,19-0,37	0,22-0,43	0,25-0,48
	5	50	-	80	mm/r	0,03-0,11	0,04-0,11	0,05-0,11	0,05-0,14	0,08-0,18	0,11-0,21	0,14-0,24	0,16-0,26
M	6	40	-	70	mm/r	0,05-0,11	0,08-0,14	0,11-0,17	0,13-0,21	0,15-0,24	0,17-0,27	0,19-0,33	0,22-0,36
	1	50	-	90	mm/r	0,05-0,13	0,06-0,14	0,08-0,16	0,10-0,18	0,12-0,20	0,13-0,21	0,16-0,24	0,18-0,26
	2	50	-	80	mm/r	0,05-0,13	0,06-0,14	0,08-0,16	0,10-0,18	0,12-0,20	0,13-0,21	0,16-0,24	0,18-0,26
S	3	50	-	70	mm/r	0,05-0,13	0,06-0,14	0,08-0,16	0,10-0,18	0,12-0,20	0,13-0,21	0,16-0,24	0,18-0,26
	1	20	-	30	mm/r	0,03-0,06	0,04-0,08	0,06-0,10	0,08-0,12	0,09-0,13	0,10-0,14	0,12-0,16	0,14-0,18
	2	10	-	30	mm/r	0,02-0,04	0,03-0,06	0,05-0,08	0,07-0,10	0,08-0,11	0,09-0,12	0,10-0,14	0,11-0,16
	3	10	-	40	mm/r	0,02-0,04	0,02-0,05	0,04-0,07	0,06-0,09	0,07-0,10	0,08-0,11	0,09-0,13	0,10-0,15
	4	10	-	40	mm/r	0,02-0,04	0,03-0,06	0,05-0,08	0,07-0,10	0,08-0,11	0,09-0,12	0,10-0,14	0,11-0,16

Informational Icons Guide











Indexable Milling Icons

 Face Milling	 Helical Milling	 Ramping	 Slotting: Square End	 Side Milling/ Shoulder Milling: Square End
 3D Profiling	 Pocketing	 Cylindrical/Plain Shank	 Weldon® Shank	 Screw-On Shank
 Shell Mill	 Through Coolant			

Solid End Milling Icons

 Plunge Milling	 Ramping: Blank	 Ramping: 3°	 Slotting: Ball Nose	 Slotting: Ball Nose with AP Dimension
 Slotting: Square End	 Slotting: Square End with AP Dimension	 Trochoidal Milling	 Side Milling/ Shoulder Milling: Ball Nose	 Side Milling/ Shoulder Milling: Ball Nose with AE/AP Dimension
 Side Milling/ Shoulder Milling: Square End	 Side Milling/ Shoulder Milling: Square End with AE/AP Dimension	 Chamfer Milling	 Side/Shoulder Milling: Radius	 3D Profiling
 Corner Style: Ball Nose	 Corner Style: Corner Chamfer	 Corner Style: Corner Radius	 Corner Style: Square End	 Cylindrical/Plain Shank
 Shank: Duo-Lock™ Coupling	 Helix Angle: 0°	 Helix Angle: 20°	 Helix Angle: 30°	 Helix Angle: 38°
 Helix Angle: 45°	 Tool Dimensions: Flute Configuration: X (Variable)	 Tool Dimensions: Flute Configuration: 2	 Tool Dimensions: Flute Configuration: 3	 Tool Dimensions: Flute Configuration: 4
 Tool Dimensions: Flute Configuration: 5	 Tool Dimensions: Flute Configuration: 6	 Tool Dimensions: Flute Configuration: 7		

Holemaking Icons

 Drilling	 Drilling: Inclined Entry	 Drilling: Inclined Exit	 Drilling: Stacked Plates	 Drilling Depth: 3x
 Drilling Depth: 5x	 Drilling Depth: 8x	 Shank: Cylindrical Plain ≤h6	 Helix Angle: 30°	 Through Coolant: Radial: Drilling
 Tool Dimensions: 2-Flute/2-Margin/ Coolant				

DIN – German Institute for Standardisation
ISO – International Standardisation Organisation

Customer Application Support (CAS)

Get fast and reliable answers to your toughest metalcutting problems.

Our Customer Application Support (CAS) Team is the metalworking industry's leading help desk resource for tooling application solutions and problem resolution.

- Easy access to proven metalworking expertise.
- Service level excellence.
- Best-in-class application support tools and technology.

Easy access to proven metalworking expertise!

WIDIA™ Customer Application Engineers assist customers and engineering groups throughout the world with expert tool selection and application recommendations for the entire range of WIDIA tooling.

Service Level Excellence:

- Fast telephone response.
- Quick technical solutions.
- Efficient case management.

Services Provided:

- Tooling selection.
- Operating parameters.
- Troubleshooting.
- Process optimisation.
- Hardware support.

Best-in-Class Support Tools and Technology:

- Tooling performance experts.
- Materials database.
- Application calculators.

ORIGINATING COUNTRY	LANGUAGE	TEL	FAX	EMAIL
Australia	English	001-724-539-6921 *	001-724-539-6830 *	ap.techsupport@widia.com
Austria	German	0800 291630	0049-911-9735-429 *	eu.techsupport@widia.com
Belgium	English/French	0800 80410	0049-911-9735-429 *	eu.techsupport@widia.com
China	Chinese	400-889-2237	+86-21-58999985 *	w-cn.techsupport@widia.com
Denmark	English	808 89295	001-724-539-6830 *	na.techsupport@widia.com
Finland	English	0800 919413	001-724-539-6830 *	na.techsupport@widia.com
France	French	080 5540 379	0049-911-9735-429 *	eu.techsupport@widia.com
Germany	German	0800 1015774	0911-9735-429*	eu.techsupport@widia.com
India	English	1 800 103 5227	—	in.techsupport@widia.com
Israel	English	1809 449907	001-724-539-6830 *	na.techsupport@widia.com
Italy	Italian	800 916568	02 89512146 *	eu.techsupport@widia.com
Japan	English	001-724539-6921 *	001-724-539-6830 *	ap.techsupport@widia.com
Korea (South)	English	001-724539-6921 *	001-724-539-6830 *	ap.techsupport@widia.com
Malaysia	English	001-724539-6921 *	001-724-539-6830 *	ap.techsupport@widia.com
Netherlands	English	0800 0201131	001-724-539-6830 *	na.techsupport@widia.com
New Zealand	English	001-724539-6921 *	001-724-539-6830 *	ap.techsupport@widia.com
Norway	English	800 10081	001-724-539-6830 *	na.techsupport@widia.com
Poland	Polish	00800 4411943	06166 56504 *	eu.techsupport@widia.com
Russia (landline)	Russian	8800 5556395	0048 6166 56504 *	eu.techsupport@widia.com
Russia (cell phone)	Russian	+7 8005556395	0048 6166 56504 *	eu.techsupport@widia.com
Singapore	English	001-724539-6921 *	001-724-539-6830 *	ap.techsupport@widia.com
South Africa	English	0800 981644	001-724-539-6830 *	na.techsupport@widia.com
Sweden	English	020798794	001-724-539-6830 *	na.techsupport@widia.com
Taiwan	English	001-724539-6921 *	001-724-539-6830 *	ap.techsupport@widia.com
Thailand	English	001-724539-6921 *	001-724-539-6830 *	ap.techsupport@widia.com
United Kingdom	English	0800 028 2996	001-724-539-6830 *	na.techsupport@widia.com
Ukraine	Russian	800502665	0048 6166 56504 *	eu.techsupport@widia.com
USA	English	888 539 5145	001-724-539-6830 *	na.techsupport@widia.com

*Noted phone and fax numbers are not toll free.

Material Overview • DIN

DIN

P Steel	K Cast Iron	S High-Temp Alloys
M Stainless Steel	N Non-Ferrous	H Hardened Materials

material group	description	content	tensile strength RM (MPa)*	hardness (HB)	hardness (HRC)	material number
P0	Low-Carbon Steels, Long Chipping	C <0,25%	<530	<125	–	–
P1	Low-Carbon Steels, Short Chipping, Free Machining	C <0,25%	<530	<125	–	C15, Ck22, ST37-2, S235JR, 9SMnPb28, GS38
P2	Medium- and High-Carbon Steels	C >0,25%	>530	<220	<25	ST52, S355JR, C35, GS60, Cf53
P3	Alloy Steels and Tool Steels	C >0,25%	600–850	<330	<35	16MnCr5, Ck45, 21CrMoV5-7, 38SMn28
P4	Alloy Steels and Tool Steels	C >0,25%	850–1400	340–450	35–48	100Cr6, 30CrNiMo8, 42CrMo4, C70W2, S6525, X120Mn12
P5	Ferritic, Martensitic, and PH Stainless Steels	–	600–900	<330	<35	100Cr6, 30CrNiMo8, 42CrMo4, C70W2, S6525, X120Mn12
P6	High-Strength Ferritic, Martensitic, and PH Stainless Steels	–	900–1350	350–450	35–48	X102CrMo17, G-X120Cr29
M1	Austenitic Stainless Steel	–	<600	130–200	–	X5CrNi 18 10, X2CrNiMo 17 13 2, G-X25CrNiSi18 9, X15CrNiSi 20 12
M2	High-Strength Austenitic Stainless and Cast Stainless Steels	–	600–800	150–230	<25	X2CrNiMo 13 4, X5NiCr 32 21, X5CrNiNb 18 10, G-X15CrNi 25-20
M3	Duplex Stainless Steel	–	<800	135–275	<30	X8CrNiMo27 5, X2CrNiMoN22 5 3, X20CrNiSi25 4, G-X40CrNiSi27 4
K1	Grey Cast Iron	–	125–500	120–290	<32	GG15, GG25, GG30, GG40, GTW40
K2	Low- and Medium-Strength Ductile Irons (Nodular Irons) and Compacted Graphite Irons (CGI)	–	<600	130–260	<28	GGG40, GTS35
K3	High-Strength Ductile Irons and Austempered Ductile Iron (ADI)	–	>600	180–350	<43	GGG60, GTW55, GTS65
N1	Wrought Aluminium	–	–	–	–	AlMg1, Al99.5, AlCuMg1, AlCuBiPb, AlMgSi1, AlMgSiPb
N2	Low-Silicon Aluminium Alloys and Magnesium Alloys	Si <12,2%	–	–	–	GAISiCu4, GDAISi10Mg
N3	High-Silicon Aluminium Alloys and Magnesium Alloys	Si >12,2%	–	–	–	G-ALSi12, G-ALSi17Cu4, G-ALSi21CuNiMg
N4	Copper-, Brass-, Zinc-Based on Machinability Index Range of 70–100	–	–	–	–	CuZn40, Ms60, G-CuSn5ZnPb, CuZn37, CuSi3Mn
N5	Nylon, Plastics, Rubbers, Phenolics, Resins, Fibreglass	–	–	–	–	Lexan®, Hostalen™, Polystyrol, Makralon®
N6	Carbon, Graphite Composites, CFRP	–	–	–	–	CFK, GFK
N7	Metal Matrix Composites (MMC)	–	–	–	–	–
S1	Iron-Based, Heat-Resistant Alloys	–	500–1200	160–260	25–48	X1NiCrMoCu32 28 7, X12NiCrSi36 16, X5NiCrAlTi31 20, X40CoCrNi20 20
S2	Cobalt-Based, Heat-Resistant Alloys	–	1000–1450	250–450	25–48	Haynes® 188, Stellite® 6,21,31
S3	Nickel-Based, Heat-Resistant Alloys	–	600–1700	160–450	<48	INCONEL® 690, INCONEL 625, Hastelloy®, Nimonic® 75
S4	Titanium and Titanium Alloys	–	900–1600	300–400	33–48	Ti1, TiAl5Sn2, TiAl6V4, TiAl4Mo4Sn2
H1	Hardened Materials	–	–	–	44–48	GX260NiCr42, GX330NiCr42, GX300CrNiSi952, GX300CrMo153, Hardox® 400
H2	Hardened Materials	–	–	–	48–55	–
H3	Hardened Materials	–	–	–	56–60	–
H4	Hardened Materials	–	–	–	>60	–

Find your Local WIDIA Authorised Distributor

WIDIA™ brand cutting tools are available exclusively through a specialised network of Authorised Distributor partners whom you can count on to deliver much more than products. Our distributors know us, and more importantly, they know you. They know better than anyone in the industry how to put the global power of WIDIA to work for you — in your industry, in your region, and for your business.

WIDIA distributor partners provide technical expertise that you can count on. They will show you how to:

- Significantly reduce cycle time.
- Improve machine tool utilisation.
- Achieve measurable productivity improvements.
- Take advantage of proven supply chain solutions.
- Access local inventory and best-in-class technical support.
- Request onsite demonstrations of the latest tooling technology.

And with thousands of turning, milling, holmaking, tapping, and tooling systems products available from WIDIA, you'll find everything you need from one single source.



Find your Local WIDIA Authorised Distributor by accessing our distributor finder at widia.com.

IMPORTANT SAFETY INSTRUCTIONS: READ BEFORE USING THE TOOLS IN THIS CATALOGUE

METALCUTTING SAFETY

Projectile and Fragmentation Hazards

Modern metalcutting operations involve high spindle and cutter speeds and high temperatures and cutting forces. Hot metal chips may fly off the workpiece during metalcutting. Although cutting tools are designed and manufactured to withstand high cutting forces and temperatures, they can sometimes fragment, particularly if they are subjected to over-stress, severe impact, or other abuse.

To avoid injury:

- Always wear appropriate personal protective equipment, including safety goggles, when operating metalcutting machines or working nearby.
- Always make sure all machine guards are in place.

Breathing and Skin Contact Hazards

Grinding carbide or other advanced cutting tool materials produces dust or mist containing metallic particles. Breathing this dust or mist — especially over an extended period — can cause temporary or permanent lung disease or make existing medical conditions worse. Contact with this dust or mist can irritate eyes, skin, and mucous membranes and may make existing skin conditions worse.

To avoid injury:

- Always wear breathing protection and safety goggles when grinding.
- Provide ventilation control and collect and properly dispose of dust, mist, or sludge from grinding.
- Avoid skin contact with dust or mist.

For more information, read the applicable Material Safety Data Sheet provided by WIDIA and consult General Industry Safety and Health Regulations, Part 1910, Title 29 of the Code of Federal Regulations.

These safety instructions are general guidelines. Many variables affect machining operations. It is impossible to cover every specific situation. The technical information included in this catalogue and recommendations on machining practices may not apply to your particular operation.

For more information, consult the WIDIA Metalcutting Safety booklet, available free from WIDIA at +1 724 539 5747 or fax +1 724 539 5439. For specific product safety and environmental questions, contact our Corporate Environmental Health and Safety Office at +1 724 539 5066 or fax +1 724 539 5372.

AluSurf, ArCut, ERICKSON, TOP DRILL S, VariDrill, VariMill, VariMill II, VariMill III, Victory, VSM11, VSM17, VSM490, VSM490-10, VSM490-15, WavCut, WIDIA, WIDIA-Hanita, and X-Feed are trademarks of Kennametal, Inc. and are used as such herein. The absence of a product, service name, or logo from this list does not constitute a waiver of the Kennametal trademark or other intellectual property rights concerning that name or logo.

DUO-LOCK® is a registered trademark and Duo-Lock™ is a trademark of Haimer GmbH.

Weldon® is a registered trademark of Weldon Tool Company.

©Copyright 2017 by Kennametal Inc., Latrobe, PA 15650. All rights reserved.

WIDIA 

WORLD HEADQUARTERS
WIDIA Products Group
Kennametal Inc.
1600 Technology Way
Latrobe, PA 15650 USA
Tel: 1 800 979 4342
w-na.service@widia.com

EUROPEAN HEADQUARTERS
WIDIA Products Group
Kennametal Europe GmbH
Rheingoldstrasse 50
CH 8212 Neuhausen am Rheinfall
Switzerland
Tel: +41 52 6750 100
w-ch.service@widia.com

ASIA-PACIFIC HEADQUARTERS
WIDIA Products Group
Kennametal (Singapore) Pte. Ltd.
3A International Business Park
Unit #01-02/03/05, ICON@IBP
Singapore 609935
Tel: +65 6265 9222
w-sg.service@widia.com

INDIA HEADQUARTERS
WIDIA Products Group
Kennametal India Limited
CIN: L27109KA1964PLC001546
8/9th Mile, Tumkur Road
Bangalore - 560 073
Tel: +91 80 2839 4321
w-in.service@widia.com

METRIC 2018

ADVANCES

WIDIA 

widia.com