



Solid End Milling

Solid End Milling Introduction	K2-K17
High-Performance Solid Carbide End Mills	L1-L150
General Purpose Solid Carbide End Mills	M1-M43



End Mills									
Z = number of teeth		Fine Finishing	Finishing	Roughing	Slot Milling	Plunging	Contour Milling	Peel Milling	Trochoidal Milling
end mill Z = 1		○	○	●	●	●	○	○	○
end mill Z = 2		○	○	◐	●	●	○	○	○
end mill Z = 3		○	◐	◐	●	◐	○	○	○
end mill Z = 4/5		◐	●	●	●*	○	○	●	●
multi-flute cutter Z = 6-8		●	●	○	○	○	○	●	●
Ball Nose and Torus End Mills									
ball nose end mill Z = 2					●		●		
ball nose end mill Z = 4					◐		●		

*VariMill™/VariMil™ GP Only

- first choice
- suitable with limitations
- not recommended

Always select a tool with the shortest possible flute length whenever possible. This will increase the stability of the tool and give the best results.

When selecting an end mill, the following machining factors will affect your selection of the correct end mill for your application:

1. Tool overhang.
2. Coolant flow.
3. Machine and setup stability.
4. Machine power and torque.
5. Material to be machined.
6. Machine adaptor size (CV40, CV50, HSK63, etc.).
7. See Tool Reference Guides on pages K6-K11.

	Materials	Recommended Series																								Page Reference			
		P						M			K			N						S				H					
		Steels & Alloyed Steels						Stainless Steel			Cast Iron			Non-Ferrous						High-Temp Alloys & Titanium				Hardened Materials					
	0	1	2	3	4	5	6	1	2	3	1	2	3	1	2	3	4	5	6	1	2	3	4	1	2	3	4		
Type of Cut	Roughing																												
	DQ13																												L54
	4U40, 4U70																												L58-L59
	X-Feed™ 70N6																												L140
	X-Feed 70N7																												L141
	4909, 4979																												L131-L132
	Semi-Finishing																												
	VariMill I™ – 4777																												L4-L5
	VariMill II™ – 577C																												L24
	VariMill II ER – 577E																												L32
	VariMill III™ ER – 771E, 772E																												L45
	AluSurf™ 5102, 5103																												L124-L125
	Finishing																												
	D507, D517																												L90
	VariMill III ER – 77NE, 771E, 772E																												L44-L45
	AluSurf 5102, 5103																												L124-L125
	Finishing Pockets																												
	VariMill I – 4777																												L4-L5
	VariMill II – 57NC																												L25-L26
	VariMill II ER – 57NE																												L33
	VariMill III ER – 77NE																												L44
	AluSurf 51N3																												L126
	Long Wall Milling																												
	VariMill II Long – 5718																												L38-L39
VariMill III ER – 772E																												L45	
3D Ball Nose																													
VariMill I – 47N0																												L12	
HPC/Peel Milling																													
VariMill I – 4777, 4778																												L4-L6	
VariMill II – 577C																												L24	
VariMill II ER – 577E																												L32	
VariMill II Long – 5718																												L38-L39	
VariMill III ER – 77NE, 771E, 772E																												L44-L45	
AluSurf 5102, 5103																												L124-L125	
Trochoidal Milling																													
VariMill I – 4777, 4778																												L4-L6	
VariMill II – 577C																												L24	
VariMill II ER – 577E																												L32	
VariMill III ER – 771E, 772E																												L45	
AluSurf 5102, 5103																												L124-L125	

■ Best Selection Per Application

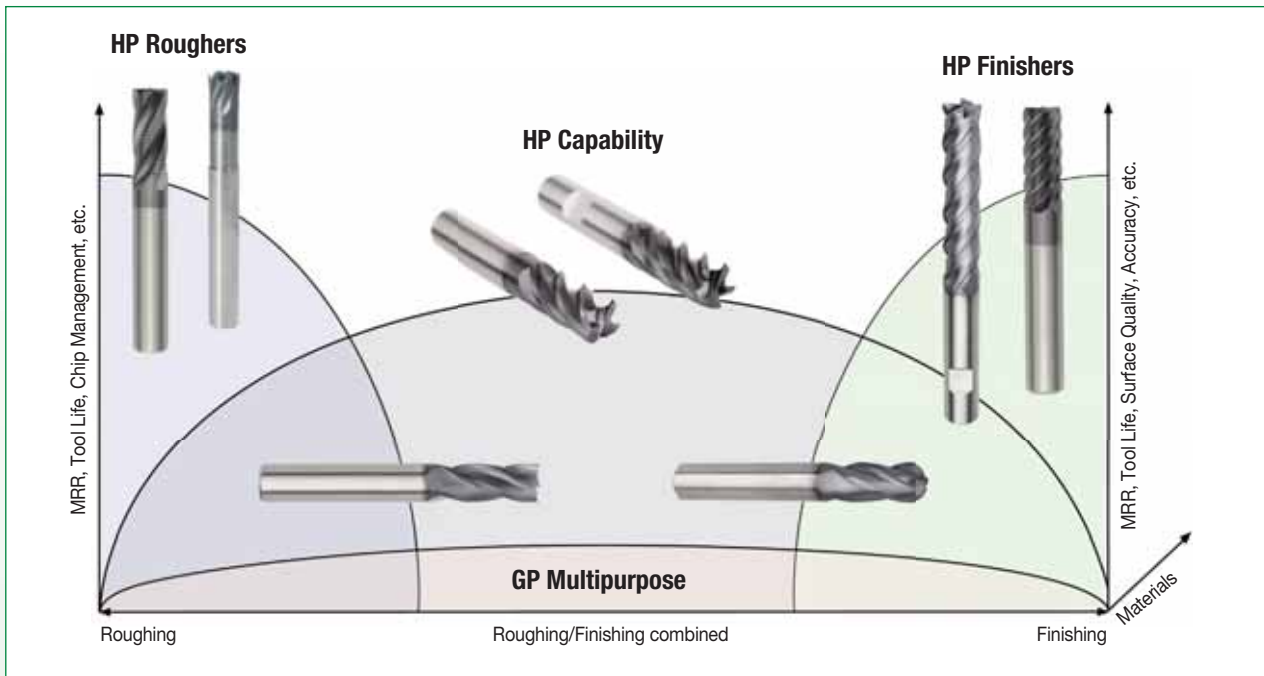

■ Best Selection For Trochoidal/High-Speed Machining Concepts

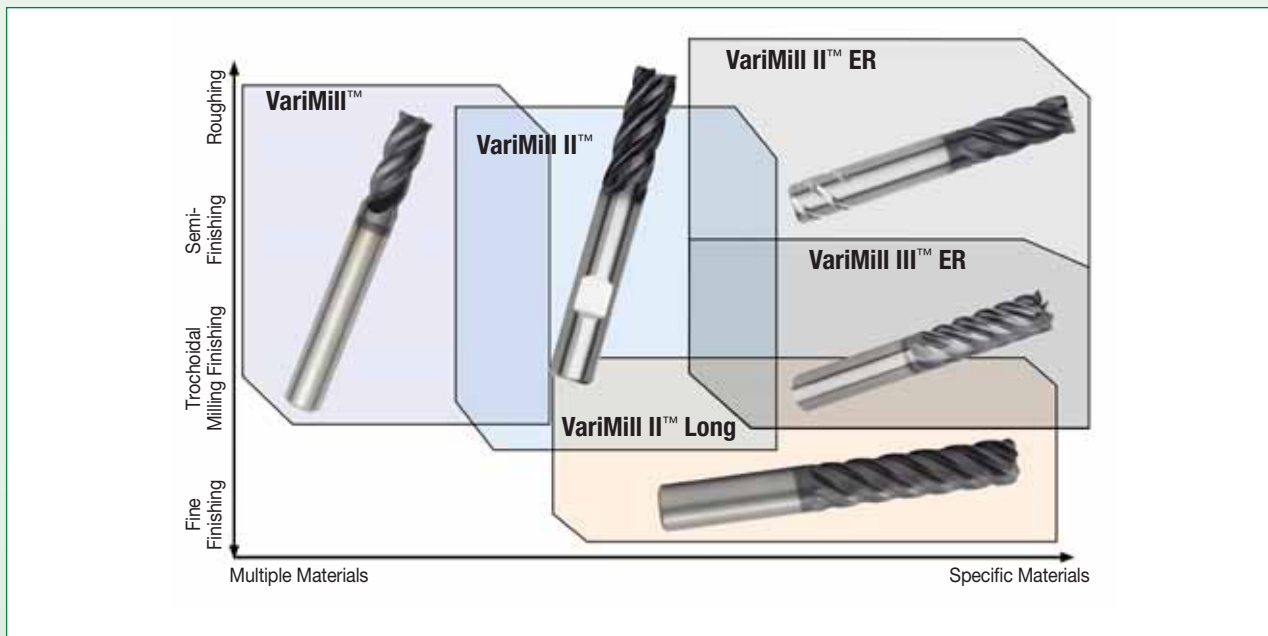

■ Recommended Adaptors per End Mill Platform

SCEM Platform	Recommended Adaptors	
	First Choice	Alternate Choice
VariMill I™	HydroForce™	Shrink Fit
VariMill II™/VariMill II™ ER	HydroForce	Shrink Fit
VariMill III™ ER	HydroForce	Shrink Fit
VariMill II™ Long	HydroForce	Shrink Fit
High-Performance Finishers	HydroForce	Shrink Fit
High-Performance Roughers	HydroForce	Weldon Adaptor
AluSurf™/Aluminium Tools	HydroForce	Shrink Fit
VisionPlus™/VisionPlus X-Feed™	HydroForce	Shrink Fit
VariMill GP	Shrink Fit	Weldon Adaptor

■ Select Adaptor per Technical Data/Characteristics



























Technical data/characteristics	Toolholders				
	HydroForce high torque	Shrink Fit	Milling chuck	ER collet chuck	Weldon® adaptor
torque transmission	★★★★★	★★★★	★★★★★	★★	★★★★★
radial runout (T.I.R.) ¹	★★★★★	★★★★★	★★★★	★★★	★
radial rigidity ²	★★★★	★★★★★	★★★	★★★	★★★
tool length adjustment	★★★★★	★★★★	★	★★★★	★★
tool shank tolerance requirement	★★★★	★★	★★★	★★★★★	★★★
through coolant	★★★★★	★★★★★	★★★	★★★	★★
minimum quantity lubrication (MQL)	★★★★★	★★★★★	★	★	★
dampening capability	★★★★★	★	★★★	★★★	★★★
shank diameter range ³	★★★★★	★	★★★★★	★★★★★	★
cost of toolholder	★★	★★★	★	★★★★	★★★★★
low requirement of external devices ⁴	★★★★★	★	★★★★	★★★★	★★★★★
ease of handling	★★★★★	★★★	★★	★★★★	★★★★
dust resistance	★★★★★	★★★★★	★★★	★★★	★★★★
high-speed capability	★★★★★	★★★★★	★★★	★★★	★
balancing accuracy	★★★★★	★★★★★	★★★	★★★	★

¹ Radial runout may affect tool life.



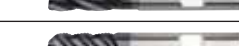
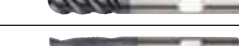

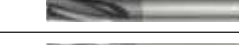











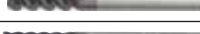







² Radial rigidity for Weldon holder is low at a direction perpendicular to the screw.

³ Accepts different shank diameters through the use of reduction sleeves or due to collapse range.





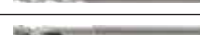
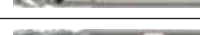

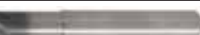







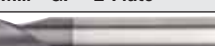

⁴ Collet chucks and milling chucks may require the use of a torque or special wrench; Shrink Fit adaptor requires a shrinking unit.

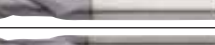
	Series	Range of Diameter Ø min- Ø max mm	Number of Flutes	Cutting Centre	Uncoated	TiCN	AlTiN	TiAlN	DCL TiB ₂	Diamond	PCD	<input checked="" type="radio"/> first choice <input type="radio"/> alternate choice
High-Performance Solid Carbide End Mills • VariMill™												
VariMill I™												
	4777	4-25	4	Yes			X					
	4778	4-25	4	Yes			X					
	4717	6-20	4	Yes				X				
	4727	12-20	4	Yes				X				
	47N7 ALTIN	4-20	4	Yes			X					
	47N7 TIALN	4-20	4	Yes				X				
	47N6	6-20	4	Yes				X				
	47N0	5-20	4	Yes			X					
VariMill II™												
	577C	4-25	5	Yes			X					
	57NC	6-25	5	Yes			X					
VariMill II™ ER												
	577E	10-25	5	Yes			X					
	57NE	10-25	5	Yes			X					
VariMill II™ Long												
	5718	6-25	5	No			X					
VariMill III™ ER												
	77NE	10-20	7	Yes			X					
	771E/772E	10-20	7	Yes			X					
High-Performance Solid Carbide End Mills • Roughing												
	DQ13	3-20	3	Yes			X					
	49H6	8-20	3/4	Yes				X				
	4976	4-25	3/4/5	Yes			X					
	422824/422820	6-25	4	Yes				X				
	4U40	6-25	4/6	Yes			X					
	4U70	6-25	4/6	Yes			X					
	49N6	4-25	3/4/5	Yes			X					
	4969	5-20	3/4	Yes				X				
	422813/022813	6-25	3	Yes	X			X				
	422818	6-20	4	Yes	X			X				
	422846	6-25	4/6	Yes	X			X				
	4906	4-25	3/4/5	Yes		X		X				
	4966	5-25	3/4	Yes		X		X				

	P				M	K	N				S				H		Page References	
	1 2 3	4	5	6	1 2 3	1 2 3	1 2 3 4 5	6	1	2	3	4	1 2	3 4				
	Steel <35 HRC	Steel >36-48 HRC	PH and Ferritic Stainless Steel <35 HRC	PH and Ferritic Stainless Steel >35 HRC	Stainless Steel	Cast Iron	Non-Ferrous	Graphite	Iron Based	Nickel Based	Pure Titanium	Titanium Alloys	Hardened Steels H1 = <48 HRC H2 = 48-55	H3 = 56-60 HRC H4 = >60 HRC	Product Information	Cutting Data		
High-Performance Solid Carbide End Mills • VariMill™ (continued)																		
VariMill I™ (continued)																		
	●	●	○	○	●	●			○	○	○	○	○		L4-L5	L13		
	●	●	●	●	●	○			○	●	●	●	●		L6	L14		
	●	●	●	●	●	○			●	●	●	●	●		L7	L15		
	●	●	●	●	●	○			●	●	●	●	●		L8	L16		
	●	●	●	●	●	○			●	●	●	●	●		L9-L10	L17		
	●	●	○	○	●	○			○	○	○	○	○		L9-L10	L18		
	●	●	○	○	●	○			○	○	○	○	○		L11	L19		
	●	●	○	○	●	●			○	○	○	○	○		L12	L20		
VariMill II™ (continued)																		
	●	●	○	○	●	●			○	○	○	○	○		L24	L27		
	○	●	●	●	●	○			○	●	●	●	●		L25-L26	L28		
VariMill II™ ER (continued)																		
	○	○	●	●	●	○			●	●	●	●	●		L32	L34		
	○	○	●	●	●	○			●	●	●	●	●		L33	L35		
VariMill II™ Long (continued)																		
	●	●	●	●	●	○			○	●	●	●	●		L38-L39	L40		
VariMill III™ ER (continued)																		
			○	○	○					●	●	●	○		L44	L46		
			○	○	○					●	●	●	○		L45	L47-L48		
High-Performance Solid Carbide End Mills • Roughing (continued)																		
	●	●	●	○	○	○			○	○	○	○	○		L54	L67		
	●	●	●	○	●	●			●	●	●	●	○		L55	L68		
	●	●	○	○	●	●			○	○	○	○	○		L56	L69		
	●	●	○	○	●	●			○	○	○	○	○		L57	L70		
	○	●	●	●	●	○			○	○	○	○	○		L58	L71		
	○	●	●	●	●	○			○	○	○	○	○		L59	L72		
	●	●	○	○	○	●			○	○	○	○	○		L60	L73		
	●	●	○	○	○	●			○	○	○	○	○		L61	L74		
	●	●			●	●									L62	L75		
	●	●			●	●									L63	L76		
	●	●			●	●									L64	L77		
	●	●	●	●	●	●	○		○	○	○	○	○		L65	L78		
	●	●	●	●	●	●	●		○	○	○	○	○		L66	L79		

	Series	Range of Diameter Ø min- Ø max mm	Number of Flutes	Cutting Centre	Uncoated	TiCN	AlTiN	TiAlN	DCL TiB ₂	Diamond	PCD	<input checked="" type="radio"/> first choice <input type="radio"/> alternate choice
High-Performance Solid Carbide End Mills • Finishing												
	4001 JJ	1-20	2	Yes			X					
	D503/D513	2-20	3	Yes	X	X		X				
	DC03	3-20	3	Yes				X				
	4503 JJ	1-20	3	Yes			X					
	422802/322802/022802	2-20	3	Yes	X	X		X				
	4603	3-20	3	Yes				X				
	D507/D517	6-20	6	Yes			X					
	422826/422822	6-25	6/8	No			X					
	422827	6-25	6/8	No			X					
	D518	4-25	4/6/8	Yes			X					
	026621	8-20	4/6/8	No	X							
	024112	6-10	2	Yes						X		
	024111	2-12	2	Yes						X		
High-Performance Solid Carbide End Mills • Micro End Mills												
	423007/023007	0,4-3,0	2	Yes	X		X					
	4632	0,4-2,0	2	Yes	X			X				
	4633	0,4-3,0	3	Yes	X			X				
	4651	1,0-2,0	2	Yes	X	X		X				
High-Performance Solid Carbide End Mills • Aluminium												
AluSurf™												
	5102	1,5-20	2	Yes	X							
	5103	3-20	3	Yes	X							
	51N3	6-20	3	Yes	X							
High-Performance Aluminium												
	524149	3-12	1	Yes					X			
	4909	6-25	3	Yes	X							
	4979	6-25	3	Yes	X	X						
	49N9	6-20	3	Yes	X							
	49G9	8-25	3	Yes		X						
High-Performance Solid Carbide End Mills • Hard Materials												
VisionPlus™ X-Feed™												
	70N6/71N6	6-20	6	No			X					
	70N7	6-20	6	No			X					

P		M		K		N			S				H		Page References	
1 2 3	4	5	6	1 2 3	1 2 3	1 2 3 4 5	6	1	2	3	4	1 2	3 4	Product Information	Cutting Data	
Steel <35 HRC	Steel >36-48 HRC	PH and Ferritic Stainless Steel <35 HRC	PH and Ferritic Stainless Steel >35 HRC	Stainless Steel	Cast Iron	Non-Ferrous	Graphite	Iron Based	Nickel Based	Pure Titanium	Titanium Alloys	Hardened Steels H1 = <48 HRC H2 = 48-55	H3 = 56-60 HRC H4 = >60 HRC			
High-Performance Solid Carbide End Mills • Finishing (continued)																
●	●			●		○								L82	L97	
●	●	○	○	●	●			●	●	●	●	○		L83	L98-L99	
●	●	○	○	○	○			●	●	●	●	○		L84	L100	
●	●	○	○	●	○			○	○	○	○	○		L85	L101	
●	●	●	●	●	●			●	●	●	●	○		L86-L88	L102	
●	●	○	○	●	●			●	●	●	●	○		L89	L103	
●	●	○	○	●	●			○	○	○	○	○		L90	L104-L105	
●	●			●	●									L91	L106	
●	●	●	●	●	●			●	●	●	●	○		L92	L107	
●	●	●	●	●	○			○	○	○	○			L93	L108	
●	●	○	○		●									L94	L109	
						●								L95	L110	
						●								L96	L111	
High-Performance Solid Carbide End Mills • Micro End Mills (continued)																
●	●	●	●	●	●	●	●	○	○	○				L114	L118	
●	●	●	●	●	●	●								L115	L119	
●	●	●	●	●	●	●								L116	L120	
●	●	●	●	●	●	●								L117	L121	
High-Performance Solid Carbide End Mills • Aluminium (continued)																
AluSurf™ (continued)																
						●	○							L124	L127	
						●	○							L125	L127	
						●	○							L126	L127	
High-Performance Aluminium (continued)																
						●	●							L130	L135	
						●	○							L131	L135	
						●	○							L132	L136	
						●	○							L133	L136	
						●	○							L134	L137	
High-Performance Solid Carbide End Mills • Hard Materials (continued)																
VisionPlus™ X-Feed™ (continued)																
		○										●	●	L140	L142	
		○										●	●	L141	L143	

	Series	Range of Diameter Ø min- Ø max mm	Number of Flutes	Cutting Centre	Uncoated	TiCN	AlTiN	TiAlN	DCL TiB ₂	Diamond	PCD
General Purpose Solid Carbide End Mills • Roughing/Finishing											
NINA™											
	423002/323002/ 423001/323001	2-12	3	Yes		X		X			
	423004/423003	4-12	4	Yes			X				
	423048/423047	2-12	2	Yes			X				
	423039/423038	2-12	2	Yes			X				
	423036/423037	6-10	4	No			X	X			
VariMill™ GP • 2-Flute											
	D002/D012	2-20	2	Yes	X			X			
	2819	3-20	2	Yes	X			X			
	4002/4012	1-20	2	Yes				X			
	D001 D011	2-20	2	Yes				X			
	2838	2-20	2	Yes	X			X			
	4001/4011/4021	1-20	2	Yes	X			X			
VariMill GP • 4-Flute											
	D004/D014	2-20	4	Yes	X			X			
	2528	4-20	4	Yes	X			X			
	4004/4014/4024	1-20	4	Yes	X			X			
	D010	3-20	4	Yes	X			X			
	2848	4-20	4	Yes	X			X			
	4000/4010	2-20	4	Yes				X			

P				M			K				N				S				H		Page References	
1	2	3	4	1	2	3	1	2	3	4	5	6	1	2	3	4	1	2	3	4	Product Information	Cutting Data
Steel <35 HRC	Steel >36-48 HRC	PH and Ferritic Stainless Steel <35 HRC	PH and Ferritic Stainless Steel >35 HRC	Stainless Steel	Cast Iron	Non-Ferrous	Graphite	Iron Based	Nickel Based	Pure Titanium	Titanium Alloys	Hardened Steels H1 = <48 HRC H2 = 48-55 H3 = 56-60 HRC H4 = >60 HRC										
General Purpose Solid Carbide End Mills • Roughing/Finishing (continued)																						
NINA™ (continued)																						
●	●	●	●	●	●	●	●													M4	M9	
●	●	●	●	●	●	●														M5	M9	
●	●	●	●	●	●	●														M6	M10	
●	●	●	●	●	●	●														M7	M10	
●	●	●	●	●	●	●	●	●	●	●	●	●	●							M8	M11	
VariMill™ GP • 2-Flute (continued)																						
●	●	●	●	●	●	●														M14-M15	M23	
●	●	●	●	●	●	●														M16	M23	
●	●	●	●	●	●	●														M17-M18	M23-M24	
●	●	●	●	●	●	●														M19	M25	
●	●	●	●	●	●	●														M20	M25	
●	●	●	●	●	●	●														M21-M22	M25-M26	
VariMill GP • 4-Flute (continued)																						
●	●	●	●	●	●	●														M32-M33	M40-M41	
●	●	●	●	●	●	●														M34	M41	
●	●	●	●	●	●	●														M35-M36	M40-M41	
●	●	●	●	●	●	●														M37	M42	
●	●	●	●	●	●	●														M38	M42	
●	●	●	●	●	●	●														M39	M42-M43	

Victory™ Grades for High-Performance
Solid Carbide End Mills

Victory



WIDIA™ has taken the next step in solid carbide end mill innovation by introducing the Victory™ Grades WP15PE™ and WS15PE™. Victory combines state-of-the-art surface treatments and proprietary edge technology with the successful market-leading WIDIA geometries, delivering significant improvement to tool life and Metal Removal Rates (MRR). The new Victory Grades can be found across the entire high-performance offering, which includes the VariMill™ family, high-performance roughers, and high-performance finishers.

Features and Benefits

- Innovative edge preparation providing consistent tool life by eliminating most edge microchipping caused by grinding.
- Advanced post-coat finish reducing chip build-up and improving chip flow.
- First-time use of Victory Grade nomenclature for better identification of grades.
- Centre cutting addition on VariMill II™.

Innovative Advantage of Victory™ Grades

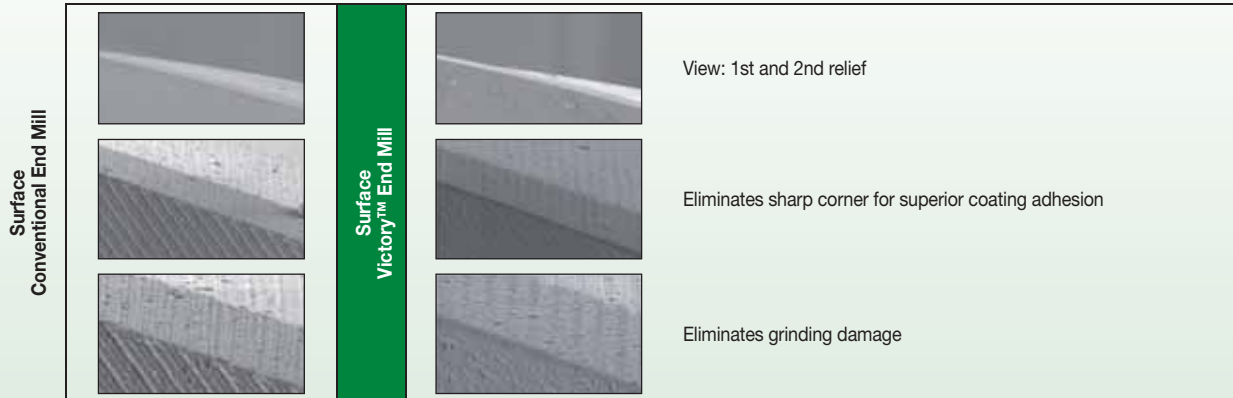

<p>WP15PE™ W = WIDIA™ P = Steels 15 = Application Range (Medium to Roughing) P = Carbide + PVD E = Solid End Mills</p>	<p>WS15PE™ W = WIDIA™ S = High-Temp Alloys 15 = Application Range (Medium to Roughing) P = Carbide + PVD E = Solid End Mills</p>
Primary Materials	Primary Materials
P0 through P4 Steels M1 through M3 Austenitic Stainless Steels K1 through K3 Cast Irons H1 Hardened Steels	S1 through S4 High-Temp Alloys P5 through P6 Ferritic and Martensitic Stainless Steels H1 Hardened Steels
Secondary Materials	Secondary Materials
S1 through S4 High-Temp Alloys H2 Hardened Steels	M1 through M3 Austenitic Stainless Steels H2 Hardened Steels

The new Victory grades are spread across the high-performance offering, including high-performance roughers, high-performance finishers, and select VariMill™ platforms.



Metric	series	Victory Grade		● first choice ○ alternate choice					
		WP15PE	WS15PE	P	M	K	N	S	H
VariMill I™	4777, 47N0	✓		●	●	●		○	○
VariMill II™	577C	✓		●	●	●		○	○
VariMill II™	57NC		✓	○	○			●	○
VariMill II™ ER	577E, 57NE		✓	○	○			●	○
HP Roughers	DQ13, 4976, 4U40, 4U70	✓		●	●	●		○	○
HP Finishers	4001JJ, 4503JJ, D507, D518	✓		●	●	●		○	○

How do the new Victory Catalogue numbers work?

Each character in our catalogue number signifies a specific trait of that product. Use the following key columns and corresponding images to easily identify which attributes apply.

OLD Grade Nomenclature • Metric

Series Number			250
5	77	7	
Series			Cutting Diameter
5 = 5-Flute Carbide 4 = 4-Flute Carbide			010 = 1mm 020 = 2mm 030 = 3mm 040 = 4mm 050 = 5mm 060 = 6mm 070 = 7mm 080 = 8mm 090 = 9mm 100 = 10mm 120 = 12mm 140 = 14mm 160 = 16mm 180 = 18mm 200 = 20mm 250 = 25mm 320 = 32mm

NEW Victory Nomenclature • Metric

Series Number					
577	C	250	0	8	W
Series	Special Designation	Cutting Diameter	Corner Condition	Shank Diameter	Shank Style
5 = 5-Flute Carbide 4 = 4-Flute Carbide	C = Centre Cutting	010 = 1mm 020 = 2mm 030 = 3mm 040 = 4mm 050 = 5mm 060 = 6mm 070 = 7mm 080 = 8mm 090 = 9mm 100 = 10mm 120 = 12mm 140 = 14mm 160 = 16mm 180 = 18mm 200 = 20mm 250 = 25mm 320 = 32mm	0 & Z = Sharp 1 = 0,75 2 = 0,50 3 = 1,00 4 = 1,50 5 = 2,00 6 = 2,50 7 = 3,00 8 = 4,00	2 = 6mm 3 = 8mm 4 = 10mm 5 = 12mm 6 = 16mm 7 = 20mm 8 = 25mm 9 = 32mm	T = Plain W = Weldon® V = SAFE-LOCK®

By referencing this easy-to-use guide, you can identify the correct product to meet your needs.

OLD Grade Nomenclature • Metric

0	8	M	W
Corner Condition	Shank Diameter	Grade	Shank Style
<p>0 = Sharp 1 = Radius</p>	<p>2 = 6mm 3 = 8mm 4 = 10mm 5 = 12mm 6 = 16mm 7 = 20mm 8 = 25mm 9 = 32mm</p>	<p>L = TiAlN M = AlTiN C = TiCN R = TiAlN J = Uncoated</p>	<p>T = Plain W = Weldon® J = JIS</p>

NEW Victory Nomenclature • Metric

W	P	15	P	E
Brand	ISO Material Code	Wear Range	Coating Type	Product Family
WIDIA™	<p>P = Steel S = High-Temperature Alloys</p>	15 = High Wear	P = PVD	E = End Mill



Reconditioning Services

WIDIA™ Reconditioning Services Optimise the Total Value of Metalcutting Tools Throughout Their Entire Life

WIDIA Reconditioning Services optimise the value of metalcutting tools throughout their entire lifecycle by giving like-new performance — with rapid turnaround time — so tools are always on hand and perform just like new.

- Local support you can trust.
- Rapid turnaround to minimise inventory.
- Like-new performance continues delivering productivity.
- Application support throughout the tool lifecycle.
- WIDIA proprietary geometry specifications after each regrind.
- WIDIA certified coatings.
- Easy logistics through the reconditioning process.

Simple Logistics

Our unique reconditioning program simplifies sending and receiving reconditioned tools to reduce shipping time and increase on-hand inventory.

To use WIDIA tool reconditioning services, contact your authorised WIDIA distributor to get started.





Global Reconditioning Network



To locate a Reconditioning Center near you, visit widia.com/services.





Solid End Milling • High-Performance Solid Carbide End Mills

VariMill.....	L2-L48
Roughing.....	L50-L79
Finishing.....	L80-L111
Micro Solid Carbide End Mills.....	L112-L121
Aluminium.....	L122-L137
Hard Materials.....	L138-L143
Trochoidal Milling.....	L144-L150



High-Performance Solid Carbide End Mills •
VariMill I™

VariMill I



VariMill I offers plunging, slotting, and profiling at the highest possible feed rates for a wide range of materials. They are designed to provide maximum Metal Removal Rates (MRR) and to achieve superior surface conditions. A wide range of diameters and corner configurations, such as chamfer, radii, and sharp edges, are available from stock.

- High-performance universal tools for almost all workpiece materials.
- Roughing and finishing with one tool.
- Various length-of-cut, long reach and necked versions, ball nose, corner chamfer, and corner radius available.

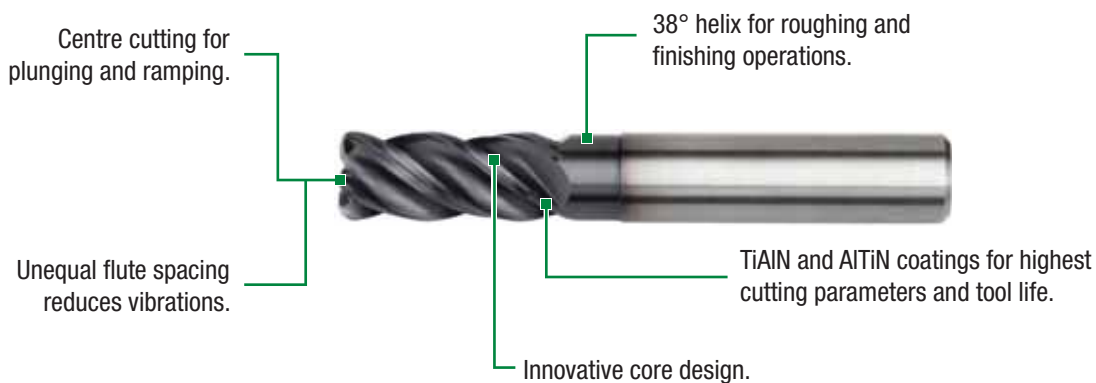

VariMill I™ Series

- Increase your output with less tool changes and increased Metal Removal Rates (MRR).
- No specific tools for roughing and finishing required.
- Less passes due to 1 x D slotting capability (not recommended for 4717 and 4727).

4777 Series

- High metal removal rates and tool life in:
 - Stainless steels, steels, and alloyed steels.
 - High-temperature alloys and titanium.



4778 AiTiN Series

- Titanium geometry design.
- Corner radii.



4717 Series

- Stainless steel and steel geometry design.
- 3,5 x D length-of-cut.
- Less passes necessary for long wall machining.



4727 TiAlN Series

- Stainless steel and steel geometry design.
- 5–6 x D length-of-cut.
- Less passes necessary for long wall machining.



47N7 TiAlN Series

- Stainless steel and steel geometry design.
- Radii corner and neck design for cutting depths requiring additional passes.



47N7 AiTiN Series

- Titanium and stainless steel geometry design.
- Radii corner and neck design for cutting depths requiring additional passes.



47N6 Series

- Stainless steel and steel geometry design.
- Benefit from long reach and neck design for deep cavities.



47N0 Series

- Stainless steel and steel geometry design.
- Centre cutting ball nose.



- Unequal flute spacing.
- Centre cutting.
- Single tool for both roughing and finishing operations requiring fewer setups.
- Standard items listed. Additional styles and coatings made-to-order.

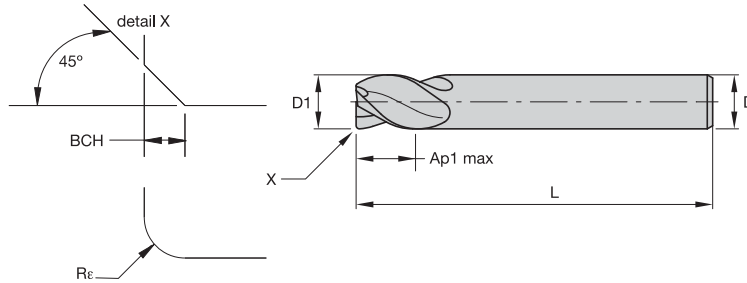
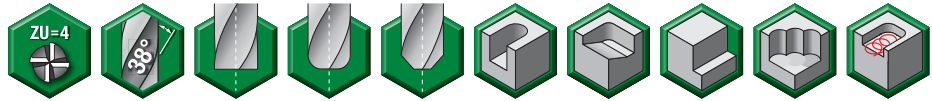

End Mill Tolerances

D1	tolerance e8	D	tolerance h6 + / -
≤ 3	-0,014/-0,028	≤ 3	0/-0,006
> 3-6	-0,020/-0,038	> 3-6	0/-0,008
> 6-10	-0,025/-0,047	> 6-10	0/-0,009
> 10-18	-0,032/-0,059	> 10-18	0/-0,011
> 18-30	-0,040/-0,073	> 18-30	0/-0,013



■ Series 4777 • VariMill • Victory Grades

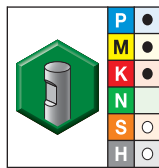
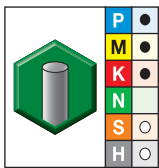

- first choice
- alternate choice

order #	catalogue #	order #	catalogue #	D1	D	length of cut Ap1 max	length L	Re	BCH
5576753	477704001T	-	-	4,0	6	12,00	55	0,20	-
5576751	477704002T	5576752	477704002W	4,0	6	12,00	55	-	0,40
5576754	477704022T	-	-	4,0	6	12,00	55	-	-
5576755	477705002T	5576756	477705002W	5,0	6	13,00	57	-	0,40
5576757	477705012T	-	-	5,0	6	13,00	57	0,20	-
5576758	477705022T	-	-	5,0	6	13,00	57	-	-
5576759	477706002T	5576760	477706002W	6,0	6	13,00	57	-	0,40
5576761	477706012T	-	-	6,0	6	13,00	57	0,20	-
5576762	477706022T	-	-	6,0	6	13,00	57	-	-
5576763	477707003T	5576764	477707003W	7,0	8	16,00	63	-	0,40
5576765	477707013T	-	-	7,0	8	16,00	63	0,20	-
5576766	477707023T	-	-	7,0	8	16,00	63	-	-
5576767	477708003T	5576768	477708003W	8,0	8	16,00	63	-	0,40
5576769	477708013T	-	-	8,0	8	16,00	63	0,20	-
5576770	477708023T	-	-	8,0	8	16,00	63	-	-
5576771	477709004T	5576772	477709004W	9,0	10	19,00	72	-	0,50
5576773	477709014T	-	-	9,0	10	19,00	72	0,20	-
5576774	477709024T	-	-	9,0	10	19,00	72	-	-
5576775	477710004T	5576776	477710004W	10,0	10	22,00	72	-	0,50
5576777	477710024T	-	-	10,0	10	22,00	72	0,30	-

(continued)

(Series 4777 • VariMill • Victory Grades — continued)

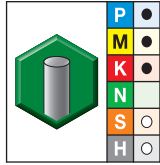
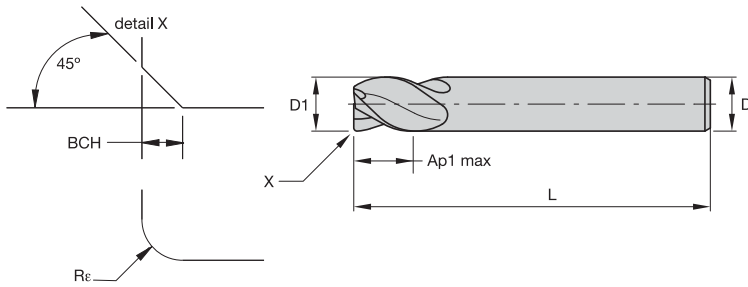

grade WP15PE
AITiN

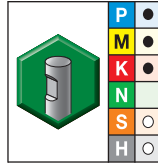

grade WP15PE
AITiN

● first choice
○ alternate choice

order #	catalogue #	order #	catalogue #	D1	D	length of cut Ap1 max	length L	Re	BCH
5576778	4777100Z4T	-	-	10,0	10	22,00	72	-	-
5576779	4777110Z5T	-	-	11,0	12	26,00	83	-	-
5576790	477712005T	5576791	477712005W	12,0	12	26,00	83	-	0,50
5576792	477712025T	-	-	12,0	12	26,00	83	0,30	-
5576793	4777120Z5T	-	-	12,0	12	26,00	83	-	-
5576794	477714015T	5576795	477714014W	14,0	14	26,00	83	-	0,50
5576796	477716006T	5576797	477716006W	16,0	16	32,00	92	-	0,50
5576798	477716026T	-	-	16,0	16	32,00	92	0,30	-
5576799	4777160Z6T	-	-	16,0	16	32,00	92	-	-
5576810	477718018T	5576811	477718018W	18,0	18	32,00	92	-	0,50
5576812	477720007T	5576813	477720007W	20,0	20	38,00	104	-	0,50
5576814	47772002T	-	-	20,0	20	38,00	104	0,30	-
5576816	477725008T	5576817	477725008W	25,0	25	45,00	121	-	0,50

- Unequal flute spacing.
- Centre cutting.
- Optimised geometry for titanium machining.
- Single tool for both roughing and finishing operations requiring fewer setups.
- Standard items listed. Additional styles and coatings made-to-order.

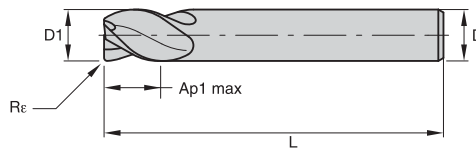
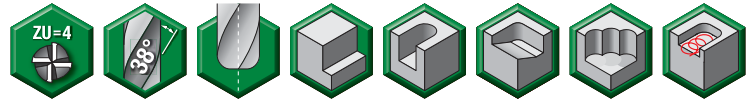

End Mill Tolerances

D1	tolerance e8	D	tolerance h6 + / -
≤ 3	-0,014/-0,028	≤ 3	0/-0,006
> 3-6	-0,020/-0,038	> 3-6	0/-0,008
> 6-10	-0,025/-0,047	> 6-10	0/-0,009
> 10-18	-0,032/-0,059	> 10-18	0/-0,011
> 18-30	-0,040/-0,073	> 18-30	0/-0,013

■ Series 4778 • VariMill

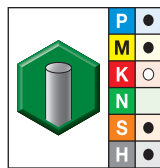

grade AITiN-MT
AITiN

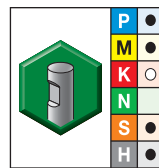

grade AITiN-MW
AITiN

- first choice
- alternate choice

order #	catalogue #	order #	catalogue #	D1	D	length of cut Ap1 max	length L	Rε
2545563	477804002MT	3592826	477804002MW	4,0	6	12,00	55	0,20
2545564	477805002MT	3592827	477805002MW	5,0	6	13,00	57	0,20
2545565	477806002MT	3592828	477806002MW	6,0	6	13,00	57	0,20
2545570	477807003MT	3592829	477807003MW	7,0	8	16,00	63	0,20
2545603	477808003MT	3592830	477808003MW	8,0	8	16,00	63	0,20
2545605	477809004MT	3592831	477809004MW	9,0	10	19,00	72	0,20
2601245	477810004MT	3592832	477810004MW	10,0	10	22,00	72	0,30
2601246	477812005MT	3592833	477812005MW	12,0	12	26,00	83	0,30
2601248	477814014MT	3592834	477814014MW	14,0	14	26,00	83	0,30
2601249	477816006MT	3592835	477816006MW	16,0	16	32,00	92	0,30
2601250	477818018MT	3592836	477818018MW	18,0	18	32,00	92	0,30
2601251	477820007MT	3592837	477820007MW	20,0	20	38,00	104	0,30
2601252	477825008MT	3592838	477825008MW	25,0	25	45,00	121	0,30

- Unequal flute spacing.
- Centre cutting.
- Standard items listed. Additional styles and coatings made-to-order.

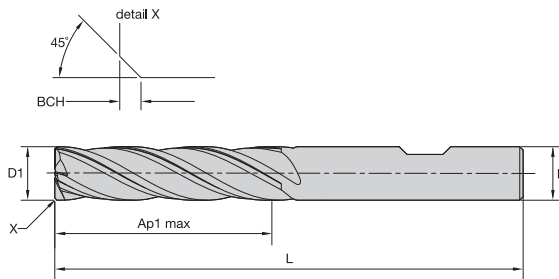
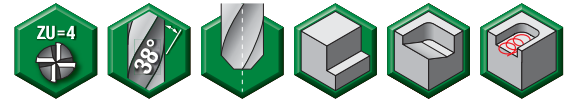

End Mill Tolerances

D1	tolerance e8	D	tolerance h6 + / -
≤ 3	-0,014/-0,028	≤ 3	0/-0,006
> 3-6	-0,020/-0,038	> 3-6	0/-0,008
> 6-10	-0,025/-0,047	> 6-10	0/-0,009
> 10-18	-0,032/-0,059	> 10-18	0/-0,011
> 18-30	-0,040/-0,073	> 18-30	0/-0,013

■ Series 4717 • VariMill • Extended Length of Cut

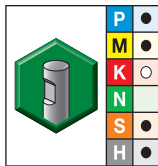

grade TiAlN-LW
TiAlN

- first choice
- alternate choice

order #	catalogue #	D1	D	length of cut Ap1 max	length L	BCH
3641112	471706002LW	6,0	6	32,00	76	0,40
3641113	471708003LW	8,0	8	32,00	87	0,40
3641114	471710004LW	10,0	10	38,00	89	0,50
3641115	471712005LW	12,0	12	51,00	100	0,50
3641116	471716006LW	16,0	16	57,00	125	0,50
3641117	471720007LW	20,0	20	57,00	125	0,50

High-Performance Solid Carbide End Mills

- Unequal flute spacing.
- Centre cutting.
- Standard items listed. Additional styles and coatings made-to-order.

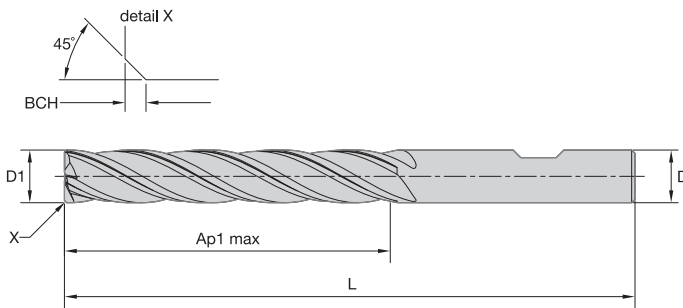
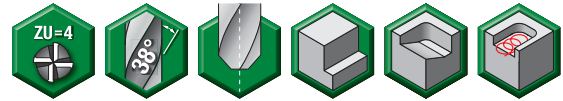

End Mill Tolerances

D1	tolerance e8	D	tolerance h6 + / -
≤ 3	-0,014/-0,028	≤ 3	0/-0,006
> 3-6	-0,020/-0,038	> 3-6	0/-0,008
> 6-10	-0,025/-0,047	> 6-10	0/-0,009
> 10-18	-0,032/-0,059	> 10-18	0/-0,011
> 18-30	-0,040/-0,073	> 18-30	0/-0,013

■ Series 4727 • VariMill • Extended Length of Cut

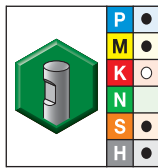

grade TiAlN-LW
TiAlN

- first choice
- alternate choice

order #	catalogue #	D1	D	length of cut Ap1 max	length L	BCH
3641118	472712005LW	12,0	12	76,00	125	0,50
3641119	472716006LW	16,0	16	76,00	150	0,50
3641120	472720007LW	20,0	20	102,00	175	0,50

High-Performance Solid Carbide End Mills

- Unequal flute spacing.
- Centre cutting.
- Single tool for both roughing and finishing operations requiring fewer setups.
- Standard items listed. Additional styles and coatings made-to-order.

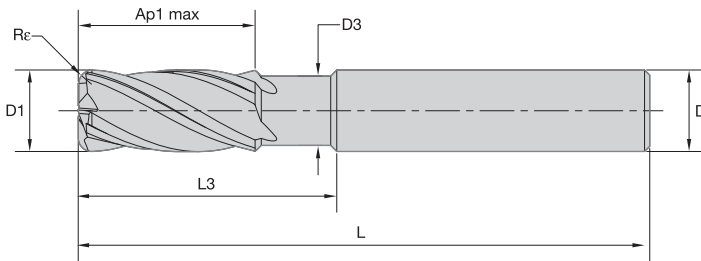
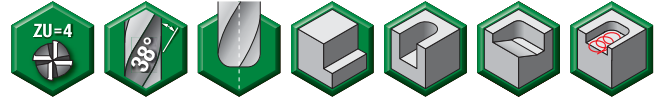

End Mill Tolerances

D1	tolerance e8	D	tolerance h6 + / -
≤ 3	-0,014/-0,028	≤ 3	0/-0,006
> 3-6	-0,020/-0,038	> 3-6	0/-0,008
> 6-10	-0,025/-0,047	> 6-10	0/-0,009
> 10-18	-0,032/-0,059	> 10-18	0/-0,011
> 18-30	-0,040/-0,073	> 18-30	0/-0,013

■ Series 47N7 • VariMill • With Neck

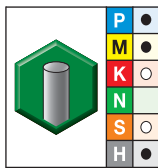

grade AlTiN-MT
AlTiN

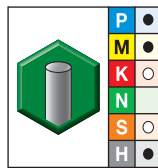

grade TiAlN-LT
TiAlN

- first choice
- alternate choice

order #	catalogue #	order #	catalogue #	D1	D	D3	length of cut Ap1 max	L3	length L	Re
—	—	3462450	47N704002LT	4,0	6	3,60	12,00	16,00	55	0,40
3462452	47N704012MT	3462451	47N704012LT	4,0	6	3,60	12,00	16,00	55	0,50
—	—	3462453	47N704022LT	4,0	6	3,60	12,00	16,00	55	1,00
—	—	3462454	47N705002LT	5,0	6	4,60	13,00	18,00	57	0,50
3462456	47N705012MT	3462455	47N705012LT	5,0	6	4,60	13,00	18,00	57	1,00
3462458	47N706002MT	3462457	47N706002LT	6,0	6	5,50	13,00	21,00	57	0,50
3462460	47N706012MT	3462459	47N706012LT	6,0	6	5,50	13,00	21,00	57	1,00
—	—	3462461	47N706022LT	6,0	6	5,50	13,00	21,00	57	1,50
3462463	47N708003MT	3462462	47N708003LT	8,0	8	7,50	16,00	27,00	63	0,50
3462465	47N708013MT	3462464	47N708013LT	8,0	8	7,50	16,00	27,00	63	1,00
—	—	3462466	47N708023LT	8,0	8	7,50	16,00	27,00	63	1,50
—	—	3462467	47N708033LT	8,0	8	7,50	16,00	27,00	63	2,00
3462469	47N710004MT	3462468	47N710004LT	10,0	10	9,50	22,00	32,00	72	0,50
3462471	47N710014MT	3462470	47N710014LT	10,0	10	9,50	22,00	32,00	72	1,00
—	—	3462472	47N710024LT	10,0	10	9,50	22,00	32,00	72	1,50
3462474	47N710034MT	3462473	47N710034LT	10,0	10	9,50	22,00	32,00	72	2,00
3462476	47N712005MT	3462475	47N712005LT	12,0	12	11,50	26,00	38,00	83	0,50
3462478	47N712015MT	3462477	47N712015LT	12,0	12	11,50	26,00	38,00	83	1,00
—	—	3462479	47N712025LT	12,0	12	11,50	26,00	38,00	83	1,50
3462481	47N712035MT	3462480	47N712035LT	12,0	12	11,50	26,00	38,00	83	2,00

(continued)

(Series 47N7 • VariMill • With Neck — continued)

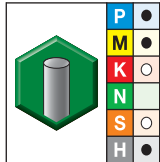
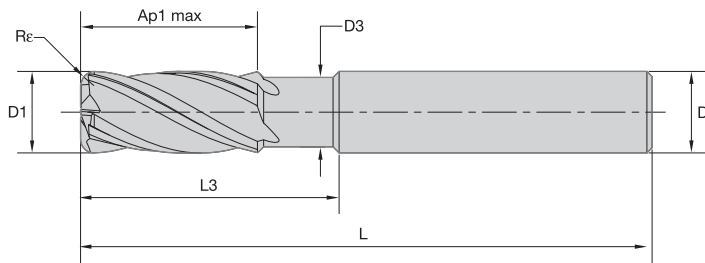

grade AlTiN-MT
AlTiN

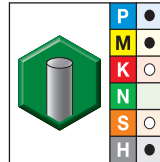

grade TiAlN-LT
TiAlN

● first choice
○ alternate choice

grade AlTiN-MT AlTiN		grade TiAlN-LT TiAlN		D1	D	D3	length of cut Ap1 max	L3	length L	Re
order #	catalogue #	order #	catalogue #							
3462483	47N712045MT	3462482	47N712045LT	12,0	12	11,50	26,00	38,00	83	4,00
3462485	47N716006MT	3462484	47N716006LT	16,0	16	15,00	32,00	44,00	92	1,00
3462487	47N716016MT	3462486	47N716016LT	16,0	16	15,00	32,00	44,00	92	2,00
3462489	47N716026MT	3462488	47N716026LT	16,0	16	15,00	32,00	44,00	92	4,00
3462491	47N720007MT	3462490	47N720007LT	20,0	20	19,00	38,00	55,00	104	1,00
3462493	47N720017MT	3462492	47N720017LT	20,0	20	19,00	38,00	55,00	104	2,00
3462495	47N720027MT	3462494	47N720027LT	20,0	20	19,00	38,00	55,00	104	4,00

High-Performance Solid Carbide End Mills

- Unequal flute spacing.
- Centre cutting.
- Single tool for both roughing and finishing operations requiring fewer setups.
- Standard items listed. Additional styles and coatings made-to-order.

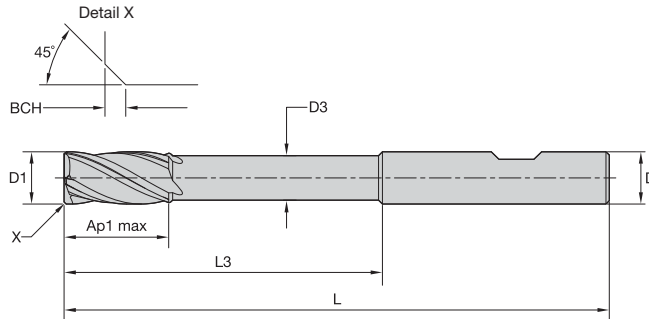
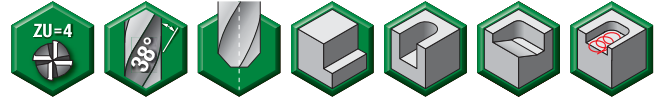

End Mill Tolerances

D1	tolerance e8	D	tolerance h6 + / -
≤ 3	-0,014/-0,028	≤ 3	0/-0,006
> 3-6	-0,020/-0,038	> 3-6	0/-0,008
> 6-10	-0,025/-0,047	> 6-10	0/-0,009
> 10-18	-0,032/-0,059	> 10-18	0/-0,011
> 18-30	-0,040/-0,073	> 18-30	0/-0,013

■ Series 47N6 • VariMill • Extended Reach with Neck

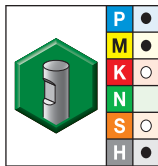

grade TiAlN-LW
TiAlN

- first choice
- alternate choice

order #	catalogue #	D1	D	D3	length of cut Ap1 max	L3	length L	BCH
4067705	47N606002LW	6,0	6	5,50	12,00	42,00	100	0,40
4067706	47N608003LW	8,0	8	7,30	16,00	62,00	100	0,40
4067707	47N610004LW	10,0	10	9,10	20,00	60,00	100	0,50
4067708	47N612005LW	12,0	12	11,00	24,00	73,00	125	0,50
4067709	47N616006LW	16,0	16	14,56	32,00	100,00	150	0,50
4067710	47N620007LW	20,0	20	18,20	40,00	98,00	175	0,50

- Unequal flute spacing.
- Centre cutting.
- Single tool for both roughing and finishing operations requiring fewer setups.
- Standard items listed. Additional styles and coatings made-to-order.

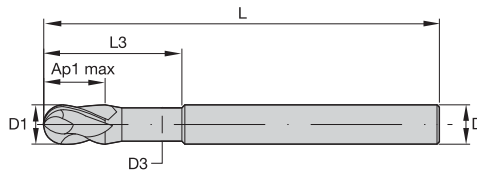
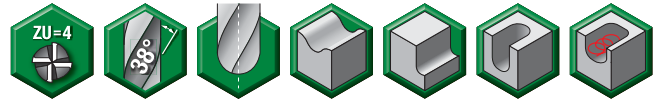

End Mill Tolerances

D1	tolerance e8	D	tolerance h6 + / -
≤ 3	-0,014/-0,028	≤ 3	0/-0,006
> 3-6	-0,020/-0,038	> 3-6	0/-0,008
> 6-10	-0,025/-0,047	> 6-10	0/-0,009
> 10-18	-0,032/-0,059	> 10-18	0/-0,011
> 18-30	-0,040/-0,073	> 18-30	0/-0,013



■ Series 47N0 • VariMill • Ball Nose • Victory Grades

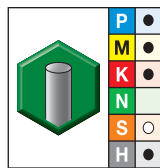

grade WP15PE
AlTiN

- first choice
- alternate choice

order #	catalogue #	D1	D	D3	length of cut Ap1 max	L3	length L
5576818	47N005002T	5,0	6	4,70	9,00	15,00	57
5576819	47N006002T	6,0	6	5,64	10,00	15,00	57
5576820	47N008003T	8,0	8	7,52	12,00	20,00	63
5576821	47N010004T	10,0	10	9,40	14,00	25,00	72
5576822	47N012005T	12,0	12	11,28	16,00	30,00	83
5576823	47N016006T	16,0	16	15,04	22,00	38,00	92
5576824	47N020007T	20,0	20	18,80	26,00	50,00	104

High-Performance Solid Carbide End Mills

■ Series 4777 • VariMill • Victory Grades



Material Group																				
	Side Milling (A) and Slotting (B)			WP15PE			Recommended feed per tooth (fz = mm/th) for side milling (A). For slotting (B), reduce fz by 20%.													
	A		B	Cutting Speed – vc m/min			D1 – Diameter													
	ap	ae	ap	min		max	mm	4,0	5,0	6,0	8,0	10,0	12,0	14,0	16,0	18,0	20,0	25,0		
P	0	1,5 x D	0,5 x D	1 x D	150	–	200	fz	0,028	0,036	0,044	0,060	0,072	0,083	0,092	0,101	0,108	0,114	0,124	
	1	1,5 x D	0,5 x D	1 x D	150	–	200	fz	0,028	0,036	0,044	0,060	0,072	0,083	0,092	0,101	0,108	0,114	0,124	
	2	1,5 x D	0,5 x D	1 x D	140	–	190	fz	0,028	0,036	0,044	0,060	0,072	0,083	0,092	0,101	0,108	0,114	0,124	
	3	1,5 x D	0,5 x D	1 x D	120	–	160	fz	0,023	0,030	0,036	0,050	0,061	0,070	0,079	0,087	0,095	0,101	0,114	
	4	1,5 x D	0,5 x D	0,75 x D	90	–	150	fz	0,021	0,027	0,033	0,045	0,054	0,062	0,070	0,077	0,083	0,088	0,098	
	5	1,5 x D	0,5 x D	1 x D	60	–	100	fz	0,019	0,024	0,029	0,040	0,048	0,056	0,063	0,070	0,076	0,081	0,091	
M	6	1,5 x D	0,5 x D	0,75 x D	50	–	75	fz	0,016	0,020	0,025	0,034	0,040	0,047	0,052	0,057	0,061	0,065	0,071	
	1	1,5 x D	0,5 x D	1 x D	90	–	115	fz	0,023	0,030	0,036	0,050	0,061	0,070	0,079	0,087	0,095	0,101	0,114	
	2	1,5 x D	0,5 x D	1 x D	60	–	80	fz	0,019	0,024	0,029	0,040	0,048	0,056	0,063	0,070	0,076	0,081	0,091	
K	3	1,5 x D	0,5 x D	1 x D	60	–	70	fz	0,016	0,020	0,025	0,034	0,040	0,047	0,052	0,057	0,061	0,065	0,071	
	1	1,5 x D	0,5 x D	1 x D	120	–	150	fz	0,028	0,036	0,044	0,060	0,072	0,083	0,092	0,101	0,108	0,114	0,124	
	2	1,5 x D	0,5 x D	1 x D	110	–	140	fz	0,023	0,030	0,036	0,050	0,061	0,070	0,079	0,087	0,095	0,101	0,114	
S	3	1,5 x D	0,5 x D	1 x D	110	–	130	fz	0,019	0,024	0,029	0,040	0,048	0,056	0,063	0,070	0,076	0,081	0,091	
	1	1,5 x D	0,3 x D	0,3 x D	50	–	90	fz	0,023	0,030	0,036	0,050	0,061	0,070	0,079	0,087	0,095	0,101	0,114	
	2	1,5 x D	0,3 x D	0,3 x D	25	–	40	fz	0,013	0,016	0,019	0,026	0,032	0,037	0,042	0,046	0,050	0,054	0,061	
	3	1,5 x D	0,5 x D	1 x D	60	–	80	fz	0,019	0,024	0,029	0,040	0,048	0,056	0,063	0,070	0,076	0,081	0,091	
H	4	1,5 x D	0,5 x D	1 x D	50	–	60	fz	0,016	0,021	0,026	0,037	0,045	0,052	0,058	0,064	0,069	0,074	0,084	
H	1	1,5 x D	0,5 x D	0,75 x D	80	–	140	fz	0,021	0,027	0,033	0,045	0,054	0,062	0,070	0,077	0,083	0,088	0,098	

NOTE: Lower value of cutting speed is used for high stock removal applications or for higher hardness (machinability) within group.
Higher value of cutting speed is used for finishing applications or for lower hardness (machinability) within group.
Above parameters are based on ideal conditions. For smaller taper machining centres, please adjust parameters accordingly on >12mm diameters.

High-Performance Solid Carbide End Mills

■ Series 4778 • VariMill

Material Group								Recommended feed per tooth (fz = mm/th) for side milling (A). For slotting (B), reduce fz by 20%.								
	Side Milling (A) and Slotting (B)			AlTiN			D1 – Diameter									
	A		B	Cutting Speed – vc m/min			mm	4,0	6,0	8,0	10,0	12,0	16,0	20,0	25,0	
	ap	ae	ap	min	–	max	fz									
P	1	1,5 x D	0,5 x D	1 x D	150	–	200	fz	0,028	0,044	0,060	0,072	0,083	0,101	0,114	0,124
	2	1,5 x D	0,5 x D	1 x D	140	–	190	fz	0,028	0,044	0,060	0,072	0,083	0,101	0,114	0,124
	3	1,5 x D	0,5 x D	1 x D	120	–	160	fz	0,023	0,036	0,050	0,061	0,070	0,087	0,101	0,114
	4	1,5 x D	0,5 x D	0,75 x D	90	–	150	fz	0,021	0,033	0,045	0,054	0,062	0,077	0,088	0,098
	5	1,5 x D	0,5 x D	1 x D	60	–	100	fz	0,019	0,029	0,040	0,048	0,056	0,070	0,081	0,091
	6	1,5 x D	0,5 x D	0,75 x D	50	–	75	fz	0,016	0,025	0,034	0,040	0,047	0,057	0,065	0,071
M	1	1,5 x D	0,5 x D	1 x D	90	–	115	fz	0,023	0,036	0,050	0,061	0,070	0,087	0,101	0,114
	2	1,5 x D	0,5 x D	1 x D	60	–	80	fz	0,019	0,029	0,040	0,048	0,056	0,070	0,081	0,091
	3	1,5 x D	0,5 x D	1 x D	60	–	70	fz	0,016	0,025	0,034	0,040	0,047	0,057	0,065	0,071
K	1	1,5 x D	0,5 x D	1 x D	120	–	150	fz	0,028	0,044	0,060	0,072	0,083	0,101	0,114	0,124
	2	1,5 x D	0,5 x D	1 x D	110	–	130	fz	0,023	0,036	0,050	0,061	0,070	0,087	0,101	0,114
	3	1,5 x D	0,5 x D	1 x D	100	–	130	fz	0,019	0,029	0,040	0,048	0,056	0,070	0,081	0,091
S	1	1,5 x D	0,3 x D	0,3 x D	50	–	90	fz	0,023	0,036	0,050	0,061	0,070	0,087	0,101	0,114
	2	1,5 x D	0,3 x D	0,3 x D	25	–	40	fz	0,013	0,019	0,026	0,032	0,037	0,046	0,054	0,061
	3	1,5 x D	0,5 x D	1 x D	60	–	80	fz	0,019	0,029	0,040	0,048	0,056	0,070	0,081	0,091
	4	1,5 x D	0,5 x D	1 x D	50	–	60	fz	0,016	0,026	0,037	0,045	0,052	0,064	0,074	0,084
H	1	1,5 x D	0,5 x D	0,75 x D	80	–	140	fz	0,021	0,033	0,045	0,054	0,062	0,077	0,088	0,098

NOTE: Lower value of cutting speed is used for high stock removal applications or for higher hardness (machinability) within group.
 Higher value of cutting speed is used for finishing applications or for lower hardness (machinability) within group.
 Above parameters are based on ideal conditions. For smaller taper machining centres, please adjust parameters accordingly on >12mm diameters.

High-Performance Solid Carbide End Mills

■ Series 4717 • VariMill

Material Group		Side Milling (A)										Recommended feed per tooth (fz = mm/th) for side milling (A).						
		Finishing					Roughing											
		A		TiAlN			A		TiAlN			D1 – Diameter						
				Cutting Speed – vc m/min					Cutting Speed – vc m/min									
		ap	ae	min	max	ap	ae	min	max	mm	6,0	8,0	10,0	12,0	16,0	20,0		
P	1	Ap1 max	0,05 x D*	300	–	400	Ap1 max	0,2 x D	150	–	200	fz	0,044	0,060	0,072	0,083	0,092	0,114
	2	Ap1 max	0,05 x D*	280	–	380	Ap1 max	0,2 x D	140	–	190	fz	0,044	0,060	0,072	0,083	0,092	0,114
	3	Ap1 max	0,05 x D*	240	–	320	Ap1 max	0,2 x D	120	–	160	fz	0,036	0,050	0,061	0,070	0,079	0,101
	4	Ap1 max	0,05 x D*	180	–	300	Ap1 max	0,2 x D	90	–	150	fz	0,033	0,045	0,054	0,062	0,070	0,088
	5	Ap1 max	0,05 x D*	120	–	200	Ap1 max	0,2 x D	60	–	100	fz	0,029	0,040	0,048	0,056	0,063	0,081
	6	Ap1 max	0,05 x D*	100	–	150	Ap1 max	0,2 x D	50	–	75	fz	0,025	0,034	0,040	0,047	0,052	0,065
M	1	Ap1 max	0,05 x D*	180	–	230	Ap1 max	0,2 x D	90	–	115	fz	0,036	0,050	0,061	0,070	0,079	0,101
	2	Ap1 max	0,05 x D*	120	–	160	Ap1 max	0,2 x D	60	–	80	fz	0,029	0,040	0,048	0,056	0,063	0,081
	3	Ap1 max	0,05 x D*	120	–	140	Ap1 max	0,2 x D	60	–	70	fz	0,025	0,034	0,040	0,047	0,052	0,065
K	1	Ap1 max	0,05 x D*	240	–	300	Ap1 max	0,2 x D	120	–	150	fz	0,044	0,060	0,072	0,083	0,092	0,114
	2	Ap1 max	0,05 x D*	220	–	260	Ap1 max	0,2 x D	110	–	130	fz	0,036	0,050	0,061	0,070	0,079	0,101
	3	Ap1 max	0,05 x D*	200	–	260	Ap1 max	0,2 x D	100	–	130	fz	0,029	0,040	0,048	0,056	0,063	0,081
S	1	Ap1 max	0,05 x D*	100	–	180	Ap1 max	0,2 x D	50	–	90	fz	0,036	0,050	0,061	0,070	0,079	0,101
	2	Ap1 max	0,05 x D*	50	–	80	Ap1 max	0,2 x D	25	–	40	fz	0,036	0,050	0,061	0,070	0,079	0,101
	3	Ap1 max	0,05 x D*	120	–	160	Ap1 max	0,2 x D	60	–	80	fz	0,019	0,026	0,032	0,037	0,042	0,054
	4	Ap1 max	0,05 x D*	100	–	120	Ap1 max	0,2 x D	50	–	60	fz	0,026	0,037	0,045	0,052	0,058	0,074
H	1	Ap1 max	0,05 x D*	160	–	280	Ap1 max	0,2 x D	80	–	140	fz	0,033	0,045	0,054	0,062	0,070	0,088

*For cutting data above, use ae ≤ 0,8mm.

NOTE: Lower value of cutting speed is used for high stock removal applications or for higher hardness (machinability) within group.



Higher value of cutting speed is used for finishing applications or for lower hardness (machinability) within group.

Above parameters are based on ideal conditions. For smaller taper machining centres, please adjust parameters accordingly on >12mm diameters.

For finishing, increase feed per tooth by 20%.

High-Performance Solid Carbide End Mills

■ Series 4727 • VariMill

Material Group		 										Recommended feed per tooth (fz = mm/th) for side milling (A).			
		Side Milling (A)													
		Finishing					Roughing					D1 – Diameter			
		A		TiAlN			A		TiAlN						
		ap	ae	Cutting Speed – vc m/min			ap	ae	Cutting Speed – vc m/min			mm	12,0	16,0	20,0
P	1	Ap1 max	0,05 x D*	300	–	400	Ap1 max	0,2 x D	150	–	200	fz	0,083	0,101	0,114
	2	Ap1 max	0,05 x D*	280	–	380	Ap1 max	0,2 x D	140	–	190	fz	0,083	0,101	0,114
	3	Ap1 max	0,05 x D*	240	–	320	Ap1 max	0,2 x D	120	–	160	fz	0,070	0,087	0,101
	4	Ap1 max	0,05 x D*	180	–	300	Ap1 max	0,2 x D	90	–	150	fz	0,062	0,077	0,088
	5	Ap1 max	0,05 x D*	120	–	200	Ap1 max	0,2 x D	60	–	100	fz	0,056	0,070	0,081
	6	Ap1 max	0,05 x D*	100	–	150	Ap1 max	0,2 x D	50	–	75	fz	0,047	0,057	0,065
M	1	Ap1 max	0,05 x D*	180	–	230	Ap1 max	0,2 x D	90	–	115	fz	0,070	0,087	0,101
	2	Ap1 max	0,05 x D*	120	–	160	Ap1 max	0,2 x D	60	–	80	fz	0,056	0,070	0,081
	3	Ap1 max	0,05 x D*	120	–	140	Ap1 max	0,2 x D	60	–	70	fz	0,047	0,057	0,065
K	1	Ap1 max	0,05 x D*	240	–	300	Ap1 max	0,2 x D	120	–	150	fz	0,083	0,101	0,114
	2	Ap1 max	0,05 x D*	220	–	260	Ap1 max	0,2 x D	110	–	130	fz	0,070	0,087	0,101
	3	Ap1 max	0,05 x D*	200	–	260	Ap1 max	0,2 x D	100	–	130	fz	0,056	0,070	0,081
S	1	Ap1 max	0,05 x D*	100	–	180	Ap1 max	0,2 x D	50	–	90	fz	0,070	0,087	0,101
	2	Ap1 max	0,05 x D*	50	–	80	Ap1 max	0,2 x D	25	–	40	fz	0,070	0,087	0,101
	3	Ap1 max	0,05 x D*	120	–	160	Ap1 max	0,2 x D	60	–	80	fz	0,037	0,046	0,054
	4	Ap1 max	0,05 x D*	100	–	120	Ap1 max	0,2 x D	50	–	60	fz	0,052	0,064	0,074
H	1	Ap1 max	0,05 x D*	160	–	280	Ap1 max	0,2 x D	80	–	140	fz	0,062	0,077	0,088

*For cutting data above, use ae ≤ 0,8mm.



NOTE: Lower value of cutting speed is used for high stock removal applications or for higher hardness (machinability) within group.

Higher value of cutting speed is used for finishing applications or for lower hardness (machinability) within group.

Above parameters are based on ideal conditions. For smaller taper machining centres, please adjust parameters accordingly on >12mm diameters.

For finishing, increase feed per tooth by 20%.

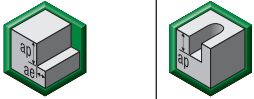
■ Series 47N7 AlTiN • VariMill • With Neck

Material Group																
	Side Milling (A) and Slotting (B)			AlTiN			Recommended feed per tooth (fz = mm/th) for side milling (A). For slotting (B), reduce fz by 20%.									
	A		B	Cutting Speed – vc m/min			mm	D1 – Diameter								
	ap	ae	ap	min	–	max		4,0	6,0	8,0	10,0	12,0	16,0	20,0		
P	1	1,5 x D	0,5 x D	1 x D	150	–	200	fz	0,028	0,044	0,060	0,072	0,083	0,101	0,114	
	2	1,5 x D	0,5 x D	1 x D	140	–	190	fz	0,028	0,044	0,060	0,072	0,083	0,101	0,114	
	3	1,5 x D	0,5 x D	1 x D	120	–	160	fz	0,023	0,036	0,050	0,061	0,070	0,087	0,101	
	4	1,5 x D	0,5 x D	0,75 x D	90	–	150	fz	0,021	0,033	0,045	0,054	0,062	0,077	0,088	
	5	1,5 x D	0,5 x D	1 x D	60	–	100	fz	0,019	0,029	0,040	0,048	0,056	0,070	0,081	
	6	1,5 x D	0,5 x D	0,75 x D	50	–	75	fz	0,016	0,025	0,034	0,040	0,047	0,057	0,065	
M	1	1,5 x D	0,5 x D	1 x D	90	–	115	fz	0,023	0,036	0,050	0,061	0,070	0,087	0,101	
	2	1,5 x D	0,5 x D	1 x D	60	–	80	fz	0,019	0,029	0,040	0,048	0,056	0,070	0,081	
	3	1,5 x D	0,5 x D	1 x D	60	–	70	fz	0,016	0,025	0,034	0,040	0,047	0,057	0,065	
K	1	1,5 x D	0,5 x D	1 x D	120	–	150	fz	0,028	0,044	0,060	0,072	0,083	0,101	0,114	
	2	1,5 x D	0,5 x D	1 x D	110	–	130	fz	0,023	0,036	0,050	0,061	0,070	0,087	0,101	
	3	1,5 x D	0,5 x D	1 x D	100	–	130	fz	0,019	0,029	0,040	0,048	0,056	0,070	0,081	
S	1	1,5 x D	0,3 x D	0,3 x D	50	–	90	fz	0,023	0,036	0,050	0,061	0,070	0,087	0,101	
	2	1,5 x D	0,3 x D	0,3 x D	25	–	40	fz	0,013	0,019	0,026	0,032	0,037	0,046	0,054	
	3	1,5 x D	0,5 x D	1 x D	60	–	80	fz	0,019	0,029	0,040	0,048	0,056	0,070	0,081	
	4	1,5 x D	0,5 x D	1 x D	50	–	60	fz	0,016	0,026	0,037	0,045	0,052	0,064	0,074	
H	1	1,5 x D	0,5 x D	0,75 x D	80	–	140	fz	0,021	0,033	0,045	0,054	0,062	0,077	0,088	

NOTE: Lower value of cutting speed is used for high stock removal applications or for higher hardness (machinability) within group.
Higher value of cutting speed is used for finishing applications or for lower hardness (machinability) within group.
Above parameters are based on ideal conditions. For smaller taper machining centres, please adjust parameters accordingly on >12mm diameters.

■ Series 47N7 TiAlN • VariMill • With Neck

Material Group	Side Milling (A) and Slotting (B)			TiAlN			Recommended feed per tooth (fz = mm/th) for side milling (A). For slotting (B), reduce fz by 20%.									
	A		B	Cutting Speed – vc m/min			mm	D1 – Diameter								
	ap	ae	ap	min		max		4,0	6,0	8,0	10,0	12,0	16,0	20,0		
							fz									
P	1	1,5 x D	0,5 x D	1 x D	150	–	200	fz	0,028	0,044	0,060	0,072	0,083	0,101	0,114	
	2	1,5 x D	0,5 x D	1 x D	140	–	190	fz	0,028	0,044	0,060	0,072	0,083	0,101	0,114	
	3	1,5 x D	0,5 x D	1 x D	120	–	160	fz	0,023	0,036	0,050	0,061	0,070	0,087	0,101	
	4	1,5 x D	0,5 x D	0,75 x D	90	–	150	fz	0,021	0,033	0,045	0,054	0,062	0,077	0,088	
	5	1,5 x D	0,5 x D	1 x D	60	–	100	fz	0,019	0,029	0,040	0,048	0,056	0,070	0,081	
	6	1,5 x D	0,5 x D	0,75 x D	50	–	75	fz	0,016	0,025	0,034	0,040	0,047	0,057	0,065	
M	1	1,5 x D	0,5 x D	1 x D	90	–	115	fz	0,023	0,036	0,050	0,061	0,070	0,087	0,101	
	2	1,5 x D	0,5 x D	1 x D	60	–	80	fz	0,019	0,029	0,040	0,048	0,056	0,070	0,081	
	3	1,5 x D	0,5 x D	1 x D	60	–	70	fz	0,016	0,025	0,034	0,040	0,047	0,057	0,065	
K	1	1,5 x D	0,5 x D	1 x D	120	–	150	fz	0,028	0,044	0,060	0,072	0,083	0,101	0,114	
	2	1,5 x D	0,5 x D	1 x D	110	–	130	fz	0,023	0,036	0,050	0,061	0,070	0,087	0,101	
	3	1,5 x D	0,5 x D	1 x D	100	–	130	fz	0,019	0,029	0,040	0,048	0,056	0,070	0,081	
S	1	1,5 x D	0,3 x D	0,3 x D	50	–	90	fz	0,023	0,036	0,050	0,061	0,070	0,087	0,101	
	2	1,5 x D	0,3 x D	0,3 x D	25	–	40	fz	0,013	0,019	0,026	0,032	0,037	0,046	0,054	
	3	1,5 x D	0,5 x D	1 x D	60	–	80	fz	0,019	0,029	0,040	0,048	0,056	0,070	0,081	
	4	1,5 x D	0,5 x D	1 x D	50	–	60	fz	0,016	0,026	0,037	0,045	0,052	0,064	0,074	
H	1	1,5 x D	0,5 x D	0,75 x D	80	–	140	fz	0,021	0,033	0,045	0,054	0,062	0,077	0,088	

NOTE: Lower value of cutting speed is used for high stock removal applications or for higher hardness (machinability) within group.
 Higher value of cutting speed is used for finishing applications or for lower hardness (machinability) within group.
 Above parameters are based on ideal conditions. For smaller taper machining centres, please adjust parameters accordingly on >12mm diameters.

High-Performance Solid Carbide End Mills

■ Series 47N6 • VariMill • With Neck

Material Group								Recommended feed per tooth (fz = mm/th) for side milling (A). For slotting (B), reduce fz by 20%.						
	Side Milling (A) and Slotting (B)			TiAlN			D1 – Diameter							
	A		B	Cutting Speed – vc m/min			mm	6,0	8,0	10,0	12,0	16,0	20,0	
	ap	ae	ap	min		max								
P	0	1,5 x D	0,2 x D	0,5 x D	150	–	200	fz	0,044	0,060	0,072	0,083	0,101	0,114
	1	1,5 x D	0,2 x D	0,5 x D	150	–	200	fz	0,044	0,060	0,072	0,083	0,101	0,114
	2	1,5 x D	0,2 x D	0,5 x D	140	–	190	fz	0,044	0,060	0,072	0,083	0,101	0,114
	3	1,5 x D	0,2 x D	0,5 x D	120	–	160	fz	0,036	0,050	0,061	0,070	0,087	0,101
	4	1,5 x D	0,2 x D	0,5 x D	90	–	150	fz	0,033	0,045	0,054	0,062	0,077	0,088
	5	1,5 x D	0,2 x D	0,5 x D	60	–	100	fz	0,029	0,040	0,048	0,056	0,070	0,081
M	1	1,5 x D	0,2 x D	0,5 x D	90	–	115	fz	0,036	0,050	0,061	0,070	0,087	0,101
	2	1,5 x D	0,2 x D	0,5 x D	60	–	80	fz	0,029	0,040	0,048	0,056	0,070	0,081
	3	1,5 x D	0,2 x D	0,5 x D	60	–	70	fz	0,025	0,034	0,040	0,047	0,057	0,065
K	1	1,5 x D	0,2 x D	0,5 x D	120	–	150	fz	0,044	0,060	0,072	0,083	0,101	0,114
	2	1,5 x D	0,2 x D	0,5 x D	110	–	130	fz	0,036	0,050	0,061	0,070	0,087	0,101
	3	1,5 x D	0,2 x D	0,5 x D	110	–	130	fz	0,029	0,040	0,048	0,056	0,070	0,081
S	1	1,5 x D	0,2 x D	0,5 x D	50	–	90	fz	0,036	0,050	0,061	0,070	0,087	0,101
	2	1,5 x D	0,1 x D	0,3 x D	25	–	40	fz	0,019	0,026	0,032	0,037	0,046	0,054
	3	1,5 x D	0,2 x D	0,5 x D	60	–	80	fz	0,029	0,040	0,048	0,056	0,070	0,081
	4	1,5 x D	0,2 x D	0,5 x D	50	–	60	fz	0,026	0,037	0,045	0,052	0,064	0,074
H	1	1,5 x D	0,1 x D	0,3 x D	80	–	140	fz	0,033	0,045	0,054	0,062	0,077	0,088

NOTE: Lower value of cutting speed is used for high stock removal applications or for higher hardness (machinability) within group.
Higher value of cutting speed is used for finishing applications or for lower hardness (machinability) within group.
Above parameters are based on ideal conditions. For smaller taper machining centres, please adjust parameters accordingly on >12mm diameters.

■ Series 47N0 • With Neck • VariMill • Victory Grades



Material Group																	
	Side Milling (A) and Slotting (B)			WP15PE			Recommended feed per tooth (fz = mm/th) for side milling (A). For slotting (B), reduce fz by 20%.										
	A		B	Cutting Speed – vc m/min			D1 – Diameter										
	ap	ae	ap	min		max	mm	5,0	6,0	8,0	10,0	12,0	14,0	16,0	18,0	20,0	
P	0	1,25 x D	0,5 x D	1 x D	150	–	200	fz	0,036	0,044	0,060	0,072	0,083	0,092	0,101	0,108	0,114
	1	1,25 x D	0,5 x D	1 x D	150	–	200	fz	0,036	0,044	0,060	0,072	0,083	0,092	0,101	0,108	0,114
	2	1,25 x D	0,5 x D	1 x D	140	–	190	fz	0,036	0,044	0,060	0,072	0,083	0,092	0,101	0,108	0,114
	3	1,25 x D	0,5 x D	1 x D	120	–	160	fz	0,030	0,036	0,050	0,061	0,070	0,079	0,087	0,095	0,101
	4	1,25 x D	0,5 x D	0,75 x D	90	–	150	fz	0,027	0,033	0,045	0,054	0,062	0,070	0,077	0,083	0,088
	5	1,25 x D	0,5 x D	1 x D	60	–	100	fz	0,024	0,029	0,040	0,048	0,056	0,063	0,070	0,076	0,081
M	1	1,25 x D	0,5 x D	1 x D	90	–	115	fz	0,030	0,036	0,050	0,061	0,070	0,079	0,087	0,095	0,101
	2	1,25 x D	0,5 x D	1 x D	60	–	80	fz	0,024	0,029	0,040	0,048	0,056	0,063	0,070	0,076	0,081
	3	1,25 x D	0,5 x D	1 x D	60	–	70	fz	0,020	0,025	0,034	0,040	0,047	0,052	0,057	0,061	0,065
K	1	1,25 x D	0,5 x D	1 x D	120	–	150	fz	0,036	0,044	0,060	0,072	0,083	0,092	0,101	0,108	0,114
	2	1,25 x D	0,5 x D	1 x D	110	–	140	fz	0,030	0,036	0,050	0,061	0,070	0,079	0,087	0,095	0,101
	3	1,25 x D	0,5 x D	1 x D	110	–	130	fz	0,024	0,029	0,040	0,048	0,056	0,063	0,070	0,076	0,081
S	1	1 x D	0,3 x D	0,3 x D	50	–	90	fz	0,030	0,036	0,050	0,061	0,070	0,079	0,087	0,095	0,101
	2	1 x D	0,3 x D	0,3 x D	25	–	40	fz	0,016	0,019	0,026	0,032	0,037	0,042	0,046	0,050	0,054
	3	1,25 x D	0,5 x D	1 x D	60	–	80	fz	0,024	0,029	0,040	0,048	0,056	0,063	0,070	0,076	0,081
	4	1,25 x D	0,5 x D	1 x D	50	–	60	fz	0,021	0,026	0,037	0,045	0,052	0,058	0,064	0,069	0,074
H	1	1,25 x D	0,5 x D	0,75 x D	80	–	140	fz	0,027	0,033	0,045	0,054	0,062	0,070	0,077	0,083	0,088

NOTE: Lower value of cutting speed is used for high stock removal applications or for higher hardness (machinability) within group.
 Higher value of cutting speed is used for finishing applications or for lower hardness (machinability) within group.
 Above parameters are based on ideal conditions. For smaller taper machining centres, please adjust parameters accordingly on >12mm diameters.

High-Performance Solid Carbide End Mills

HydroForce™ HT Chuck



EXTREME **CHALLENGES.**
EXTREME **RESULTS.**

HydroForce™ HT Chuck High Torque for High Metal
Removal Rates (MRR) and Superior Surface Finish

- HydroForce gives you an unmatched combination of accuracy and clamping forces.
- Compact and stable design.
- Advanced hydraulic clamping with lowest runout and superior vibration dampening.
- Balanced quality to lower vibration, especially at high speeds.
- Focused and flexible product offering.

To learn more about our innovations, contact your local
Authorised Distributor or visit widia.com.

WIDIA 

High-Performance Solid Carbide End Mills •

VariMill II™

VariMill II



VariMill II end mills are the proven leader in the field of high-performance, chatter-free machining. They are designed to provide maximum metal removal rates and to achieve supreme surface conditions. Utilising an innovative and proprietary design with unequal flute spacing, VariMill II carbide end mills provide users with the most versatile technology available, capable of outperforming other high-performance tools.

- 1 x D slotting in titanium and stainless steels with five unequally spaced flutes.
- Roughing and finishing with one tool.
- Various lengths-of-cut; necked and corner radius versions available.

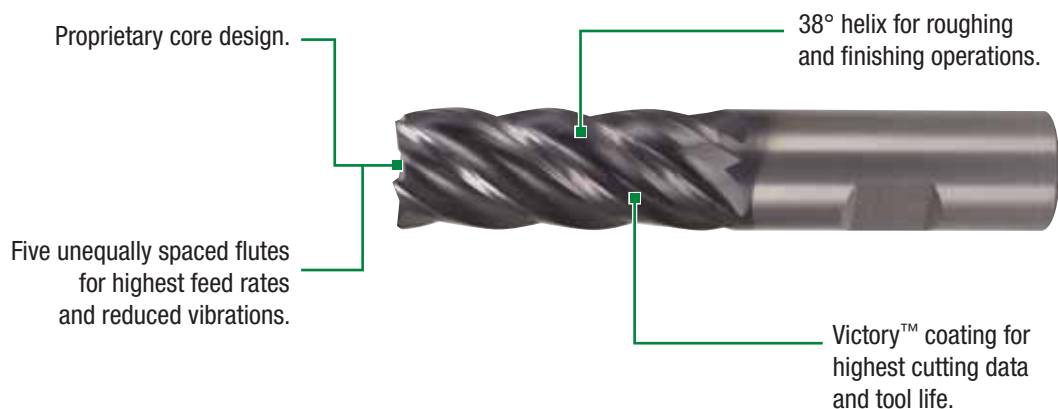

WIDIA
VICTORY

VariMill II™ Series

- Five unequally spaced flutes boosting your output with higher feed rates.
- Centre cutting.
- Roughing and finishing with one tool.
- Less passes due to 1 x D slotting capability on almost all materials, including titanium.

577C Series

- Highest metal removal rates and tool life in:
 - Stainless steels, steels, and alloyed steels
 - Cast iron.
 - High-temperature alloys and titanium.
- Corner radii and sharp edges.



57NC Series

- Titanium and stainless steel geometry design.
- Radii corner and neck design for depths requiring additional passes.



- Unequal flute spacing.
- Centre cutting.
- Single tool for both roughing and finishing operations requiring fewer setups.
- Slotting up to 1 x D.
- Standard items listed. Additional styles and coatings made-to-order.

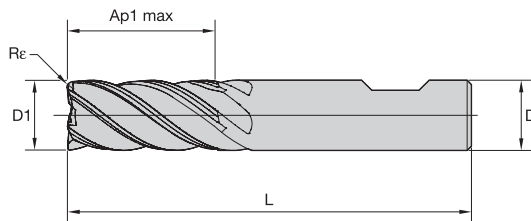
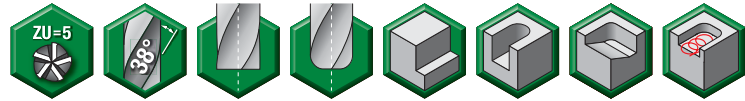

End Mill Tolerances

D1	tolerance e8	D	tolerance h6 + / -
≤ 3	-0,014/-0,028	≤ 3	0/-0,006
> 3-6	-0,020/-0,038	> 3-6	0/-0,008
> 6-10	-0,025/-0,047	> 6-10	0/-0,009
> 10-18	-0,032/-0,059	> 10-18	0/-0,011
> 18-30	-0,040/-0,073	> 18-30	0/-0,013



Series 577C • VariMill II • With Centre Cut • Victory Grades

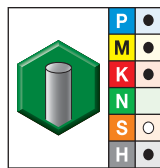

grade WP15PE
AITiN

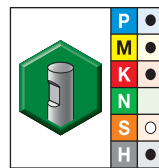

grade WP15PE
AITiN

- first choice
- alternate choice

order #	catalogue #	order #	catalogue #	D1	D	length of cut Ap1 max	length L	Re
5578866	577C04002T	5578867	577C04002W	4,0	6	11,00	55	0,25
5578868	577C04012T	-	-	4,0	6	11,00	55	-
5578990	577C05002T	5578991	577C05002W	5,0	6	13,00	57	0,25
5578992	577C06002T	5578993	577C06002W	6,0	6	13,00	57	0,40
5578994	577C06012T	-	-	6,0	6	13,00	57	-
5578995	577C07003T	5578996	577C07003W	7,0	8	16,00	63	0,40
5578997	577C08003T	5578998	577C08003W	8,0	8	19,00	63	0,50
5578999	577C08013T	-	-	8,0	8	19,00	63	-
5579021	577C09004T	5579022	577C09004W	9,0	10	19,00	72	0,50
5579023	577C10004T	5579024	577C10004W	10,0	10	22,00	72	0,50
5579025	577C10014T	-	-	10,0	10	22,00	72	-
5579026	577C12005T	5579027	577C12005W	12,0	12	26,00	83	0,75
5579028	577C12015T	-	-	12,0	12	26,00	83	-
5579029	577C14004T	5579040	577C14004W	14,0	14	26,00	83	0,75
5579041	577C14014T	-	-	14,0	14	26,00	83	-
5579042	577C16006T	5579043	577C16006W	16,0	16	32,00	92	0,75
5579044	577C16016T	-	-	16,0	16	32,00	92	-
5579045	577C18008T	5579046	577C18008W	18,0	18	32,00	92	0,75
5579047	577C20007T	5579048	577C20007W	20,0	20	38,00	104	0,75
5579049	577C20017T	-	-	20,0	20	38,00	104	-
5579060	577C25008T	5579061	577C25008W	25,0	25	45,00	121	0,75

- Unequal flute spacing.
- Centre cutting.
- Single tool for both roughing and finishing operations requiring fewer setups.
- Slotting up to 1 x D.
- Standard items listed. Additional styles and coatings made-to-order.

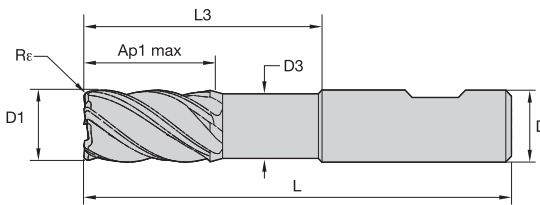
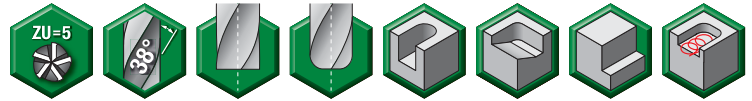

End Mill Tolerances

D1	tolerance e8	D	tolerance h6 + / -
≤ 3	-0,014/-0,028	≤ 3	0/-0,006
> 3-6	-0,020/-0,038	> 3-6	0/-0,008
> 6-10	-0,025/-0,047	> 6-10	0/-0,009
> 10-18	-0,032/-0,059	> 10-18	0/-0,011
> 18-30	-0,040/-0,073	> 18-30	0/-0,013



■ Series 57NC • VariMill II • With Neck • With Centre Cut • Victory Grades

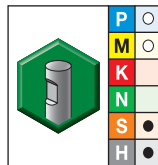
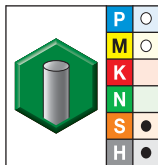

- first choice
- alternate choice

WS15PE AITiN		WS15PE AITiN		D1	D	D3	length of cut Ap1 max	L3	length L	Re
order #	catalogue #	order #	catalogue #							
5598906	57NC06002T	—	—	6,0	6	5,64	13,00	18,00	63	—
5598907	57NC06022T	5598908	57NC06022W	6,0	6	5,64	13,00	18,00	63	0,50
5598909	57NC06032T	5599070	57NC06032W	6,0	6	5,64	13,00	18,00	63	1,00
—	—	5599071	57NC06042W	6,0	6	5,64	13,00	18,00	63	1,50
5599072	57NC08003T	—	—	8,0	8	7,52	19,00	24,00	76	—
5599073	57NC08023T	5599074	57NC08023W	8,0	8	7,52	19,00	24,00	76	0,50
5599075	57NC08033T	5599076	57NC08033W	8,0	8	7,52	19,00	24,00	76	1,00
—	—	5599077	57NC08053W	8,0	8	7,52	19,00	24,00	76	2,00
5599078	57NC10004T	—	—	10,0	10	9,40	22,00	30,00	76	—
5599079	57NC10024T	5599080	57NC10024W	10,0	10	9,40	22,00	30,00	76	0,50
5599081	57NC10034T	5599082	57NC10034W	10,0	10	9,40	22,00	30,00	76	1,00
5599083	57NC10054T	5599084	57NC10054W	10,0	10	9,40	22,00	30,00	76	2,00
5599085	57NC12005T	—	—	12,0	12	11,28	26,00	36,00	83	—
5599086	57NC12025T	5599087	57NC12025W	12,0	12	11,28	26,00	36,00	83	0,50
5599088	57NC12035T	5599089	57NC12035W	12,0	12	11,28	26,00	36,00	83	1,00
5599090	57NC12055T	5599091	57NC12055W	12,0	12	11,28	26,00	36,00	83	2,00
5599092	57NC16006T	—	—	16,0	16	15,04	32,00	48,00	100	—
5599093	57NC16026T	5598905	57NC16026W	16,0	16	15,04	32,00	48,00	100	0,50
5599094	57NC16036T	5599095	57NC16036W	16,0	16	15,04	32,00	48,00	100	1,00
5599096	57NC16056T	5599097	57NC16056W	16,0	16	15,04	32,00	48,00	100	2,00

(continued)

(Series 57NC • VariMill II • With Neck • With Centre Cut • Victory Grades — continued)

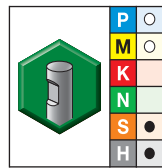
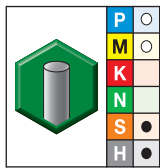
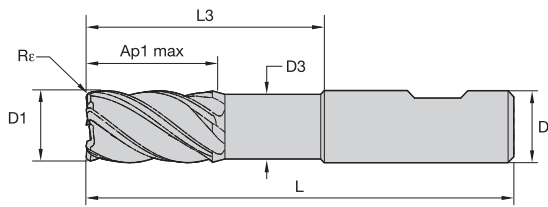

● first choice
 ○ alternate choice

WS15PE AITiN		WS15PE AITiN		D1	D	D3	length of cut Ap1 max	L3	length L	Re
order #	catalogue #	order #	catalogue #							
5599098	57NC16076T	5599099	57NC16076W	16,0	16	15,04	32,00	48,00	100	3,00
5599100	57NC20007T	—	—	20,0	20	18,80	38,00	60,00	115	—
5599101	57NC20027T	5599102	57NC20027W	20,0	20	18,80	38,00	60,00	115	0,50
5599103	57NC20037T	5599104	57NC20037W	20,0	20	18,80	38,00	60,00	115	1,00
5599105	57NC20057T	5599106	57NC20057W	20,0	20	18,80	38,00	60,00	115	2,00
5599107	57NC20077T	5599108	57NC20077W	20,0	20	18,80	38,00	60,00	115	3,00
5599109	57NC20087T	5599110	57NC20087W	20,0	20	18,80	38,00	60,00	115	4,00
5599111	57NC25008T	—	—	25,0	25	23,50	45,00	75,00	135	—
5599112	57NC25028T	5599113	57NC25028W	25,0	25	23,50	45,00	75,00	135	0,50
5599114	57NC25038T	5599115	57NC25038W	25,0	25	23,50	45,00	75,00	135	1,00
5599116	57NC25058T	5599117	57NC25058W	25,0	25	23,50	45,00	75,00	135	2,00
5599118	57NC25078T	5599119	57NC25078W	25,0	25	23,50	45,00	75,00	135	3,00
5599120	57NC25088T	5599121	57NC25088W	25,0	25	23,50	45,00	75,00	135	4,00

High-Performance Solid Carbide End Mills

■ Series 577C • VariMill II • Victory Grades



Material Group																	
	Side Milling (A) and Slotting (B)			WP15PE			Recommended feed per tooth (fz = mm/th) for side milling (A). For slotting (B), reduce fz by 20%.										
	A		B	Cutting Speed – vc m/min			D1 – Diameter										
	ap	ae	ap	min	–	max	mm	6,0	8,0	10,0	12,0	14,0	16,0	18,0	20,0	25,0	
P	0	1,5 x D	0,5 x D	1 x D	150	–	200	fz	0,044	0,060	0,072	0,083	0,092	0,101	0,108	0,114	0,124
	1	1,5 x D	0,5 x D	1 x D	150	–	200	fz	0,044	0,060	0,072	0,083	0,092	0,101	0,108	0,114	0,124
	2	1,5 x D	0,5 x D	1 x D	140	–	190	fz	0,044	0,060	0,072	0,083	0,092	0,101	0,108	0,114	0,124
	3	1,5 x D	0,5 x D	1 x D	120	–	160	fz	0,036	0,050	0,061	0,070	0,079	0,087	0,095	0,101	0,114
	4	1,5 x D	0,5 x D	0,75 x D	90	–	150	fz	0,033	0,045	0,054	0,062	0,070	0,077	0,083	0,088	0,098
M	5	1,5 x D	0,5 x D	1 x D	60	–	100	fz	0,029	0,040	0,048	0,056	0,063	0,070	0,076	0,081	0,091
	1	1,5 x D	0,5 x D	1 x D	90	–	115	fz	0,036	0,050	0,061	0,070	0,079	0,087	0,095	0,101	0,114
	2	1,5 x D	0,5 x D	1 x D	60	–	80	fz	0,029	0,040	0,048	0,056	0,063	0,070	0,076	0,081	0,091
K	3	1,5 x D	0,5 x D	1 x D	60	–	70	fz	0,025	0,034	0,040	0,047	0,052	0,057	0,061	0,065	0,071
	1	1,5 x D	0,5 x D	1 x D	120	–	150	fz	0,044	0,060	0,072	0,083	0,092	0,101	0,108	0,114	0,124
	2	1,5 x D	0,5 x D	1 x D	110	–	140	fz	0,036	0,050	0,061	0,070	0,079	0,087	0,095	0,101	0,114
S	3	1,5 x D	0,5 x D	1 x D	110	–	130	fz	0,029	0,040	0,048	0,056	0,063	0,070	0,076	0,081	0,091
	1	1,5 x D	0,3 x D	0,3 x D	50	–	90	fz	0,036	0,050	0,061	0,070	0,079	0,087	0,095	0,101	0,114
	2	1,5 x D	0,3 x D	0,3 x D	25	–	40	fz	0,019	0,026	0,032	0,037	0,042	0,046	0,050	0,054	0,061
	3	1,5 x D	0,3 x D	1 x D	60	–	80	fz	0,029	0,040	0,048	0,056	0,063	0,070	0,076	0,081	0,091
H	4	1,5 x D	0,5 x D	1 x D	50	–	60	fz	0,026	0,037	0,045	0,052	0,058	0,064	0,069	0,074	0,084
	1	1,5 x D	0,5 x D	0,75 x D	80	–	140	fz	0,033	0,045	0,054	0,062	0,070	0,077	0,083	0,088	0,098
	2	1,5 x D	0,2 x D	0,5 x D	70	–	120	fz	0,025	0,034	0,040	0,047	0,052	0,057	0,061	0,065	0,071

NOTE: Lower value of cutting speed is used for high stock removal applications or for higher hardness (machinability) within group.
Higher value of cutting speed is used for finishing applications or for lower hardness (machinability) within group.
Above parameters are based on ideal conditions. For smaller taper machining centres, please adjust parameters accordingly on >12mm diameters.

■ Series 57NC • VariMill II • With Neck • Victory Grades



Material Group																	
	Side Milling (A) and Slotting (B)			WS15PE			Recommended feed per tooth (fz = mm/th) for side milling (A). For slotting (B), reduce fz by 20%.										
	A		B	Cutting Speed – vc m/min			D1 – Diameter										
	ap	ae	ap	min	–	max	mm	6,0	8,0	10,0	12,0	14,0	16,0	18,0	20,0	25,0	
P	5	1,5 x D	0,5 x D	1 x D	60	–	100	fz	0,029	0,040	0,048	0,056	0,063	0,070	0,076	0,081	0,091
	6	1,5 x D	0,5 x D	0,75 x D	50	–	75	fz	0,025	0,034	0,040	0,047	0,052	0,057	0,061	0,065	0,071
M	1	1,5 x D	0,5 x D	1 x D	90	–	115	fz	0,036	0,050	0,061	0,070	0,079	0,087	0,095	0,101	0,114
	2	1,5 x D	0,5 x D	1 x D	60	–	80	fz	0,029	0,040	0,048	0,056	0,063	0,070	0,076	0,081	0,091
	3	1,5 x D	0,5 x D	1 x D	60	–	70	fz	0,025	0,034	0,040	0,047	0,052	0,057	0,061	0,065	0,071
K	1	1,5 x D	0,5 x D	1 x D	120	–	150	fz	0,044	0,060	0,072	0,083	0,092	0,101	0,108	0,114	0,124
	2	1,5 x D	0,5 x D	1 x D	110	–	140	fz	0,036	0,050	0,061	0,070	0,079	0,087	0,095	0,101	0,114
	3	1,5 x D	0,5 x D	1 x D	110	–	130	fz	0,029	0,040	0,048	0,056	0,063	0,070	0,076	0,081	0,091
S	1	1,5 x D	0,3 x D	0,3 x D	50	–	90	fz	0,036	0,050	0,061	0,070	0,079	0,087	0,095	0,101	0,114
	2	1,5 x D	0,3 x D	0,3 x D	25	–	40	fz	0,019	0,026	0,032	0,037	0,042	0,046	0,050	0,054	0,061
	3	1,5 x D	0,5 x D	1 x D	60	–	80	fz	0,029	0,040	0,048	0,056	0,063	0,070	0,076	0,081	0,091
	4	1,5 x D	0,5 x D	1 x D	50	–	60	fz	0,026	0,037	0,045	0,052	0,058	0,064	0,069	0,074	0,084
H	1	1,5 x D	0,5 x D	0,75 x D	80	–	140	fz	0,033	0,045	0,054	0,062	0,070	0,077	0,083	0,088	0,098
	2	1,5 x D	0,2 x D	0,5 x D	70	–	120	fz	0,025	0,034	0,040	0,047	0,052	0,057	0,061	0,065	0,071

NOTE: Lower value of cutting speed is used for high stock removal applications or for higher hardness (machinability) within group.
 Higher value of cutting speed is used for finishing applications or for lower hardness (machinability) within group.
 Above parameters are based on ideal conditions. For smaller taper machining centres, please adjust parameters accordingly on >12mm diameters.

X-Feed™ End Mills for High-Feed Milling



EXTREME **CHALLENGES.**
EXTREME **RESULTS.**

Specifically engineered to machine hardened steel up to 67 HRC at extreme speeds and feeds

- Unique tool with new 6-flute style for high productivity.
- Necked shanks provide extended reach in deep cavities.
- High feed rates, up to 0,6mm per tooth on a 20mm tool.
- Machine hardened materials at 2–3x the metal removal rate of competitive end mills.
- Wide range of cutting diameters: down to 6mm for small and medium pocket work.
- Innovative new geometry maximises metal removal rates.
- High metal removal rates and lower manufacturing costs.

To learn more about our innovations, contact your local Authorised Distributor or visit widia.com.

WIDIA 

High-Performance Solid Carbide End Mills •

VariMill II™ ER

VariMill II ER



Engineered with Eccentric Relief (ER) grind at the cutting edges for greater edge strength, enabling higher metal removal rates and increased productivity. The new VariMill II ER is the first WIDIA™ off-the-shelf end mill available with **SAFE-λOCK®** by HAIMER, providing excellent stability, eliminating end mill pullout, and increasing concentric tool clamping. Though primarily designed for roughing and finishing applications in the aerospace industry, VariMill II ER can be used as a solution for any titanium or stainless steel application and is capable of slotting, ramping, and plunging.

- High-performance tools for titanium and stainless steel workpiece materials.
- Roughing and finishing with one tool, lowering tool costs.
- Various radius and necked versions available.
- Standard offering with **SAFE-λOCK®** by HAIMER.

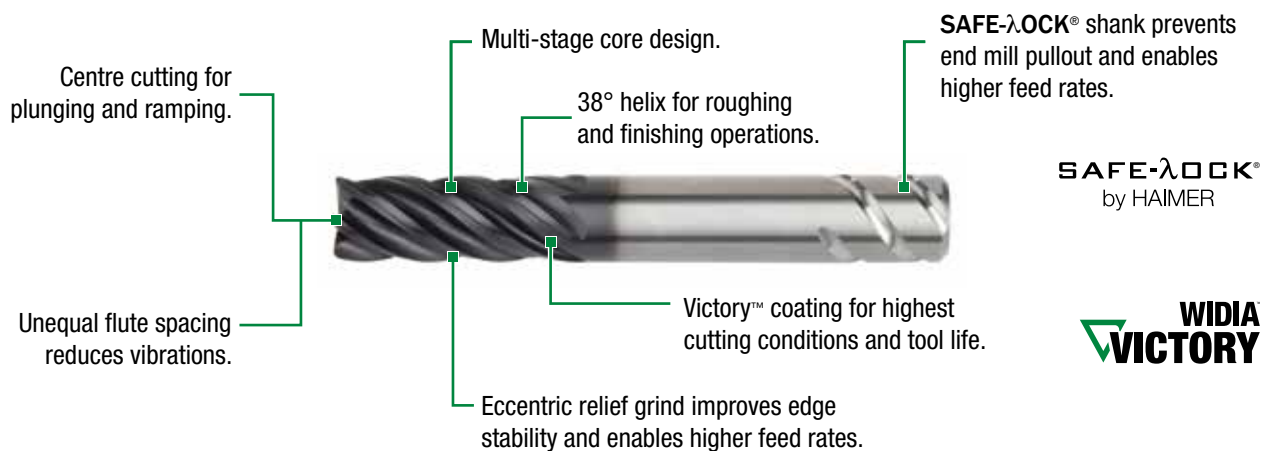

VariMill II™ ER Series

- Unique geometry providing increased tool life and higher metal removal rates in difficult-to-machine workpiece materials.
- Increased output due to fewer tool changes and higher metal removal rates.
- Roughing and finishing with one tool, lowering tool costs.
- 1 x D slotting capability requires less passes, increasing productivity.

577E Series

- Eccentric relief for edge stability and strength.
- Extensive radii corner offering.



57NE Series

- Eccentric relief for edge stability and strength.
- Extensive radii corner offering.
- Neck design for depths requiring additional passes.



Application Example

Side milling of INCONEL® 718 component.

Workpiece material: INCONEL 718

Tool: D = 16mm

Cutting data: $a_p = 27,43\text{mm}$

$a_e = 1,3\text{mm}$

$vc = 19,8\text{ m/min}$

$f_z = 0,05\text{ mm/th}$

Result: Increased tool life from 2 workpieces to 5.

- Unequal flute spacing.
- Centre cutting.
- Optimised geometry for titanium machining.
- Single tool for both roughing and finishing operations requiring fewer setups.
- Standard items listed. Additional styles and coatings made-to-order.

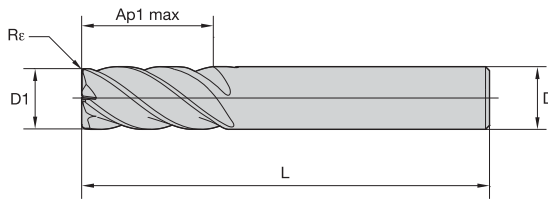
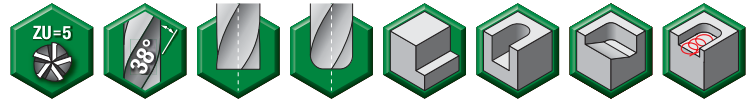

End Mill Tolerances

D1	tolerance e8	D	tolerance h6 + / -
≤ 3	-0,014/-0,028	≤ 3	0/-0,006
> 3-6	-0,020/-0,038	> 3-6	0/-0,008
> 6-10	-0,025/-0,047	> 6-10	0/-0,009
> 10-18	-0,032/-0,059	> 10-18	0/-0,011
> 18-30	-0,040/-0,073	> 18-30	0/-0,013



Series 577E • VariMill II ER • Victory Grades

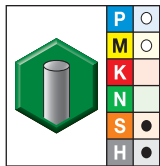

WS15PE
AITiN

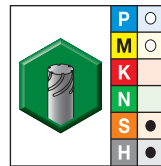

WS15PE
AITiN

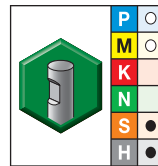

WS15PE
AITiN

- first choice
- alternate choice

order #	catalogue #	order #	catalogue #	order #	catalogue #	D1	D	length of cut Ap1 max	length L	Re
5599171	577E10004T	-	-	-	-	10,0	10	22,00	72	-
5599172	577E10024T	-	-	5599173	577E10024W	10,0	10	22,00	72	0,50
-	-	5599174	577E12005V	-	-	12,0	12	26,00	83	-
-	-	5599175	577E12015V	5599176	577E12015W	12,0	12	26,00	83	0,75
-	-	5599177	577E16006V	-	-	16,0	16	32,00	92	-
-	-	5599178	577E16016V	5599179	577E16016W	16,0	16	32,00	92	0,75
-	-	5599180	577E20007V	-	-	20,0	20	38,00	104	-
-	-	5599181	577E20017V	5599182	577E20017W	20,0	20	38,00	104	0,75
-	-	5599183	577E25018V	5599184	577E25018W	25,0	25	45,00	121	0,75

- Unequal flute spacing.
- Centre cutting.
- Optimised geometry for titanium machining.
- Single tool for both roughing and finishing operations requiring fewer setups.
- Standard items listed. Additional styles and coatings made-to-order.

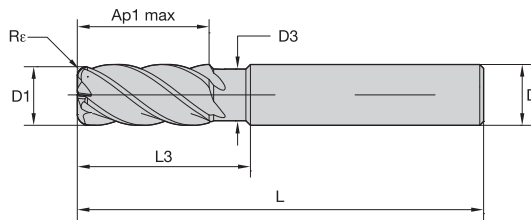
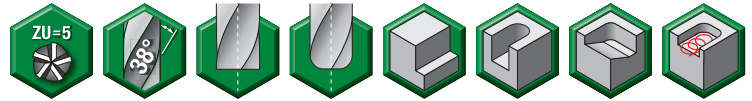

End Mill Tolerances

D1	tolerance e8	D	tolerance h6 + / -
≤ 3	-0,014/-0,028	≤ 3	0/-0,006
> 3-6	-0,020/-0,038	> 3-6	0/-0,008
> 6-10	-0,025/-0,047	> 6-10	0/-0,009
> 10-18	-0,032/-0,059	> 10-18	0/-0,011
> 18-30	-0,040/-0,073	> 18-30	0/-0,013



■ Series 57NE • VariMill II ER • With Neck • Victory Grades

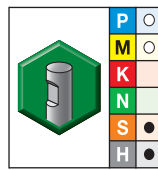
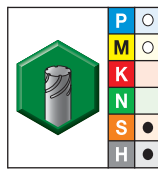
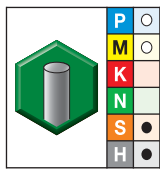

- first choice
- alternate choice

order #	catalogue #	order #	catalogue #	order #	catalogue #	D1	D	D3	length of cut Ap1 max	L3	length L	Re
5599122	57NE10004T	—	—	—	—	10,0	10	9,40	22,00	30,00	76	—
5599123	57NE10024T	—	—	5599124	57NE10024W	10,0	10	9,40	22,00	30,00	76	0,50
5599125	57NE10034T	—	—	5599126	57NE10034W	10,0	10	9,40	22,00	30,00	76	1,00
5599127	57NE10054T	—	—	5599128	57NE10054W	10,0	10	9,40	22,00	30,00	76	2,00
—	—	5599129	57NE12005V	—	—	12,0	12	11,28	26,00	36,00	83	—
—	—	5599130	57NE12025V	5599131	57NE12025W	12,0	12	11,28	26,00	36,00	83	0,50
—	—	5599132	57NE12035V	5599133	57NE12035W	12,0	12	11,28	26,00	36,00	83	1,00
—	—	5599134	57NE12055V	5599135	57NE12055W	12,0	12	11,28	26,00	36,00	83	2,00
—	—	5599136	57NE16006V	—	—	16,0	16	15,04	32,00	48,00	100	—
—	—	5599137	57NE16026V	5599138	57NE16026W	16,0	16	15,04	32,00	48,00	100	0,50
—	—	5599139	57NE16036V	5599140	57NE16036W	16,0	16	15,04	32,00	48,00	100	1,00
—	—	5599141	57NE16056V	5599142	57NE16056W	16,0	16	15,04	32,00	48,00	100	2,00
—	—	5599143	57NE20007V	—	—	20,0	20	18,80	38,00	60,00	115	—
—	—	5599144	57NE20027V	5599145	57NE20027W	20,0	20	18,80	38,00	60,00	115	0,50
—	—	5599146	57NE20037V	5599147	57NE20037W	20,0	20	18,80	38,00	60,00	115	1,00
—	—	5599148	57NE20057V	5599149	57NE20057W	20,0	20	18,80	38,00	60,00	115	2,00
—	—	5599160	57NE20087V	5599161	57NE20087W	20,0	20	18,80	38,00	60,00	115	4,00
—	—	5599162	57NE25008V	—	—	25,0	25	23,50	45,00	75,00	135	—
—	—	5599163	57NE25028V	5599164	57NE25028W	25,0	25	23,50	45,00	75,00	135	0,50
—	—	5599165	57NE25038V	5599166	57NE25038W	25,0	25	23,50	45,00	75,00	135	1,00
—	—	5599167	57NE25058V	5599168	57NE25058W	25,0	25	23,50	45,00	75,00	135	2,00
—	—	5599169	57NE25088V	5599170	57NE25088W	25,0	25	23,50	45,00	75,00	135	4,00

■ Series 577E • VariMill II ER • Victory Grades



Material Group								Recommended feed per tooth (fz = mm/th) for side milling (A). For slotting (B), reduce fz by 20%.								
		Side Milling (A) and Slotting (B)		WS15PE												
		A		B		Cutting Speed – vc m/min			D1 – Diameter							
		ap	ae	ap	min		max	mm	10,0	12,0	16,0	18,0	20,0	25,0		
P	5	1,5 x D	0,5 x D	1 x D	60	–	100	fz	0,048	0,056	0,070	0,076	0,081	0,091		
	6	1,5 x D	0,5 x D	0,75 x D	50	–	75	fz	0,040	0,047	0,057	0,061	0,065	0,071		
M	1	1,5 x D	0,5 x D	1 x D	90	–	115	fz	0,061	0,070	0,087	0,095	0,101	0,114		
	2	1,5 x D	0,5 x D	1 x D	60	–	80	fz	0,048	0,056	0,070	0,076	0,081	0,091		
	3	1,5 x D	0,5 x D	1 x D	60	–	70	fz	0,040	0,047	0,057	0,061	0,065	0,071		
S	1	1,5 x D	0,3 x D	0,3 x D	50	–	90	fz	0,061	0,070	0,087	0,095	0,101	0,114		
	2	1,5 x D	0,3 x D	0,3 x D	50	–	90	fz	0,032	0,037	0,046	0,050	0,054	0,061		
	3	1,5 x D	0,3 x D	1 x D	25	–	40	fz	0,048	0,056	0,070	0,076	0,081	0,091		
	4	1,5 x D	0,5 x D	1 x D	50	–	60	fz	0,045	0,052	0,064	0,069	0,074	0,084		
H	1	1,5 x D	0,5 x D	0,75 x D	80	–	140	fz	0,054	0,062	0,077	0,083	0,088	0,098		
	2	1,5 x D	0,2 x D	0,5 x D	70	–	120	fz	0,040	0,047	0,057	0,061	0,065	0,071		

NOTE: Lower value of cutting speed is used for high stock removal applications or for higher hardness (machinability) within group.
Higher value of cutting speed is used for finishing applications or for lower hardness (machinability) within group.
Above parameters are based on ideal conditions. For smaller taper machining centres, please adjust parameters accordingly on >12mm diameters.

■ Series 57NE • VariMill II ER • With Neck • Victory Grades



Material Group								Recommended feed per tooth (fz = mm/th) for side milling (A). For slotting (B), reduce fz by 20%.						
		Side Milling (A) and Slotting (B)		WS15PE										
		A		B	Cutting Speed – vc m/min			D1 – Diameter						
		ap	ae	ap	min		max	mm	10,0	12,0	16,0	18,0	20,0	25,0
P	5	1,5 x D	0,5 x D	1 x D	60	-	100	fz	0,048	0,056	0,070	0,076	0,081	0,091
	6	1,5 x D	0,5 x D	0,75 x D	50	-	75	fz	0,040	0,047	0,057	0,061	0,065	0,071
M	1	1,5 x D	0,5 x D	1 x D	90	-	115	fz	0,061	0,070	0,087	0,095	0,101	0,114
	2	1,5 x D	0,5 x D	1 x D	60	-	80	fz	0,048	0,056	0,070	0,076	0,081	0,091
	3	1,5 x D	0,5 x D	1 x D	60	-	70	fz	0,040	0,047	0,057	0,061	0,065	0,071
S	1	1,5 x D	0,3 x D	0,3 x D	50	-	90	fz	0,061	0,070	0,087	0,095	0,101	0,114
	2	1,5 x D	0,3 x D	0,3 x D	25	-	50	fz	0,032	0,037	0,046	0,050	0,054	0,061
	3	1,5 x D	0,3 x D	1 x D	40	-	90	fz	0,048	0,056	0,070	0,076	0,081	0,091
	4	1,5 x D	0,5 x D	1 x D	50	-	60	fz	0,045	0,052	0,064	0,069	0,074	0,084
H	1	1,5 x D	0,5 x D	0,75 x D	80	-	140	fz	0,054	0,062	0,077	0,083	0,088	0,098
	2	1,5 x D	0,2 x D	0,5 x D	70	-	120	fz	0,040	0,047	0,057	0,061	0,065	0,071

NOTE: Lower value of cutting speed is used for high stock removal applications or for higher hardness (machinability) within group.
Higher value of cutting speed is used for finishing applications or for lower hardness (machinability) within group.
Above parameters are based on ideal conditions. For smaller taper machining centres, please adjust parameters accordingly on >12mm diameters.

High-Performance Solid Carbide End Mills •
VariMill II™ Long

VariMill II Long



Designed to achieve highest surface quality and tool life in titanium, stainless steels, and steels. Innovative core and tool geometry design enable chatter-free corner machining in one pass. VariMill II Long covers 4 x D lengths-of-cut for semi-finishing and fine finishing operations with radii and sharp corner versions from stock.

- Tailored 43° helix improves surface finish.
- Less passes in side milling with 4 x D length-of-cut capability.
- One tool for semi-finishing and fine finishing operations.
- No need for feed rate reduction when machining corners.

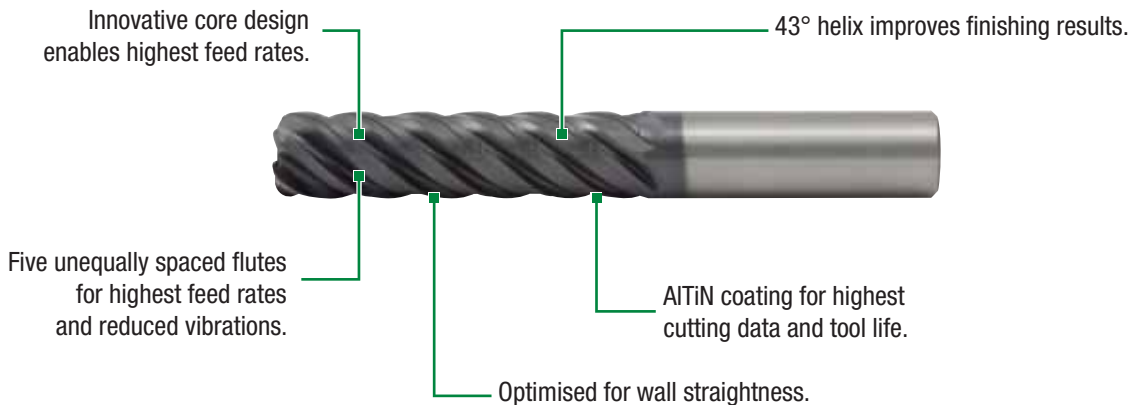

VariMill II™ Long Series

- Achieve excellent surface finish and outstanding wall straightness.
- Benefit from high accuracy even with thin wall machining.
- Simplify your programming of cavities by keeping the feed rate and radial engagement constant.

5718 Series

- Highest surface quality and tool life in:
 - Titanium
 - Stainless steels
- Corner radii and sharp edges.
- 4 x D length of cut.

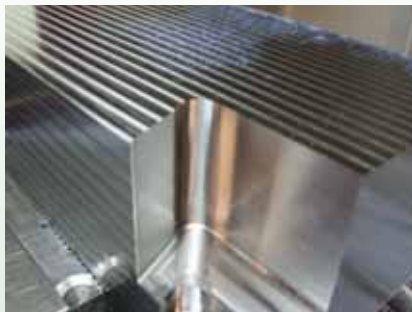
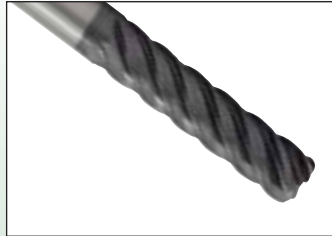

Application Example

Side milling 60° angled corner with constant feed rate.

Workpiece material: Titanium 6Al-4V

Tool: D = 15,875mm

Cutting data: $a_p = 63\text{mm}$

$a_e = 0,5\text{mm}$

$v_c = 100\text{ m/min}$

$f_z = 0,06\text{ mm/z}$

Result: Surface finish Ra 0,4 μm

- Unequal flute spacing.
- Non-centre cutting.
- For finishing and semi-finishing applications.
- Standard items listed. Additional styles and coatings made-to-order.

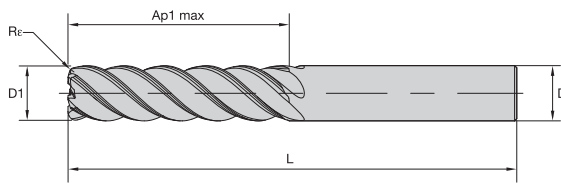

End Mill Tolerances

D1	tolerance e8	D	tolerance h6 + / -
≤ 3	-0,014/-0,028	≤ 3	0/-0,006
> 3-6	-0,020/-0,038	> 3-6	0/-0,008
> 6-10	-0,025/-0,047	> 6-10	0/-0,009
> 10-18	-0,032/-0,059	> 10-18	0/-0,011
> 18-30	-0,040/-0,073	> 18-30	0/-0,013

■ Series 5718 • VariMill II Long • 4 x D Length of Cut

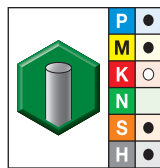

grade AlTiN-MT
AlTiN

- first choice
- alternate choice

order #	catalogue #	D1	D	length of cut Ap1 max	length L	Re
5096566	571806002MT	6,0	6	24,00	76	—
5096567	571806012MT	6,0	6	24,00	76	0,50
5096568	571806022MT	6,0	6	24,00	76	1,00
5096569	571808003MT	8,0	8	32,00	76	—
5096660	571808013MT	8,0	8	32,00	76	0,50
5096661	571808023MT	8,0	8	32,00	76	1,00
4124297	571810004MT	10,0	10	40,00	100	—
5096662	571810014MT	10,0	10	40,00	100	0,50
5096664	571810034MT	10,0	10	40,00	100	2,00
5096665	571810044MT	10,0	10	40,00	100	2,50
4124298	571812005MT	12,0	12	48,00	125	—
5096667	571812025MT	12,0	12	48,00	125	1,00
5096668	571812035MT	12,0	12	48,00	125	2,00
5096669	571812045MT	12,0	12	48,00	125	2,50
4124299	571814014MT	14,0	14	56,00	120	—
5096752	571814024MT	14,0	14	56,00	120	1,00
5096753	571814034MT	14,0	14	56,00	120	2,00
5096754	571814044MT	14,0	14	56,00	120	3,00
5096755	571814054MT	14,0	14	56,00	120	4,00
4124300	571816006MT	16,0	16	64,00	141	—

(continued)

(Series 5718 • VariMill II Long • 4 x D Length of Cut — continued)

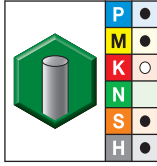
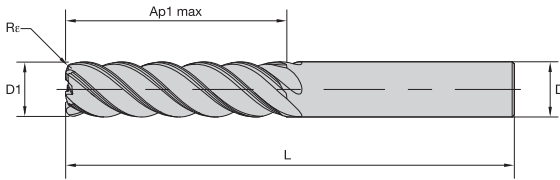

● first choice
○ alternate choice

grade AlTiN-MT AlTiN		D1	D	length of cut Ap1 max	length L	Rε
5096756	571816016MT	16,0	16	64,00	141	0,50
5096757	571816026MT	16,0	16	64,00	141	1,00
5096758	571816036MT	16,0	16	64,00	141	2,00
5096759	571816046MT	16,0	16	64,00	141	3,00
5096800	571816056MT	16,0	16	64,00	141	4,00
4124301	571818018MT	18,0	18	72,00	150	—
5096801	571818028MT	18,0	18	72,00	150	1,00
5096802	571818038MT	18,0	18	72,00	150	2,00
5096803	571818048MT	18,0	18	72,00	150	3,00
5096804	571818058MT	18,0	18	72,00	150	4,00
4124302	571820007MT	20,0	20	80,00	150	—
5096805	571820017MT	20,0	20	80,00	150	0,50
5096806	571820027MT	20,0	20	80,00	150	1,00
5096807	571820037MT	20,0	20	80,00	150	2,00
5096808	571820047MT	20,0	20	80,00	150	3,00
5096809	571820057MT	20,0	20	80,00	150	4,00
4124323	571825008MT	25,0	25	100,00	170	—
5096860	571825018MT	25,0	25	100,00	170	0,50
5096861	571825028MT	25,0	25	100,00	170	1,00
5096862	571825038MT	25,0	25	100,00	170	2,00
5096863	571825048MT	25,0	25	100,00	170	3,00
5096864	571825058MT	25,0	25	100,00	170	4,00

High-Performance Solid Carbide End Mills

■ Series 5718 • VariMill II Long • 4 x D Length of Cut

Material Group																
	Side Milling (A)		AlTiN			Recommended feed per tooth (fz = mm/th) for side milling (A). For slotting (B), reduce fz by 20%.										
	A		Cutting Speed – vc m/min			D1 – Diameter										
	ap	ae	min		max	mm	6,0	8,0	10,0	12,0	14,0	16,0	18,0	20,0	25,0	
P	0	Ap1 max	0,05 x D*	300	–	400	fz	0,053	0,072	0,086	0,099	0,111	0,121	0,130	0,137	0,149
	1	Ap1 max	0,05 x D*	300	–	400	fz	0,053	0,072	0,086	0,099	0,111	0,121	0,130	0,137	0,149
	2	Ap1 max	0,05 x D*	280	–	380	fz	0,053	0,072	0,086	0,099	0,111	0,121	0,130	0,137	0,149
	3	Ap1 max	0,05 x D*	240	–	320	fz	0,044	0,060	0,073	0,084	0,095	0,105	0,113	0,121	0,137
	4	Ap1 max	0,05 x D*	180	–	300	fz	0,039	0,054	0,065	0,075	0,084	0,092	0,099	0,106	0,117
	5	Ap1 max	0,05 x D*	120	–	200	fz	0,035	0,048	0,058	0,067	0,076	0,084	0,091	0,097	0,109
M	1	Ap1 max	0,05 x D*	180	–	230	fz	0,044	0,060	0,073	0,084	0,095	0,105	0,113	0,121	0,137
	2	Ap1 max	0,05 x D*	120	–	160	fz	0,035	0,048	0,058	0,067	0,076	0,084	0,091	0,097	0,109
	3	Ap1 max	0,05 x D*	120	–	140	fz	0,030	0,040	0,048	0,056	0,062	0,068	0,073	0,078	0,085
K	1	Ap1 max	0,05 x D*	240	–	300	fz	0,053	0,072	0,086	0,099	0,111	0,121	0,130	0,137	0,149
	2	Ap1 max	0,05 x D*	220	–	280	fz	0,044	0,060	0,073	0,084	0,095	0,105	0,113	0,121	0,137
	3	Ap1 max	0,05 x D*	220	–	260	fz	0,035	0,048	0,058	0,067	0,076	0,084	0,091	0,097	0,109
S	1	Ap1 max	0,05 x D*	100	–	180	fz	0,044	0,060	0,073	0,084	0,095	0,105	0,113	0,121	0,137
	2	Ap1 max	0,05 x D*	50	–	80	fz	0,023	0,032	0,038	0,045	0,050	0,056	0,060	0,065	0,074
	3	Ap1 max	0,05 x D*	120	–	160	fz	0,035	0,048	0,058	0,067	0,076	0,084	0,091	0,097	0,109
	4	Ap1 max	0,05 x D*	100	–	120	fz	0,031	0,044	0,053	0,062	0,070	0,077	0,083	0,089	0,100
H	1	Ap1 max	0,05 x D*	160	–	280	fz	0,039	0,054	0,065	0,075	0,084	0,092	0,099	0,106	0,117
	2	Ap1 max	0,06 x D*	140	–	240	fz	0,030	0,040	0,048	0,056	0,062	0,068	0,073	0,078	0,085

* For the above cutting data, do not exceed an overall ae of 0,8mm.
 NOTE: Lower value of cutting speed is used for high stock removal applications or for higher hardness (machinability) within group.
 Higher value of cutting speed is used for finishing applications or for lower hardness (machinability) within group.
 Above parameters are based on ideal conditions. For smaller taper machining centres, please adjust parameters accordingly on >12mm diameters.

High-Performance Solid Carbide End Mills

Designed to significantly reduce machining time in aluminium!



EXTREME CHALLENGES.
EXTREME RESULTS.

AluSurf™ Carbide End Mills for High Metal Removal Rates and Superior Surface Finishes

- Use only one tool for roughing and finishing operations.
- Slotting is effective up to full, 1 x D axial depth; side milling (profiling) is effective up to 0.5 x D, radial by 1.5 x D axial depth.
- Three-flute series uses unequal flute spacing for chatter-free performance.
- Effective in a full range of machine speeds.
- Multiple corner radii and extended neck configurations are available as standard.

To learn more about our innovations, contact your local Authorised Distributor or visit widia.com.

WIDIA 

High-Performance Solid Carbide End Mills •
VariMill III™ ER



VariMill III ER

The trend towards more efficiency and increased productivity using high-speed machining techniques such as trochoidal and peel milling will continue to be a focus for aerospace components. The new VariMill III ER is designed to provide the highest Metal Removal Rates (MRR) and extended tool life in the most demanding materials in the aerospace industry. VariMill III ER is designed to be applied in titanium and stainless steel workpiece materials for both semi-finishing and finishing applications.

- 7-flute eccentric relief design provides edge strength along with high productivity.
- Superior surface finishes and wall straightness capability from specialised core.
- Finishing and semi-finishing at up to 30% of the diameter with one tool.
- First choice for high-speed machining in difficult-to-cut workpiece materials.

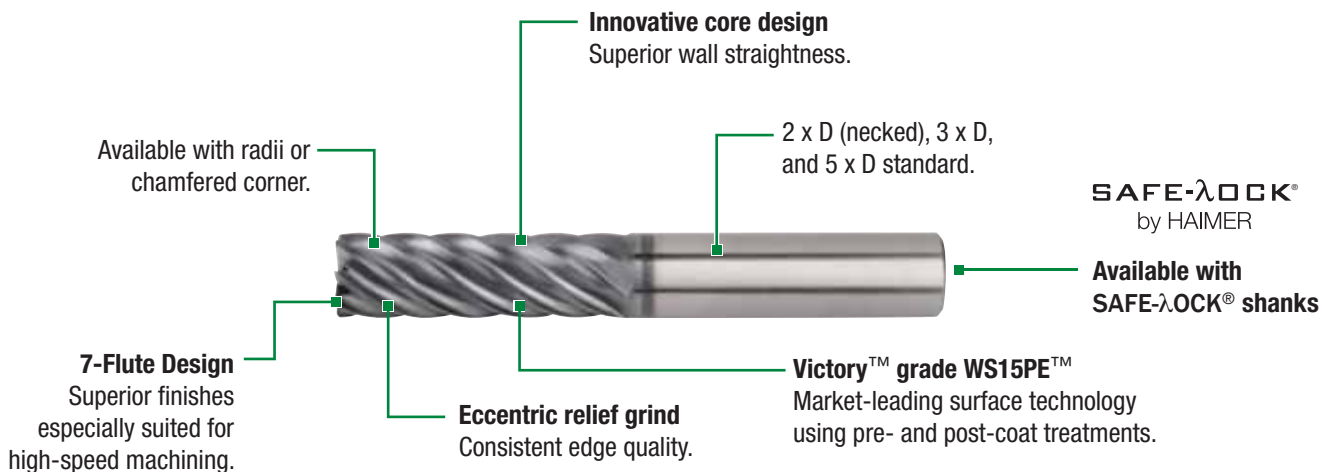

WIDIA
VICTORY

WIDIA

VariMill III™ ER Series

- Seven unequally spaced flutes provide the maximum output and surface quality.
- Eccentric relief for edge strength and stability.
- Semi-finishing and finishing with one tool.
- Victory™ grade WS15PE™ for increased heat and wear resistance.

77NE Series

- Titanium and stainless steel geometry design.
- Corner radii and chamfered corners.
- 2 x D length of cut.
- Necked 5 x D reach.
- Centre cutting.

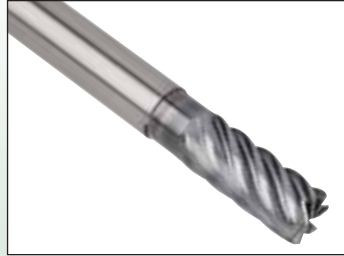

772E Series

- Titanium and stainless steel geometry design.
- Corner radii and chamfered corners.
- 5 x D length of cut.
- Centre cutting.
- SAFE-LOCK®.



771E Series

- Titanium and stainless steel geometry design.
- Corner radii and chamfered corners.
- 3 x D length of cut.
- Centre cutting.



- Unequal flute spacing.
- Centre cutting.
- Ramping angle 3°
- Optimised for difficult-to-machine workpiece materials.
- Semi-finishing to finishing applications.
- High speed machining capability.
- Standard items listed. Additional styles and coatings made to order.

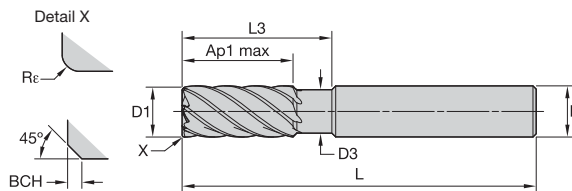

End Mill Tolerances

D1	tolerance e8	D	tolerance h6 + / -
≤ 3	-0,014/-0,028	≤ 3	0/-0,006
> 3-6	-0,020/-0,038	> 3-6	0/-0,008
> 6-10	-0,025/-0,047	> 6-10	0/-0,009
> 10-18	-0,032/-0,059	> 10-18	0/-0,011
> 18-30	-0,040/-0,073	> 18-30	0/-0,013



■ Series 77NE • VariMill III ER • With Neck • Victory Grades

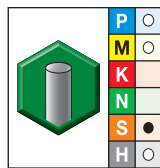

WS15PE
AlTiN

- first choice
- alternate choice

order #	catalogue #	D1	D	D3	length of cut Ap1 max	L3	length L	Re	BCH
5978039	77NE10004T	10,0	10	9,40	22,00	30,00	76	—	0,50
5978040	77NE10024T	10,0	10	9,40	22,00	30,00	76	0,50	—
5978096	77NE12005T	12,0	12	11,28	26,00	36,00	83	—	0,50
5978097	77NE12025T	12,0	12	11,28	26,00	36,00	83	0,50	—
5978104	77NE16006T	16,0	16	15,04	32,00	48,00	100	—	0,50
5978105	77NE16026T	16,0	16	15,04	32,00	48,00	100	0,50	—
5978112	77NE20007T	20,0	20	18,80	38,00	60,00	115	—	0,50
5978113	77NE20027T	20,0	20	18,80	38,00	60,00	115	0,50	—

- Unequal flute spacing.
- Centre cutting.
- Ramping angle 3°.
- Optimised for difficult-to-machine workpiece materials.
- Semi-finishing to finishing applications.
- High-speed machining capability.
- Standard items listed. Additional styles and coatings made to order.

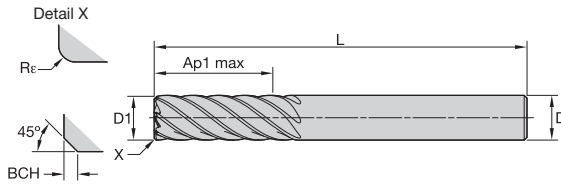

End Mill Tolerances

D1	tolerance e8	D	tolerance h6 + / -
≤ 3	-0,014/-0,028	≤ 3	0/-0,006
> 3-6	-0,020/-0,038	> 3-6	0/-0,008
> 6-10	-0,025/-0,047	> 6-10	0/-0,009
> 10-18	-0,032/-0,059	> 10-18	0/-0,011
> 18-30	-0,040/-0,073	> 18-30	0/-0,013



■ Series 771E 772E • VariMill III ER • Victory Grades

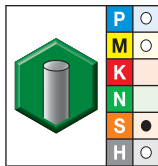

WS15PE
AITiN

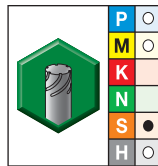

WS15PE
AITiN

- first choice
- alternate choice

order #	catalogue #	order #	catalogue #	D1	D	length of cut Ap1 max	length L	Rε	BCH
5978092	771E10004T	—	—	10,0	10	30,00	76	—	0,50
5978093	771E10024T	—	—	10,0	10	30,00	76	0,50	—
5978094	772E10004T	—	—	10,0	10	50,00	100	—	0,50
5978095	772E10024T	—	—	10,0	10	50,00	100	0,50	—
5978098	771E12005T	—	—	12,0	12	36,00	100	—	0,50
5978099	771E12025T	—	—	12,0	12	36,00	100	0,50	—
5978100	772E12005T	5978102	772E12005V	12,0	12	60,00	125	—	0,50
5978101	772E12025T	5978103	772E12025V	12,0	12	60,00	125	0,50	—
5978106	771E16006T	—	—	16,0	16	48,00	110	—	0,50
5978107	771E16026T	—	—	16,0	16	48,00	110	0,50	—
5978108	772E16006T	5978110	772E16006V	16,0	16	80,00	141	—	0,50
5978109	772E16026T	5978111	772E16026V	16,0	16	80,00	141	0,50	—
5978114	771E20007T	—	—	20,0	20	60,00	125	—	0,50
5978115	771E20027T	—	—	20,0	20	60,00	125	0,50	—
5978116	772E20007T	5978118	772E20007V	20,0	20	100,00	166	—	0,50
5978117	772E20027T	5978119	772E20027V	20,0	20	100,00	166	0,50	—

■ Series 77NE • VariMill III ER • With Neck • Semi-Finishing • Victory Grades



Material Group	Side Milling (A)		WS15PE			Recommended feed per tooth (fz = mm/th) for side milling (A).						
	A		Cutting Speed – vc m/min			mm	D1 – Diameter					
	ap	ae	min		max		10,0	12,0	16,0	18,0	20,0	
						fz						
P	4	Ap1 max	0,3 x D	90	–	150	fz	0,054	0,062	0,077	0,083	0,088
	5	Ap1 max	0,3 x D	60	–	100	fz	0,048	0,056	0,070	0,076	0,081
M	1	Ap1 max	0,3 x D	90	–	115	fz	0,061	0,070	0,087	0,095	0,101
	2	Ap1 max	0,3 x D	60	–	80	fz	0,048	0,056	0,070	0,076	0,081
	3	Ap1 max	0,3 x D	60	–	70	fz	0,040	0,047	0,057	0,061	0,065
S	1	Ap1 max	0,3 x D	50	–	90	fz	0,061	0,070	0,087	0,095	0,101
	2	Ap1 max	0,3 x D	25	–	40	fz	0,032	0,037	0,046	0,050	0,054
	3	Ap1 max	0,3 x D	60	–	80	fz	0,048	0,056	0,070	0,076	0,081
	4	Ap1 max	0,3 x D	50	–	60	fz	0,045	0,052	0,064	0,069	0,074
H	1	Ap1 max	0,3 x D	80	–	140	fz	0,054	0,062	0,077	0,083	0,088
	2	Ap1 max	0,3 x D	70	–	120	fz	0,040	0,047	0,057	0,061	0,065

NOTE: Lower value of cutting speed is used for high stock removal applications or for higher hardness (machinability) within group.
 Higher value of cutting speed is used for finishing applications or for lower hardness (machinability) within group.
 Above parameters are based on ideal conditions. For smaller taper machining centres, please adjust parameters accordingly on >12mm diameters.

■ Series 77NE • VariMill III ER • With Neck • Finishing • Victory Grades



Material Group	Side Milling (A)		WS15PE			Recommended feed per tooth (fz = mm/th) for side milling (A).						
	A		Cutting Speed – vc m/min			mm	D1 – Diameter					
	ap	ae	min		max		10,0	12,0	16,0	18,0	20,0	
						fz						
P	4	Ap1 max	0,06 x D	180	–	300	fz	0,065	0,075	0,092	0,099	0,106
	5	Ap1 max	0,06 x D	120	–	200	fz	0,058	0,067	0,084	0,091	0,097
M	1	Ap1 max	0,06 x D	180	–	230	fz	0,073	0,084	0,105	0,113	0,121
	2	Ap1 max	0,06 x D	120	–	160	fz	0,058	0,067	0,084	0,091	0,097
	3	Ap1 max	0,06 x D	120	–	140	fz	0,048	0,056	0,068	0,073	0,078
S	1	Ap1 max	0,06 x D	100	–	180	fz	0,073	0,084	0,105	0,113	0,121
	2	Ap1 max	0,06 x D	50	–	80	fz	0,038	0,045	0,056	0,060	0,065
	3	Ap1 max	0,06 x D	120	–	160	fz	0,058	0,067	0,084	0,091	0,097
	4	Ap1 max	0,06 x D	100	–	120	fz	0,053	0,062	0,077	0,083	0,089
H	1	Ap1 max	0,06 x D	160	–	280	fz	0,065	0,075	0,092	0,099	0,106
	2	Ap1 max	0,06 x D	140	–	240	fz	0,048	0,056	0,068	0,073	0,078

NOTE: Lower value of cutting speed is used for high stock removal applications or for higher hardness (machinability) within group.
 Higher value of cutting speed is used for finishing applications or for lower hardness (machinability) within group.
 Above parameters are based on ideal conditions. For smaller taper machining centres, please adjust parameters accordingly on >12mm diameters.

High-Performance Solid Carbide End Mills

■ Series 771E • VariMill III ER • Semi-Finishing • Victory Grades



Material Group	Side Milling (A)		WS15PE			Recommended feed per tooth (fz = mm/th) for side milling (A).						
	A		Cutting Speed – vc m/min			D1 – Diameter						
	ap	ae	min		max	mm	10,0	12,0	16,0	18,0	20,0	
P	4	3 x D	0,2 x D	90	–	150	fz	0,054	0,062	0,077	0,083	0,088
	5	3 x D	0,2 x D	60	–	100	fz	0,048	0,056	0,070	0,076	0,081
M	1	3 x D	0,2 x D	90	–	115	fz	0,061	0,070	0,087	0,095	0,101
	2	3 x D	0,2 x D	60	–	80	fz	0,048	0,056	0,070	0,076	0,081
	3	3 x D	0,2 x D	60	–	70	fz	0,040	0,047	0,057	0,061	0,065
S	1	3 x D	0,2 x D	50	–	90	fz	0,061	0,070	0,087	0,095	0,101
	2	3 x D	0,2 x D	25	–	40	fz	0,032	0,037	0,046	0,050	0,054
	3	3 x D	0,2 x D	60	–	80	fz	0,048	0,056	0,070	0,076	0,081
	4	3 x D	0,2 x D	50	–	60	fz	0,045	0,052	0,064	0,069	0,074
H	1	3 x D	0,2 x D	80	–	140	fz	0,054	0,062	0,077	0,083	0,088
	2	3 x D	0,2 x D	70	–	120	fz	0,040	0,047	0,057	0,061	0,065

NOTE: Lower value of cutting speed is used for high stock removal applications or for higher hardness (machinability) within group.
Higher value of cutting speed is used for finishing applications or for lower hardness (machinability) within group.
Above parameters are based on ideal conditions. For smaller taper machining centres, please adjust parameters accordingly on >12mm diameters.

■ Series 771E • VariMill III ER • Finishing • Victory Grades



Material Group	Side Milling (A)		WS15PE			Recommended feed per tooth (fz = mm/th) for side milling (A).						
	A		Cutting Speed – vc m/min			D1 – Diameter						
	ap	ae	min		max	mm	10,0	12,0	16,0	18,0	20,0	
P	4	3 x D	0,06 x D	180	–	300	fz	0,065	0,075	0,092	0,099	0,106
	5	3 x D	0,06 x D	120	–	200	fz	0,058	0,067	0,084	0,091	0,097
M	1	3 x D	0,06 x D	180	–	230	fz	0,073	0,084	0,105	0,113	0,121
	2	3 x D	0,06 x D	120	–	160	fz	0,058	0,067	0,084	0,091	0,097
	3	3 x D	0,06 x D	120	–	140	fz	0,048	0,056	0,068	0,073	0,078
S	1	3 x D	0,06 x D	100	–	180	fz	0,073	0,084	0,105	0,113	0,121
	2	3 x D	0,06 x D	50	–	80	fz	0,038	0,045	0,056	0,060	0,065
	3	3 x D	0,06 x D	120	–	160	fz	0,058	0,067	0,084	0,091	0,097
	4	3 x D	0,06 x D	100	–	120	fz	0,053	0,062	0,077	0,083	0,089
H	1	3 x D	0,06 x D	160	–	280	fz	0,065	0,075	0,092	0,099	0,106
	2	3 x D	0,06 x D	140	–	240	fz	0,048	0,056	0,068	0,073	0,078

NOTE: Lower value of cutting speed is used for high stock removal applications or for higher hardness (machinability) within group.
Higher value of cutting speed is used for finishing applications or for lower hardness (machinability) within group.
Above parameters are based on ideal conditions. For smaller taper machining centres, please adjust parameters accordingly on >12mm diameters.

■ Series 772E • VariMill III ER • Finishing • Victory Grades



Material Group	Side Milling (A)		WS15PE			Recommended feed per tooth (fz = mm/th) for side milling (A).						
	A		Cutting Speed – vc m/min			mm	D1 – Diameter					
	ap	ae	min		max		10,0	12,0	16,0	18,0	20,0	
	ap	ae	min		max	mm	10,0	12,0	16,0	18,0	20,0	
P	0	5 x D	0,05 x D	300	–	400	fz	0,086	0,099	0,121	0,130	0,137
	1	5 x D	0,05 x D	300	–	400	fz	0,086	0,099	0,121	0,130	0,137
	2	5 x D	0,05 x D	280	–	380	fz	0,086	0,099	0,121	0,130	0,137
	3	5 x D	0,05 x D	240	–	320	fz	0,073	0,084	0,105	0,113	0,121
	4	5 x D	0,05 x D	180	–	300	fz	0,065	0,075	0,092	0,099	0,106
	5	5 x D	0,05 x D	120	–	200	fz	0,058	0,067	0,084	0,091	0,097
M	1	5 x D	0,05 x D	180	–	230	fz	0,073	0,084	0,105	0,113	0,121
	2	5 x D	0,05 x D	120	–	160	fz	0,058	0,067	0,084	0,091	0,097
	3	5 x D	0,05 x D	120	–	140	fz	0,048	0,056	0,068	0,073	0,078
K	1	5 x D	0,05 x D	240	–	300	fz	0,086	0,099	0,121	0,130	0,137
	2	5 x D	0,05 x D	220	–	280	fz	0,073	0,084	0,105	0,113	0,121
	3	5 x D	0,05 x D	220	–	260	fz	0,058	0,067	0,084	0,091	0,097
S	1	5 x D	0,05 x D	100	–	180	fz	0,073	0,084	0,105	0,113	0,121
	2	5 x D	0,05 x D	50	–	80	fz	0,038	0,045	0,056	0,060	0,065
	3	5 x D	0,05 x D	120	–	160	fz	0,058	0,067	0,084	0,091	0,097
	4	5 x D	0,05 x D	100	–	120	fz	0,053	0,062	0,077	0,083	0,089
H	1	5 x D	0,05 x D	160	–	280	fz	0,065	0,075	0,092	0,099	0,106
	2	5 x D	0,06 x D	140	–	240	fz	0,048	0,056	0,068	0,073	0,078

NOTE: Lower value of cutting speed is used for high stock removal applications or for higher hardness (machinability) within group.
 Higher value of cutting speed is used for finishing applications or for lower hardness (machinability) within group.
 Above parameters are based on ideal conditions. For smaller taper machining centres, please adjust parameters accordingly on >12mm diameters.

High-Performance Solid Carbide End Mills

Putting your round tools in a position to succeed



EXTREME **CHALLENGES.**
EXTREME **RESULTS.**

Precision Collet Chuck

- Minimises runout to dramatically boost performance.
- Creates an upsurge in tool life.
- Eliminates pullout with **SAFE-LOCK®** by HAIMER option.
- Chatter-free refined balancing to G2.5@25,000 RPM.
- Extreme versatility for use with most rotating applications.

To learn more about our innovations, contact your local Authorised Distributor or visit widia.com.

WIDIA 

High-Performance Solid Carbide •
Roughers

HP ROUGHER



Special proprietary carbide substrates and state-of-the-art surface technology, combined with unique geometries, provides end users with the capability to significantly reduce machining time with heavier and deeper cuts, fewer passes, and faster surface speed. WIDIA™ geometries are uniquely formed and fine-tuned to optimise chip form, size, and evacuation generated by a given workpiece material.

- For all ferrous workpiece materials.
- Low power consumption at high speeds with long tool life.
- Provides maximum metal removal rates in both slotting and profiling operations.
- Alternative solution for productivity gains on light machines.

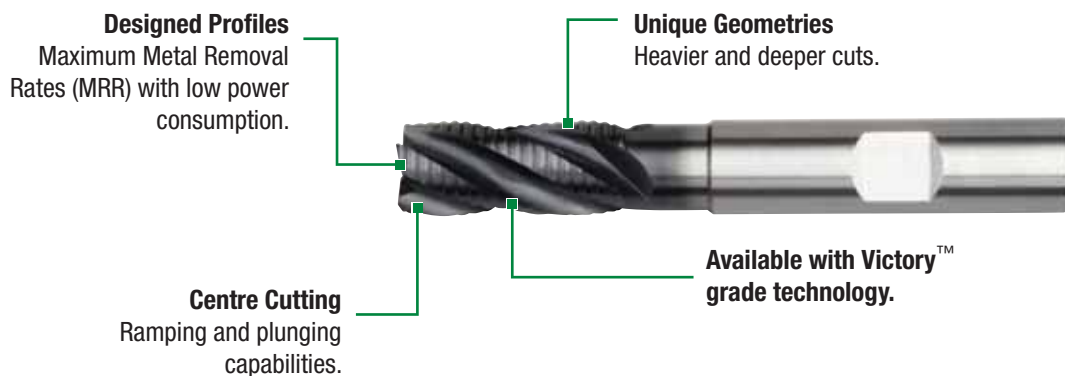

WIDIA
VICTORY

High-Performance Solid Carbide Roughers

- Reduce machine time with heavier, deeper cuts requiring fewer passes.
- Lower power consumption at higher speeds providing productivity even when horsepower may be limited.
- Maximum Metal Removal Rates (MRR) in both slotting and profiling.
- Uniquely designed profiles to optimise chip form in given workpiece materials.

DQ13 Series

- Centre Cutting.
- 3-Flute.
- 35° helix.
- Chipbreaker pitch.
- Victory™ grade.
- DIN 6527.



422824 422820 Series

- Centre cutting.
- 4-flute.
- 30° helix.
- Flat shallow pitch.



49H6 Series

- Centre cutting.
- 20° helix.
- Fine Pitch.
- Through coolant.



4U40 Series

- Centre cutting.
- 4- and 6-flutes.
- 45° helix.
- Unequal flute spacing.
- Flat shallow pitch.
- Victory™ grade.



4U70 Series

- Centre cutting.
- 4- and 6-flutes.
- 45° helix.
- Unequal flute spacing.
- Flat and shallow pitch.
- Victory™ grade.



4976 Series

- Centre cutting.
- 3-, 4-, and 5-flutes.
- 30° helix.
- Flat shallow pitch.
- Victory™ grade.



49N6 Series

- Centre cutting.
- 3- and 4-flutes.
- 30° helix.
- With neck.
- Flat and shallow pitch.



(continued)

High-Performance Solid Carbide Roughers *(continued)*

4969 Series

- Centre cutting.
- 3- and 4-flutes.
- 45° helix.
- Flat shallow pitch.
- Ball nose.



422846 022846 Series

- Centre cutting.
- 4- and 6-flutes.
- 45° helix.
- Flat shallow pitch.
- Steels and cast irons.
- DIN 6527.



422813 022813 Series

- Centre cutting.
- 3-flute.
- 30° helix.
- Flat shallow pitch.
- DIN 6527.



4906 Series

- Centre cutting.
- 4-, 5-, and 6-flutes.
- 20° helix.
- Fine pitch.
- Universal applications.



422818 022818 Series

- Centre cutting.
- 4-flute.
- 30° helix.
- Flat shallow pitch.
- Steels and cast irons.
- DIN 6527.



4966 Series

- Centre cutting.
- 3- and 4-flutes.
- 20° helix.
- Fine pitch.
- Ball nose.
- Universal applications.



Rougher Profiles

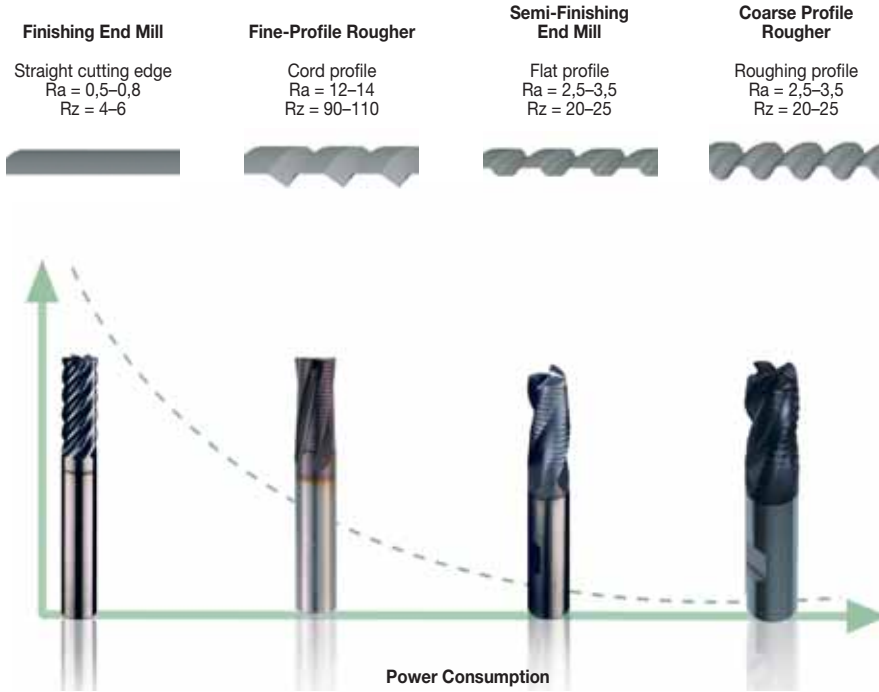

Coarse profile

For slotting, pocketing, and heavy profile cuts in ferrous materials.



Fine profile

For profile cuts and shallow slots (less than .50) in ferrous materials.



Extra-Fine profile

For profiling cuts in medium to hard steels.



Chamfered profile

For machining non-ferrous materials.



Flat shallow profile

For machining alloyed steels, stainless steels, high-temp alloys, titanium, and hard materials.



Chipbreaker profile

For roughing and semi-finishing.

- Centre cutting.
- Chipbreaker pitch.
- Standard items listed. Additional styles and coatings made-to-order.

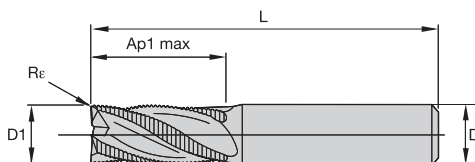

End Mill Tolerances

D1	tolerance h11 + / -	D	tolerance h6 + / -
≤ 3	0/-0,060	≤ 3	0/-0,006
> 3-6	0/-0,075	> 3-6	0/-0,008
> 6-10	0/-0,09	> 6-10	0/-0,009
> 10-18	0/-0,11	> 10-18	0/-0,011
> 18-30	0/-0,13	> 18-30	0/-0,013



Series DQ13 • Victory Grades

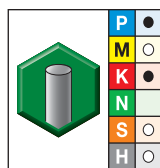

grade WP15PE
AITiN

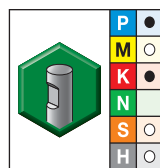

grade WP15PE
AITiN

- first choice
- alternate choice

order #	catalogue #	order #	catalogue #	D1	D	length of cut Ap1 max	length L	Re
5560534	DQ1303002T	5560536	DQ1303002W	3,0	6	7,00	54	0,25
5560535	DQ1304002T	5560537	DQ1304002W	4,0	6	8,00	57	0,25
-		5560538	DQ1305002W	5,0	6	10,00	57	0,25
-		5560539	DQ1306002W	6,0	6	10,00	57	0,45
-		5560700	DQ1307003W	7,0	8	13,00	63	0,45
-		5560701	DQ1308003W	8,0	8	16,00	63	0,45
-		5560702	DQ1310004W	10,0	10	19,00	72	0,45
-		5560703	DQ1312005W	12,0	12	22,00	83	0,45
-		5560704	DQ1314014W	14,0	14	22,00	83	0,45
-		5560705	DQ1316006W	16,0	16	32,00	92	0,45
-		5560706	DQ1318018W	18,0	18	32,00	92	0,45
-		5560707	DQ1320007W	20,0	20	38,00	104	0,45

- Centre cutting.
- Fine pitch.
- TiAlN-LW = Multilayer.
- TiAlN-RW = Monolayer.
- Standard items listed. Additional styles and coatings made-to-order.

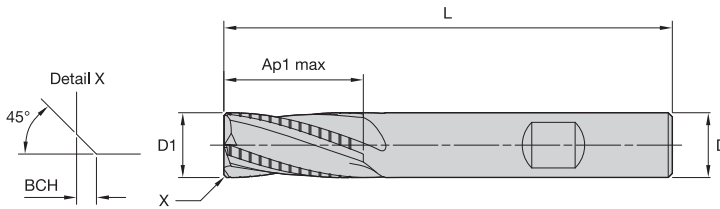

End Mill Tolerances			
D1	tolerance h11 + / -	D	tolerance h6 + / -
≤ 3	0/-0,060	≤ 3	0/-0,006
> 3-6	0/-0,075	> 3-6	0/-0,008
> 6-10	0/-0,09	> 6-10	0/-0,009
> 10-18	0/-0,11	> 10-18	0/-0,011
> 18-30	0/-0,13	> 18-30	0/-0,013

■ Series 49H6

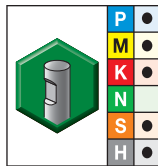

grade TiAlN-LW
TiAlN

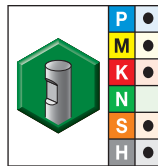

grade TiAlN-RW
TiAlN

- first choice
- alternate choice

order #	catalogue #	order #	catalogue #	D1	D	length of cut Ap1 max	length L	BCH	ZU
1657259	49H608003LW	1657260	49H608003RW	8,0	8	16,00	63	0,30	3
1657263	49H610004LW	1657264	49H610004RW	10,0	10	22,00	72	0,50	4
—	—	1657268	49H612005RW	12,0	12	26,00	83	0,50	4
1968206	49H614014LW	—	—	14,0	14	26,00	83	0,50	4
1657273	49H616006LW	1657274	49H616006RW	16,0	16	32,00	92	0,50	4
1657277	49H618018LW	1657278	49H618018RW	18,0	18	32,00	92	0,50	4
1657281	49H620007LW	1657282	49H620007RW	20,0	20	38,00	104	0,50	4

- Centre cutting.
- Flat shallow pitch.
- Standard items listed. Additional styles and coatings made-to-order.

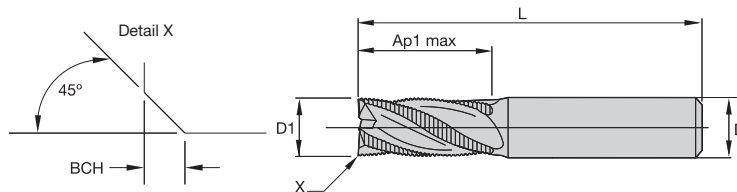
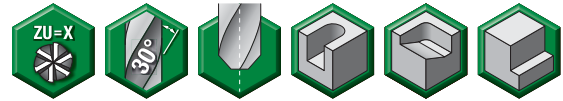

End Mill Tolerances

D1	tolerance d11	D	tolerance h6 + / -
≤ 3	-0,020/-0,080	≤ 3	0/-0,006
> 3-6	-0,030/-0,105	> 3-6	0/-0,008
> 6-10	-0,040/-0,130	> 6-10	0/-0,009
> 10-18	-0,050/-0,160	> 10-18	0/-0,011
> 18-30	-0,065/-0,195	> 18-30	0/-0,013



Series 4976 • Victory Grades

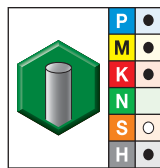

grade WP15PE
AlTiN

- first choice
- alternate choice

order #	catalogue #	D1	D	length of cut Ap1 max	length L	BCH	ZU
5560708	497604002T	4,0	6	8,00	57	0,30	3
5560709	497605002T	5,0	6	13,00	57	0,30	3
5560710	497606002T	6,0	6	13,00	57	0,30	3
5560711	497608003T	8,0	8	16,00	63	0,30	3
5560712	497610004T	10,0	10	22,00	72	0,50	4
5560713	497612005T	12,0	12	26,00	83	0,50	4
5560714	497614014T	14,0	14	26,00	83	0,50	4
5560715	497616006T	16,0	16	32,00	92	0,50	4
5560716	497618018T	18,0	18	32,00	92	0,50	4
5560717	497620007T	20,0	20	38,00	104	0,50	4
5560718	497625008T	25,0	25	45,00	121	0,50	5

High-Performance Solid Carbide End Mills

- Centre cutting.
- Flat shallow pitch.
- Standard items listed. Additional styles and coatings made-to-order.

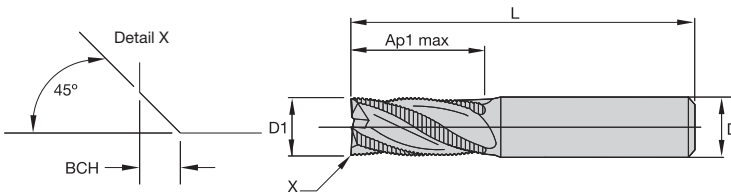

End Mill Tolerances

D1	tolerance h10 + / -	D	tolerance h6 + / -
≤ 3	0/-0,040	≤ 3	0/-0,006
> 3-6	0/-0,048	> 3-6	0/-0,008
> 6-10	0/-0,058	> 6-10	0/-0,009
> 10-18	0/-0,070	> 10-18	0/-0,011
> 18-30	0/-0,084	> 18-30	0/-0,013

■ Series 422820 422824

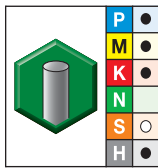

grade K30F-DCHP
TiAlN

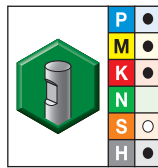

grade K30F-DCHP
TiAlN

- first choice
- alternate choice

order #	catalogue #	order #	catalogue #	D1	D	length of cut Ap1 max	length L	BCH
2628396	422820-000060	2628451	422824-000060	6,0	6	18,00	62	0,10
2628397	422820-000080	2628473	422824-000080	8,0	8	24,00	68	0,20
2628400	422820-000100	2628475	422824-000100	10,0	10	30,00	80	0,30
2628401	422820-000120	2628477	422824-000120	12,0	12	36,00	93	0,30
2628446	422820-000160	2628478	422824-000160	16,0	16	48,00	108	0,40
2628447	422820-000200	2628481	422824-000200	20,0	20	60,00	126	0,40
2628448	422820-000250	2628482	422824-000250	25,0	25	75,00	150	0,40

High-Performance Solid Carbide End Mills

- Centre cutting.
- Flat shallow pitch.
- Unequal flute spacing.
- Standard items listed. Additional styles and coatings made-to-order.

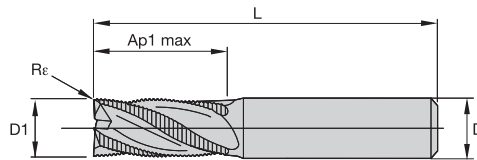
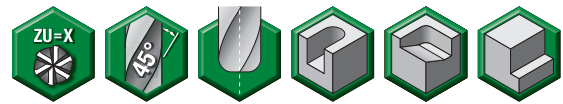

End Mill Tolerances

D1	tolerance d11	D	tolerance h6 + / -
≤ 3	-0,020/-0,080	≤ 3	0/-0,006
> 3-6	-0,030/-0,105	> 3-6	0/-0,008
> 6-10	-0,040/-0,130	> 6-10	0/-0,009
> 10-18	-0,050/-0,160	> 10-18	0/-0,011
> 18-30	-0,065/-0,195	> 18-30	0/-0,013



Series 4U40 • Victory Grades

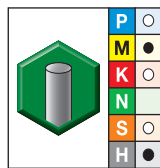

grade WP15PE
AlTiN

- first choice
- alternate choice

order #	catalogue #	D1	D	length of cut Ap1 max	length L	Rε	ZU
5583159	4U4006002T	6,0	6	6,00	57	0,75	4
5583420	4U4008003T	8,0	8	8,00	63	0,75	4
5583421	4U4010004T	10,0	10	10,00	72	0,75	4
5583422	4U4012005T	12,0	12	12,00	83	1,00	4
5583423	4U4016006T	16,0	16	16,00	92	1,00	6
5583424	4U4020007T	20,0	20	20,00	104	1,25	6
5583425	4U4025008T	25,0	25	25,00	121	1,25	6

- Centre cutting.
- Flat shallow pitch.
- Unequal flute spacing.
- Standard items listed. Additional styles and coatings made-to-order.

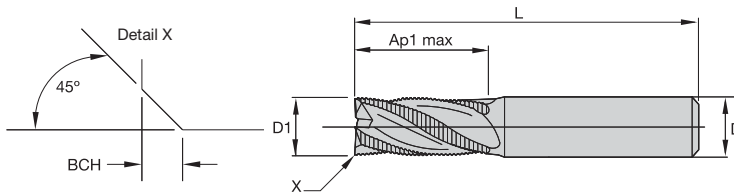

End Mill Tolerances

D1	tolerance d11	D	tolerance h6 + / -
≤ 3	-0,020/-0,080	≤ 3	0/-0,006
> 3-6	-0,030/-0,105	> 3-6	0/-0,008
> 6-10	-0,040/-0,130	> 6-10	0/-0,009
> 10-18	-0,050/-0,160	> 10-18	0/-0,011
> 18-30	-0,065/-0,195	> 18-30	0/-0,013



■ Series 4U70 • Victory Grades

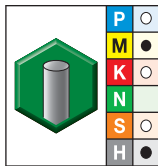

grade WP15PE
AITiN

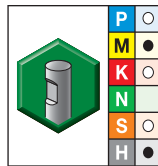

grade WP15PE
AITiN

- first choice
- alternate choice

order #	catalogue #	order #	catalogue #	D1	D	length of cut Ap1 max	length L	BCH	ZU
5583426	4U7006002T	5583436	4U7006002W	6,0	6	13,00	57	0,30	4
5583427	4U7008003T	5583437	4U7008003W	8,0	8	16,00	63	0,40	4
5583428	4U7010004T	5583438	4U7010004W	10,0	10	22,00	72	0,50	4
5583429	4U7012005T	5583439	4U7012005W	12,0	12	26,00	83	0,50	4
5583430	4U7016006T	5583440	4U7016006W	16,0	16	32,00	92	0,60	6
5583431	4U7016046T	—	—	16,0	16	32,00	92	0,60	4
5583432	4U7020007T	5583441	4U7020007W	20,0	20	38,00	104	1,00	6
5583433	4U7020047T	—	—	20,0	20	38,00	104	1,00	4
5583434	4U7025008T	5583442	4U7025008W	25,0	25	45,00	121	1,12	6
5583435	4U7025048T	—	—	25,0	25	45,00	121	1,12	4

High-Performance Solid Carbide End Mills

- Centre cutting.
- Flat shallow profile.
- Standard items listed. Additional styles and coatings made-to-order.

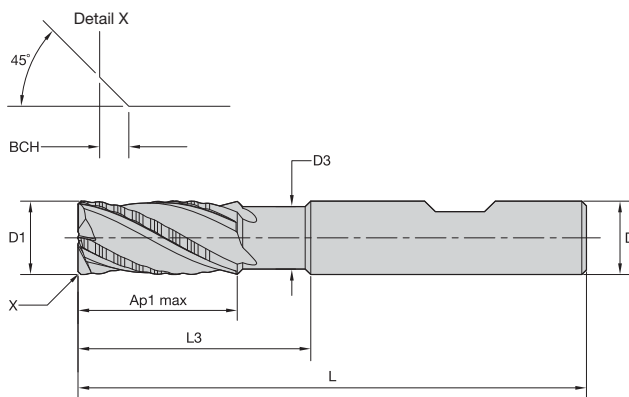
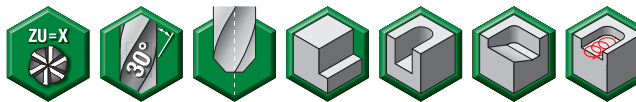

End Mill Tolerances

D1	tolerance d11	D	tolerance h6 + / -
≤ 3	-0,020/-0,080	≤ 3	0/-0,006
> 3-6	-0,030/-0,105	> 3-6	0/-0,008
> 6-10	-0,040/-0,130	> 6-10	0/-0,009
> 10-18	-0,050/-0,160	> 10-18	0/-0,011
> 18-30	-0,065/-0,195	> 18-30	0/-0,013

Series 49N6 • With Neck

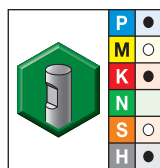

grade AlTiN-MW
AlTiN

- first choice
- alternate choice

order #	catalogue #	D1	D	D3	length of cut Ap1 max	L3	length L	BCH	ZU
3474583	49N604002MW	4,0	6	—	8,00	8,00	57	0,30	3
3474584	49N605002MW	5,0	6	—	13,00	13,00	57	0,30	3
3474585	49N606002MW	6,0	6	6	13,00	21,00	57	0,30	3
3474587	49N608003MW	8,0	8	8	16,00	27,00	63	0,30	3
3474589	49N610004MW	10,0	10	10	22,00	32,00	72	0,50	4
3474591	49N612005MW	12,0	12	11	26,00	38,00	83	0,50	4
3474593	49N614014MW	14,0	14	13	26,00	38,00	83	0,50	4
3474594	49N616006MW	16,0	16	15	32,00	44,00	92	0,50	4
3474595	49N618018MW	18,0	18	17	32,00	44,00	92	0,50	4
3474596	49N620007MW	20,0	20	19	38,00	54,00	104	0,50	4
3474597	49N625008MW	25,0	25	24	45,00	65,00	121	0,50	5

- Centre cutting.
- Flat shallow profile.
- Standard items listed. Additional styles and coatings made-to-order.
- Roughing profile also on radii portion of end mill.

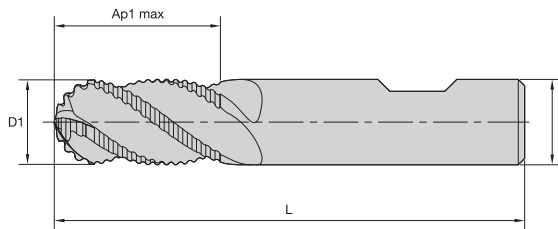

End Mill Tolerances

D1	tolerance d11	D	tolerance h6 + / -
≤ 3	-0,020/-0,080	≤ 3	0/-0,006
> 3-6	-0,030/-0,105	> 3-6	0/-0,008
> 6-10	-0,040/-0,130	> 6-10	0/-0,009
> 10-18	-0,050/-0,160	> 10-18	0/-0,011
> 18-30	-0,065/-0,195	> 18-30	0/-0,013

■ Series 4969

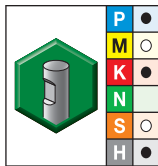

grade TiAlN-LW
TiAlN

- first choice
- alternate choice

order #	catalogue #	D1	D	length of cut Ap1 max	length L	ZU
3881115	496905002LW	5,0	6	13,00	57	3
3881116	496906002LW	6,0	6	13,00	57	3
3881117	496908003LW	8,0	8	16,00	63	4
3881118	496910004LW	10,0	10	22,00	72	4
3881119	496912005LW	12,0	12	26,00	83	4
3881120	496914014LW	14,0	14	26,00	83	4
3881121	496916006LW	16,0	16	32,00	92	4
3881122	496918018LW	18,0	18	32,00	92	4
3881123	496920007LW	20,0	20	38,00	104	4

High-Performance Solid Carbide End Mills

- Centre cutting.
- Flat shallow pitch.
- Standard items listed. Additional styles and coatings made-to-order.

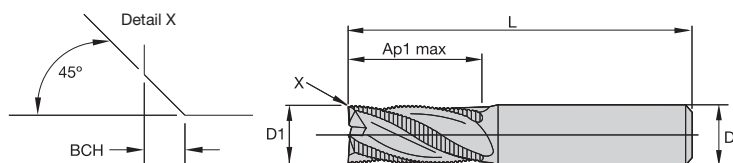

End Mill Tolerances

D1	tolerance h10 + / -	D	tolerance h6 + / -
≤ 3	0/-0,04	≤ 3	0/-0,006
> 3-6	0/-0,048	> 3-6	0/-0,008
> 6-10	0/-0,058	> 6-10	0/-0,009
> 10-18	0/-0,070	> 10-18	0/-0,011
> 18-30	0/-0,084	> 18-30	0/-0,013

Series 022813 422813

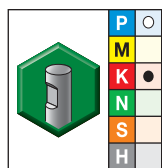

grade K30F
uncoated

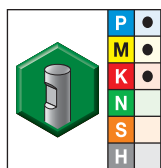

grade K30F-DCF
TiAlN

- first choice
- alternate choice

order #	catalogue #	order #	catalogue #	D1	D	length of cut Ap1 max	length L	BCH
2332360	022813-000060	2342043	422813-000060	6,0	6	10,00	57	0,10
2332361	022813-000080	2342045	422813-000080	8,0	8	16,00	63	0,20
2332362	022813-000100	2342047	422813-000100	10,0	10	19,00	72	0,30
2332363	022813-000120	2342049	422813-000120	12,0	12	22,00	83	0,30
2332364	022813-000160	2342051	422813-000160	16,0	16	26,00	92	0,40
2332365	022813-000200	2342053	422813-000200	20,0	20	32,00	104	0,40
2332366	022813-000250	2342055	422813-000250	25,0	25	45,00	121	0,40

- Centre cutting.
- Flat shallow pitch.
- Standard items listed. Additional styles and coatings made-to-order.

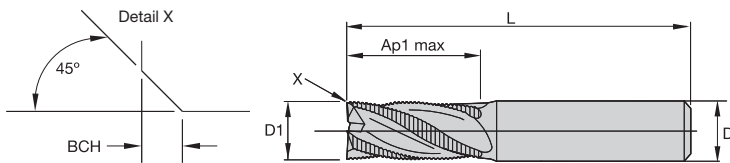

End Mill Tolerances

D1	tolerance h10 + / -	D	tolerance h6 + / -
≤ 3	0/-0,04	≤ 3	0/-0,006
> 3-6	0/-0,048	> 3-6	0/-0,008
> 6-10	0/-0,058	> 6-10	0/-0,009
> 10-18	0/-0,070	> 10-18	0/-0,011
> 18-30	0/-0,084	> 18-30	0/-0,013

■ Series 022818 422818

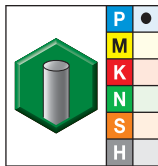

grade K30F
uncoated

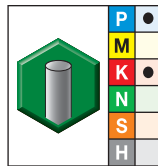

grade K30F-DCF
TiAlN

- first choice
- alternate choice

order #	catalogue #	order #	catalogue #	D1	D	length of cut Ap1 max	length L	BCH
2332420	022818-000060	2342154	422818-000060	6,0	6	13,00	57	0,10
2332421	022818-000080	2342156	422818-000080	8,0	8	19,00	63	0,20
2332422	022818-000100	2342158	422818-000100	10,0	10	22,00	72	0,30
2332423	022818-000120	2342160	422818-000120	12,0	12	26,00	83	0,30
2332425	022818-000160	2342162	422818-000160	16,0	16	32,00	92	0,40
2332427	022818-000200	2342164	422818-000200	20,0	20	38,00	104	0,40

- Centre cutting.
- Flat shallow pitch.
- Standard items listed. Additional styles and coatings made-to-order.

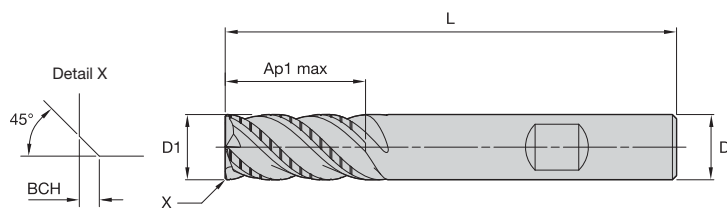

End Mill Tolerances

D1	tolerance h10 + / -	D	tolerance h6 + / -
≤ 3	0/-0,04	≤ 3	0/-0,006
> 3-6	0/-0,048	> 3-6	0/-0,008
> 6-10	0/-0,058	> 6-10	0/-0,009
> 10-18	0/-0,070	> 10-18	0/-0,011
> 18-30	0/-0,084	> 18-30	0/-0,013

Series 022846 422846

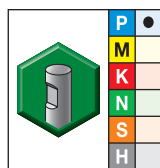

grade K30F uncoated

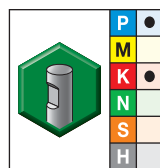

grade K30F-DCF TiAlN

- first choice
- alternate choice

order #	catalogue #	order #	catalogue #	D1	D	length of cut Ap1 max	length L	BCH	ZU
2332652	022846-000060	2342676	422846-000060	6,0	6	13,00	57	0,10	4
2332653	022846-000080	2342678	422846-000080	8,0	8	19,00	63	0,20	4
2332654	022846-000100	2342680	422846-000100	10,0	10	22,00	72	0,30	4
2332655	022846-000120	2342684	422846-000120	12,0	12	26,00	83	0,30	4
2332656	022846-000160	2342686	422846-000160	16,0	16	32,00	92	0,40	6
2332657	022846-000200	2342688	422846-000200	20,0	20	38,00	104	0,40	6
2332658	022846-000250	2342690	422846-000250	25,0	25	45,00	121	0,40	6

- Centre cutting.
- Fine pitch.
- LW = Multilayer.
- RW = Monolayer.
- Standard items listed. Additional styles and coatings made-to-order.

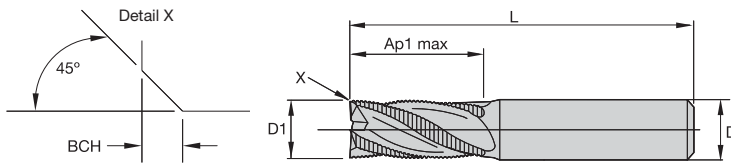
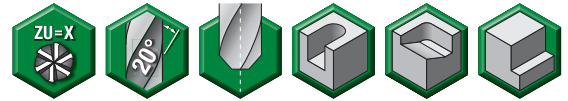

End Mill Tolerances

D1	tolerance d11	D	tolerance h6 + / -
≤ 3	-0,020/-0,080	≤ 3	0/-0,006
> 3-6	-0,030/-0,105	> 3-6	0/-0,008
> 6-10	-0,040/-0,130	> 6-10	0/-0,009
> 10-18	-0,050/-0,160	> 10-18	0/-0,011
> 18-30	-0,065/-0,195	> 18-30	0/-0,013

■ Series 4906

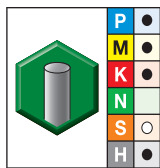

grade TiAlN-RT
TiAlN

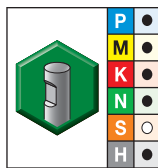

grade TiCN-CW
TiCN

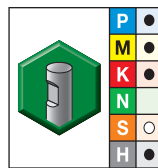

grade TiAlN-LW
TiAlN

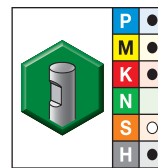

grade TiAlN-RW
TiAlN

- first choice
- alternate choice

order #	catalogue #	order #	catalogue #	order #	catalogue #	order #	catalogue #	D1	D	length of cut Ap1 max	length L	BCH	ZU
1657001	490604002RT	1656997	490604002CW	1657000	490604002LW	1657002	490604002RW	4,0	6	11,00	55	0,30	3
1657009	490605002RT	1657007	490605002CW	1657008	490605002LW	1657010	490605002RW	5,0	6	13,00	57	0,30	3
1657018	490606002RT	1657016	490606002CW	1657017	490606002LW	1657019	490606002RW	6,0	6	13,00	57	0,30	3
3133084	490607003RT	1657023	490607003CW	1657024	490607003LW	1657025	490607003RW	7,0	8	16,00	63	0,30	3
1657033	490608003RT	1657031	490608003CW	1657032	490608003LW	1657034	490608003RW	8,0	8	16,00	63	0,30	3
3133085	490609004RT	1657039	490609004CW	1657040	490609004LW	1657041	490609004RW	9,0	10	19,00	72	0,50	4
1657050	490610004RT	1657048	490610004CW	1657049	490610004LW	1657051	490610004RW	10,0	10	22,00	72	0,50	4
3133086	490611005RT	1657055	490611005CW	1968092	490611005LW	1657056	490611005RW	11,0	12	26,00	83	0,50	4
1657063	490612005RT	1657061	490612005CW	1657062	490612005LW	1657064	490612005RW	12,0	12	26,00	83	0,50	4
3133087	490613014RT	1657068	490613014CW	1968204	490613014LW	1657069	490613014RW	13,0	14	26,00	83	0,50	4
1657084	490614014RT	1570244	490614014CW	1657083	490614014LW	1657085	490614014RW	14,0	14	26,00	83	0,50	4
1657096	490616006RT	1657094	490616006CW	1657095	490616006LW	1657097	490616006RW	16,0	16	32,00	92	0,50	4
1657104	490618018RT	1657102	490618018CW	1657103	490618018LW	1657105	490618018RW	18,0	18	32,00	92	0,50	4
1657112	490620007RT	1657110	490620007CW	1657111	490620007LW	1657113	490620007RW	20,0	20	38,00	104	0,50	4
1657120	490625008RT	1657118	490625008CW	1657119	490625008LW	1657121	490625008RW	25,0	25	45,00	121	0,50	5

- Centre cutting.
- Fine pitch.
- LW = Multilayer.
- RW = Monolayer.
- Standard items listed. Additional styles and coatings made-to-order.

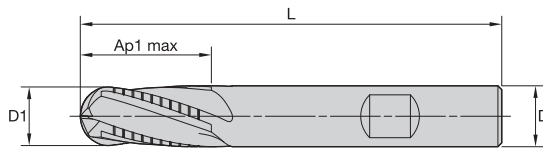

End Mill Tolerances

D1	tolerance d11	D	tolerance h6 + / -
≤ 3	-0,020/-0,080	≤ 3	0/-0,006
> 3-6	-0,030/-0,105	> 3-6	0/-0,008
> 6-10	-0,040/-0,130	> 6-10	0/-0,009
> 10-18	-0,050/-0,160	> 10-18	0/-0,011
> 18-30	-0,065/-0,195	> 18-30	0/-0,013

Series 4966

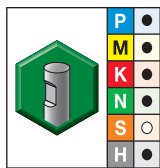

grade TiCN-CW
TiCN

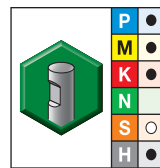

grade TiAlN-LW
TiAlN

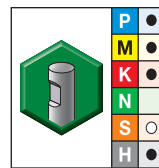



grade TiAlN-RW
TiAlN

- first choice
- alternate choice

order #	catalogue #	order #	catalogue #	order #	catalogue #	D1	D	length of cut Ap1 max	length L	ZU
1657191	496605002CW	1657192	496605002LW	1657193	496605002RW	5,0	6	13,00	57	3
1657196	496606002CW	1657197	496606002LW	1657198	496606002RW	6,0	6	13,00	57	3
1657201	496608003CW	1657202	496608003LW	1657203	496608003RW	8,0	8	16,00	63	3
1657206	496610004CW	1657207	496610004LW	1657208	496610004RW	10,0	10	22,00	72	4
1657211	496612005CW	1657212	496612005LW	1657213	496612005RW	12,0	12	26,00	83	4
	—	1657217	496614014LW	1657218	496614014RW	14,0	14	26,00	83	4
1657221	496616006CW	1657222	496616006LW	1657223	496616006RW	16,0	16	32,00	92	4
1657227	496618018CW	—	—	—	—	18,0	18	32,00	92	4
1657232	496620007CW	—	—	1657234	496620007RW	20,0	20	38,00	104	4
1657237	496625008CW	—	—	1657239	496625008RW	25,0	25	45,00	121	4

■ Series DQ13 • Victory Grades



Material Group	 																			
	Side Milling (A) and Slotting (B)			WP15PE		Recommended feed per tooth (fz = mm/th) for side milling (A). For slotting (B), reduce fz by 20%.														
	A		B	Cutting Speed – vc m/min		D1 – Diameter														
	ap	ae	ap	min	max	mm	3,0	4,0	5,0	6,0	7,0	8,0	10,0	12,0	14,0	16,0	18,0	20,0		
P	0	1 x D	0,5 x D	0,75 x D	150	–	200	fz	0,021	0,028	0,036	0,044	0,052	0,060	0,072	0,083	0,092	0,101	0,108	0,114
	1	1 x D	0,5 x D	0,75 x D	150	–	200	fz	0,021	0,028	0,036	0,044	0,052	0,060	0,072	0,083	0,092	0,101	0,108	0,114
	2	1 x D	0,5 x D	0,75 x D	140	–	190	fz	0,021	0,028	0,036	0,044	0,052	0,060	0,072	0,083	0,092	0,101	0,108	0,114
	3	1 x D	0,5 x D	0,75 x D	120	–	160	fz	0,017	0,023	0,030	0,036	0,043	0,050	0,061	0,070	0,079	0,087	0,095	0,101
	4	1 x D	0,5 x D	0,5 x D	90	–	150	fz	0,016	0,021	0,027	0,033	0,039	0,045	0,054	0,062	0,070	0,077	0,083	0,088
	5	1 x D	0,5 x D	0,75 x D	60	–	100	fz	0,014	0,019	0,024	0,029	0,035	0,040	0,048	0,056	0,063	0,070	0,076	0,081
M	1	1 x D	0,5 x D	0,75 x D	90	–	115	fz	0,017	0,023	0,030	0,036	0,043	0,050	0,061	0,070	0,079	0,087	0,095	0,101
	2	1 x D	0,4 x D	0,75 x D	60	–	80	fz	0,014	0,019	0,024	0,029	0,035	0,040	0,048	0,056	0,063	0,070	0,076	0,081
	3	1 x D	0,4 x D	0,75 x D	60	–	70	fz	0,012	0,016	0,020	0,025	0,029	0,034	0,040	0,047	0,052	0,057	0,061	0,065
K	1	1 x D	0,5 x D	0,75 x D	120	–	150	fz	0,021	0,028	0,036	0,044	0,052	0,060	0,072	0,083	0,092	0,101	0,108	0,114
	2	1 x D	0,5 x D	0,75 x D	110	–	140	fz	0,017	0,023	0,030	0,036	0,043	0,050	0,061	0,070	0,079	0,087	0,095	0,101
	3	1 x D	0,4 x D	0,75 x D	110	–	130	fz	0,014	0,019	0,024	0,029	0,035	0,040	0,048	0,056	0,063	0,070	0,076	0,081
S	1	1 x D	0,3 x D	0,4 x D	50	–	90	fz	0,017	0,023	0,030	0,036	0,043	0,050	0,061	0,070	0,079	0,087	0,095	0,101
	2	1 x D	0,3 x D	0,3 x D	25	–	40	fz	0,009	0,013	0,016	0,019	0,023	0,026	0,032	0,037	0,042	0,046	0,050	0,054
	3	1 x D	0,4 x D	0,75 x D	60	–	80	fz	0,014	0,019	0,024	0,029	0,035	0,040	0,048	0,056	0,063	0,070	0,076	0,081
	4	1 x D	0,4 x D	0,75 x D	50	–	60	fz	0,011	0,016	0,021	0,026	0,031	0,037	0,045	0,052	0,058	0,064	0,069	0,074
H	1	1 x D	0,2 x D	0,3 x D	80	–	140	fz	0,016	0,021	0,027	0,033	0,039	0,045	0,054	0,062	0,070	0,077	0,083	0,088

NOTE: Lower value of cutting speed is used for high stock removal applications or for higher hardness (machinability) within group.
Higher value of cutting speed is used for finishing applications or for lower hardness (machinability) within group.
Above parameters are based on ideal conditions. For smaller taper machining centres, please adjust parameters accordingly on >12mm diameters.

High-Performance Solid Carbide End Mills



Series 49H6

Material Group								Recommended feed per tooth (fz = mm/th) for side milling (A). For slotting (B), reduce fz by 20%.							
	Side Milling (A)		Slotting (B)	TiAlN			mm	D1 – Diameter							
	A		B	Cutting Speed – vc m/min				8,0	10,0	12,0	14,0	16,0	18,0	20,0	
	ap	ae	ap	min		max									
P	0	1,5 x D	0,5 x D	1 x D	150	–	200	fz	0,048	0,058	0,066	0,074	0,081	0,086	0,091
	1	1,5 x D	0,5 x D	1 x D	150	–	200	fz	0,048	0,058	0,066	0,074	0,081	0,086	0,091
	2	1,5 x D	0,5 x D	1 x D	140	–	190	fz	0,048	0,058	0,066	0,074	0,081	0,086	0,091
	3	1,0 x D	0,4 x D	0,75 x D	120	–	160	fz	0,040	0,048	0,056	0,063	0,070	0,076	0,081
	4	1,0 x D	0,3 x D	0,5 x D	90	–	150	fz	0,036	0,043	0,050	0,056	0,061	0,066	0,070
M	1	1,0 x D	0,4 x D	0,75 x D	90	–	115	fz	0,040	0,048	0,056	0,063	0,070	0,076	0,081
	2	1,0 x D	0,4 x D	0,75 x D	60	–	80	fz	0,032	0,039	0,045	0,051	0,056	0,060	0,065
	3	1,0 x D	0,4 x D	0,75 x D	60	–	70	fz	0,027	0,032	0,037	0,042	0,046	0,049	0,052
K	1	1,5 x D	0,5 x D	1 x D	120	–	150	fz	0,048	0,058	0,066	0,074	0,081	0,086	0,091
	2	1,5 x D	0,4 x D	1 x D	110	–	140	fz	0,040	0,048	0,056	0,063	0,070	0,076	0,081
	3	1,5 x D	0,4 x D	1 x D	110	–	130	fz	0,032	0,039	0,045	0,051	0,056	0,060	0,065
S	1	1,5 x D	0,5 x D	0,75 x D	50	–	90	fz	0,040	0,048	0,056	0,063	0,070	0,076	0,081
	3	1,5 x D	0,5 x D	0,75 x D	60	–	80	fz	0,032	0,039	0,045	0,051	0,056	0,060	0,065
H	1	1,0 x D	0,3 x D	0,5 x D	80	–	140	fz	0,036	0,043	0,050	0,056	0,061	0,066	0,070

NOTE: Lower value of cutting speed is used for high-stock removal applications or for higher hardness (machinability) within group.
 Higher value of cutting speed is used for finishing applications or for lower hardness (machinability) within group.
 Above parameters are based on ideal conditions. For smaller taper machining centres, please adjust parameters accordingly on >12mm diameters.

■ Series 4976 • Victory Grades



Material Group	 																			
	Side Milling (A) and Slotting (B)			WP15PE		Recommended feed per tooth (fz = mm/th) for side milling (A). For slotting (B), reduce fz by 20%.														
	A		B	Cutting Speed – vc m/min		D1 – Diameter														
	ap	ae	ap	min	max	mm	4,0	5,0	6,0	8,0	10,0	12,0	14,0	16,0	18,0	20,0	25,0			
P	0	1,5 x D	0,5 x D	1 x D	150	–	200	fz	0,028	0,036	0,044	0,060	0,072	0,083	0,092	0,101	0,108	0,114	0,124	
	1	1,5 x D	0,5 x D	1 x D	150	–	200	fz	0,028	0,036	0,044	0,060	0,072	0,083	0,092	0,101	0,108	0,114	0,124	
	2	1,5 x D	0,5 x D	1 x D	140	–	190	fz	0,028	0,036	0,044	0,060	0,072	0,083	0,092	0,101	0,108	0,114	0,124	
	3	1,5 x D	0,4 x D	0,75 x D	120	–	160	fz	0,023	0,030	0,036	0,050	0,061	0,070	0,079	0,087	0,095	0,101	0,114	
	4	1,5 x D	0,4 x D	0,75 x D	90	–	150	fz	0,021	0,027	0,033	0,045	0,054	0,062	0,070	0,077	0,083	0,088	0,098	
M	1	1,5 x D	0,4 x D	0,75 x D	90	–	115	fz	0,023	0,030	0,036	0,050	0,061	0,070	0,079	0,087	0,095	0,101	0,114	
	2	1,5 x D	0,4 x D	0,75 x D	60	–	80	fz	0,019	0,024	0,029	0,040	0,048	0,056	0,063	0,070	0,076	0,081	0,091	
	3	1,5 x D	0,4 x D	0,75 x D	60	–	70	fz	0,016	0,020	0,025	0,034	0,040	0,047	0,052	0,057	0,061	0,065	0,071	
K	1	1,5 x D	0,5 x D	1 x D	120	–	150	fz	0,028	0,036	0,044	0,060	0,072	0,083	0,092	0,101	0,108	0,114	0,124	
	2	1,5 x D	0,4 x D	1 x D	110	–	140	fz	0,023	0,030	0,036	0,050	0,061	0,070	0,079	0,087	0,095	0,101	0,114	
	3	1,5 x D	0,4 x D	1 x D	110	–	130	fz	0,019	0,024	0,029	0,040	0,048	0,056	0,063	0,070	0,076	0,081	0,091	
S	1	1,5 x D	0,3 x D	0,75 x D	50	–	90	fz	0,023	0,030	0,036	0,050	0,061	0,070	0,079	0,087	0,095	0,101	0,114	
	2	1,5 x D	0,3 x D	0,3 x D	25	–	40	fz	0,013	0,016	0,019	0,026	0,032	0,037	0,042	0,046	0,050	0,054	0,061	
	3	1,5 x D	0,4 x D	0,75 x D	60	–	80	fz	0,019	0,024	0,029	0,040	0,048	0,056	0,063	0,070	0,076	0,081	0,091	
	4	1,5 x D	0,3 x D	0,75 x D	50	–	60	fz	0,016	0,021	0,026	0,037	0,045	0,052	0,058	0,064	0,069	0,074	0,084	
H	1	1,5 x D	0,3 x D	0,3 x D	80	–	140	fz	0,021	0,027	0,033	0,045	0,054	0,062	0,070	0,077	0,083	0,088	0,098	

NOTE: Lower value of cutting speed is used for high stock removal applications or for higher hardness (machinability) within group.
Higher value of cutting speed is used for finishing applications or for lower hardness (machinability) within group.
Above parameters are based on ideal conditions. For smaller taper machining centres, please adjust parameters accordingly on >12mm diameters.

■ Series 422820 422824

Material Group								Recommended feed per tooth (fz = mm/th) for side milling (A). For slotting (B), reduce fz by 20%.							
	Side Milling (A) and Slotting (B)		Side Milling (A) and Slotting (B)		K30F-DCHP										
	A		B		AITiN										
	ap	ae	ap	ae	Cutting Speed – vc m/min			mm	D1 – Diameter						
				min		max		6,0	8,0	10,0	12,0	16,0	20,0	25,0	
P	1	3 x D	0,25 x D	0,7 x D	150	–	200	fz	0,032	0,043	0,052	0,063	0,077	0,087	0,095
	2	3 x D	0,25 x D	0,5 x D	140	–	190	fz	0,032	0,043	0,052	0,063	0,077	0,087	0,095
	3	3 x D	0,25 x D	0,5 x D	120	–	160	fz	0,026	0,036	0,044	0,054	0,067	0,077	0,087
	4	3 x D	0,25 x D	0,25 x D	90	–	150	fz	0,024	0,032	0,039	0,048	0,059	0,067	0,075
	5	3 x D	0,25 x D	0,25 x D	60	–	100	fz	0,021	0,029	0,035	0,043	0,053	0,062	0,070
	6	3 x D	0,25 x D	0,25 x D	50	–	75	fz	0,018	0,024	0,029	0,036	0,044	0,050	0,054
M	1	3 x D	0,25 x D	0,5 x D	80	–	100	fz	0,026	0,036	0,044	0,054	0,067	0,077	0,087
	3	3 x D	0,25 x D	0,5 x D	60	–	80	fz	0,018	0,024	0,029	0,036	0,044	0,050	0,054
K	1	3 x D	0,25 x D	0,5 x D	120	–	160	fz	0,032	0,043	0,052	0,063	0,077	0,087	0,095
	2	3 x D	0,25 x D	0,5 x D	110	–	140	fz	0,026	0,036	0,044	0,054	0,067	0,077	0,087
	3	3 x D	0,25 x D	0,5 x D	100	–	130	fz	0,021	0,029	0,035	0,043	0,053	0,062	0,070
S	1	3 x D	0,25 x D	0,5 x D	50	–	90	fz	0,026	0,036	0,044	0,054	0,067	0,077	0,087
H	1	3 x D	0,25 x D	0,5 x D	80	–	140	fz	0,024	0,032	0,039	0,048	0,059	0,067	0,075

NOTE: Lower value of cutting speed is used for high-stock removal applications or for higher hardness (machinability) within group.
 Higher value of cutting speed is used for finishing applications or for lower hardness (machinability) within group.
 Above parameters are based on ideal conditions. For smaller taper machining centres, please adjust parameters accordingly on >12mm diameters.

■ Series 4U40 • Victory Grades



Material Group																
	Side Milling (A) and Slotting (B)			WP15PE			Recommended feed per tooth (fz = mm/th) for side milling (A). For slotting (B), reduce fz by 20%.									
	A		B	Cutting Speed – vc m/min			D1 – Diameter									
	ap	ae	ap	min		max	mm	6,0	8,0	10,0	12,0	16,0	20,0	25,0		
P	3	0,8 x D	0,5 x D	0,75 x D	120	–	160	fz	0,036	0,050	0,061	0,070	0,087	0,101	0,114	
	4	0,8 x D	0,4 x D	0,5 x D	90	–	150	fz	0,033	0,045	0,054	0,062	0,077	0,088	0,098	
	5	0,8 x D	0,5 x D	0,75 x D	60	–	100	fz	0,029	0,040	0,048	0,056	0,070	0,081	0,091	
	6	0,8 x D	0,4 x D	0,5 x D	50	–	75	fz	0,025	0,034	0,040	0,047	0,057	0,065	0,071	
M	1	0,8 x D	0,5 x D	0,75 x D	90	–	115	fz	0,036	0,050	0,061	0,070	0,087	0,101	0,114	
	2	0,8 x D	0,4 x D	0,75 x D	60	–	80	fz	0,029	0,040	0,048	0,056	0,070	0,081	0,091	
	3	0,8 x D	0,4 x D	0,75 x D	60	–	70	fz	0,025	0,034	0,040	0,047	0,057	0,065	0,071	
K	1	0,8 x D	0,5 x D	0,75 x D	120	–	150	fz	0,044	0,060	0,072	0,083	0,101	0,114	0,124	
	2	0,8 x D	0,5 x D	0,75 x D	110	–	140	fz	0,036	0,050	0,061	0,070	0,087	0,101	0,114	
	3	0,8 x D	0,4 x D	0,75 x D	110	–	130	fz	0,029	0,040	0,048	0,056	0,070	0,081	0,091	
S	1	0,8 x D	0,4 x D	0,75 x D	50	–	90	fz	0,036	0,050	0,061	0,070	0,087	0,101	0,114	
	2	0,8 x D	0,25 x D	0,3 x D	25	–	40	fz	0,019	0,026	0,032	0,037	0,046	0,054	0,061	
	3	0,8 x D	0,4 x D	0,75 x D	60	–	80	fz	0,029	0,040	0,048	0,056	0,070	0,081	0,091	
	4	0,8 x D	0,3 x D	0,5 x D	50	–	60	fz	0,026	0,037	0,045	0,052	0,064	0,074	0,084	
H	1	0,8 x D	0,5 x D	0,5 x D	80	–	140	fz	0,033	0,045	0,054	0,062	0,077	0,088	0,098	
	2	0,8 x D	0,2 x D	0,3 x D	70	–	120	fz	0,025	0,034	0,040	0,047	0,057	0,065	0,071	
	3	0,8 x D	0,15 x D	0,2 x D	60	–	90	fz	0,019	0,026	0,032	0,037	0,046	0,054	0,061	

NOTE: Lower value of cutting speed is used for high stock removal applications or for higher hardness (machinability) within group.
Higher value of cutting speed is used for finishing applications or for lower hardness (machinability) within group.
For rougher tool with 6 flutes, use ap in slotting 60% of table value.
Above parameters are based on ideal conditions. For smaller taper machining centres, please adjust parameters accordingly on >12mm diameters.

High-Performance Solid Carbide End Mills

■ Series 4U70 • Victory Grades





Material Group								Recommended feed per tooth (fz = mm/th) for side milling (A). For slotting (B), reduce fz by 20%.							
	Side Milling (A) and Slotting (B)		WP15PE			Cutting Speed – vc m/min		D1 – Diameter							
	A		B		min	max	mm	6,0	8,0	10,0	12,0	16,0	20,0	25,0	
	ap	ae	ap												
P	3	1 x D	0,5 x D	0,75 x D	120	–	160	fz	0,036	0,050	0,061	0,070	0,087	0,101	0,114
	4	1 x D	0,3 x D	0,75 x D	90	–	150	fz	0,033	0,045	0,054	0,062	0,077	0,088	0,098
	5	1 x D	0,5 x D	0,75 x D	60	–	100	fz	0,029	0,040	0,048	0,056	0,070	0,081	0,091
	6	1 x D	0,3 x D	0,3 x D	50	–	75	fz	0,025	0,034	0,040	0,047	0,057	0,065	0,071
M	1	1 x D	0,5 x D	0,75 x D	90	–	115	fz	0,036	0,050	0,061	0,070	0,087	0,101	0,114
	2	1 x D	0,5 x D	0,75 x D	60	–	80	fz	0,029	0,040	0,048	0,056	0,070	0,081	0,091
	3	1 x D	0,5 x D	0,75 x D	60	–	70	fz	0,025	0,034	0,040	0,047	0,057	0,065	0,071
K	1	1 x D	0,5 x D	1 x D	120	–	150	fz	0,044	0,060	0,072	0,083	0,101	0,114	0,124
	2	1 x D	0,5 x D	1 x D	110	–	140	fz	0,036	0,050	0,061	0,070	0,087	0,101	0,114
	3	1 x D	0,5 x D	1 x D	110	–	130	fz	0,029	0,040	0,048	0,056	0,070	0,081	0,091
S	1	1 x D	0,3 x D	0,75 x D	50	–	90	fz	0,036	0,050	0,061	0,070	0,087	0,101	0,114
	2	1 x D	0,3 x D	0,3 x D	25	–	40	fz	0,019	0,026	0,032	0,037	0,046	0,054	0,061
	3	1 x D	0,4 x D	0,75 x D	60	–	80	fz	0,029	0,040	0,048	0,056	0,070	0,081	0,091
	4	1 x D	0,4 x D	0,75 x D	50	–	60	fz	0,026	0,037	0,045	0,052	0,064	0,074	0,084
H	1	1 x D	0,3 x D	0,3 x D	80	–	140	fz	0,033	0,045	0,054	0,062	0,077	0,088	0,098
	2	1 x D	0,2 x D	0,2 x D	70	–	120	fz	0,025	0,034	0,040	0,047	0,057	0,065	0,071
	3	1 x D	0,2 x D	0,2 x D	60	–	90	fz	0,019	0,026	0,032	0,037	0,046	0,054	0,061

NOTE: Lower value of cutting speed is used for high stock removal applications or for higher hardness (machinability) within group.
Higher value of cutting speed is used for finishing applications or for lower hardness (machinability) within group.
For rougher tool with 6 flutes, use ap in slotting 60% of table value.
Above parameters are based on ideal conditions. For smaller taper machining centres, please adjust parameters accordingly on >12mm diameters.

High-Performance Solid Carbide End Mills

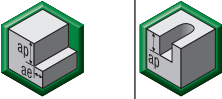
■ Series 49N6

Material Group																				
		Side Milling (A) and Slotting (B)			AITiN		Recommended feed per tooth (fz = mm/th) for side milling (A). For slotting (B), reduce fz by 20%.													
		A		B	Cutting Speed – vc m/min		D1 – Diameter													
		ap	ae	ap	min	max	mm	4,0	5,0	6,0	8,0	10,0	12,0	14,0	16,0	18,0	20,0	25,0		
P	0	1,5 x D	0,5 x D	1 x D	150	–	200	fz	0,024	0,031	0,037	0,051	0,061	0,070	0,079	0,086	0,092	0,097	0,105	
	1	1,5 x D	0,5 x D	1 x D	150	–	200	fz	0,024	0,031	0,037	0,051	0,061	0,070	0,079	0,086	0,092	0,097	0,105	
	2	1,5 x D	0,5 x D	1 x D	140	–	190	fz	0,024	0,031	0,037	0,051	0,061	0,070	0,079	0,086	0,092	0,097	0,105	
	3	1,5 x D	0,4 x D	0,75 x D	120	–	160	fz	0,020	0,025	0,031	0,043	0,051	0,060	0,067	0,074	0,080	0,086	0,097	
	4	1,5 x D	0,3 x D	0,5 x D	90	–	150	fz	0,018	0,023	0,028	0,038	0,046	0,053	0,060	0,065	0,070	0,075	0,083	
M	5	1,5 x D	0,4 x D	0,75 x D	60	–	100	fz	0,016	0,021	0,025	0,034	0,041	0,048	0,054	0,059	0,064	0,069	0,077	
	1	1,5 x D	0,4 x D	0,75 x D	80	–	100	fz	0,020	0,025	0,031	0,043	0,051	0,060	0,067	0,074	0,080	0,086	0,097	
	2	1,5 x D	0,4 x D	0,75 x D	60	–	80	fz	0,016	0,021	0,025	0,034	0,041	0,048	0,054	0,059	0,064	0,069	0,077	
K	3	1,5 x D	0,4 x D	0,75 x D	60	–	80	fz	0,014	0,017	0,021	0,029	0,034	0,040	0,044	0,048	0,052	0,055	0,060	
	1	1,5 x D	0,5 x D	1 x D	120	–	160	fz	0,024	0,031	0,037	0,051	0,061	0,070	0,079	0,086	0,092	0,097	0,105	
	2	1,5 x D	0,4 x D	1 x D	110	–	140	fz	0,020	0,025	0,031	0,043	0,051	0,060	0,067	0,074	0,080	0,086	0,097	
S	3	1,5 x D	0,4 x D	1 x D	100	–	130	fz	0,016	0,021	0,025	0,034	0,041	0,048	0,054	0,059	0,064	0,069	0,077	
	1	1,5 x D	0,4 x D	0,75 x D	50	–	90	fz	0,020	0,025	0,031	0,043	0,051	0,060	0,067	0,074	0,080	0,086	0,097	
H	3	1,5 x D	0,4 x D	0,75 x D	60	–	80	fz	0,016	0,021	0,025	0,034	0,041	0,048	0,054	0,059	0,064	0,069	0,077	
H	1	1,5 x D	0,3 x D	0,3 x D	80	–	140	fz	0,018	0,023	0,028	0,038	0,046	0,053	0,060	0,065	0,070	0,075	0,083	

NOTE: Lower value of cutting speed is used for high stock removal applications or for higher hardness (machinability) within group.
Higher value of cutting speed is used for finishing applications or for lower hardness (machinability) within group.
Above parameters are based on ideal conditions. For smaller taper machining centres, please adjust parameters accordingly on >12mm diameters.

■ Series 4969

Material Group									Side Milling (A) and Slotting (B)									
		Side Milling (A) and Slotting (B)		TiAlN			Recommended feed per tooth (fz = mm/th) for side milling (A). For slotting (B), reduce fz by 20%.											
		A		B	Cutting Speed – vc m/min			D1 – Diameter										
		ap	ae	ap	min	–	max	mm	5,0	6,0	8,0	10,0	12,0	14,0	16,0	18,0	20,0	25,0
P	0	1,5 x D	0,5 x D	1 x D	150	–	200	fz	0,036	0,044	0,060	0,072	0,083	0,092	0,101	0,107	0,114	0,124
	1	1,5 x D	0,5 x D	1 x D	150	–	200	fz	0,036	0,044	0,060	0,072	0,083	0,092	0,101	0,107	0,114	0,124
	2	1,5 x D	0,5 x D	1 x D	140	–	190	fz	0,036	0,044	0,060	0,072	0,083	0,092	0,101	0,107	0,114	0,124
	3	1,5 x D	0,4 x D	0,75 x D	120	–	160	fz	0,030	0,036	0,050	0,061	0,070	0,079	0,087	0,094	0,101	0,114
	4	1,5 x D	0,3 x D	0,3 x D	90	–	150	fz	0,027	0,033	0,045	0,054	0,062	0,070	0,077	0,082	0,088	0,098
	5	1,5 x D	0,4 x D	0,75 x D	60	–	100	fz	0,024	0,029	0,040	0,048	0,056	0,063	0,070	0,075	0,081	0,091
M	6	1,5 x D	0,3 x D	0,3 x D	50	–	75	fz	0,020	0,025	0,034	0,040	0,047	0,052	0,057	0,061	0,065	0,071
	1	1,5 x D	0,4 x D	0,75 x D	80	–	100	fz	0,030	0,036	0,050	0,061	0,070	0,079	0,087	0,094	0,101	0,114
	2	1,5 x D	0,4 x D	0,75 x D	60	–	80	fz	0,024	0,029	0,040	0,048	0,056	0,063	0,070	0,075	0,081	0,091
K	3	1,5 x D	0,4 x D	0,75 x D	60	–	80	fz	0,020	0,025	0,034	0,040	0,047	0,052	0,057	0,061	0,065	0,071
	1	1,5 x D	0,5 x D	1 x D	120	–	160	fz	0,036	0,044	0,060	0,072	0,083	0,092	0,101	0,107	0,114	0,124
	2	1,5 x D	0,4 x D	1 x D	110	–	140	fz	0,030	0,036	0,050	0,061	0,070	0,079	0,087	0,094	0,101	0,114
S	3	1,5 x D	0,4 x D	1 x D	100	–	130	fz	0,024	0,029	0,040	0,048	0,056	0,063	0,070	0,075	0,081	0,091
	1	1,5 x D	0,4 x D	0,75 x D	50	–	90	fz	0,030	0,036	0,050	0,061	0,070	0,079	0,087	0,094	0,101	0,114
	2	1,5 x D	0,3 x D	0,3 x D	25	–	40	fz	0,016	0,019	0,026	0,032	0,037	0,042	0,046	0,050	0,054	0,061
	3	1,5 x D	0,4 x D	0,75 x D	60	–	80	fz	0,024	0,029	0,040	0,048	0,056	0,063	0,070	0,075	0,081	0,091
H	4	1,5 x D	0,3 x D	0,75 x D	50	–	60	fz	0,021	0,026	0,037	0,045	0,052	0,058	0,064	0,069	0,074	0,084
	1	1,5 x D	0,3 x D	0,3 x D	80	–	140	fz	0,027	0,033	0,045	0,054	0,062	0,070	0,077	0,082	0,088	0,098
	2	1,5 x D	0,2 x D	0,2 x D	70	–	120	fz	0,020	0,025	0,034	0,040	0,047	0,052	0,057	0,061	0,065	0,071
	3	1,5 x D	0,2 x D	0,2 x D	60	–	90	fz	0,016	0,019	0,026	0,032	0,037	0,042	0,046	0,050	0,054	0,061

NOTE: Lower value of cutting speed is used for high stock removal applications or for higher hardness (machinability) within group.
 Higher value of cutting speed is used for finishing applications or for lower hardness (machinability) within group.
 Above parameters are based on ideal conditions. For smaller taper machining centres, please adjust parameters accordingly on >12mm diameters.

High-Performance Solid Carbide End Mills

■ Series 022813 422813

Material Group	Side Milling (A) and Slotting (B)			K30F			K30F-DCF			Recommended feed per tooth (fz = mm/th) for side milling (A). For slotting (B), reduce fz by 20%.								
	A		B	Uncoated			TiAlN			mm	D1 – Diameter							
	ap	ae	ap	Cutting Speed – vc m/min			Cutting Speed – vc m/min				6,0	8,0	10,0	12,0	16,0	20,0	25,0	
	min	max	min	max	min	max	min	max	fz	fz	fz	fz	fz	fz	fz	fz		
P	1	1 x D	0,5 x D	1 x D	60	–	80	150	–	200	fz	0,032	0,043	0,052	0,063	0,077	0,087	0,097
	2	1 x D	0,5 x D	1 x D	56	–	76	140	–	190	fz	0,032	0,043	0,052	0,063	0,077	0,087	0,097
	3	1 x D	0,5 x D	1 x D	–	–	–	120	–	160	fz	0,026	0,036	0,044	0,054	0,067	0,077	0,088
	4	1 x D	0,4 x D	1 x D	–	–	–	90	–	150	fz	0,024	0,032	0,039	0,048	0,059	0,067	0,076
M	1	1 x D	0,4 x D	0,75 x D	–	–	–	80	–	100	fz	0,026	0,036	0,044	0,054	0,067	0,077	0,088
	2	1 x D	0,4 x D	0,5 x D	–	–	–	60	–	80	fz	0,018	0,024	0,029	0,036	0,044	0,050	0,056
K	1	1 x D	0,5 x D	1 x D	48	–	64	120	–	160	fz	0,032	0,043	0,052	0,063	0,077	0,087	0,097
	2	1 x D	0,4 x D	1 x D	44	–	56	110	–	140	fz	0,026	0,036	0,044	0,054	0,067	0,077	0,088
	3	1 x D	0,4 x D	1 x D	40	–	52	100	–	130	fz	0,021	0,029	0,035	0,043	0,053	0,062	0,070



NOTE: Lower value of cutting speed is used for high stock removal applications or for higher hardness (machinability) within group.
Higher value of cutting speed is used for finishing applications or for lower hardness (machinability) within group.
Above parameters are based on ideal conditions. For smaller taper machining centres, please adjust parameters accordingly on >12mm diameters.

■ Series 022818 422818

Material Group																				
		Side Milling (A) and Slotting (B)			K30F			K30F-DCF			Recommended feed per tooth (fz = mm/th) for side milling (A). For slotting (B), reduce fz by 20%.									
		A		B	Uncoated			TiAlN			D1 – Diameter									
		ap	ae	ap	Cutting Speed – vc m/min			Cutting Speed – vc m/min			mm	6,0	8,0	10,0	12,0	16,0	20,0			
P	1	1,5 x D	0,5 x D	1 x D	60	–	80	150	–	200	fz	0,033	0,041	0,049	0,060	0,073	0,082			
	2	1,5 x D	0,5 x D	1 x D	56	–	76	140	–	190	fz	0,033	0,041	0,049	0,060	0,073	0,082			
	3	1,5 x D	0,4 x D	1 x D	–	–	–	120	–	160	fz	0,027	0,034	0,041	0,051	0,063	0,073			
	4	1,5 x D	0,4 x D	0,75 x D	–	–	–	90	–	150	fz	0,024	0,030	0,037	0,045	0,055	0,063			
K	1	1,5 x D	0,5 x D	1 x D	–	–	–	120	–	160	fz	0,033	0,041	0,049	0,060	0,073	0,082			
	2	1,5 x D	0,4 x D	1 x D	–	–	–	110	–	140	fz	0,027	0,034	0,041	0,051	0,063	0,073			
	3	1,5 x D	0,4 x D	1 x D	–	–	–	100	–	130	fz	0,021	0,027	0,033	0,040	0,050	0,058			

NOTE: Lower value of cutting speed is used for high stock removal applications or for higher hardness (machinability) within group.
 Higher value of cutting speed is used for finishing applications or for lower hardness (machinability) within group.
 Above parameters are based on ideal conditions. For smaller taper machining centres, please adjust parameters accordingly on >12mm diameters.

■ Series 022846 422846

Material Group	 																	
	Side Milling (A) and Slotting (B)			K30F			K30F-DCF			Recommended feed per tooth (fz = mm/th) for side milling (A). For slotting (B), reduce fz by 20%.								
	A		B	Uncoated			TiAlN			D1 – Diameter								
	ap	ae	ap	Cutting Speed – vc m/min			Cutting Speed – vc m/min			mm	6,0	8,0	10,0	12,0	16,0	20,0	25,0	
P	0	1,5 x D	0,5 x D	1 x D	60	–	80	150	–	200	fz	0,033	0,045	0,054	0,062	0,076	0,086	0,093
	1	1,5 x D	0,5 x D	1 x D	60	–	80	150	–	200	fz	0,033	0,045	0,054	0,062	0,076	0,086	0,093
	2	1,5 x D	0,5 x D	1 x D	56	–	76	140	–	190	fz	0,033	0,045	0,054	0,062	0,076	0,086	0,093
	3	1,5 x D	0,4 x D	1 x D	–	–	–	120	–	160	fz	0,027	0,038	0,045	0,053	0,065	0,076	0,085
	4	1,5 x D	0,4 x D	0,75 x D	–	–	–	90	–	150	fz	0,025	0,034	0,041	0,047	0,058	0,066	0,073
K	1	1,5 x D	0,5 x D	1 x D	–	–	–	120	–	150	fz	0,033	0,045	0,054	0,062	0,076	0,086	0,093
	2	1,5 x D	0,4 x D	1 x D	–	–	–	110	–	140	fz	0,027	0,038	0,045	0,053	0,065	0,076	0,085
	3	1,5 x D	0,4 x D	1 x D	–	–	–	110	–	130	fz	0,022	0,030	0,036	0,042	0,052	0,061	0,068

NOTE: Lower value of cutting speed is used for high stock removal applications or for higher hardness (machinability) within group.
Higher value of cutting speed is used for finishing applications or for lower hardness (machinability) within group.
Above parameters are based on ideal conditions. For smaller taper machining centres, please adjust parameters accordingly on >12mm diameters.

■ Series 4906

Material Group																						
	Side Milling (A) and Slotting (B)			TiCN		TiAlN		Recommended feed per tooth (fz = mm/th) for side milling (A). For slotting (B), reduce fz by 20%.														
	A		B	Cutting Speed – vc m/min		Cutting Speed – vc m/min		D1 – Diameter														
	ap	ae	ap	min	max	min	max	mm	4,0	5,0	6,0	8,0	10,0	12,0	14,0	16,0	18,0	20,0	25,0			
P	0	1,5 x D	0,5 x D	1 x D	120	–	160	150	–	200	fz	0,024	0,031	0,037	0,051	0,061	0,070	0,079	0,086	0,092	0,097	0,105
	1	1,5 x D	0,5 x D	1 x D	120	–	160	150	–	200	fz	0,024	0,031	0,037	0,051	0,061	0,070	0,079	0,086	0,092	0,097	0,105
	2	1,5 x D	0,5 x D	1 x D	112	–	152	140	–	190	fz	0,024	0,031	0,037	0,051	0,061	0,070	0,079	0,086	0,092	0,097	0,105
	3	1,5 x D	0,4 x D	0,75 x D	96	–	128	120	–	160	fz	0,020	0,025	0,031	0,043	0,051	0,060	0,067	0,074	0,080	0,086	0,097
	4	1,5 x D	0,3 x D	0,3 x D	72	–	120	90	–	150	fz	0,018	0,023	0,028	0,038	0,046	0,053	0,060	0,065	0,070	0,075	0,083
M	5	1,5 x D	0,4 x D	0,75 x D	48	–	80	60	–	100	fz	0,016	0,021	0,025	0,034	0,041	0,048	0,054	0,059	0,064	0,069	0,077
	1	1,5 x D	0,4 x D	0,75 x D	72	–	92	90	–	115	fz	0,020	0,025	0,031	0,043	0,051	0,060	0,067	0,074	0,080	0,086	0,097
	2	1,5 x D	0,4 x D	0,75 x D	48	–	64	60	–	80	fz	0,016	0,021	0,025	0,034	0,041	0,048	0,054	0,059	0,064	0,069	0,077
K	3	1,5 x D	0,4 x D	0,75 x D	48	–	56	60	–	70	fz	0,014	0,017	0,021	0,029	0,034	0,040	0,044	0,048	0,052	0,055	0,060
	1	1,5 x D	0,5 x D	1 x D	96	–	120	120	–	150	fz	0,024	0,031	0,037	0,051	0,061	0,070	0,079	0,086	0,092	0,097	0,105
	2	1,5 x D	0,4 x D	1 x D	88	–	112	110	–	140	fz	0,020	0,025	0,031	0,043	0,051	0,060	0,067	0,074	0,080	0,086	0,097
S	3	1,5 x D	0,4 x D	1 x D	88	–	104	110	–	130	fz	0,016	0,021	0,025	0,034	0,041	0,048	0,054	0,059	0,064	0,069	0,077
	1	1,5 x D	0,4 x D	0,75 x D	40	–	72	50	–	90	fz	0,020	0,025	0,031	0,043	0,051	0,060	0,067	0,074	0,080	0,086	0,097
H	3	1,5 x D	0,3 x D	0,3 x D	48	–	64	60	–	80	fz	0,016	0,021	0,025	0,034	0,041	0,048	0,054	0,059	0,064	0,069	0,077
	1	1,5 x D	0,3 x D	0,3 x D	64	–	112	80	–	140	fz	0,018	0,023	0,028	0,038	0,046	0,053	0,060	0,065	0,070	0,075	0,083

NOTE: Lower value of cutting speed is used for high stock removal applications or for higher hardness (machinability) within group.
 Higher value of cutting speed is used for finishing applications or for lower hardness (machinability) within group.
 Above parameters are based on ideal conditions. For smaller taper machining centres, please adjust parameters accordingly on >12mm diameters.

■ Series 4966

Material Group	Side Milling (A) and Slotting (B)			TICN		TiAlN		Recommended feed per tooth (fz = mm/th) for side milling (A). For slotting (B), reduce fz by 20%.												
	A		B	Cutting Speed – vc m/min		Cutting Speed – vc m/min		mm	D1 – Diameter											
	ap	ae	ap	min	max	min	max		5,0	6,0	8,0	10,0	12,0	16,0	18,0	20,0	25,0			
								fz												
P	0	1,5 x D	0,5 x D	1 x D	120	–	160	150	–	200	fz	0,030	0,036	0,049	0,059	0,068	0,083	0,089	0,093	0,101
	1	1,5 x D	0,5 x D	1 x D	120	–	160	150	–	200	fz	0,030	0,036	0,049	0,059	0,068	0,083	0,089	0,093	0,101
	2	1,5 x D	0,5 x D	1 x D	112	–	152	140	–	190	fz	0,030	0,036	0,049	0,059	0,068	0,083	0,089	0,093	0,101
	3	1,5 x D	0,4 x D	0,75 x D	96	–	128	120	–	160	fz	0,024	0,030	0,041	0,050	0,058	0,072	0,077	0,083	0,093
	4	1,5 x D	0,3 x D	0,5 x D	72	–	120	90	–	150	fz	0,022	0,027	0,037	0,044	0,051	0,063	0,068	0,072	0,080
M	1	1,5 x D	0,4 x D	0,75 x D	72	–	92	90	–	115	fz	0,024	0,030	0,041	0,050	0,058	0,072	0,077	0,083	0,093
	2	1,5 x D	0,4 x D	0,75 x D	48	–	64	60	–	80	fz	0,020	0,024	0,033	0,040	0,046	0,057	0,062	0,066	0,075
	3	1,5 x D	0,4 x D	0,75 x D	48	–	56	60	–	70	fz	0,017	0,020	0,028	0,033	0,038	0,047	0,050	0,053	0,058
K	1	1,5 x D	0,5 x D	1 x D	96	–	120	120	–	150	fz	0,030	0,036	0,049	0,059	0,068	0,083	0,089	0,093	0,101
	2	1,5 x D	0,4 x D	1 x D	88	–	112	110	–	140	fz	0,024	0,030	0,041	0,050	0,058	0,072	0,077	0,083	0,093
	3	1,5 x D	0,4 x D	1 x D	88	–	104	110	–	130	fz	0,020	0,024	0,033	0,040	0,046	0,057	0,062	0,066	0,075
S	1	1,5 x D	0,4 x D	0,75 x D	40	–	72	50	–	90	fz	0,024	0,030	0,041	0,050	0,058	0,072	0,077	0,083	0,093
	3	1,5 x D	0,4 x D	0,75 x D	48	–	64	60	–	80	fz	0,020	0,024	0,033	0,040	0,046	0,057	0,062	0,066	0,075
H	1	1,5 x D	0,3 x D	0,5 x D	64	–	112	80	–	140	fz	0,022	0,027	0,037	0,044	0,051	0,063	0,068	0,072	0,080

NOTE: Lower value of cutting speed is used for high stock removal applications or for higher hardness (machinability) within group.
Higher value of cutting speed is used for finishing applications or for lower hardness (machinability) within group.
Above parameters are based on ideal conditions. For smaller taper machining centres, please adjust parameters accordingly on >12mm diameters.

High-Performance Finishing Solid Carbide End Mills

HP Finishers



Only the finest carbide substrates with market-leading geometries and state-of-the-art surface technology are used to ensure the very best quality finishing end mills are produced. These tools are fully compliant with NAS, DIN, and JIS specifications. Whether you require higher metal removal rates, improved surface finishes, fewer passes, or longer tool life, WIDIA-Hanita™ high-performance finishing end mills deliver the reliability and consistency you can depend on during your critical finishing operations.

- Specific geometries targeted for steels, stainless steels, high-temperature alloys, and titanium.
- Stub, regular, long, and extra long lengths for all applications.
- Special designs with higher number of flutes and increased helix angles for super finishing applications.
- Latest coating technology, including Victory™ grades.

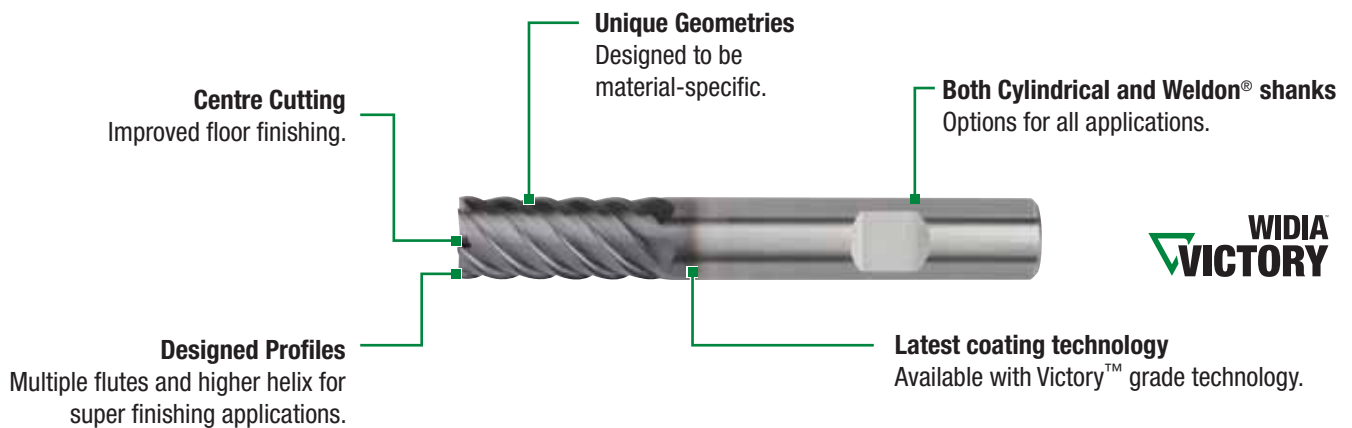

WIDIA
VICTORY

High-Performance Solid Carbide Finishing

- Specifically designed geometries for finishing in a wide range of materials.
- Higher number of flutes and higher helix angles for super finishing applications.
- High Metal Removal Rates (MRR) requiring fewer passes and longer tool life while providing superior surface finishes.

4001 JJ Series

- Centre cutting.
- 2-flute.
- 30° helix.
- Ball nose.
- JIS.
- Victory™ grade WP15PE™.



D503 D513 Series

- Centre cutting.
- 3-flute.
- 45° helix.
- DIN 6527.



DC03 Series

- Centre cutting.
- 3-flute.
- 35° helix.
- Corner radius.
- DIN 6527.



4503 JJ Series

- Centre cutting.
- 3-flute.
- 45° helix.
- JIS.
- Victory grade WP15PE.



422802/322802/022802 Series

- Centre cutting.
- 3-flute.
- 45° helix.
- Chamfered corner.
- DIN 6527.
- Universal application.



4603 Series

- Centre cutting.
- 3-flute.
- 60° helix.
- Light finishing.



D507 D517 Series

- Centre cutting.
- 6-flute.
- 45° helix.
- DIN 6527.
- Light finishing.



422826 422822 Series

- Non-centre cutting.
- 6- and 8-flutes.
- 45° helix.
- DIN 6527.
- Light finishing.



422827 Series

- Non-centre cutting.
- 6- and 8-flutes.
- 45° helix.
- Chamfered corner.



D518 Series

- Centre cutting.
- 4-, 6-, and 8-flutes.
- 50° helix.
- DIN 6527.
- Super finishing applications.



026621 Series

- Non-centre cutting.
- 4-, 6-, and 8-flutes.
- 45° helix.
- Chamfer corner.
- DIN 6527.
- Finishing of steels and cast irons.
- Cermet construction.



024112 Series

- Centre cutting.
- 2-flute.
- 20° helix.
- Tours style.
- Diamond coating.
- Non-ferrous applications.



024111 Series

- Centre cutting.
- 2-flute.
- 20° helix.
- Ball nose.
- Diamond coating.
- Non-ferrous applications.



- Centre cutting.
- Standard items listed. Additional styles and coatings made-to-order.

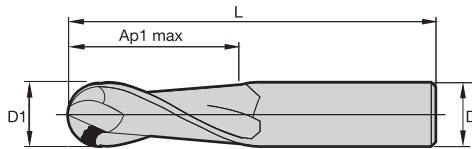

End Mill Tolerances

D1	tolerance e8	D	tolerance h6 + / -
≤ 3	-0,014/-0,028	≤ 3	0/-0,006
> 3-6	-0,020/-0,038	> 3-6	0/-0,008
> 6-10	-0,025/-0,047	> 6-10	0/-0,009
> 10-18	-0,032/-0,059	> 10-18	0/-0,011
> 18-30	-0,040/-0,073	> 18-30	0/-0,013



Series 4001 JJ • Victory Grades

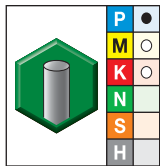

grade WP15PE
AlTiN

- first choice
- alternate choice

order #	catalogue #	D1	D	D3	length of cut Ap1 max	L3	length L
5559146	400101001T	1,0	4	—	3,00	3	50
5559147	400101501T	1,5	4	—	3,00	3	50
5559148	400102001T	2,0	4	—	3,00	3	50
5559149	400103002T	3,0	6	—	9,50	10	58
5559160	400104002T	4,0	6	—	12,00	12	76
5559161	400105002T	5,0	6	—	14,00	14	76
5559162	400106002T	6,0	6	5,6	16,00	40	100
5559163	400108003T	8,0	8	7,5	20,00	40	100
5559164	400110004T	10,0	10	9,4	22,00	35	100
5559165	400112005T	12,0	12	11,3	25,00	50	125
5559166	400114005T	14,0	14	13,2	32,00	57	125
5559167	400116006T	16,0	16	15,0	32,00	60	150
5559168	400118006T	18,0	18	16,9	38,00	60	150
5559169	400120007T	20,0	20	18,8	38,00	60	150

- Centre cutting.
- Standard items listed. Additional styles and coatings made-to-order.

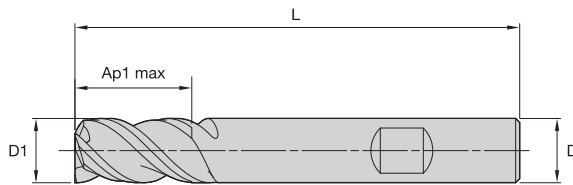

End Mill Tolerances

D1	tolerance e8	D	tolerance h6 + / -
≤ 3	-0,014/-0,028	≤ 3	0/-0,006
> 3-6	-0,020/-0,038	> 3-6	0/-0,008
> 6-10	-0,025/-0,047	> 6-10	0/-0,009
> 10-18	-0,032/-0,059	> 10-18	0/-0,011
> 18-30	-0,040/-0,073	> 18-30	0/-0,013

■ Series D503 D513

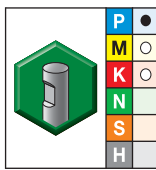

grade UNCOATED-WW

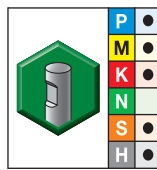

grade TiCN-CW TiCN

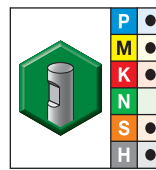

grade TiAlN-RW TiAlN

- first choice
- alternate choice

order #	catalogue #	order #	catalogue #	order #	catalogue #	D1	D	length of cut Ap1 max	length L
1661576	D50302002WW	1661573	D50302002CW	1661574	D50302002RW	2,0	6	3,00	50
1661580	D50303002WW	1661577	D50303002CW	1661578	D50303002RW	3,0	6	4,00	50
1661682	D51303002WW	—	—	1661680	D51303002RW	3,0	6	7,00	57
1661585	D50304002WW	1661582	D50304002CW	1661583	D50304002RW	4,0	6	5,00	54
1661686	D51304002WW	—	—	1661684	D51304002RW	4,0	6	8,00	57
1661590	D50305002WW	1661587	D50305002CW	1661588	D50305002RW	5,0	6	6,00	54
1661690	D51305002WW	—	—	1661688	D51305002RW	5,0	6	10,00	57
1661595	D50306002WW	1661592	D50306002CW	1661593	D50306002RW	6,0	6	7,00	54
1661694	D51306002WW	—	—	1661692	D51306002RW	6,0	6	10,00	57
1661605	D50308003WW	1661601	D50308003CW	1661603	D50308003RW	8,0	8	9,00	58
1661703	D51308003WW	—	—	1661701	D51308003RW	8,0	8	16,00	63
1661614	D50310004WW	1661611	D50310004CW	1661612	D50310004RW	10,0	10	11,00	66
1661712	D51310004WW	—	—	1661710	D51310004RW	10,0	10	19,00	72
1661619	D50312005WW	—	—	1661617	D50312005RW	12,0	12	12,00	73
1661717	D51312005WW	—	—	1661715	D51312005RW	12,0	12	22,00	83
—	—	—	—	1661622	D50314014RW	14,0	14	14,00	75
—	—	—	—	1661720	D51314014RW	14,0	14	22,00	83
1661629	D50316006WW	—	—	1661627	D50316006RW	16,0	16	16,00	82
1661727	D51316006WW	—	—	1661725	D51316006RW	16,0	16	26,00	92
1661732	D51318018WW	—	—	1661730	D51318018RW	18,0	18	26,00	92
—	—	—	—	1661636	D50320007RW	20,0	20	20,00	92
1661737	D51320007WW	—	—	1661735	D51320007RW	20,0	20	32,00	104

- Centre cutting.
- Standard items listed. Additional styles and coatings made-to-order.

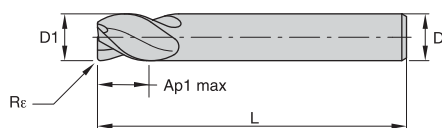

End Mill Tolerances

D1	tolerance e8	D	tolerance h6 + / -
≤ 3	-0,014/-0,028	≤ 3	0/-0,006
> 3-6	-0,020/-0,038	> 3-6	0/-0,008
> 6-10	-0,025/-0,047	> 6-10	0/-0,009
> 10-18	-0,032/-0,059	> 10-18	0/-0,011
> 18-30	-0,040/-0,073	> 18-30	0/-0,013

Series DC03

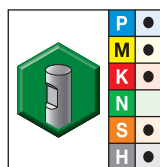

grade TiAlN-LW
TiAlN

- first choice
- alternate choice

order #	catalogue #	D1	D	length of cut Ap1 max	length L	Re
1661856	DC0303002LW	3,0	6	4,00	50	0,25
1661858	DC0304002LW	4,0	6	5,00	54	0,25
1661860	DC0305002LW	5,0	6	6,00	54	0,25
1661862	DC0306002LW	6,0	6	7,00	54	0,45
1661866	DC0308003LW	8,0	8	9,00	58	0,45
1661868	DC0310004LW	10,0	10	11,00	66	0,45
1661870	DC0312005LW	12,0	12	12,00	73	0,45
1661872	DC0314014LW	14,0	14	14,00	75	0,45
1661874	DC0316006LW	16,0	16	16,00	82	0,45
1661876	DC0318018LW	18,0	18	18,00	84	0,45
1661878	DC0320007LW	20,0	20	20,00	92	0,45

- Centre cutting.
- Standard items listed. Additional styles and coatings made-to-order.

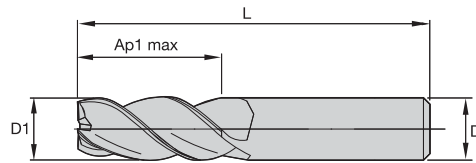

End Mill Tolerances

D1	tolerance e8	D	tolerance h6 + / -
≤ 3	-0,014/-0,028	≤ 3	0/-0,006
> 3-6	-0,020/-0,038	> 3-6	0/-0,008
> 6-10	-0,025/-0,047	> 6-10	0/-0,009
> 10-18	-0,032/-0,059	> 10-18	0/-0,011
> 18-30	-0,040/-0,073	> 18-30	0/-0,013



■ Series 4503 JJ • Victory Grades

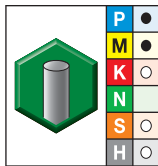

grade WP15PE
AlTiN

- first choice
- alternate choice

order #	catalogue #	D1	D	length of cut Ap1 max	length L
5559170	450301001T	1,0	4	3,00	50
5559171	450301501T	1,5	4	3,00	50
5559172	450302001T	2,0	4	3,00	50
5559173	450302501T	2,5	4	4,00	50
5559174	450302511T	2,5	4	5,00	50
5559175	450303002T	3,0	6	8,00	50
5559176	450303502T	3,5	6	12,00	50
5559177	450304002T	4,0	6	12,00	50
5559178	450304502T	4,5	6	14,00	50
5559179	450305002T	5,0	6	14,00	50
5559180	450306002T	6,0	6	16,00	50
5559181	450308003T	8,0	8	20,00	63
5559182	450310004T	10,0	10	22,00	76
5559183	450312005T	12,0	12	25,00	76
5559184	450316006T	16,0	16	32,00	89
5559185	450320007T	20,0	20	38,00	104

High-Performance Solid Carbide End Mills

High-Performance Solid Carbide End Mills • Finishing

Series 022801 022804 022802 322806 322801 322804 322802
422806 422801 422804 422802 422806



- Centre cutting.
- Standard items listed. Additional styles and coatings made-to-order.

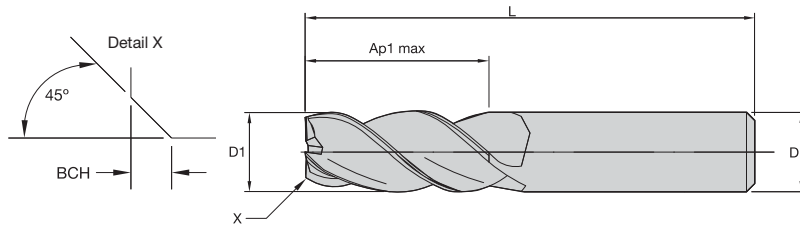

End Mill Tolerances

D1	tolerance h10 + / -	D	tolerance h6 + / -
≤ 3	0/-0,040	≤ 3	0/-0,006
> 3-6	0/-0,048	> 3-6	0/-0,008
> 6-10	0/-0,058	> 6-10	0/-0,009
> 10-18	0/-0,070	> 10-18	0/-0,011
> 18-30	0/-0,084	> 18-30	0/-0,013

Series 022801 022804 022802 322806 322801 322804 322802 422806

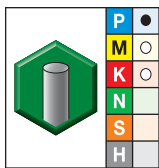

grade K30F uncoated

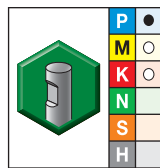

grade K30F uncoated

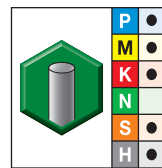

grade K30F-TiCN TiCN

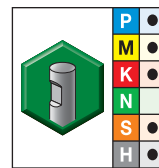

grade K30F-TiCN TiCN

- first choice
- alternate choice

order #	catalogue #	order #	catalogue #	order #	catalogue #	order #	catalogue #	D1	D	length of cut Ap1 max	length L	BCH
2332115	022801-000020	2332132	022802-000020	2335347	322801-000020	2335365	322802-000020	2,0	6	3,00	50	0,10
3048459	022804-000020	3048480	022806-000020	3048485	322804-000020	3048488	322806-000020	2,0	6	6,00	57	0,10
2332116	022801-000025	2332133	022802-000025	2335348	322801-000025	2335366	322802-000025	2,5	6	3,00	50	0,10
3048461	022804-000025	3048483	022806-000025	3048486	322804-000025	3048489	322806-000025	2,5	6	7,00	57	0,10
2332117	022801-000030	2332135	022802-000030	2335349	322801-000030	2335368	322802-000030	3,0	6	4,00	50	0,10
2332153	022804-000030	2345784	022806-000030	2335388	322804-000030	2335403	322806-000030	3,0	6	7,00	57	0,10
2332118	022801-000035	2332136	022802-000035	2335350	322801-000035	2335369	322802-000035	3,5	6	4,00	50	0,10
2332154	022804-000035	2332170	022806-000035	2335389	322804-000035	2335404	322806-000035	3,5	6	7,00	57	0,10
2332119	022801-000040	2332137	022802-000040	2335351	322801-000040	2335370	322802-000040	4,0	6	5,00	54	0,10
2332155	022804-000040	2332171	022806-000040	2335390	322804-000040	2335406	322806-000040	4,0	6	8,00	57	0,10
-		2332138	022802-000045	2335352	322801-000045	2335371	322802-000045	4,5	6	5,00	54	0,10
2332156	022804-000045	2332172	022806-000045	2335391	322804-000045	2335407	322806-000045	4,5	6	8,00	57	0,10
2332121	022801-000050	2332139	022802-000050	2335353	322801-000050	2335372	322802-000050	5,0	6	6,00	54	0,10
2332157	022804-000050	2332173	022806-000050	2335392	322804-000050	2335408	322806-000050	5,0	6	10,00	57	0,10
2332122	022801-000060	2332140	022802-000060	2335354	322801-000060	2335374	322802-000060	6,0	6	7,00	54	0,10
2332158	022804-000060	2332174	022806-000060	2335393	322804-000060	2335409	322806-000060	6,0	6	10,00	57	0,10
2332123	022801-000070	-		2335355	322801-000070	2335376	322802-000070	7,0	8	8,00	58	0,20
2332159	022804-000070	2332175	022806-000070	2335394	322804-000070	2335410	322806-000070	7,0	8	13,00	63	0,20
2332124	022801-000080	-		2335356	322801-000080	2335378	322802-000080	8,0	8	9,00	58	0,20
2332160	022804-000080	2332176	022806-000080	2335395	322804-000080	2335411	322806-000080	8,0	8	16,00	63	0,20

(continued)



(Series 022801 022804 022802 322806 322801 322804 322802 422806 — continued)

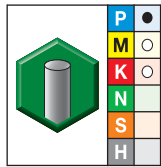
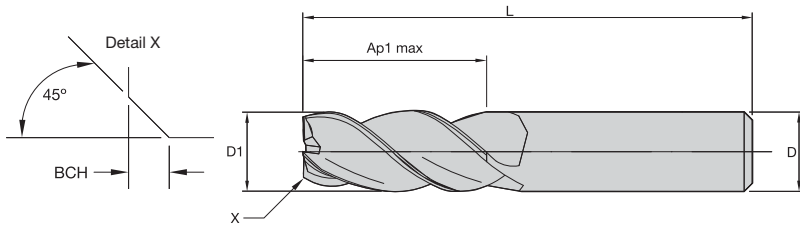

grade K30F uncoated

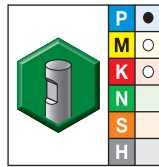

grade K30F uncoated

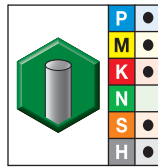

grade K30F-TiCN TiCN

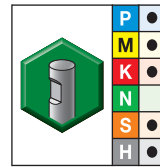

grade K30F-TiCN TiCN

order #	catalogue #	order #	catalogue #	order #	catalogue #	order #	catalogue #	D1	D	length of cut Ap1 max	length L	BCH
2332125	022801-000090	2332143	022802-000090	2335357	322801-000090	2335379	322802-000090	9,0	10	10,00	66	0,20
2332161	022804-000090	2332177	022806-000090	2335396	322804-000090	2335412	322806-000090	9,0	10	16,00	72	0,20
—	—	2332144	022802-000100	2335358	322801-000100	2335381	322802-000100	10,0	10	11,00	66	0,30
2332162	022804-000100	2332178	022806-000100	2335397	322804-000100	2335413	322806-000100	10,0	10	19,00	72	0,30
2332127	022801-000120	—	—	2335360	322801-000120	2335383	322802-000120	12,0	12	12,00	73	0,30
2332163	022804-000120	2332179	022806-000120	2335398	322804-000120	2335415	322806-000120	12,0	12	22,00	83	0,30
—	—	2332147	022802-000140	2335361	322801-000140	2335384	322802-000140	14,0	14	14,00	75	0,30
2332164	022804-000140	2332180	022806-000140	2335399	322804-000140	2335417	322806-000140	14,0	14	22,00	83	0,30
—	—	—	—	2335362	322801-000160	2335385	322802-000160	16,0	16	16,00	82	0,40
2332165	022804-000160	2332181	022806-000160	2335400	322804-000160	2335420	322806-000160	16,0	16	26,00	92	0,40
—	—	—	—	2335363	322801-000180	2335386	322802-000180	18,0	18	18,00	84	0,40
—	—	2332182	022806-000180	2335401	322804-000180	2335421	322806-000180	18,0	18	26,00	92	0,40
2332131	022801-000200	2332150	022802-000200	2335364	322801-000200	2335387	322802-000200	20,0	20	20,00	92	0,40
2332167	022804-000200	2332183	022806-000200	2335402	322804-000200	2335422	322806-000200	20,0	20	32,00	104	0,40

High-Performance Solid Carbide End Mills

■ Series 422801 422804 422802 422806

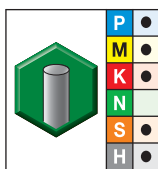

grade K30F-DCF TiAlN

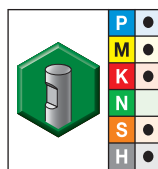

grade K30F-DCF TiAlN

- first choice
- alternate choice

order #	catalogue #	order #	catalogue #	D1	D	length of cut Ap1 max	length L	BCH
2341532	422801-000020	2341566	422802-000020	2,0	6	3,00	50	0,10
3048490	422804-000020	3048492	422806-000020	2,0	6	6,00	57	0,10
2341534	422801-000025	2341568	422802-000025	2,5	6	3,00	50	0,10
3048491	422804-000025	3048503	422806-000025	2,5	6	7,00	57	0,10
2341536	422801-000030	2341570	422802-000030	3,0	6	4,00	50	0,10
2341603	422804-000030	2341634	422806-000030	3,0	6	7,00	57	0,10
2341538	422801-000035	2341573	422802-000035	3,5	6	4,00	50	0,10
2341606	422804-000035	2341636	422806-000035	3,5	6	7,00	57	0,10

(continued)

High-Performance Solid Carbide End Mills • Finishing

Series 022801 022804 022802 322806 322801 322804 322802
422806 422801 422804 422802 422806

(Series 422801 422804 422802 422806 — continued)

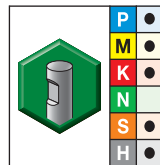
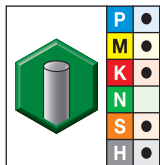
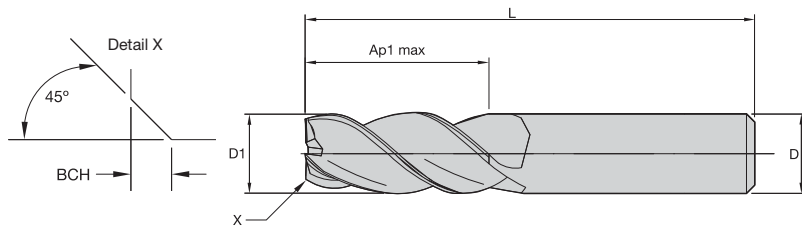

● first choice
○ alternate choice

grade K30F-DCF
TiAlN

grade K30F-DCF
TiAlN

order #	catalogue #	order #	catalogue #	D1	D	length of cut Ap1 max	length L	BCH
2341540	422801-000040	2341575	422802-000040	4,0	6	5,00	54	0,10
2341608	422804-000040	2341638	422806-000040	4,0	6	8,00	57	0,10
2341542	422801-000045	2341577	422802-000045	4,5	6	5,00	54	0,10
2341610	422804-000045	2341640	422806-000045	4,5	6	8,00	57	0,10
2341544	422801-000050	2341579	422802-000050	5,0	6	6,00	54	0,10
2341612	422804-000050	2341642	422806-000050	5,0	6	10,00	57	0,10
2341546	422801-000060	2341581	422802-000060	6,0	6	7,00	54	0,10
2341614	422804-000060	2341644	422806-000060	6,0	6	10,00	57	0,10
2341548	422801-000070	2341583	422802-000070	7,0	8	8,00	58	0,20
2341616	422804-000070	2341646	422806-000070	7,0	8	13,00	63	0,20
2341550	422801-000080	2341587	422802-000080	8,0	8	9,00	58	0,20
2341618	422804-000080	2341648	422806-000080	8,0	8	16,00	63	0,20
2341553	422801-000090	2341589	422802-000090	9,0	10	10,00	66	0,20
2341620	422804-000090	2341650	422806-000090	9,0	10	16,00	72	0,20
2341555	422801-000100	2341591	422802-000100	10,0	10	11,00	66	0,30
2341622	422804-000100	2341653	422806-000100	10,0	10	19,00	72	0,30
2341557	422801-000120	2341593	422802-000120	12,0	12	12,00	73	0,30
2341624	422804-000120	2341657	422806-000120	12,0	12	22,00	83	0,30
2341559	422801-000140	2341595	422802-000140	14,0	14	14,00	75	0,30
2341626	422804-000140	2341659	422806-000140	14,0	14	22,00	83	0,30
2341561	422801-000160	2341597	422802-000160	16,0	16	16,00	82	0,40
2341628	422804-000160	2341661	422806-000160	16,0	16	26,00	92	0,40
2341562	422801-000180	2341599	422802-000180	18,0	18	18,00	84	0,40
2341630	422804-000180	2341663	422806-000180	18,0	18	26,00	92	0,40
2341564	422801-000200	2341601	422802-000200	20,0	20	20,00	92	0,40
2341632	422804-000200	2341665	422806-000200	20,0	20	32,00	104	0,40

Chamfer Data

Corner Chamfer

D1 h10	BCH	tolerance
2-6,99	0,1	-0,05
7-9,99	0,2	-0,10
10-15,99	0,3	-0,10
16-20,00	0,4	-0,20

- Centre cutting.
- Standard items listed. Additional styles and coatings made-to-order.

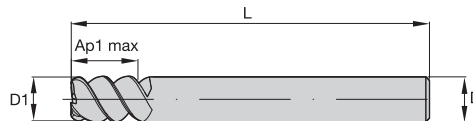

End Mill Tolerances

D1	tolerance e8	D	tolerance h6 + / -
≤ 3	-0,014/-0,028	≤ 3	0/-0,006
> 3-6	-0,020/-0,038	> 3-6	0/-0,008
> 6-10	-0,025/-0,047	> 6-10	0/-0,009
> 10-18	-0,032/-0,059	> 10-18	0/-0,011
> 18-30	-0,040/-0,073	> 18-30	0/-0,013

■ Series 4603

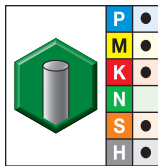

grade TiAlN-RT
TiAlN

- first choice
- alternate choice

order #	catalogue #	D1	D	length of cut Ap1 max	length L
1656750	460303002RT	3,0	6	8,00	57
1656758	460304002RT	4,0	6	11,00	57
1656765	460305002RT	5,0	6	13,00	57
1656773	460306002RT	6,0	6	13,00	57
1656781	460308003RT	8,0	8	19,00	63
1656791	460310004RT	10,0	10	22,00	72
1656799	460312005RT	12,0	12	26,00	83
1656807	460316006RT	16,0	16	32,00	92
1656815	460320007RT	20,0	20	38,00	104

- Centre cutting.
- Standard items listed. Additional styles and coatings made-to-order.

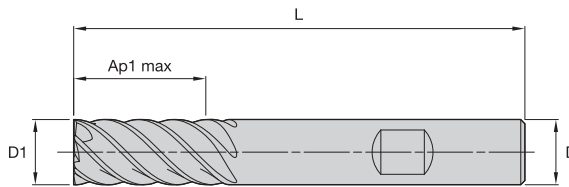

End Mill Tolerances

D1	tolerance e8	D	tolerance h6 + / -
≤ 3	-0,014/-0,028	≤ 3	0/-0,006
> 3-6	-0,020/-0,038	> 3-6	0/-0,008
> 6-10	-0,025/-0,047	> 6-10	0/-0,009
> 10-18	-0,032/-0,059	> 10-18	0/-0,011
> 18-30	-0,040/-0,073	> 18-30	0/-0,013



Series D507 D517 • Victory Grades

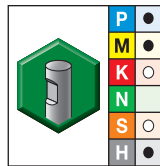

grade WP15PE
AlTiN

- first choice
- alternate choice

order #	catalogue #	D1	D	length of cut Ap1 max	length L
5559100	D50706002W	6,0	6	10,00	54
5559108	D51706002W	6,0	6	13,00	57
5559101	D50708003W	8,0	8	12,00	58
5559109	D51708003W	8,0	8	19,00	63
5559102	D50710004W	10,0	10	14,00	66
5559110	D51710004W	10,0	10	22,00	72
5559103	D50712005W	12,0	12	16,00	73
5559111	D51712005W	12,0	12	26,00	83
5559104	D50714014W	14,0	14	18,00	75
5559112	D51714014W	14,0	14	26,00	83
5559105	D50716006W	16,0	16	22,00	82
5559113	D51716006W	16,0	16	32,00	92
5559106	D50718018W	18,0	18	24,00	84
5559114	D51718018W	18,0	18	32,00	92
5559107	D50720007W	20,0	20	26,00	92
5559115	D51720007W	20,0	20	38,00	104

- Non-centre cutting.
- Standard items listed. Additional styles and coatings made-to-order.

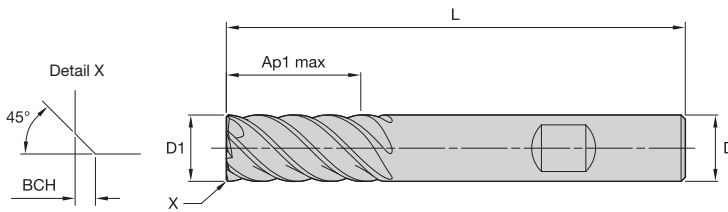

End Mill Tolerances

D1	tolerance h10 + / -	D	tolerance h6 + / -
≤ 3	0/-0,040	≤ 3	0/-0,006
> 3-6	0/-0,048	> 3-6	0/-0,008
> 6-10	0/-0,058	> 6-10	0/-0,009
> 10-18	0/-0,070	> 10-18	0/-0,011
> 18-30	0/-0,084	> 18-30	0/-0,013

■ Series 422822 422826

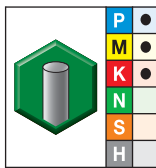

grade K30F-DCHP
AITiN

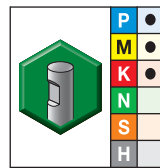

grade K30F-DCHP
AITiN

- first choice
- alternate choice

order #	catalogue #	order #	catalogue #	D1	D	length of cut Ap1 max	length L	BCH	ZU
2342270	422822-000060	2342341	422826-000060	6,0	6	13,00	57	0,10	6
2342272	422822-000080	2342343	422826-000080	8,0	8	19,00	63	0,20	6
2342274	422822-000100	2342345	422826-000100	10,0	10	22,00	72	0,30	6
2342276	422822-000120	2342347	422826-000120	12,0	12	26,00	83	0,30	6
2342280	422822-000160	2342351	422826-000160	16,0	16	32,00	92	0,40	6
2342282	422822-000180	2342353	422826-000180	18,0	18	32,00	92	0,40	8
2342284	422822-000200	2342355	422826-000200	20,0	20	38,00	104	0,40	8
2342286	422822-000250	2342357	422826-000250	25,0	25	45,00	121	0,40	8

High-Performance Solid Carbide End Mills

- Non-centre cutting.
- Standard items listed. Additional styles and coatings made-to-order.

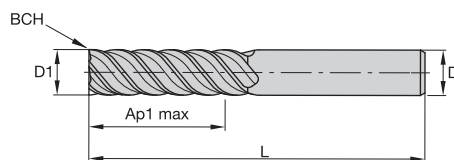

End Mill Tolerances

D1	tolerance h10 + / -	D	tolerance h6 + / -
≤ 3	0/-0,040	≤ 3	0/-0,006
> 3-6	0/-0,048	> 3-6	0/-0,008
> 6-10	0/-0,058	> 6-10	0/-0,009
> 10-18	0/-0,070	> 10-18	0/-0,011
> 18-30	0/-0,084	> 18-30	0/-0,013

Series 422827

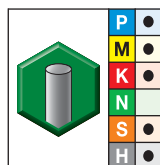

grade K30F-DCHP
AlTiN

- first choice
- alternate choice

order #	catalogue #	D1	D	length of cut Ap1 max	length L	BCH	ZU
2342360	422827-000060	6,0	6	18,00	62	0,10	6
2342362	422827-000080	8,0	8	24,00	68	0,20	6
2342364	422827-000100	10,0	10	30,00	80	0,30	6
2342366	422827-000120	12,0	12	36,00	93	0,30	6
2342368	422827-000160	16,0	16	48,00	108	0,30	6
2342370	422827-000200	20,0	20	60,00	126	0,40	8
2342372	422827-000250	25,0	25	75,00	150	0,40	8

- Centre cutting.
- Standard items listed. Additional styles and coatings made-to-order.

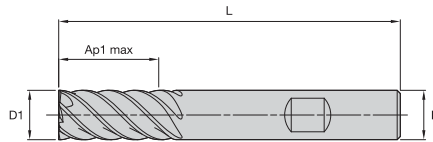

End Mill Tolerances

D1	tolerance e8	D	tolerance h6 + / -
≤ 3	-0,014/-0,028	≤ 3	0/-0,006
> 3-6	-0,020/-0,038	> 3-6	0/-0,008
> 6-10	-0,025/-0,047	> 6-10	0/-0,009
> 10-18	-0,032/-0,059	> 10-18	0/-0,011
> 18-30	-0,040/-0,073	> 18-30	0/-0,013



■ Series D518 • Vision Plus • Victory Grades

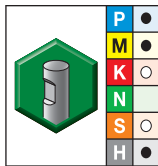

grade WP15PE
AlTiN

- first choice
- alternate choice

order #	catalogue #	D1	D	length of cut Ap1 max	length L	ZU
5559116	D51804002W	4,0	6	11,00	57	4
5559117	D51805002W	5,0	6	13,00	57	4
5559118	D51806002W	6,0	6	13,00	57	6
5559119	D51807003W	7,0	8	16,00	63	6
5559120	D51808003W	8,0	8	19,00	63	6
5559121	D51809004W	9,0	10	19,00	72	6
5559122	D51810004W	10,0	10	22,00	72	6
5559123	D51812005W	12,0	12	26,00	83	6
5559124	D51814014W	14,0	14	26,00	83	6
5559125	D51816006W	16,0	16	32,00	92	8
5559126	D51818018W	18,0	18	32,00	92	8
5559127	D51820007W	20,0	20	38,00	104	8
5559128	D51825008W	25,0	25	45,00	121	8

High-Performance Solid Carbide End Mills

- Non-centre cutting.
- Standard items listed. Additional styles and coatings made-to-order.

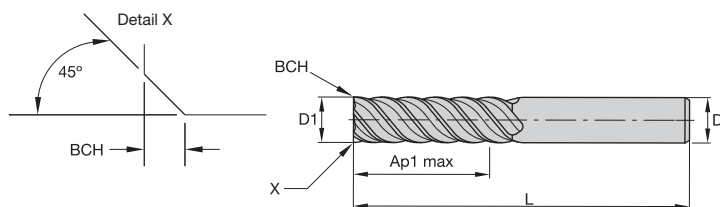

End Mill Tolerances

D1	tolerance h10 + / -	D	tolerance h6 + / -
≤ 3	0/-0,040	≤ 3	0/-0,006
> 3-6	0/-0,048	> 3-6	0/-0,008
> 6-10	0/-0,058	> 6-10	0/-0,009
> 10-18	0/-0,070	> 10-18	0/-0,011
> 18-30	0/-0,084	> 18-30	0/-0,013

Series 026621 • Cermet End Mill

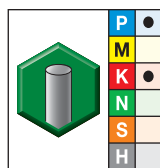

grade UNCOATED

- first choice
- alternate choice

order #	catalogue #	D1	D	length of cut Ap1 max	length L	BCH	ZU
2333138	026621-000080	8,0	8	19,00	63	0,20	4
2333140	026621-000120	12,0	12	26,00	83	0,30	6
2333143	026621-000160	16,0	16	32,00	92	0,40	8
2333145	026621-000200	20,0	20	38,00	104	0,40	8

- Centre cutting.
- Standard items listed. Additional styles and coatings made-to-order.

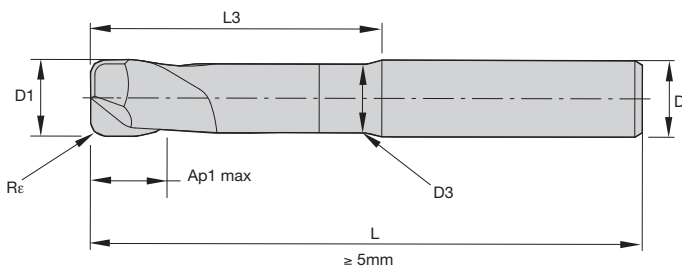

End Mill Tolerances

D1	tolerance h10 + / -	D	tolerance h6 + / -
≤ 3	0/-0,040	≤ 3	0/-0,006
> 3-6	0/-0,048	> 3-6	0/-0,008
> 6-10	0/-0,058	> 6-10	0/-0,009
> 10-18	0/-0,070	> 10-18	0/-0,011
> 18-30	0/-0,084	> 18-30	0/-0,013

■ Series 024112

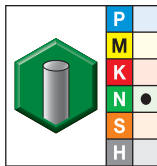

grade K10F-DIA
DIAMOND

- first choice
- alternate choice

order #	catalogue #	D1	D	D3	length of cut Ap1 max	L3	length L	Re
2333112	024112-006005	6,0	6	5,80	6,00	42,00	80	0,50
2333113	024112-008010	8,0	8	7,80	8,00	50,00	90	1,00
2333114	024112-010020	10,0	10	9,70	10,00	56,00	100	2,00

High-Performance Solid Carbide End Mills

- Centre cutting.
- Standard items listed. Additional styles and coatings made-to-order.

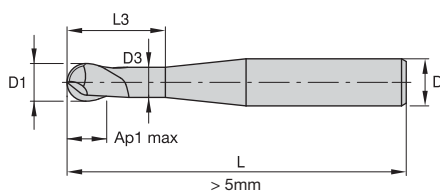

End Mill Tolerances

D1	tolerance h10 + / -	D	tolerance h6 + / -
≤ 3	0/-0,040	≤ 3	0/-0,006
> 3-6	0/-0,048	> 3-6	0/-0,008
> 6-10	0/-0,058	> 6-10	0/-0,009
> 10-18	0/-0,070	> 10-18	0/-0,011
> 18-30	0/-0,084	> 18-30	0/-0,013

■ Series 024111

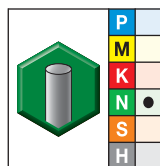

grade K10F-DIA
DIAMOND

- first choice
- alternate choice

order #	catalogue #	D1	D	D3	length of cut Ap1 max	L3	length L
2333099	024111-000020	2,0	6	1,90	2,00	17,50	70
2333100	024111-000030	3,0	6	2,90	3,00	18,50	70
2333101	024111-000040	4,0	6	3,80	4,00	19,50	80
2333102	024111-000050	5,0	6	4,80	5,00	39,00	80
2333103	024111-000060	6,0	6	5,80	6,00	42,00	80
2333104	024111-000080	8,0	8	7,80	8,00	52,00	90
2333105	024111-000100	10,0	10	9,70	10,00	58,00	100
2333106	024111-000120	12,0	12	11,70	12,00	63,00	110

■ Series 4001 JJ • Victory Grades



Material Group																					
	Side Milling (A) and Slotting (B)			WP15PE			Recommended feed per tooth (fz = mm/th) for side milling (A). For slotting (B), reduce fz by 20%.														
	A		B	Cutting Speed – vc m/min		D1 – Diameter															
	ap	ae	ap	min	max	mm	2,0	3,0	4,0	5,0	6,0	8,0	10,0	12,0	14,0	16,0	18,0	20,0	25,0		
P	0	1,25 x D	0,25 x D	0,5 x D	150	–	200	fz	0,012	0,019	0,026	0,032	0,039	0,054	0,065	0,075	0,083	0,091	0,097	0,103	0,111
	1	1,25 x D	0,25 x D	0,5 x D	150	–	200	fz	0,012	0,019	0,026	0,032	0,039	0,054	0,065	0,075	0,083	0,091	0,097	0,103	0,111
	2	1,25 x D	0,25 x D	0,5 x D	140	–	190	fz	0,012	0,019	0,026	0,032	0,039	0,054	0,065	0,075	0,083	0,091	0,097	0,103	0,111
	3	1,25 x D	0,25 x D	0,5 x D	120	–	160	fz	0,010	0,016	0,021	0,027	0,033	0,045	0,054	0,063	0,071	0,078	0,085	0,091	0,102
	4	1,25 x D	0,25 x D	0,3 x D	90	–	150	fz	0,009	0,014	0,019	0,024	0,030	0,040	0,049	0,056	0,063	0,069	0,075	0,079	0,088
M	1	1,25 x D	0,25 x D	0,5 x D	90	–	115	fz	0,010	0,016	0,021	0,027	0,033	0,045	0,054	0,063	0,071	0,078	0,085	0,091	0,102
	2	1,25 x D	0,25 x D	0,5 x D	60	–	80	fz	0,008	0,013	0,017	0,022	0,026	0,036	0,044	0,051	0,057	0,063	0,068	0,073	0,082
K	1	1,25 x D	0,25 x D	0,5 x D	120	–	150	fz	0,012	0,019	0,026	0,032	0,039	0,054	0,065	0,075	0,083	0,091	0,097	0,103	0,111
	2	1,25 x D	0,25 x D	0,5 x D	110	–	140	fz	0,010	0,016	0,021	0,027	0,033	0,045	0,054	0,063	0,071	0,078	0,085	0,091	0,102
N	1	1,25 x D	0,25 x D	0,5 x D	500	–	2000	fz	0,018	0,027	0,036	0,045	0,054	0,072	0,090	0,108	0,126	0,144	0,162	0,180	0,225
	2	1,25 x D	0,25 x D	0,5 x D	500	–	1500	fz	0,016	0,024	0,032	0,041	0,049	0,065	0,081	0,097	0,113	0,130	0,146	0,162	0,203
	3	1,25 x D	0,25 x D	0,5 x D	250	–	1000	fz	0,016	0,024	0,032	0,041	0,049	0,065	0,081	0,097	0,113	0,130	0,146	0,162	0,203
	4	1,25 x D	0,25 x D	0,5 x D	100	–	750	fz	0,018	0,027	0,036	0,045	0,054	0,072	0,090	0,108	0,126	0,144	0,162	0,180	0,225

NOTE: Lower value of cutting speed is used for high stock removal applications or for higher hardness (machinability) within group.
Higher value of cutting speed is used for finishing applications or for lower hardness (machinability) within group.
Above parameters are based on ideal conditions. For smaller taper machining centres, please adjust parameters accordingly on >12mm diameters.



■ Series D503

Material Group		Side Milling (A) and Slotting (B)		uncoated		TiAlN		Recommended feed per tooth (fz = mm/th) for side milling (A). For slotting (B), reduce fz by 20%.													
		A		B		Cutting Speed – vc m/min		mm	D1 – Diameter												
		ap	ae	ap	ap	min	max		min	max	2,0	3,0	4,0	5,0	6,0	8,0	10,0	12,0	14,0	16,0	18,0
		0,75 x D	0,4 x D	0,5 x D	0,5 x D	60	80	150	200	fz	0,014	0,021	0,028	0,036	0,044	0,060	0,072	0,083	0,092	0,101	0,108
P	0	0,75 x D	0,4 x D	0,5 x D	60	80	150	200	fz	0,014	0,021	0,028	0,036	0,044	0,060	0,072	0,083	0,092	0,101	0,108	0,114
	1	0,75 x D	0,4 x D	0,5 x D	60	80	150	200	fz	0,014	0,021	0,028	0,036	0,044	0,060	0,072	0,083	0,092	0,101	0,108	0,114
	2	0,75 x D	0,4 x D	0,5 x D	56	76	140	190	fz	0,014	0,021	0,028	0,036	0,044	0,060	0,072	0,083	0,092	0,101	0,108	0,114
	3	0,75 x D	0,4 x D	0,5 x D	48	64	120	160	fz	0,011	0,017	0,023	0,030	0,036	0,050	0,061	0,070	0,079	0,087	0,095	0,101
	4	0,75 x D	0,4 x D	0,3 x D	-	-	90	150	fz	0,010	0,016	0,021	0,027	0,033	0,045	0,054	0,062	0,070	0,077	0,083	0,088
	5	0,75 x D	0,4 x D	0,5 x D	-	-	60	100	fz	0,009	0,014	0,019	0,024	0,029	0,040	0,048	0,056	0,063	0,070	0,076	0,081
	6	0,75 x D	0,4 x D	0,3 x D	-	-	50	75	fz	0,008	0,012	0,016	0,020	0,025	0,034	0,040	0,047	0,052	0,057	0,061	0,065
M	1	0,75 x D	0,4 x D	0,5 x D	36	46	90	115	fz	0,011	0,017	0,023	0,030	0,036	0,050	0,061	0,070	0,079	0,087	0,095	0,101
	2	0,75 x D	0,4 x D	0,5 x D	-	-	60	80	fz	0,009	0,014	0,019	0,024	0,029	0,040	0,048	0,056	0,063	0,070	0,076	0,081
	3	0,75 x D	0,4 x D	0,5 x D	-	-	60	70	fz	0,008	0,012	0,016	0,020	0,025	0,034	0,040	0,047	0,052	0,057	0,061	0,065
K	1	0,75 x D	0,4 x D	0,5 x D	48	60	120	150	fz	0,014	0,021	0,028	0,036	0,044	0,060	0,072	0,083	0,092	0,101	0,108	0,114
	2	0,75 x D	0,4 x D	0,5 x D	-	-	110	140	fz	0,011	0,017	0,023	0,030	0,036	0,050	0,061	0,070	0,079	0,087	0,095	0,101
	3	0,75 x D	0,4 x D	0,5 x D	-	-	110	130	fz	0,009	0,014	0,019	0,024	0,029	0,040	0,048	0,056	0,063	0,070	0,076	0,081
S	1	0,75 x D	0,4 x D	0,3 x D	-	-	50	90	fz	0,011	0,017	0,023	0,030	0,036	0,050	0,061	0,070	0,079	0,087	0,095	0,101
	2	0,75 x D	0,4 x D	0,3 x D	-	-	25	40	fz	0,006	0,009	0,013	0,016	0,019	0,026	0,032	0,037	0,042	0,046	0,050	0,054
	3	0,75 x D	0,4 x D	0,3 x D	-	-	60	80	fz	0,009	0,014	0,019	0,024	0,029	0,040	0,048	0,056	0,063	0,070	0,076	0,081
	4	0,75 x D	0,4 x D	0,5 x D	-	-	50	60	fz	0,007	0,011	0,016	0,021	0,026	0,037	0,045	0,052	0,058	0,064	0,069	0,074
H	1	0,75 x D	0,4 x D	0,3 x D	-	-	80	140	fz	0,010	0,016	0,021	0,027	0,033	0,045	0,054	0,062	0,070	0,077	0,083	0,088

NOTE: Lower value of cutting speed is used for high stock removal applications or for higher hardness (machinability) within group.
 Higher value of cutting speed is used for finishing applications or for lower hardness (machinability) within group.
 Above parameters are based on ideal conditions. For smaller taper machining centres, please adjust parameters accordingly on >12mm diameters.

High-Performance Solid Carbide End Mills

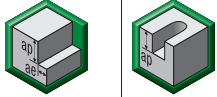
■ Series D513

Material Group													Recommended feed per tooth (fz = mm/th) for side milling (A). For slotting (B), reduce fz by 20%.										
	Side Milling (A) and Slotting (B)		uncoated			TiAlN																	
	A		B	Cutting Speed – vc m/min			Cutting Speed – vc m/min			D1 – Diameter													
	ap	ae	ap	min	max	min	max	mm	2,0	3,0	4,0	5,0	6,0	8,0	10,0	12,0	14,0	16,0	18,0	20,0			
P	0	1,25 x D	0,2 x D	0,25 x D	60	–	80	150	–	200	fz	0,014	0,021	0,028	0,036	0,044	0,060	0,072	0,083	0,092	0,101	0,108	0,114
	1	1,25 x D	0,2 x D	0,25 x D	60	–	80	150	–	200	fz	0,014	0,021	0,028	0,036	0,044	0,060	0,072	0,083	0,092	0,101	0,108	0,114
	2	1,25 x D	0,2 x D	0,25 x D	56	–	76	140	–	190	fz	0,014	0,021	0,028	0,036	0,044	0,060	0,072	0,083	0,092	0,101	0,108	0,114
	3	1,25 x D	0,2 x D	0,25 x D	48	–	64	120	–	160	fz	0,011	0,017	0,023	0,030	0,036	0,050	0,061	0,070	0,079	0,087	0,095	0,101
	4	1,25 x D	0,2 x D	0,25 x D	–	–	–	90	–	150	fz	0,010	0,016	0,021	0,027	0,033	0,045	0,054	0,062	0,070	0,077	0,083	0,088
	5	1,25 x D	0,2 x D	0,25 x D	–	–	–	60	–	100	fz	0,009	0,014	0,019	0,024	0,029	0,040	0,048	0,056	0,063	0,070	0,076	0,081
M	1	1,25 x D	0,2 x D	0,25 x D	36	–	46	90	–	115	fz	0,011	0,017	0,023	0,030	0,036	0,050	0,061	0,070	0,079	0,087	0,095	0,101
	2	1,25 x D	0,2 x D	0,25 x D	–	–	–	60	–	80	fz	0,009	0,014	0,019	0,024	0,029	0,040	0,048	0,056	0,063	0,070	0,076	0,081
	3	1,25 x D	0,2 x D	0,25 x D	–	–	–	60	–	70	fz	0,008	0,012	0,016	0,020	0,025	0,034	0,040	0,047	0,052	0,057	0,061	0,065
K	1	1,25 x D	0,2 x D	0,25 x D	48	–	60	120	–	150	fz	0,014	0,021	0,028	0,036	0,044	0,060	0,072	0,083	0,092	0,101	0,108	0,114
	2	1,25 x D	0,2 x D	0,25 x D	–	–	–	110	–	140	fz	0,011	0,017	0,023	0,030	0,036	0,050	0,061	0,070	0,079	0,087	0,095	0,101
	3	1,25 x D	0,2 x D	0,25 x D	–	–	–	110	–	130	fz	0,009	0,014	0,019	0,024	0,029	0,040	0,048	0,056	0,063	0,070	0,076	0,081
S	1	1,25 x D	0,2 x D	0,25 x D	–	–	–	50	–	90	fz	0,011	0,017	0,023	0,030	0,036	0,050	0,061	0,070	0,079	0,087	0,095	0,101
	2	1,25 x D	0,2 x D	0,25 x D	–	–	–	25	–	40	fz	0,006	0,009	0,013	0,016	0,019	0,026	0,032	0,037	0,042	0,046	0,050	0,054
	3	1,25 x D	0,2 x D	0,25 x D	–	–	–	60	–	80	fz	0,009	0,014	0,019	0,024	0,029	0,040	0,048	0,056	0,063	0,070	0,076	0,081
	4	1,25 x D	0,2 x D	0,25 x D	–	–	–	50	–	60	fz	0,007	0,011	0,016	0,021	0,026	0,037	0,045	0,052	0,058	0,064	0,069	0,074
H	1	1,25 x D	0,2 x D	0,25 x D	–	–	–	80	–	140	fz	0,010	0,016	0,021	0,027	0,033	0,045	0,054	0,062	0,070	0,077	0,083	0,088

NOTE: Lower value of cutting speed is used for high stock removal applications or for higher hardness (machinability) within group.
Higher value of cutting speed is used for finishing applications or for lower hardness (machinability) within group.
Above parameters are based on ideal conditions. For smaller taper machining centres, please adjust parameters accordingly on >12mm diameters.

■ Series DC03

Material Group																				
	Side Milling (A) and Slotting (B)				TiAlN		Recommended feed per tooth (fz = mm/th) for side milling (A). For slotting (B), reduce fz by 20%.													
	A		B		Cutting Speed – vc m/min		D1 – Diameter													
	ap	ae	ap	min	max	mm	3,0	4,0	5,0	6,0	8,0	10,0	12,0	14,0	16,0	18,0	20,0			
P	0	0,75 x D	0,4 x D	0,5 x D	150	–	200	fz	0,021	0,028	0,028	0,028	0,028	0,044	0,060	0,072	0,083	0,101	0,114	
	1	0,75 x D	0,4 x D	0,5 x D	150	–	200	fz	0,021	0,028	0,028	0,028	0,028	0,044	0,060	0,072	0,083	0,101	0,114	
	2	0,75 x D	0,4 x D	0,5 x D	140	–	190	fz	0,018	0,023	0,023	0,023	0,023	0,036	0,050	0,061	0,070	0,087	0,101	
	3	0,75 x D	0,4 x D	0,5 x D	120	–	160	fz	0,016	0,021	0,021	0,021	0,021	0,033	0,045	0,054	0,062	0,077	0,088	
	4	0,75 x D	0,4 x D	0,3 x D	90	–	150	fz	0,014	0,019	0,019	0,019	0,019	0,029	0,040	0,048	0,056	0,070	0,081	
	5	0,75 x D	0,4 x D	0,5 x D	60	–	100	fz	0,014	0,019	0,019	0,019	0,019	0,029	0,040	0,048	0,056	0,070	0,081	
M	6	0,75 x D	0,4 x D	0,3 x D	50	–	75	fz	0,012	0,016	0,016	0,016	0,016	0,025	0,034	0,040	0,047	0,057	0,065	
	1	0,75 x D	0,4 x D	0,5 x D	90	–	115	fz	0,018	0,023	0,023	0,023	0,023	0,036	0,050	0,061	0,070	0,087	0,101	
	2	0,75 x D	0,4 x D	0,5 x D	60	–	80	fz	0,014	0,019	0,019	0,019	0,019	0,029	0,040	0,048	0,056	0,070	0,081	
K	3	0,75 x D	0,4 x D	0,5 x D	60	–	70	fz	0,012	0,016	0,016	0,016	0,016	0,025	0,034	0,040	0,047	0,057	0,065	
	1	0,75 x D	0,4 x D	0,5 x D	120	–	150	fz	0,021	0,028	0,028	0,028	0,028	0,044	0,060	0,072	0,083	0,101	0,114	
	2	0,75 x D	0,4 x D	0,5 x D	110	–	140	fz	0,018	0,023	0,023	0,023	0,023	0,036	0,050	0,061	0,070	0,087	0,101	
S	3	0,75 x D	0,4 x D	0,5 x D	110	–	130	fz	0,014	0,019	0,019	0,019	0,019	0,029	0,040	0,048	0,056	0,070	0,081	
	1	0,75 x D	0,4 x D	0,3 x D	50	–	90	fz	0,018	0,023	0,023	0,023	0,023	0,036	0,050	0,061	0,070	0,087	0,101	
	2	0,75 x D	0,4 x D	0,3 x D	25	–	40	fz	0,010	0,013	0,013	0,013	0,013	0,019	0,026	0,032	0,037	0,046	0,054	
	3	0,75 x D	0,4 x D	0,3 x D	60	–	80	fz	0,014	0,019	0,019	0,019	0,019	0,029	0,040	0,048	0,056	0,070	0,081	
H	4	0,75 x D	0,4 x D	0,5 x D	50	–	60	fz	0,012	0,016	0,016	0,016	0,016	0,026	0,037	0,045	0,052	0,064	0,074	
	1	0,75 x D	0,4 x D	0,3 x D	80	–	140	fz	0,016	0,021	0,021	0,021	0,021	0,033	0,045	0,054	0,062	0,077	0,088	

NOTE: Lower value of cutting speed is used for high stock removal applications or for higher hardness (machinability) within group.
 Higher value of cutting speed is used for finishing applications or for lower hardness (machinability) within group.
 Above parameters are based on ideal conditions. For smaller taper machining centres, please adjust parameters accordingly on >12mm diameters.

High-Performance Solid Carbide End Mills

■ Series 4503 JJ • Victory Grades



Material Group																							
	Side Milling (A) and Slotting (B)			WP15PE		Recommended feed per tooth (fz = mm/th) for side milling (A). For slotting (B), reduce fz by 20%.																	
	A		B	Cutting Speed – vc m/min		D1 – Diameter																	
	ap	ae	ap	min	max	mm	1,0	1,5	2,0	2,5	3,0	3,5	4,0	4,5	5,0	6,0	8,0	10,0	12,0	16,0	18,0	20,0	
P	0	1,5 x D	0,3 x D	0,5 x D	150 – 200	fz	0,007	0,010	0,014	0,017	0,021	0,025	0,028	0,032	0,036	0,044	0,060	0,072	0,083	0,101	0,108	0,114	
	1	1,5 x D	0,3 x D	0,5 x D	150 – 200	fz	0,007	0,010	0,014	0,017	0,021	0,025	0,028	0,032	0,036	0,044	0,060	0,072	0,083	0,101	0,108	0,114	
	2	1,5 x D	0,3 x D	0,5 x D	140 – 190	fz	0,007	0,010	0,014	0,017	0,021	0,025	0,028	0,032	0,036	0,044	0,060	0,072	0,083	0,101	0,108	0,114	
	3	1,5 x D	0,3 x D	0,5 x D	120 – 160	fz	0,006	0,008	0,011	0,014	0,017	0,020	0,023	0,027	0,030	0,036	0,050	0,061	0,070	0,087	0,095	0,101	
	4	1,5 x D	0,3 x D	0,3 x D	90 – 150	fz	0,005	0,008	0,010	0,013	0,016	0,019	0,021	0,024	0,027	0,033	0,045	0,054	0,062	0,077	0,083	0,088	
	5	1,5 x D	0,3 x D	0,5 x D	60 – 100	fz	0,005	0,007	0,009	0,012	0,014	0,017	0,019	0,022	0,024	0,029	0,040	0,048	0,056	0,070	0,076	0,081	
M	1	1,5 x D	0,3 x D	0,5 x D	90 – 115	fz	0,006	0,008	0,011	0,014	0,017	0,020	0,023	0,027	0,030	0,036	0,050	0,061	0,070	0,087	0,095	0,101	
	2	1,5 x D	0,3 x D	0,5 x D	60 – 80	fz	0,005	0,007	0,009	0,012	0,014	0,017	0,019	0,022	0,024	0,029	0,040	0,048	0,056	0,070	0,076	0,081	
	3	1,5 x D	0,3 x D	0,5 x D	60 – 70	fz	0,004	0,006	0,008	0,010	0,012	0,014	0,016	0,018	0,020	0,025	0,034	0,040	0,047	0,057	0,061	0,065	
K	1	1,5 x D	0,3 x D	0,5 x D	120 – 150	fz	0,007	0,010	0,014	0,017	0,021	0,025	0,028	0,032	0,036	0,044	0,060	0,072	0,083	0,101	0,108	0,114	
	2	1,5 x D	0,3 x D	0,5 x D	110 – 140	fz	0,006	0,008	0,011	0,014	0,017	0,020	0,023	0,027	0,030	0,036	0,050	0,061	0,070	0,087	0,095	0,101	
	3	1,5 x D	0,3 x D	0,5 x D	110 – 130	fz	0,005	0,007	0,009	0,012	0,014	0,017	0,019	0,022	0,024	0,029	0,040	0,048	0,056	0,070	0,076	0,081	
S	1	1,5 x D	0,3 x D	0,3 x D	50 – 90	fz	0,006	0,008	0,011	0,014	0,017	0,020	0,023	0,027	0,030	0,036	0,050	0,061	0,070	0,087	0,095	0,101	
	2	1,5 x D	0,3 x D	0,3 x D	25 – 40	fz	0,003	0,005	0,006	0,008	0,009	0,011	0,013	0,014	0,016	0,019	0,026	0,032	0,037	0,046	0,050	0,054	
	3	1,5 x D	0,3 x D	0,5 x D	60 – 80	fz	0,005	0,007	0,009	0,012	0,014	0,017	0,019	0,022	0,024	0,029	0,040	0,048	0,056	0,070	0,076	0,081	
	4	1,5 x D	0,3 x D	0,5 x D	50 – 60	fz	0,003	0,005	0,007	0,009	0,011	0,014	0,016	0,018	0,021	0,026	0,037	0,045	0,052	0,064	0,069	0,074	
H	1	1,5 x D	0,3 x D	0,3 x D	80 – 140	fz	0,005	0,008	0,010	0,013	0,016	0,019	0,021	0,024	0,027	0,033	0,045	0,054	0,062	0,077	0,083	0,088	

NOTE: Lower value of cutting speed is used for high stock removal applications or for higher hardness (machinability) within group.
Higher value of cutting speed is used for finishing applications or for lower hardness (machinability) within group.
Above parameters are based on ideal conditions. For smaller taper machining centres, please adjust parameters accordingly on >12mm diameters.

High-Performance Solid Carbide End Mills • Finishing

Application Data • Series 022801 022804 322801 322804 422801 022806 022802
322806 322802 422802



Series 022801 022804 322801 322804 422801 022806 022802 322806 322802 422802

Material Group	ap		ae		Side Milling (A) and Slotting (B)										Recommended feed per tooth (fz = mm/th) for side milling (A). For slotting (B), reduce fz by 20%.									
	A		B		K30F		K30F-TiCN		K30F-DCF		D1 – Diameter													
	ap	ae	ap	ae	Cutting Speed – vc m/min		Cutting Speed – vc m/min		Cutting Speed – vc m/min		mm	2,0	3,0	4,0	5,0	6,0	7,0	8,0	9,0	10,0	12,0	16,0	18,0	20,0
	min	max	min	max	min	max	min	max	min	max	mm	2,0	3,0	4,0	5,0	6,0	7,0	8,0	9,0	10,0	12,0	16,0	18,0	20,0
P	0	0,75 x D	0,4 x D	0,5 x D	60	80	120	160	150	200	fz	0,011	0,017	0,023	0,029	0,035	0,041	0,048	0,053	0,058	0,066	0,081	0,086	0,091
	1	0,75 x D	0,4 x D	0,5 x D	60	80	120	160	150	200	fz	0,011	0,017	0,023	0,029	0,035	0,041	0,048	0,053	0,058	0,066	0,081	0,086	0,091
	2	0,75 x D	0,4 x D	0,5 x D	56	76	112	152	140	190	fz	0,011	0,017	0,023	0,029	0,035	0,041	0,048	0,053	0,058	0,066	0,081	0,086	0,091
	3	0,75 x D	0,4 x D	0,5 x D	48	64	96	128	120	160	fz	0,009	0,014	0,019	0,024	0,029	0,034	0,040	0,044	0,048	0,056	0,070	0,076	0,081
	4	0,75 x D	0,4 x D	0,3 x D	-	-	-	72	90	150	fz	0,008	0,013	0,017	0,022	0,026	0,031	0,036	0,040	0,043	0,050	0,061	0,066	0,070
	5	0,75 x D	0,4 x D	0,5 x D	-	-	-	48	60	100	fz	0,008	0,011	0,015	0,019	0,024	0,028	0,032	0,035	0,039	0,045	0,056	0,060	0,065
M	1	0,75 x D	0,4 x D	0,5 x D	36	46	72	92	90	115	fz	0,009	0,014	0,019	0,024	0,029	0,034	0,040	0,044	0,048	0,056	0,070	0,076	0,081
	2	0,75 x D	0,4 x D	0,5 x D	-	-	-	48	60	80	fz	0,008	0,011	0,015	0,019	0,024	0,028	0,032	0,035	0,039	0,045	0,056	0,060	0,065
	3	0,75 x D	0,4 x D	0,5 x D	-	-	-	48	56	70	fz	0,006	0,010	0,013	0,016	0,020	0,023	0,027	0,030	0,032	0,037	0,046	0,049	0,052
K	1	0,75 x D	0,4 x D	0,5 x D	48	60	96	120	120	150	fz	0,011	0,017	0,023	0,029	0,035	0,041	0,048	0,053	0,058	0,066	0,081	0,086	0,091
	2	0,75 x D	0,4 x D	0,5 x D	-	-	-	88	110	140	fz	0,009	0,014	0,019	0,024	0,029	0,034	0,040	0,044	0,048	0,056	0,070	0,076	0,081
	3	0,75 x D	0,4 x D	0,5 x D	-	-	-	88	104	130	fz	0,008	0,011	0,015	0,019	0,024	0,028	0,032	0,035	0,039	0,045	0,056	0,060	0,065
S	1	0,75 x D	0,4 x D	0,3 x D	-	-	-	40	50	90	fz	0,009	0,014	0,019	0,024	0,029	0,034	0,040	0,044	0,048	0,056	0,070	0,076	0,081
	2	0,75 x D	0,4 x D	0,3 x D	-	-	-	20	25	40	fz	0,005	0,008	0,010	0,013	0,016	0,018	0,021	0,023	0,026	0,030	0,037	0,040	0,043
	3	0,75 x D	0,4 x D	0,3 x D	-	-	-	48	60	80	fz	0,008	0,011	0,015	0,019	0,024	0,028	0,032	0,035	0,039	0,045	0,056	0,060	0,065
	4	0,75 x D	0,4 x D	0,5 x D	-	-	-	40	50	60	fz	0,006	0,009	0,013	0,016	0,021	0,025	0,029	0,033	0,036	0,041	0,051	0,056	0,059
H	1	0,75 x D	0,4 x D	0,3 x D	-	-	-	64	80	140	fz	0,008	0,013	0,017	0,022	0,026	0,031	0,036	0,040	0,043	0,050	0,061	0,066	0,070

Material Group	ap		ae		Side Milling (A) and Slotting (B)										Recommended feed per tooth (fz = mm/th) for side milling (A). For slotting (B), reduce fz by 20%.									
	A		B		K30F		K30F-TiCN		K30F-DCF		D1 – Diameter													
	ap	ae	ap	ae	Cutting Speed – vc m/min		Cutting Speed – vc m/min		Cutting Speed – vc m/min		mm	2,0	3,0	4,0	5,0	6,0	8,0	10,0	12,0	16,0	18,0	20,0		
	min	max	min	max	min	max	min	max	min	max	mm	2,0	3,0	4,0	5,0	6,0	8,0	10,0	12,0	16,0	18,0	20,0		
P	0	1,5 x D	0,3 x D	0,5 x D	60	80	120	160	150	200	fz	0,011	0,017	0,023	0,029	0,035	0,048	0,058	0,066	0,081	0,086	0,091		
	1	1,5 x D	0,3 x D	0,5 x D	60	80	120	160	150	200	fz	0,011	0,017	0,023	0,029	0,035	0,048	0,058	0,066	0,081	0,086	0,091		
	2	1,5 x D	0,3 x D	0,5 x D	56	76	112	152	140	190	fz	0,011	0,017	0,023	0,029	0,035	0,048	0,058	0,066	0,081	0,086	0,091		
	3	1,5 x D	0,3 x D	0,5 x D	48	64	96	128	120	160	fz	0,009	0,014	0,019	0,024	0,029	0,040	0,048	0,056	0,070	0,076	0,081		
	4	1,5 x D	0,3 x D	0,3 x D	-	-	-	72	90	150	fz	0,008	0,013	0,017	0,022	0,026	0,036	0,043	0,050	0,061	0,066	0,070		
	5	1,5 x D	0,3 x D	0,5 x D	-	-	-	48	60	100	fz	0,008	0,011	0,015	0,019	0,024	0,032	0,039	0,045	0,056	0,060	0,065		
M	1	1,5 x D	0,3 x D	0,5 x D	36	46	72	92	90	115	fz	0,009	0,014	0,019	0,024	0,029	0,040	0,048	0,056	0,070	0,076	0,081		
	2	1,5 x D	0,3 x D	0,5 x D	-	-	-	48	60	80	fz	0,008	0,011	0,015	0,019	0,024	0,032	0,039	0,045	0,056	0,060	0,065		
	3	1,5 x D	0,3 x D	0,5 x D	-	-	-	48	56	70	fz	0,006	0,010	0,013	0,016	0,020	0,027	0,032	0,037	0,046	0,049	0,052		
K	1	1,5 x D	0,3 x D	0,5 x D	48	60	96	120	120	150	fz	0,011	0,017	0,023	0,029	0,035	0,048	0,058	0,066	0,081	0,086	0,091		
	2	1,5 x D	0,3 x D	0,5 x D	-	-	-	88	110	140	fz	0,009	0,014	0,019	0,024	0,029	0,040	0,048	0,056	0,070	0,076	0,081		
	3	1,5 x D	0,3 x D	0,5 x D	-	-	-	88	104	130	fz	0,008	0,011	0,015	0,019	0,024	0,032	0,039	0,045	0,056	0,060	0,065		
S	1	1,5 x D	0,3 x D	0,3 x D	-	-	-	40	50	90	fz	0,009	0,014	0,019	0,024	0,029	0,040	0,048	0,056	0,070	0,076	0,081		
	2	1,5 x D	0,3 x D	0,3 x D	-	-	-	20	25	40	fz	0,005	0,008	0,010	0,013	0,016	0,021	0,026	0,030	0,037	0,040	0,043		
	3	1,5 x D	0,3 x D	0,3 x D	-	-	-	48	60	80	fz	0,008	0,011	0,015	0,019	0,024	0,032	0,039	0,045	0,056	0,060	0,065		
	4	1,5 x D	0,3 x D	0,5 x D	-	-	-	40	50	60	fz	0,006	0,009	0,013	0,016	0,021	0,029	0,036	0,041	0,051	0,056	0,059		
H	1	1,5 x D	0,3 x D	0,3 x D	-	-	-	80	80	140	fz	0,008	0,013	0,017	0,022	0,026	0,036	0,043	0,050	0,061	0,066	0,070		

NOTE: Lower value of cutting speed is used for high stock removal applications or for higher hardness (machinability) within group.
Higher value of cutting speed is used for finishing applications or for lower hardness (machinability) within group.
Above parameters are based on ideal conditions. For smaller taper machining centres, please adjust parameters accordingly on >12mm diameters.

■ Series 4603

Material Group	Side Milling (A) and Slotting (B)			TiAlN		Recommended feed per tooth (fz = mm/th) for side milling (A). For slotting (B), reduce fz by 20%.												
	A		B	Cutting Speed – vc m/min		D1 – Diameter												
	ap	ae	ap	min	max	mm	3,0	4,0	5,0	6,0	8,0	10,0	12,0	16,0	18,0	20,0		
P	0	1,5 x D	0,3 x D	0,5 x D	150	–	200	fz	0,017	0,023	0,029	0,035	0,048	0,058	0,066	0,081	0,086	0,091
	1	1,5 x D	0,3 x D	0,5 x D	150	–	200	fz	0,017	0,023	0,029	0,035	0,048	0,058	0,066	0,081	0,086	0,091
	2	1,5 x D	0,3 x D	0,5 x D	140	–	190	fz	0,017	0,023	0,029	0,035	0,048	0,058	0,066	0,081	0,086	0,091
	3	1,5 x D	0,3 x D	0,5 x D	120	–	160	fz	0,014	0,019	0,024	0,029	0,040	0,048	0,056	0,070	0,076	0,081
	4	1,5 x D	0,3 x D	0,3 x D	90	–	150	fz	0,013	0,017	0,022	0,026	0,036	0,043	0,050	0,061	0,066	0,070
	5	1,5 x D	0,3 x D	0,5 x D	60	–	100	fz	0,011	0,015	0,019	0,024	0,032	0,039	0,045	0,056	0,060	0,065
M	1	1,5 x D	0,3 x D	0,5 x D	90	–	115	fz	0,014	0,019	0,024	0,029	0,040	0,048	0,056	0,070	0,076	0,081
	2	1,5 x D	0,3 x D	0,5 x D	60	–	80	fz	0,011	0,015	0,019	0,024	0,032	0,039	0,045	0,056	0,060	0,065
	3	1,5 x D	0,3 x D	0,5 x D	60	–	70	fz	0,010	0,013	0,016	0,020	0,027	0,032	0,037	0,046	0,049	0,052
K	1	1,5 x D	0,3 x D	0,5 x D	120	–	150	fz	0,017	0,023	0,029	0,035	0,048	0,058	0,066	0,081	0,086	0,091
	2	1,5 x D	0,3 x D	0,5 x D	110	–	140	fz	0,014	0,019	0,024	0,029	0,040	0,048	0,056	0,070	0,076	0,081
	3	1,5 x D	0,3 x D	0,5 x D	110	–	130	fz	0,011	0,015	0,019	0,024	0,032	0,039	0,045	0,056	0,060	0,065
S	1	1,5 x D	0,3 x D	0,3 x D	50	–	90	fz	0,014	0,019	0,024	0,029	0,040	0,048	0,056	0,070	0,076	0,081
	2	1,5 x D	0,3 x D	0,3 x D	25	–	40	fz	0,008	0,010	0,013	0,016	0,021	0,026	0,030	0,037	0,040	0,043
	3	1,5 x D	0,3 x D	0,3 x D	60	–	80	fz	0,011	0,015	0,019	0,024	0,032	0,039	0,045	0,056	0,060	0,065
	4	1,5 x D	0,3 x D	0,5 x D	50	–	60	fz	0,009	0,013	0,016	0,021	0,029	0,036	0,041	0,051	0,056	0,059
H	1	1,5 x D	0,3 x D	0,3 x D	80	–	140	fz	0,013	0,017	0,022	0,026	0,036	0,043	0,050	0,061	0,066	0,070

NOTE: Lower value of cutting speed is used for high stock removal applications or for higher hardness (machinability) within group.
Higher value of cutting speed is used for finishing applications or for lower hardness (machinability) within group.
Above parameters are based on ideal conditions. For smaller taper machining centres, please adjust parameters accordingly on >12mm diameters.

Series D507 • Victory Grades



Material Group		Side Milling (A)		WP15PE			Recommended feed per tooth (fz = mm/th) for side milling (A).									
		A		Cutting Speed – vc m/min			D1 – Diameter									
		ap	ae	min	–	max	mm	4,0	6,0	8,0	10,0	12,0	14,0	16,0	18,0	20,0
P	0	1,0 x D	0,2 x D	150	–	200	fz	0,028	0,044	0,060	0,072	0,083	0,092	0,101	0,108	0,114
	1	1,0 x D	0,2 x D	150	–	200	fz	0,028	0,044	0,060	0,072	0,083	0,092	0,101	0,108	0,114
	2	1,0 x D	0,2 x D	140	–	190	fz	0,028	0,044	0,060	0,072	0,083	0,092	0,101	0,108	0,114
	3	1,0 x D	0,1 x D	120	–	160	fz	0,023	0,036	0,050	0,061	0,070	0,079	0,087	0,095	0,101
	4	1,0 x D	0,1 x D	90	–	150	fz	0,021	0,033	0,045	0,054	0,062	0,070	0,077	0,083	0,088
	5	1,0 x D	0,1 x D	60	–	100	fz	0,019	0,029	0,040	0,048	0,056	0,063	0,070	0,076	0,081
	6	1,0 x D	0,1 x D	50	–	75	fz	0,016	0,025	0,034	0,040	0,047	0,052	0,057	0,061	0,065
M	1	1,0 x D	0,1 x D	90	–	115	fz	0,023	0,036	0,050	0,061	0,070	0,079	0,087	0,095	0,101
	2	1,0 x D	0,1 x D	60	–	80	fz	0,019	0,029	0,040	0,048	0,056	0,063	0,070	0,076	0,081
	3	1,0 x D	0,1 x D	60	–	70	fz	0,016	0,025	0,034	0,040	0,047	0,052	0,057	0,061	0,065
K	1	1,0 x D	0,1 x D	120	–	150	fz	0,028	0,044	0,060	0,072	0,083	0,092	0,101	0,108	0,114
	2	1,0 x D	0,1 x D	110	–	140	fz	0,023	0,036	0,050	0,061	0,070	0,079	0,087	0,095	0,101
	3	1,0 x D	0,1 x D	110	–	130	fz	0,019	0,029	0,040	0,048	0,056	0,063	0,070	0,076	0,081
S	1	1,0 x D	0,1 x D	50	–	90	fz	0,023	0,036	0,050	0,061	0,070	0,079	0,087	0,095	0,101
	2	1,0 x D	0,1 x D	25	–	40	fz	0,013	0,019	0,026	0,032	0,037	0,042	0,046	0,050	0,054
	3	1,0 x D	0,15 x D	60	–	80	fz	0,019	0,029	0,040	0,048	0,056	0,063	0,070	0,076	0,081
	4	1,0 x D	0,15 x D	50	–	60	fz	0,016	0,026	0,037	0,045	0,052	0,058	0,064	0,069	0,074
H	1	1,0 x D	0,1 x D	80	–	140	fz	0,021	0,033	0,045	0,054	0,062	0,070	0,077	0,083	0,088

NOTE: Lower value of cutting speed is used for high stock removal applications or for higher hardness (machinability) within group.
Higher value of cutting speed is used for finishing applications or for lower hardness (machinability) within group.

■ Series D517 • Victory Grades



Material Group																
	Side Milling (A)		WP15PE			Recommended feed per tooth (fz = mm/th) for side milling (A).										
	A		Cutting Speed – vc m/min			D1 – Diameter										
	ap	ae	min		max	mm	4,0	6,0	8,0	10,0	12,0	14,0	16,0	18,0	20,0	
P	0	Ap1 max	0,05 x D	150	–	200	fz	0,028	0,044	0,060	0,072	0,083	0,092	0,101	0,108	0,114
	1	Ap1 max	0,05 x D	150	–	200	fz	0,028	0,044	0,060	0,072	0,083	0,092	0,101	0,108	0,114
	2	Ap1 max	0,05 x D	140	–	190	fz	0,028	0,044	0,060	0,072	0,083	0,092	0,101	0,108	0,114
	3	Ap1 max	0,05 x D	120	–	160	fz	0,023	0,036	0,050	0,061	0,070	0,079	0,087	0,095	0,101
	4	Ap1 max	0,05 x D	90	–	150	fz	0,021	0,033	0,045	0,054	0,062	0,070	0,077	0,083	0,088
	5	Ap1 max	0,05 x D	60	–	100	fz	0,019	0,029	0,040	0,048	0,056	0,063	0,070	0,076	0,081
M	6	Ap1 max	0,05 x D	50	–	75	fz	0,016	0,025	0,034	0,040	0,047	0,052	0,057	0,061	0,065
	1	Ap1 max	0,05 x D	90	–	115	fz	0,023	0,036	0,050	0,061	0,070	0,079	0,087	0,095	0,101
	2	Ap1 max	0,05 x D	60	–	80	fz	0,019	0,029	0,040	0,048	0,056	0,063	0,070	0,076	0,081
K	3	Ap1 max	0,05 x D	60	–	70	fz	0,016	0,025	0,034	0,040	0,047	0,052	0,057	0,061	0,065
	1	Ap1 max	0,05 x D	120	–	150	fz	0,028	0,044	0,060	0,072	0,083	0,092	0,101	0,108	0,114
	2	Ap1 max	0,05 x D	110	–	140	fz	0,023	0,036	0,050	0,061	0,070	0,079	0,087	0,095	0,101
S	3	Ap1 max	0,05 x D	110	–	130	fz	0,019	0,029	0,040	0,048	0,056	0,063	0,070	0,076	0,081
	1	Ap1 max	0,04 x D	50	–	90	fz	0,023	0,036	0,050	0,061	0,070	0,079	0,087	0,095	0,101
	2	Ap1 max	0,04 x D	25	–	40	fz	0,013	0,019	0,026	0,032	0,037	0,042	0,046	0,050	0,054
	3	Ap1 max	0,05 x D	60	–	80	fz	0,019	0,029	0,040	0,048	0,056	0,063	0,070	0,076	0,081
H	4	Ap1 max	0,05 x D	50	–	60	fz	0,016	0,026	0,037	0,045	0,052	0,058	0,064	0,069	0,074
	1	Ap1 max	0,04 x D	80	–	140	fz	0,021	0,033	0,045	0,054	0,062	0,070	0,077	0,083	0,088

NOTE: Lower value of cutting speed is used for high stock removal applications or for higher hardness (machinability) within group.
Higher value of cutting speed is used for finishing applications or for lower hardness (machinability) within group.
For better surface finish, reduce feed per tooth.

■ Series 422822 422826

Material Group																
	Side Milling (A) and Slotting (B)		K30F-DCF			Recommended feed per tooth (fz = mm/th) for side milling (A). For slotting (B), reduce fz by 20%.										
			AlTiN			mm	D1 – Diameter									
	A		Cutting Speed – vc m/min													
	ap	ae	min		max		6,0	8,0	10,0	12,0	14,0	16,0	18,0	20,0	25,0	
P	0	1,5 x D	0,05 x D	165	–	165	fz	0,044	0,060	0,072	0,083	0,092	0,101	0,108	0,114	0,124
	1	1,5 x D	0,05 x D	165	–	165	fz	0,044	0,060	0,072	0,083	0,092	0,101	0,108	0,114	0,124
	2	1,5 x D	0,05 x D	154	–	154	fz	0,044	0,060	0,072	0,083	0,092	0,101	0,108	0,114	0,124
	3	1,5 x D	0,05 x D	132	–	132	fz	0,036	0,050	0,061	0,070	0,079	0,087	0,095	0,101	0,114
	4	1,5 x D	0,05 x D	99	–	99	fz	0,033	0,045	0,054	0,062	0,070	0,077	0,083	0,088	0,098
	5	1,5 x D	0,05 x D	66	–	66	fz	0,029	0,040	0,048	0,056	0,063	0,070	0,076	0,081	0,091
M	6	1,5 x D	0,04 x D	55	–	55	fz	0,025	0,034	0,040	0,047	0,052	0,057	0,061	0,065	0,071
	1	1,5 x D	0,05 x D	99	–	99	fz	0,036	0,050	0,061	0,070	0,079	0,087	0,095	0,101	0,114
	2	1,5 x D	0,05 x D	66	–	66	fz	0,029	0,040	0,048	0,056	0,063	0,070	0,076	0,081	0,091
K	3	1,5 x D	0,05 x D	66	–	66	fz	0,025	0,034	0,040	0,047	0,052	0,057	0,061	0,065	0,071
	1	1,5 x D	0,05 x D	132	–	132	fz	0,044	0,060	0,072	0,083	0,092	0,101	0,108	0,114	0,124
	2	1,5 x D	0,05 x D	121	–	121	fz	0,036	0,050	0,061	0,070	0,079	0,087	0,095	0,101	0,114
N	3	1,5 x D	0,05 x D	121	–	121	fz	0,029	0,040	0,048	0,056	0,063	0,070	0,076	0,081	0,091
	1	1,5 x D	0,05 x D	275	–	275	fz	0,054	0,072	0,090	0,108	0,126	0,144	0,162	0,180	0,225
S	1	1,5 x D	0,04 x D	55	–	55	fz	0,036	0,050	0,061	0,070	0,079	0,087	0,095	0,101	0,114
	2	1,5 x D	0,04 x D	27.5	–	27.5	fz	0,019	0,026	0,032	0,037	0,042	0,046	0,050	0,054	0,061
	3	1,5 x D	0,05 x D	66	–	66	fz	0,029	0,040	0,048	0,056	0,063	0,070	0,076	0,081	0,091
	4	1,5 x D	0,05 x D	55	–	55	fz	0,026	0,037	0,045	0,052	0,058	0,064	0,069	0,074	0,084
H	1	1,5 x D	0,04 x D	88	–	88	fz	0,033	0,045	0,054	0,062	0,070	0,077	0,083	0,088	0,098

NOTE: Lower value of cutting speed is used for high stock removal applications or for higher hardness (machinability) within group.
Higher value of cutting speed is used for finishing applications or for lower hardness (machinability) within group.
Above parameters are based on ideal conditions. For smaller taper machining centres, please adjust parameters accordingly on >12mm diameters.

High-Performance Solid Carbide End Mills

■ Series 422827 • Vision Plus



Material Group														
				K30F-DCHP			Recommended feed per tooth (fz = mm/th) for side milling (A).							
		Side Milling (A)		AlTiN										
		A		Cutting Speed – vc m/min			D1 – Diameter							
		ap	ae	min		max	mm	6,0	8,0	10,0	12,0	16,0	20,0	25,0
P	1	3 x D	0,05 x D	150	–	200	fz	0,044	0,060	0,072	0,083	0,101	0,114	0,124
	2	3 x D	0,05 x D	140	–	190	fz	0,044	0,060	0,072	0,083	0,101	0,114	0,124
	3	3 x D	0,05 x D	120	–	160	fz	0,036	0,050	0,061	0,070	0,087	0,101	0,114
	4	3 x D	0,05 x D	90	–	150	fz	0,033	0,045	0,054	0,062	0,077	0,088	0,098
	5	3 x D	0,05 x D	60	–	100	fz	0,029	0,040	0,048	0,056	0,070	0,081	0,091
	6	3 x D	0,05 x D	50	–	75	fz	0,025	0,034	0,040	0,047	0,057	0,065	0,071
M	1	3 x D	0,05 x D	80	–	100	fz	0,036	0,050	0,061	0,070	0,087	0,101	0,114
	2	3 x D	0,05 x D	60	–	80	fz	0,029	0,040	0,048	0,056	0,070	0,081	0,091
	3	3 x D	0,05 x D	60	–	80	fz	0,025	0,034	0,040	0,047	0,057	0,065	0,071
K	1	3 x D	0,05 x D	120	–	160	fz	0,044	0,060	0,072	0,083	0,101	0,114	0,124
	2	3 x D	0,05 x D	110	–	140	fz	0,036	0,050	0,061	0,070	0,087	0,101	0,114
	3	3 x D	0,05 x D	100	–	130	fz	0,029	0,040	0,048	0,056	0,070	0,081	0,091
S	1	3 x D	0,05 x D	90	–	115	fz	0,036	0,050	0,061	0,070	0,087	0,101	0,114
	2	3 x D	0,05 x D	20	–	40	fz	0,019	0,026	0,032	0,037	0,046	0,054	0,061
	3	3 x D	0,05 x D	50	–	80	fz	0,029	0,040	0,048	0,056	0,070	0,081	0,091
	4	3 x D	0,05 x D	45	–	65	fz	0,026	0,037	0,045	0,052	0,064	0,074	0,084
H	1	3 x D	0,05 x D	100	–	140	fz	0,033	0,045	0,054	0,062	0,077	0,088	0,098

NOTE: Lower value of cutting speed is used for high-stock removal applications or for higher hardness (machinability) within group.
Higher value of cutting speed is used for finishing applications or for lower hardness (machinability) within group.
For better surface finish, reduce feed per tooth.
Above parameters are based on ideal conditions. For smaller taper machining centres, please adjust parameters accordingly on >12mm diameters.

■ Series D518 • Vision Plus • Victory Grades





Material Group																						
		Side Milling (A)		WP15PE		Recommended feed per tooth (fz = mm/th) for side milling (A).																
		A		Cutting Speed – vc m/min		mm	D1 – Diameter															
		ap	ae	min	max		4,0	5,0	6,0	7,0	8,0	9,0	10,0	12,0	14,0	16,0	18,0	20,0	25,0			
P	0	Ap1 max	0,05 x D	150	–	200	fz	0,028	0,036	0,044	0,052	0,060	0,066	0,072	0,083	0,092	0,101	0,108	0,114	0,124		
	1	Ap1 max	0,05 x D	150	–	200	fz	0,028	0,036	0,044	0,052	0,060	0,066	0,072	0,083	0,092	0,101	0,108	0,114	0,124		
	2	Ap1 max	0,05 x D	140	–	190	fz	0,028	0,036	0,044	0,052	0,060	0,066	0,072	0,083	0,092	0,101	0,108	0,114	0,124		
	3	Ap1 max	0,05 x D	120	–	160	fz	0,023	0,030	0,036	0,043	0,050	0,055	0,061	0,070	0,079	0,087	0,095	0,101	0,114		
	4	Ap1 max	0,05 x D	90	–	150	fz	0,021	0,027	0,033	0,039	0,045	0,050	0,054	0,062	0,070	0,077	0,083	0,088	0,098		
	5	Ap1 max	0,05 x D	60	–	100	fz	0,019	0,024	0,029	0,035	0,040	0,044	0,048	0,056	0,063	0,070	0,076	0,081	0,091		
M	6	Ap1 max	0,04 x D	50	–	75	fz	0,016	0,020	0,025	0,029	0,034	0,037	0,040	0,047	0,052	0,057	0,061	0,065	0,071		
	1	Ap1 max	0,05 x D	90	–	115	fz	0,023	0,030	0,036	0,043	0,050	0,055	0,061	0,070	0,079	0,087	0,095	0,101	0,114		
	2	Ap1 max	0,05 x D	60	–	80	fz	0,019	0,024	0,029	0,035	0,040	0,044	0,048	0,056	0,063	0,070	0,076	0,081	0,091		
K	3	Ap1 max	0,05 x D	60	–	70	fz	0,016	0,020	0,025	0,029	0,034	0,037	0,040	0,047	0,052	0,057	0,061	0,065	0,071		
	1	Ap1 max	0,05 x D	120	–	150	fz	0,028	0,036	0,044	0,052	0,060	0,066	0,072	0,083	0,092	0,101	0,108	0,114	0,124		
	2	Ap1 max	0,05 x D	110	–	140	fz	0,023	0,030	0,036	0,043	0,050	0,055	0,061	0,070	0,079	0,087	0,095	0,101	0,114		
S	3	Ap1 max	0,05 x D	110	–	130	fz	0,019	0,024	0,029	0,035	0,040	0,044	0,048	0,056	0,063	0,070	0,076	0,081	0,091		
	1	Ap1 max	0,04 x D	50	–	90	fz	0,023	0,030	0,036	0,043	0,050	0,055	0,061	0,070	0,079	0,087	0,095	0,101	0,114		
	2	Ap1 max	0,04 x D	25	–	40	fz	0,013	0,016	0,019	0,023	0,026	0,029	0,032	0,037	0,042	0,046	0,050	0,054	0,061		
	3	Ap1 max	0,05 x D	60	–	80	fz	0,019	0,024	0,029	0,035	0,040	0,044	0,048	0,056	0,063	0,070	0,076	0,081	0,091		
H	4	Ap1 max	0,05 x D	50	–	60	fz	0,016	0,021	0,026	0,031	0,037	0,041	0,045	0,052	0,058	0,064	0,069	0,074	0,084		
	1	Ap1 max	0,04 x D	80	–	140	fz	0,021	0,027	0,033	0,039	0,045	0,050	0,054	0,062	0,070	0,077	0,083	0,088	0,098		
	2	Ap1 max	0,05 x D	70	–	120	fz	0,016	0,020	0,025	0,029	0,034	0,037	0,040	0,047	0,052	0,057	0,061	0,065	0,071		

NOTE: Lower value of cutting speed is used for high stock removal applications or for higher hardness (machinability) within group.
 Higher value of cutting speed is used for finishing applications or for lower hardness (machinability) within group.
 For better surface finish, reduce feed per tooth.



High-Performance Solid Carbide End Mills

■ Series 026621 • Cermet End Mill

Material Group															
	Side Milling (A)			Cermet			Recommended feed per tooth (fz = mm/th) for side milling (A).								
	A		Cutting Speed – vc m/min	mm	D1 – Diameter										
	ap	ae			min	–	max	6,0	8,0	10,0	12,0	14,0	16,0	18,0	20,0
P	0	Ap1 max	0,05 x D	225	–	300	fz	0,044	0,060	0,072	0,083	0,092	0,101	0,108	0,114
	1	Ap1 max	0,05 x D	225	–	300	fz	0,044	0,060	0,072	0,083	0,092	0,101	0,108	0,114
	2	Ap1 max	0,05 x D	210	–	285	fz	0,044	0,060	0,072	0,083	0,092	0,101	0,108	0,114
	3	Ap1 max	0,05 x D	180	–	240	fz	0,036	0,050	0,061	0,070	0,079	0,087	0,095	0,101
	4	Ap1 max	0,05 x D	135	–	225	fz	0,033	0,045	0,054	0,062	0,070	0,077	0,083	0,088
	5	Ap1 max	0,05 x D	90	–	150	fz	0,029	0,040	0,048	0,056	0,063	0,070	0,076	0,081
M	1	Ap1 max	0,05 x D	135	–	172,5	fz	0,036	0,050	0,061	0,070	0,079	0,087	0,095	0,101
	2	Ap1 max	0,05 x D	90	–	120	fz	0,029	0,040	0,048	0,056	0,063	0,070	0,076	0,081
	3	Ap1 max	0,05 x D	90	–	105	fz	0,025	0,034	0,040	0,047	0,052	0,057	0,061	0,065
K	1	Ap1 max	0,05 x D	180	–	225	fz	0,044	0,060	0,072	0,083	0,092	0,101	0,108	0,114
	2	Ap1 max	0,05 x D	165	–	210	fz	0,036	0,050	0,061	0,070	0,079	0,087	0,095	0,101
	3	Ap1 max	0,05 x D	165	–	195	fz	0,029	0,040	0,048	0,056	0,063	0,070	0,076	0,081
N	1	Ap1 max	0,05 x D	750	–	3000	fz	0,060	0,080	0,100	0,120	0,140	0,160	0,180	0,200
	2	Ap1 max	0,05 x D	750	–	2250	fz	0,054	0,072	0,090	0,108	0,126	0,144	0,162	0,180
	3	Ap1 max	0,05 x D	750	–	2250	fz	0,042	0,056	0,070	0,084	0,098	0,112	0,126	0,140
	4	Ap1 max	0,05 x D	600	–	1125	fz	0,048	0,064	0,080	0,096	0,112	0,128	0,144	0,160
	5	Ap1 max	0,05 x D	375	–	1500	fz	0,054	0,072	0,090	0,108	0,126	0,144	0,162	0,180
	6	Ap1 max	0,05 x D	150	–	1125	fz	0,060	0,080	0,100	0,120	0,140	0,160	0,180	0,200
	7	Ap1 max	0,05 x D	150	–	1125	fz	0,042	0,056	0,070	0,084	0,098	0,112	0,126	0,140
H	1	Ap1 max	0,04 x D	120	–	210	fz	0,033	0,045	0,054	0,062	0,070	0,077	0,083	0,088
	2	Ap1 max	0,05 x D	105	–	180	fz	0,025	0,034	0,040	0,047	0,052	0,057	0,061	0,065



NOTE: No slotting for tools with 8 flutes; for 6 flutes ap 0,15 x D.
Above parameters are based on ideal conditions. For smaller taper machining centres, please adjust parameters accordingly on >12mm diameters.

■ Series 024112

Material Group													
	Side Milling (A) and Slotting (B)				K10F-DIA			Recommended feed per tooth (fz = mm/th) for side milling (A). For slotting (B), reduce fz by 20%.					
	A		B	Cutting Speed – vc m/min			mm	D1 – Diameter					
	ap	ae	ap	min		max		4,0	6,0	8,0	10,0		
N	6	0,7 x D	0,5 x D	0,5 x D	100	–	750	fz	0,040	0,060	0,080	0,100	

NOTE: Lower value of cutting speed is used for high stock removal applications or for higher hardness (machinability) within group.
Higher value of cutting speed is used for finishing applications or for lower hardness (machinability) within group.

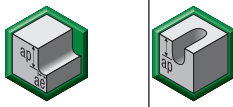
■ Series 024111

																		
		Side Milling (A) and Slotting (B)			uncoated			Recommended feed per tooth (fz = mm/th) for side milling (A). For slotting (B), reduce fz by 20%.										
Material Group		A		B	Cutting Speed – vc m/min			D1 – Diameter										
		ap	ae	ap	min		max	mm	2,0	3,0	4,0	5,0	6,0	8,0	10,0	12,0		
	N 6	0,7 x D	0,5 x D	0,5 x D	100	–	750	fz	0,020	0,030	0,040	0,050	0,060	0,080	0,100	0,120		

NOTE: Lower value of cutting speed is used for high stock removal applications or for higher hardness (machinability) within group.
Higher value of cutting speed is used for finishing applications or for lower hardness (machinability) within group.

Micro Solid Carbide End Mills

Micro Solid Carbide End Mills



Micro solid carbide end mills offer plunging, slotting, profiling, and 3D milling for a wide range of materials and applications. They are designed to provide efficient machining in a wide range of steel, cast iron, copper and copper alloys, and aluminium materials. Micro square and ball nose tools, designed for the most demanding end users, offer exceptional tool life and precision at high speeds and feeds.

- 2-flute ball nose and 2–3 flute cutters with sharp corner.
- Micro tools for a wide range of materials.
- Roughing and finishing in one tool.
- Diameter range from 0.4–3mm.

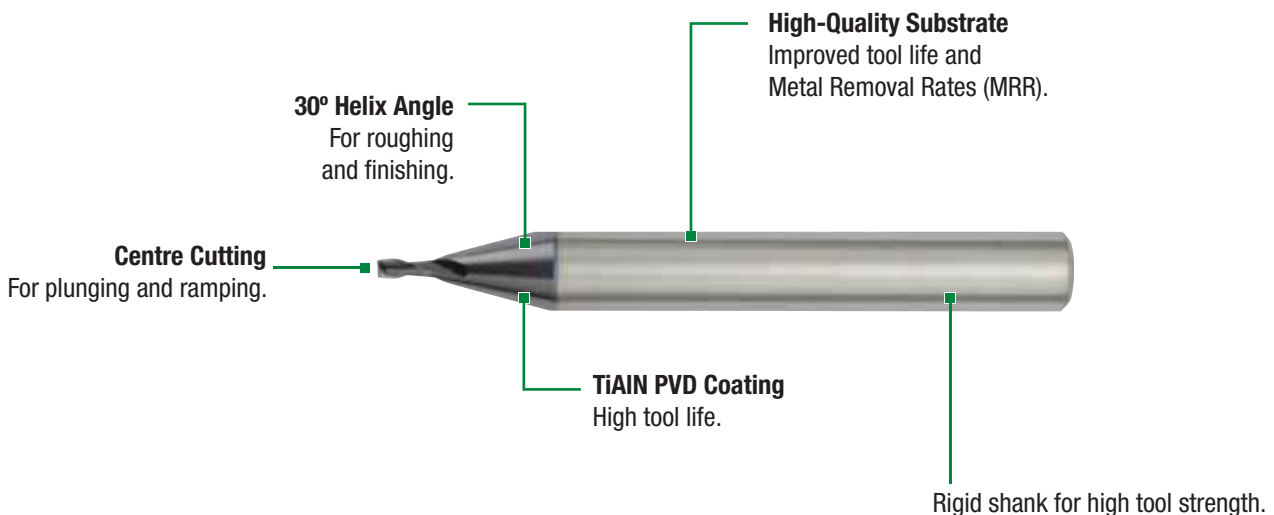

Micro Solid Carbide End Mills

- Increases your manufacturing flexibility and cost efficiency.
- Suitable for roughing and finishing.
- Rigid shank gives extra toughness and strength.

423007 023007 Series

- Diameter range 0,4–3,0mm.
- Steels, stainless steels, cast iron, and non-ferrous.
- Centre cut ball nose.
- Available coated and uncoated.



4633 Series

- Wide range of diameters from 0,4–3mm.
- Medium steel, aluminium, copper, and cast iron.
- Centre cut.
- Available coated and uncoated.
- Rigid shank gives extra toughness and strength.



4632 Series

- Wide range of diameters from 0,4–2mm.
- Medium steel, aluminium, copper, and cast iron.
- Centre cut.
- Available coated and uncoated.



4651 Series

- Ball nose tool in range of diameter from 1–2mm with 3mm shank.
- Medium steel, aluminium, copper, and cast iron.
- Centre cut ball nose.
- Available coated and uncoated.



- Centre cutting.
- Standard items listed. Additional styles and coatings made-to-order.

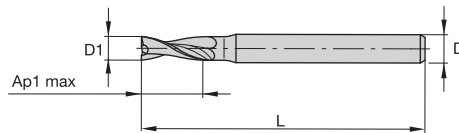

End Mill Tolerances

D1	tolerance h10 + / -	D	tolerance h6 + / -
≤ 3	0/-0,040	≤ 3	0/-0,006
> 3-6	0/-0,048	> 3-6	0/-0,008
> 6-10	0/-0,058	> 6-10	0/-0,009
> 10-18	0/-0,070	> 10-18	0/-0,011
> 18-30	0/-0,084	> 18-30	0/-0,013

■ Series 023007 423007

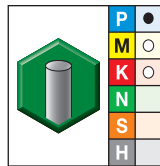

grade K30F uncoated

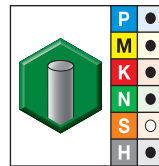

grade K30F-DCHP AlTiN

- first choice
- alternate choice

order #	catalogue #	order #	catalogue #	D1	D	length of cut Ap1 max	length L
2333055	023007-000004	2343368	423007-000004	0,4	3	0,80	38
2333056	023007-000005	2343370	423007-000005	0,5	3	1,00	38
2333057	023007-000006	2343372	423007-000006	0,6	3	1,20	38
2333058	023007-000008	2343374	423007-000008	0,8	3	1,60	38
2333060	023007-000010	2343376	423007-000010	1,0	3	2,00	38
2333061	023007-000012	2343378	423007-000012	1,2	3	2,40	38
2333064	023007-000015	2343380	423007-000015	1,5	3	3,00	38
2333067	023007-000018	2343382	423007-000018	1,8	3	3,60	38
2333069	023007-000020	2343384	423007-000020	2,0	3	6,00	38
2333070	023007-000025	2343386	423007-000025	2,5	3	7,00	38
2333071	023007-000030	2343388	423007-000030	3,0	3	7,00	38

- Centre cutting.
- Standard items listed. Additional styles and coatings made-to-order.

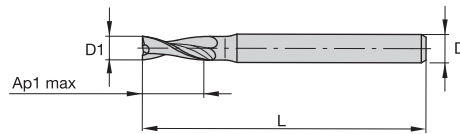

End Mill Tolerances

D1	tolerance e8	D	tolerance h6 + / -
≤ 3	-0,014/-0,028	≤ 3	0/0,006
> 3-6	-0,020/-0,038	> 3-6	0/0,008
> 6-10	-0,025/-0,047	> 6-10	0/0,009
> 10-18	-0,032/-0,059	> 10-18	0/0,011
> 18-30	-0,040/-0,073	> 18-30	0/0,013

■ Series 4632

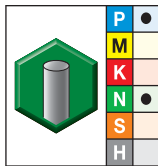

grade UNCOATED

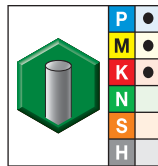

grade TiAlN-RT
TiAlN

- first choice
- alternate choice

order #	catalogue #	order #	catalogue #	D1	D	length of cut Ap1 max	length L
1656841	463200400..	1602266	463200400RT	0,4	3	1,50	38
1656844	463200500..	1602268	463200500RT	0,5	3	1,50	38
1656849	463200600..	1602270	463200600RT	0,6	3	1,50	38
1656853	463200800..	1602273	463200800RT	0,8	3	1,50	38
1656858	463201000..	1602274	463201000RT	1,0	3	2,00	38
1656863	463201500..	1602275	463201500RT	1,5	3	2,00	38
1656867	463202000..	-	-	2,0	3	8,00	38

High-Performance Solid Carbide End Mills

- Centre cutting.
- Standard items listed. Additional styles and coatings made-to-order.

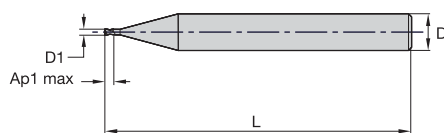

End Mill Tolerances

D1	tolerance e8	D	tolerance h6 + / -
≤ 3	-0,014/-0,028	≤ 3	0/0,006
> 3-6	-0,020/-0,038	> 3-6	0/0,008
> 6-10	-0,025/-0,047	> 6-10	0/0,009
> 10-18	-0,032/-0,059	> 10-18	0/0,011
> 18-30	-0,040/-0,073	> 18-30	0/0,013

■ Series 4633

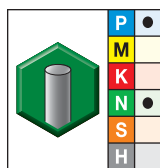

grade UNCOATED

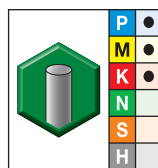

grade TiAlN-RT
TiAlN

- first choice
- alternate choice

order #	catalogue #	order #	catalogue #	D1	D	length of cut Ap1 max	length L
1656873	463300400..	1656875	463300400RT	0,4	3	1,50	38
1656878	463300500..	1656880	463300500RT	0,5	3	1,50	38
1656883	463300600..	1656885	463300600RT	0,6	3	1,50	38
1656888	463300800..	1656890	463300800RT	0,8	3	1,50	38
1656893	463301000..	1656895	463301000RT	1,0	3	2,00	38
1656898	463301200..	1656900	463301200RT	1,2	3	2,00	38
1656901	463301500..	1656903	463301500RT	1,5	3	2,00	38
1656906	463301800..	1656908	463301800RT	1,8	3	2,00	38
1656909	463302000..	1656910	463302000RT	2,0	3	8,00	38
—	—	1656913	463302500RT	2,5	3	9,00	38
—	—	1656916	463303000RT	3,0	3	12,00	38

- Centre cutting.
- Standard items listed. Additional styles and coatings made-to-order.

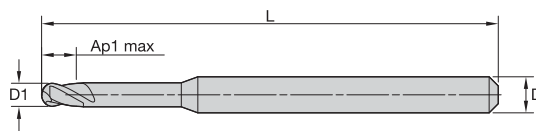

End Mill Tolerances

D1	tolerance e8	D	tolerance h6 + / -
≤ 3	-0,014/-0,028	≤ 3	0/0,006
> 3-6	-0,020/-0,038	> 3-6	0/0,008
> 6-10	-0,025/-0,047	> 6-10	0/0,009
> 10-18	-0,032/-0,059	> 10-18	0/0,011
> 18-30	-0,040/-0,073	> 18-30	0/0,013

■ Series 4651

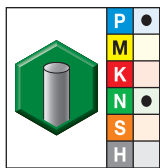

grade UNCOATED

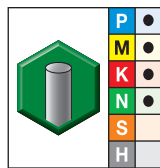

grade TiCN-CT
TiCN

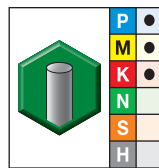

grade TiAlN-RT
TiAlN

- first choice
- alternate choice

order #	catalogue #	order #	catalogue #	order #	catalogue #	D1	D	length of cut Ap1 max	length L
1656950	465101000..	1656951	465101000CT	1611066	465101000RT	1,0	3	2,00	38
1656952	465101200..	1656953	465101200CT	1656954	465101200RT	1,2	3	2,00	38
1656955	465101500..	1656956	465101500CT	1656957	465101500RT	1,5	3	2,00	38
—	—	1656959	465101800CT	1656960	465101800RT	1,8	3	2,00	38
1656971	465102000..	1656972	465102000CT	1602538	465102000RT	2,0	3	2,00	38

High-Performance Solid Carbide End Mills



■ Series 023007 423007

Material Group																						
	Side Milling (A) and Slotting (B)			K30F uncoated		K30F - DCHP AlTiN		Recommended feed per tooth (fz = mm/th) for side milling (A). For slotting (B), reduce fz by 20%.														
	A		B	Cutting Speed – vc m/min		Cutting Speed – vc m/min		D1 – Diameter														
	ap	ae	ap	min	max	min	max	mm	0,4	0,5	0,6	0,8	1,0	1,2	1,5	1,8	2,0	2,5	3,0			
P	0	1 x D	0,1 x D	0,25 x D	75	–	100	150	–	200	fz	0,003	0,004	0,004	0,006	0,007	0,009	0,011	0,014	0,015	0,019	0,023
	1	1 x D	0,1 x D	0,25 x D	75	–	100	150	–	200	fz	0,003	0,004	0,004	0,006	0,007	0,009	0,011	0,014	0,015	0,019	0,023
	2	1 x D	0,1 x D	0,25 x D	70	–	95	140	–	190	fz	0,003	0,004	0,004	0,006	0,007	0,009	0,011	0,014	0,015	0,019	0,023
	3	1 x D	0,1 x D	0,25 x D	60	–	80	120	–	160	fz	0,002	0,003	0,004	0,005	0,006	0,007	0,009	0,011	0,012	0,016	0,019
	4	1 x D	0,1 x D	0,25 x D	–	–	–	90	–	150	fz	0,002	0,003	0,003	0,005	0,006	0,007	0,009	0,010	0,012	0,014	0,017
M	1	1 x D	0,1 x D	0,25 x D	45	–	57,5	90	–	115	fz	0,002	0,003	0,004	0,005	0,006	0,007	0,009	0,011	0,012	0,016	0,019
	2	1 x D	0,1 x D	0,25 x D	–	–	–	60	–	80	fz	0,002	0,003	0,003	0,004	0,005	0,006	0,008	0,009	0,010	0,013	0,016
K	1	1 x D	0,1 x D	0,25 x D	60	–	75	120	–	150	fz	0,003	0,004	0,004	0,006	0,007	0,009	0,011	0,014	0,015	0,019	0,023
	2	1 x D	0,1 x D	0,25 x D	–	–	–	110	–	140	fz	0,002	0,003	0,004	0,005	0,006	0,007	0,009	0,011	0,012	0,016	0,019
N	1	1 x D	0,1 x D	0,25 x D	250	–	1000	500	–	2000	fz	0,004	0,006	0,007	0,009	0,011	0,013	0,017	0,020	0,022	0,028	0,033
	2	1 x D	0,1 x D	0,25 x D	250	–	750	500	–	1500	fz	0,004	0,005	0,006	0,008	0,010	0,012	0,015	0,018	0,020	0,025	0,030
	5	1 x D	0,1 x D	0,25 x D	125	–	500	250	–	1000	fz	0,004	0,005	0,006	0,008	0,010	0,012	0,015	0,018	0,020	0,025	0,030
S	1	1 x D	0,1 x D	0,25 x D	–	–	–	50	–	90	fz	0,002	0,003	0,004	0,005	0,006	0,007	0,009	0,011	0,012	0,016	0,019
	2	1 x D	0,1 x D	0,25 x D	–	–	–	25	–	40	fz	0,001	0,002	0,002	0,003	0,003	0,004	0,005	0,006	0,007	0,009	0,010
	3	1 x D	0,1 x D	0,25 x D	–	–	–	60	–	80	fz	0,002	0,003	0,003	0,004	0,005	0,006	0,008	0,009	0,010	0,013	0,016
	4	1 x D	0,1 x D	0,25 x D	–	–	–	50	–	60	fz	0,001	0,002	0,002	0,003	0,004	0,005	0,006	0,007	0,008	0,010	0,013
H	1	1 x D	0,1 x D	0,25 x D	–	–	–	80	–	140	fz	0,002	0,003	0,003	0,005	0,006	0,007	0,009	0,010	0,012	0,014	0,017

NOTE: Lower value of cutting speed is used for high stock removal applications or for higher hardness (machinability) within group.
Higher value of cutting speed is used for finishing applications or for lower hardness (machinability) within group.

High-Performance Solid Carbide End Mills

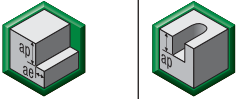
■ Series 4632

Material Group																		
	Side Milling (A) and Slotting (B)			uncoated			TiAlN			Recommended feed per tooth (fz = mm/th) for side milling (A). For slotting (B), reduce fz by 20%.								
	A		B	Cutting Speed – vc m/min			Cutting Speed – vc m/min			D1 – Diameter								
	ap	ae	ap	min	max		min	max		mm	0,4	0,5	0,6	0,8	1,0	1,5	2,0	
P	0	1 x D	0,1 x D	0,25 x D	75	–	100	150	–	200	fz	0,003	0,004	0,004	0,006	0,007	0,011	0,015
	1	1 x D	0,1 x D	0,25 x D	75	–	100	150	–	200	fz	0,003	0,004	0,004	0,006	0,007	0,011	0,015
	2	1 x D	0,1 x D	0,25 x D	–	–	–	140	–	190	fz	0,003	0,004	0,004	0,006	0,007	0,011	0,015
	3	1 x D	0,1 x D	0,25 x D	–	–	–	120	–	160	fz	0,002	0,003	0,004	0,005	0,006	0,009	0,012
	4	1 x D	0,1 x D	0,25 x D	–	–	–	90	–	150	fz	0,002	0,003	0,003	0,005	0,006	0,009	0,012
M	1	1 x D	0,1 x D	0,25 x D	–	–	–	90	–	115	fz	0,002	0,003	0,004	0,005	0,006	0,009	0,012
	2	1 x D	0,1 x D	0,25 x D	–	–	–	60	–	80	fz	0,002	0,003	0,003	0,004	0,005	0,008	0,010
K	1	1 x D	0,1 x D	0,25 x D	–	–	–	120	–	150	fz	0,003	0,004	0,004	0,006	0,007	0,011	0,015
	2	1 x D	0,1 x D	0,25 x D	–	–	–	110	–	140	fz	0,002	0,003	0,004	0,005	0,006	0,009	0,012
N	1	1 x D	0,1 x D	0,25 x D	250	–	1000	500	–	2000	fz	0,004	0,006	0,007	0,009	0,011	0,017	0,022
	2	1 x D	0,1 x D	0,25 x D	250	–	750	500	–	1500	fz	0,004	0,005	0,006	0,008	0,010	0,015	0,020
	5	1 x D	0,1 x D	0,25 x D	125	–	400	250	–	1000	fz	0,004	0,005	0,006	0,008	0,010	0,015	0,020

NOTE: Lower value of cutting speed is used for high stock removal applications or for higher hardness (machinability) within group.
Higher value of cutting speed is used for finishing applications or for lower hardness (machinability) within group.

■ Series 4633

Material Group																						
	Side Milling (A) and Slotting (B)			uncoated		TiAlN		Recommended feed per tooth (fz = mm/th) for side milling (A). For slotting (B), reduce fz by 20%.														
	A		B	Cutting Speed – vc m/min		Cutting Speed – vc m/min		D1 – Diameter														
	ap	ae	ap	min	max	min	max	mm	0,4	0,5	0,6	0,8	1,0	1,2	1,5	1,8	2,0	2,5	3,0			
P	0	1 x D	0,1 x D	0,25 x D	75	–	100	150	–	200	fz	0,030	0,037	0,045	0,060	0,075	0,090	0,113	0,136	0,152	0,191	0,231
	1	1 x D	0,1 x D	0,25 x D	75	–	100	150	–	200	fz	0,030	0,037	0,045	0,060	0,075	0,090	0,113	0,136	0,152	0,191	0,231
	2	1 x D	0,1 x D	0,25 x D	–	–	–	140	–	190	fz	0,030	0,037	0,045	0,060	0,075	0,090	0,113	0,136	0,152	0,191	0,231
	3	1 x D	0,1 x D	0,25 x D	–	–	–	120	–	160	fz	0,024	0,030	0,036	0,049	0,061	0,074	0,092	0,111	0,124	0,157	0,190
	4	1 x D	0,1 x D	0,25 x D	–	–	–	90	–	150	fz	0,023	0,028	0,034	0,045	0,057	0,069	0,086	0,104	0,115	0,145	0,175
M	1	1 x D	0,1 x D	0,25 x D	–	–	–	90	–	115	fz	0,024	0,030	0,036	0,049	0,061	0,074	0,092	0,111	0,124	0,157	0,190
	2	1 x D	0,1 x D	0,25 x D	–	–	–	60	–	80	fz	0,020	0,025	0,031	0,041	0,051	0,062	0,077	0,093	0,103	0,130	0,157
K	1	1 x D	0,1 x D	0,25 x D	–	–	–	120	–	150	fz	0,030	0,037	0,045	0,060	0,075	0,090	0,113	0,136	0,152	0,191	0,231
	2	1 x D	0,1 x D	0,25 x D	–	–	–	110	–	140	fz	0,024	0,030	0,036	0,049	0,061	0,074	0,092	0,111	0,124	0,157	0,190
N	1	1 x D	0,1 x D	0,25 x D	250	–	1000	500	–	2000	fz	0,044	0,055	0,066	0,088	0,110	0,132	0,165	0,198	0,220	0,275	0,330
	2	1 x D	0,1 x D	0,25 x D	250	–	750	500	–	1500	fz	0,040	0,050	0,059	0,079	0,099	0,119	0,149	0,178	0,198	0,248	0,297
	5	1 x D	0,1 x D	0,25 x D	125	–	400	250	–	1000	fz	0,040	0,050	0,059	0,079	0,099	0,119	0,149	0,178	0,198	0,248	0,297

NOTE: Lower value of cutting speed is used for high stock removal applications or for higher hardness (machinability) within group.
Higher value of cutting speed is used for finishing applications or for lower hardness (machinability) within group.

■ Series 4651

Material Group		Side Milling (A) and Slotting (B)		uncoated		TiAlN		TiCN		Recommended feed per tooth (fz = mm/th) for side milling (A). For slotting (B), reduce fz by 20%.									
		A		B		Cutting Speed – vc m/min		Cutting Speed – vc m/min		Cutting Speed – vc m/min		mm	D1 – Diameter						
		ap	ae	ap	ap	min	max	min	max	min	max		1,0	1,2	1,5	1,8	2,0		
		0	1	2	3	4	1	2	1	2	1	2	1	2	3	4	5		
P	0	0,5 x D	0,5 x D	0,5 x D	75	–	100	150	–	200	120	–	160	fz	0,007	0,009	0,011	0,014	0,015
	1	0,5 x D	0,5 x D	0,5 x D	75	–	100	150	–	200	120	–	160	fz	0,007	0,009	0,011	0,014	0,015
	2	0,5 x D	0,5 x D	0,5 x D	–	–	–	140	–	190	112	–	152	fz	0,007	0,009	0,011	0,014	0,015
	3	0,3 x D	0,3 x D	0,3 x D	–	–	–	120	–	160	96	–	128	fz	0,006	0,007	0,009	0,011	0,012
	4	0,3 x D	0,3 x D	0,3 x D	–	–	–	90	–	150	72	–	120	fz	0,006	0,007	0,009	0,010	0,012
M	1	0,3 x D	0,3 x D	0,3 x D	–	–	–	90	–	115	72	–	92	fz	0,006	0,007	0,009	0,011	0,012
	2	0,3 x D	0,3 x D	0,3 x D	–	–	–	60	–	80	48	–	64	fz	0,005	0,006	0,008	0,009	0,010
K	1	0,5 x D	0,5 x D	0,5 x D	–	–	–	120	–	150	96	–	120	fz	0,007	0,009	0,011	0,014	0,015
	2	0,5 x D	0,5 x D	0,5 x D	–	–	–	110	–	140	88	–	112	fz	0,006	0,007	0,009	0,011	0,012
N	1	0,5 x D	0,5 x D	0,5 x D	250	–	1000	500	–	2000	400	–	1600	fz	0,011	0,013	0,017	0,020	0,022
	2	0,5 x D	0,5 x D	0,5 x D	250	–	750	500	–	1500	400	–	1200	fz	0,010	0,012	0,015	0,018	0,020
	5	0,5 x D	0,5 x D	0,5 x D	125	–	400	250	–	1000	200	–	800	fz	0,010	0,012	0,015	0,018	0,020

NOTE: Lower value of cutting speed is used for high stock removal applications or for higher hardness (machinability) within group.
Higher value of cutting speed is used for finishing applications or for lower hardness (machinability) within group.

High-Performance Solid Carbide End Mills •
AluSurf™

AluSurf Aluminium

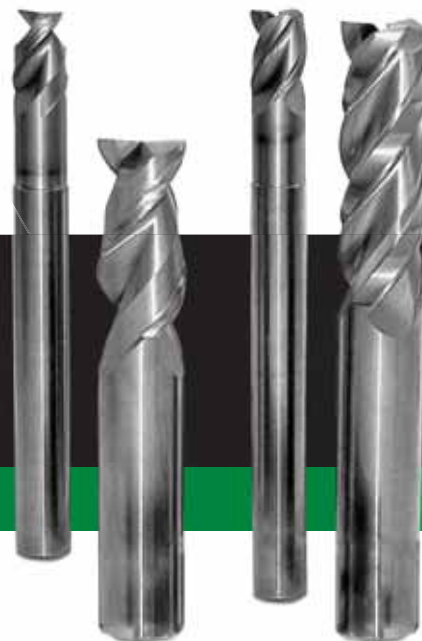

AluSurf provides extraordinary Metal Removal Rates (MRR) by combining roughing and finishing operations for any aluminium plunging, slotting, and profiling application. Its proprietary flute geometry is designed for rigidity and improved chip evacuation generating exceptional wall-to-floor perpendicularity, even in thin wall applications. To ensure a superior floor surface finish the AluSurf front geometry is equipped with a wiper facet grind.

- One tool for roughing and finishing operations.
- Slotting depths up to 1 x D and peripheral milling up to 1.5 x D axially at 0.5 x D radially.
- Unequal flute spacing for chatter-free performance, (3-flute series only).
- Multiple corner radii and extended neck configurations available as standard.

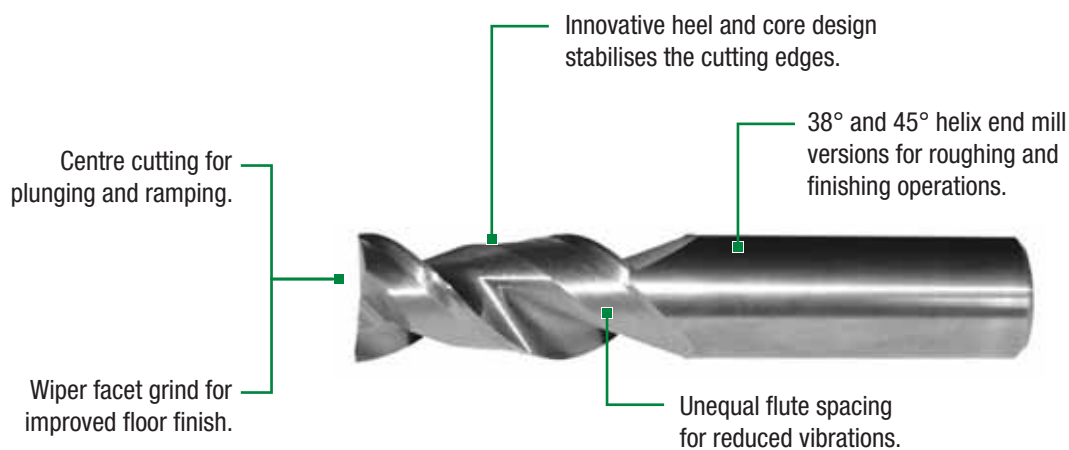

AluSurf™ Series

- Increase your output due to less tool changes and increased Metal Removal Rates (MRR).
- No specific tools for roughing and finishing necessary.
- Less passes due to 1 x D slotting capability.
- Perfect for MQL (Minimum Quantity Lubrication) methods.

5102 Series

- 2-flute, 45° helix.
- Radii and sharp corner configuration.



5103 Series

- 3-flute, 38° helix.
- Unequal flute spacing.
- Radii and sharp corner configuration.

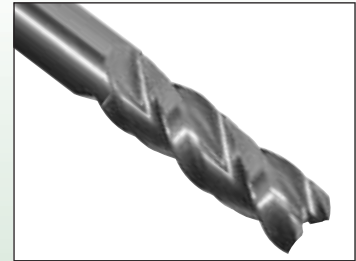

51N3 Series

- 3-flute, 38° helix.
- Unequal flute spacing.
- Extended neck for long-reach applications.
- Radii and sharp corner configuration.



Operation: Slotting
Customer: Aluminium Block
Material: 6061 Aluminium
Workpiece: AluSurf solid carbide end mill.
Results: 100% better surface finish on walls and floor.

	COMPETITOR	WIDIA-Hanita™
tool:	uncoated tools	uncoated tools
end mill:	16mm 3-flute	16mm 3-flute
material:	aluminium	aluminium
depth of cut (ap):	8mm	8mm
width of cut (ae):	8mm	8mm
speed (Vc):	610 m/min	610 m/min
RPM (N):	12,000 RPM	12,000 RPM
feed rate (Vf):	3,600 mm/min	3,600 mm/min
chip load per tooth (Fz):	0,1 mm/th	0,1 mm/th
metal removal rate:	230 cm³/min	230 cm³/min

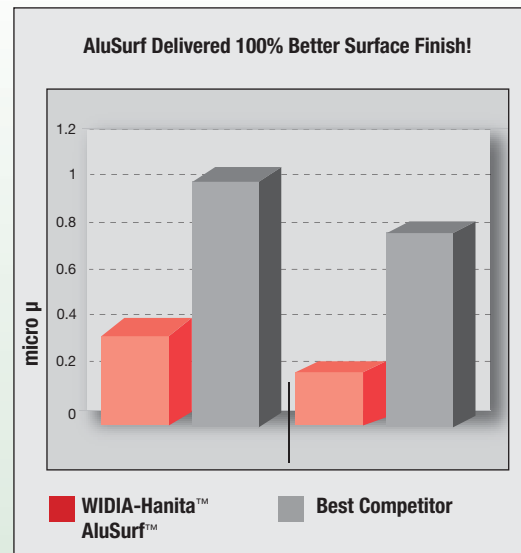

- Centre cutting.
- Wiper facet design for improved floor finishes.
- Standard items listed. Additional styles and coatings made-to-order.

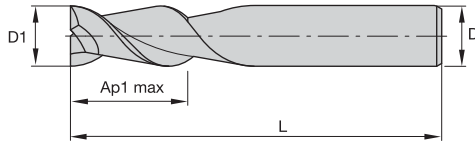
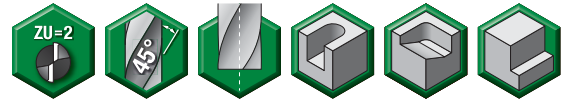

End Mill Tolerances

D1	tolerance e8	D	tolerance h6 + / -
≤ 3	0/0,006	≤ 3	0/0,006
> 3-6	0/0,008	> 3-6	0/0,008
> 6-10	0/0,009	> 6-10	0/0,009
> 10-18	0/0,011	> 10-18	0/0,011
> 18-30	0/0,013	> 18-30	0/0,013

Series 5102 • AluSurf

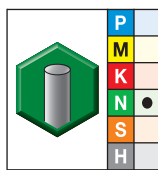

grade UNCOATED

- first choice
- alternate choice

order #	catalogue #	D1	D	length of cut Ap1 max	length L
3484680	510201500..	1,5	3	6,00	38
3484681	510202000..	2,0	3	8,00	38
3484682	510202500..	2,5	3	9,00	38
3484683	510203000..	3,0	3	12,00	38
3107860	510204001..	4,0	4	12,00	50
3484684	510205001..	5,0	5	14,00	50
3484685	510205002..	5,0	6	14,00	50
3107859	510206002..	6,0	6	16,00	50
3484686	510208003..	8,0	8	20,00	63
3484687	510210004..	10,0	10	22,00	76
3484688	510212005..	12,0	12	25,00	76
3484689	510214014..	14,0	14	32,00	83
3484690	510216006..	16,0	16	32,00	89
3484691	510218018..	18,0	18	38,00	100
3484692	510220007..	20,0	20	38,00	104

- Centre cutting.
- Unequal flute spacing.
- Wiper facet design for improved floor finishes.
- Standard items listed. Additional styles and coatings made-to-order.

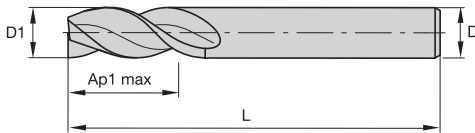

End Mill Tolerances

D1	tolerance e8	D	tolerance h6 + / -
≤ 3	0/0,006	≤ 3	0/0,006
> 3-6	0/0,008	> 3-6	0/0,008
> 6-10	0/0,009	> 6-10	0/0,009
> 10-18	0/0,011	> 10-18	0/0,011
> 18-30	0/0,013	> 18-30	0/0,013

■ Series 5103 • AluSurf

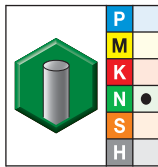

grade UNCOATED

- first choice
- alternate choice

order #	catalogue #	D1	D	length of cut Ap1 max	length L
3484693	510303000..	3,0	3	12,00	38
3484694	510304001..	4,0	4	12,00	50
3484695	510305001..	5,0	5	14,00	50
3484696	510306002..	6,0	6	16,00	50
3484697	510308003..	8,0	8	20,00	63
3484698	510310004..	10,0	10	22,00	76
3484699	510312005..	12,0	12	25,00	76
3484700	510314014..	14,0	14	32,00	83
3350935	510316006..	16,0	16	32,00	89
3484701	510318018..	18,0	18	38,00	100
3484702	510320007..	20,0	20	38,00	104

High-Performance Solid Carbide End Mills

- Centre cutting.
- Unequal flute spacing.
- Wiper facet design for improved floor finishes.
- Standard items listed. Additional styles and coatings made-to-order.

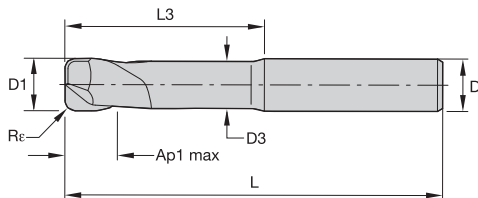
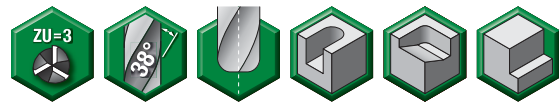

End Mill Tolerances

D1	tolerance e8	D	tolerance h6 + / -
≤ 3	0/0,006	≤ 3	0/0,006
> 3-6	0/0,008	> 3-6	0/0,008
> 6-10	0/0,009	> 6-10	0/0,009
> 10-18	0/0,011	> 10-18	0/0,011
> 18-30	0/0,013	> 18-30	0/0,013

■ Series 51N3 • AluSurf

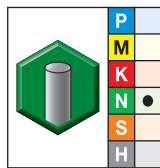

grade UNCOATED

- first choice
- alternate choice

order #	catalogue #	D1	D	D3	length of cut Ap1 max	L3	length L	Re
3484705	51N306022..	6,0	6	5,40	9,00	18,00	63	0,20
3484703	51N306002..	6,0	6	5,40	9,00	18,00	63	0,50
3484704	51N306012..	6,0	6	5,40	9,00	18,00	63	1,00
3484708	51N308023..	8,0	8	7,20	12,00	24,00	76	0,20
3484706	51N308003..	8,0	8	7,20	12,00	24,00	76	0,50
3484707	51N308013..	8,0	8	7,20	12,00	24,00	76	1,00
3484711	51N310024..	10,0	10	9,00	15,00	30,00	89	0,20
3484709	51N310004..	10,0	10	9,00	15,00	30,00	89	0,50
3484710	51N310014..	10,0	10	9,00	15,00	30,00	89	1,50
3484714	51N312025..	12,0	12	10,80	18,00	36,00	100	0,20
3484712	51N312005..	12,0	12	10,80	18,00	36,00	100	0,50
3484713	51N312015..	12,0	12	10,80	18,00	36,00	100	1,50
3484718	51N316036..	16,0	16	14,40	24,00	48,00	110	0,20
3484715	51N316006..	16,0	16	14,40	24,00	48,00	110	0,50
3484716	51N316016..	16,0	16	14,40	24,00	48,00	110	1,00
3484717	51N316026..	16,0	16	14,40	24,00	48,00	110	2,00
3484722	51N320037..	20,0	20	18,80	30,00	60,00	125	0,20
3484719	51N320007..	20,0	20	18,80	30,00	60,00	125	0,50
3484720	51N320017..	20,0	20	18,80	30,00	60,00	125	1,50
3484721	51N320027..	20,0	20	18,80	30,00	60,00	125	4,00

■ Series 5102 • AluSurf

		For Side Milling (A) and Slotting (B)			uncoated			Recommended feed per tooth (fz = mm/th) for side milling (A). For slotting (B), reduce fz by 20%.									
Material Group	A		B	Cutting Speed – vc m/min			D1 – Diameter										
	ap	ae	ap	min		max	mm	1,5	2,0	4,0	6,0	8,0	10,0	12,0	16,0	20,0	
N	1	1,5 x D	0,5 x D	1 x D	500	–	2000	fz	0,014	0,018	0,036	0,054	0,072	0,090	0,108	0,144	0,180
	2	1,5 x D	0,5 x D	1 x D	500	–	1500	fz	0,012	0,016	0,032	0,049	0,065	0,081	0,097	0,130	0,162

NOTE: Multiply ap for milling machine spindle with ceramic bearings by 0,5.
For better surface finish, reduce feed per tooth.
Above parameters are based on ideal conditions. For smaller taper machining centres, please adjust parameters accordingly on diameters >12mm.

Application Data • Series 5103 • AluSurf™

■ Series 5103 • AluSurf

		For Side Milling (A) and Slotting (B)			uncoated			Recommended feed per tooth (fz = mm/th) for side milling (A). For slotting (B), reduce fz by 20%.									
Material Group	A		B	Cutting Speed – vc m/min			D1 – Diameter										
	ap	ae	ap	min		max	mm	3,0	6,0	8,0	10,0	12,0	16,0	20,0			
N	1	1,5 x D	0,5 x D	1 x D	500	–	2000	fz	0,027	0,054	0,072	0,090	0,108	0,144	0,180		
	2	1,5 x D	0,5 x D	1 x D	500	–	1500	fz	0,024	0,049	0,065	0,081	0,097	0,130	0,162		

NOTE: Multiply ap for milling machine spindle with ceramic bearings by 0,5.
For better surface finish, reduce feed per tooth.
Above parameters are based on ideal conditions. For smaller taper machining centres, please adjust parameters accordingly on diameters >12mm.

Application Data • Series 51N3 • AluSurf™

■ Series 51N3 • AluSurf

		For Side Milling (A) and Slotting (B)			uncoated			Recommended feed per tooth (fz = mm/th) for side milling (A). For slotting (B), reduce fz by 20%.									
Material Group	A		B	Cutting Speed – vc m/min			D1 – Diameter										
	ap	ae	ap	min		max	mm	6,0	8,0	10,0	12,0	16,0	20,0				
N	1	1 x D	0,5 x D	1 x D	500	–	2000	fz	0,060	0,080	0,100	0,120	0,160	0,200			
	2	1 x D	0,5 x D	1 x D	500	–	1500	fz	0,054	0,072	0,090	0,108	0,144	0,180			

NOTE: Multiply ap for milling machine spindle with ceramic bearings by 0,5.
For better surface finish, reduce feed per tooth.
Above parameters are based on ideal conditions. For smaller taper machining centres, please adjust parameters accordingly on diameters >12mm.

High-Performance Aluminium Solid Carbide End Mills

HP Aluminium End Mills Series



WIDIA™ solid carbide end mills provide maximum Metal Removal Rates (MRR) and superior surface quality while reducing machining time in aluminium. The centre cutting design allows for plunging, slotting, and profiling applications in any type of aluminium workpiece materials. The proprietary flute geometry is designed to deliver exceptional chip evacuation while generating floor-to-wall straightness, especially thin wall applications. With many styles to choose from, you can be sure WIDIA will have a solution for your non-ferrous applications.

- One tool for roughing and finishing operations.
- Capable of slotting depths up to 1 x D and side milling up to 1.5 x D axially at 0.5 x D radially (please follow application data for specific tool).
- Multiple corner radii and extended neck configurations available as standard.

HP Aluminium End Mills Series

- Increase your output due to less tool changes and increased Metal Removal Rates (MRR).
- No specific tools for roughing and finishing necessary.
- Less passes due to 1 x D slotting capability.
- Perfect for MQL (Minimum Quantity Lubrication) applications.

524149 Series

- 1-flute, 30° helix.
- DLC coated option for abrasive aluminium and carbon.
- Uncoated for aluminium.
- Sharp corner configuration.



4909 Series

- 3-flute, 40° helix
- Coarse cord style roughing profile
- Protective chamfer configuration



4979 Series

- 3-flute, 40° helix
- TiCN coated option
- Chamfer pitch roughing profile.
- Protective chamfer configuration



49N9 Series

- 3-flute, 40° helix
- Coarse cord style roughing profile
- Protective chamfer configuration
- Extended neck for long-reach applications



49G9 Series

- 3-flute, 40° helix.
- TiCN coated option.
- Coarse cord style roughing profile
- Protective chamfer configuration.
- Internal coolant for improved chip evacuation and higher tool life.



- Centre cutting.
- Standard items listed. Additional styles and coatings made-to-order.

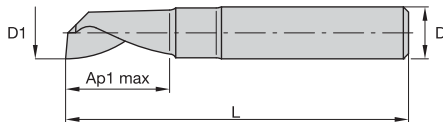
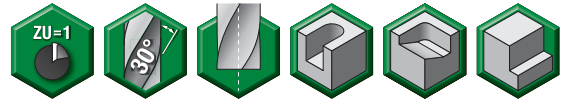

End Mill Tolerances

D1	tolerance h10 + / -	D	tolerance h6 + / -
≤ 3	0/0,040	≤ 3	0/0,006
> 3-6	0/0,048	> 3-6	0/0,008
> 6-10	0/0,058	> 6-10	0/0,009
> 10-18	0/0,070	> 10-18	0/0,011
> 18-30	0/0,084	> 18-30	0/0,013

■ Series 524149

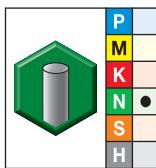

grade K10F-DCL
DLC

- first choice
- alternate choice

order #	catalogue #	D1	D	length of cut Ap1 max	length L
2651100	524149-000030	3,0	6	12,00	50
2651314	524149-000040	4,0	6	15,00	60
2651317	524149-000050	5,0	6	17,00	60
2651318	524149-000060	6,0	6	20,00	60
2651319	524149-000080	8,0	10	25,00	75
2651320	524149-000100	10,0	8	25,00	75
2651321	524149-000120	12,0	12	25,00	75

High-Performance Solid Carbide End Mills

- Centre cutting.
- Coarse pitch.
- Standard items listed. Additional styles and coatings made-to-order.

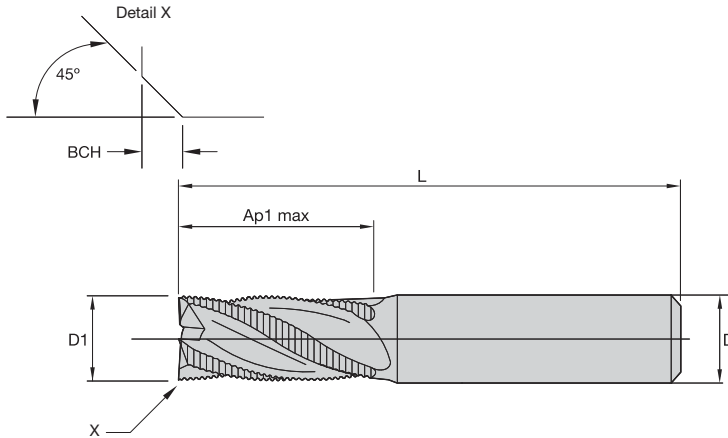
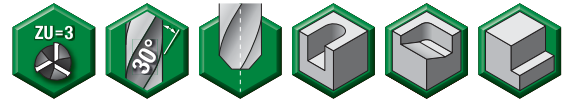

End Mill Tolerances

D1	tolerance d11	D	tolerance h6 + / -
≤ 3	-0,020/-0,080	≤ 3	0/0,006
> 3-6	-0,030/-0,105	> 3-6	0/0,008
> 6-10	-0,040/-0,130	> 6-10	0/0,009
> 10-18	-0,050/-0,160	> 10-18	0/0,011
> 18-30	-0,065/-0,195	> 18-30	0/0,013

■ Series 4909

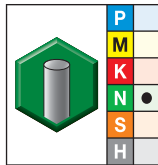

grade UNCOATED

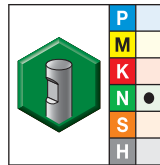

grade UNCOATED-WW

- first choice
- alternate choice

order #	catalogue #	order #	catalogue #	D1	D	length of cut Ap1 max	length L	BCH
1657125	490906002..	1657126	490906002WW	6,0	6	13,00	57	0,06
1657127	490908003..	1657128	490908003WW	8,0	8	16,00	63	0,06
1657129	490910004..	1657131	490910004WW	10,0	10	22,00	72	0,06
1657132	490912005..	1657134	490912005WW	12,0	12	26,00	83	1,00
1657136	490914014..	1657137	490914014WW	14,0	14	26,00	83	1,00
1657138	490916006..	1657140	490916006WW	16,0	16	32,00	92	1,00
1657142	490918018..	1657143	490918018WW	18,0	18	32,00	92	1,00
1657144	490920007..	1657145	490920007WW	20,0	20	38,00	104	1,00
1657146	490925008..	1657148	490925008WW	25,0	25	45,00	121	1,00

- Centre cutting.
- Chamfered pitch.
- Standard items listed. Additional styles and coatings made-to-order.

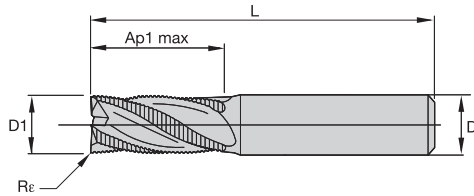
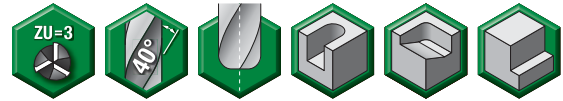

End Mill Tolerances

D1	tolerance d11	D	tolerance h6 + / -
≤ 3	-0,020/-0,080	≤ 3	0/0,006
> 3-6	-0,030/-0,105	> 3-6	0/0,008
> 6-10	-0,040/-0,130	> 6-10	0/0,009
> 10-18	-0,050/-0,160	> 10-18	0/0,011
> 18-30	-0,065/-0,195	> 18-30	0/0,013

Series 4979

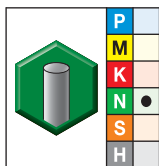

grade UNCOATED

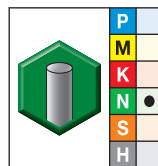

grade TiCN-CT
TiCN

- first choice
- alternate choice

order #	catalogue #	order #	catalogue #	D1	D	length of cut Ap1 max	length L	Rε
1858322	497906002..	1858423	497906002CT	6,0	6	13,00	57	0,25
1858424	497908003..	1858425	497908003CT	8,0	8	16,00	63	0,25
1858426	497910004..	1858427	497910004CT	10,0	10	22,00	72	0,50
1858428	497912005..	1858430	497912005CT	12,0	12	26,00	83	0,50
1858434	497916006..	1858437	497916006CT	16,0	16	32,00	92	1,00
1858441	497920007..	1858463	497920007CT	20,0	20	38,00	104	1,00
1858465	497925008..	1858466	497925008CT	25,0	25	45,00	121	1,50

- Centre cutting.
- Chamfered pitch.
- Standard items listed. Additional styles and coatings made-to-order.

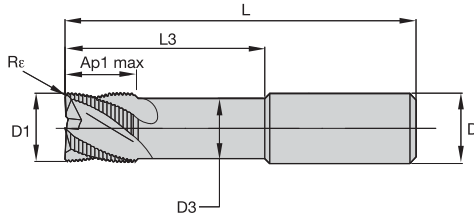
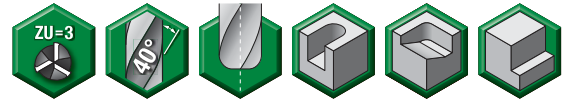

End Mill Tolerances

D1	tolerance d11	D	tolerance h6 + / -
≤ 3	-0,020/-0,080	≤ 3	0/0,006
> 3-6	-0,030/-0,105	> 3-6	0/0,008
> 6-10	-0,040/-0,130	> 6-10	0/0,009
> 10-18	-0,050/-0,160	> 10-18	0/0,011
> 18-30	-0,065/-0,195	> 18-30	0/0,013

■ Series 49N9

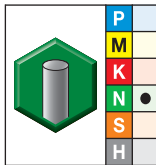

grade UNCOATED

- first choice
- alternate choice

order #	catalogue #	D1	D	D3	length of cut Ap1 max	L3	length L	Re
2510324	49N906002..	6,0	6	5,00	8,00	18,00	57	0,25
2510325	49N908003..	8,0	8	7,00	10,00	24,00	63	0,25
2510326	49N910004..	10,0	10	9,00	12,00	30,00	72	0,50
2510327	49N912005..	12,0	12	11,00	15,00	36,00	83	0,50
2510328	49N916006..	16,0	16	14,80	20,00	48,00	92	1,00
2510329	49N920007..	20,0	20	18,70	24,00	60,00	104	1,00

High-Performance Solid Carbide End Mills

- Centre cutting.
- Chamfered pitch.
- Through coolant.
- Standard items listed. Additional styles and coatings made-to-order.

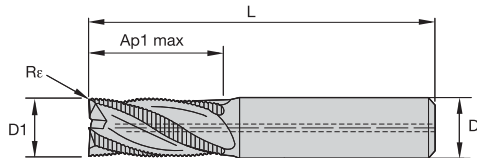

End Mill Tolerances

D1	tolerance d11	D	tolerance h6 +/-
≤ 3	-0,020/-0,080	≤ 3	0/0,006
> 3-6	-0,030/-0,105	> 3-6	0/0,008
> 6-10	-0,040/-0,130	> 6-10	0/0,009
> 10-18	-0,050/-0,160	> 10-18	0/0,011
> 18-30	-0,065/-0,195	> 18-30	0/0,013

Series 49G9

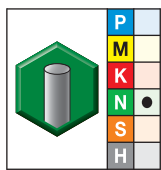

grade TiCN-CT
TiCN

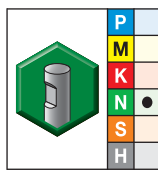

grade TiCN-CW
TiCN

- first choice
- alternate choice

order #	catalogue #	order #	catalogue #	D1	D	length of cut Ap1 max	length L	Re
1859874	49G908003CT	1902489	49G908003CW	8,0	8	16,00	63	0,25
1859875	49G910004CT	1902490	49G910004CW	10,0	10	22,00	72	0,50
1859876	49G912005CT	1902491	49G912005CW	12,0	12	26,00	83	0,50
1859877	49G916006CT	1902492	49G916006CW	16,0	16	32,00	92	1,00
1859878	49G920007CT	1902493	49G920007CW	20,0	20	38,00	104	1,00
1859879	49G925008CT	1902494	49G925008CW	25,0	25	45,00	121	1,50

■ Series 524149

Material Group																
	Side Milling (A) and Slotting (B)			K10F-DCL			Recommended feed per tooth (fz = mm/th) for side milling (A). For slotting (B), reduce fz by 20%.									
				DLC												
	A		B	Cutting Speed – vc m/min			D1 – Diameter									
	ap	ae	ap	min		max	mm	3,0	4,0	5,0	6,0	8,0	10,0	12,0		
N	1	1,2 x D	0,5 x D	1 x D	500	–	2000	fz	0,021	0,028	0,035	0,042	0,056	0,070	0,084	
	2	1,2 x D	0,5 x D	1 x D	500	–	1500	fz	0,019	0,025	0,032	0,038	0,050	0,063	0,076	
	3	1,2 x D	0,5 x D	1 x D	500	–	1500	fz	0,017	0,022	0,028	0,034	0,045	0,056	0,067	
	4	1,2 x D	0,5 x D	1 x D	250	–	750	fz	0,015	0,020	0,025	0,029	0,039	0,049	0,059	
	6	1,2 x D	0,5 x D	1 x D	100	–	500	fz	0,021	0,028	0,035	0,042	0,056	0,070	0,084	

NOTE: For better surface finish, reduce feed per tooth.

Application Data • Series 4909

■ Series 4909

Material Group																
	Side Milling (A) and Slotting (B)			uncoated			Recommended feed per tooth (fz = mm/th) for side milling (A). For slotting (B), reduce fz by 20%.									
	A		B	Cutting Speed – vc m/min			D1 – Diameter									
	ap	ae	ap	min		max	mm	6,0	8,0	10,0	12,0	16,0	20,0	25,0		
N	1	1,5 x D	0,5 x D	1 x D	500	–	2000	fz	0,066	0,088	0,110	0,132	0,176	0,220	0,275	
	2	1,5 x D	0,5 x D	1 x D	500	–	1500	fz	0,059	0,079	0,099	0,119	0,158	0,198	0,248	

NOTE: For cutting aluminium with high silicon TiCN coating is recommended.

Multiply ap for milling machine spindle with ceramic bearings by 0,5.

Above parameters are based on ideal conditions. For smaller taper machining centres, please adjust parameters accordingly on diameters >12mm.

■ Series 4979

Material Group								Recommended feed per tooth (fz = mm/th) for side milling (A). For slotting (B), reduce fz by 20%.									
	Side Milling (A) and Slotting (B)		uncoated														
	A		B	Cutting Speed – vc m/min			D1 – Diameter										
	ap	ae	ap	min		max	mm	6,0	8,0	10,0	12,0	16,0	18,0	20,0			
N	1	1,5 x D	0,5 x D	1 x D	500	–	2000	fz	0,072	0,096	0,120	0,144	0,192	0,216	0,240		
	2	1,5 x D	0,5 x D	1 x D	500	–	1500	fz	0,065	0,086	0,108	0,130	0,173	0,194	0,216		
	3	1,5 x D	0,5 x D	1 x D	500	–	1500	fz	0,050	0,067	0,084	0,101	0,134	0,151	0,168		
	4	1,5 x D	0,5 x D	1 x D	400	–	750	fz	0,058	0,077	0,096	0,115	0,154	0,173	0,192		
	5	1,5 x D	0,5 x D	1 x D	250	–	1000	fz	0,065	0,086	0,108	0,130	0,173	0,194	0,216		

NOTE: For cutting aluminium with high silicon, TiCN coating is recommended.
 Multiply ap for milling machine spindle with ceramic bearings by 0,5.
 Above parameters are based on ideal conditions. For smaller taper machining centres, please adjust parameters accordingly on diameters >12mm.

Application Data • Series 49N9

■ Series 49N9

Material Group								Recommended feed per tooth (fz = mm/th) for side milling (A). For slotting (B), reduce fz by 20%.									
	Side Milling (A) and Slotting (B)		uncoated														
	A		B	Cutting Speed – vc m/min			D1 – Diameter										
	ap	ae	ap	min		max	mm	6,0	8,0	10,0	12,0	16,0	18,0	20,0			
N	1	1 x D	0,5 x D	1 x D	500	–	2000	fz	0,072	0,096	0,120	0,144	0,192	0,216	0,240		
	2	1 x D	0,5 x D	1 x D	500	–	1500	fz	0,065	0,086	0,108	0,130	0,173	0,194	0,216		
	3	1 x D	0,5 x D	1 x D	500	–	1500	fz	0,050	0,067	0,084	0,101	0,134	0,151	0,168		
	4	1 x D	0,5 x D	1 x D	400	–	750	fz	0,058	0,077	0,096	0,115	0,154	0,173	0,192		
	5	1 x D	0,5 x D	1 x D	250	–	1000	fz	0,065	0,086	0,108	0,130	0,173	0,194	0,216		

NOTE: For cutting aluminium with high silicon, TiCN coating is recommended.
 Multiply ap for milling machine spindle with ceramic bearings by 0,5.
 Above parameters are based on ideal conditions. For smaller taper machining centres, please adjust parameters accordingly on diameters >12mm.

■ Series 49G9

Material Group																
	Side Milling (A) and Slotting (B)				uncoated			Recommended feed per tooth (fz = mm/th) for side milling (A). For slotting (B), reduce fz by 20%.								
	A		B		Cutting Speed – vc m/min			D1 – Diameter								
	ap	ae	ap	min		max	mm	6,0	8,0	10,0	12,0	16,0	18,0	20,0		
N	1	1 x D	0,5 x D	1 x D	500	–	2000	fz	0,072	0,096	0,120	0,144	0,192	0,216	0,240	
	2	1 x D	0,5 x D	1 x D	500	–	1500	fz	0,065	0,086	0,108	0,130	0,173	0,194	0,216	
	3	1 x D	0,5 x D	1 x D	500	–	1500	fz	0,050	0,067	0,084	0,101	0,134	0,151	0,168	
	4	1 x D	0,5 x D	1 x D	400	–	750	fz	0,058	0,077	0,096	0,115	0,154	0,173	0,192	
	5	1 x D	0,5 x D	1 x D	250	–	1000	fz	0,065	0,086	0,108	0,130	0,173	0,194	0,216	

NOTE: Multiply ap for milling machine spindle with ceramic bearings by 0,5.
Above parameters are based on ideal conditions. For smaller taper machining centres, please adjust parameters accordingly on diameters >12mm.

X-Feed™ End Mills for High-Feed Milling

X-Feed



X-Feed significantly reduces manufacturing time machining heat-treated steels up to 67 HRC hardness, having 50% more effective cutting edges than regular solid carbide tooling. X-Feed combines roughing and semi-finishing into one operation by taking shallow depths-of-cut at extremely high feed rates, maximising Metal Removal Rates (MRR). X-Feed, which has a 3 x D neck and extended reach design, is perfectly suited for pocketing using 3D machining techniques such as ramping and helical interpolation. During face milling, the proprietary front-end geometry of X-Feed is entirely in contact with the workpiece, providing up to 55% engagement compared to the regular 5–10% provided by ball nose-type tooling.

- Proprietary 6-flute design for high productivity.
- One tool for roughing and semi-finishing operations.
- Covering hardened materials ranging from 37–67 HRC with two dedicated geometries.
- Custom solutions tailored for machining titanium and other high-temperature alloys available.

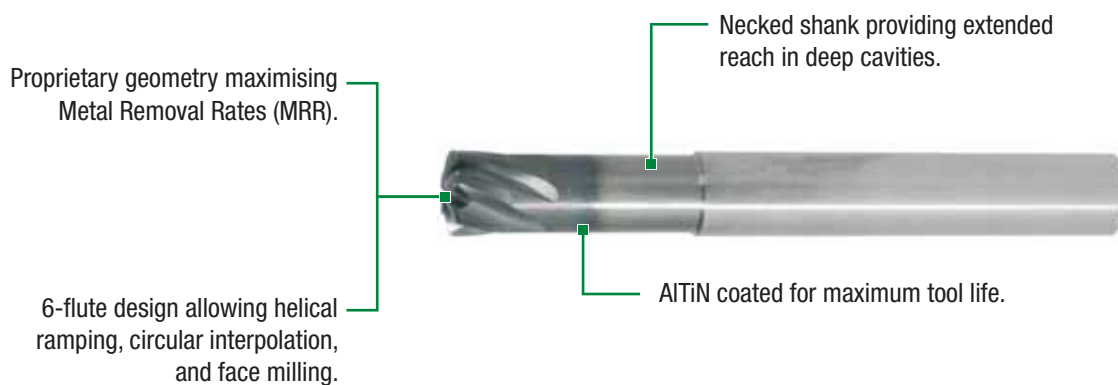

X-Feed™ Series

- Significantly reduces manufacturing time in machining hardened steels.
- Providing the benefits of indexable style high-feed milling starting from as small as 6mm.
- Increases your capability to perform 3D machining, helical ramping, circular interpolation, face milling, and pocketing.
- One tool for roughing and semi-finishing.

70N6 Series

- 6-flute.
- Extended neck for long-reach applications.
- Applicable for hardened steels from 40–52 HRC.



70N7 Series

- 6-flute.
- Extended neck for long-reach applications.
- Applicable for hardened steels from 50–67 HRC.



Operation: Pocket Milling
Customer: Die and Mould Manufacturer
Material: AISI 4340 hardened steel (52 HRC)
Workpiece: Mould
Results:

- 3x better Metal Removal Rate (MRR) than competitive tool!
- Machined at more than 3x faster feed!

	COMPETITOR	WIDIA™-Hanita™
tool:	6-flute H/P for die & mould	70N612005MT
material:	medium-hardened steel (52 HRC)	medium-hardened steel (52 HRC)
surface speed:	120 m/min	160 m/min
feed per tooth:	0,34mm	0,34mm
depth of cut:	0,8mm	0,6mm
table feed:	4,331 mm/min	15,287 mm/min
metal removal rate:	22,8 cm ³	60,5 cm ³

Individual results may vary.

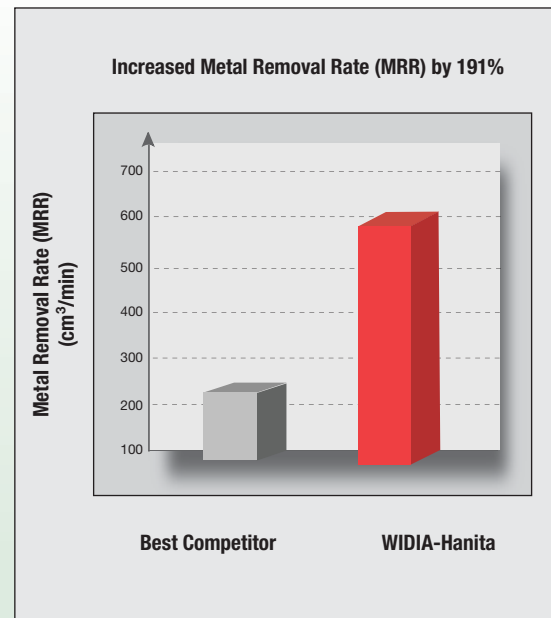

- Non-centre cutting.
- Standard items listed. Additional styles and coatings made-to-order.

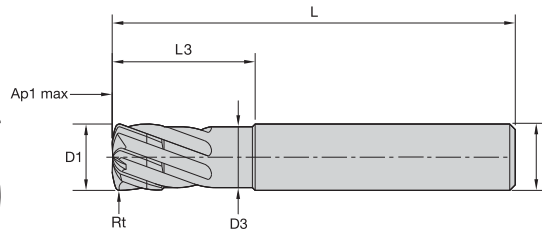
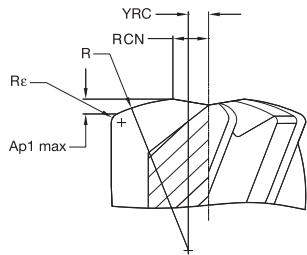
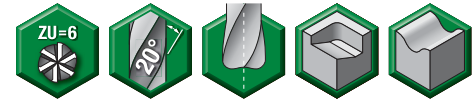

End Mill Tolerances

D1	tolerance e8	D	tolerance h6 + / -
≤ 3	-0,014/-0,028	≤ 3	0/0,006
> 3–6	-0,020/-0,038	> 3–6	0/0,008
> 6–10	-0,025/-0,047	> 6–10	0/0,009
> 10–18	-0,032/-0,059	> 10–18	0/0,011
> 18–30	-0,040/-0,073	> 18–30	0/0,013

Series 70N6 71N6 • 37–52 HRC • Vision Plus X-Feed

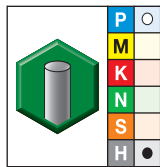

grade AITiN-MT1
AITiN

- first choice
- alternate choice

order #	catalogue #	D1	D	D3	length of cut Ap1 max	L3	length L	Re	Rt
3745400	71N606002MT	6,0	6	5,50	0,32	9,00	57	0,38	0,62
3341346	70N606002MT	6,0	6	5,50	0,32	18,00	63	0,38	0,62
3745401	71N608003MT	8,0	8	7,50	0,42	12,00	63	0,50	0,83
3341348	70N608003MT	8,0	8	7,50	0,42	24,00	76	0,50	0,83
3745402	71N610004MT	10,0	10	9,00	0,53	15,00	72	0,63	1,04
3101466	70N610004MT	10,0	10	9,00	0,53	30,00	89	0,63	1,04
3745413	71N612005MT	12,0	12	11,00	0,63	18,00	83	0,75	1,24
3101467	70N612005MT	12,0	12	11,00	0,63	36,00	100	0,75	1,24
3484748	70N616006MT	16,0	16	15,00	0,84	48,00	110	1,00	1,66
3484749	70N620007MT	20,0	20	19,00	1,05	60,00	125	1,25	2,07

NOTE: YRC = distance from centre line to the crown of the R radius.

RCN = distance from centre line to the start of the cutting edge. This dimension can also help determine the minimum circle size when helical ramping.

R = the head radius size.

Re = the shoulder radius or radius at the corner of the cutter.

Programming Data

Tool List 70N6															
Geometrical Parameters									Ramping Guide for Circular and Linear Interpolation						
									Circular Interpolation		Linear Interpolation				
									Allowed Range of Hole Diameter		Calculated Length (mm) per Ramp Angle				
diameter	Ap1 max	Rfm	Rt	Rc	Xfm	Yfm	YD	Number			Ramp Angle (degree)				
[mm]	[mm]	[mm]	[mm]	[mm]	[mm]	[mm]	[mm]	flutes	Smallest	Largest	1	2	3	4	5
6	0,32	6	0,62	0,375	0,32	0,75	1,32	6	8,64	12	18,12	9,06	6,03	4,52	3,61
8	0,42	8	0,83	0,500	0,42	1,00	1,76	6	11,52	16	24,16	12,08	8,05	6,03	4,82
10	0,53	10	1,04	0,625	0,53	1,25	2,20	6	14,4	20	30,20	15,09	10,06	7,54	6,02
12	0,63	12	1,24	0,750	0,63	1,50	2,64	6	17,28	24	36,24	18,11	12,07	9,05	7,23
16	0,84	16	1,66	1,000	0,84	2,00	3,52	6	23,04	32	48,31	24,15	16,09	12,06	9,64
20	1,05	20	2,07	1,250	1,05	2,50	4,40	6	28,8	40	60,39	30,19	20,11	15,08	12,05
Recommended Feed											100%	70%	50%	30%	10%

- Non-centre cutting.
- Standard items listed. Additional styles and coatings made-to-order.

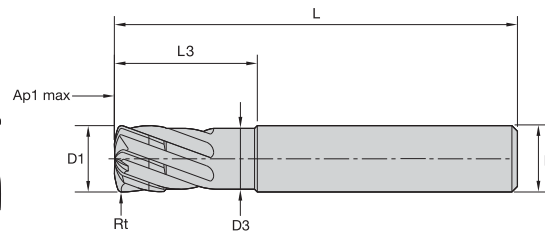
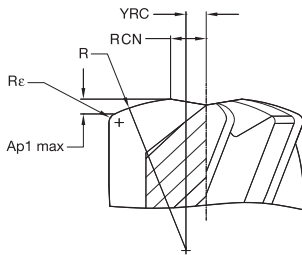

End Mill Tolerances

D1	tolerance e8	D	tolerance h6 + / -
≤ 3	-0,014/-0,028	≤ 3	0/0,006
> 3-6	-0,020/-0,038	> 3-6	0/0,008
> 6-10	-0,025/-0,047	> 6-10	0/0,009
> 10-18	-0,032/-0,059	> 10-18	0/0,011
> 18-30	-0,040/-0,073	> 18-30	0/0,013

■ **Series 70N7 • >52 HRC • Vision Plus X-Feed**

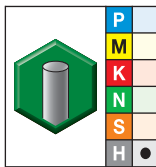

grade **AlTiN-MT1**
AlTiN

- first choice
- alternate choice

order #	catalogue #	D1	D	D3	length of cut Ap1 max	L3	length L	Re	Rt
3484756	70N706002MT	6,0	6	5,50	0,20	18,00	63	0,38	0,58
3484757	70N708003MT	8,0	8	7,50	0,27	24,00	76	0,50	0,77
3484758	70N710004MT	10,0	10	9,00	0,33	30,00	89	0,63	0,96
3403492	70N712005MT	12,0	12	11,00	0,40	36,00	100	0,75	1,15
3477329	70N716006MT	16,0	16	15,00	0,54	48,00	110	1,00	1,54
3484759	70N720007MT	20,0	20	19,00	0,67	60,00	125	1,25	1,92

NOTE: YRC = distance from centre line to the crown of the R radius.
 RCN = distance from centre line to the start of the cutting edge. This dimension can also help determine the minimum circle size when helical ramping.
 R = the head radius size.
 Re = the shoulder radius or radius at the corner of the cutter.

■ **Programming Data**

Tool List 70N7															
Geometrical Parameters									Ramping Guide for Circular and Linear Interpolation						
									Circular Interpolation		Linear Interpolation				
									Allowed Range of Hole Diameter		Calculated Length (mm) per Ramp Angle				
diameter	Ap1 max	Rfm	Rt	Rc	Xfm	Yfm	YD	Number			Ramp Angle (degree)				
[mm]	[mm]	[mm]	[mm]	[mm]	[mm]	[mm]	[mm]	flutes	Smallest	Largest	1	2	3	4	5
6	0,20	9	0,58	0,375	0,20	0,75	1,26	6	8,52	12	11,51	5,75	3,83	2,87	2,30
8	0,27	12	0,77	0,500	0,27	1,00	1,68	6	11,36	16	15,34	7,67	5,11	3,83	3,06
10	0,33	15	0,96	0,625	0,33	1,25	2,10	6	14,2	20	19,18	9,58	6,39	4,79	3,83
12	0,40	18	1,15	0,750	0,40	1,50	2,52	6	17,04	24	23,01	11,50	7,66	5,74	4,59
16	0,54	24	1,54	1,000	0,54	2,00	3,36	6	22,72	32	30,68	15,34	10,22	7,66	6,12
20	0,67	30	1,92	1,250	0,67	2,50	4,20	6	28,4	40	38,35	19,17	12,77	9,57	7,65
Recommended Feed											100%	70%	50%	30%	10%

■ Series 70N6 71N6 • Vision Plus X-Feed

Material Group													
		Profile Milling		AlTiN			Recommended Feed Per Tooth (fz = mm/th) for 3D milling/profiling (A)						
		A		Cutting Speed – vc m/min			D1 – Diameter						
		ap	ae	min		max	mm	6,0	8,0	10,0	12,0	16,0	20,0
P	4	0,05 x D	0,55 x D	160	–	180	fz	0,300	0,500	0,500	0,500	0,600	0,700
H	1	0,05 x D	0,55 x D	140	–	160	fz	0,300	0,500	0,500	0,500	0,600	0,700
	2	0,05 x D	0,55 x D	100	–	120	fz	0,200	0,300	0,300	0,400	0,500	0,600

NOTE: Above parameters are based on ideal conditions. For smaller taper machining centres, please adjust parameters on diameters >12mm.

■ Series 70N7 • Vision Plus X-Feed

Material Group													
		Profile Milling		AlTiN			Recommended Feed Per Tooth (fz = mm/th) for 3D milling/profiling (A)						
		A		Cutting Speed – vc m/min			D1 – Diameter						
		ap	ae	min		max	mm	6,0	8,0	10,0	12,0	16,0	20,0
H	2	0,03 x D	0,55 x D	100	–	120	fz	0,200	0,300	0,300	0,400	0,500	0,600
	3	0,03 x D	0,55 x D	80	–	100	fz	0,200	0,300	0,300	0,400	0,500	0,600
	4	0,03 x D	0,55 x D	50	–	70	fz	0,150	0,200	0,250	0,300	0,400	0,500

NOTE: Above parameters are based on ideal conditions. For smaller taper machining centers, please adjust parameters accordingly on diameters >12mm.

■ Conventional Slotting

- Full slotting limitations:
 - Usually not more than $a_p = 1 \times D$.
 - Conventional and climb milling at the same time.
 - High heat development on the tool and on the workpiece.
 - Difficult chip evacuation.
 - High radial forces.
- This means:
 - No constant chip thickness.
 - Low MRR.
 - Surface quality from the left to right side are different.
 - Limited tool life.
 - High power and torque requirements for the machine.

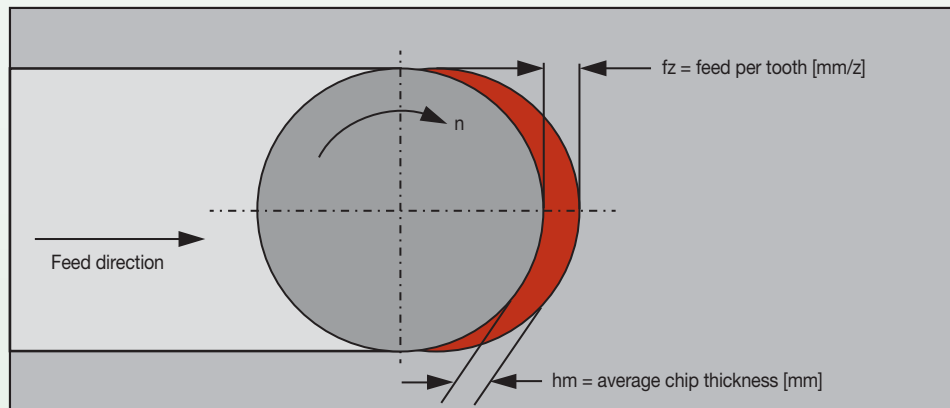

■ ae and Chip Thickness

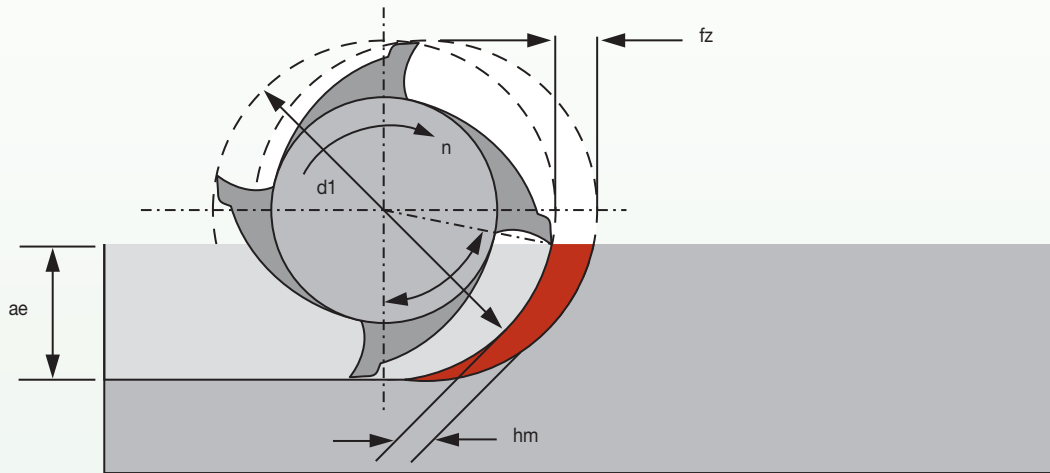

To calculate average chip thickness:

$$hm = fz \cdot \left(\sqrt{\frac{ae}{d_1}} \right)$$

Simplified formula for shown application and 90° angles on the tool.

The chip thickness defines the load on the cutting edge.

■ ae and Chip Thickness

chip thinning effect		
ae	programmed feed (fz)	chip thickness (hm)
100%	0,15mm	0,1mm
50%	0,15mm	0,1mm
40%	0,15mm	0,09mm
20%	0,15mm	0,07mm
10%	0,15mm	0,046mm

The chip thickness needs to be compensated by feed.

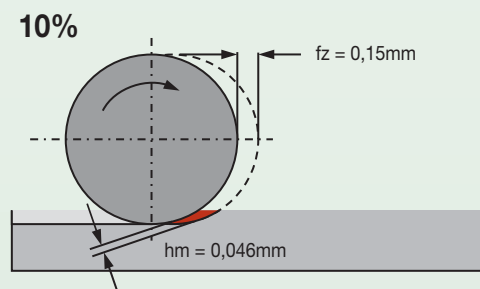
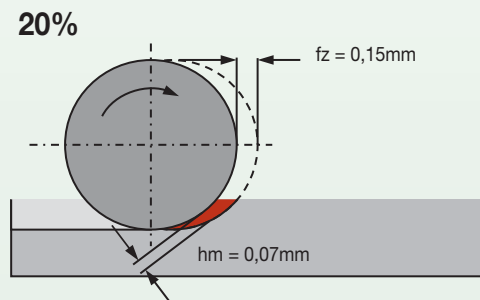
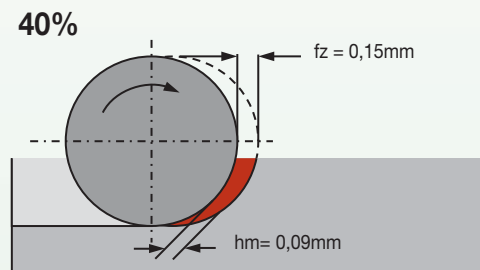
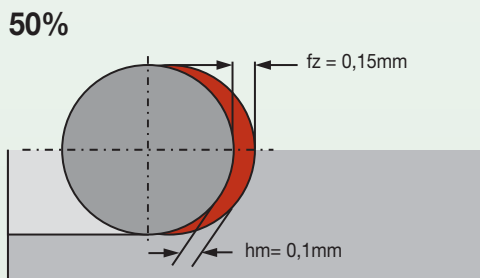
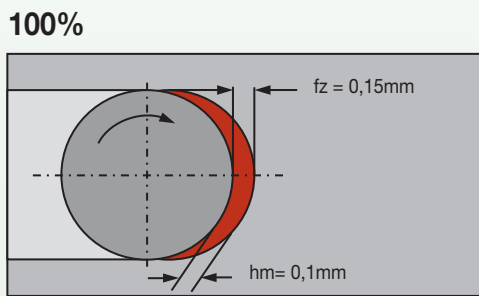

■ **Helix Angle and Chip Thickness**

The chip thickness (h) depends on the helix angle of the cutting edge. If the feed fz is constant, the chip thickness gets thinner as helix angle rises. That means with more helix angle, the chip gets thinner — or you can rise feed rate to increase productivity and load to the cutting edge.

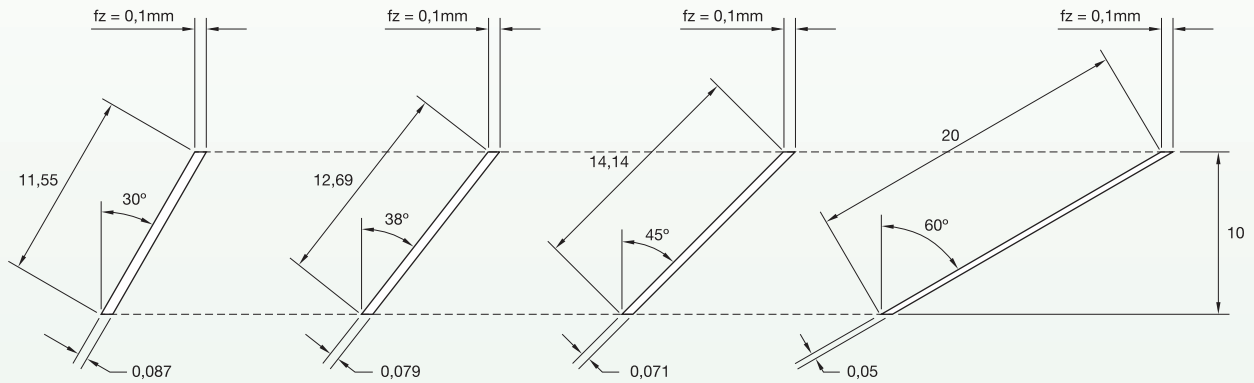

■ **Calculation of Chip Thickness**

The chip thickness (h) is not constant, but defines the load of the cutting edge. By reducing the load on the cutting edge, machining at higher speeds is possible through the machining parameters. For easier calculation, use an average chip thickness hm. When calculating machining data this way cutting data may be compromised because the workpiece is often a different shape.

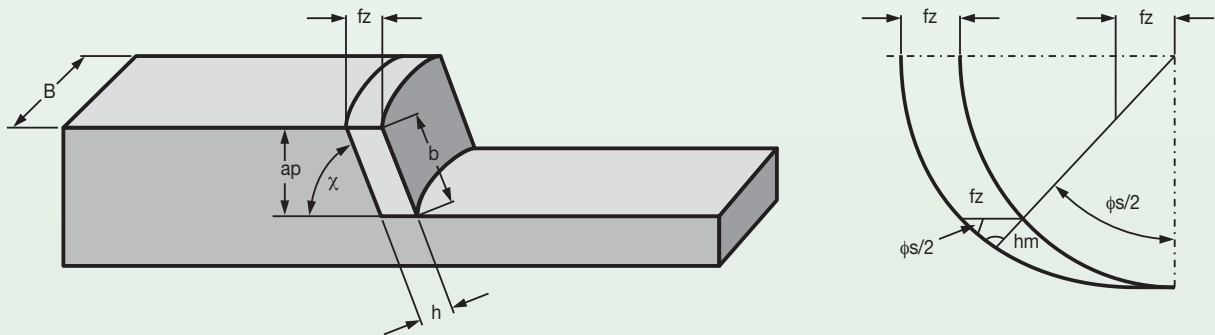

$$h_m = \frac{360^\circ}{\pi \cdot \phi_s} \cdot \frac{a_e}{D} \cdot f_z \cdot \sin \chi$$

- hm [mm] = average chip thickness
- phi_s [°] = engagement angle
- ae [mm] = width of engagement
- D1 [mm] = outer diameter tool
- fz [mm] = feed per tooth
- chi [°] = lead angle
- lambda [°] = helix angle *

* Solid End Mills: $\chi = 90^\circ - \lambda$

NOTE: It makes no difference if the tool is solid or an indexable milling tool.

■ Differences between hm and hx

In conventional milling, it makes sense to calculate the load to the cutting edge through hm. With reducing the ae to very low values, you can calculate with the maximum chip thickness hx to make sure that the feed per tooth is set up correctly.

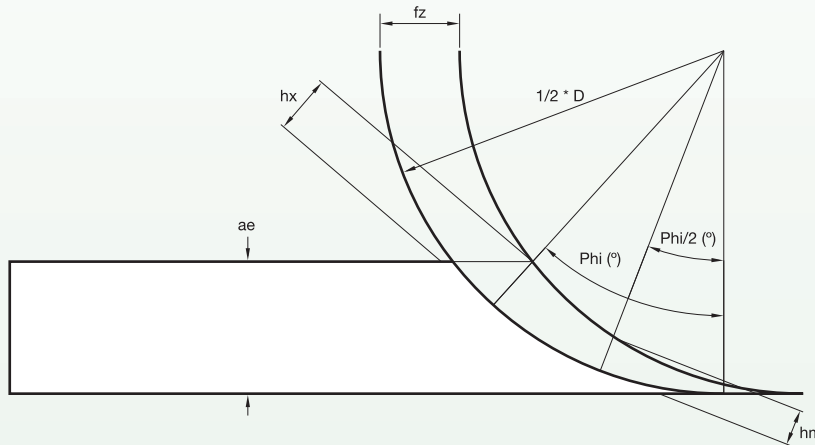

Conventional

$$h_m = 360^\circ / \pi \cdot \phi_s \cdot a_e / D \cdot f_z \cdot \sin \chi$$

- hm [mm] = average chip thickness
- fs [°] = engagement angle
- ae [mm] = width of engagement
- D1 [mm] = outer diameter tool
- fz [mm] = feed per tooth
- χ [°] = lead angle
- λ [°] = helix angle *

Smart Machining

$$h_x = 360^\circ / \pi \cdot \phi_s \cdot 2 \cdot a_e / D \cdot f_z \cdot \sin \chi$$

- hx [mm] = maximum chip thickness
- fs [°] = engagement angle
- ae [mm] = width of engagement
- D1 [mm] = outer diameter tool
- fz [mm] = feed per tooth
- χ [°] = lead angle
- λ [°] = helix angle *

* Solid End Mills: $\chi = 90^\circ - \lambda$

Trochoidal Milling can be performed with solid or indexable milling tools.

■ Cutting Speed

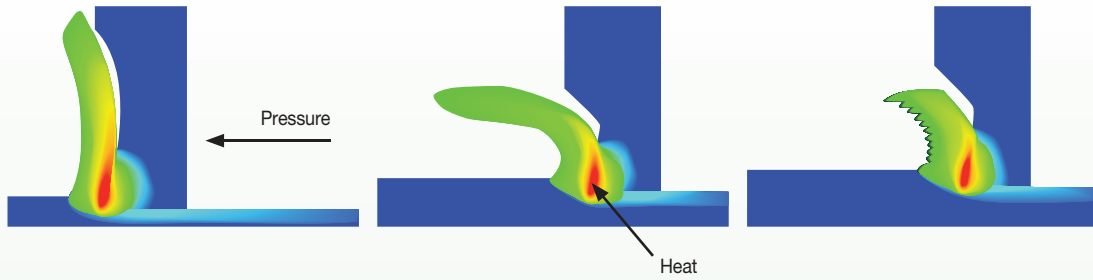

Reduced radial engagement influences the cutting speed, because the heat produced through the cutting process limits the cutting speed.

ae/D	full slot	50% ae	40% ae	30% ae	20% ae	10% ae	5% ae	4% ae
speed factors	0,9	1	1,1	1,2	1,3	1,4	2,5	3
phi [°]	180	90	78,46	66,42	53,13	36,87	25,84	23,07

■ Static Trochoidal Milling for a Full Slot

- Use a tool in which $D < b$.
- Programme circles in the CNC programme (as a cycle).
- After one circle, repeat the same with an offset.
- Optimise by shortening the lane "in the air" to a form like a "D".

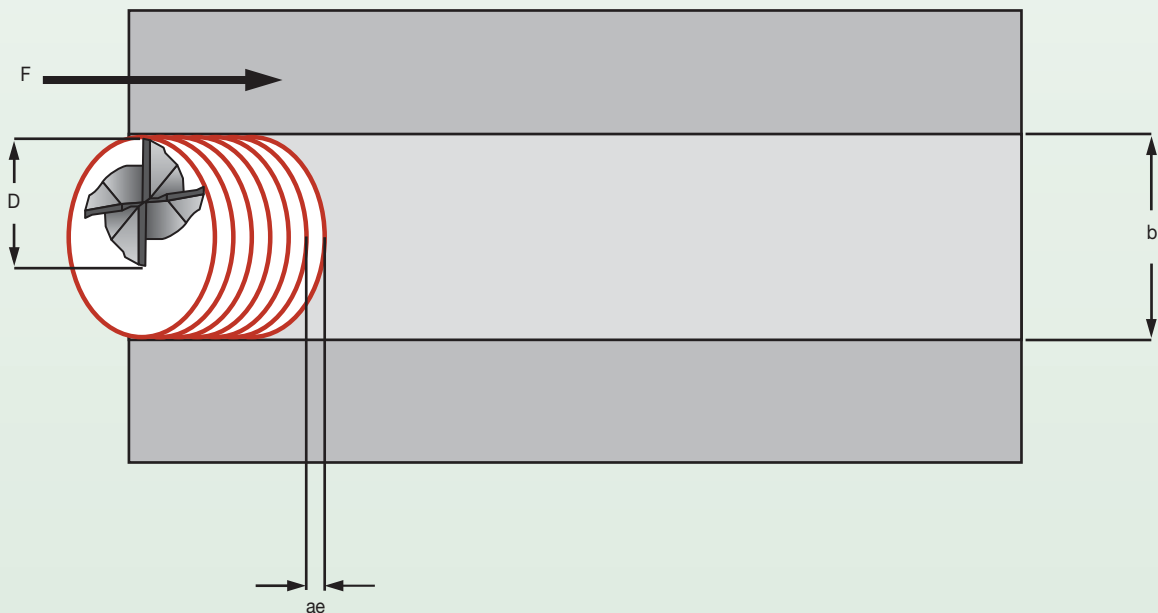

Trochoidal Milling can be performed with solid or indexable milling tools.

■ Dynamic Trochoidal Milling

- Transfer the basic idea control of chip thickness to dynamic processes.
- Dynamic adaption of feed in relation to ae and wrap angle through an intelligent CAM Software.
- Using helix interpolation, D-lanes, and morphing cycles.

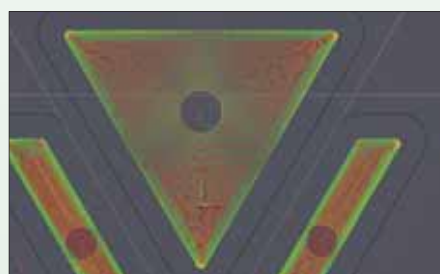
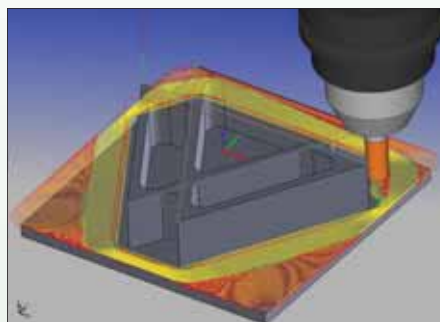
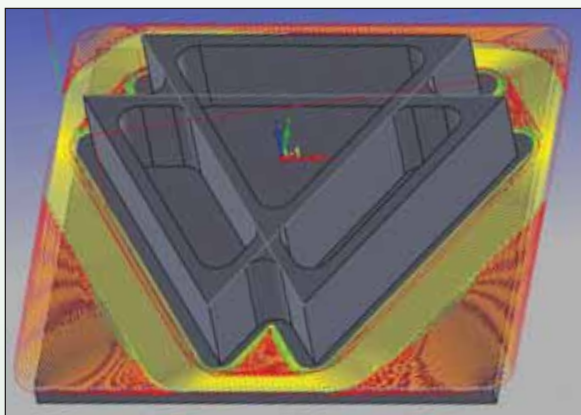

■ Requirements

Static trochoidal milling

- Dynamic machine.
- CNC Programme.
- Modern tool.
- Cutting data for trochoidal machining.

Dynamic trochoidal milling

- Dynamic CNC machine.
- CAD/CAM optimization software.
- Modern tool.
- Cutting data for trochoidal machining.

■ Benefits

- Constant chip thickness.
- Reduced arc/angle engagement (wrap angle).
- Tremendously reduced load on the cutting edge.
- Reduced temperature during the machining process.
- Higher cutting speed and feed per tooth possible.
- Reduced cycle time and increased tool life.
- Better chip evacuation.
- Better usage of the tool length.
- Less torque and power requirements for the machine.
- Less risk of spindle damages through torque fluctuation and reduced torque peaks caused by conventional milling processes.

VariMill III™ ER



EXTREME **CHALLENGES.**
EXTREME **RESULTS.**

VariMill III ER provides the highest metal removal rates and superior surface finish in the most demanding workpiece materials in the aerospace industry. WIDIA-Hanita™ combines its unmatched tooling technology with state-of-the-art surface treatments to deliver the highest quality and productivity you can rely on when it comes down to critical semi-finishing and finishing operations.

- 7-Flute design maximises Metal Removal Rates (MRR) and surface quality.
- Up to 30% radial engagement allowing for increased productivity.
- Perfectly suited for high-speed machining techniques such as trochoidal and peel milling.
- Central coolant hole on 2 x D tools; chip evacuation during pocketing.
- Available with SAFE-λOCK® as standard for increased tool life and anti-pullout.
- Available with all common aerospace radii.

To learn more about our innovations, contact your local Authorised Distributor or visit widia.com.

WIDIA 

High-Performance Solid Carbide End Mills • **SAFE-λOCK®**

In High-Performance Cutting (HPC), slow microcreeping can cause the cutting tool to be pulled out of the chuck, turning high-quality workpieces to scrap.

SAFE-λOCK®



Be on the safe side with SAFE-λOCK® in High-Performance Cutting (HPC).

- Highly accurate clamping due to positive connection.
- No loss of accuracy.
- No pullout or spinning of the tool.
- No damage to the workpiece or machine.
- Groove on tool shank is directed so the tool will be pulled into the chuck (depending on direction of rotation).

Order Information

WIDIA™ high-performance end mills with a shank diameter of 12mm and larger are available with SAFE-λOCK® technology, as a special tool, upon request. Please contact your local customer service location to receive a quote.

Features

- Form-closed clamping.
- High accuracy clamping.
- Helical grooves.

Functions

- No pullout.
- Excellent runout.
- Adjustable clamping length.

Benefits

- Reduce scrap rate.
- Higher tool life.
- No need to change NC programme after regrinding.





Example for Highest Metal Removal Rates (MRR)

The VariMill II ER proprietary design with unequal flute spacing and unique core geometry for chatter-free machining enables slotting operations in titanium up to 1 x D.



SAFE-λOCK®

The safety belt for high-performance solid carbide end mills provide form-closed clamping with high accuracy and helical grooves for length adjustment.

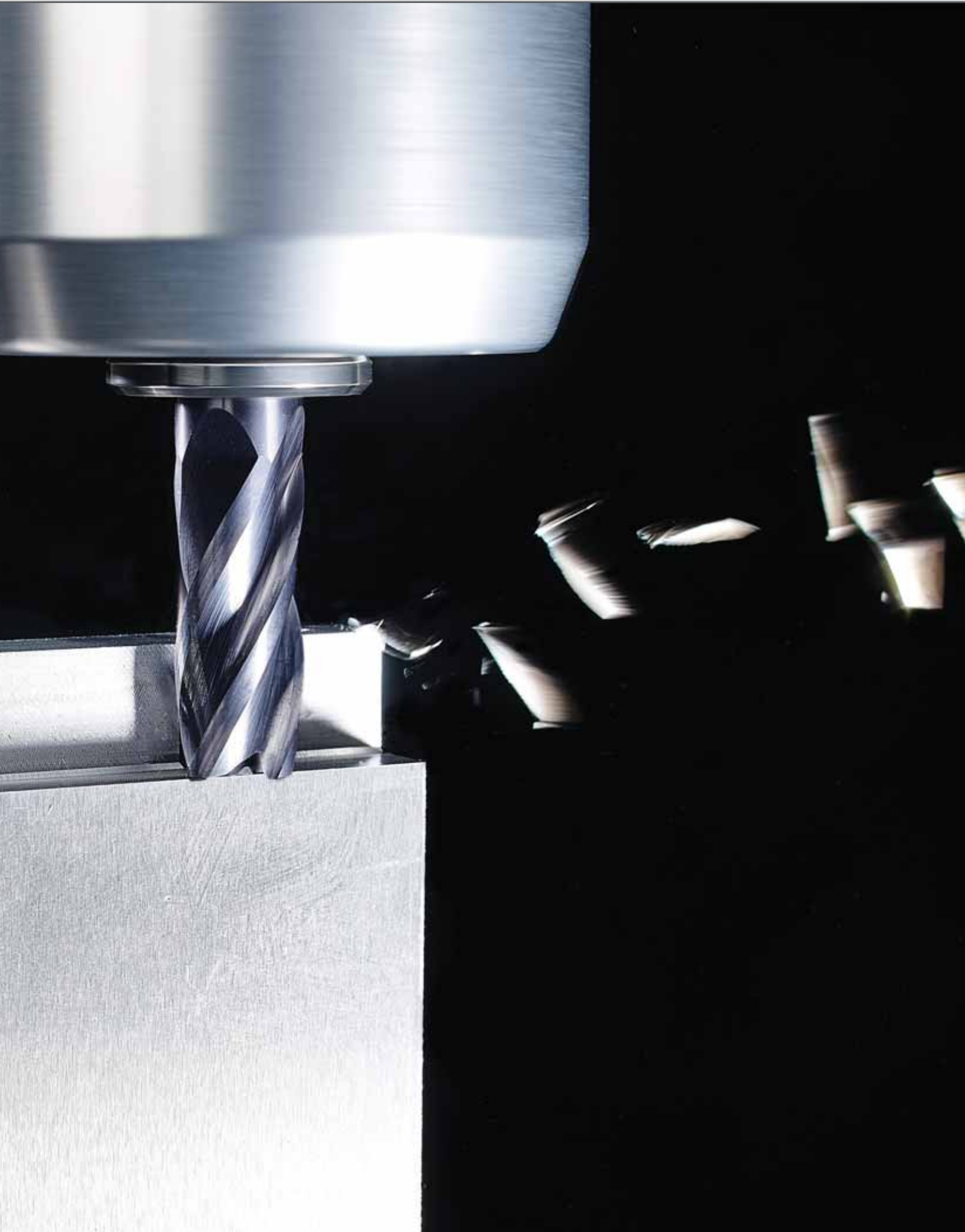

Solid End Milling • General Purpose Solid Carbide End Mills

NINA Solid Carbide Roughers and Finishers	M2-M11
VariMill General Purpose 2-Flute End Mills	M12-M26
VariMill General Purpose 3-Flute End Mills	M28
VariMill General Purpose 4-Flute End Mills	M30-M43



NINA™ Solid Carbide Roughers/Finishers

NINA



NINA is an economic choice for high quality and performance when regrinding is not justified. Designed to minimise tool costs for applications when short lengths-of-cut are required. NINA has a short, compact design with minimised vibration and soft cut to support mill-turn machines. A state-of-the-art substrate and wide range of coatings offers high tool life and stable manufacturing on a wide range of workpiece materials. With different front end styles (sharp edge, corner chamfer, radii, ball nose, and chamfering tool), NINA covers a wide range of applications. Roughing and finishing with one tool reduces tool inventory and tool changes providing increased productivity and value.

- One tool for roughing and finishing operations.
- Milling at a value price when re-grinding is not justified.
- Stable, low-vibration solution with soft cut for mill-turn machines.
- Wide range of front ends and coatings.

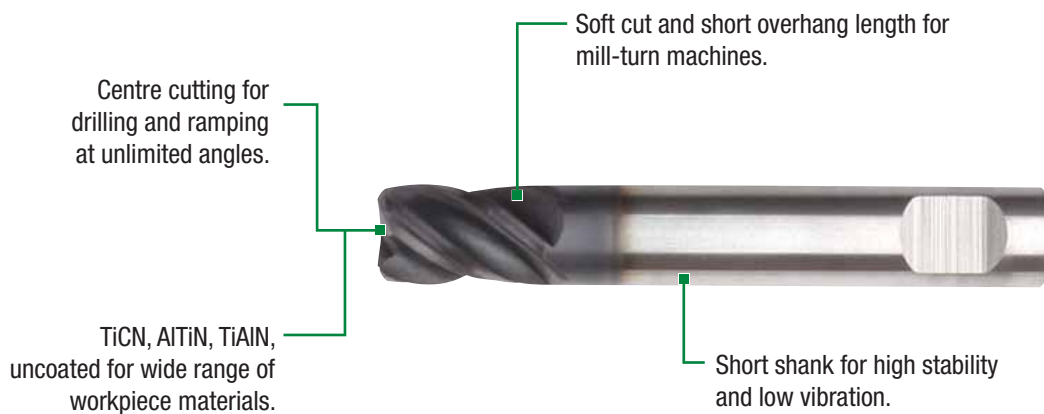

NINA™ Series

- Economic price, low-cost carbide substrate.
- Excellent results for applications when short lengths-of-cut are required.
- Reduce tool stock and ease tool management.
- Wide range of applications and materials with one tool.
- Rough and finish with one tool.

323002/423002/323001/423001 Series

- 3-flute.
- Sharp edge front end.
- TiCN/AlTiN coating.
- For steel, stainless steel, cast iron, and aluminium.
- Centre cutting.



423004/423003 Series

- 4-flute.
- Chamfer end for improved tool life.
- AlTiN coating.
- For steel, stainless steel, and cast iron.
- Centre cutting.



423048/423047 Series

- 2-flute.
- Radii for improved tool life and wider application range.
- AlTiN coating.
- For steel, stainless steel, and non-ferrous.
- Centre cutting.



423039/423008 Series

- 2-flute.
- Ball nose for 3D profiling.
- AlTiN coating.
- For steel, stainless steel, and non-ferrous.
- Centre cutting.

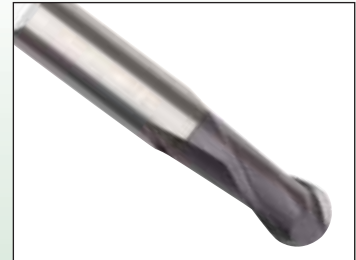

423036/423037 Series

- 4-flute.
- 90° point angle.
- AlTiN/TiAlN coating.
- For widest range of materials.

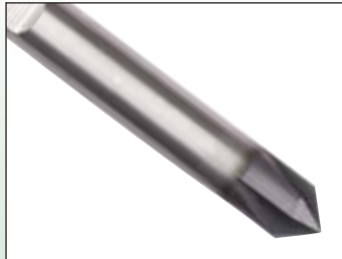

- Centre cutting.
- Standard items listed. Additional styles and coatings made-to-order.

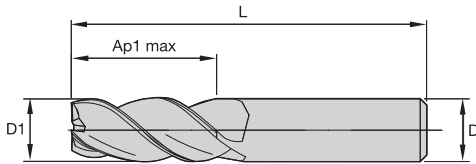
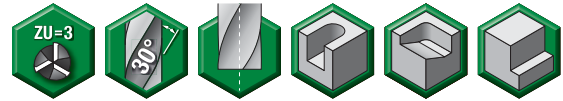

End Mill Tolerances

D1	tolerance h10 + / -	D	tolerance h6 + / -
≤ 3	0/0,04	≤ 3	0/0,006
> 3-6	0/0,048	> 3-6	0/0,008
> 6-10	0/0,058	> 6-10	0/0,009
> 10-18	0/0,070	> 10-18	0/0,011
> 18-30	0/0,084	> 18-30	0/0,013

Series 423002 323002 423001 323001 • NINA

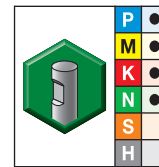
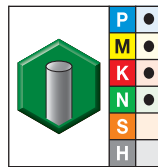
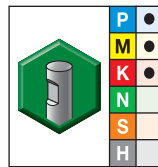
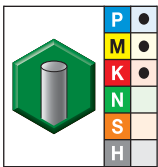

- first choice
- alternate choice

grade K30F-DCF TiAlN		grade K30F-DCF TiAlN		grade K30F-TiCN TiCN		grade K30F-TiCN TiCN		D1	D	length of cut Ap1 max	length L
order #	catalogue #	order #	catalogue #	order #	catalogue #	order #	catalogue #				
2627990	423002-000020	2343352	423001-000020	2627800	323002-000020	2336740	323001-000020	2,0	6	4,00	38
2628043	423002-000030	2343354	423001-000030	2627801	323002-000030	2336747	323001-000030	3,0	6	5,00	38
2628044	423002-000040	2343356	423001-000040	2627802	323002-000040	2336753	323001-000040	4,0	6	7,00	38
2628045	423002-000050	2343358	423001-000050	2627983	323002-000050	2336759	323001-000050	5,0	6	8,00	38
2628046	423002-000060	2343360	423001-000060	2627984	323002-000060	2336765	323001-000060	6,0	6	8,00	38
2628047	423002-000080	2343362	423001-000080	2627985	323002-000080	2336771	323001-000080	8,0	8	11,00	43
2628048	423002-000100	2343364	423001-000100	2627986	323002-000100	2336777	323001-000100	10,0	10	13,00	50
2628049	423002-000120	2343366	423001-000120	2627987	323002-000120	2336783	323001-000120	12,0	12	15,00	55

NOTE: For application data, please see page M9.

- Centre cutting.
- HPC.
- Standard items listed. Additional styles and coatings made-to-order.

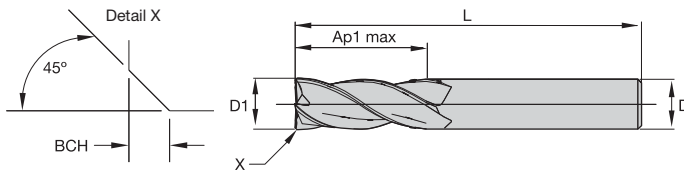

End Mill Tolerances

D1	tolerance h10 + / -	D	tolerance h6 + / -
≤ 3	0/0,04	≤ 3	0/0,006
> 3-6	0/0,048	> 3-6	0/0,008
> 6-10	0/0,058	> 6-10	0/0,009
> 10-18	0/0,070	> 10-18	0/0,011
> 18-30	0/0,084	> 18-30	0/0,013

■ Series 423004 423003 • NINA

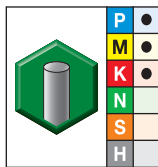

grade K30F-DCHP
AITiN

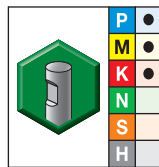

grade K30F-DCHP
AITiN

- first choice
- alternate choice

order #	catalogue #	order #	catalogue #	D1	D	length of cut Ap1 max	length L	BCH
3657761	423004-000040	3657756	423003-000040	4,0	6	7,00	38	0,40
3657762	423004-000060	3657757	423003-000060	6,0	6	8,00	38	0,40
3657763	423004-000080	3657758	423003-000080	8,0	8	11,00	43	0,40
3657764	423004-000100	3657759	423003-000100	10,0	10	13,00	50	0,50
3657765	423004-000120	3657760	423003-000120	12,0	12	15,00	55	0,50

NOTE: For application data, please see page M9.

- Centre cutting.
- Standard items listed. Additional styles and coatings made-to-order.

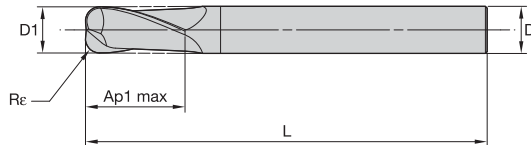
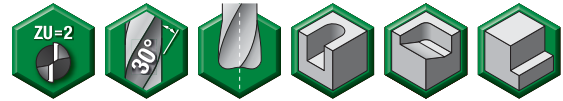

End Mill Tolerances

D1	tolerance h10 + / -	D	tolerance h6 + / -
≤ 3	0/0,04	≤ 3	0/0,006
> 3-6	0/0,048	> 3-6	0/0,008
> 6-10	0/0,058	> 6-10	0/0,009
> 10-18	0/0,070	> 10-18	0/0,011
> 18-30	0/0,084	> 18-30	0/0,013

Series 423048 423047 • NINA

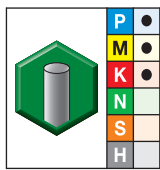

grade K30F-DCHP
TiAlN

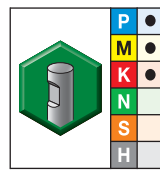

grade K30F-DCHP
TiAlN

- first choice
- alternate choice

order #	catalogue #	order #	catalogue #	D1	D	length of cut Ap1 max	length L	Rε
2343564	423048-000020	2343548	423047-000020	2,0	6	4,00	38	0,50
2343566	423048-000030	2343550	423047-000030	3,0	6	5,00	38	0,50
2343568	423048-000040	2343552	423047-000040	4,0	6	7,00	38	0,50
2343570	423048-000050	2343554	423047-000050	5,0	6	8,00	38	0,50
2343572	423048-000060	2343556	423047-000060	6,0	6	8,00	38	1,00
2343574	423048-000080	2343558	423047-000080	8,0	8	11,00	43	2,00
2343576	423048-000100	2343560	423047-000100	10,0	10	13,00	50	3,00
2343579	423048-000120	2343562	423047-000120	12,0	12	15,00	55	3,00

NOTE: For application data, please see page M10.

- Centre cutting.
- Standard items listed. Additional styles and coatings made-to-order.

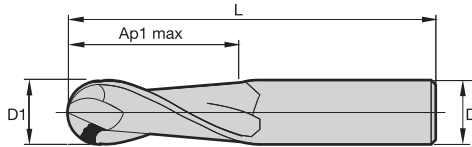

End Mill Tolerances

D1	tolerance h10 + / -	D	tolerance h6 + / -
≤ 3	0/0,04	≤ 3	0/0,006
> 3-6	0/0,048	> 3-6	0/0,008
> 6-10	0/0,058	> 6-10	0/0,009
> 10-18	0/0,070	> 10-18	0/0,011
> 18-30	0/0,084	> 18-30	0/0,013

■ Series 423039 423038 • NINA

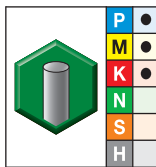

grade K30F-DCHP
TiAlN

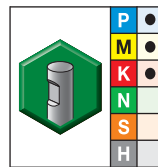

grade K30F-DCHP
TiAlN

- first choice
- alternate choice

order #	catalogue #	order #	catalogue #	D1	D	length of cut Ap1 max	length L
2343531	423039-000020	2343514	423038-000020	2,0	6	4,00	38
2343533	423039-000030	2343516	423038-000030	3,0	6	5,00	38
2343535	423039-000040	2343519	423038-000040	4,0	6	7,00	38
2343537	423039-000050	2343521	423038-000050	5,0	6	8,00	38
2343539	423039-000060	2343523	423038-000060	6,0	6	8,00	38
2343541	423039-000080	2343525	423038-000080	8,0	8	11,00	43
2343543	423039-000100	2343527	423038-000100	10,0	10	13,00	50
2343545	423039-000120	2343529	423038-000120	12,0	12	15,00	55

NOTE: For application data, please see page M10.

- Non-centre cutting.
- Chamfering.
- Standard items listed. Additional styles and coatings made-to-order.

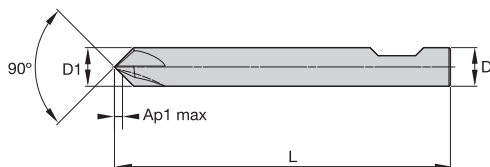

End Mill Tolerances

D1	tolerance h10 + / -	D	tolerance h6 + / -
≤ 3	0/0,04	≤ 3	0/0,006
> 3-6	0/0,048	> 3-6	0/0,008
> 6-10	0/0,058	> 6-10	0/0,009
> 10-18	0/0,070	> 10-18	0/0,011
> 18-30	0/0,084	> 18-30	0/0,013

■ Series 423036 423037 • NINA

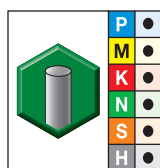

grade K30F-DCF
TiAlN

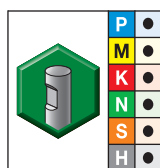

grade K30F-DCHP
AlTiN

- first choice
- alternate choice

order #	catalogue #	order #	catalogue #	D1	D	length of cut Ap1 max	length L
2343508	423036-000060	—	—	6,0	6	1,00	38
—	—	2628498	423037-000060	6,0	6	1,00	83
2343510	423036-000080	—	—	8,0	8	1,50	43
—	—	2628499	423037-000080	8,0	8	1,50	104
2343512	423036-000100	—	—	10,0	10	2,00	50
—	—	2628500	423037-000100	10,0	10	2,00	125

NOTE: For application data, please see page M11.

■ Series 423002 323002 423001 323001 • NINA

Material Group																			
	Side Milling (A) and Slotting (B)			K30F-TiCN			K30F-DCF			Recommended feed per tooth (fz = mm/th) for side milling (A). For slotting (B), reduce fz by 20%.									
				TiCN			TiAlN												
	A		B	Cutting Speed – vc m/min			Cutting Speed – vc m/min			D1 – Diameter									
ap	ae	ap	min	–	max	min	–	max	mm	2,0	3,0	4,0	5,0	6,0	8,0	10,0	12,0		
P	0	0,75 x D	0,5 x D	0,5 x D	150	–	200	150	–	200	fz	0,014	0,021	0,028	0,036	0,044	0,060	0,072	0,083
	1	0,75 x D	0,5 x D	0,5 x D	150	–	200	150	–	200	fz	0,014	0,021	0,028	0,036	0,044	0,060	0,072	0,083
	2	0,75 x D	0,5 x D	0,5 x D	140	–	190	140	–	190	fz	0,014	0,021	0,028	0,036	0,044	0,060	0,072	0,083
	3	0,75 x D	0,5 x D	0,5 x D	120	–	160	120	–	160	fz	0,011	0,017	0,023	0,030	0,036	0,050	0,061	0,070
	4	0,75 x D	0,5 x D	0,5 x D	90	–	150	90	–	150	fz	0,010	0,016	0,021	0,027	0,033	0,045	0,054	0,062
M	1	0,75 x D	0,5 x D	0,5 x D	90	–	115	90	–	115	fz	0,011	0,017	0,023	0,030	0,036	0,050	0,061	0,070
	2	0,75 x D	0,5 x D	0,5 x D	60	–	80	60	–	80	fz	0,009	0,014	0,019	0,024	0,029	0,040	0,048	0,056
K	1	0,75 x D	0,5 x D	0,5 x D	120	–	150	120	–	150	fz	0,014	0,021	0,028	0,036	0,044	0,060	0,072	0,083
	2	0,75 x D	0,5 x D	0,5 x D	110	–	140	110	–	140	fz	0,011	0,017	0,023	0,030	0,036	0,050	0,061	0,070
N	1	0,75 x D	0,5 x D	0,5 x D	500	–	2000	500	–	2000	fz	0,020	0,030	0,040	0,050	0,060	0,080	0,100	0,120
	2	0,75 x D	0,5 x D	0,5 x D	500	–	1500	500	–	1500	fz	0,018	0,027	0,036	0,045	0,054	0,072	0,090	0,108
	5	0,75 x D	0,5 x D	0,5 x D	250	–	1000	250	–	1000	fz	0,018	0,027	0,036	0,045	0,054	0,072	0,090	0,108

NOTE: Lower value of cutting speed is used for high stock removal applications or for higher hardness (machinability) within group.
Higher value of cutting speed is used for finishing applications or for lower hardness (machinability) within group.

Application Data • Series 423004 423003 • NINA

■ Series 423004 423003 • NINA

Material Group																	
	Side Milling (A) and Slotting (B)			K30F-DCHP			Recommended feed per tooth (fz = mm/th) for side milling (A). For slotting (B), reduce fz by 20%.										
				AlTiN													
	A		B	Cutting Speed – vc m/min			D1 – Diameter										
ap	ae	ap	min	–	max	mm	4,0	5,0	6,0	8,0	10,0	12,0					
P	0	1 x D	0,5 x D	1 x D	150	–	200	fz	0,028	0,036	0,044	0,060	0,072	0,083			
	1	1 x D	0,5 x D	1 x D	150	–	200	fz	0,028	0,036	0,044	0,060	0,072	0,083			
	2	1 x D	0,5 x D	1 x D	140	–	190	fz	0,028	0,036	0,044	0,060	0,072	0,083			
	3	1 x D	0,5 x D	1 x D	120	–	160	fz	0,023	0,030	0,036	0,050	0,061	0,070			
	4	1 x D	0,5 x D	1 x D	90	–	150	fz	0,021	0,027	0,033	0,045	0,054	0,062			
M	1	1 x D	0,5 x D	1 x D	90	–	115	fz	0,023	0,030	0,036	0,050	0,061	0,070			
	2	1 x D	0,5 x D	1 x D	60	–	80	fz	0,019	0,024	0,029	0,040	0,048	0,056			
K	1	1 x D	0,5 x D	1 x D	120	–	150	fz	0,028	0,036	0,044	0,060	0,072	0,083			
	2	1 x D	0,5 x D	1 x D	110	–	140	fz	0,023	0,030	0,036	0,050	0,061	0,070			
	3	1 x D	0,5 x D	1 x D	110	–	130	fz	0,019	0,024	0,029	0,040	0,048	0,056			
N	1	1 x D	0,5 x D	1 x D	500	–	2000	fz	0,040	0,050	0,060	0,080	0,100	0,120			
	2	1 x D	0,5 x D	1 x D	500	–	1500	fz	0,036	0,045	0,054	0,072	0,090	0,108			
	3	1 x D	0,5 x D	1 x D	250	–	1000	fz	0,036	0,045	0,054	0,072	0,090	0,108			

NOTE: Lower value of cutting speed is used for high stock removal applications or for higher hardness (machinability) within group.
Higher value of cutting speed is used for finishing applications or for lower hardness (machinability) within group.

■ Series 423048 423047 • NINA

Material Group														
	Side Milling (A) and Slotting (B)			K30F-DCHP			Recommended feed per tooth (fz = mm/th) for side milling (A). For slotting (B), reduce fz by 20%.							
				AITiN										
	A		B	Cutting Speed – vc m/min			D1 – Diameter							
ap	ae	ap	min	–	max	mm	4,0	5,0	6,0	8,0	10,0	12,0		
P	0	0,75 x D	0,5 x D	0,5 x D	150	–	200	fz	0,028	0,036	0,044	0,060	0,072	0,083
	1	0,75 x D	0,5 x D	0,5 x D	150	–	200	fz	0,028	0,036	0,044	0,060	0,072	0,083
	2	0,75 x D	0,5 x D	0,5 x D	140	–	190	fz	0,028	0,036	0,044	0,060	0,072	0,083
	3	0,75 x D	0,5 x D	0,5 x D	120	–	160	fz	0,023	0,030	0,036	0,050	0,061	0,070
	4	0,75 x D	0,5 x D	0,5 x D	90	–	150	fz	0,021	0,027	0,033	0,045	0,054	0,062
M	1	0,75 x D	0,5 x D	0,5 x D	90	–	115	fz	0,023	0,030	0,036	0,050	0,061	0,070
	2	0,75 x D	0,5 x D	0,5 x D	60	–	80	fz	0,019	0,024	0,029	0,040	0,048	0,056
K	1	0,75 x D	0,5 x D	0,5 x D	120	–	150	fz	0,028	0,036	0,044	0,060	0,072	0,083
	2	0,75 x D	0,5 x D	0,5 x D	110	–	140	fz	0,023	0,030	0,036	0,050	0,061	0,070
N	1	0,75 x D	0,5 x D	0,5 x D	500	–	2000	fz	0,040	0,050	0,060	0,080	0,100	0,120
	2	0,75 x D	0,5 x D	0,5 x D	500	–	1500	fz	0,036	0,045	0,054	0,072	0,090	0,108
	5	0,75 x D	0,5 x D	0,5 x D	250	–	1000	fz	0,036	0,045	0,054	0,072	0,090	0,108

NOTE: Lower value of cutting speed is used for high stock removal applications or for higher hardness (machinability) within group. Higher value of cutting speed is used for finishing applications or for lower hardness (machinability) within group.



Application Data • Series 423039 423038 • NINA

■ Series 423039 423038 • NINA

Material Group														
	Side Milling (A) and Slotting (B)			K30F-DCHP			Recommended Feed Per Tooth (fz = mm/th) for 3D milling/profiling							
				AITiN										
	A		B	Cutting Speed – vc m/min			D1 – Diameter							
ap	ae	ap	min	–	max	mm	4,0	5,0	6,0	8,0	10,0	12,0		
P	0	0,75 x D	0,5 x D	0,5 x D	150	–	200	fz	0,028	0,036	0,044	0,060	0,072	0,083
	1	0,75 x D	0,5 x D	0,5 x D	150	–	200	fz	0,028	0,036	0,044	0,060	0,072	0,083
	2	0,75 x D	0,5 x D	0,5 x D	140	–	190	fz	0,028	0,036	0,044	0,060	0,072	0,083
	3	0,75 x D	0,5 x D	0,5 x D	120	–	160	fz	0,023	0,030	0,036	0,050	0,061	0,070
	4	0,75 x D	0,5 x D	0,5 x D	90	–	150	fz	0,021	0,027	0,033	0,045	0,054	0,062
M	1	0,75 x D	0,5 x D	0,5 x D	90	–	115	fz	0,023	0,030	0,036	0,050	0,061	0,070
	2	0,75 x D	0,5 x D	0,5 x D	60	–	80	fz	0,019	0,024	0,029	0,040	0,048	0,056
K	1	0,75 x D	0,5 x D	0,5 x D	120	–	150	fz	0,028	0,036	0,044	0,060	0,072	0,083
	2	0,75 x D	0,5 x D	0,5 x D	110	–	140	fz	0,023	0,030	0,036	0,050	0,061	0,070
N	1	0,75 x D	0,5 x D	0,5 x D	500	–	2000	fz	0,040	0,050	0,060	0,080	0,100	0,120
	2	0,75 x D	0,5 x D	0,5 x D	500	–	1500	fz	0,036	0,045	0,054	0,072	0,090	0,108
	5	0,75 x D	0,5 x D	0,5 x D	250	–	1000	fz	0,036	0,045	0,054	0,072	0,090	0,108

NOTE: Lower value of cutting speed is used for high stock removal applications or for higher hardness (machinability) within group. Higher value of cutting speed is used for finishing applications or for lower hardness (machinability) within group.

■ Series 423036 423037 • NINA

Material Group													
	Chamfer Milling		K30F-DCF			K30F-DCHP			Recommended feed per tooth (fz = mm/th) for chamfering (A)				
	A		TiAlN			AlTiN			mm	D1 – Diameter			
	ap	ae	Cutting Speed – vc m/min			Cutting Speed – vc m/min				6,0	8,0	10,0	
		min	–	max	min	–	max						
P	0	0,35 x D	0,35 x D	150	–	200	150	–	200	fz	0,035	0,048	0,058
	1	0,35 x D	0,35 x D	150	–	200	150	–	200	fz	0,035	0,048	0,058
	2	0,35 x D	0,35 x D	140	–	190	140	–	190	fz	0,035	0,048	0,058
	3	0,35 x D	0,35 x D	120	–	160	120	–	160	fz	0,029	0,040	0,048
	4	0,35 x D	0,35 x D	90	–	150	90	–	150	fz	0,026	0,036	0,043
	5	0,35 x D	0,35 x D	60	–	100	60	–	100	fz	0,024	0,032	0,039
M	1	0,35 x D	0,35 x D	90	–	115	90	–	115	fz	0,029	0,040	0,048
	2	0,35 x D	0,35 x D	60	–	80	60	–	80	fz	0,024	0,032	0,039
	3	0,35 x D	0,35 x D	60	–	70	60	–	70	fz	0,020	0,027	0,032
K	1	0,35 x D	0,35 x D	120	–	150	120	–	150	fz	0,035	0,048	0,058
	2	0,35 x D	0,35 x D	110	–	140	110	–	140	fz	0,029	0,040	0,048
	3	0,35 x D	0,35 x D	110	–	130	110	–	130	fz	0,024	0,032	0,039
N	1	0,35 x D	0,35 x D	500	–	2000	500	–	2000	fz	0,048	0,064	0,080
	2	0,35 x D	0,35 x D	500	–	1500	500	–	1500	fz	0,043	0,058	0,072
	3	0,35 x D	0,35 x D	500	–	1500	500	–	1500	fz	0,034	0,045	0,056
	4	0,35 x D	0,35 x D	400	–	750	400	–	750	fz	0,038	0,051	0,064
	5	0,35 x D	0,35 x D	250	–	1000	250	–	1000	fz	0,043	0,058	0,072
	6	0,35 x D	0,35 x D	100	–	750	100	–	750	fz	0,048	0,064	0,080
	7	0,35 x D	0,35 x D	100	–	750	100	–	750	fz	0,034	0,045	0,056
S	1	0,35 x D	0,35 x D	50	–	90	50	–	90	fz	0,029	0,040	0,048
	2	0,35 x D	0,35 x D	25	–	40	25	–	40	fz	0,016	0,021	0,026
	3	0,35 x D	0,35 x D	60	–	80	60	–	80	fz	0,024	0,032	0,039
	4	0,35 x D	0,35 x D	50	–	60	50	–	60	fz	0,021	0,029	0,036
H	1	0,35 x D	0,35 x D	80	–	140	80	–	140	fz	0,026	0,036	0,043

General Purpose Solid Carbide End Mills

General Purpose 2-Flute End Mills •

VariMill™ GP

VariMill GP



VariMill GP offers plunging, slotting, and profiling for a wide range of materials and applications. Designed to provide high metal removal rates and excellent surface conditions at a value price. A wide range of diameters, lengths, and corner styles (such as chamfered, sharp edge, and ball nose) are available from stock.

VariMill GP • 2-Flute

- General purpose tools for a wide range of workpiece materials.
- Roughing and finishing with one tool.
- Various lengths-of-cut and overall lengths with different front end designs available.
- Two flutes for high flexibility in unstable conditions.

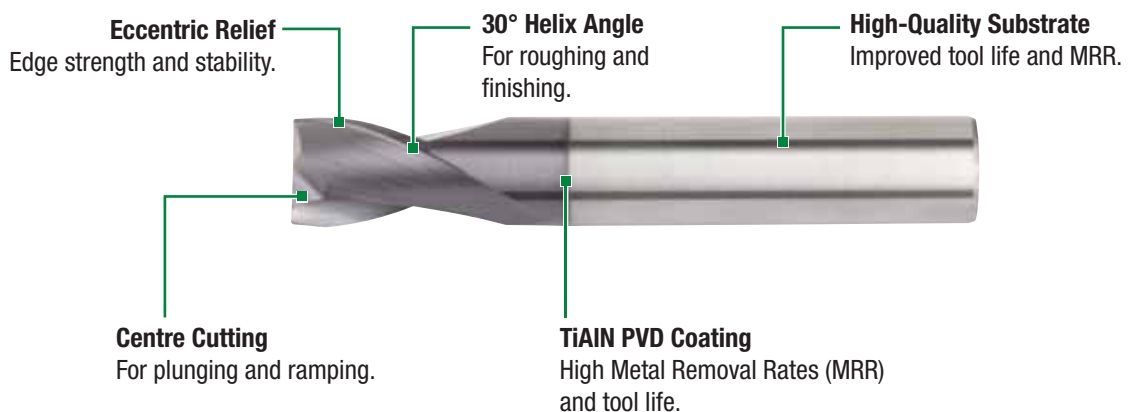

VariMill™ GP

- Increased manufacturing flexibility and reduced tooling cost.
- Fewer tool changes and high Metal Removal Rates (MRR).
- Eccentric relief for improved edge stability and high tool life.
- Easy and cost-efficient regrinding due to eccentric relief.

D002/D012 Series

- Centre cutting.
- DIN 6527 standard dimensions — short and long.
- Steel, stainless steel, and cast iron.
- Corner chamfer for increased tool life.

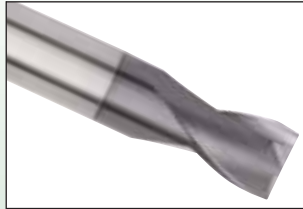

2819 Series

- Centre cutting.
- DIN 6528 standard dimensions.
- Steel, stainless steel, and cast iron.
- Corner chamfer for increased tool life.



4002/4012/4022 Series

- Centre cutting.
- Wide range of lengths-of-cut — regular, long, and extra long.
- Steel, stainless steel, and cast iron.
- Corner chamfer for increased tool life.

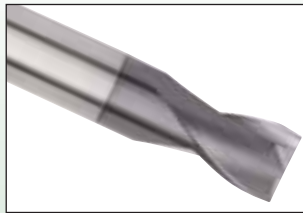

D001/D011 Series

- DIN 6527 standard dimensions — short and long.
- Steel, stainless steel, and cast iron.
- Centre cut ball nose.



2838 Series

- DIN 6528 standard dimensions.
- Steel, stainless steel, and cast iron.
- Centre cut ball nose.



4001/4011/4021 Series

- Wide range of lengths-of-cut — regular, long, and extra long.
- Steel, stainless steel, and cast iron.
- Centre cut ball nose.



- Centre cutting.
- Chamfered corners.
- Standard items listed. Additional styles and coatings made-to-order.

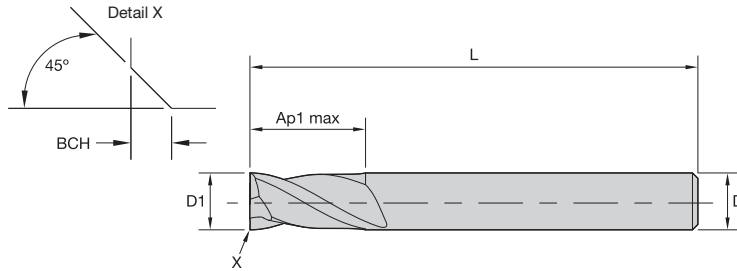

End Mill Tolerances

D1	tolerance e8	D	tolerance h6 +/-
≤ 3	-0,014/-0,028	≤ 3	0/0,006
> 3-6	-0,020/-0,038	> 3-6	0/0,008
> 6-10	-0,025/-0,047	> 6-10	0/0,009
> 10-18	-0,032/-0,059	> 10-18	0/0,011
> 18-30	-0,040/-0,073	> 18-30	0/0,013

■ Series D002 D012 • VariMill GP

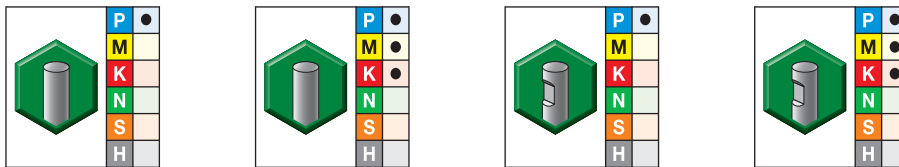

- first choice
- alternate choice

grade UNCOATED		grade TiAlN TiAlN		grade UNCOATED		grade TiAlN TiAlN		D1	D	length of cut Ap1 max	length L	BCH
order #	catalogue #	order #	catalogue #	order #	catalogue #	order #	catalogue #					
5877567	D0020200T003	5877330	D0020200T003	—	—	—	—	2,0	6	3,00	50	—
5877568	D0020250T003	5877501	D0020250T003	—	—	—	—	2,5	6	3,00	50	—
5877569	D0120250T007	5877502	D0120250T007	—	—	—	—	2,5	6	7,00	57	—
5877571	D0020300T004	5877503	D0020300T004	—	—	—	—	3,0	6	4,00	50	—
5877572	D0120300T007	5877504	D0120300T007	—	—	—	—	3,0	6	7,00	57	—
5877573	D0020350T004	5877505	D0020350T004	—	—	—	—	3,5	6	4,00	50	—
5877574	D0020400T005	5877506	D0020400T005	—	—	—	—	4,0	6	5,00	54	0,10
6092391	D0020400T005S	6092298	D0020400T005S	—	—	—	—	4,0	6	5,00	54	—
6092392	D0120400T008S	6092299	D0120400T008S	—	—	—	—	4,0	6	8,00	57	—
5877575	D0120400T008	5877507	D0120400T008	—	—	—	—	4,0	6	8,00	57	0,10
6092394	D0020450T005S	6092300	D0020450T005S	—	—	—	—	4,5	6	5,00	54	—
5877576	D0020450T005	5877509	D0020450T005	—	—	—	—	4,5	6	5,00	54	0,10
6092395	D0120450T008S	6092301	D0120450T008S	—	—	—	—	4,5	6	8,00	57	—
5877577	D0120450T008	5877510	D0120450T008	—	—	—	—	4,5	6	8,00	57	0,10
6092397	D0020500T006S	6092302	D0020500T006S	—	—	—	—	5,0	6	6,00	54	—
5877578	D0020500T006	5877511	D0020500T006	—	—	—	—	5,0	6	6,00	54	0,10
6092398	D0120500T010S	6092303	D0120500T010S	—	—	—	—	5,0	6	10,00	57	—
5877579	D0120500T010	5877512	D0120500T010	—	—	—	—	5,0	6	10,00	57	0,10
6092399	D0020600T007S	6092304	D0020600T007S	—	—	—	—	6,0	6	7,00	54	—
5877581	D0020600T007	5877513	D0020600T007	—	—	—	—	6,0	6	7,00	54	0,10
6092411	D0120600T010S	6092305	D0120600T010S	—	—	—	—	6,0	6	10,00	57	—
5877582	D0120600T010	5877514	D0120600T010	—	—	—	—	6,0	6	10,00	57	0,10
6092412	D0020700T008S	6092306	D0020700T008S	—	—	—	—	7,0	8	8,00	58	—
5877583	D0020700T008	5877515	D0020700T008	—	—	—	—	7,0	8	8,00	58	0,10
6092414	D0120700T013S	6092307	D0120700T013S	—	—	—	—	7,0	8	13,00	63	—
5877584	D0120700T013	5877516	D0120700T013	—	—	—	—	7,0	8	13,00	63	0,10
6092415	D0020800T009S	6092308	D0020800T009S	—	—	—	—	8,0	8	9,00	58	—
5877585	D0020800T009	5877517	D0020800T009	—	—	—	—	8,0	8	9,00	58	0,20

(continued)

(Series D002 D012 • VariMill GP — continued)

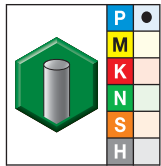
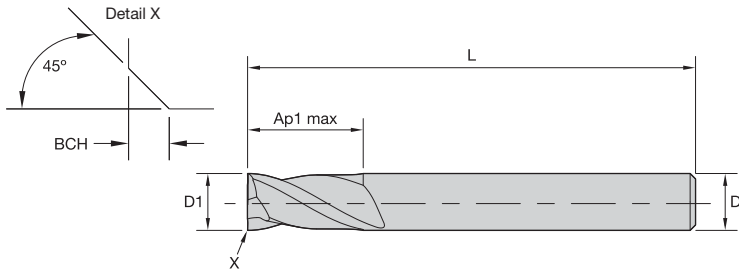

grade UNCOATED

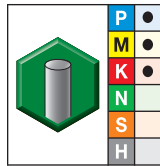

grade TiAlN
TiAlN

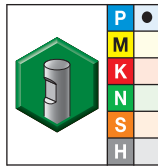

grade UNCOATED

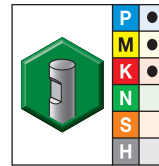

grade TiAlN
TiAlN

- first choice
- alternate choice

grade UNCOATED		grade TiAlN TiAlN		grade UNCOATED		grade TiAlN TiAlN		D1	D	length of cut Ap1 max	length L	BCH
order #	catalogue #	order #	catalogue #	order #	catalogue #	order #	catalogue #					
6092416	D0120800T016S	6092309	D0120800T016S	—	—	—	—	8,0	8	16,00	63	—
5877586	D0120800T016	5877518	D0120800T016	—	—	—	—	8,0	8	16,00	63	0,20
6092418	D0020900T010S	6092310	D0020900T010S	—	—	—	—	9,0	10	10,00	66	—
5877588	D0020900T010	5877520	D0020900T010	—	—	—	—	9,0	10	10,00	66	0,20
6092419	D0120900T016S	6092321	D0120900T016S	—	—	—	—	9,0	10	16,00	72	—
5877589	D0120900T016	5877521	D0120900T016	—	—	—	—	9,0	10	16,00	72	0,20
6092421	D0021000T011S	6092322	D0021000T011S	—	—	—	—	10,0	10	11,00	66	—
5877590	D0021000T011	5877522	D0021000T011	—	—	—	—	10,0	10	11,00	66	0,20
6092422	D0121000T019S	6092323	D0121000T019S	—	—	—	—	10,0	10	19,00	72	—
5877591	D0121000T019	5877523	D0121000T019	—	—	—	—	10,0	10	19,00	72	0,20
6092423	D0021200T012S	6092324	D0021200T012S	6092345	D0021200W012S	6092334	D0021200W012S	12,0	12	12,00	73	—
5877592	D0021200T012	5877524	D0021200T012	5877556	D0021200W012	5877535	D0021200W012	12,0	12	12,00	73	0,30
6092424	D0121200T022S	6092325	D0121200T022S	6092346	D0121200W022S	6092335	D0121200W022S	12,0	12	22,00	83	—
5877593	D0121200T022	5877525	D0121200T022	5877557	D0121200W022	5877537	D0121200W022	12,0	12	22,00	83	0,30
6092426	D0021400T014S	6092326	D0021400T014S	6092347	D0021400W014S	6092336	D0021400W014S	14,0	14	14,00	75	—
5877594	D0021400T014	5877526	D0021400T014	5877558	D0021400W014	5877538	D0021400W014	14,0	14	14,00	75	0,30
6092427	D0121400T022S	6092327	D0121400T022S	6092348	D0121400W022S	6092337	D0121400W022S	14,0	14	22,00	83	—
5877595	D0121400T022	5877527	D0121400T022	5877559	D0121400W022	5877539	D0121400W022	14,0	14	22,00	83	0,30
6092429	D0021600T016S	6092328	D0021600T016S	6092349	D0021600W016S	6092338	D0021600W016S	16,0	16	16,00	82	—
5877596	D0021600T016	5877529	D0021600T016	5877560	D0021600W016	5877540	D0021600W016	16,0	16	16,00	82	0,30
6092431	D0121600T026S	6092329	D0121600T026S	6092350	D0121600W026S	6092339	D0121600W026S	16,0	16	26,00	92	—
5877597	D0121600T026	5877530	D0121600T026	5877561	D0121600W026	5877551	D0121600W026	16,0	16	26,00	92	0,30
6092432	D0021800T018S	6092330	D0021800T018S	6092381	D0021800W018S	6092340	D0021800W018S	18,0	18	18,00	84	—
5877598	D0021800T018	5877531	D0021800T018	5877563	D0021800W018	5877552	D0021800W018	18,0	18	18,00	84	0,30
6092435	D0121800T026S	6092331	D0121800T026S	6092382	D0121800W026S	6092341	D0121800W026S	18,0	18	26,00	92	—
5877599	D0121800T026	5877532	D0121800T026	5877564	D0121800W026	5877553	D0121800W026	18,0	18	26,00	92	0,30
6092436	D0022000T020S	6092332	D0022000T020S	6092383	D0022000W020S	6092342	D0022000W020S	20,0	20	20,00	92	—
5877601	D0022000T020	5877533	D0022000T020	5877565	D0022000W020	5877554	D0022000W020	20,0	20	20,00	92	0,30
6092438	D0122000T032S	6092333	D0122000T032S	6092384	D0122000W032S	6092344	D0122000W032S	20,0	20	32,00	104	—
5877602	D0122000T032	5877534	D0122000T032	5877566	D0122000W032	5877555	D0122000W032	20,0	20	32,00	104	0,30

NOTE: For application data, please see page M23.

- Centre cutting.
- Chamfered corners.
- Standard items listed. Additional styles and coatings made-to-order.

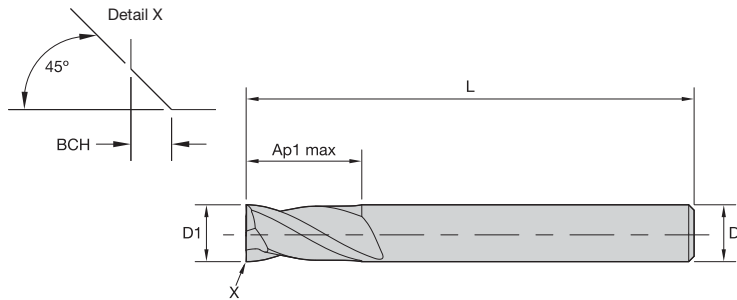

End Mill Tolerances

D1	tolerance e8	D	tolerance h6 +/-
≤ 3	-0,014/-0,028	≤ 3	0/0,006
> 3-6	-0,020/-0,038	> 3-6	0/0,008
> 6-10	-0,025/-0,047	> 6-10	0/0,009
> 10-18	-0,032/-0,059	> 10-18	0/0,011
> 18-30	-0,040/-0,073	> 18-30	0/0,013

Series 2819 • VariMill GP

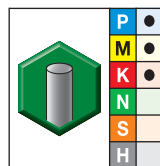
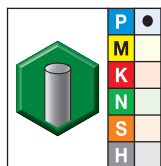

- first choice
- alternate choice

grade UNCOATED

grade TiAlN
TiAlN

order #	catalogue #	order #	catalogue #	D1	D	length of cut Ap1 max	length L	BCH
5877617	28190300T007	5877603	28190300T007	3,0	3	8,00	50	—
6092573	28190400T008S	6092528	28190400T008S	4,0	4	8,00	50	—
5877618	28190400T008	5877604	28190400T008	4,0	4	8,00	50	0,10
6092574	28190500T010S	6092529	28190500T010S	5,0	5	10,00	50	—
5877619	28190500T010	5877605	28190500T010	5,0	5	10,00	50	0,10
6092576	28190600T010S	6092530	28190600T010S	6,0	6	10,00	57	—
5877620	28190600T010	5877606	28190600T010	6,0	6	10,00	57	0,10
6092577	28190700T013S	6092561	28190700T013S	7,0	7	13,00	60	—
5877621	28190700T013	5877607	28190700T013	7,0	7	13,00	60	0,10
6092578	28190800T016S	6092562	28190800T016S	8,0	8	16,00	63	—
5877622	28190800T016	5877608	28190800T016	8,0	8	16,00	63	0,20
6092579	28190900T016S	6092563	28190900T016S	9,0	9	16,00	67	—
5877623	28190900T016	5877609	28190900T016	9,0	9	16,00	67	0,20
6092580	28191000T019S	6092565	28191000T019S	10,0	10	19,00	72	—
5877624	28191000T019	5877610	28191000T019	10,0	10	19,00	72	0,20
6092581	28191200T022S	6092566	28191200T022S	12,0	12	22,00	83	—
5877625	28191200T022	5877611	28191200T022	12,0	12	22,00	83	0,30
6092582	28191400T022S	6092567	28191400T022S	14,0	14	22,00	83	—
5877626	28191400T022	5877612	28191400T022	14,0	14	22,00	83	0,30
6092583	28191500T026S	6092568	28191500T026S	15,0	15	26,00	92	—
5877627	28191500T026	5877613	28191500T026	15,0	15	26,00	92	0,30
6092584	28191600T026S	6092569	28191600T026S	16,0	16	26,00	92	—
5877628	28191600T026	5877614	28191600T026	16,0	16	26,00	92	0,30
6092585	28191800T026S	6092570	28191800T026S	18,0	18	26,00	92	—
5877629	28191800T026	5877615	28191800T026	18,0	18	26,00	92	0,30
6092586	28192000T032S	6092571	28192000T032S	20,0	20	32,00	104	—
5877630	28192000T032	5877616	28192000T032	20,0	20	32,00	104	0,30

NOTE: For application data, please see page M23.

- Centre cutting.
- Chamfered corners.
- Standard items listed. Additional styles and coatings made-to-order.

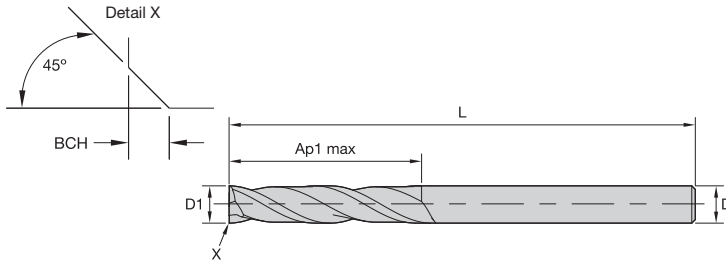

End Mill Tolerances

D1	tolerance e8	D	tolerance h6 + / -
≤ 3	-0,014/-0,028	≤ 3	0/0,006
> 3-6	-0,020/-0,038	> 3-6	0/0,008
> 6-10	-0,025/-0,047	> 6-10	0/0,009
> 10-18	-0,032/-0,059	> 10-18	0/0,011
> 18-30	-0,040/-0,073	> 18-30	0/0,013

■ Series 4002 4012 • VariMill GP

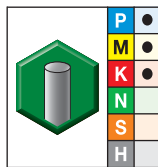

- first choice
- alternate choice

order #	catalogue #	grade TiAlN TiAlN	D1	D	length of cut Ap1 max	length L	BCH
5873484	40020100T004		1,0	3	4,00	38	—
5873485	40020150T004		1,5	3	4,00	38	—
5873486	40020180T004		1,8	3	4,00	38	—
5873487	40020200T006		2,0	3	6,30	38	—
5873488	40020250T006		2,5	3	6,30	38	—
5873489	40020300T009		3,0	3	9,50	38	—
5873490	40020300T019		3,0	3	19,00	63	—
5873491	40120300T025		3,0	3	25,00	75	—
5873492	40020350T012		3,5	4	12,00	50	—
5873493	40020400T012		4,0	4	12,00	50	0,10
6092621	40020400T012S		4,0	4	12,00	50	—
5873494	40020400T019		4,0	4	19,00	63	0,10
6092622	40020400T019S		4,0	4	19,00	63	—
6092623	40120400T031S		4,0	4	31,00	75	—
5873495	40120400T031		4,0	4	31,00	75	0,10
6092624	40020450T014S		4,5	6	14,00	50	—
5873496	40020450T014		4,5	6	14,00	50	0,10
5873497	40020480T014		4,8	6	14,00	50	0,10
6092626	40020480T014S		4,8	6	14,00	50	—
5873498	40020500T014		5,0	5	14,00	50	0,10
6092627	40020500T014S		5,0	5	14,00	50	—
5873499	40020500T020		5,0	5	20,00	63	0,10
6092628	40020500T020S		5,0	5	20,00	63	—
6092631	40120500T031S		5,0	5	31,00	100	—
5873500	40120500T031		5,0	5	31,00	100	0,10
5873501	40020550T014		5,5	6	14,00	50	0,10
6092632	40020550T014S		5,5	6	14,00	50	—
6092633	40020600T016S		6,0	6	16,00	50	—
5873502	40020600T016		6,0	6	16,00	50	0,10
5873503	40020600T028		6,0	6	28,00	76	0,10
6092634	40020600T028S		6,0	6	28,00	76	—
6092636	40120600T038S		6,0	6	38,00	100	—
5873504	40120600T038		6,0	6	38,00	100	0,10
6092637	40020700T020S		7,0	7	20,00	63	—
5873505	40020700T020		7,0	7	20,00	63	0,10
5873506	40020800T020		8,0	8	20,00	63	0,20

(continued)
M17

(Series 4002 4012 • VariMill GP — continued)

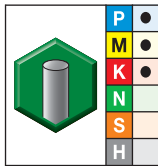
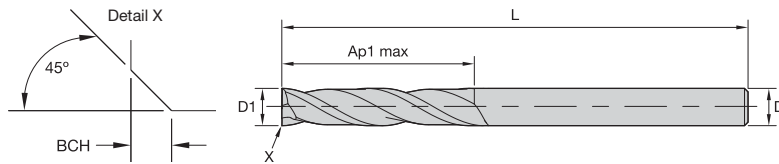

● first choice
○ alternate choice

grade TiAlN
TiAlN

order #	catalogue #	D1	D	length of cut Ap1 max	length L	BCH
6092638	40020800T020S	8,0	8	20,00	63	—
6092639	40020800T028S	8,0	8	28,00	76	—
5873507	40020800T028	8,0	8	28,00	76	0,20
6092640	40120800T041S	8,0	8	41,00	100	—
5873508	40120800T041	8,0	8	41,00	100	0,20
5873509	40020900T020	9,0	9	20,00	63	0,20
6092641	40020900T020S	9,0	9	20,00	63	—
5873510	40021000T022	10,0	10	22,00	72	0,20
6092643	40021000T022S	10,0	10	22,00	72	—
6092644	40021000T032S	10,0	10	32,00	89	—
5873511	40021000T032	10,0	10	32,00	89	0,20
6092645	40121000T045S	10,0	10	45,00	100	—
5873512	40121000T045	10,0	10	45,00	100	0,20
6092646	40021100T025S	11,0	11	25,00	76	—
5873513	40021100T025	11,0	11	25,00	76	0,30
5873514	40021200T025	12,0	12	25,00	76	0,30
6092647	40021200T025S	12,0	12	25,00	76	—
5873515	40021200T045	12,0	12	45,00	100	0,30
6092648	40021200T045S	12,0	12	45,00	100	—
6092650	40121200T075S	12,0	12	75,00	150	—
5873516	40121200T075	12,0	12	75,00	150	0,30
6092651	40021400T032S	14,0	14	32,00	83	—
5873517	40021400T032	14,0	14	32,00	83	0,30
6092653	40021400T050S	14,0	14	50,00	100	—
5873518	40021400T050	14,0	14	50,00	100	0,30
6092654	40121400T075S	14,0	14	75,00	150	—
5873519	40121400T075	14,0	14	75,00	150	0,30
5873520	40021600T032	16,0	16	32,00	89	0,30
6092657	40021600T032S	16,0	16	32,00	89	—
6092658	40021600T056S	16,0	16	56,00	110	—
5873531	40021600T056	16,0	16	56,00	110	0,30
6092659	40121600T075S	16,0	16	75,00	150	—
5873532	40121600T075	16,0	16	75,00	150	0,30
5873533	40021800T038	18,0	18	38,00	100	0,30
6092660	40021800T038S	18,0	18	38,00	100	—
5873534	40021800T060	18,0	18	60,00	125	0,30
6092681	40021800T060S	18,0	18	60,00	125	—
6092682	40121800T075S	18,0	18	75,00	150	—
5873535	40121800T075	18,0	18	75,00	150	0,30
6092683	40022000T038S	20,0	20	38,00	104	—
5873536	40022000T038	20,0	20	38,00	104	0,30
6092684	40022000T056S	20,0	20	56,00	125	—
5873537	40022000T056	20,0	20	56,00	125	0,30
6092685	40122000T075S	20,0	20	75,00	150	—
5873538	40122000T075	20,0	20	75,00	150	0,30

NOTE: For application data, please see pages M23–M24.

- Centre cutting.
- Standard items listed. Additional styles and coatings made-to-order.

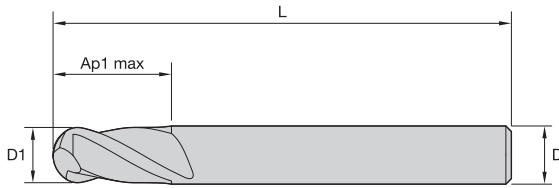

End Mill Tolerances

D1	tolerance e8	D	tolerance h6 + / -
≤ 3	-0,014/-0,028	≤ 3	0/0,006
> 3-6	-0,020/-0,038	> 3-6	0/0,008
> 6-10	-0,025/-0,047	> 6-10	0/0,009
> 10-18	-0,032/-0,059	> 10-18	0/0,011
> 18-30	-0,040/-0,073	> 18-30	0/0,013

■ Series D001 D011 • VariMill GP

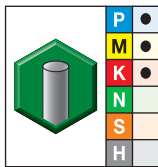

- first choice
- alternate choice

order #	catalogue #	grade TiAlN TiAlN	D1	D	length of cut Ap1 max	length L
5880362	D0110200T006		2,0	6	6,00	57
5880363	D0010300T004		3,0	6	4,00	50
5880364	D0110300T007		3,0	6	7,00	57
5880365	D0010400T005		4,0	6	5,00	54
5880366	D0110400T008		4,0	6	8,00	57
5880367	D0110500T010		5,0	6	10,00	57
5880368	D0110600T010		6,0	6	10,00	57
5880369	D0110700T013		7,0	8	13,00	63
5880370	D0110800T016		8,0	8	16,00	63
5880381	D0111000T019		10,0	10	19,00	72
5880382	D0111200T022		12,0	12	22,00	83
5880383	D0111400T022		14,0	14	22,00	83
5880384	D0111600T026		16,0	16	26,00	92
5880385	D0012000T020		20,0	20	20,00	92
5880386	D0112000T032		20,0	20	32,00	104

NOTE: For application data, please see page M25.

- Centre cutting.
- Standard items listed. Additional styles and coatings made-to-order.

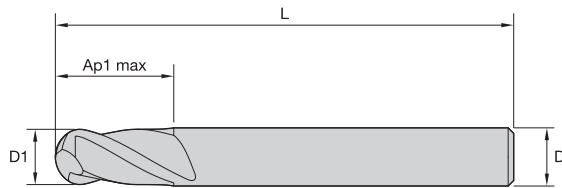
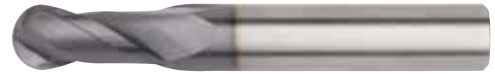

End Mill Tolerances

D1	tolerance e8	D	tolerance h6 + / -
≤ 3	-0,014/-0,028	≤ 3	0/0,006
> 3-6	-0,020/-0,038	> 3-6	0/0,008
> 6-10	-0,025/-0,047	> 6-10	0/0,009
> 10-18	-0,032/-0,059	> 10-18	0/0,011
> 18-30	-0,040/-0,073	> 18-30	0/0,013

■ Series 2838 • VariMill GP

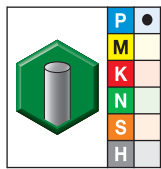

grade UNCOATED

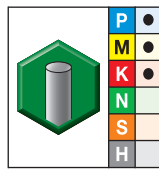

grade TiAlN
TiAlN

- first choice
- alternate choice

order #	catalogue #	order #	catalogue #	D1	D	length of cut Ap1 max	length L
—	—	5880451	28380200T007	2,0	2	7,00	50
5880462	28380300T007	5880452	28380300T007	3,0	3	7,00	50
5880463	28380400T008	5880453	28380400T008	4,0	4	8,00	50
5880464	28380500T010	5880454	28380500T010	5,0	5	10,00	50
5880465	28380600T010	5880455	28380600T010	6,0	6	10,00	57
5880466	28380800T016	5880456	28380800T016	8,0	8	16,00	63
5880467	28381000T019	5880457	28381000T019	10,0	10	19,00	72
5880468	28381200T022	5880458	28381200T022	12,0	12	22,00	83
5880469	28381400T022	5880459	28381400T022	14,0	14	22,00	83
5880470	28381600T026	5880460	28381600T026	16,0	16	26,00	92
5880471	28382000T032	5880461	28382000T032	20,0	20	32,00	104

NOTE: For application data, please see page M25.

- Centre cutting.
- Standard items listed. Additional styles and coatings made-to-order.

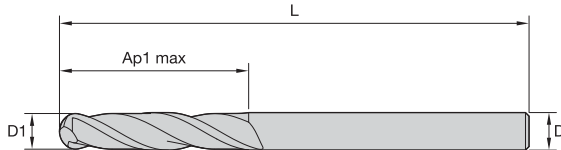

End Mill Tolerances

D1	tolerance e8	D	tolerance h6 + / -
≤ 3	-0,014/-0,028	≤ 3	0/0,006
> 3-6	-0,020/-0,038	> 3-6	0/0,008
> 6-10	-0,025/-0,047	> 6-10	0/0,009
> 10-18	-0,032/-0,059	> 10-18	0/0,011
> 18-30	-0,040/-0,073	> 18-30	0/0,013

■ Series 4001 4011 4021 • VariMill GP

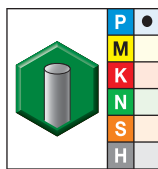

grade UNCOATED

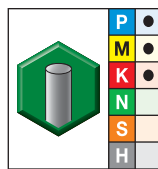

grade TiAlN
TiAlN

- first choice
- alternate choice

order #	catalogue #	order #	catalogue #	D1	D	length of cut Ap1 max	length L
5880425	40010100T004	5880387	40010100T004	1,0	3	4,00	38
5880426	40010150T005	5880388	40010150T005	1,5	3	5,00	38
5880427	40010200T006	5880389	40010200T006	2,0	3	6,30	38
5880428	40010250T007	5880390	40010250T007	2,5	3	7,00	38
5880429	40010300T009	5880391	40010300T009	3,0	3	9,50	38
—	—	5880392	40010350T012	3,5	4	12,00	50
5880430	40010400T012	5880393	40010400T012	4,0	4	12,00	50
5880431	40110400T019	5880395	40110400T019	4,0	4	19,00	63
5880432	40210400T031	5880396	40210400T031	4,0	4	31,00	75
5880433	40010500T014	—	—	5,0	5	14,00	50
—	—	5880397	40210500T014	5,0	6	14,00	50
5880435	40010600T020	5880398	40010600T020	6,0	6	20,00	63
5880436	40110600T028	5880399	40110600T028	6,0	6	28,00	76
5880437	40210600T038	5880400	40210600T038	6,0	6	38,00	100
5880438	40010800T020	5880401	40010800T020	8,0	8	20,00	63
5880439	40110800T028	5880402	40110800T028	8,0	8	28,00	76
5880440	40210800T040	5880403	40210800T040	8,0	8	40,00	100
5880441	40011000T022	5880404	40011000T022	10,0	10	22,00	76
5880442	40111000T032	5880405	40111000T032	10,0	10	32,00	89
5880443	40211000T045	5880406	40211000T045	10,0	10	45,00	100

(continued)

(Series 4001 4011 4021 • VariMill GP — continued)

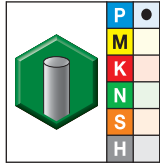
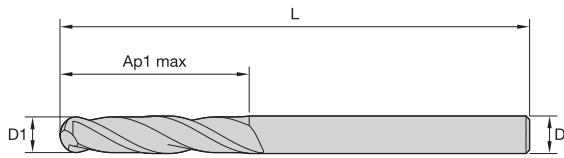

grade UNCOATED

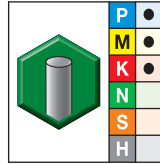

grade TiAlN
TiAlN

● first choice
○ alternate choice

order #	catalogue #	order #	catalogue #	D1	D	length of cut Ap1 max	length L
5880444	40011200T025	5880407	40011200T025	12,0	12	25,00	75
5880445	40111200T045	5880408	40111200T045	12,0	12	45,00	100
5880446	40211200T075	5880409	40211200T075	12,0	12	75,00	150
5880447	40011400T032	5880410	40011400T032	14,0	14	32,00	89
5880448	40011600T032	5880411	40011600T032	16,0	16	32,00	89
5880449	40012000T038	5880412	40012000T038	20,0	20	38,00	100
5880450	40112000T075	5880413	40112000T075	20,0	20	75,00	150

NOTE: For application data, please see pages M25–M26.

■ Series D002 D012 2819 4002 • TiAlN • VariMill GP

Material Group	Side Milling (A) and Slotting (B)		TiAlN		Recommended feed per tooth (fz = mm/th) for side milling (A). For slotting (B), reduce fz by 20%.																	
	A		B		Cutting Speed – vc m/min		D1 – Diameter															
	ap	ae	ap	min	max	mm	1,0	2,0	3,0	4,0	5,0	6,0	8,0	10,0	12,0	14,0	16,0	18,0	20,0			
	P	0	Ap1 max	0,1 x D	0,5 x D	150	–	200	fz	0,007	0,014	0,021	0,028	0,036	0,044	0,060	0,072	0,083	0,092	0,101	0,108	0,114
1		Ap1 max	0,1 x D	0,5 x D	150	–	200	fz	0,007	0,014	0,021	0,028	0,036	0,044	0,060	0,072	0,083	0,092	0,101	0,108	0,114	
2		Ap1 max	0,1 x D	0,5 x D	140	–	190	fz	0,007	0,014	0,021	0,028	0,036	0,044	0,060	0,072	0,083	0,092	0,101	0,108	0,114	
3		Ap1 max	0,1 x D	0,5 x D	120	–	160	fz	0,006	0,011	0,017	0,023	0,030	0,036	0,050	0,061	0,070	0,079	0,087	0,095	0,101	
4		Ap1 max	0,1 x D	0,5 x D	90	–	150	fz	0,005	0,010	0,016	0,021	0,027	0,033	0,045	0,054	0,062	0,070	0,077	0,083	0,088	
M	1	Ap1 max	0,1 x D	0,5 x D	90	–	115	fz	0,006	0,011	0,017	0,023	0,030	0,036	0,050	0,061	0,070	0,079	0,087	0,095	0,101	
	2	Ap1 max	0,1 x D	0,5 x D	60	–	80	fz	0,005	0,009	0,014	0,019	0,024	0,029	0,040	0,048	0,056	0,063	0,070	0,076	0,081	
K	1	Ap1 max	0,1 x D	0,5 x D	120	–	150	fz	0,007	0,014	0,021	0,028	0,036	0,044	0,060	0,072	0,083	0,092	0,101	0,108	0,114	
	2	Ap1 max	0,1 x D	0,5 x D	110	–	140	fz	0,006	0,011	0,017	0,023	0,030	0,036	0,050	0,061	0,070	0,079	0,087	0,095	0,101	

NOTE: Lower value of cutting speed is used for high stock removal applications or for higher hardness (machinability) within group.
Higher value of cutting speed is used for finishing applications or for lower hardness (machinability) within group.
Above parameters are based on ideal conditions. For smaller taper machining centres, please adjust parameters accordingly on >12mm diameters.

■ Series D002 D012 2819 4002 • Uncoated • VariMill GP

Material Group	Side Milling (A) and Slotting (B)		uncoated		Recommended feed per tooth (fz = mm/th) for side milling (A). For slotting (B), reduce fz by 20%.																	
	A		B		Cutting Speed – vc m/min		D1 – Diameter															
	ap	ae	ap	min	max	mm	2,0	3,0	4,0	6,0	8,0	10,0	12,0	16,0	20,0							
	P	0	Ap1 max	0,1 x D	0,5 x D	120	–	160	fz	0,014	0,021	0,028	0,044	0,060	0,072	0,083	0,101	0,114				
1		Ap1 max	0,1 x D	0,5 x D	120	–	160	fz	0,014	0,021	0,028	0,044	0,060	0,072	0,083	0,101	0,114					
2		Ap1 max	0,1 x D	0,5 x D	112	–	152	fz	0,014	0,021	0,028	0,044	0,060	0,072	0,083	0,101	0,114					

NOTE: Lower value of cutting speed is used for high stock removal applications or for higher hardness (machinability) within group.
Higher value of cutting speed is used for finishing applications or for lower hardness (machinability) within group.
Above parameters are based on ideal conditions. For smaller taper machining centres, please adjust parameters accordingly on >12mm diameters.

■ Series 4012 • TiAlN • VariMill GP

		Side Milling (A)		TiAlN			Recommended feed per tooth (fz = mm/th) for side milling (A).													
Material Group	A		Cutting Speed – vc m/min			D1 – Diameter														
	ap	ae	min		max	mm	2,0	3,0	4,0	5,0	6,0	8,0	10,0	12,0	14,0	16,0	18,0	20,0		
P	0	Ap1 max	0,1 x D	150	–	200	fz	0,014	0,021	0,028	0,036	0,044	0,060	0,072	0,083	0,092	0,101	0,108	0,114	
	1	Ap1 max	0,1 x D	150	–	200	fz	0,014	0,021	0,028	0,036	0,044	0,060	0,072	0,083	0,092	0,101	0,108	0,114	
	2	Ap1 max	0,1 x D	140	–	190	fz	0,014	0,021	0,028	0,036	0,044	0,060	0,072	0,083	0,092	0,101	0,108	0,114	
	3	Ap1 max	0,1 x D	120	–	160	fz	0,011	0,017	0,023	0,030	0,036	0,050	0,061	0,070	0,079	0,087	0,095	0,101	
	4	Ap1 max	0,1 x D	90	–	150	fz	0,010	0,016	0,021	0,027	0,033	0,045	0,054	0,062	0,070	0,077	0,083	0,088	
M	1	Ap1 max	0,1 x D	90	–	115	fz	0,011	0,017	0,023	0,030	0,036	0,050	0,061	0,070	0,079	0,087	0,095	0,101	
	2	Ap1 max	0,1 x D	60	–	80	fz	0,009	0,014	0,019	0,024	0,029	0,040	0,048	0,056	0,063	0,070	0,076	0,081	
K	1	Ap1 max	0,1 x D	120	–	150	fz	0,014	0,021	0,028	0,036	0,044	0,060	0,072	0,083	0,092	0,101	0,108	0,114	
	2	Ap1 max	0,1 x D	110	–	140	fz	0,011	0,017	0,023	0,030	0,036	0,050	0,061	0,070	0,079	0,087	0,095	0,101	

NOTE: Lower value of cutting speed is used for high stock removal applications or for higher hardness (machinability) within group.
 Higher value of cutting speed is used for finishing applications or for lower hardness (machinability) within group.
 Above parameters are based on ideal conditions. For smaller taper machining centres, please adjust parameters accordingly on >12mm diameters.

■ Series 4012 • Uncoated • VariMill GP

		Side Milling (A)		uncoated			Recommended feed per tooth (fz = mm/th) for side milling (A).													
Material Group	A		Cutting Speed – vc m/min			D1 – Diameter														
	ap	ae	min		max	mm	3,0	4,0	6,0	8,0	10,0	12,0	16,0	20,0						
P	0	Ap1 max	0,1 x D	120	–	160	fz	0,021	0,028	0,044	0,060	0,072	0,083	0,101	0,114					
	1	Ap1 max	0,1 x D	120	–	160	fz	0,021	0,028	0,044	0,060	0,072	0,083	0,101	0,114					
	2	Ap1 max	0,1 x D	112	–	152	fz	0,021	0,028	0,044	0,060	0,072	0,083	0,101	0,114					

NOTE: Lower value of cutting speed is used for high stock removal applications or for higher hardness (machinability) within group.
 Higher value of cutting speed is used for finishing applications or for lower hardness (machinability) within group.
 Above parameters are based on ideal conditions. For smaller taper machining centres, please adjust parameters accordingly on >12mm diameters.

■ Series D001 D011 2838 4001 • TiAlN • VariMill GP

Material Group																					
	Side Milling (A) and Slotting (B)			TiAlN			Recommended feed per tooth (fz = mm/th) for side milling (A). For slotting (B), reduce fz by 20%.														
	A		B	Cutting Speed – vc m/min		mm	D1 – Diameter														
	ap	ae	ap	min	max		1,0	2,0	3,0	4,0	5,0	6,0	8,0	10,0	12,0	14,0	16,0	18,0	20,0		
P	0	Ap1 max	0,1 x D	0,5 x D	150	–	200	fz	0,007	0,014	0,021	0,028	0,036	0,044	0,060	0,072	0,083	0,092	0,101	0,108	0,114
	1	Ap1 max	0,1 x D	0,5 x D	150	–	200	fz	0,007	0,014	0,021	0,028	0,036	0,044	0,060	0,072	0,083	0,092	0,101	0,108	0,114
	2	Ap1 max	0,1 x D	0,5 x D	140	–	190	fz	0,007	0,014	0,021	0,028	0,036	0,044	0,060	0,072	0,083	0,092	0,101	0,108	0,114
	3	Ap1 max	0,1 x D	0,5 x D	120	–	160	fz	0,006	0,011	0,017	0,023	0,030	0,036	0,050	0,061	0,070	0,079	0,087	0,095	0,101
	4	Ap1 max	0,1 x D	0,5 x D	90	–	150	fz	0,005	0,010	0,016	0,021	0,027	0,033	0,045	0,054	0,062	0,070	0,077	0,083	0,088
M	1	Ap1 max	0,1 x D	0,5 x D	90	–	115	fz	0,006	0,011	0,017	0,023	0,030	0,036	0,050	0,061	0,070	0,079	0,087	0,095	0,101
	2	Ap1 max	0,1 x D	0,5 x D	60	–	80	fz	0,005	0,009	0,014	0,019	0,024	0,029	0,040	0,048	0,056	0,063	0,070	0,076	0,081
K	1	Ap1 max	0,1 x D	0,5 x D	120	–	150	fz	0,007	0,014	0,021	0,028	0,036	0,044	0,060	0,072	0,083	0,092	0,101	0,108	0,114
	2	Ap1 max	0,1 x D	0,5 x D	110	–	140	fz	0,006	0,011	0,017	0,023	0,030	0,036	0,050	0,061	0,070	0,079	0,087	0,095	0,101

NOTE: Lower value of cutting speed is used for high stock removal applications or for higher hardness (machinability) within group.
Higher value of cutting speed is used for finishing applications or for lower hardness (machinability) within group.
Above parameters are based on ideal conditions. For smaller taper machining centres, please adjust parameters accordingly on >12mm diameters.

■ Series D001 D011 2838 4001 • Uncoated • VariMill GP

Material Group																					
	Side Milling (A) and Slotting (B)			uncoated			Recommended feed per tooth (fz = mm/th) for side milling (A). For slotting (B), reduce fz by 20%.														
	A		B	Cutting Speed – vc m/min		mm	D1 – Diameter														
	ap	ae	ap	min	max		1,0	2,0	3,0	4,0	6,0	8,0	10,0	12,0	16,0	20,0					
P	0	Ap1 max	0,1 x D	0,5 x D	120	–	160	fz	0,007	0,014	0,021	0,028	0,044	0,060	0,072	0,083	0,101	0,114			
	1	Ap1 max	0,1 x D	0,5 x D	120	–	160	fz	0,007	0,014	0,021	0,028	0,044	0,060	0,072	0,083	0,101	0,114			
	2	Ap1 max	0,1 x D	0,5 x D	112	–	152	fz	0,007	0,014	0,021	0,028	0,044	0,060	0,072	0,083	0,101	0,114			

NOTE: Lower value of cutting speed is used for high stock removal applications or for higher hardness (machinability) within group.
Higher value of cutting speed is used for finishing applications or for lower hardness (machinability) within group.
Above parameters are based on ideal conditions. For smaller taper machining centres, please adjust parameters accordingly on >12mm diameters.

■ Series 4011 4021 • TiAlN • VariMill GP

		Side Milling (A)		TiAlN			Recommended feed per tooth (fz = mm/th) for side milling (A).												
Material Group	A		Cutting Speed – vc m/min			mm	D1 – Diameter												
	ap	ae	min		max		2,0	3,0	4,0	5,0	6,0	8,0	10,0	12,0	14,0	16,0	18,0	20,0	
P	0	Ap1 max	0,1 x D	150	–	200	fz	0,014	0,021	0,028	0,036	0,044	0,060	0,072	0,083	0,092	0,101	0,108	0,114
	1	Ap1 max	0,1 x D	150	–	200	fz	0,014	0,021	0,028	0,036	0,044	0,060	0,072	0,083	0,092	0,101	0,108	0,114
	2	Ap1 max	0,1 x D	140	–	190	fz	0,014	0,021	0,028	0,036	0,044	0,060	0,072	0,083	0,092	0,101	0,108	0,114
	3	Ap1 max	0,1 x D	120	–	160	fz	0,011	0,017	0,023	0,030	0,036	0,050	0,061	0,070	0,079	0,087	0,095	0,101
M	1	Ap1 max	0,1 x D	90	–	115	fz	0,011	0,017	0,023	0,030	0,036	0,050	0,061	0,070	0,079	0,087	0,095	0,101
	2	Ap1 max	0,1 x D	60	–	80	fz	0,009	0,014	0,019	0,024	0,029	0,040	0,048	0,056	0,063	0,070	0,076	0,081
K	1	Ap1 max	0,1 x D	120	–	150	fz	0,014	0,021	0,028	0,036	0,044	0,060	0,072	0,083	0,092	0,101	0,108	0,114
	2	Ap1 max	0,1 x D	110	–	140	fz	0,011	0,017	0,023	0,030	0,036	0,050	0,061	0,070	0,079	0,087	0,095	0,101

NOTE: Lower value of cutting speed is used for high stock removal applications or for higher hardness (machinability) within group.
 Higher value of cutting speed is used for finishing applications or for lower hardness (machinability) within group.
 Above parameters are based on ideal conditions. For smaller taper machining centres, please adjust parameters accordingly on >12mm diameters.

■ Series 4011 4021 • Uncoated • VariMill GP

		Side Milling (A)		uncoated			Recommended feed per tooth (fz = mm/th) for side milling (A).												
Material Group	A		Cutting Speed – vc m/min			mm	D1 – Diameter												
	ap	ae	min		max		2,0	3,0	4,0	6,0	8,0	10,0	12,0	16,0	20,0				
P	0	Ap1 max	0,1 x D	120	–	160	fz	0,014	0,021	0,028	0,044	0,060	0,072	0,083	0,101	0,114			
	1	Ap1 max	0,1 x D	120	–	160	fz	0,014	0,021	0,028	0,044	0,060	0,072	0,083	0,101	0,114			
	2	Ap1 max	0,1 x D	112	–	152	fz	0,014	0,021	0,028	0,044	0,060	0,072	0,083	0,101	0,114			

NOTE: Lower value of cutting speed is used for high stock removal applications or for higher hardness (machinability) within group.
 Higher value of cutting speed is used for finishing applications or for lower hardness (machinability) within group.
 Above parameters are based on ideal conditions. For smaller taper machining centres, please adjust parameters accordingly on >12mm diameters.

Unmatched Versatility Meets Powerful Performance



EXTREME **CHALLENGES.**
EXTREME **RESULTS.**

Top Cut 4™

Specifically designed for versatility — Top Cut 4 offers outstanding flexibility, increased productivity, and is the one tool to apply to a variety of drilling applications and different workpiece materials.

- High tool life at accelerated speeds.
- Efficient chip evacuation.
- Increased coolant supply.
- Up to 5 x D.

To learn more about the benefits of **WIDIA™ Top Cut 4**, contact your local distributor.

WIDIA 



Solid Carbide End Mills

WIDIA™ offers a complete line of 3-flute general-purpose solid carbide end mill tools

General purpose offers plunging, slotting, and profiling for a wide range of materials and applications. Designed to provide high Metal Removal Rates (MRR) and excellent surface conditions at economic pricing. For a complete line of comprehensive tools, visit widia.com.

NOVO KNOWS ART TO PART TO PROFIT

Being as productive and profitable as possible is your fundamental goal. With the addition of NOVO™ to your team, your goal can be achieved. NOVO possesses powerful digital tools that link together process planning, inventory availability and purchase, cost-per-part management, and productivity improvements.

NOVO can ensure you have the right tools on your machines, in the right sequence. This results in flawless execution that accelerates every job, and maximises every shift.

01

THE DIGITAL SOURCE FOR DELIVERING SMART MACHINING SOLUTIONS

widia.com/novo

NOVO™

WIDIA-Hanita™ Means Quality

WIDIA
HANITA

WIDIA-Hanita™ solid carbide end mill products have a strong history of providing revolutionary and innovative solutions for your most extreme solid end milling challenges.



EXTREME **CHALLENGES.** EXTREME **RESULTS.**

As an industry-leading manufacturer of carbide round tools, WIDIA-Hanita™ offers a complete portfolio of precision-engineered products with solutions for a wide range of workpiece materials at widia.com.

The VariMill™ line offers superior performance high-speed machining.

- The versatile 2- and 4-flute general-purpose line, VariMill™ GP, is ideal for a wide range of materials.
- The 4-flute VariMill I™ offers plunging, slotting, and profiling at the highest possible feed rates for a wide range of materials.
- The 5-flute VariMill II™ end mills are the proven leader in the field of high-performance, chatter-free machining.
- The 5-flute VariMill II™ ER end mills are specifically designed for machining high-performance aerospace materials.
- The 7-flute VariMill III™ ER high-performance tool has true finishing capabilities for walls and floors.

WIDIA

General Purpose 4-Flute End Mills •
VariMill™ GP

VariMill GP



VariMill GP offers plunging, slotting, and profiling for a wide range of materials and applications. Designed to provide high metal removal rates and excellent surface conditions at a value price. A wide range of diameters, lengths, and corner styles (such as chamfered, sharp edge, and ball nose) are available from stock.

VariMill GP • 4-Flute

- General purpose tools for a wide range of workpiece materials.
- Roughing and finishing with one tool.
- Various lengths-of-cut and overall lengths with different front-end designs available.
- Four flutes for high Metal Removal Rates (MRR) and tool life.

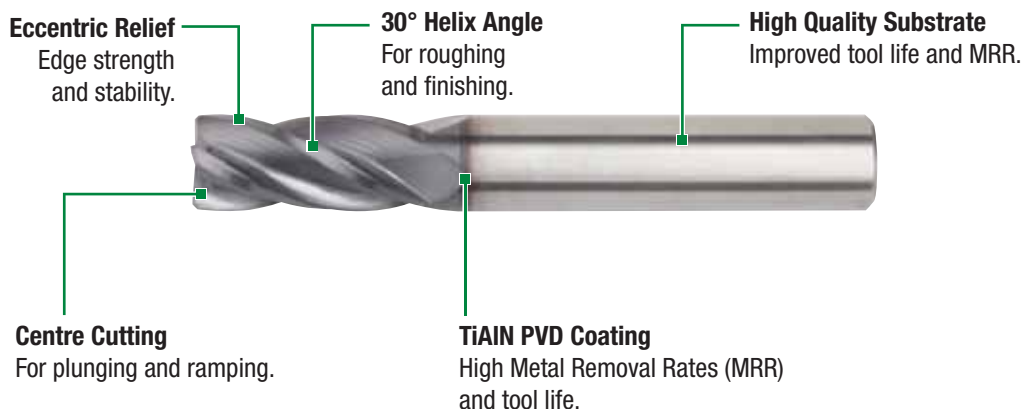

VariMill™ GP

- Increased manufacturing flexibility and reduced tooling cost.
- Less tool changes and high Metal Removal Rates (MRR).
- One tool required for roughing and finishing.
- Eccentric relief for improved edge stability and high tool life.
- Easy and cost-efficient regrinding due to eccentric relief.

D004/D014 Series

- Centre cutting.
- DIN 6527 standard dimensions — short and long.
- Steel, stainless steel, and cast iron.
- Corner chamfer for increased tool life.



2528 Series

- Centre cutting.
- DIN 6528 standard dimensions.
- Steel, stainless steel, and cast iron.
- Corner chamfer for increased tool life.



4004/4014/4024 Series

- Centre cutting.
- Wide range of lengths-of-cut — regular, long, and extra long.
- Steel, stainless steel, and cast iron.
- Corner chamfer for increased tool life.



D010 Series

- DIN 6527 standard dimensions — short and long.
- Steel, stainless steel, and cast iron.
- Centre cut ball nose.

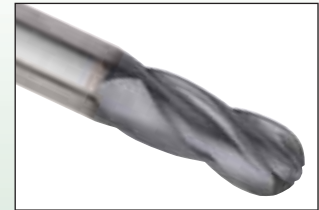

2848 Series

- DIN 6528 standard dimensions.
- Steel, stainless steel, and cast iron.
- Centre cut ball nose.



4000/4010 Series

- Wide range of lengths-of-cut — regular and long.
- Steel, stainless steel, and cast iron.
- Centre cut ball nose.



- Centre cutting.
- Chamfered corners.
- Standard items listed. Additional styles and coatings made-to-order.

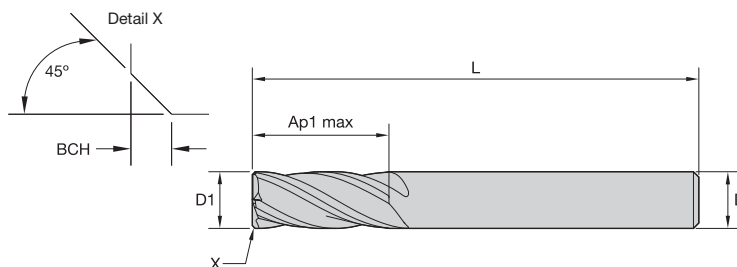

End Mill Tolerances

D1	tolerance e8	D	tolerance h6 + / -
≤ 3	-0,014/-0,028	≤ 3	0/0,006
> 3-6	-0,020/-0,038	> 3-6	0/0,008
> 6-10	-0,025/-0,047	> 6-10	0/0,009
> 10-18	-0,032/-0,059	> 10-18	0/0,011
> 18-30	-0,040/-0,073	> 18-30	0/0,013

■ Series D004 D014 • VariMill GP

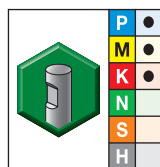
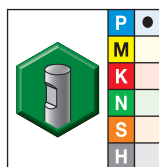
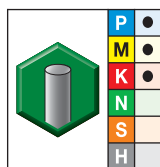

- first choice
- alternate choice

grade TiAlN TiAlN		grade UNCOATED		grade TiAlN TiAlN		D1	D	length of cut Ap1 max	length L	BCH
order #	catalogue #	order #	catalogue #	order #	catalogue #					
5825894	D0040200T004	—	—	—	—	2,0	6	4,00	50	—
5825895	D0140200T007	—	—	—	—	2,0	6	7,00	57	—
5825896	D0140250T008	—	—	—	—	2,5	6	8,00	57	—
5825897	D0040300T005	—	—	—	—	3,0	6	5,00	50	—
5825898	D0140300T008	—	—	—	—	3,0	6	8,00	57	—
5825899	D0140350T010	—	—	—	—	3,5	6	10,00	57	—
5825900	D0040400T008	—	—	—	—	4,0	6	8,00	54	0,10
6085348	D0040400T008S	—	—	—	—	4,0	6	8,00	54	—
6085349	D0140400T011S	—	—	—	—	4,0	6	11,00	57	—
5825931	D0140400T011	—	—	—	—	4,0	6	11,00	57	0,10
6085350	D0140450T011S	—	—	—	—	4,5	6	11,00	57	—
5825932	D0140450T011	—	—	—	—	4,5	6	11,00	57	0,10
6085361	D0040500T009S	—	—	—	—	5,0	6	9,00	54	—
5825933	D0040500T009	—	—	—	—	5,0	6	9,00	54	0,10
6085362	D0140500T013S	—	—	—	—	5,0	6	13,00	57	—
5825934	D0140500T013	—	—	—	—	5,0	6	13,00	57	0,10
6085363	D0140550T013S	—	—	—	—	5,5	6	13,00	57	—
5825935	D0140550T013	—	—	—	—	5,5	6	13,00	57	0,10
6085364	D0040600T010S	—	—	—	—	6,0	6	10,00	54	—
5825936	D0040600T010	—	—	—	—	6,0	6	10,00	54	0,10
6085365	D0140600T013S	—	—	—	—	6,0	6	13,00	57	—
5825937	D0140600T013	—	—	—	—	6,0	6	13,00	57	0,10
6085366	D0140650T016S	—	—	—	—	6,5	8	16,00	63	—
5825938	D0140650T016	—	—	—	—	6,5	8	16,00	63	0,10
6085367	D0040700T011S	—	—	—	—	7,0	8	11,00	58	—
5825939	D0040700T011	—	—	—	—	7,0	8	11,00	58	0,10
6085368	D0140700T016S	—	—	—	—	7,0	8	16,00	63	—
5825940	D0140700T016	—	—	—	—	7,0	8	16,00	63	0,10

(continued)

(Series D004 D014 • VariMill GP — continued)

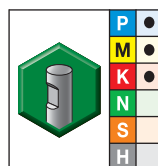
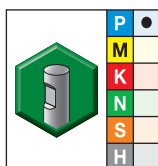
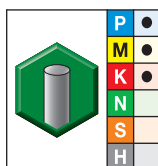
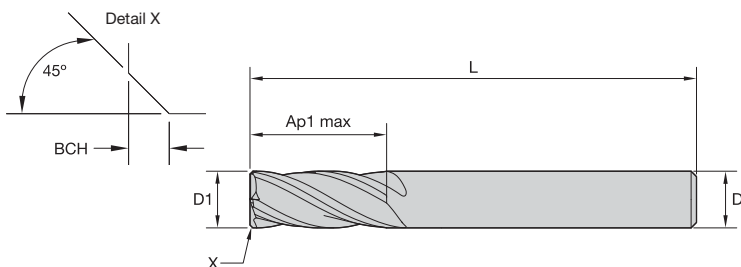

● first choice
○ alternate choice

grade TiAlN TiAlN		grade UNCOATED		grade TiAlN TiAlN		D1	D	length of cut Ap1 max	length L	BCH
order #	catalogue #	order #	catalogue #	order #	catalogue #					
6085369	D0140750T019S	—	—	—	—	7,5	8	19,00	63	—
5825941	D0140750T019	—	—	—	—	7,5	8	19,00	63	0,10
6085370	D0040800T012S	—	—	—	—	8,0	8	12,00	58	—
5825942	D0040800T012	—	—	—	—	8,0	8	12,00	58	0,20
6085371	D0140800T019S	—	—	—	—	8,0	8	19,00	63	—
5825943	D0140800T019	—	—	—	—	8,0	8	19,00	63	0,20
6085372	D0040900T013S	—	—	—	—	9,0	10	13,00	66	—
5825944	D0040900T013	—	—	—	—	9,0	10	13,00	66	0,20
6085373	D0140900T019S	—	—	—	—	9,0	10	19,00	72	—
5825945	D0140900T019	—	—	—	—	9,0	10	19,00	72	0,20
6085374	D0041000T014S	—	—	—	—	10,0	10	14,00	66	—
5825946	D0041000T014	—	—	—	—	10,0	10	14,00	66	0,20
6085375	D0141000T022S	—	—	—	—	10,0	10	22,00	72	—
5825947	D0141000T022	—	—	—	—	10,0	10	22,00	72	0,20
6085376	D0041200T016S	6085406	D0041200W016S	6085396	D0041200W016S	12,0	12	16,00	73	—
5825948	D0041200T016	5825968	D0041200W016	5825958	D0041200W016	12,0	12	16,00	73	0,30
6085377	D0141200T026S	—	—	6085397	D0141200W026S	12,0	12	26,00	83	—
5825949	D0141200T026	5825969	D0141200W026	5825959	D0141200W026	12,0	12	26,00	83	0,30
—	—	—	—	6085407	D0141200W026S	12,0	12	26,00	83	—
6085378	D0041400T018S	6085408	D0041400W018S	6085398	D0041400W018S	14,0	14	18,00	75	—
5825950	D0041400T018	5825970	D0041400W018	5825960	D0041400W018	14,0	14	18,00	75	0,30
6085379	D0141400T026S	—	—	6085399	D0141400W026S	14,0	14	26,00	83	—
5825951	D0141400T026	5825971	D0141400W026	5825961	D0141400W026	14,0	14	26,00	83	0,30
—	—	—	—	6085409	D0141400W026S	14,0	14	26,00	83	—
6085380	D0041600T022S	6085410	D0041600W022S	6085400	D0041600W022S	16,0	16	22,00	82	—
5825952	D0041600T022	5825972	D0041600W022	5825962	D0041600W022	16,0	16	22,00	82	0,30
6085391	D0141600T032S	6085421	D0141600W032S	6085401	D0141600W032S	16,0	16	32,00	92	—
5825953	D0141600T032	5825973	D0141600W032	5825963	D0141600W032	16,0	16	32,00	92	0,30
6085392	D0041800T024S	6086478	D0041800W024S	6085402	D0041800W024S	18,0	18	24,00	84	—
5825954	D0041800T024	5825974	D0041800W024	5825964	D0041800W024	18,0	18	24,00	84	0,30
6085393	D0141800T032S	6086479	D0141800W032S	6085403	D0141800W032S	18,0	18	32,00	92	—
5825955	D0141800T032	5825975	D0141800W032	5825965	D0141800W032	18,0	18	32,00	92	0,30
6085394	D0042000T026S	6086480	D0042000W026S	6085404	D0042000W026S	20,0	20	26,00	92	—
5825956	D0042000T026	5825976	D0042000W026	5825966	D0042000W026	20,0	20	26,00	92	0,30
6085395	D0142000T038S	6086491	D0142000W038S	6085405	D0142000W038S	20,0	20	38,00	104	—
5825957	D0142000T038	5825977	D0142000W038	5825967	D0142000W038	20,0	20	38,00	104	0,30

NOTE: For application data, please see pages M40–M41.

- Centre cutting.
- Chamfered corners.
- Standard items listed. Additional styles and coatings made-to-order.

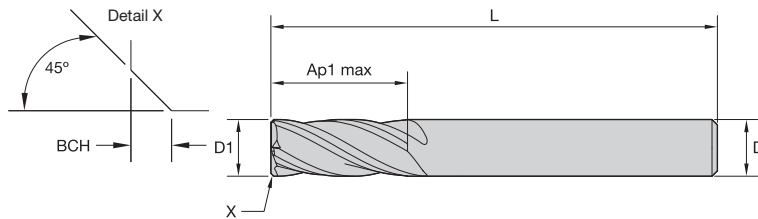

End Mill Tolerances

D1	tolerance e8	D	tolerance h6 + / -
≤ 3	-0,014/-0,028	≤ 3	0/0,006
> 3-6	-0,020/-0,038	> 3-6	0/0,008
> 6-10	-0,025/-0,047	> 6-10	0/0,009
> 10-18	-0,032/-0,059	> 10-18	0/0,011
> 18-30	-0,040/-0,073	> 18-30	0/0,013

Series 2528 • VariMill GP

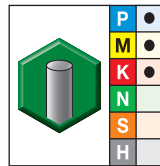
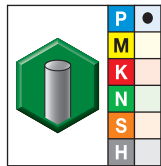

- first choice
- alternate choice

grade UNCOATED

grade TiAlN
TiAlN

order #	catalogue #	order #	catalogue #	D1	D	length of cut Ap1 max	length L	BCH
6086507	25280400T011S	6086492	25280400T011S	4,0	4	11,00	50	—
5825993	25280400T011	5825978	25280400T011	4,0	4	11,00	50	0,10
6086508	25280500T013S	6086493	25280500T013S	5,0	5	13,00	50	—
5825994	25280500T013	5825979	25280500T013	5,0	5	13,00	50	0,10
6086509	25280600T013S	6086494	25280600T013S	6,0	6	13,00	57	—
5825995	25280600T013	5825980	25280600T013	6,0	6	13,00	57	0,10
6086510	25280800T019S	6086495	25280800T019S	8,0	8	19,00	63	—
5825996	25280800T019	5825981	25280800T019	8,0	8	19,00	63	0,20
6086531	25281000T022S	6086496	25281000T022S	10,0	10	22,00	72	—
5825997	25281000T022	5825982	25281000T022	10,0	10	22,00	72	0,20
6086502	25281200T026S	6086497	25281200T026S	12,0	12	26,00	83	—
5825988	25281200T026	5825983	25281200T026	12,0	12	26,00	83	0,30
6086503	25281400T026S	6086498	25281400T026S	14,0	14	26,00	83	—
5825989	25281400T026	5825984	25281400T026	14,0	14	26,00	83	0,30
6086504	25281600T032S	6086499	25281600T032S	16,0	16	32,00	92	—
5825990	25281600T032	5825985	25281600T032	16,0	16	32,00	92	0,30
6086505	25281800T032S	6086500	25281800T032S	18,0	18	32,00	92	—
5825991	25281800T032	5825986	25281800T032	18,0	18	32,00	92	0,30
6086506	25282000T038S	6086501	25282000T038S	20,0	20	38,00	104	—
5825992	25282000T038	5825987	25282000T038	20,0	20	38,00	104	0,30

NOTE: For application data, please see page M41.

- Centre cutting.
- Chamfered corners.
- Standard items listed. Additional styles and coatings made-to-order.

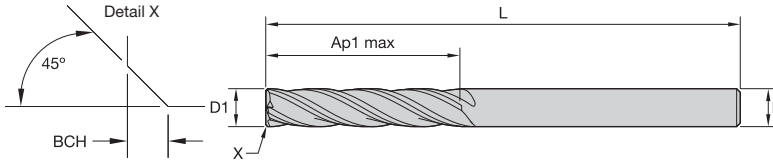
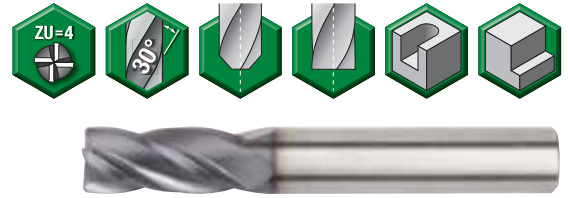

End Mill Tolerances

D1	tolerance e8	D	tolerance h6 + / -
≤ 3	-0,014/-0,028	≤ 3	0/0,006
> 3-6	-0,020/-0,038	> 3-6	0/0,008
> 6-10	-0,025/-0,047	> 6-10	0/0,009
> 10-18	-0,032/-0,059	> 10-18	0/0,011
> 18-30	-0,040/-0,073	> 18-30	0/0,013

■ Series 4004 4014 4024 • VariMill GP

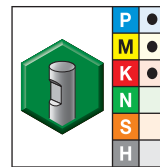
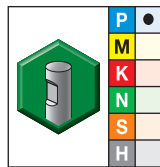
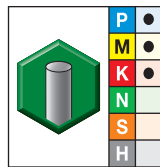
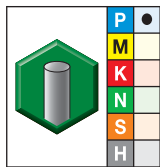

- first choice
- alternate choice

grade UNCOATED		grade TiAlN TiAlN		grade UNCOATED		grade TiAlN TiAlN		D1	D	length of cut Ap1 max	length L	BCH
order #	catalogue #	order #	catalogue #	order #	catalogue #	order #	catalogue #					
5826085	40040100T004	5826016	40040100T004	—	—	—	—	1,0	3	4,00	38	—
5826086	40040150T004	5826017	40040150T004	—	—	—	—	1,5	3	4,00	38	—
5826087	40040200T006	5826018	40040200T006	—	—	—	—	2,0	3	6,30	38	—
5826088	40040250T006	5826019	40040250T006	—	—	—	—	2,5	3	6,30	38	—
5826089	40040300T009	5826020	40040300T009	—	—	—	—	3,0	3	9,50	38	—
5826090	40140300T019	5826021	40140300T019	—	—	—	—	3,0	3	19,00	63	—
5826101	40240300T025	5826022	40240300T025	—	—	—	—	3,0	3	25,00	75	—
5826102	40040350T012	5826023	40040350T012	—	—	—	—	3,5	4	12,00	50	—
5826103	40040400T011	5826024	40040400T011	—	—	—	—	4,0	4	11,00	50	0,10
6085522	40040400T011S	6085576	40040400T011S	—	—	—	—	4,0	4	11,00	50	—
—	—	6085577	40140400T019S	—	—	—	—	4,0	4	19,00	63	—
—	—	5826025	40140400T019	—	—	—	—	4,0	4	19,00	63	0,10
—	—	6085578	40240400T031S	—	—	—	—	4,0	4	31,00	75	—
—	—	5826026	40240400T031	—	—	—	—	4,0	4	31,00	75	0,10
6085523	40040450T014S	6085579	40040450T014S	—	—	—	—	4,5	5	14,00	50	—
5826104	40040450T014	5826027	40040450T014	—	—	—	—	4,5	5	14,00	50	0,10
—	—	6085580	40040500T013S	—	—	—	—	5,0	5	13,00	50	—
—	—	5826028	40040500T013	—	—	—	—	5,0	5	13,00	50	0,10
6085524	40040500T020S	6085581	40040500T020S	—	—	—	—	5,0	5	20,00	63	—
5826105	40040500T020	5826029	40040500T020	—	—	—	—	5,0	5	20,00	63	0,10
—	—	6085582	40140500T030S	—	—	—	—	5,0	5	30,00	75	—
—	—	5826030	40140500T030	—	—	—	—	5,0	5	30,00	75	0,10
—	—	6085583	40240500T031S	—	—	—	—	5,0	5	31,00	100	—
—	—	5826031	40240500T031	—	—	—	—	5,0	5	31,00	100	0,10
6085525	40040600T016S	6085584	40040600T016S	—	—	—	—	6,0	6	16,00	50	—
5826106	40040600T016	5826032	40040600T016	—	—	—	—	6,0	6	16,00	50	0,10
6085526	40140600T028S	6085585	40140600T028S	—	—	—	—	6,0	6	28,00	75	—
5826107	40140600T028	5826033	40140600T028	—	—	—	—	6,0	6	28,00	75	0,10
6085527	40240600T038S	6085586	40240600T038S	—	—	—	—	6,0	6	38,00	100	—
5826108	40240600T038	5826034	40240600T038	—	—	—	—	6,0	6	38,00	100	0,10
—	—	6085587	40040700T020S	—	—	—	—	7,0	8	20,00	63	—
—	—	5826035	40040700T020	—	—	—	—	7,0	8	20,00	63	0,10

(continued)

(Series 4004 4014 4024 • VariMill GP — continued)

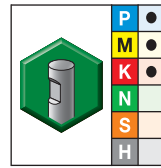
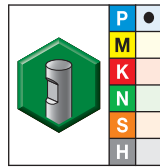
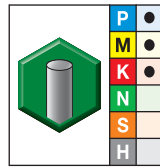
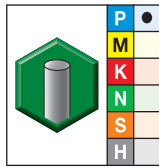
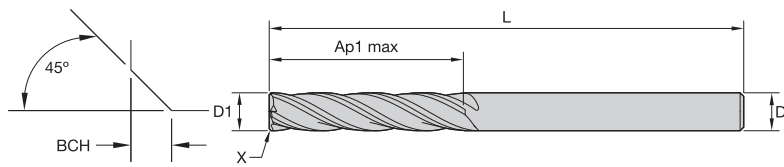

● first choice
○ alternate choice

grade UNCOATED		grade TiAlN TiAlN		grade UNCOATED		grade TiAlN TiAlN		D1	D	length of cut Ap1 max	length L	BCH
order #	catalogue #	order #	catalogue #	order #	catalogue #	order #	catalogue #					
6085528	40040800T020S	6085588	40040800T020S	—	—	—	—	8,0	8	20,00	50	—
5826109	40040800T020	5826036	40040800T020	—	—	—	—	8,0	8	20,00	50	0,20
6085529	40140800T028S	6085589	40140800T028S	—	—	—	—	8,0	8	28,00	75	—
5826110	40140800T028	5826037	40140800T028	—	—	—	—	8,0	8	28,00	75	0,20
6085530	40240800T041S	6085590	40240800T041S	—	—	—	—	8,0	8	41,00	100	—
5826111	40240800T041	5826038	40240800T041	—	—	—	—	8,0	8	41,00	100	0,20
—	—	6085591	40040900T020S	—	—	—	—	9,0	9	20,00	63	—
—	—	5826039	40040900T020	—	—	—	—	9,0	9	20,00	63	0,20
6085531	40041000T022S	6085592	40041000T022S	—	—	—	—	10,0	10	22,00	72	—
5826113	40041000T022	5826040	40041000T022	—	—	—	—	10,0	10	22,00	72	0,20
6085532	40141000T032S	6085593	40141000T032S	—	—	—	—	10,0	10	32,00	89	—
5826114	40141000T032	5826041	40141000T032	—	—	—	—	10,0	10	32,00	89	0,20
6085533	40241000T045S	6085594	40241000T045S	—	—	—	—	10,0	10	45,00	100	—
5826115	40241000T045	5826042	40241000T045	—	—	—	—	10,0	10	45,00	100	0,20
6085534	40041200T025S	—	—	6085549	40041200W025S	6085610	40041200W025S	12,0	12	25,00	75	—
—	—	5826043	40041200T025	—	—	—	—	12,0	12	25,00	89	0,30
—	—	6085595	40041200T025S	—	—	—	—	12,0	12	25,00	89	—
5826116	40041200T025	—	—	5826141	40041200W025	5826070	40041200W025	12,0	12	25,00	75	0,30
6085535	40141200T045S	6085596	40141200T045S	6085550	40141200W045S	6085611	40141200W045S	12,0	12	45,00	100	—
5826117	40141200T045	5826044	40141200T045	5826142	40141200W045	5826071	40141200W045	12,0	12	45,00	100	0,30
6085536	40241200T075S	6085597	40241200T075S	6085551	40241200W075S	6085612	40241200W075S	12,0	12	75,00	150	—
5826118	40241200T075	5826045	40241200T075	5826143	40241200W075	5826072	40241200W075	12,0	12	75,00	150	0,30
6085537	40041400T032S	6085598	40041400T032S	6085552	40041400W032S	6085613	40041400W032S	14,0	14	32,00	83	—
5826119	40041400T032	5826046	40041400T032	5826144	40041400W032	5826073	40041400W032	14,0	14	32,00	83	0,30
5826120	40141400T050	5826047	40141400T050	5826146	40141400W050	5826074	40141400W050	14,0	14	50,00	100	0,30
6085538	40141400T050S	6085599	40141400T050S	6085553	40141400W050S	6085614	40141400W050S	14,0	14	50,00	100	—
6085539	40241400T075S	6085600	40241400T075S	6085554	40241400W075S	6085615	40241400W075S	14,0	14	75,00	150	—
5826121	40241400T075	5826049	40241400T075	5826147	40241400W075	5826075	40241400W075	14,0	14	75,00	150	0,30
5826122	40041600T032	5826061	40041600T032	5826148	40041600W032	5826076	40041600W032	16,0	16	32,00	92	0,30
6085540	40041600T032S	6085601	40041600T032S	6085555	40041600W032S	6085616	40041600W032S	16,0	16	32,00	92	—
6085541	40141600T056S	6085602	40141600T056S	6085556	40141600W056S	6102465	40141600W056S	16,0	16	56,00	110	—
5826123	40141600T056	5826062	40141600T056	5826149	40141600W056	5826077	40141600W056	16,0	16	56,00	110	0,30
6085542	40241600T075S	6085603	40241600T075S	6086532	40241600W075S	6085427	40241600W075S	16,0	16	75,00	150	—
5826124	40241600T075	5826063	40241600T075	5826150	40241600W075	5826078	40241600W075	16,0	16	75,00	150	0,30
6085543	40041800T038S	6085604	40041800T038S	6086533	40041800W038S	6085428	40041800W038S	18,0	18	38,00	100	—
5826125	40041800T038	5826064	40041800T038	5826151	40041800W038	5826079	40041800W038	18,0	18	38,00	100	0,30
6085544	40141800T060S	6085605	40141800T060S	6086534	40141800W060S	6085429	40141800W060S	18,0	18	60,00	125	—
5826126	40141800T060	5826065	40141800T060	5826152	40141800W060	5826080	40141800W060	18,0	18	60,00	125	0,30
6085545	40241800T075S	6085606	40241800T075S	6086535	40241800W075S	6085430	40241800W075S	18,0	18	75,00	150	—
5826127	40241800T075	5826066	40241800T075	5826153	40241800W075	5826081	40241800W075	18,0	18	75,00	150	0,30
5826128	40042000T038	5826067	40042000T038	5826154	40042000W038	5826082	40042000W038	20,0	20	38,00	104	0,30
6085546	40042000T038S	6085607	40042000T038S	6086536	40042000W038S	6085511	40042000W038S	20,0	20	38,00	104	—
6085547	40142000T056S	6085608	40142000T056S	6086537	40142000W056S	6085512	40142000W056S	20,0	20	56,00	125	—
5826129	40142000T056	5826068	40142000T056	5826155	40142000W056	5826083	40142000W056	20,0	20	56,00	125	0,30
6085548	40242000T075S	6085609	40242000T075S	6086538	40242000W075S	6085513	40242000W075S	20,0	20	75,00	150	—
5826130	40242000T075	5826069	40242000T075	5826156	40242000W075	5826084	40242000W075	20,0	20	75,00	150	0,30

NOTE: For application data, please see pages M40–M41.

- Centre cutting.
- Standard items listed. Additional styles and coatings made-to-order.

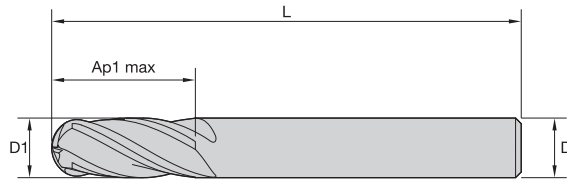

End Mill Tolerances

D1	tolerance e8	D	tolerance h6 + / -
≤ 3	-0,014/-0,028	≤ 3	0/0,006
> 3-6	-0,020/-0,038	> 3-6	0/0,008
> 6-10	-0,025/-0,047	> 6-10	0/0,009
> 10-18	-0,032/-0,059	> 10-18	0/0,011
> 18-30	-0,040/-0,073	> 18-30	0/0,013

■ Series D010 • VariMill GP

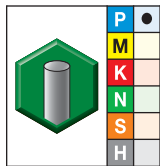

grade UNCOATED

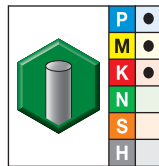

grade TiAlN
TiAlN

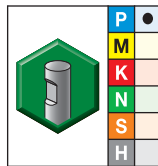

grade UNCOATED

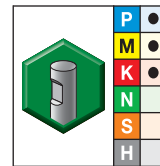

grade TiAlN
TiAlN

- first choice
- alternate choice

order #	catalogue #	order #	catalogue #	order #	catalogue #	order #	catalogue #	D1	D	length of cut Ap1 max	length L
5825604	D0100300T008	5825527	D0100300T008	—	—	—	—	3,0	6	8,00	57
5825605	D0100400T011	5825528	D0100400T011	—	—	—	—	4,0	6	11,00	57
5825606	D0100500T013	5825529	D0100500T013	—	—	—	—	5,0	6	13,00	57
5825607	D0100600T013	5825530	D0100600T013	—	—	—	—	6,0	6	13,00	57
5825608	D0100800T019	5825531	D0100800T019	—	—	—	—	8,0	8	19,00	63
5825609	D0101000T022	5825532	D0101000T022	—	—	—	—	10,0	10	22,00	72
5825610	D0101200T026	5825533	D0101200T026	5825589	D0101200W026	5825540	D0101200W026	12,0	12	26,00	83
5825611	D0101400T026	5825534	D0101400T026	5825590	D0101400W026	5825541	D0101400W026	14,0	14	26,00	83
5825612	D0101600T032	5825536	D0101600T032	5825591	D0101600W032	5825542	D0101600W032	16,0	16	32,00	92
5825613	D0101800T032	5825538	D0101800T032	5825592	D0101800W032	5825543	D0101800W032	18,0	18	32,00	92
5825614	D0102000T038	5825539	D0102000T038	5825593	D0102000W038	5825544	D0102000W038	20,0	20	38,00	104

NOTE: For application data, please see page M42.

- Centre cutting.
- Standard items listed. Additional styles and coatings made-to-order.

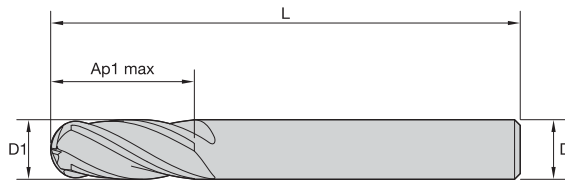

End Mill Tolerances

D1	tolerance e8	D	tolerance h6 + / -
≤ 3	-0,014/-0,028	≤ 3	0/0,006
> 3-6	-0,020/-0,038	> 3-6	0/0,008
> 6-10	-0,025/-0,047	> 6-10	0/0,009
> 10-18	-0,032/-0,059	> 10-18	0/0,011
> 18-30	-0,040/-0,073	> 18-30	0/0,013

Series 2848 • VariMill GP

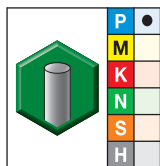

grade UNCOATED

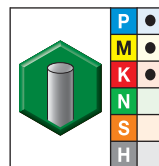

grade TiAlN
TiAlN

- first choice
- alternate choice

order #	catalogue #	order #	catalogue #	D1	D	length of cut Ap1 max	length L
5825594	28480400T011	5825545	28480400T011	4,0	4	11,00	50
5825595	28480500T013	5825546	28480500T013	5,0	5	13,00	50
5825596	28480600T013	5825547	28480600T013	6,0	6	13,00	57
5825597	28480800T019	5825548	28480800T019	8,0	8	19,00	63
5825598	28481000T022	5825549	28481000T022	10,0	10	22,00	72
5825599	28481200T026	5825550	28481200T026	12,0	12	26,00	83
5825600	28481400T026	5825551	28481400T026	14,0	14	26,00	83
5825601	28481600T032	5825552	28481600T032	16,0	16	32,00	92
5825602	28481800T032	5825553	28481800T032	18,0	18	32,00	92
5825603	28482000T038	5825554	28482000T038	20,0	20	38,00	104

NOTE: For application data, please see page M42.

- Centre cutting.
- Standard items listed. Additional styles and coatings made-to-order.

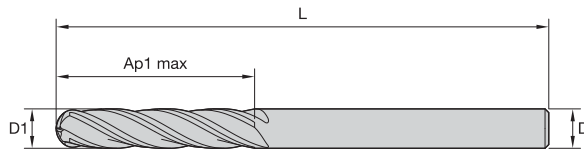
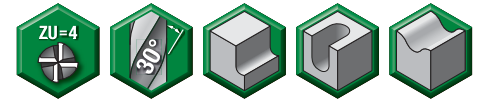

End Mill Tolerances

D1	tolerance e8	D	tolerance h6 + / -
≤ 3	-0,014/-0,028	≤ 3	0/0,006
> 3-6	-0,020/-0,038	> 3-6	0/0,008
> 6-10	-0,025/-0,047	> 6-10	0/0,009
> 10-18	-0,032/-0,059	> 10-18	0/0,011
> 18-30	-0,040/-0,073	> 18-30	0/0,013

■ Series 4000 4010 • VariMill GP

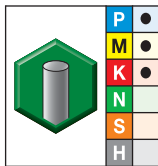

- first choice
- alternate choice

order #	catalogue #	D1	D	length of cut Ap1 max	length L
5825555	40000200T006	2,0	3	6,30	38
5825556	40000300T020	3,0	3	20,00	75
5825557	40000400T014	4,0	4	14,00	50
5825558	40100400T025	4,0	4	25,00	75
5825559	40000500T016	5,0	5	16,00	50
5825560	40100500T030	5,0	5	30,00	75
5825573	40000600T016	6,0	6	16,00	50
5825574	40100600T019	6,0	6	19,00	63
5825575	40100600T030	6,0	6	30,00	75
5825576	40000800T019	8,0	8	19,00	63
5825577	40100800T040	8,0	8	40,00	100
5825578	40001000T022	10,0	10	22,00	72
5825579	40101000T040	10,0	10	40,00	100
5825580	40001200T025	12,0	12	25,00	75
5825581	40101200T045	12,0	12	45,00	150
5825583	40001400T032	14,0	14	32,00	83
5825584	40101400T050	14,0	14	50,00	100
5825585	40001600T032	16,0	16	32,00	89
5825586	40101600T065	16,0	16	65,00	150
5825587	40001800T038	18,0	18	38,00	100
5825588	40102000T056	20,0	20	56,00	125

NOTE: For application data, please see pages M42-M43.

■ Series D004 4004 • TiAlN • VariMill GP

Material Group																								
	Side Milling (A) and Slotting (B)			TiAlN		Recommended feed per tooth (fz = mm/th) for side milling (A). For slotting (B), reduce fz by 20%.																		
	A		B	Cutting Speed – vc m/min		mm	D1 – Diameter																	
	ap	ae	ap	min	max		1,0	2,0	3,0	4,0	5,0	6,0	8,0	10,0	12,0	14,0	16,0	18,0	20,0					
P	0	Ap1 max	0,1 x D	0,5 x D	150	–	200	fz	0,007	0,014	0,021	0,028	0,036	0,044	0,060	0,072	0,083	0,092	0,101	0,108	0,114			
	1	Ap1 max	0,1 x D	0,5 x D	150	–	200	fz	0,007	0,014	0,021	0,028	0,036	0,044	0,060	0,072	0,083	0,092	0,101	0,108	0,114			
	2	Ap1 max	0,1 x D	0,5 x D	140	–	190	fz	0,007	0,014	0,021	0,028	0,036	0,044	0,060	0,072	0,083	0,092	0,101	0,108	0,114			
	3	Ap1 max	0,1 x D	0,5 x D	120	–	160	fz	0,006	0,011	0,017	0,023	0,030	0,036	0,050	0,061	0,070	0,079	0,087	0,095	0,101			
M	1	Ap1 max	0,1 x D	0,5 x D	90	–	115	fz	0,006	0,011	0,017	0,023	0,030	0,036	0,050	0,061	0,070	0,079	0,087	0,095	0,101			
	2	Ap1 max	0,1 x D	0,5 x D	60	–	80	fz	0,005	0,009	0,014	0,019	0,024	0,029	0,040	0,048	0,056	0,063	0,070	0,076	0,081			
K	1	Ap1 max	0,1 x D	0,5 x D	120	–	150	fz	0,007	0,014	0,021	0,028	0,036	0,044	0,060	0,072	0,083	0,092	0,101	0,108	0,114			
	2	Ap1 max	0,1 x D	0,5 x D	110	–	140	fz	0,006	0,011	0,017	0,023	0,030	0,036	0,050	0,061	0,070	0,079	0,087	0,095	0,101			

NOTE: Lower value of cutting speed is used for high stock removal applications or for higher hardness (machinability) within group.
Higher value of cutting speed is used for finishing applications or for lower hardness (machinability) within group.
Above parameters are based on ideal conditions. For smaller taper machining centres, please adjust parameters accordingly on >12mm diameters.



■ Series D004 4004 • Uncoated • VariMill GP

Material Group																								
	Side Milling (A) and Slotting (B)			uncoated		Recommended feed per tooth (fz = mm/th) for side milling (A). For slotting (B), reduce fz by 20%.																		
	A		B	Cutting Speed – vc m/min		mm	D1 – Diameter																	
	ap	ae	ap	min	max		1,0	2,0	3,0	4,0	6,0	8,0	10,0	12,0	16,0	20,0								
P	0	Ap1 max	0,1 x D	0,5 x D	120	–	160	fz	0,007	0,014	0,021	0,028	0,044	0,060	0,072	0,083	0,101	0,114						
	1	Ap1 max	0,1 x D	0,5 x D	120	–	160	fz	0,007	0,014	0,021	0,028	0,044	0,060	0,072	0,083	0,101	0,114						
	2	Ap1 max	0,1 x D	0,5 x D	112	–	152	fz	0,007	0,014	0,021	0,028	0,044	0,060	0,072	0,083	0,101	0,114						

NOTE: Lower value of cutting speed is used for high stock removal applications or for higher hardness (machinability) within group.
Higher value of cutting speed is used for finishing applications or for lower hardness (machinability) within group.
Above parameters are based on ideal conditions. For smaller taper machining centres, please adjust parameters accordingly on >12mm diameters.



General Purpose Solid Carbide End Mills

■ Series D014 2528 4014 4024 • TiAlN • VariMill GP

Material Group																			
	Side Milling (A)		TiAlN			Recommended feed per tooth (fz = mm/th) for side milling (A).													
	A		Cutting Speed – vc m/min			D1 – Diameter													
	ap	ae	min		max	mm	2,0	3,0	4,0	5,0	6,0	8,0	10,0	12,0	14,0	16,0	18,0	20,0	
P	0	Ap1 max	0,1 x D	150	–	200	fz	0,014	0,021	0,028	0,036	0,044	0,060	0,072	0,083	0,092	0,101	0,108	0,114
	1	Ap1 max	0,1 x D	150	–	200	fz	0,014	0,021	0,028	0,036	0,044	0,060	0,072	0,083	0,092	0,101	0,108	0,114
	2	Ap1 max	0,1 x D	140	–	190	fz	0,014	0,021	0,028	0,036	0,044	0,060	0,072	0,083	0,092	0,101	0,108	0,114
	3	Ap1 max	0,1 x D	120	–	160	fz	0,011	0,017	0,023	0,030	0,036	0,050	0,061	0,070	0,079	0,087	0,095	0,101
	4	Ap1 max	0,1 x D	90	–	150	fz	0,010	0,016	0,021	0,027	0,033	0,045	0,054	0,062	0,070	0,077	0,083	0,088
M	1	Ap1 max	0,1 x D	90	–	115	fz	0,011	0,017	0,023	0,030	0,036	0,050	0,061	0,070	0,079	0,087	0,095	0,101
	2	Ap1 max	0,1 x D	60	–	80	fz	0,009	0,014	0,019	0,024	0,029	0,040	0,048	0,056	0,063	0,070	0,076	0,081
K	1	Ap1 max	0,1 x D	120	–	150	fz	0,014	0,021	0,028	0,036	0,044	0,060	0,072	0,083	0,092	0,101	0,108	0,114
	2	Ap1 max	0,1 x D	110	–	140	fz	0,011	0,017	0,023	0,030	0,036	0,050	0,061	0,070	0,079	0,087	0,095	0,101

NOTE: Lower value of cutting speed is used for high stock removal applications or for higher hardness (machinability) within group.
Higher value of cutting speed is used for finishing applications or for lower hardness (machinability) within group.
Above parameters are based on ideal conditions. For smaller taper machining centres, please adjust parameters accordingly on >12mm diameters.

■ Series D014 2528 4014 4024 • Uncoated • VariMill GP

Material Group																
	Side Milling (A)		uncoated			Recommended feed per tooth (fz = mm/th) for side milling (A).										
	A		Cutting Speed – vc m/min			D1 – Diameter										
	ap	ae	min		max	mm	3,0	4,0	6,0	8,0	10,0	12,0	16,0	20,0		
P	0	Ap1 max	0,1 x D	120	–	160	fz	0,021	0,028	0,044	0,060	0,072	0,083	0,101	0,114	
	1	Ap1 max	0,1 x D	120	–	160	fz	0,021	0,028	0,044	0,060	0,072	0,083	0,101	0,114	
	2	Ap1 max	0,1 x D	112	–	152	fz	0,021	0,028	0,044	0,060	0,072	0,083	0,101	0,114	

NOTE: Lower value of cutting speed is used for high stock removal applications or for higher hardness (machinability) within group.
Higher value of cutting speed is used for finishing applications or for lower hardness (machinability) within group.
Above parameters are based on ideal conditions. For smaller taper machining centres, please adjust parameters accordingly on >12mm diameters.

■ Series D010 2848 4000 • TiAlN • VariMill GP

Material Group	Side Milling (A) and Slotting (B)		TiAlN			Recommended feed per tooth (fz = mm/th) for side milling (A). For slotting (B), reduce fz by 20%.														
	A		B		Cutting Speed – vc m/min	mm	D1 – Diameter													
	ap	ae	ap	min			max	3,0	4,0	5,0	6,0	8,0	10,0	12,0	14,0	16,0	18,0	20,0		
	ap1 max	0,1 x D	0,5 x D	150	–	200	fz	0,021	0,028	0,036	0,044	0,060	0,072	0,083	0,092	0,101	0,108	0,114		
P	0	Ap1 max	0,1 x D	0,5 x D	150	–	200	fz	0,021	0,028	0,036	0,044	0,060	0,072	0,083	0,092	0,101	0,108	0,114	
	1	Ap1 max	0,1 x D	0,5 x D	150	–	200	fz	0,021	0,028	0,036	0,044	0,060	0,072	0,083	0,092	0,101	0,108	0,114	
	2	Ap1 max	0,1 x D	0,5 x D	140	–	190	fz	0,021	0,028	0,036	0,044	0,060	0,072	0,083	0,092	0,101	0,108	0,114	
	3	Ap1 max	0,1 x D	0,5 x D	120	–	160	fz	0,017	0,023	0,030	0,036	0,050	0,061	0,070	0,079	0,087	0,095	0,101	
	4	Ap1 max	0,1 x D	0,5 x D	90	–	150	fz	0,016	0,021	0,027	0,033	0,045	0,054	0,062	0,070	0,077	0,083	0,088	
M	1	Ap1 max	0,1 x D	0,5 x D	90	–	115	fz	0,017	0,023	0,030	0,036	0,050	0,061	0,070	0,079	0,087	0,095	0,101	
	2	Ap1 max	0,1 x D	0,5 x D	60	–	80	fz	0,014	0,019	0,024	0,029	0,040	0,048	0,056	0,063	0,070	0,076	0,081	
K	1	Ap1 max	0,1 x D	0,5 x D	120	–	150	fz	0,021	0,028	0,036	0,044	0,060	0,072	0,083	0,092	0,101	0,108	0,114	
	2	Ap1 max	0,1 x D	0,5 x D	110	–	140	fz	0,017	0,023	0,030	0,036	0,050	0,061	0,070	0,079	0,087	0,095	0,101	

NOTE: Lower value of cutting speed is used for high stock removal applications or for higher hardness (machinability) within group.
Higher value of cutting speed is used for finishing applications or for lower hardness (machinability) within group.
Above parameters are based on ideal conditions. For smaller taper machining centres, please adjust parameters accordingly on >12mm diameters.



Application Data • Series 4010 • VariMill™ GP

■ Series 4010 • TiAlN • VariMill GP

Material Group	Side Milling (A)		TiAlN			Recommended feed per tooth (fz = mm/th) for side milling (A).													
	A		Cutting Speed – vc m/min		mm	D1 – Diameter													
	ap	ae	min	max		3,0	4,0	5,0	6,0	8,0	10,0	12,0	14,0	16,0	18,0	20,0			
	ap1 max	0,1 x D	150	–	200	fz	0,021	0,028	0,036	0,044	0,060	0,072	0,083	0,092	0,101	0,108	0,114		
P	0	Ap1 max	0,1 x D	150	–	200	fz	0,021	0,028	0,036	0,044	0,060	0,072	0,083	0,092	0,101	0,108	0,114	
	1	Ap1 max	0,1 x D	150	–	200	fz	0,021	0,028	0,036	0,044	0,060	0,072	0,083	0,092	0,101	0,108	0,114	
	2	Ap1 max	0,1 x D	140	–	190	fz	0,021	0,028	0,036	0,044	0,060	0,072	0,083	0,092	0,101	0,108	0,114	
	3	Ap1 max	0,1 x D	120	–	160	fz	0,017	0,023	0,030	0,036	0,050	0,061	0,070	0,079	0,087	0,095	0,101	
	4	Ap1 max	0,1 x D	90	–	150	fz	0,016	0,021	0,027	0,033	0,045	0,054	0,062	0,070	0,077	0,083	0,088	
M	1	Ap1 max	0,1 x D	90	–	115	fz	0,017	0,023	0,030	0,036	0,050	0,061	0,070	0,079	0,087	0,095	0,101	
	2	Ap1 max	0,1 x D	60	–	80	fz	0,014	0,019	0,024	0,029	0,040	0,048	0,056	0,063	0,070	0,076	0,081	
K	1	Ap1 max	0,1 x D	120	–	150	fz	0,021	0,028	0,036	0,044	0,060	0,072	0,083	0,092	0,101	0,108	0,114	
	2	Ap1 max	0,1 x D	110	–	140	fz	0,017	0,023	0,030	0,036	0,050	0,061	0,070	0,079	0,087	0,095	0,101	

NOTE: Lower value of cutting speed is used for high stock removal applications or for higher hardness (machinability) within group.
Higher value of cutting speed is used for finishing applications or for lower hardness (machinability) within group.
Above parameters are based on ideal conditions. For smaller taper machining centres, please adjust parameters accordingly on >12mm diameters.

■ Series 4010 • Uncoated • VariMill GP

															
	Side Milling (A)		uncoated			Recommended feed per tooth (fz = mm/th) for side milling (A).									
Material Group	A		Cutting Speed – vc m/min				D1 – Diameter								
	ap	ae	min		max	mm	3,0	4,0	6,0	8,0	10,0	12,0	16,0	20,0	
P	0	Ap1 max	0,1 x D	120	–	160	fz	0,021	0,028	0,044	0,060	0,072	0,083	0,101	0,114
	1	Ap1 max	0,1 x D	120	–	160	fz	0,021	0,028	0,044	0,060	0,072	0,083	0,101	0,114
	2	Ap1 max	0,1 x D	112	–	152	fz	0,021	0,028	0,044	0,060	0,072	0,083	0,101	0,114

NOTE: Lower value of cutting speed is used for high stock removal applications or for higher hardness (machinability) within group.
Higher value of cutting speed is used for finishing applications or for lower hardness (machinability) within group.
Above parameters are based on ideal conditions. For smaller taper machining centres, please adjust parameters accordingly on >12mm diameters.